

NAVAL AIR TRAINING COMMAND



NAS CORPUS CHRISTI, TEXAS

CNATRA P-401 (Rev. 02-13)

WORKBOOK



INTRODUCTION TO HELICOPTER AERODYNAMICS TH-57

2013



DEPARTMENT OF THE NAVY
CHIEF OF NAVAL AIR TRAINING
250 LEXINGTON BLVD SUITE 102
CORPUS CHRISTI TX 78419-5041

CNATRA P-401
N714
18 Apr 13

CNATRA P-401 (REV. 02-13)

Subj: WORKBOOK, INTRODUCTION TO HELICOPTER AERODYNAMICS,
TH-57

1. CNATRA P-401 (Rev. 04-11) PAT, "Workbook, Introduction to Helicopter Aerodynamics, TH-57" is issued for information, standardization of instruction, and guidance to all flight instructors and student military aviators in the Naval Air Training Command.
2. This publication is an explanatory aid to the Helicopter and Tiltrotor curriculums and shall be the authority for the execution of all flight procedures and maneuvers herein contained.
3. Recommendations for changes shall be submitted via CNATRA TCR form 1550/19 in accordance with CNATRAINST 1550.6 series.
4. CNATRA P-401 (Rev. 10-09) PAT is hereby cancelled and superseded.

C. HOLLINGSWORTH
Chief of Staff

Distribution:
CNATRA Website

INTRODUCTION TO HELICOPTER AERODYNAMICS WORKBOOK TH-57

Q-2A-0015

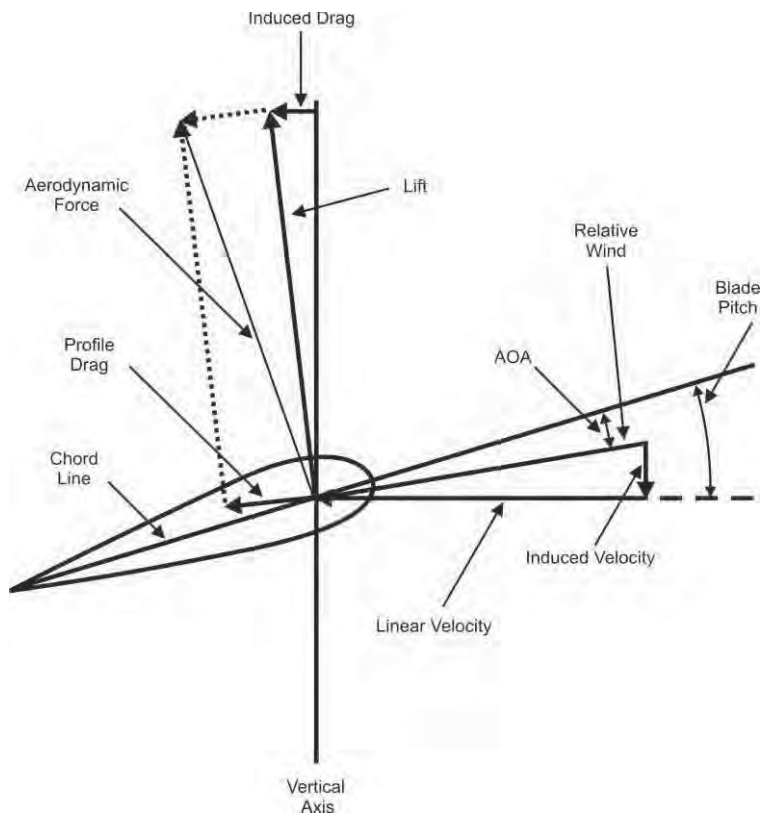

LIST OF EFFECTIVE PAGES

Dates of issue for original and changed pages are:

Original...0...15 Sep 99

Revision1...0...15 Sept 00

Revision2...0...07 Oct 09

Revision3...0...18 Apr 13

TOTAL NUMBER OF PAGES IN THIS PUBLICATION IS 390 CONSISTING OF THE FOLLOWING:

Page No.	Change No.	Page No.	Change No.
COVER	0	8-1 – 8-18	0
LETTER	0	8-19 (blank)	0
iii – xxi	0	8-20 – 8-21	0
xxii (blank)	0	8-22 (blank)	0
1-1 – 1-19	0	9-1 – 9-23	0
1-20 (blank)	0	9-24 (blank)	0
1-21 – 1-24	0	9-25 – 9-26	0
1-25 (blank)	0	9-27 (blank)	0
1-26 – 1-28	0	9-28	0
2-1 – 2-41	0	10-1 – 10-42	0
2-42 (blank)	0	10-43 (blank)	0
2-43 – 2-44	0	10-44	0
2-45 (blank)	0	11-1 – 11-35	0
2-46	0	11-36 (blank)	0
3-1 – 3-8	0	11-37 – 11-40	0
4-1 – 4-16	0	12-1 – 12-41	0
5-1 – 5-9	0	12-42 (blank)	0
5-10 (blank)	0	12-43 – 12-44	0
5-11 – 5-12	0	12-45 (blank)	0
6-1 – 6-15	0	12-46	0
6-16 (blank)	0	13-1 – 13-5	0
6-17 – 6-18	0	13-6 (blank)	0
6-19 (blank)	0	A-1 – A-17	0
6-20	0	B-1 – B-2	0
7-1 – 7-23	0	C-1 – C-3	0
7-24 (blank)	0	C-4 (blank)	0
7-25 – 7-26	0		
7-27 (blank)	0		
7-28	0		

INTERIM CHANGE SUMMARY

The following Changes have been previously incorporated in this manual:

CHANGE NUMBER	REMARKS/PURPOSE

The following Interim Changes have been incorporated in this Change/Revision:

INTERIM CHANGE NUMBER	REMARKS/PURPOSE	ENTERED BY	DATE

ACKNOWLEDGEMENTS

The genesis for this text was direction from CNATRA to develop a more comprehensive helicopter aerodynamics text and course with the ultimate goal of making smarter and therefore safer pilots. This text was produced through the collective effort of Training Air Wing FIVE academic instructors and helicopter pilots, and the Rotary Wing Aerodynamics Instructor from the U.S. Navy & Marine Corps School of Aviation Safety. A number of additional Wing personnel, mostly flight students awaiting training, provided research and clerical support. LCDR Clay Wilkins was the team leader and responsible for the overall course development. The text was designed to be a reference that the fleet pilot can use as a single source document, not just as a flight school workbook. It includes a great deal of information and pictorial items from open internet sources as well as the books in the reference list. The most notable sources are works from Ray Prouty, as quoted in the School of Aviation Safety's (SAS) Rotary Wing Aerodynamics for Naval Aviators, and the SAS book itself. If there are any errors in the interpretation of these authors' materials or the sources in the reference list (Appendix A), or the information as presented, the reader should report them to Training Air Wing FIVE Academic Training Department. This book is a work in progress and will be updated periodically.

The following personnel have all made considerable contributions to the content of this text.

LCDR Clay Wilkins, USN (UH-60A, AH-1S, CH-54A, OH-6A, OH-58A/C, UH-1H) Course Manager

Maj. James Pritchard, USMC (CH-53E) Rotary Wing Aerodynamics Instructor, U.S. Navy & Marine Corps School of Aviation Safety

LT Mark Heupel, USCG (HH-65) TW-5 Academic Instructor

LtCol Craig D'Ambra, USMC (Ret) (CH-46E) TW-5 Academic Instructor

LCDR Sammy Samoluk, USN (Ret) (HH-46) Lockheed Martin Contract Simulator Instructor

LCDR Bert Outlaw, USN (Ret) (H-3) Lockheed Martin Contract Simulator Instructor

INSTRUCTIONS FOR STUDENT NAVAL AVIATORS

I. Objective

Upon completion of this course, the student will possess an understanding of basic helicopter aerodynamics as stated in the terminal objective. While the student will be required to demonstrate a functional knowledge of the material presented through successful completion of an end-of-course examination with a minimum score of 80%, this course is primarily focused on preparing the student for practical application of that knowledge in future helicopter flight and flight planning.

II. Assumptions

1. The scope of this course is somewhat limited by its terminal objective; therefore, an engineering background is not required for mastery of the basic concepts of this course.
2. Recent completion of the Fundamentals of Aerodynamics course offered in Aviation Preflight Indoctrination (or an equivalent course) is assumed. Review of the material may be required if an extended period of time has passed or the material was not previously mastered.
3. Concurrent completion of interactive courseware (ICWs) in the form of computer-based training (CBTs) is augmented by the availability of knowledgeable instructors and a formal review session prior to testing.
4. Every effort has been made to produce an introductory text that will also serve as an adequate, stand-alone, ready reference for the military helicopter pilot. Since a comprehensive helicopter engineering text is neither intended nor deemed necessary, a recommended reading list is provided for those with greater curiosity.

III. Instructional Approach of this edition

1. This edition has been organized to be more user friendly. The concepts to be mastered for the end-of-course exam are described in the corresponding enabling objectives in the basic text.
2. This edition includes the Table of Contents and appendices with a reference/recommended reading list, Glossary and an Index.

IV. Recommendations for Students

1. It is to your advantage to review the enabling objectives before completing computer-based training, study of the text, and the class presentation.
2. The utility of this course depends primarily upon the conscientious accomplishment of your reading and study assignments.

3. Participation in a study group is highly recommended. A study group of four members has been shown to be optimum.
4. Equations have been used throughout the book to provide a more in-depth understanding for those who want more detail. The equations are NOT testable.

AVIATOR AND INSTRUCTOR GUIDANCE

Every aviator has a “toolbox” with tools he or she has collected and mastered over the years. Among other things, that toolbox probably contains emergency procedures, operating limitations, regulations or instructions, and an assortment of lessons learned.

A mastery of basic aerodynamic principles is an important tool for the professional aviator, especially when it comes to the challenging rigors of rotary wing flight in military aviation. Aerodynamics can save your life. Time after time, mishap reports attribute either a lack of understanding or the inappropriate misapplication of aerodynamic principles as a causal factor of the mishap.

The exposure in flight training to these principles and their application is only the first step in the mastery of the essential concepts. Every profession requires continuing education. As iron sharpens iron, we learn from one another. It is the responsibility of every naval aviator to continually sharpen the skills necessary to maintain the “edge” that may one day make the difference in the accomplishment of the mission and/or your crew’s survival.

Periodic review of both systems and aerodynamic course material will provide for the greatest retention and immediate recall. Each time the aviator re-reads the text, he will glean some new fact or relationship to improve his overall understanding, even those who have yet to set foot in a new aircraft.

A survey of pilots of the Aviation Safety Officer Course reveals that few of the aerodynamic principles necessary to investigate a mishap have been retained from flight training. Each ASO is exposed to twenty lecture hours of rotary wing aerodynamics in the course. It is clear from this course that every individual is not only capable of, but also highly motivated toward, making basic aerodynamic principles an integral part of their toolbox. Their goal is not to develop mishap investigation skills, but rather to develop mishap avoidance skills they can share.

Therefore, the goal of this text is to present the principles of helicopter aerodynamics in a straightforward, comprehensible manner, such that both the newest student naval aviator and the crustiest old instructor pilot may have at their disposal a concise, accurate reference. The best available tool, however, is only of use to the craftsman who develops and maintains a level of expertise to make its use second nature.

TABLE OF CONTENTS

LIST OF EFFECTIVE PAGES.....	iv
INTERIM CHANGE SUMMARY.....	v
ACKNOWLEDGEMENTS.....	vi
INSTRUCTIONS FOR STUDENT NAVAL AVIATORS.....	vii
AVIATOR AND INSTRUCTOR GUIDANCE.....	ix
TABLE OF CONTENTS.....	x
TABLE OF FIGURES.....	xvi
CHAPTER ONE - INTRODUCTION AND BASIC PHYSICS REVIEW.....	1-1
100. INTRODUCTION.....	1-1
101. LESSON TOPIC LEARNING OBJECTIVES.....	1-1
102. REFERENCES.....	1-2
103. STUDY ASSIGNMENT.....	1-2
104. REVIEW OF BASIC PHYSICS AND AERODYNAMICS.....	1-2
105. VECTOR ANALYSIS.....	1-3
106. ESSENTIAL TERMS AND DEFINITIONS.....	1-5
107. NEWTON'S LAWS OF MOTION.....	1-6
108. PROPERTIES OF THE ATMOSPHERE.....	1-9
109. THE GENERAL GAS LAW.....	1-10
110. THE STANDARD ATMOSPHERE.....	1-11
111. ALTITUDE COMPUTATIONS.....	1-12
112. ALTITUDE COMPUTATIONS – DENSITY ALTITUDE.....	1-14
CHAPTER ONE REVIEW QUESTIONS.....	1-21
CHAPTER ONE REVIEW ANSWERS.....	1-26
CHAPTER TWO - HELICOPTER AERODYNAMICS BASICS.....	2-1
200. INTRODUCTION.....	2-1
201. LESSON TOPIC LEARNING OBJECTIVES.....	2-1
202. REFERENCES.....	2-2
203. STUDY ASSIGNMENT.....	2-2
204. AIRCRAFT REFERENCE SYSTEM.....	2-2
205. INTRODUCTION TO THE STANDARD HELICOPTER.....	2-3
206. GENERAL PROPERTIES OF AIRFLOW.....	2-3
207. THE CONTINUITY EQUATION.....	2-4
208. BERNOULLI'S EQUATION.....	2-5
209. A STREAMTUBE AS A MODEL FOR AN AIRFOIL.....	2-6
210. THE BOUNDARY LAYER.....	2-7
211. AN INTRODUCTION TO LIFT THEORIES.....	2-8
212. PRESSURE DISTRIBUTION THEORY.....	2-9
213. CIRCULATION THEORY.....	2-9
214. MOMENTUM THEORY.....	2-11
215. BLADE ELEMENT THEORY.....	2-13
216. AIRFOIL CHARACTERISTICS AND NOMENCLATURE.....	2-16
217. AIRFOIL TYPES.....	2-18

218.	AIRFLOW TERMS	2-19
219.	BLADE ANGLES	2-25
220.	AERODYNAMIC FORCES	2-27
221.	TOTAL AERODYNAMIC FORCE.....	2-29
222.	LIFT AND THE LIFT EQUATION.....	2-31
223.	DRAG AND THE DRAG EQUATION.....	2-32
224.	PITCHING MOMENT	2-36
225.	AERODYNAMIC FORCES ON THE AIRCRAFT/TOTAL ROTOR THRUST	2-39
226.	MAIN ROTOR DRAG (IN-PLANE AND H-FORCE)	2-41
227.	TAIL ROTOR THRUST	2-41
CHAPTER TWO REVIEW QUESTIONS		2-43
CHAPTER TWO REVIEW ANSWERS.....		2-46
CHAPTER THREE - AIRFOIL DESIGN		3-1
300.	INTRODUCTION	3-1
301.	LESSON TOPIC LEARNING OBJECTIVES.....	3-1
302.	REFERENCES	3-1
303.	STUDY ASSIGNMENT	3-1
304.	GENERAL.....	3-2
305.	LEADING EDGE SUCTION.....	3-2
306.	TWIST AND TAPER	3-3
307.	INERTIA.....	3-5
308.	SOLIDITY	3-5
309.	AIRFOIL DESIGN FOR COMPRESSIBILITY.....	3-6
CHAPTER THREE REVIEW QUESTIONS.....		3-7
CHAPTER THREE REVIEW ANSWERS.....		3-8
CHAPTER FOUR - ROTOR SYSTEM DYNAMICS		4-1
400.	INTRODUCTION	4-1
401.	LESSON TOPIC LEARNING OBJECTIVES.....	4-1
402.	REFERENCES	4-1
403.	STUDY ASSIGNMENT	4-2
404.	BLADE ACTIONS.....	4-2
405.	PHASE LAG.....	4-3
406.	PHASE LAG VERSUS GYROSCOPIC PRECESSION	4-5
407.	CONTROL INPUTS.....	4-6
408.	CONING.....	4-10
409.	GEOMETRIC IMBALANCE	4-11
CHAPTER FOUR REVIEW QUESTIONS.....		4-15
CHAPTER FOUR REVIEW ANSWERS		4-16
CHAPTER FIVE - AIRCRAFT AND ROTOR SYSTEM DESIGN.....		5-1
500.	INTRODUCTION	5-1
501.	LESSON TOPIC LEARNING OBJECTIVES.....	5-1
502.	REFERENCES	5-1

503.	STUDY ASSIGNMENT	5-1
504.	ROTOR SYSTEMS DESIGN CHARACTERISTICS	5-2
505.	ROTOR AXIS.....	5-3
506.	MAIN ROTOR TYPES	5-3
507.	SINGLE MAIN ROTOR	5-5
508.	TIP BOOST	5-5
509.	MULTIPLE MAIN ROTORS	5-6
510.	TANDEM ROTOR DESIGN	5-7
511.	COAXIAL ROTOR DESIGN	5-7
512.	SYNCHROPTER DESIGN	5-8
513.	TILTROTOR / TILTWING.....	5-8
514.	DESIGN MODIFICATIONS	5-9
515.	PROPULSION DEVICES	5-9
CHAPTER FIVE REVIEW QUESTIONS		5-11
CHAPTER FIVE REVIEW ANSWERS.....		5-12
 CHAPTER SIX - TAIL ROTOR DESIGN		6-1
600.	INTRODUCTION	6-1
601.	LESSON TOPIC LEARNING OBJECTIVES	6-1
602.	REFERENCES	6-1
603.	STUDY ASSIGNMENT	6-1
604.	TORQUE EFFECT.....	6-2
605.	TAIL ROTOR DESIGN	6-3
606.	NOTAR (NO TAIL ROTOR).....	6-6
607.	VERTICAL STABILIZER.....	6-8
608.	TRANSLATING TENDENCY AND HOVER ATTITUDE.....	6-9
609.	WEATHER VANING	6-9
610.	TAIL ROTOR FAILURES AND ISSUES.....	6-10
CHAPTER SIX REVIEW QUESTIONS		6-17
CHAPTER SIX REVIEW ANSWERS.....		6-20
 CHAPTER SEVEN - STABILITY AND CONTROL.....		7-1
700.	INTRODUCTION	7-1
701.	LESSON TOPIC LEARNING OBJECTIVES.....	7-1
702.	REFERENCES	7-1
703.	STUDY ASSIGNMENT	7-2
704.	GENERAL.....	7-2
705.	STATIC STABILITY	7-2
706.	DYNAMIC STABILITY	7-5
707.	CENTER OF GRAVITY (CG).....	7-7
708.	HELICOPTER STATIC STABILITY AND MANEUVERABILITY	7-9
709.	LATERAL STATIC STABILITY	7-10
710.	DIHEDRAL EFFECT.....	7-10
711.	THE FLYING WING MODEL.....	7-11
712.	THE FUSELAGE AND LONGITUDINAL STABILITY	7-12
713.	HORIZONTAL STABILIZER / STABILATOR.....	7-12

714.	AIRSPED STABILITY	7-13
715.	ANGLE-OF-ATTACK INSTABILITY	7-14
716.	DIRECTIONAL STATIC STABILITY	7-14
717.	THE FUSELAGE AND DIRECTIONAL STABILITY	7-15
718.	THE VERTICAL STABILIZER	7-15
719.	CONTROL	7-15
720.	MECHANICAL VERSUS VIRTUAL AXIS	7-16
721.	PILOT / AIRCRAFT INTERACTION	7-17
722.	CONTROL MECHANISMS	7-20
723.	TRIMMED FLIGHT	7-20
CHAPTER SEVEN REVIEW QUESTIONS.....		7-25
CHAPTER SEVEN REVIEW ANSWERS		7-28
 CHAPTER EIGHT - ENGINE AND AIRCRAFT PERFORMANCE		8-1
800.	INTRODUCTION	8-1
801.	LESSON TOPIC LEARNING OBJECTIVES	8-1
802.	REFERENCES	8-2
803.	STUDY ASSIGNMENT	8-2
804.	GENERAL	8-2
805.	POWER REQUIRED	8-4
806.	POWER AVAILABLE	8-8
807.	EFFECT OF TAIL ROTOR ON POWER AVAILABLE	8-9
808.	POWER REQUIRED EXCEEDS POWER AVAILABLE	8-10
809.	CASE STUDY – POWER REQUIRED, EXTREME EXAMPLE	8-13
CHAPTER EIGHT REVIEW QUESTIONS.....		8-15
CHAPTER EIGHT REVIEW ANSWERS		8-16
NATOPS PART XI QUESTIONS.....		8-17
NATOPS PART XI ANSWERS		8-20
 CHAPTER NINE - HOVER PERFORMANCE		9-1
900.	INTRODUCTION	9-1
901.	LESSON TOPIC LEARNING OBJECTIVES	9-1
902.	REFERENCES	9-1
903.	STUDY ASSIGNMENT	9-2
904.	GENERAL	9-2
905.	INDUCED VELOCITY AND INDUCED POWER	9-4
906.	VORTICES	9-5
907.	WAKE VORTICES	9-7
908.	HOVER OUT-OF-GROUND-EFFECT (HOGE)	9-8
909.	HOVER IN-GROUND-EFFECT (HIGE)	9-9
910.	POWER REQUIREMENTS	9-15
911.	TRANSLATING TENDENCY	9-19
912.	HOVER ATTITUDE	9-20
913.	HOVERING FLIGHT	9-22
CHAPTER NINE REVIEW QUESTIONS.....		9-25
CHAPTER NINE REVIEW ANSWERS.....		9-28

CHAPTER TEN - FORWARD FLIGHT PERFORMANCE	10-1
1000. INTRODUCTION	10-1
1001. LESSON TOPIC LEARNING OBJECTIVES	10-1
1002. REFERENCES	10-2
1003. STUDY ASSIGNMENT	10-2
1004. GENERAL	10-2
1005. TRANSITION FROM HOVER TO LOW SPEED FLIGHT	10-5
1006. DOWNWIND TAKEOFF PROBLEM	10-10
1007. TRANSLATIONAL FLOW AND TRANSLATIONAL LIFT	10-12
1008. EFFECTIVE TRANSLATIONAL LIFT	10-14
1009. TRANSVERSE FLOW EFFECT	10-15
1010. DISSYMMETRY OF LIFT	10-17
1011. BLOWBACK	10-18
1012. PENDULUM EFFECT	10-20
1013. GROUND VORTEX	10-20
1014. RETREATING BLADE STALL	10-21
1015. COMPRESSIBILITY	10-26
1016. BLADE REGIONS	10-28
1017. REVIEW OF OPTIMUM AIRSPEEDS	10-30
CHAPTER TEN REVIEW QUESTIONS.....	10-41
CHAPTER TEN REVIEW ANSWERS	10-44
CHAPTER ELEVEN - DESCENDING FLIGHT	11-1
1100. INTRODUCTION	11-1
1101. LESSON TOPIC LEARNING OBJECTIVES	11-1
1102. REFERENCES	11-2
1103. STUDY ASSIGNMENT	11-2
1104. GENERAL	11-2
1105. AERODYNAMICS OF THE NORMAL APPROACH	11-3
1106. TRANSITION TO HOVER	11-3
1107. POWER REQUIRED EXCEEDS POWER AVAILABLE	11-4
1108. CASE STUDY – POWER REQUIRED EXCEEDS POWER AVAILABLE	11-5
1109. VORTEX RING STATE (VRS)	11-6
1110. CASE STUDY – VORTEX RING STATE	11-14
1111. AUTOROTATION	11-15
1112. AERODYNAMICS OF AUTOROTATION IN FORWARD FLIGHT	11-19
1113. AUTOROTATION DESCENT VARIABLES	11-21
1114. PHASES OF AUTOROTATION	11-22
1115. WINDMILL BRAKE STATE	11-31
1116. HEIGHT VELOCITY DIAGRAM	11-32
CHAPTER ELEVEN REVIEW QUESTIONS.....	11-37
CHAPTER ELEVEN REVIEW ANSWERS	11-40

CHAPTER TWELVE - FLIGHT PHENOMENA	12-1
1200. INTRODUCTION	12-1
1201. LESSON TOPIC LEARNING OBJECTIVES	12-1
1202. REFERENCES	12-2
1203. STUDY ASSIGNMENT	12-2
1204. GENERAL	12-2
1205. MANEUVERING FLIGHT / G-LOADING	12-2
1206. OVERBANK	12-10
1207. DIVE PULLOUT	12-13
1208. CASE STUDIES – MANEUVERING FLIGHT	12-14
1209. FLIGHT ENVELOPE / V-N DIAGRAM	12-14
1210. MAST BUMPING	12-18
1211. VIBRATION ANALYSIS	12-20
1212. HELICOPTER VIBRATIONS BY RAY PROUTY	12-22
1213. MAINTENANCE / FATIGUE / FAILURE	12-28
1214. GROUND RESONANCE	12-30
1215. DYNAMIC ROLLOVER	12-34
CHAPTER TWELVE REVIEW QUESTIONS	12-43
CHAPTER TWELVE REVIEW ANSWERS	12-46
CHAPTER THIRTEEN - REVIEW	13-1
1300. INTRODUCTION	13-1
1301. LESSON TOPIC LEARNING OBJECTIVES	13-1
1302. STUDY ASSIGNMENT	13-1
1303. REVIEW	13-1
APPENDIX A - GLOSSARY	A-1
A100. GLOSSARY	A-1
APPENDIX B - REFERENCES AND READING LIST	B-1
APPENDIX C - INDEX	C-1
C100. INDEX	C-1

TABLE OF FIGURES

Figure 1-1	Resultant by the Tip-to-Tail Method	1-3
Figure 1-2	Force Vectors on an Airfoil.....	1-4
Figure 1-3	Force Vectors on Aircraft in Flight.....	1-4
Figure 1-4	The Law of Equilibrium.....	1-7
Figure 1-5	Vertical Climb	1-7
Figure 1-6	Static Pressure.....	1-9
Figure 1-7	Molecular Energy and Air Temperature.....	1-10
Figure 1-8	Gas Under Variable Changes	1-11
Figure 1-9	Standard Atmosphere Table.....	1-12
Figure 1-10	Pressure Altitude vs. True Altitude with Varying Local Pressures	1-14
Figure 1-11	DA Chart.....	1-15
Figure 1-12	Dew Point Correction Chart.....	1-16
Figure 1-13	Thrust Variation with Humidity	1-18
Figure 1-14	Sample Effects of DA Calculations on CH-53D Performance	1-19
Figure 2-1	Aircraft Reference System	2-3
Figure 2-2	Airflow Through a Streamtube	2-4
Figure 2-3	Venturi Effect.....	2-5
Figure 2-4	Venturi Flow.....	2-7
Figure 2-5	Stagnation Point.....	2-7
Figure 2-6	Pressure Changes Around a Cambered Airfoil	2-9
Figure 2-7	Magnus Effect.....	2-10
Figure 2-8	Pressure Distribution for Magnus Effect.....	2-10
Figure 2-9	Induced Velocity Idealized for Momentum Theory	2-12
Figure 2-10	Variables in the Blade Element Theory	2-14
Figure 2-11	Airflow Over the Airfoil	2-15
Figure 2-12	Blade Element Diagram	2-15
Figure 2-13	Airfoil Nomenclature	2-17
Figure 2-14	Symmetrical Airfoil	2-17
Figure 2-15	Nonsymmetrical Airfoil.....	2-18
Figure 2-16	NACA Airfoil Notation.....	2-19
Figure 2-17	Relative Wind.....	2-20
Figure 2-18	Rotational Velocity (V-Rot)	2-21
Figure 2-19	Blade Tip Vortex Generation.....	2-22
Figure 2-20	Induced Flow and AOA.....	2-22
Figure 2-21	Development of Induced Velocity (Downwash)	2-23
Figure 2-22	Components of Linear Velocity	2-23
Figure 2-23	Blade Element Diagram	2-24
Figure 2-24	Blade Pitch Angle.....	2-25
Figure 2-25	AOA.....	2-25
Figure 2-26	Lift on a Symmetric Airfoil.....	2-26
Figure 2-27	Lift on a Cambered Airfoil.....	2-27
Figure 2-28	Streamlines Around a Symmetric Airfoil.....	2-28
Figure 2-29	Total Aerodynamic Force.....	2-29

Figure 2-30	Coefficient of Lift Versus AOA Curve.....	2-31
Figure 2-31	Forces Acting on an Airfoil	2-32
Figure 2-32	CD vs. AOA	2-33
Figure 2-33	Drag and Airspeed Relationship	2-34
Figure 2-34	Production of Induced Drag	2-36
Figure 2-35	Pitching Moments in Airfoils	2-37
Figure 2-36	“Droop Snoot” Design Airfoil.....	2-38
Figure 2-37	Balanced Forces, Hovering, No Wind.....	2-39
Figure 2-38	Unbalanced Forces Causing Acceleration	2-40
Figure 2-39	Balanced Forces, Steady-State Flight.....	2-40
Figure 2-40	Unbalanced Forces Causing Deceleration	2-41
Figure 3-1	Pressure Distribution and Leading Edge Suction.....	3-2
Figure 3-2	Bernoulli Equation as Derived by Euler.....	3-3
Figure 3-3	Continuity, Bernoulli, and Euler Equations.....	3-3
Figure 3-4	Blade Twist	3-4
Figure 3-5	Geometric combined w/aerodynamic and Aerodynamic Blade Twist.....	3-4
Figure 3-6	Blade Taper	3-5
Figure 4-1	Deflections in Linear and Rotating Systems.....	4-4
Figure 4-2	Phase Lag.....	4-6
Figure 4-3	Rotor Flapping Due to Cyclic Input.....	4-7
Figure 4-4	Phase Lag.....	4-8
Figure 4-5	Relationship Between Cyclic Inputs and Rotor Response	4-8
Figure 4-6	Cyclic Pitch Variation-Full Forward, Low Pitch.....	4-9
Figure 4-7	Centrifugal Force and Coning	4-10
Figure 4-8	Disk Area vs. Coning	4-11
Figure 4-9	CG Shifts with Flapping.....	4-12
Figure 4-10	Geometric Imbalance.....	4-13
Figure 4-11	Underslinging Compensation for Geometric Imbalance.....	4-14
Figure 5-1	Axis of Rotation.....	5-3
Figure 5-2	Rotor Configurations.....	5-4
Figure 5-3	Flow Effects from Overlapping Rotors.....	5-6
Figure 5-4	Sikorsky’s X2 TECHNOLOGY™ Demonstrator.....	5-8
Figure 6-1	Tail Rotor Unbalanced Force	6-2
Figure 6-2	Yaw Control Mechanisms for Various Configurations.....	6-3
Figure 6-3	Impact of Tail Rotor Direction	6-4
Figure 6-4	Tail Rotor Configurations.....	6-5
Figure 6-5	Plain Flapping Hinge and Delta-Three Hinge.....	6-6
Figure 6-6	NOTAR Anti-torque System.....	6-7
Figure 6-7	Vertical Stabilizer	6-8
Figure 6-8	Translating Tendency.....	6-9
Figure 6-9	Weather Vaning	6-9
Figure 6-10	Effects of Wind Direction on Directional Control	6-11

Figure 6-11	LTE in a Right Crosswind	6-13
Figure 6-12	Fly Home Capability After Loss Of Tail Rotor Thrust.....	6-15
Figure 7-1	Positive Static Stability	7-3
Figure 7-2	Negative Static Stability	7-4
Figure 7-3	Neutral Static Stability	7-4
Figure 7-4	Time History Plots, with Damping	7-5
Figure 7-5	Positive Dynamic Stability	7-6
Figure 7-6	Neutral Dynamic Stability.....	7-6
Figure 7-7	Negative Dynamic Stability.....	7-7
Figure 7-8	Effect of Rotor Systems on CG Travel.....	7-9
Figure 7-9	Lateral Dihedral Effect.....	7-11
Figure 7-10	Flying Wing Model	7-11
Figure 7-11	Positive and Negative Longitudinal Static Stability	7-12
Figure 7-12	Airspeed Stability.....	7-13
Figure 7-13	AOA Instability	7-14
Figure 7-14	Mechanical vs. Virtual Axis	7-16
Figure 7-15	Turning vs. Hover Thrust	7-17
Figure 7-16	Overcontrolling	7-18
Figure 7-17	Cyclic Control Response Around the Longitudinal and Lateral Axis	7-19
Figure 7-18	Hub Control Moments.....	7-19
Figure 7-19	Control Mechanisms for Various Configurations	7-20
Figure 7-20	Hover Trim	7-21
Figure 8-1	Total Drag Curve	8-3
Figure 8-2	Power Required Versus Airspeed Curve.....	8-4
Figure 8-3	Aerodynamic Forces Affecting Power Required	8-5
Figure 8-4	Power Required Curves Versus Airspeed	8-5
Figure 8-5	Optimum Airspeeds	8-7
Figure 8-6	Maximum Range Airspeed Adjustment for Winds	8-8
Figure 8-7	Induced Power Required.....	8-11
Figure 8-8	Parasite Power Required.....	8-12
Figure 8-9	Decrease in Excess Power as Airspeed Decreases	8-13
Figure 9-1	Hovering Flight	9-2
Figure 9-2	Hovering Flight - Blade Element Diagram.....	9-3
Figure 9-3	Power Required vs. Airspeed.....	9-4
Figure 9-4	Generation and Shape of Tip Vortices.....	9-5
Figure 9-5	Vortex Behavior	9-6
Figure 9-6	Vortex Activity Near the Ground.....	9-7
Figure 9-7	Aircraft Reactions to Wake Turbulence.....	9-8
Figure 9-8	HOGE.....	9-9
Figure 9-9	Airflow in Hovering Flight.....	9-9
Figure 9-10	HIGE	9-10
Figure 9-11	Thrust Improvement Due to Ground Effect	9-11
Figure 9-12	Effect of the Presence of the Ground on Induced Velocity	9-12

Figure 9-13	Tip Vortices In and OGE	9-13
Figure 9-14	Vortices	9-13
Figure 9-15	Distance from Rotor to Ground/Radar Altimeter Reading Zero.....	9-14
Figure 9-16	Power Required vs. Airspeed.....	9-15
Figure 9-17	Drag and Torque on Rotor Blade.....	9-16
Figure 9-18	Power Available vs. Power Required as Altitude Increases	9-19
Figure 9-19	Changes to Hover Power with Weight, Altitude, and rpm	9-19
Figure 9-20	Translating Tendency.....	9-20
Figure 9-21	Semi-Rigid Rotor System and Effect of Tail Low Attitude.....	9-21
Figure 9-22	Fully Articulated Rotor System.....	9-22
Figure 10-1	Differential Velocities on the Rotor System Caused by Forward Airspeed	10-3
Figure 10-2	AOA Distribution.....	10-4
Figure 10-3	Induced Power Required.....	10-6
Figure 10-4	Profile Power Required vs. Airspeed	10-7
Figure 10-5	Parasite Power Required vs. Airspeed.....	10-8
Figure 10-6	Power Required Curves	10-9
Figure 10-7	Effect of an Increase in Various Conditions on Power Required.....	10-10
Figure 10-8	Tailwind Power Requirement.....	10-11
Figure 10-9	Power Required Shift With Gross Weight	10-12
Figure 10-10	Initial Increase in Excess Power as Airspeed Increases	10-13
Figure 10-11	Effective Translational Lift (ETL)	10-14
Figure 10-12	Tilted Total Thrust Vector	10-15
Figure 10-13	Transverse Flow Effect.....	10-15
Figure 10-14	Transverse Flow Effect Due to Coning	10-16
Figure 10-15	Flapping (Advancing Blade – 3-O’Clock Position).....	10-17
Figure 10-16	Flapping (Retreating Blade – 9-O’Clock Position).....	10-18
Figure 10-17	Rotor System Axes in Hover and in Forward Flight.....	10-19
Figure 10-18	Blade Pitch Angles	10-19
Figure 10-19	Pendulum Effect.....	10-20
Figure 10-20	Ground Vortex	10-21
Figure 10-21	Velocity Distribution in Forward Flight.....	10-22
Figure 10-22	Retreating Blade Flapping	10-23
Figure 10-23	AOA Distribution.....	10-23
Figure 10-24	Retreating Blade Stall Region.....	10-24
Figure 10-25	Critical Mach Number	10-27
Figure 10-26	Drag Increase with Mach Number	10-28
Figure 10-27	Blade Areas in Forward Flight	10-29
Figure 10-28	Optimum Airspeeds	10-30
Figure 10-29	Power Required Chart (CH-46E).....	10-31
Figure 10-30	Fuel Flow vs. TAS	10-33
Figure 10-31	Excess Power	10-33
Figure 10-32	Max Range Altitude vs. Gross Weight.....	10-35
Figure 10-33	AH-1W - Max Range Airspeed vs. Gross Weight.....	10-36
Figure 10-34	SH-60B – Max Range Airspeed vs. Gross Weight	10-37

Figure 10-35	Rpm vs. Fuel Flow.....	10-38
Figure 10-36	Excess Power	10-39
Figure 10-37	Best Angle of Climb	10-40
Figure 10-38	Rate of Climb vs. Best Angle of Climb.....	10-40
Figure 11-1	Flow States of Flight	11-3
Figure 11-2	Velocity Profile in Normal Thrusting State.....	11-3
Figure 11-3	Induced Flow Velocity During Hovering Flight.....	11-6
Figure 11-4	Vortex Ring State (VRS)	11-6
Figure 11-5	Induced Flow Velocity Before VRS.....	11-7
Figure 11-6	VRS.....	11-7
Figure 11-7	Vortex Ring State.....	11-8
Figure 11-8	Power and Pitch to Maintain Constant Thrust.....	11-8
Figure 11-9	VRS Diagram	11-9
Figure 11-10	Generic VRS Diagram.....	11-11
Figure 11-11	TH-57 B/C (3000 lbs, SEA LEVEL).....	11-11
Figure 11-12	Flow States.....	11-13
Figure 11-13	Blade Element in Autorotation	11-14
Figure 11-14	Power Ratios in Climb and Descent	11-14
Figure 11-15	Autorotative State	11-16
Figure 11-16	Blade Regions in Vertical Autorotation Descent.....	11-17
Figure 11-17	Force Vectors in Vertical Autorotative Descent	11-18
Figure 11-18	Autorotative Regions in Forward Flight.....	11-20
Figure 11-19	Rotor System Flow Regions	11-21
Figure 11-20	Force Vectors in Level-Powered Flight at High Speed.....	11-23
Figure 11-21	Force Vectors After Power Loss – Reduced Collective	11-24
Figure 11-22	Rotor Speed vs. Pilot Reaction Time.....	11-25
Figure 11-23	Force Vectors in Autorotative Steady-State Descent.....	11-26
Figure 11-24	Rpm Response to Small rpm Variations.....	11-26
Figure 11-25	Autorotational Rate of Descent Compared to Airspeed.....	11-29
Figure 11-26	Blade Element and Thrust During Steady State Auto and Flare.....	11-30
Figure 11-27	Windmill Brake State	11-32
Figure 11-28	TH-57 H-V Diagram.....	11-32
Figure 11-29	Generic Height Velocity Diagram	11-34
Figure 12-1	Straight and Level Flight.....	12-3
Figure 12-2	Maintain Altitude By Increasing Thrust	12-4
Figure 12-3	Force Vectors in a Turn	12-4
Figure 12-4	Cosine and Inverse of Cosine for Various Angles of Bank	12-5
Figure 12-5	Power Required For Various Load Factors	12-6
Figure 12-6	Coordinated Flight.....	12-7
Figure 12-7	Skid and Slip.....	12-8
Figure 12-8	Load Factor vs. AOB	12-9
Figure 12-9	Time To Impact vs. Altitude at Constant Airspeed and Power.....	12-10
Figure 12-10	Overbank Equation Development	12-11
Figure 12-11	Effect of Overbank on Vertical Acceleration	12-12

Figure 12-12	Loss of Altitude With 10° of Overbank	12-12
Figure 12-13	Dive Pullout	12-13
Figure 12-14	V-n Diagram for Fixed Wing Aircraft	12-15
Figure 12-15	AH-64 Apache V-n Diagram.....	12-15
Figure 12-16	Sources of Rotor System Control Moments	12-19
Figure 12-17	Thrust Vector Tilt.....	12-19
Figure 12-18	Main Rotor Rotating Frequency	12-21
Figure 12-19	Vibration Analysis	12-22
Figure 12-20	Blade Modes	12-24
Figure 12-21	M/R Frequencies	12-25
Figure 12-22	Driving Frequencies.....	12-26
Figure 12-23	Oscillating Plunge Forces Trying to Tame the Rotor.....	12-26
Figure 12-24	Rotor System Out of Balance.....	12-31
Figure 12-25	H-46 in Ground Resonance.....	12-32
Figure 12-26	H-46 with Blade Pattern Imbalance.....	12-33
Figure 12-27	Forces and Moments About a Helicopter CG	12-35
Figure 12-28	Moment of Inertia Example.....	12-36
Figure 12-29	Forces Acting on Aircraft During Dynamic Rollover	12-39
Figure 12-30	Rollover Moment for Varying Crosswind and Collective Pitch Setting... 	12-41
Figure 13-1	Concepts and Terminology	13-2
Figure 13-2	Blade Element Diagram	13-3
Figure 13-3	Power Required Versus Power Available.....	13-4
Figure 13-4	Autorotation Height Velocity Diagram.....	13-5

THIS PAGE INTENTIONALLY LEFT BLANK

CHAPTER ONE INTRODUCTION AND BASIC PHYSICS REVIEW

100. INTRODUCTION

The purpose of this chapter is to aid the student in understanding the history of helicopter flight, and to provide a review of basic physics and atmospheric relevant to helicopter aerodynamics.

This lesson topic will review many terms and concepts originally introduced in aviation preflight indoctrination. Any concepts in this section that remain a challenge to the student may be reviewed in further detail in the Fundamentals of Aerodynamics Student Guide (NAVAVSCOLSCOM-SG-111) from API.

101. LESSON TOPIC LEARNING OBJECTIVES

1. **Terminal Objective.** Partially supported by this lesson topic:

Upon completion of this unit of instruction, the student aviator will demonstrate knowledge of basic aerodynamic factors that are important to an understanding of helicopter performance.

2. **Enabling Objectives.** Completely supported by this lesson topic:

- a. Recall the definition of scalar quantity, vector, force, mass, volume, density, weight, moment, work, power, energy, potential energy, and kinetic energy.
- b. Recall the definition of equilibrium flight.
- c. Recall the definition of static pressure, air density, temperature, lapse rate, humidity, and air viscosity.
- d. Recall the definition of pressure altitude (PA).
- e. Recall the definition of density altitude (DA).
- f. State Newton's three Laws of Motion, giving examples of each.
- g. State the relationship between humidity and air density.
- h. State the relationship between temperature and air viscosity.
- i. List the main gases of the air and their relative proportions.
- j. Describe the relationship between the three properties of air; pressure, density and temperature as it relates to the General Gas Law.

- k. Describe the effect of pressure, temperature, and humidity on the density of the air as related by the General Gas Law.
- l. Describe the relationship between helicopter performance and DA.
- m. State the pressure, temperature, lapse rate, and air density at sea level in the standard atmosphere using both Metric and English units of measurement.
- n. Describe the Standard Atmosphere and state its purpose.
- o. State the relationships between temperature, pressure, air density, local speed of sound and altitude within the standard atmosphere.
- p. Determine the DA using a DA chart.
- q. Recall the effect of temperature and humidity on DA.

102. REFERENCES

- 1. A History of Aerodynamics
- 2. Helicopter Theory
- 3. Principles of Helicopter Aerodynamics
- 4. Helicopter Aerodynamics
- 5. Rotary Wing Aerodynamics for Naval Aviators
- 6. Fundamentals of Flight
- 7. Fundamentals of Aerodynamics Student Guide (NAVAVSCOLSCOM-SG-111)

103. STUDY ASSIGNMENT

- 1. Review Chapter One.
- 2. Answer the Review Questions.

104. REVIEW OF BASIC PHYSICS AND AERODYNAMICS

Based on the student naval aviator's recent completion of aviation preflight indoctrination, the review of vector analysis, physics and atmospheric has been abbreviated to include only those concepts which are also applicable to rotary wing flight. If necessary, review your "Fundamentals of Aerodynamics" workbook from API. There are also a few concepts, such as density altitude (DA) computation, which will be introduced within this section because of a

1-2 INTRODUCTION AND BASIC PHYSICS REVIEW

clear connection to the reviewed material. Why is physics important? Aerodynamics is a branch of aeromechanics, which is a branch of mechanics, and mechanics is a branch of physics. Therefore, aerodynamics is all about physics or as a physics teacher once said “if it isn’t physics, it’s stamp collecting!”

105. VECTOR ANALYSIS

A **scalar** is a quantity that describes only magnitude, e.g., time, temperature, or volume. It is expressed using a single number, including units. A **vector** is a quantity that describes both magnitude and direction. It is commonly used to represent displacement, velocity, acceleration, or force.

Vectors can be represented as arrows. The direction and length of the arrow represent the direction and magnitude of the vector. Vectors may be added by placing the tail of each succeeding vector on the head (or tip) of the one preceding it and drawing the resultant vector from the tail of the first to the tip of the last. This new vector is the resulting magnitude and direction of all the original vectors working together as demonstrated by the navigation example below (Figure 1-1).

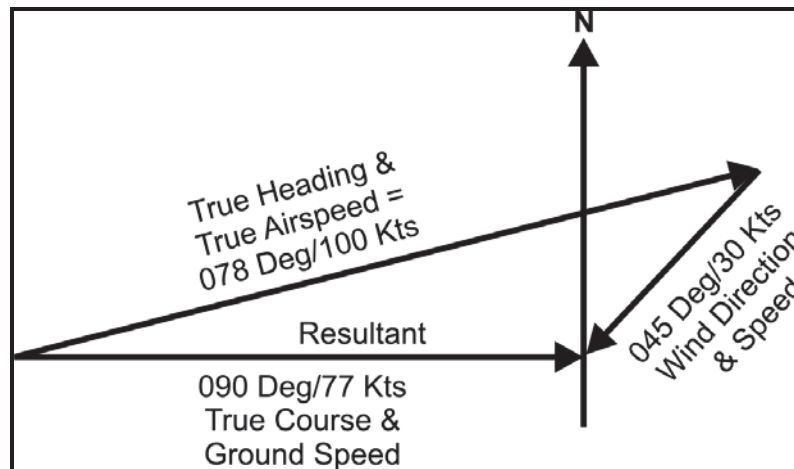

Figure 1-1 Resultant by the Tip-to-Tail Method

Conversely, a vector may be deconstructed into two or more component vectors that lie in whatever planes of motion or direction we wish.

For example, an aircraft in a 30° climb at 100 knots may be said to have 86.6 knots of horizontal velocity and 50 knots of vertical velocity. Or, in another example, an aerodynamic force vector may be deconstructed into lift and drag components.

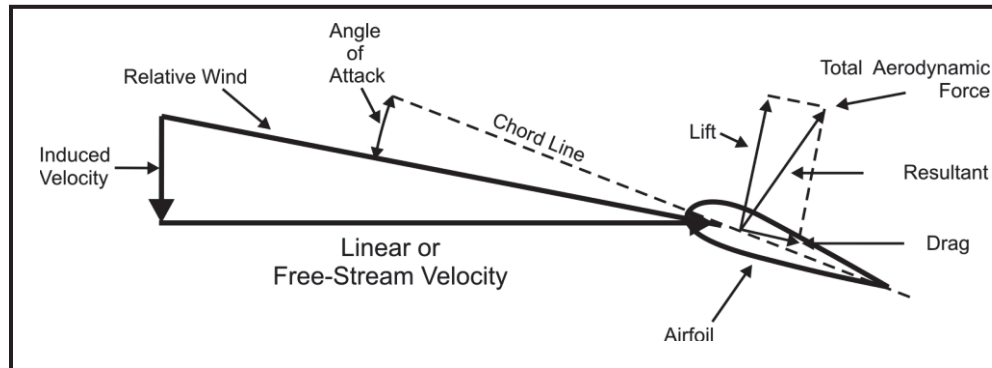

Figure 1-2 Force Vectors on an Airfoil

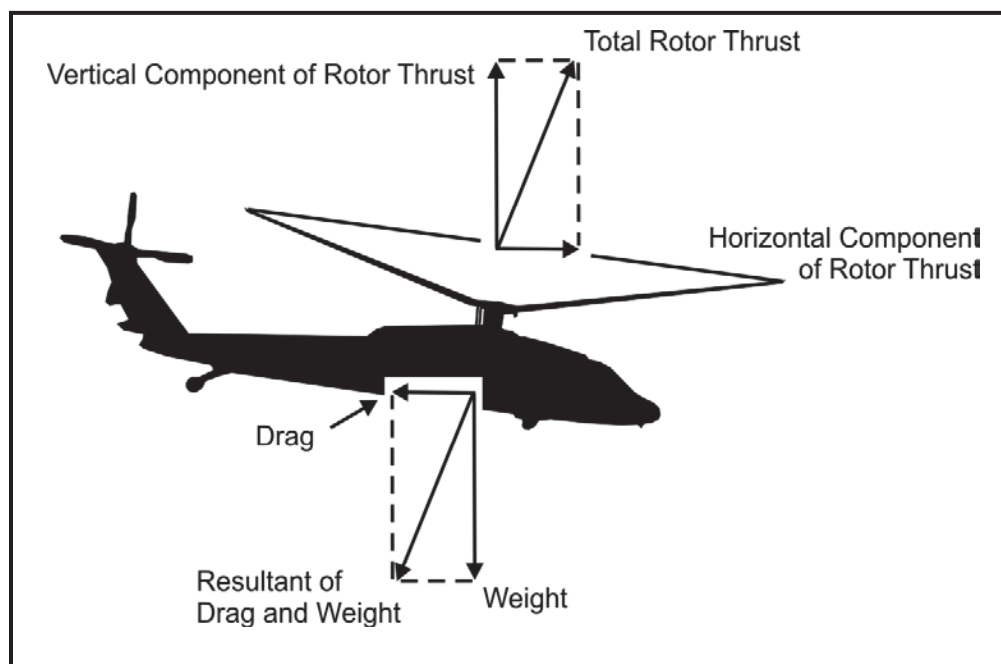

Figure 1-3 Force Vectors on Aircraft in Flight

Figures 1-2 and 1-3 show an example of vectors used to depict the forces acting on an airfoil segment, and an aircraft in flight. Note that the total rotor thrust vector may be resolved into perpendicular components, a vertical component and a horizontal component. Also, the drag and weight can be combined to form a resultant of these two forces, which must then be equal and opposite to the total rotor thrust in equilibrium flight.

Displacement (s) is the distance and direction of a body's movement (an aircraft flies 100 NM east). **Velocity (V)** is the speed and direction of a body's motion, the rate of change of position (an aircraft flies south at 150 knots). Note that reversal of a velocity vector can also be represented by merely changing the sign of the speed or magnitude.

Distance is the scalar equivalent to the magnitude of displacement. Speed is a scalar equivalent to the magnitude of velocity. **Force (F)** is a vector measure of the push or pull exerted on a body (15,000 lbs of rotor thrust holds an aircraft at a hover).

$$\mathbf{F} = \mathbf{m} \mathbf{a}$$

Mass (m) is the quantity of molecular material that comprises an object.

Acceleration (a) is the rate and direction of a body's change of velocity (gravity accelerates bodies toward the center of the earth at 32.174 ft/s² or 9.8 m/s²).

The above terms are introduced here as examples of scalar and vector quantities. Other terms relevant to the study of physics, as it applies to aerodynamics, are defined in the next section.

106. ESSENTIAL TERMS AND DEFINITIONS

1. **Volume (v)** is the amount of space occupied by an object.
2. **Density (ρ or 'rho')** is mass per unit volume. It is expressed:

$$\rho = \mathbf{m} / \mathbf{v}$$

3. **Weight (W)** is the force with which a mass is attracted toward the center of the earth by gravity.
4. A **moment (M)** is created when a force is applied at some distance from an axis, and tends to produce rotation about that point. **A moment is a vector quantity equal to a force (F) times the distance (d) from the point of rotation on a line that is perpendicular to the applied force vector.** This perpendicular distance is called the moment arm. **Torque (Q)** is another word for a moment created by a force.

$$\mathbf{M} = \mathbf{F} \mathbf{d}$$

5. **Work (W)** is done when a force acts on a body and moves it. It is a scalar quantity **equal to the force (F) times the distance of displacement (s).**

$$\mathbf{W} = \mathbf{F} \mathbf{s}$$

6. **Power (P)** is the rate of doing work or work done per unit of time.

$$\mathbf{P} = \mathbf{F} (\mathbf{s}) / \mathbf{t} = \mathbf{W} / \mathbf{t}$$

NOTE

The power may also be represented in two other ways later in the text:

$$1) \quad P = F (s/t) = F * V$$

$$2) \quad P = (Fd) / t = Q * \text{rpm}$$

7. **Energy** is a scalar measure of a body's capacity to do work. There are two types of energy: potential energy and kinetic energy. Energy cannot be created or destroyed, but may be transformed from one form to another. This principle is called the law of conservation of energy. The equation for total energy is:

$$\text{T.E.} = \text{K.E.} + \text{P.E.}$$

8. **Potential energy (P.E.)** is the ability of a body to do work because of its position or state of being. It is a function of mass (m), gravity (g), and height (h), or of chemical composition. In aerodynamics only the former is considered.

$$\text{P.E.} = \text{weight} \times \text{height} = m g h$$

9. **Kinetic energy (K.E.)** is the ability of a body to do work because of its motion. It is a function of mass (m) and velocity (V).

$$\text{K.E.} = \frac{1}{2} mV^2$$

Work may be performed on a body to change its position and give it potential energy or work may give the body motion so that it has kinetic energy. Under ideal conditions, if no work is being done on an object, its total energy will remain constant. Such an object is considered to be in a closed system. In a closed system, the total energy will remain constant but potential energy may be converted to kinetic energy, and vice versa. For example, the kinetic energy of a glider in forward flight may be converted into potential energy by climbing. As the glider's altitude (P.E.) increases, its velocity (K.E.) will decrease.

107. NEWTON'S LAWS OF MOTION

1. Newton's First Law - The Law of Equilibrium:

"A body at rest tends to remain at rest and a body in motion tends to remain in motion **at a constant velocity** (same speed and direction) unless acted upon by some unbalanced force."

The tendency of a body to remain in its condition of rest or motion is called inertia.

Equilibrium is the absence of acceleration, either linear (in a straight line) or angular (rotational). **Equilibrium exists when the sum of all the forces and the sum of all the moments around the center of gravity (CG) are equal to zero.** An airplane in straight and level flight at a constant velocity is acted upon by four basic forces: thrust, drag, lift and weight. In this situation, all four forces act either completely horizontally or completely vertically. In the helicopter, total rotor thrust provides both the vertical and the horizontal components. When the horizontal component is equal to drag, and the vertical component is equal to weight, the helicopter is considered to be in equilibrium (Figure 1-4).

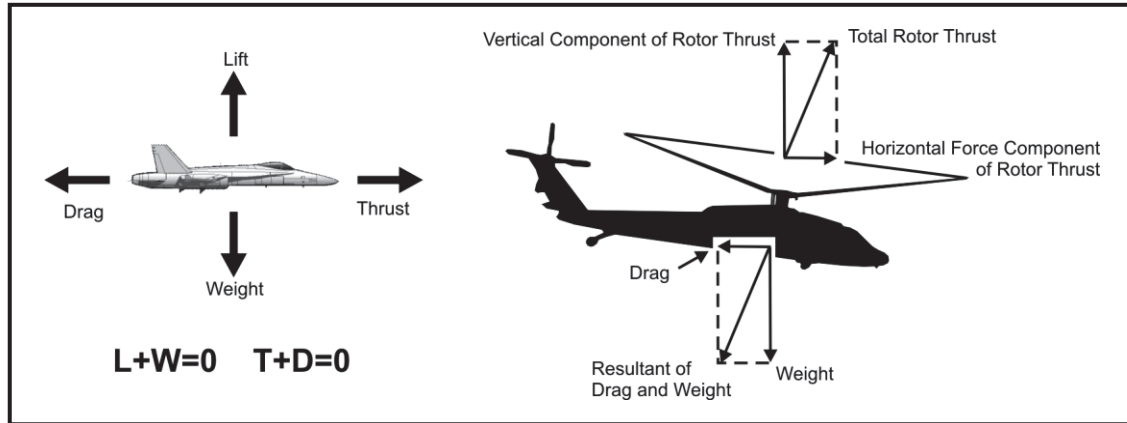

Figure 1-4 The Law of Equilibrium

An aircraft does not have to be in straight and level flight to be in equilibrium. An aircraft that is climbing at a 30° angle to the horizon, but not accelerating or decelerating, exhibits no unbalanced forces. This is another example of equilibrium flight. The horizontal component of thrust must overcome the horizontal components of both drag and lift. The vertical components of thrust and lift must overcome the weight and the vertical component of drag.

Figure 1-5(a) shows an airplane that is able to generate sufficient thrust to climb vertically (90° to the horizon) at a constant true airspeed can also stabilize at an equilibrium flight condition. Thrust must equal weight plus total drag, and lift provided by the wings must be zero.

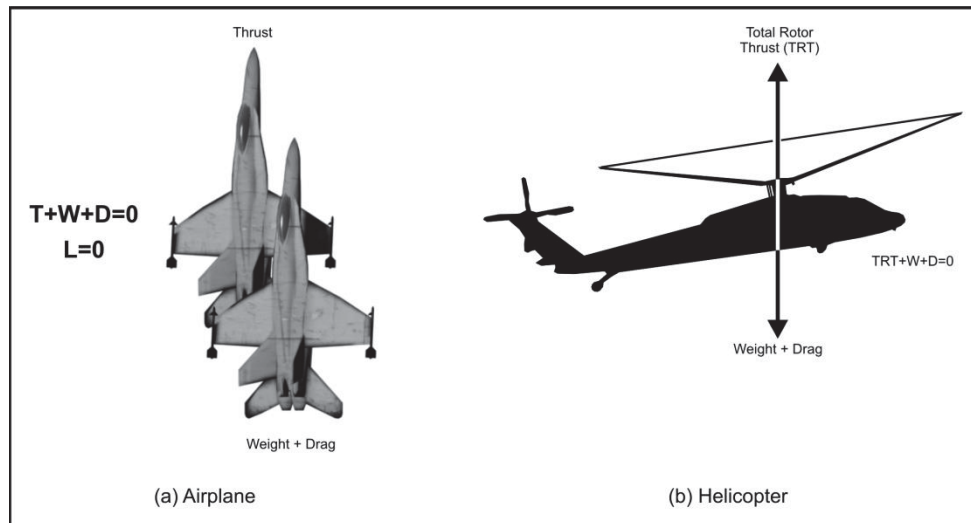

Figure 1-5 Vertical Climb

An airplane experiences lift as a result of airflow across an airfoil due to a longitudinal thrust vector. In the above example, lift is zeroed due to a vertical thrust vector.

In a helicopter (Figure 1-5(b)), therefore, the main rotor thrust vector primarily provides this lifting force. Forward flight results from a tilting of this thrust vector. The division of main

rotor thrust into its vertical (lifting) component and horizontal (propulsive) component (Figure 1-4) will be discussed later in the text.

Trimmed flight exists when the sum of the moments around the CG is zero. In trimmed flight, however, the sum of the forces may not be equal to zero since you can trim an airplane into a turn. **If you are in equilibrium flight, then you are in trimmed flight, but the reverse is not necessarily true.**

2. Newton's Second Law - The Law of Acceleration

"An unbalanced force (**F**) acting on a body produces an acceleration (**a**) in the direction of the force that is directly proportional to the force and inversely proportional to the mass (**m**) of the body."

If there is an unbalanced force on a body, the body is no longer in equilibrium and the body will accelerate. Acceleration is the rate of change in velocity (a change in either speed or direction). The force required to produce a change in motion of a body is directly proportional to the mass of the body and the acceleration, $F = ma$ (force equals the object's mass times its acceleration). Hence, assuming the aircraft mass to be constant, a specific amount of unbalanced force, that is, an increase in propulsive force will generate a proportional acceleration. The greater the unbalanced force, the greater the acceleration. Commonly, an acceleration in which the change in velocity is a decrease in speed is called a "deceleration."

When an aircraft's thrust is greater than its drag (in level flight), the amount of extra thrust (not balanced out by drag) will accelerate the aircraft until drag increases to equal the total thrust. In a turn, the aircraft's lift is no longer purely vertical. The horizontal component of lift created in a bank is not balanced by any other force on the aircraft, and so accelerates the aircraft in the direction of bank, causing a change in direction or turn.

3. Newton's Third Law - The Law of Interaction:

"For every action, there is an equal and opposite reaction."

A more commonplace example is that of weight and the normal force. An object sitting motionless on the floor exerts a force downward due to its weight. For that object to remain motionless in equilibrium and not be accelerated toward the center of the earth, the floor must push upward on the object with a force equal to the object's weight. That upward force is called the normal force.

Similarly, a hovering helicopter may be viewed as an application of this law. The rotor accelerates air particles downward as the air passes through the rotor system. This time rate of change of vertical momentum of the air thus creates a vertical force downward on the air. The downward acceleration of the air results in an equal and opposite upward reaction of the rotor system. This upward reaction force known as "thrust" acts perpendicular to the tip path plane, and opposes the force due to gravity of the helicopter's mass (weight). This is an example of momentum theory and will be discussed in more detail later in the text.

108. PROPERTIES OF THE ATMOSPHERE

The atmosphere is composed of approximately 78% nitrogen (N_2), 21% oxygen (O_2), and 1% other gases by volume, which includes argon and carbon dioxide. Air is considered to be a uniform mixture of these gases, so we will examine its characteristics as a whole rather than as separate gases.

1. **Static pressure (P_s)** is the force each air particle exerts on those around it. On a more macroscopic scale, ambient static pressure (14.7 psi at sea level on standard day) is equal to the weight of a column of air over a given area (Figure 1-6). The force of static pressure acts perpendicularly to any surface with which the air particles collide. As you increase altitude, less air is above you, so the weight of the column of air is decreased. Thus **atmospheric static pressure decreases with an increase in altitude** at a rate of approximately 1.0 in-Hg per 1000 feet, near the earth's surface.

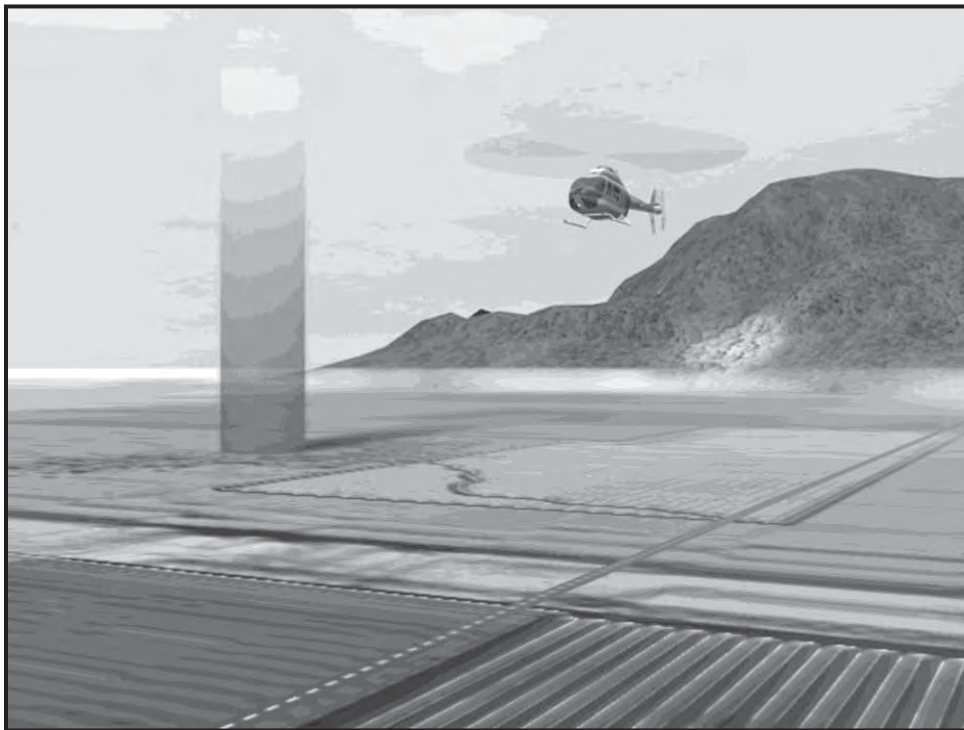

Figure 1-6 Static Pressure

2. **Air density (ρ)** is the total mass of air particles per unit of volume. The distance between individual air particles increases with altitude resulting in fewer particles per unit volume. Therefore, **air density decreases with an increase in altitude**.

3. **Density Ratio (σ)** is the ratio of the density of air at a specific altitude to that of the standard altitude (sea level).

4. **Temperature (T)** is a measure of the average kinetic energy of air particles. As temperature increases, particles begin to move and vibrate faster, increasing their kinetic energy (δ°) (Figure 1-7). **Air temperature decreases linearly with an increase in altitude at a rate of approximately 2 °C (3.57 °F) per 1000 ft up through 36,000 feet MSL.** This is called the **standard, or adiabatic lapse rate**. Above 36,000 feet lies another layer of air at a constant temperature of -56.5 °C called the isothermal layer.

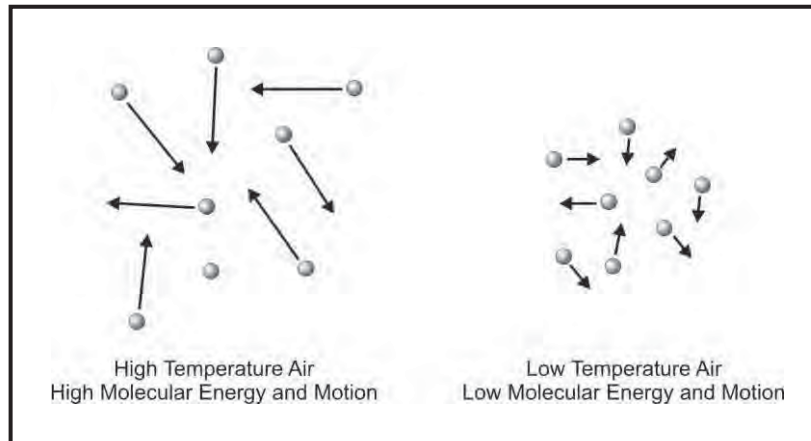

Figure 1-7 Molecular Energy and Air Temperature

5. **Humidity** is the amount of water vapor in the air. As humidity increases, water molecules displace an equal number of air molecules. Since water molecules have less mass (H_2O , molecular weight (MW) 18) than air (N_2 , MW 28; and O_2 , MW 32) and occupy approximately the same volume, the overall mass in a given volume decreases. Therefore, **as humidity increases, air density decreases**. Compared to dry air, the density of air at 100% humidity is 4% less.

6. **Viscosity (μ)** is a measure of the air's resistance to flow and shearing. Air viscosity can determine its tendency to stick to a surface or how easily it flows past it. For liquids, as temperature increases, viscosity decreases. Recall that the oil in your car flows better or “gets thinner” when the engine gets hot. Just the opposite happens with air: **Air viscosity increases with an increase in temperature**. This will be discussed further with engine performance.

109. THE GENERAL GAS LAW

The General Gas Law demonstrates the relationship between the three major properties of air: pressure (P), density (ρ), and temperature (T). It is expressed as an equation where R is the Universal Gas Constant

$$P = \rho R T$$

This equation can be used to describe what happens to a gas under ideal circumstances when changes occur to one of the properties while another is kept constant.

For instance, in a closed system, one is able to increase pressure by keeping density constant and increasing temperature (as in a pressure cooker). On the other hand, in an open system like the atmosphere, if pressure remains constant, density and temperature have an inverse relationship. An increase in temperature will result in a decrease in density, and vice versa. These relationships are demonstrated below:

$$\begin{array}{ccc} \leftarrow P = \rho R T \rightarrow & \uparrow P = \rho R T \uparrow & \downarrow P = \rho R T \leftarrow \end{array}$$

Figure 1-8 Gas Under Variable Changes

The effects of several atmospheric properties may be demonstrated through the warming period of a day. Although the static pressure and PA may remain virtually constant throughout the day, as the sun heats the air, the reduced density causes a dramatic increase in density altitude. This has a noticeable impact by decreasing aircraft performance.

110. THE STANDARD ATMOSPHERE

The atmospheric layer in which most flying is done is an ever-changing environment. Temperature and pressure vary with altitude, season, location, time, and even solar sunspot activity. It is impractical to take all of these into consideration when discussing airplane performance. In order to disregard these atmospheric changes, an engineering baseline has been developed called the **standard atmosphere** (Figure 1-9). It is a set of reference conditions giving average values of air properties as a function of altitude. **Unless otherwise stated, any discussion of atmospheric properties in this course will assume standard atmospheric conditions.**

Altitude (ft)	Density (slugs/ft ³)	Density Ratio	Pressure (psf)	Pressure Ratio	Temperature		Tempera- ture Ratio	Speed of Sound (knots)
					°F	°C		
h	ρ	σ	p	δ			θ	α
0	0.002377	1.0000	2116	1.0000	59.00	15.00	1.0000	681.7
1,000	0.002308	0.9711	2041	0.9644	55.43	13.02	0.9831	659.5
2,000	0.002241	0.9428	1968	0.9298	51.87	11.04	0.9662	637.2
3,000	0.002175	0.9151	1897	0.8962	48.30	9.06	0.9794	614.9
4,000	0.002111	0.8881	1828	0.8637	44.74	7.08	0.9725	592.6
5,000	0.002048	0.8617	1761	0.8320	41.17	5.09	0.9656	570.3
6,000	0.001987	0.8369	1696	0.8014	37.60	3.11	0.9587	547.9
7,000	0.001927	0.8108	1633	0.7718	34.04	1.13	0.9519	525.6
8,000	0.001868	0.7860	1572	0.7428	30.47	-0.86	0.9450	503.3
9,000	0.001811	0.7620	1513	0.7148	26.90	-2.83	0.9381	480.9
10,000	0.001755	0.7386	1455	0.6877	23.34	-4.81	0.9312	458.6
11,000	0.001701	0.7156	1400	0.6616	19.77	-6.79	0.9244	436.2
12,000	0.001648	0.6933	1346	0.6361	16.21	-8.77	0.9175	413.8
13,000	0.001596	0.6714	1294	0.6116	12.64	-10.76	0.9106	391.4
14,000	0.001545	0.6500	1243	0.5874	9.07	-12.74	0.9037	369.0
15,000	0.001496	0.6292	1194	0.5643	5.51	-14.72	0.8969	346.7
20,000	0.001266	0.5328	972.5	0.4596	-12.32	-24.62	0.8625	314.6
25,000	0.001065	0.4481	785.3	0.3711	-30.15	-34.53	0.8281	282.2
30,000	0.000889	0.3741	628.4	0.2970	-47.98	-44.43	0.7937	249.5
35,000	0.000737	0.3099	498.0	0.2363	-65.82	-54.34	0.7594	216.8
36,089	0.000708	0.2971	472.7	0.2234	-69.70	-56.50	0.7519	213.8
40,000	0.000685	0.2462	391.7	0.1851	-69.70	-56.50	0.7519	213.8
50,000	0.000362	0.1522	242.2	0.1145	-69.70	-56.50	0.7519	213.8
60,000	0.000224	0.0941	149.8	0.0708	-69.70	-56.50	0.7519	213.8

Figure 1-9 Standard Atmosphere Table

Sound is caused by some disturbance in the air; for example, an explosion causes a sound because it compresses the air immediately around it. **Sound is wave motion, not particle motion, so the motion of sound can be affected by changes in the medium through which it travels.** The **local speed of sound** is the rate at which sound waves travel through a particular air mass. The speed of sound in air is primarily dependent on the temperature of the air. **As the temperature of the air increases, the speed of sound increases.** This is most relevant in the discussion of advancing blade Mach effects, or compressibility, later in the text.

111. ALTITUDE COMPUTATIONS

One of the benefits of a standard atmosphere lies in the concepts of **pressure altitude** (PA) and **density altitude** (DA). PA is that altitude in the standard atmosphere which corresponds to a particular static air pressure. An aircraft altimeter senses pressure through the static portion of the pitot-static system, then shows the altitude at which that pressure would be found in the standard atmosphere. The pitot-static system will be discussed in more detail in Chapter Two. All early altimeters were referenced to the standard Sea Level pressure of 29.92 inches Hg at sea level. Altitude was estimated by determining the altitude in the standard atmosphere at which the measured pressure would occur. Modern altimeters can be adjusted to yield accurate altitude

at a known point, like an airfield, by changing reference sea level pressure to an appropriate value. Airport meteorologists measure air pressure, determine what pressure at sea level would have to exist to yield an accurate altitude reading using standard pressure lapse rate, and report that setting to pilots. After being set properly, an adjustable altimeter reports the altitude at which the measured pressure would be found if a standard pressure lapse rate was applied to a sea level pressure equal to that set by the pilot. **Standard pressure lapse rate is 1000 feet of PA for each one inch of Hg.** To determine PA (in the standard atmosphere) for use in calculations a pilot needs only to set 29.92 inches into the altimeter and read the result.

Properly setting the altimeter and periodically checking for changes in the prescribed setting can be very important. To properly set the altimeter, pilots should make sure that they are receiving the altimeter setting in inches of mercury for height above sea level. Three types of settings may be encountered overseas: QNH, QNE, and QFE.

1. QNH is altitude corrected to standard sea level (provided in ATIS in the United States).
2. QNE is PA (altimeter set to 29.92)
3. QFE is a setting at an airfield to read height above ground at that location (the altimeter would read zero at the airfield surface).

The issue overseas is further confused by the fact that settings are often given in hectopascals (millibars), rather than inches of mercury. To avoid problems, listen for foreign controllers' statements of what their pressure reference is and, if necessary, use the Flight Information Handbook to convert.

Checking for changes in altimeter setting during cross country travel or as weather moves in can also be important. When station pressure or temperature drops, an altimeter set at the previous condition will read higher than it should. For example, as depicted in figure 1-10 below, a flight at 1000 ft AGL in the standard atmosphere would have the aircraft at a pressure of 28.92. Note that flight into a high pressure system would cause the altimeter to read low (actual altitude of 2000 ft AGL) while flight into a low pressure system would cause the altimeter to read higher than actual altitude (0 ft AGL).

REMEMBER

“High to low look out below” or “hot to cold look out below.”

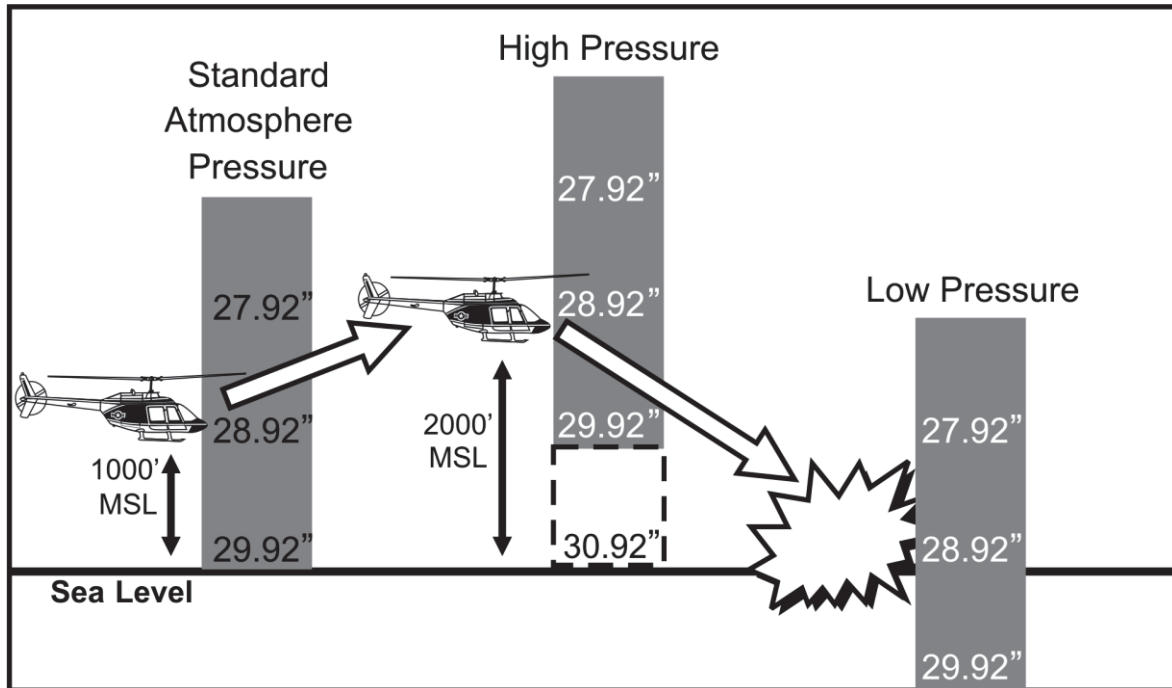

Figure 1-10 Pressure Altitude vs. True Altitude with Varying Local Pressures

112. ALTITUDE COMPUTATIONS – DENSITY ALTITUDE

A more appropriate term for correlating aerodynamic performance in the nonstandard atmosphere is density altitude (DA). DA is that altitude in the standard atmosphere which corresponds to a particular air density. Changes in air density are caused by variations in atmospheric pressure, temperature, and humidity. **Density altitude (DA) is the PA corrected for temperature and humidity deviations from the standard atmosphere.** If you know the outside air temperature and humidity, and you can determine the PA, as described above, you can derive the DA. DA is the environmental factor which most significantly affects power available.

Typically, aviators will use a chart (Figure 1-11) to determine DA for the ambient PA and temperature. Enter the chart at the bottom at the appropriate outside air temperature (OAT) and plot vertically upward to intersect the current PA depicted on the diagonals, determined by dialing 29.92 into the aircraft altimeter. From this point, read laterally to the left to determine the DA (not corrected for humidity). In the example depicted on Figure 1-11, a temperature of 6 °C and 2400' PA, the DA is 2000'.

Another method for estimating DA is to use the ‘rule of thumb’ equation below.

$$DA = PA + [(T_{\text{Ambient}} - T_{\text{Std@Altitude}})] \times 120$$

For PA, dial in 29.92 " Hg. Temps are in °C.

The above ‘rule of thumb’ merely requires an accurate understanding of standard temperature at altitude. Remember that the temperature at sea level for a standard day is 15 °C. With an average lapse rate of 2 °C / 1000’ MSL, the standard temperature at altitude can be easily determined; i.e., 5 °C at 5000’ MSL, and -5 °C at 10,000’ MSL. This estimation of DA still fails to correct for humidity, which is discussed below.

As mentioned earlier, changes in the water vapor content, or **humidity**, can also greatly affect the density of the air, in addition to temperature deviations from standard. To recap, as humidity increases, water molecules with less mass and approximately the same volume as air molecules displace the more dense air molecules to make the same overall volume contain less actual mass. Thus, an increase in humidity leads to a decrease in air density, and, therefore, an increase in DA.

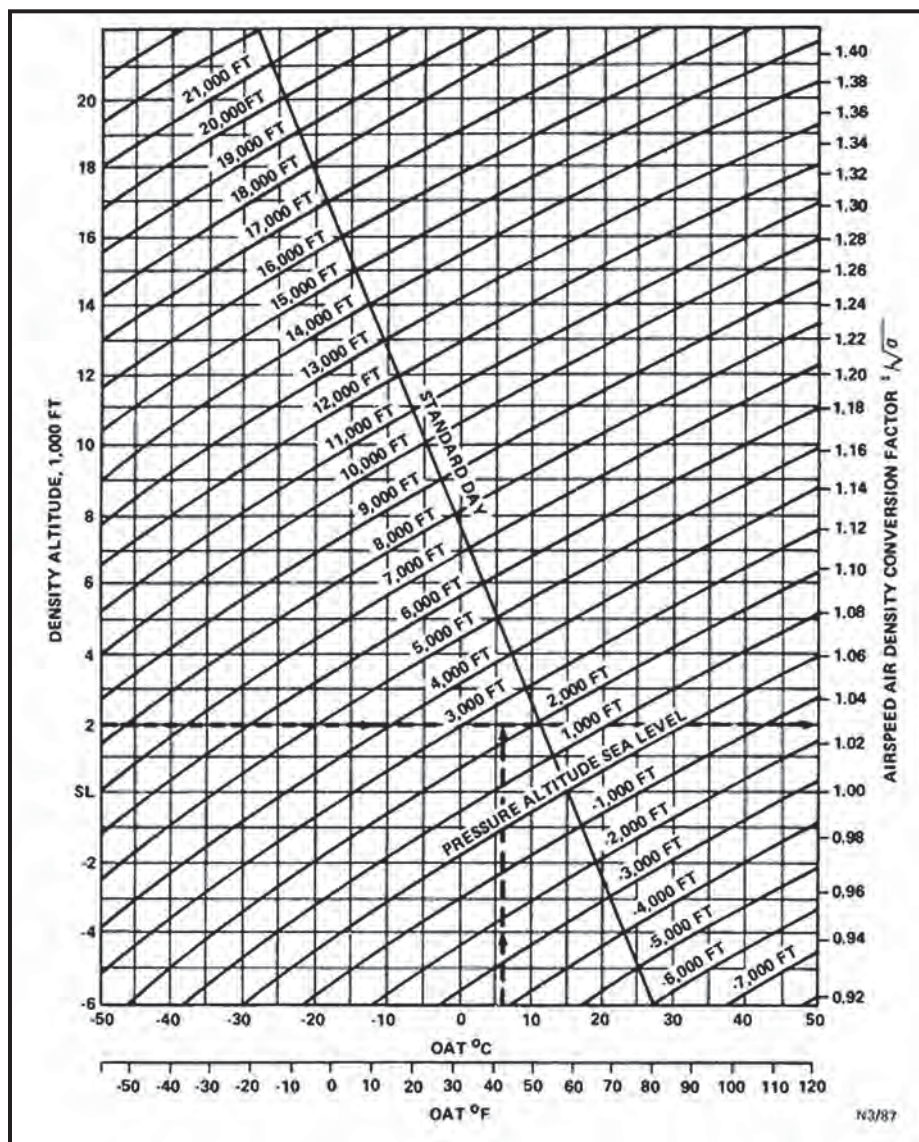

Figure 1-11 DA Chart

One way to adjust calculations for humidity is to use a higher temperature than might be associated with lower density in performance charts. This fictional quantity is known as **virtual temperature**, and is defined as OAT corrected for relative humidity. In the same way that wind chill is applied to a cold day's temperature to reflect how the wind affects the human body, a virtual temperature correction may be applied to a temperature measurement to reflect the effect of humidity on the air's density. The genesis of this virtual temperature concept for military pilots was possibly an old 1962 Navy Weather Research Facility pamphlet that rigorously defined the equations involved in DA computations and illustrated their relationships for practical application using a DA Circular Computer. These computers are still in use today at many weather offices. The dew point temperature correction chart (Figure 1-12) serves the same purpose as a DA Computer. It accepts dew point and temperature, and then yields virtual temperature and DA. Regardless of method used, the question you might want to ask your weather briefer is if virtual temperature (moisture effect) was used in the computation of the DA given on your weather brief.

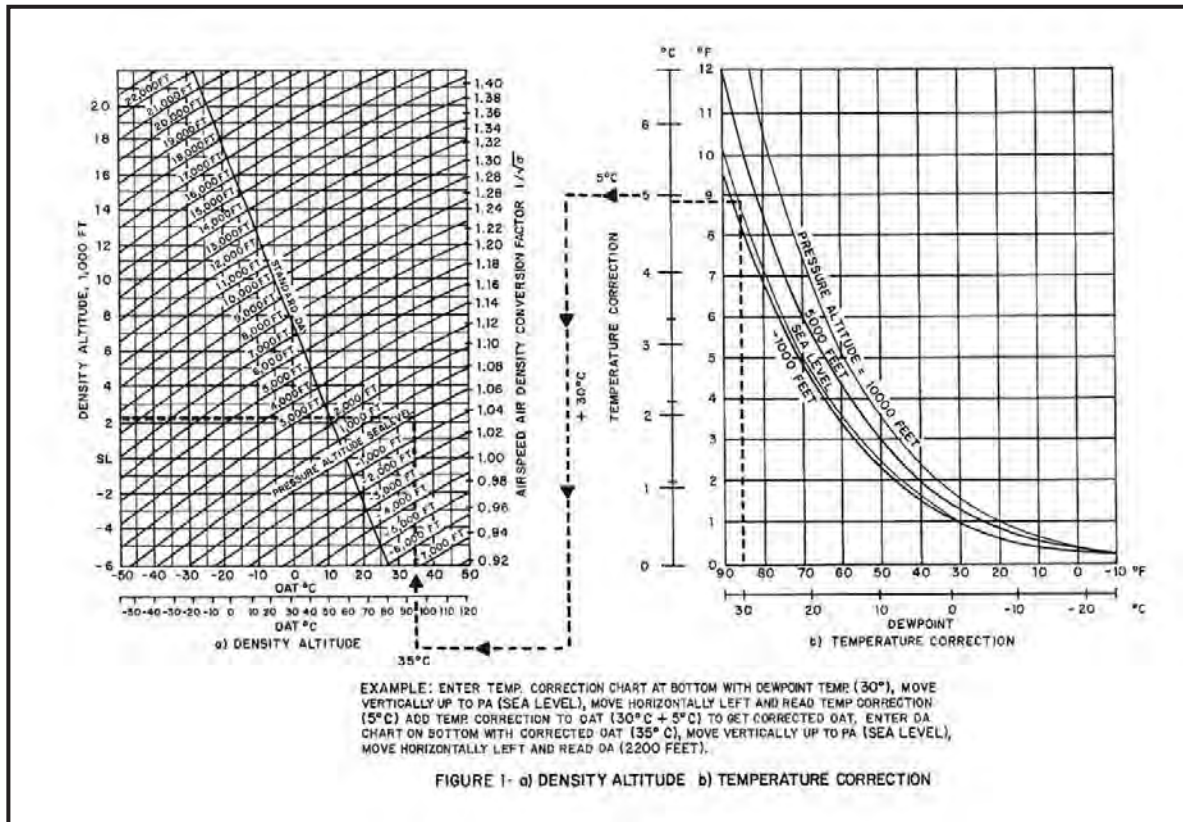

Figure 1-12 Dew Point Correction Chart

Moisture in the air can be slightly beneficial in controlling engine temperature, but generally tends to be detrimental to helicopter performance. Moisture as liquid can provide valuable cooling to an engine. For example, water is sprayed into the inlet of an AV-8B to cool the airflow during high demand operations so that maximum power can be obtained without exceeding material heat limits on turbine blades.

As the water evaporates, it cools the airflow leading to the engine turbine section allowing higher combustion temperatures and an increase in thrust produced. But moisture as vapor in the air is also a performance degrader. The decrease in the density of the airflow due to the presence of water molecules requires more mass flow of air to produce the same amount of thrust. Since only a limited amount of air can be run through the engine, the effect of water vapor is to reduce power available.

This loss of power available and aforementioned cooling effects tend to offset each other in typical helicopter operating scenarios, so engine performance doesn't change as much with humidity (Figure 1-12) as it does with temperature (discussed in Chapter Five).

Furthermore, with respect to rotor systems, reduced air density decreases the lift produced on the rotor blades as discussed further with the lift equation in Chapter Two. For this reason, the overall effect of humidity degrades helicopter performance.

The previous philosophy on how to handle the effect of moisture on DA varied from either **no adjustment** whatsoever to the **10% rule** of thumb for relative humidity (RH), adopted by numerous NATOPS manuals, of adding 100 feet to your DA (based on PA and OAT), **for every 10% relative humidity above 0% RH.**

$$\text{DA (corrected for RH)} = \text{DA (chart)} + (100' \times \text{RH}/10\%)$$

NOTE

The TH-57 NATOPS Manual refers to the 10% rule. Therefore, it will be used for test purposes.

The 10% adjustment factor stems from a linear approximation of the curve (Figure 1-13). Some manuals state that the relative humidity (RH) correction (10% adjustment factor) doesn't go into effect until the RH is above 40% (**40% rule**). This is because the same curve in Figure 1-13 can be estimated by two distinct slopes, with this 40% rule appearing to give a better approximation. For example, 0-40% humidity results in no correction, and 50-100% humidity results in a 100-600 foot altitude correction for humidity (rather than an errant 500-1000 foot correction) based on the "10% rule."

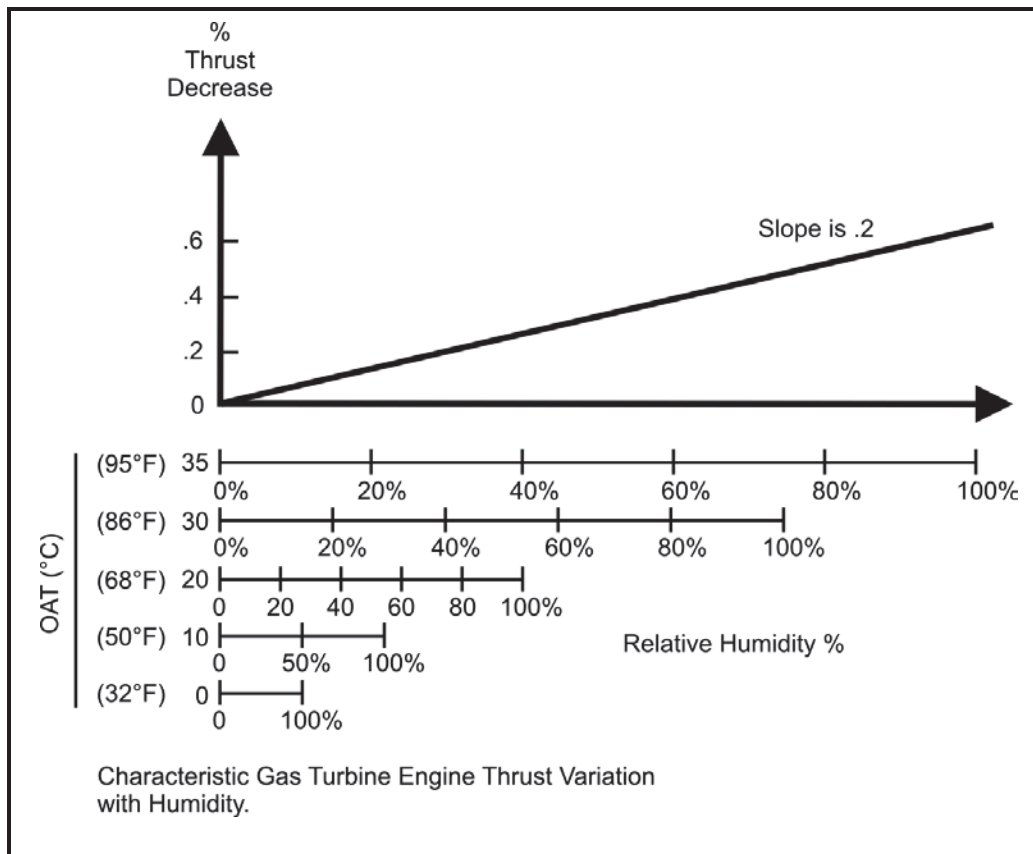

Figure 1-13 Thrust Variation with Humidity

A comparison of the three commonly used methods to compute DA indicates that a significant variation exists between the chosen methods. For example, if we assume an OAT of 30 °C (86 °F), PA of sea level and Dew Point of 30 °C (RH=100%) we obtain a DA of 1800 feet based on the DA chart using PA and an uncorrected OAT. If we incorporate the "100 foot-10% RH rule" for 100% RH the DA is increased by 1000 feet to 2800 feet or to 2400 feet if we only apply the "rule of thumb" for RH above 40% as some NATOPS manuals dictate. The actual DA obtained from the DA chart using a corrected OAT yields 2200 feet.

Applied to typical aircraft performance data (CH53D), the effect of the differences is apparent in Figure 1-14. Making no adjustment might lead to overestimation of capabilities. The difference is small, but in situations where operations may be conducted close to safe power margins, consideration of all factors is important. Ignoring DA effects could mean that safe margins are exceeded. On the other hand, being **overly** conservative could impact the ability to complete a mission satisfactorily. **The 40% rule offers the most accurate quick estimate of humidity effects, compared to the more conservative 10% rule.**

$$\text{DA (corrected for RH >40\%)} = \text{DA (chart)} + 100'(\text{RH} - 40\%)/10\%$$

And is **only** corrected for RH > 40%

Again, for calculations in the field, PA is easily obtained by setting 29.92" Hg in the Kollsman window of the barometric altimeter. Obtaining the dew point is usually a little more difficult unless you have access to a weather service. In the absence of any of this information, you can always assume a worst case scenario of 100% RH which is when the OAT and dew point are the same.

For comparison purposes, Figure 1-14 below depicts for a CH-53D the relative accuracy of the three techniques for humidity correction of DA with an RH of 100%.

<u>Adjustment</u>	<u>DA</u>	<u>Max Gross Wt (HOGE)</u>
NONE	7800 FT	34,800 lbs
10% RULE	8800 FT	34,000 lbs
DA COMPUTER	8400 FT	34,500 lbs
40% RULE	8400 FT	34,500 lbs

Figure 1-14 Sample Effects of DA Calculations on CH-53D Performance

The 10% Rule provides a more conservative estimate of DA and is the recommended method in most helicopter NATOPS manuals. **If a NATOPS manual does not discuss the effects of humidity, be conservative and apply the 10% Rule.**

THIS PAGE INTENTIONALLY LEFT BLANK

CHAPTER ONE REVIEW QUESTIONS

1. Oxygen comprises approximately _____% of the earth's atmosphere.
2. Define static pressure. What change in atmospheric static pressure (P_s) occurs with an increase in altitude (sea level to 18,000 ft.)?
3. How does a vector quantity differ from a scalar quantity?
4. Define mass.
5. Define weight.
6. How are a force and a moment related?
7. Define work. How is it calculated?
8. Define power.
9. Define energy. What is the equation for total energy?

10. Define potential energy (P.E.).

11. Define kinetic energy (K.E.).

12. Under what conditions can both a flying aircraft and an aircraft parked on the flight line both be in equilibrium?

13. What is the difference between trimmed flight and equilibrium flight?

14. When relative humidity is 50%, the moist air is half as dense as dry air. ____ (True/False)
15. Define air temperature.
16. Define air density.
17. What change in air density occurs with an increase in humidity?
18. DA is PA corrected for _____ and _____.
19. State Newton's First Law of Motion.
20. State Newton's Second Law of Motion and provide an example.
21. State Newton's Third Law of Motion and provide an example.
22. What is the standard rate of change in air temperature that occurs in the standard atmosphere from sea level through 36,000 feet?
23. Air density changes in direct proportion to _____ and in inverse proportion to _____, _____, and _____.
24. An increase in humidity increases/decreases DA, which increases/decreases rotor efficiency.

25. State the effects that increased DA has on power available and power required.
- _____
26. What are the sea level conditions in the standard atmosphere?
27. State the General Gas Law. What is the relationship between temperature, pressure, and density according to the General Gas Law?
28. The altitude corresponding to a given static air pressure in the standard atmosphere is _____.
29. As temperature increases above standard day conditions, DA increases/decreases and air density increases/decreases.
30. What is the primary factor affecting the speed of sound in air?
31. According to the General Gas Law, if a gas's density remains constant (such as in a sealed tank) and its temperature increases, then the pressure of the gas will increase/decrease.
32. The general gas law demonstrates that if the pressure of a gas remains constant, and its temperature increases, then its density increases/decreases.
33. A Standard atmosphere is defined by pressure of _____ in. Hg and temperature of ____ °C or ____ °F.
34. Using the DA Chart on page 1-22 or your NATOPS manual and the **10% Rule**, find the DA for a PA of 3500', temperature of 24 °C, and relative humidity of 80%. _____
35. Using the rule of thumb equation, calculate the DA for a PA of 6000', temperature of 17 °C, and relative humidity of 50%. _____
36. What change in air density occurs with an increase in altitude (sea level to 18,000 ft.)?
37. Compared to dry air, the density of air at 100% humidity is
- a. 4% more dense.
 - b. about the same.
 - c. decreased 1% per 1000'.
 - d. less dense.

38. Aircraft altimeters are constructed for the pressure-height relationship
- and there is a mechanical correction factor for humidity.
 - and will always give you true altitude.
 - and can determine DA by dialing in 29.92.
 - and can determine PA by dialing in 29.92.
39. On a cool, dry air day, one would expect the
- DA to be high
 - DA to be low
 - air density to be low
 - air density and the DA to be the same
40. When computing DA, 90% relative humidity adds _____ to dry air DA (10% rule).
- 50% of the PA
 - 500 ft plus 25% of the humidity
 - 90 ft
 - 900 ft
41. As DA increases, the _____ will increase because the _____ is/are less efficient.
- power available... rotor blades
 - power required ... engine
 - power available ... engine
 - power required ... rotor blades
42. Air at 50% humidity
- has the same density as air at 100% humidity.
 - is half as dense as dry air.
 - has greater density than air at 100% humidity.
 - humidity does not affect the density of the air
43. An increase in air density will
- increase DA
 - have no effect on the helicopter below its hovering ceiling
 - increase power available
 - decrease rotor efficiency

THIS PAGE INTENTIONALLY LEFT BLANK

CHAPTER ONE REVIEW ANSWERS

1. 21
2. Static pressure is the force each air particle exerts on those around it, or the weight of a column of air over a given area. Static pressure decreases with increase in altitude.
3. A scalar quantity describes only magnitude, but a vector describes both magnitude and direction.
4. Mass is the amount of molecular material that comprises an object.
5. Weight is the force with which an object is attracted toward the center of the earth by earth's gravity.
6. A moment is created when a force is applied to a body at some distance from a fulcrum.
7. Work is equal to force times displacement, or $W = Fs$.
8. Power is the rate of work per unit of time, or $P = F(s)/t = W/t$
9. Energy is a measure of a body's capacity to do work. $TE = KE + PE$
10. Potential energy is the ability of a body to do work because of its position.
11. Kinetic energy is the ability of a body to do work because of its motion.
12. Both aircraft are considered to be in equilibrium if there is an absence of acceleration on each.
13. In equilibrium flight, the sum of all accelerations is zero, while in trimmed flight, the sum of all moments is zero. An aircraft in trimmed flight may be in linear acceleration, and therefore not in equilibrium.
14. False.
15. Air temperature is the average kinetic energy of air particles.
16. Air density is the total mass of air molecules per unit of volume.
17. As humidity increases, air density decreases.
18. temperature and humidity
19. A body at rest tends to remain at rest and a body in motion tends to remain in motion at a constant velocity unless acted upon by some unbalanced force.

20. $F = ma$. If thrust is greater than drag, then an aircraft will accelerate in the direction of the thrust at a rate that is proportional to its gross weight (which is proportional to its mass).
21. For every action there is an equal and opposite reaction. The torque that spins the main rotor tends to make the fuselage spin in the opposite direction.
22. Air temperature decreases 2 °C per 1000 ft up to 36,000 ft.
23. pressure, temperature, altitude, and humidity
24. increases, decreases
25. As DA increases, power available decreases and power required increases.
26. Temp = 15 °C, 59 °F, and pressure 29.92 in Hg
27. $P = \rho R t$ Pressure varies directly with density and temperature.
28. PA
29. increases, decreases
30. air temperature
31. increase
32. decreases
33. 29.92, 15 °C, 59 °F
34. 6200'
35. 8180'
36. decreases
37. d
38. d
39. b
40. d
41. d

42. c

43. c

CHAPTER TWO HELICOPTER AERODYNAMICS BASICS

200. INTRODUCTION

The purpose of this chapter is to aid the student in understanding the basic theories of helicopter aerodynamics. This lesson topic will introduce the standard aircraft and blade element diagram as well as many new terms and concepts.

201. LESSON TOPIC LEARNING OBJECTIVES

1. **Terminal Objective:** Partially supported by this lesson topic:

Upon completion of this unit of instruction the student will be able to identify all aerodynamic forces acting on a rotor system and their effects on the system.

2. **Enabling Objectives:** Completely supported by this lesson topic:

- a. Describe how the Momentum Theory can be used to model helicopter aerodynamics.
- b. Describe how the Blade Element Theory can be used to model helicopter aerodynamics.
- c. Recall the definition of the following terms: Airfoil, chord line, tip path plane, Aerodynamic Center (AC), rotor disk, blade pitch/angle of incidence, linear velocity, induced velocity, angle of attack (AOA), lift, induced drag, profile drag, thrust, in-plane drag, relative wind, rotational velocity, and translational velocity.
- d. Draw a blade element diagram and label the components listed above.
- e. State the relationships between relative wind and AOA.
- f. State the relationships between angle of incidence and AOA.
- g. State the relationships between induced velocity, linear velocity, and relative wind.
- h. State the relationship between rotational velocity, translational velocity, and linear velocity.
- i. Recall the differences between symmetrical and non-symmetrical airfoils.
- j. Given basic aerodynamic equations (lift, drag, etc), identify the variables in each and state the relationships between the variables.
- k. Describe the forces produced by the main rotor system and tail rotor, and their effects on the helicopter.

202. REFERENCES

1. Fundamentals of Aerodynamics, NAVAVSCOLSCOM-SG-111
2. Rotary Wing Aerodynamics for Naval Aviators
3. Fundamentals of Flight
4. Helicopter Aerodynamics

203. STUDY ASSIGNMENT

1. Review Chapter Two.
2. Answer the Review Questions.

204. AIRCRAFT REFERENCE SYSTEM

An aircraft's (helicopter or fixed-wing) reference system consists of three mutually perpendicular lines (axes) intersecting at a single point (Figure 2-1). This point, called the center of gravity (**CG**), is the point at which all weight is considered to be concentrated and at which all forces are measured. Theoretically, the aircraft will balance if suspended at the CG. When in flight, the aircraft will rotate about the CG, so all moments will be resolved around it as well. The CG will move as fuel burns, bombs/missiles are expended, or cargo shifts.

The **longitudinal axis** passes from the nose to the tail of the aircraft. Movement of the lateral axis around the longitudinal axis is called **roll**, or **lateral control**.

The **lateral axis** passes from wingtip to wingtip. Movement of the longitudinal axis around the lateral axis is called **pitch**, or **longitudinal control**.

The **vertical axis** passes vertically through the CG. Movement of the longitudinal axis around the vertical axis is called **yaw**, or **directional control**. As an aircraft moves through the air, the axis system moves with it. Therefore, the movement of the aircraft can be described by the movement of its CG.

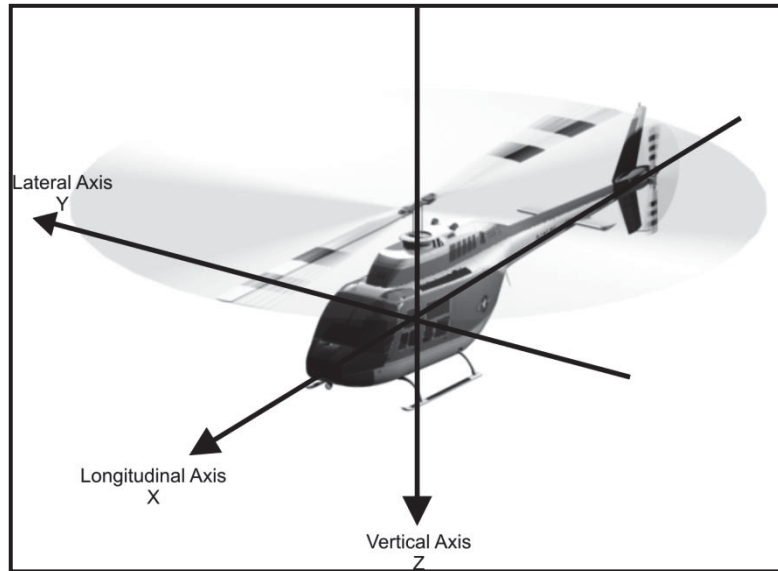

Figure 2-1 Aircraft Reference System

205. INTRODUCTION TO THE STANDARD HELICOPTER

For the purpose of examining the aerodynamic principles of rotary wing flight, it is practical to use a standard helicopter, to minimize the number of design variables which could otherwise make an introductory course somewhat cumbersome. Although many design considerations will be discussed in detail in Chapter Four, the bulk of the material to be mastered in this text is primarily applicable to the single main rotor design with a tail rotor. The standard aircraft discussed will be the TH-57, the U.S. Navy version of the Bell 206.

The NATOPS describes the TH-57B as a single-engine, land-based utility-type helicopter. The airframe consists of the cabin section, cowling section, landing gear section, tailboom section, and vertical fin. The airframe forward section is primarily an aluminum honeycomb, semi-monocoque structure. The main rotor is a two-bladed, semi-rigid, underslung, flapping type, employing two and one-fourth degrees preconing. Each main rotor blade is attached to a common hub by means of a grip, a pitch change bearing, and a tension-torsion strap assembly to carry blade centrifugal force.

The tail rotor is a two-bladed, semi-rigid, flapping type.

Some basic assumptions for this text: If not otherwise specified, single main rotor, tail rotor, hovering flight with level rotor disk (in-plane is horizontal, axial is vertical), no blade twist.

206. GENERAL PROPERTIES OF AIRFLOW

The atmosphere is a uniform mixture of gases with the properties of a fluid, or a material that flows. The laws of fluid motion can therefore be used to describe its motion and behavior.

Airflow, as any fluid flow, is easily affected by changes in four point properties: static pressure, density, temperature, and velocity. Any or all of these properties can vary widely from one point in an airflow to the next. The four point properties can therefore be used to describe the state of an airflow at any specific spot.

Steady airflow exists if the point properties at every point in the flow remain constant over time. The speed and/or direction of the individual air particles may vary from one point to another in the flow, but every particle that passes point 1 will have the same velocity as the particle before it. In steady airflow, each particle of air follows the same path as the preceding particle; that path is called a **streamline**. In a steady airflow, particles do not cross streamlines.

Airflow can be studied by studying the collection of streamlines within it. A collection of many streamlines is called a **streamtube**, which describes a contained flow just as effectively as a tube with solid walls. The streamtube—because it describes a steady airflow—is a closed system in which total mass and total energy remain constant. **All the mass that enters a streamtube will exit it** (Figure 2-2).

207. THE CONTINUITY EQUATION

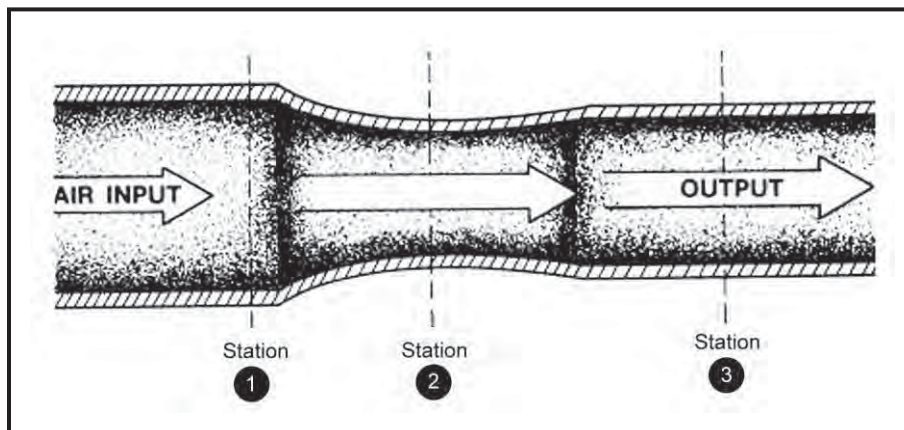

Figure 2-2 Airflow Through a Streamtube

Let us intersect the streamtube depicted in Figure 2-2 with three planes, perpendicular to the airflow at stations 1, 2 and 3, with cross-sectional areas of A_1 , A_2 , and A_3 , respectively. The amount of mass passing any point in the streamtube may be found by multiplying area by velocity to give volume per unit time and then multiplying by density to give mass per unit time. This is called mass flow (or “m dot” for engineering types) and is expressed:

$$dm/dt = \rho AV = \dot{m}$$

Because it is a closed system, the amount of mass flowing through A_1 must equal that flowing through A_2 and A_3 since, by definition, mass does not flow through the walls of a streamtube. Thus, an equation expressing the continuity of flow through a streamtube is:

$$\rho_1 A_1 V_1 = \rho_2 A_2 V_2 = \rho_3 A_3 V_3$$

2-4 HELICOPTER AERODYNAMICS BASICS

Our discussion is limited to subsonic airflow, therefore we can regard changes in density due to **compressibility** as insignificant. If we assume that both ends of the streamtube are at the same altitude, then ρ_1 is equal to ρ_2 is equal to ρ_3 and we can cancel them from our equation. A **simplified continuity equation** below is the one that we will use.

$$A_1V_1 = A_2V_2 = A_3V_3$$

If the areas A_1 , A_2 and A_3 are the same, then the velocity of the air leaving the streamtube will be the same as the velocity entering the streamtube. If the area A_2 decreases, the velocity must increase to keep the mass flow at that location equal to the mass flow at A_1 (Figure 2-3). Venturi effect is the term used to describe this phenomenon. Thus, **velocity and area in a streamtube are inversely related**.

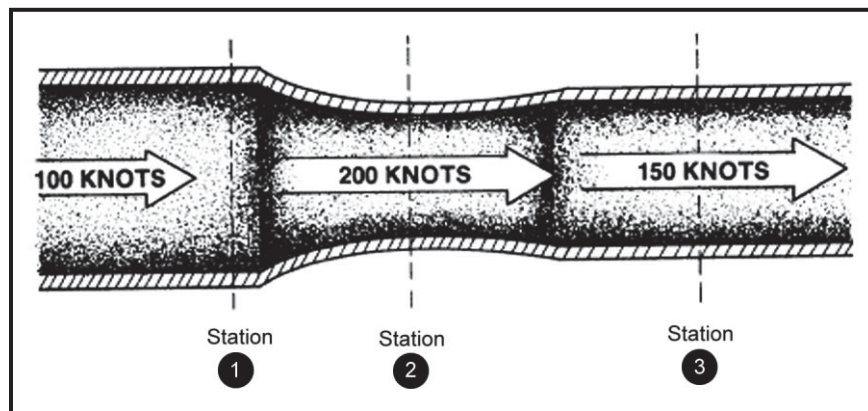

Figure 2-3 Venturi Effect

It is this principle that explains the effect of a water nozzle, for example. By restricting the cross-sectional area of the opening of a water hose, it is possible to speed up the flow of water until it becomes capable of traveling some distance, perhaps to wet down a deserving friend, relative, or a pilot after his last military flight.

All that remains is to discuss what defines the cross-sectional area in a streamtube. As discussed, the streamtube is a collection of streamlines or the paths of molecules in a steady flow. A reduction in cross-sectional area is the result of some external influence causing a change in direction of the streamlines such that they move closer together. The most likely candidate is some object in the airflow that diverts the streamlines. In the case of the water hose, the hose itself defined the size and shape of the streamtube and the narrowing was caused either by a nozzle attachment or a well-placed thumb.

208. BERNOULLI'S EQUATION

Just as the continuity equation illustrates conservation of mass flow, Bernoulli's equation describes the relationship between internal fluid pressure and fluid velocity. It is a statement of the law of conservation of energy. It helps explain why an airfoil develops an aerodynamic force. Aerodynamics is concerned with the forces acting on an object due to airflow. These

forces are the result of pressure and friction. The relationship between pressure and velocity in an airflow is fundamental to understanding how we create aerodynamic forces with a wing. Bernoulli's equation describes this relationship for a steady airflow. Pressure of flowing air may be compared to energy in that the total pressure of flowing air will always remain constant unless energy is added or removed.

Recall that in a closed system, total energy is the sum of potential energy and kinetic energy, and must remain constant:

$$T.E. = K.E. + P.E.$$

In an airflow, potential energy and kinetic energy act through pressures. Fluid flow pressure has two components: static and dynamic pressure. The static pressure is the pressure component that would be measured in the flow but not moving with the flow as the pressure is measured. Static pressure is also known as the force per unit area acting on a surface. The potential energy component is static pressure and the kinetic energy component is dynamic pressure. Bernoulli developed a concept that static pressure and dynamic pressure in a steady flow add up to a constant total pressure in the same way that potential energy and kinetic energy add up to a constant total energy in any closed system.

Compressed air has potential energy because it can do work by exerting a force on a surface. Therefore, **static pressure (P_S)** is a measure of potential energy per unit volume.

Moving air has kinetic energy since it can do work by exerting a force on a surface due to its momentum. Dividing K.E. by volume and substituting ρ for mass/volume, gives us dynamic pressure. **Dynamic pressure (q)** is the pressure of a fluid resulting from its motion, and is equal to $\frac{1}{2} \rho V^2$.

The principle is mathematically expressed as **Bernoulli's Equation**:

$$P_T = P_S + q = \text{Constant, where}$$

$$(T.E = K.E. + P.E)$$

$$P_T = \text{Total Pressure}$$

$$P_S = \text{Static Pressure}$$

$$q = \frac{1}{2} \rho V^2 = \text{Dynamic Pressure}$$

$$\text{Therefore } P_T = P_S + \frac{1}{2} \rho V^2$$

209. A STREAMTUBE AS A MODEL FOR AN AIRFOIL

Figure 2-4 depicts the bottom half of the constricted area of the tube, which resembles the top half of an airfoil. Even with the top half of the tube removed, the air still accelerates over the curved area because the upper air layers restrict the flow, just as the top half of the constricted tube did. As area in a streamtube decreases, velocity increases, therefore q must increase (recall that q contains V^2). From Bernoulli's equation we know that since q increases, P_S must decrease.

This acceleration causes decreased static pressure above the curved portion and creates a pressure differential caused by the variation of static and dynamic pressures.

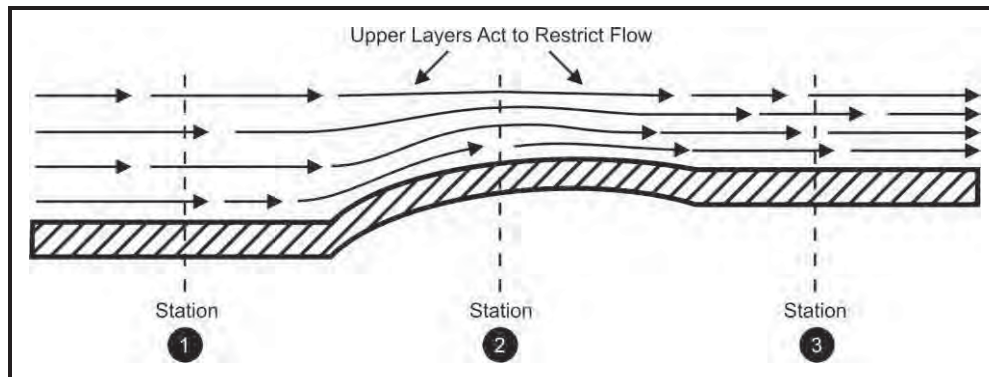

Figure 2-4 Venturi Flow

Now, consider the streamtube with an airfoil (**rotor blade**) placed in it. The airflow around the upper and lower surfaces of a rotor blade is similar to the airflow through a constriction. The shape of the airfoil will determine the distribution of pressure changes found within the streamtube. Airflow striking an airfoil will have its velocity slow to near zero, creating an area of high static pressure called the **leading edge stagnation point**.

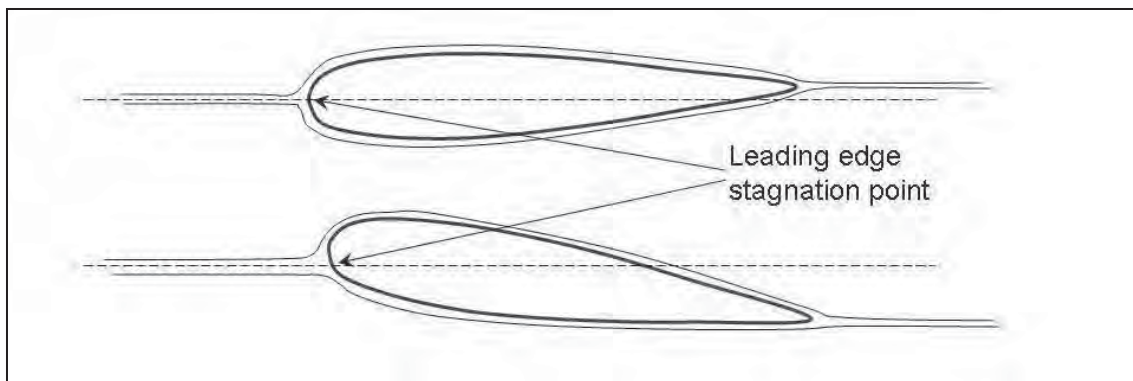

Figure 2-5 Stagnation Point

The airflow then separates so that some air moves over the airfoil and some under it, creating two streamtubes. Airflow leaving the leading edge stagnation point will be accelerated due to the decrease in the cross-sectional area of each streamtube. The airflow on both surfaces will reach a maximum velocity at the point of maximum thickness. This concept will be expanded upon after some airfoil terms have been discussed.

210. THE BOUNDARY LAYER

The **boundary layer** is that layer of airflow over a surface that demonstrates local airflow retardation due to viscosity. It is usually no more than 1 mm thick (the thickness of a playing card) at the leading edge of an airfoil, and grows in thickness as it moves aft over the surface.

The boundary layer has two types of airflow:

In **laminar flow**, the air molecules move smoothly along in streamlines. The laminar layer produces very little friction, but is easily separated from the surface.

In **turbulent flow**, the streamlines break up and the flow is disorganized and irregular. The turbulent layer produces higher friction drag, but adheres to the upper surface of the airfoil delaying (but not preventing) boundary layer separation.

Any object that moves through the air will develop a boundary layer that varies in thickness according to the shape and material properties of its surface. The type of flow in the boundary layer depends on its location over the surface. The boundary layer will be laminar only near the leading edge of the airfoil. As the air flows aft, the laminar layer begins oscillating and becomes turbulent. The turbulent layer will continue to increase in thickness as it flows aft and eventually separate from the wing.

Because the outermost layer of molecules in the boundary layer is moving at the free stream velocity and maintains its steady flow properties while the layers below it begin to become turbulent, it is that layer which can be said to define the wall of the streamtube. When the boundary layer separates and no longer follows the shape of the wing, it changes the pressure distribution through the streamtube and affects the aerodynamic force.

211. AN INTRODUCTION TO LIFT THEORIES

Several theories have been developed during the last two hundred years to attempt to explain the production of lift by an airfoil. Before we introduce the leading theories, consider the following story:

One day, four blind men were taken to the zoo, led to stand near a large bull elephant and instructed to state what they observed. The blind man near the head reached out and felt the elephant's trunk; he stated that the object was a large python snake. The blind man near the shoulder reached out and felt the elephant's front leg; he stated that it was a large tree. The next blind man reached out and felt the side of the elephant, observing that it was a great wall. The last blind man reached out and felt the elephant's tail; he stated that he felt long, coarse hair that smelled of sauerkraut and mothballs, and therefore concluded it was his mother-in-law.

The point of the story, the latter observation notwithstanding, is that there are different ways to describe the same animal. This is the same problem we have in trying to quantify lift. One argument says that the pressure differential from the top to bottom of the airfoil describes lift. Another argument says that the wing deflects the air downward, thus pushing itself up. Yet another says that there is a net circulation of air around the wing, which causes it to lift. Each of these ideas is completely legitimate and can be supported by mathematical proof. But each also has a set of specific constraints and approximations, which will limit its applicability. There will be situations where one method is more convenient to use than another, and other situations that will demand one specific method of investigation. This chapter will investigate four methods describing lift: Pressure Distribution, Circulation Theory, the Momentum Theory, and the Blade Element Theory.

212. PRESSURE DISTRIBUTION THEORY

The **pressure distribution theory** evolves from two concepts that have been described earlier in the text: the principle of continuity, and the principle of conservation of energy as applied to fluid dynamics (Bernoulli's Equation). To recap, in considering continuity, as the area (of a streamtube, for example) decreases, the velocity increases. Furthermore, from Bernoulli, as the velocity of the air goes up, the static pressure goes down.

Therefore, putting the Bernoulli equation together with the continuity principle, we have the following: as the area decreases, the velocity increases, and as the velocity increases the static pressure decreases. Well, if the pressure goes down over the top of a wing more so than over the bottom, then it stands to reason that the wing will be lifted up as seen in Figure 2-6. This differential pressure, accounted for by the continuity principle and the Bernoulli equation, is the method of choice in describing the mechanics of lift by the pressure distribution theory.

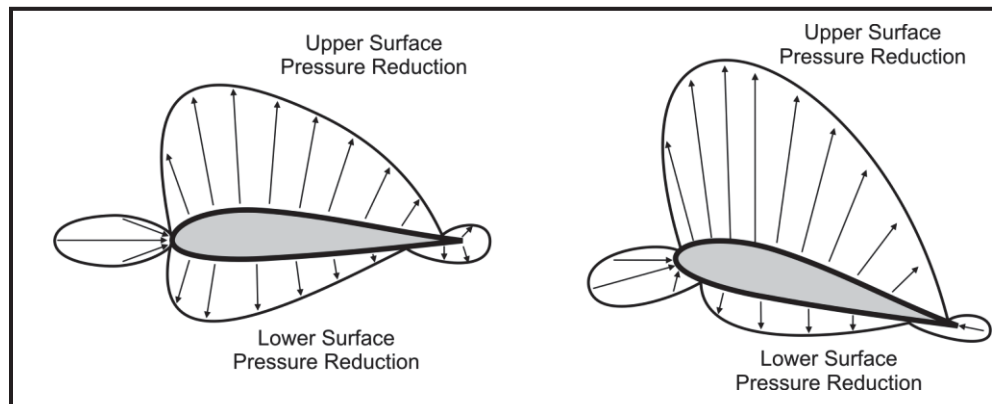

Figure 2-6 Pressure Changes Around a Cambered Airfoil

213. CIRCULATION THEORY

Circulation theory, or the Kutta-Joukowski Theorem, is a method for describing the flow over a spinning cylinder and, more generally, over any closed area (Figure 2-7). It is named after German mathematician Wilhelm Kutta (1867-1944) and Russian physicist Nikolai Joukowski (1847-1921) who independently discovered it at the beginning of the 20th century. It can be described as follows.

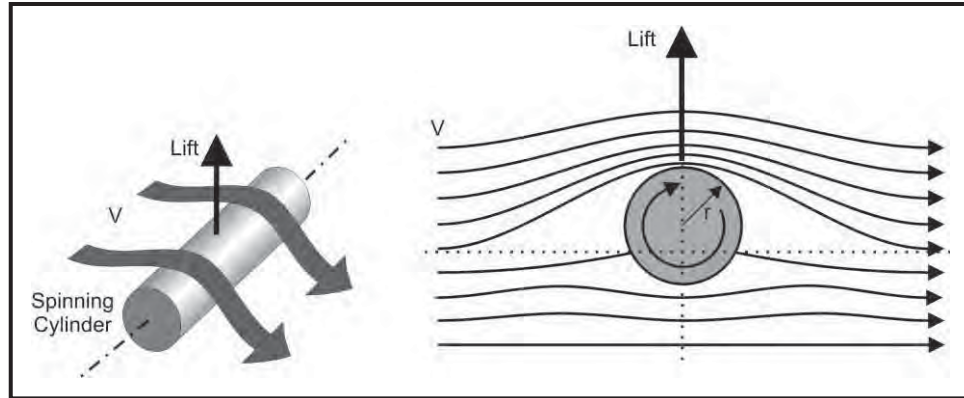

Figure 2-7 Magnus Effect

First, if a non-rotating circular cylinder is placed in a flow field it will produce no lift. The streamlines and resultant pressure distributions around a cylinder without circulation (Figure 2-8) generate no net lift force. When the cylinder is rotated, however, it induces a rotational or circulatory flow and there is a distinct change in the streamlines and pressure distributions. Air next to the surface of the cylinder is sped up on the top and slowed down on the bottom by the relative motion of the cylinder's surface. The differences in flow speeds cause pressure differences on top and bottom (Figure 2-8), with the end result being a net lift force perpendicular to the relative velocity.

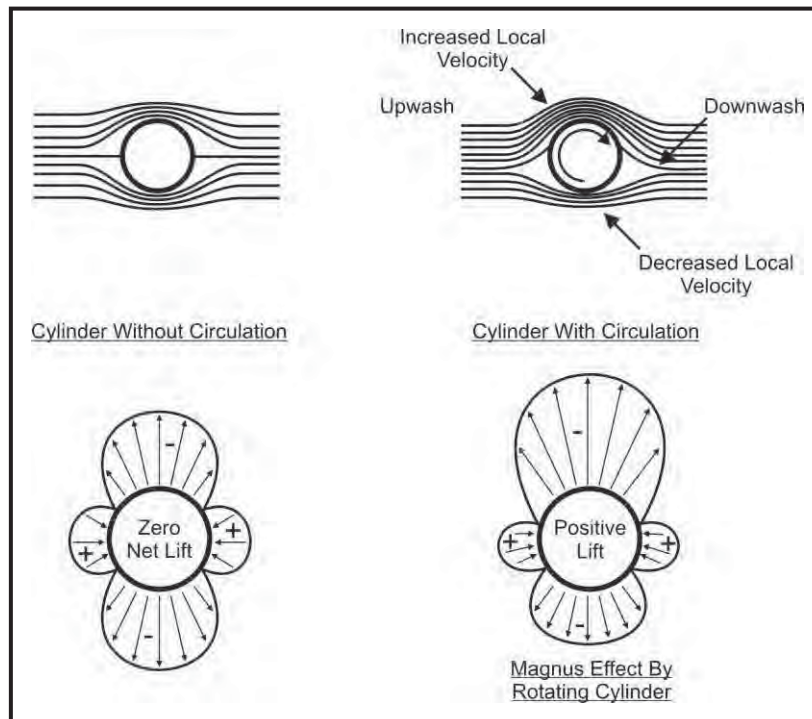

Figure 2-8 Pressure Distribution for Magnus Effect

The Kutta-Joukowski equation is:

$$L' = \rho_{\infty} V_{\infty} \Gamma$$

and is read as follows: “The lift per unit span is equal to the free stream density times the free stream velocity times the circulation, gamma.” John D. Anderson in his book FUNDAMENTALS OF AERODYNAMICS states, “The Kutta-Joukowski theorem is simply an alternative way of expressing the **consequences** of the surface pressure distribution; it is a mathematical expression that is consistent with the special tools we have developed for the analysis of inviscid, incompressible flow. Therefore, it is not quite proper to say that circulation causes lift. Rather, lift is caused by the net imbalance of the surface pressure distribution, and circulation is simply a defined quantity determined from the same pressures.”

Although the flow around an airfoil also supports this circulation theory, the pressure distribution explanation that we have chosen is more convenient for our use because it is understandable and readily measurable. There have been recent developments in rotary wing flight where circulation theory has been shown to have nearly direct application. Use of a rotating body to generate pressure differences on top and bottom surfaces, or viewed alternatively, impart circulation to a flow, is termed Magnus effect.

Helicopter tail rotors can now be augmented or replaced by the prudent use of airflow control. A NOTAR (NO Tail Rotor) helicopter diverts air down the right side of the helicopter’s tailboom to direct and accelerate passing air from the main rotor’s downwash. The faster air on the right side produces lower static pressure there than on the left side, and a side force is generated (Coanda effect). That force reduces the amount of anti-torque that is required from the tail rotor, allowing for a sideward facing jet to be used for control instead of a tail rotor.

Another method using a different technique was originally tested by NASA on Bell 204B and New Zealand UH-1H aircraft. This latter technique, instead of accelerating the flow on the right side of the tailboom, disrupts the flow on the left hand side with a stall strip to produce the same effect. It has been used on H-1's in the fleet and is an excellent example of circulation theory in practice.

Main rotor and tail rotor systems create unique challenges in the application of a valid lifting theory. Airflow through and about a rotating system of airfoils is obviously more complex than that associated with a simple fixed wing. The many phases of flight discussed in the remainder of this text include: hovering in and out of ground effect; forward flight; climbing and descending flight; powered and unpowered flight; and an assortment of flight phenomena ranging from retreating blade stall to mast bumping to dynamic rollover. Although no theory is perfect, the theories discussed in the next two sections of this text are widely recognized for their ability to model rotary wing airflow and performance in many phases of flight. These two theories are the momentum theory and the blade element theory.

214. MOMENTUM THEORY

The Momentum Theory of lift relies on Newton’s laws of motion with regard to the air as it passes over an airfoil, and the reaction of the airfoil to the motion of the air. Newton’s third law

of motion says that for every action there is an equal and opposite reaction. In hover, this theory states that a certain amount of air above the rotor system is accelerated to a certain velocity at a certain distance below the rotor. Since the amount of air has a finite mass and is given a finite acceleration, its force can be determined through Newton's second law ($F=ma$).

Specifically, the theory shows that given an initial velocity (v_0) of zero well above the rotor system, the rotor system accelerates the air downward through the rotors to a particular velocity (v_i , induced velocity) based on the diameter of the rotor, the density of the air and the weight of the helicopter. The mass of air has been shown to be further accelerated by the idealized constraints of the flow to twice the induced velocity at about the distance of one rotor diameter (Figure 2-9).

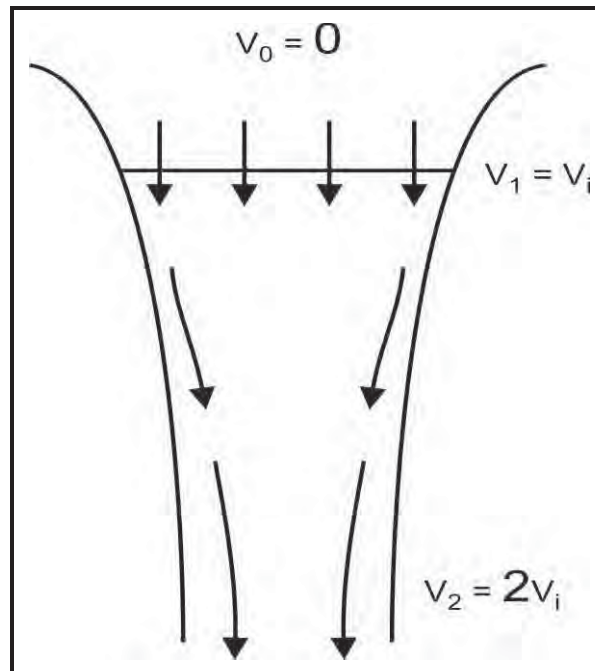

Figure 2-9 Induced Velocity Idealized for Momentum Theory

Recall from the review of basic physics in Chapter One that power can be expressed in terms of force and velocity, or alternately as torque and rotor rpm (Ω):

$$P = F * V$$

$$P = Q * \Omega$$

These relationships make momentum theory useful in analyzing an important portion of the power required to hover, called induced power. Induced power is that portion of total power used to accelerate air downward and create lift. So, in equilibrium, the thrust or force generated by the rotor must equal aircraft weight, so the induced power required to hover is then a function of aircraft weight (T , for thrust) and induced velocity (V_i):

$$P_i = T * V_i$$

It also describes other essential relationships, such as the relationship between torque and induced velocity:

$$P = \text{Thrust} * V_i, \text{ and } P = Q * \Omega, \text{ so}$$

$$\text{Thrust} * V_i = Q * \Omega, \text{ and}$$

$$\text{Thrust} = \frac{Q * \Omega}{V_i}$$

Therefore, if the helicopter weighs more, it requires more torque, higher rotor speed, less induced velocity, or some combination of all three.

Momentum Theory also helps us derive a useful relationship between induced velocity and rotor disk size, or area (A) in the following equation:

$$V_i = \sqrt{\frac{T}{2\rho A}}$$

T/A or thrust divided by the disk area is called “disk loading” which is similar to airplane wing loading. So, as weight goes up, induced velocity or "downwash" increases. But, as the disk gets bigger, downwash decreases. Finally, as density decreases when you climb, downwash increases, because density (ρ) is in the denominator of the equation. The relevance of this will become more apparent in Chapter 9 when we start discussing induced velocity (v_i) and induced power necessary to hover.

215. BLADE ELEMENT THEORY

Whereas the Momentum Theory can describe the overall forces on the entire rotor disk, the Blade Element Theory allows for a greater fidelity in understanding the action and reaction of individual blades within a rotor disk. The basis of Blade Element Theory is to take a very small portion of the rotor blade and determine the forces acting on it. The portion we pick will have a width of Δr and a length c (corresponding to the chord length of the blade). By multiplying these two distances together we now have an area over which the forces can be calculated using the lift equation. Figure 2-10 shows the initial set up as a rotor blade with radius R rotating at a constant angular velocity, Ω .

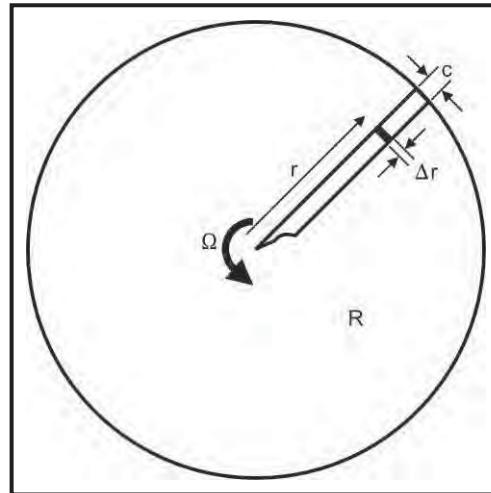

Figure 2-10 Variables in the Blade Element Theory

We have chosen our blade element at a distance, r , from the hub, therefore its velocity is determined by Δr . Recall that we are describing the lift only on this particular blade element, therefore we must use a variation of the lift equation for the proper results.

$$\Delta L = \frac{1}{2} \rho \Omega^2 r^2 (c \Delta r) c_L$$

(note similarity to $\frac{1}{2} \rho V^2 S C_L$)

As usual ρ is density and c_L is the incremental lift coefficient (discussed in section 221). The lift equation above is read as follows: “Incremental lift is equal to one half ρ times the quantity Ωr squared times the chord length times the change in r times the incremental lift coefficient”. Now we have the lift on that small blade element. Repeating this process many times will give us the lift on one of the blades; multiplying by the number of blades will yield the overall rotor lift force. However, it isn't that simple in a dynamic environment since other variables start to change. For example, as the rotor system transitions into forward flight, the velocities change with respect to the position of the rotor blade as it rotates (producing an advancing and a retreating side) and the angles of attack change to allow for dissymmetry of lift (discussed in Chapter 10). The math can get a little confusing. Good thing for computers, which can quite handily juggle these changes and produce a relatively good approximation. Now let's examine this incremental lift, ΔL , on this small blade element.

Airflow conditions at the blade element are diagrammed in Figure 2-11. The blade “sees” a combination of **linear velocity** (sometimes called linear flow) and downward **induced velocity** as components of **relative wind**.

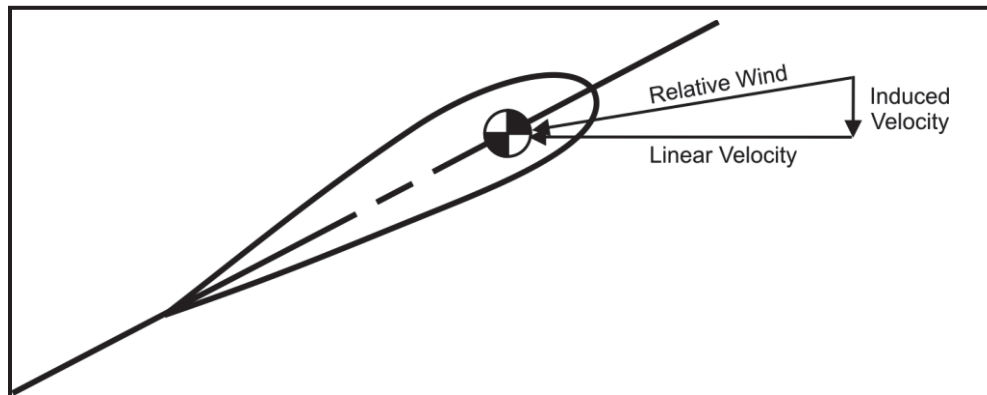

Figure 2-11 Airflow Over the Airfoil

The **angle of attack (AOA)** is the aerodynamic angle formed between the relative wind and the **chord line** (Figure 2-12). The **pitch angle** is the mechanical angle formed between the tip path plane (TPP) and the chord line. **Lift**, which is the component of the total aerodynamic force perpendicular to the relative wind, is tilted aft. This rearward component generated by lift is **induced drag**, formed from the acceleration of a mass of air (downwash) and the energy spent in the creation of trailing vortices. The remaining arrow labeled profile drag is the result of air friction acting on the blade element and comprised of viscous drag (skin friction) and form drag, which is the drag produced from the low velocity/low static pressure air formed in the wake of each blade.

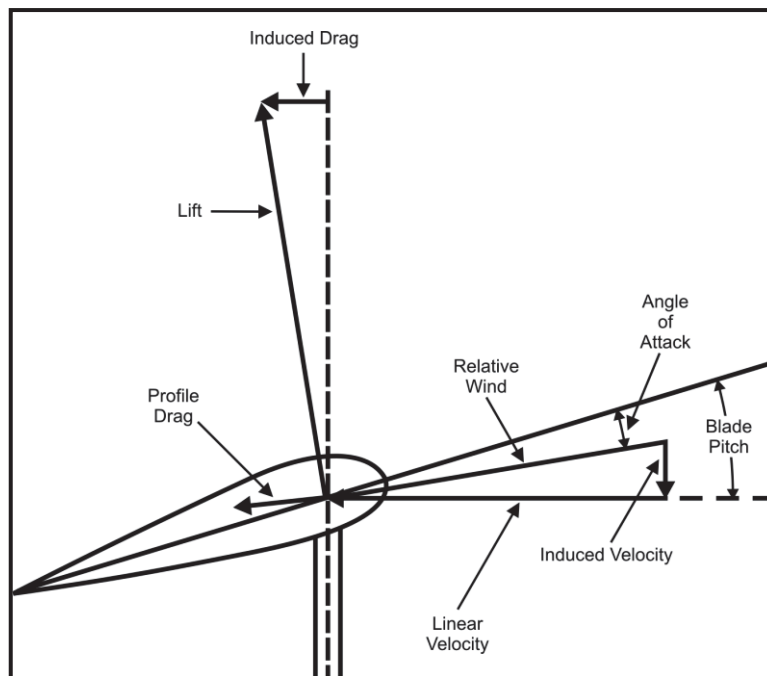

Figure 2-12 Blade Element Diagram

216. AIRFOIL CHARACTERISTICS AND NOMENCLATURE

An airfoil is a structure designed to react usefully due to its motion through the air. It usually has a cross section carefully contoured to suit its intended application or function. Airfoils are applied to aircraft, missiles, or other aerial vehicles or projectiles to develop lift (wing or rotor blade). They are also used for stability (fin), control (elevator), and thrust or propulsion (propeller or rotor blade). Certain airfoils, such as rotor blades, combine some of these functions. The terminology associated with airfoils must be understood before the aerodynamic forces can be discussed. Figure 2-13 illustrates a typical airfoil section, with important characteristics labeled. Terminology for those characteristics is as follows:

1. **Chord line** – A straight line connecting the leading and trailing edges of the airfoil.
2. **Chord** – The length of the chord line from leading edge to trailing edge.
3. **Mean-camber line** – A line drawn halfway between the upper and lower surfaces of the airfoil. It begins and terminates at the ends of the chord line.
4. **Maximum camber** – The displacement of the mean line from the chord line.
5. **Leading edge radius** – Radius of a circle that would have the same curvature as the leading edge of the airfoil.
6. **Center of pressure** – The point along the chord line of an airfoil through which all aerodynamic forces are considered to act. The average location of the pressure variation is called the center of pressure, in the same way that the average location of the weight of an object is called the **center of gravity**. On a symmetrical airfoil, the center of pressure remains stationary while on a cambered airfoil the center of pressure moves forward with increasing AOA.
7. **Aerodynamic Center (AC)** – The point along the chord line where changes in angle of attack do not change the moment on the airfoil. The aerodynamic center on subsonic airfoils is typically at the $\frac{1}{4}$ chord position.

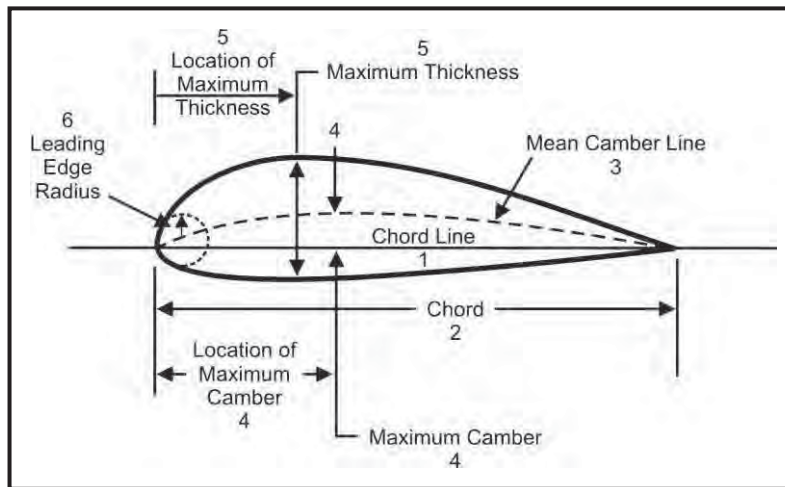

Figure 2-13 Airfoil Nomenclature

8. **Symmetry** - The two basic types of airfoils are symmetrical and nonsymmetrical. If the mean camber line is above the chord line, the airfoil has **positive camber**. If it is below the chord line, the airfoil has **negative camber**. If the mean camber line is coincident with the chord line, the airfoil is a symmetrical airfoil.

The **symmetrical airfoil** (Figure 2-14), is distinguished by having identical upper and lower surface designs, the mean camber line and chord line being coincident and producing zero lift at zero AOA. A symmetrical design has advantages and disadvantages. One advantage is that the center-of-pressure (discussed in section 219) travel remains relatively constant under varying angles of attack. Since the center-of-pressure does not move as AOA varies, the airfoil does not generate a moment about the **aerodynamic center** (AC) with increased AOA. The absence of moments about the AC minimizes the twisting force exerted on the airfoil. The minimal twisting moments make the airfoil easier to construct and less costly than a similar, cambered airfoil. It should be no surprise, then, that early helicopter rotor designs used symmetric airfoils.

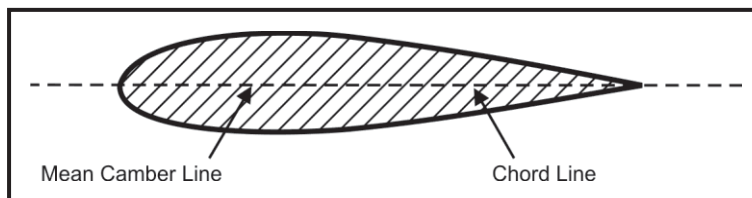

Figure 2-14 Symmetrical Airfoil

The disadvantages are that the symmetrical design produces less lift at a given AOA than a nonsymmetrical design does and also exhibits undesirable stall characteristics.

The nonsymmetrical airfoil (cambered) has different upper and lower surface designs (Figure 2-15). With nonsymmetrical airfoils, there is greater curvature of the airfoil above the chord line than below. In the nonsymmetrical airfoil, the mean camber line and chord line are

not coincident. The nonsymmetrical airfoil design produces useful lift even at zero angle of attack. A nonsymmetrical design has advantages and disadvantages. The advantages are that the design produces more lift at a given AOA than a symmetrical design, produces an improved lift to drag ratio, and has better stall characteristics. The disadvantage is that the center-of-pressure travel can move up to 20% of the chord line (creating undesirable torque on the airfoil structure) and the production costs of such a design are greater. Modern materials and manufacturing processes have made use of nonsymmetric airfoils practical in rotor blades, so their use is quite common on newer models.

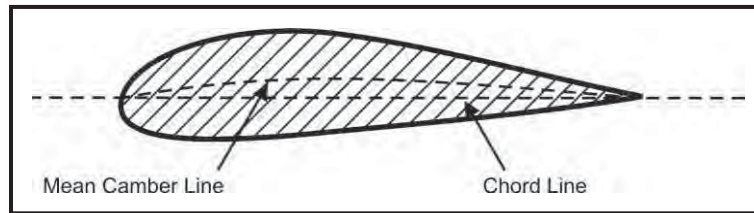

Figure 2-15 Nonsymmetrical Airfoil

The shapes of all standard National Advisory Committee for Aeronautics (NACA) airfoils are generated by specifying the shape of the mean camber line and then wrapping a specified symmetrical thickness distribution around the mean camber line. The NACA identified different airfoil shapes with logical numbering systems, the first “family” of NACA airfoils was the “four-digit” series, such as the NACA 2412 airfoil. Here, the first digit is the maximum camber in hundredths of chord, the second digit is the location of maximum camber in tenths of chord, and the last two digits give the maximum thickness of the airfoil in hundredths of chord. So the NACA 2412 would have its maximum camber of 2% chord located at 40% chord, from the leading edge, and the airfoil would have a maximum thickness of 12% chord. Other families of airfoils include the five and six digit series. The shape of the mean-camber line is very important in determining the aerodynamic characteristics of an airfoil. The maximum camber and its location are two parameters that help to define the mean-camber line. These quantities are expressed as fractions or percentages of the chord.

217. AIRFOIL TYPES

Airfoils have been refined over time by helicopter designers to take advantage of camber and new materials (Figure 2-16). There is still a place for the simpler symmetric airfoil on tail rotors and vertical tails. In such applications a symmetric airfoil supplies a simple, predictable lifting surface that does not require a special support structure.

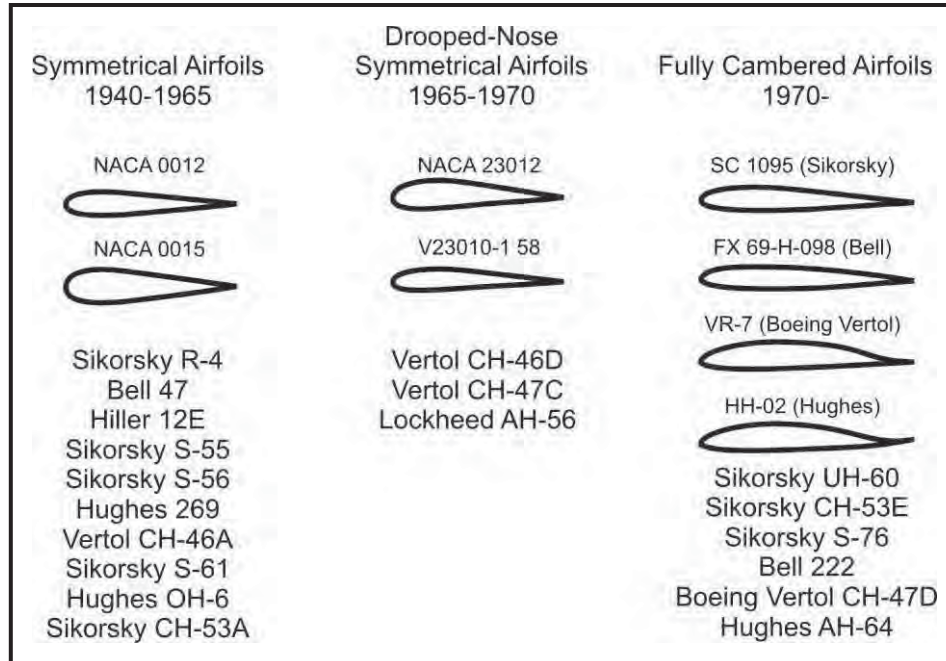

Figure 2-16 NACA Airfoil Notation

218. AIRFLOW TERMS

The uninitiated student routinely finds himself inundated with unfamiliar concepts and terms at the onset of a new course of study, and helicopter aerodynamics is no exception to this dilemma. Although many terms are interchangeable, and their understanding should be mastered, there are many important differences in terms that may initially seem subtle. Wind, flow, and velocity are interrelated and sometimes used loosely in the description of aerodynamic concepts. Remember that velocity is a vector with both magnitude and direction. Therefore, three of the preferred terms to be used during this course are rotational velocity (V-rot), translational velocity (V-trans) and linear velocity. Because the term relative wind is a long established aerodynamic term, this term will also be understood to represent a velocity vector, as will be explained below. Also note that many books reference everything to the horizontal plane, but since the rotor disk tilts, the reference plane would more correctly be the rotor tip path plane (TPP) which is not always horizontal. However, for ease of explanation, most texts draw blade pictures with the assumption that the TPP direction of travel is level or “horizontal” to the horizon.

Relative Wind. Grasping the concept of relative wind (Figure 2-17) is essential for an understanding of aerodynamics and its practical application in flight for the aviator. Relative wind is the total airflow with respect to an airfoil, normally due to its movement through the air. All movement of air across an airfoil, to include a crosswind or updraft, contributes to relative wind. As depicted in each example in Figure 2-17, whether the air flows horizontally into the airfoil or has a downwash or upwash component, the relative wind can be defined as a single vector. In the case of a helicopter, a number of factors contribute to this relative wind. At a hover, these include the rotational component (V-rot) from the turning rotor and a vertical component (V-ind) due to a relative downwash or upwash. During a crosswind or with

translational movement of the aircraft, a translational component (V -trans) of relative wind will also be considered. Terms sometimes used to quantify the relative wind vector include relative and/or resultant velocity.

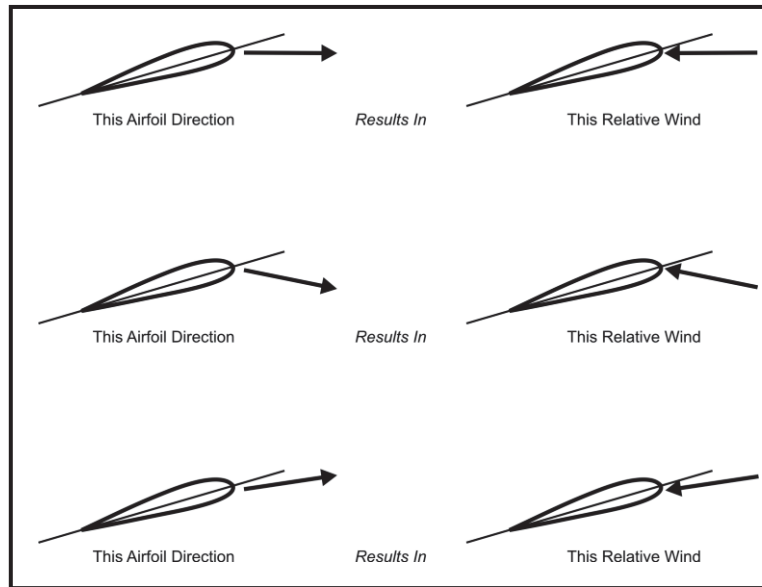

Figure 2-17 Relative Wind

Linear velocity. When discussing the blade element diagram, the horizontal component (parallel to the tip path plane) of the relative wind is called the linear velocity (horizontal velocity, or flow in some texts). The linear velocity is the sum of two components, rotational velocity and translational velocity, depending on flight conditions, as described in the following sections.

Rotational Velocity (V -rot). The rotational component of linear velocity (Figure 2-18) is produced by the rotation of the rotor blades as they turn about the mast. The term rotational refers simply to the method of producing the relative wind. Air flows over the airfoil opposite the physical flight path of the airfoil, striking the blade at 90° to the leading edge and parallel to the plane of rotation and is constantly changing in direction during rotation. The term rotational velocity (V -rot) is used to quantify the rotational component of linear velocity. The rotational velocity is constant at each point along the span throughout 360° of rotation, being highest at the blade tips and decreasing uniformly to zero at the axis of rotation (center of the mast). Figure 2-18 shows a blade tip speed of 397 knots. The tip speed is a function of rotor rpm and the length of the blade, as represented by the equation:

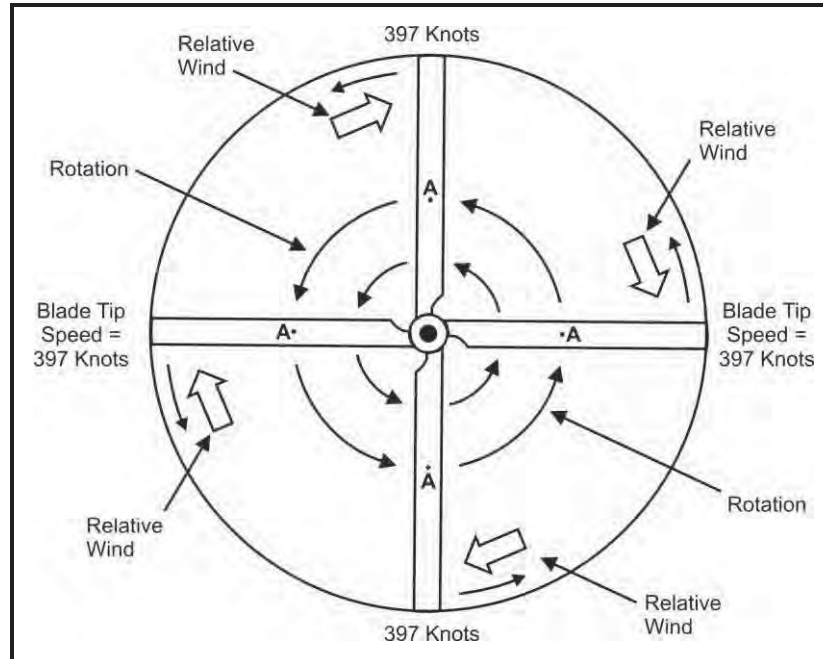

Figure 2-18 Rotational Velocity (V-Rot)

$$V_{rot} = (rpm) (2 \pi r) / (101.3 \text{ fpm/knot})$$

If point "A" in Figure 2-18 is 8 feet from the rotor mast and the system is turning at 394 rpm, we can determine V_{rot} as follows:

$$V_{rot} = (394) (2) (3.14) (8) / 101.3 = 195 \text{ knots}$$

Note that the wind is in no way interpreted to rotate, but rather its vector representation rotates to remain perpendicular to the leading edge as the rotor turns through the air.

For ease of comparison, note above that 1 knot is equal to 101.3 feet per minute ($6076 \text{ ft}_{\text{NM}} / 60 \text{ min}_{\text{hr}}$). This relationship may be helpful throughout the course, for example: 10 knots is approximately 1000 fpm, whether in forward flight, climb, or descent.

Induced Velocity (V-ind). On the ground at flat pitch the blade is not producing lift or downwash and the relative wind over the blade is the same as V-rot. Induced velocity is the vertical component of relative wind. With no downwash, no induced velocity is being produced. As the blade pitch angle is increased a pressure differential is created between the upper and lower surfaces of the blade. Air then attempts to flow around the blade tips from the higher pressure on the bottom blade surface to lower pressure on the upper blade surface (Figure 2-19). As the blade moves through the air mass, the air trying to flow around the blade tip causes a vortex behind the blade tip.

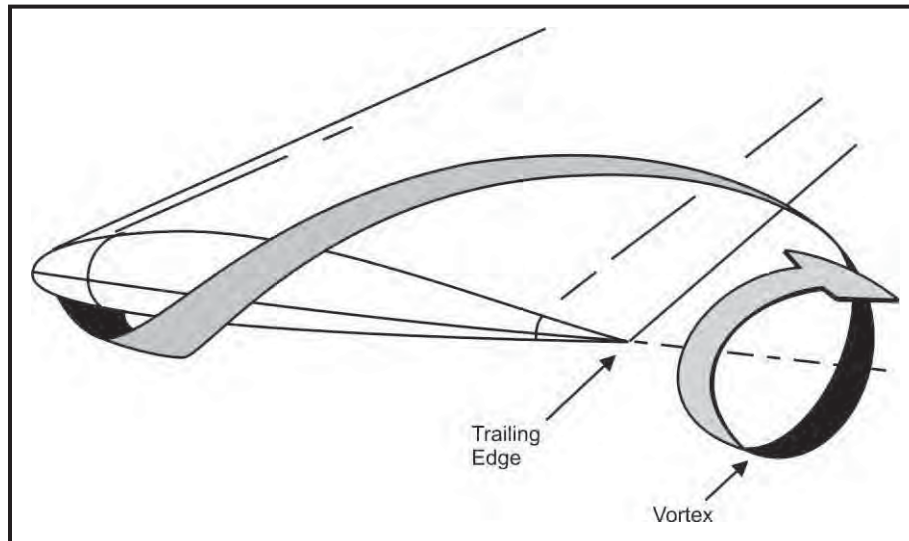

Figure 2-19 Blade Tip Vortex Generation

This “tip vortex” induces a span-wise flow and a downwash velocity at the trailing edge of the blade. Hence the rotor system at positive pitch induces a downward flow of air from the trailing edge of each rotor blade. Since the blades are moving horizontally in rapid succession, the induced downward component of air from the preceding blade must be added to the rotational velocity (V_{rot}) of the following blade. Combining the V_{rot} and the induced velocity gives the relative wind (Figure 2-20). The effect of the increasing induced velocity on the following blade is to decrease its AOA. Accordingly, to maintain a constant altitude hover, the pitch angle must be increased, which further increases induced velocity. In this manner, the still air is changed to a column of descending air (downwash) by rotor blade action (Figure 2-21). The induced velocity is most pronounced at a hover under no-wind conditions because the rotor system pumps airflow vertically through the rotor disk, producing the largest uninterrupted vortices. The term induced velocity (V_{ind}) quantifies the induced flow (downwash or upwash).

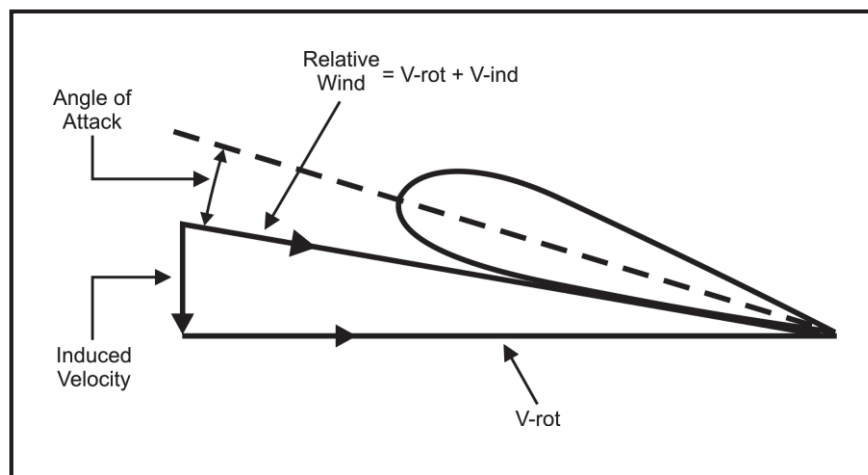

Figure 2-20 Induced Flow and AOA

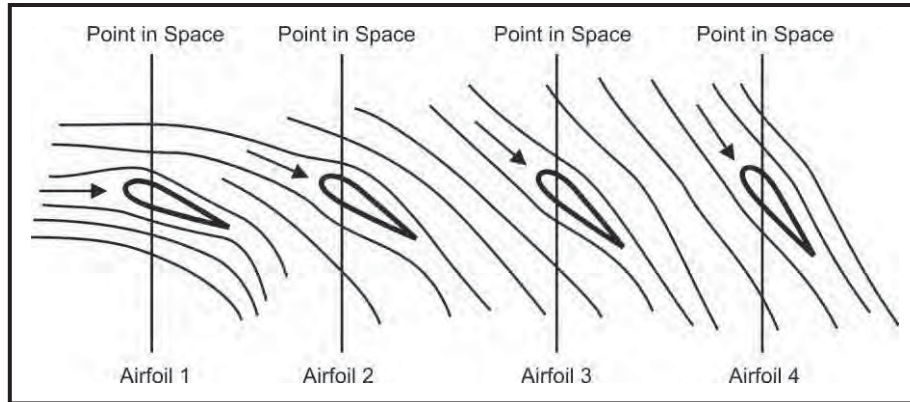

Figure 2-21 Development of Induced Velocity (Downwash)

NOTE

The relative wind created as a result of vertical motion of the air may be further modified by such factors as flapping, any horizontal movement (hunting, translation, or crosswind) of the blade, and airspeed, which will all be discussed later in the text.

Aircraft Translational Velocity (V-tran). While in forward flight, or while hovering with a crosswind, the rotational velocity (V-rot) must be modified by a translational component which is termed translational velocity (V-tran). If the aircraft translational velocity line is projected through the axis of rotation of the rotor system, the translational flow of air causes the airfoil to experience more horizontal airflow on one side of the wind line and less on the other (Figure 2-22). On the blade element diagram, the linear velocity is therefore determined by adding the translational velocity (V-tran) to the rotational velocity (V-rot) on the advancing blade and subtracting V-tran on the retreating blade.

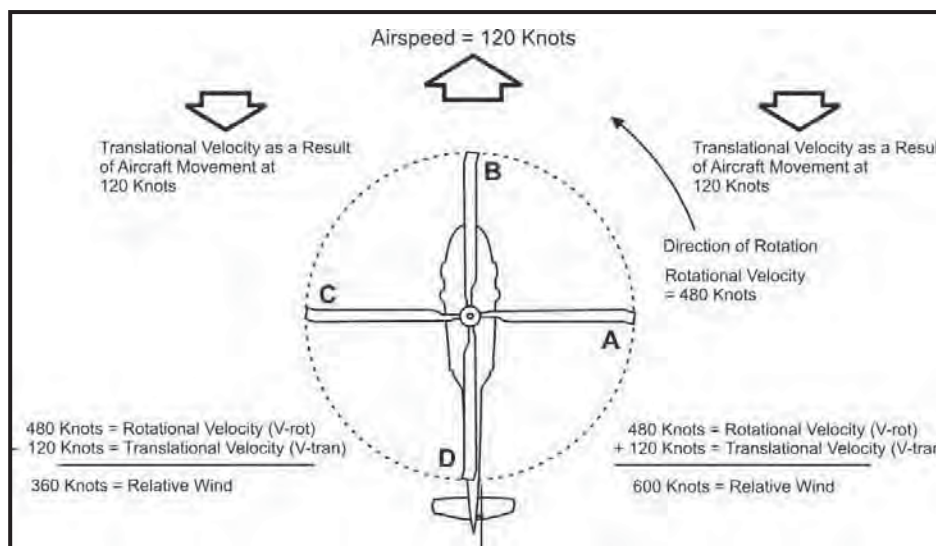

Figure 2-22 Components of Linear Velocity

Additionally, the pattern of air circulation through the disk changes when the aircraft has horizontal motion. With the associated decrease in the formation of tip vortices, the induced velocity is reduced. As the helicopter gains airspeed it moves into an air mass that is less and less disturbed. This change results in an improved efficiency (additional lift) being produced from a given blade pitch setting, which is primarily due to the reduction in induced velocity. This entire process will be further discussed in more detail in Chapter 10, which covers airflow in forward flight.

Review of Blade Element Diagram. At a no-wind hover, the relative wind is simply the rotational velocity (V_{rot}) modified by the induced velocity (Figure 2-23). With a crosswind or translational flight, however, the aircraft component of relative wind (V_{tran}) is added to, or subtracted from, the rotational velocity, depending on whether the blade is advancing or retreating (Figure 2-22) in relation to helicopter movement or the crosswind vector. In summary, the relative wind vector can be determined by vector addition of the induced velocity and the linear velocity ($V_{\text{rot}} \pm V_{\text{tran}}$, if applicable).

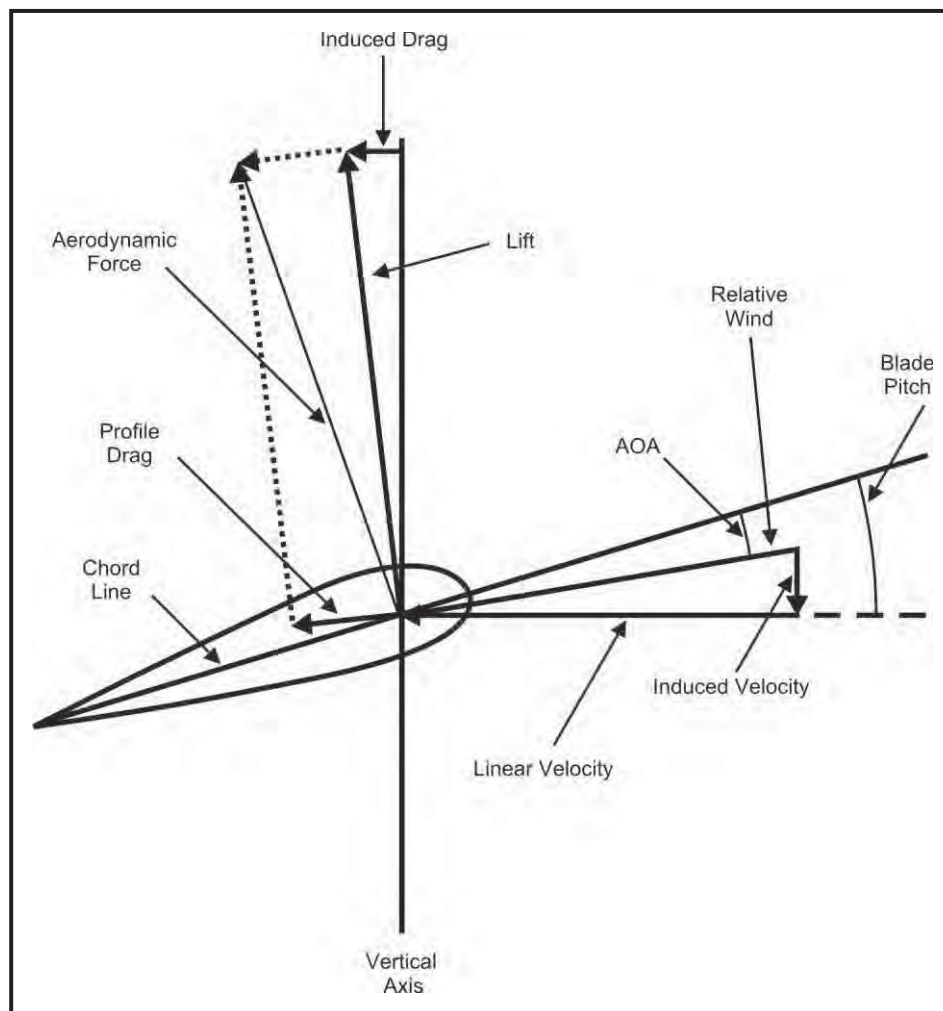

Figure 2-23 Blade Element Diagram

The blade element diagram in Figure 2-23 depicts various concepts necessary to understand much of the material for the remainder of the course, which should therefore be committed to memory: chord line, blade pitch, relative wind, linear velocity, induced velocity, AOA, lift, induced drag, profile drag, and aerodynamic force. Remember the components of the linear velocity vector: rotational velocity and translational velocity.

219. BLADE ANGLES

AOA and Blade Pitch. The blade pitch or pitch angle (also referred to as **angle of incidence**) is the angle between the chord line of a main or tail rotor blade and the plane of rotation of the rotor system (tip path plane). It is a mechanically defined angle rather than an aerodynamic angle (Figure 2-24). The AOA is the angle between the airfoil chord line and the relative wind (Figure 2-25). In the absence of an induced velocity, AOA and pitch angle are the same. Whenever relative wind is modified by induced velocity, the pitch angle and AOA are different. Collective and cyclic feathering (control input pitch changes) mechanically changes the pitch angle. Therefore, a change in the blade pitch results in a change in the AOA, which changes the coefficient of lift of the airfoil.

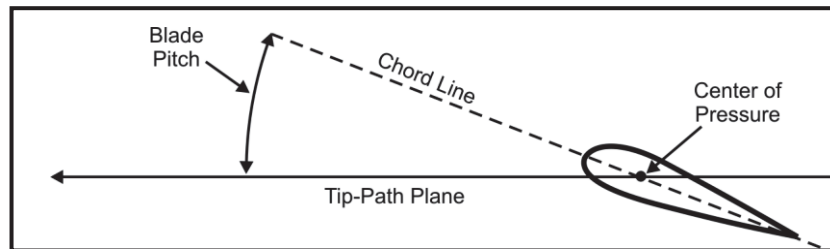

Figure 2-24 Blade Pitch Angle

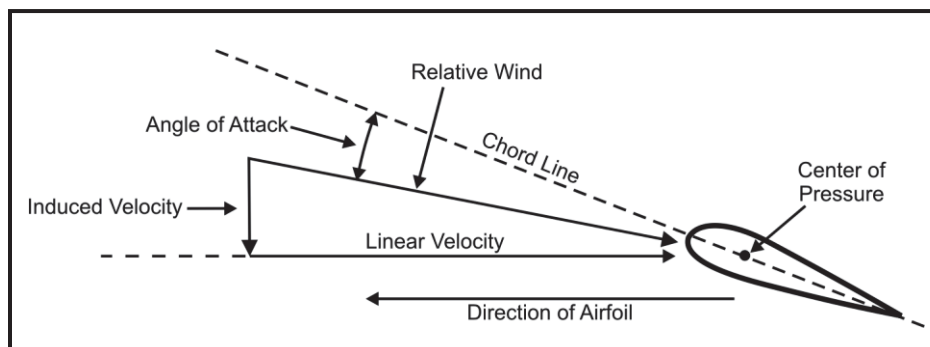

Figure 2-25 AOA

AOA and Stall. AOA is one of the primary factors that determines amount of lift and drag produced by an airfoil. Because the AOA is an aerodynamic angle, it can change with no change in the blade pitch, such as due to an increase in induced velocity decreasing the AOA. Aviators adjust the blade pitch through normal control manipulation and the aerodynamic forces change the AOA, yet even with no aviator input, the AOA will change as an integral part of the rotor blade traveling through the rotor disk arc. This continuous process of change is designed to accommodate rotary-wing flight. Aviators may have little control over blade flapping, blade

flexing, and gusty wind or turbulent air conditions, but cyclic feathering allows for pilot compensation.

Up to the point of aerodynamic stall, increasing the AOA causes greater acceleration of air atop the airfoil which results in a larger pressure differential between the top and bottom of the airfoil which, in turn, produces more lift. However, if the AOA is increased beyond a critical angle, the airflow across the top of the airfoil will separate (boundary layer separation). This creates a turbulent layer and causes static pressure on the upper surface of the wing to increase, thereby reducing the net pressure differential between the upper and lower surfaces. When this occurs, lift rapidly decreases, and drag rapidly increases. The only factor that can cause a stall is exceeding the critical AOA for the specific airfoil (the airspeed may vary at which the critical AOA will be reached).

A symmetric airfoil at zero AOA (Figure 2-26, left side) produces identical velocity increases and static pressure decreases on both the upper and lower surfaces. In the figure, arrows indicate static pressure relative to ambient static pressure. Arrows pointing toward the airfoils indicate higher static pressure; arrows pointing away from the airfoils indicate lower static pressure. The large arrows represent total force generated on each surface. At zero AOA the force on the lower surface is equal and opposite to that on the top surface. Since there is no pressure differential perpendicular to the relative wind, the airfoil produces zero net lift.

The right side of Figure 2-26 depicts what happens when an AOA is introduced to a symmetric airfoil. The streamtubes on the top surface get more compressed than those on the bottom surface, so the flow speeds up more. The faster flow on the top surface leads to higher dynamic pressure and lower static pressure. Notice that pressure on the lower surface is lower than ambient pressure also, but it is still higher than the pressure on the top surface. The lower static pressure above the airfoil creates a partial vacuum or suction which pulls the airfoil up. Some people prefer to think of it as the higher static pressure on the bottom surface pushes the airfoil up toward the lower pressure air on the upper surface, and lift is generated.

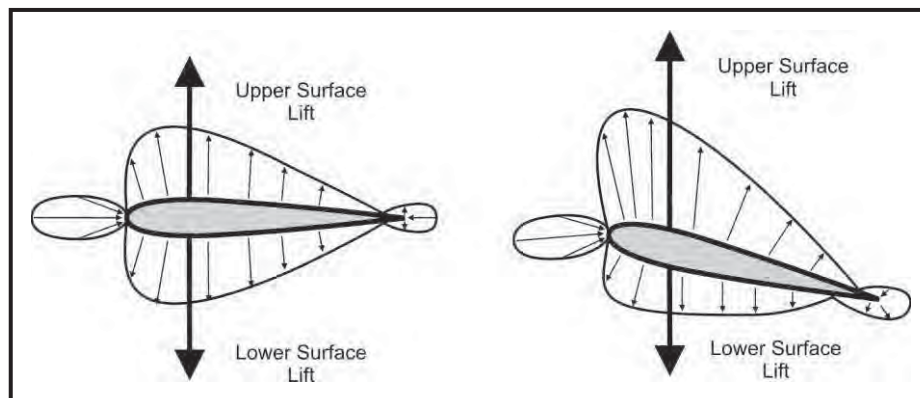

Figure 2-26 Lift on a Symmetric Airfoil

A cambered airfoil produces lift even at zero degrees AOA (Figure 2-27, left side). The positive camber makes the area in the streamtube above the wing smaller than the area in the streamtube below the wing. The airflow above the wing thus travels faster and causes a lower static

pressure. Higher static pressure below the wing pushes toward the lower pressure on the upper surface and generates lift. Also notice that putting a cambered airfoil at a positive blade pitch generates more lift than a symmetric airfoil would generate at the same angle.

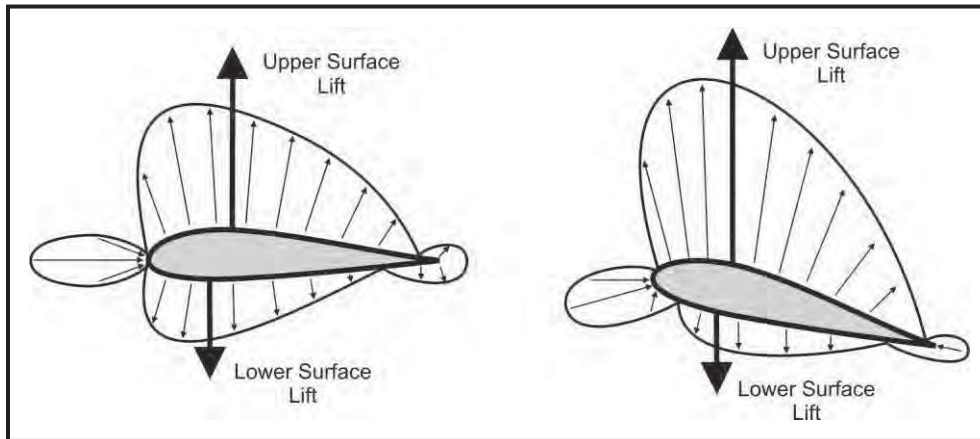

Figure 2-27 Lift on a Cambered Airfoil

220. AERODYNAMIC FORCES

Aerodynamics involves the study of forces imposed on a body that is placed in an airflow. The air can be moving past the object at a given velocity, or the body can be moving through still air at the given velocity. The effect is the same. The velocity at which the air impacts the body is represented by a relative wind vector that has magnitude and a direction.

Recall the discussion of airflow and streamtubes earlier in the chapter. Air flows around a symmetric airfoil at zero AOA in a streamline pattern similar to that depicted in Figure 2-28. As the air strikes the leading edge of the airfoil, its velocity slows to near zero, creating an area of high static pressure called the leading edge stagnation point. Air that is flowing adjacent to the stagnation point separates so that some air moves over the airfoil and some under it. Air passing over and below the airfoil is bounded on one side by the airfoil surface and on other sides by pressure in adjacent streamlines, so that a sort of “streamtube” is formed. Airflow leaving the leading edge stagnation point is accelerated as it passes through the decreased area in each streamtube, in the same way it would in a tube of decreasing size.

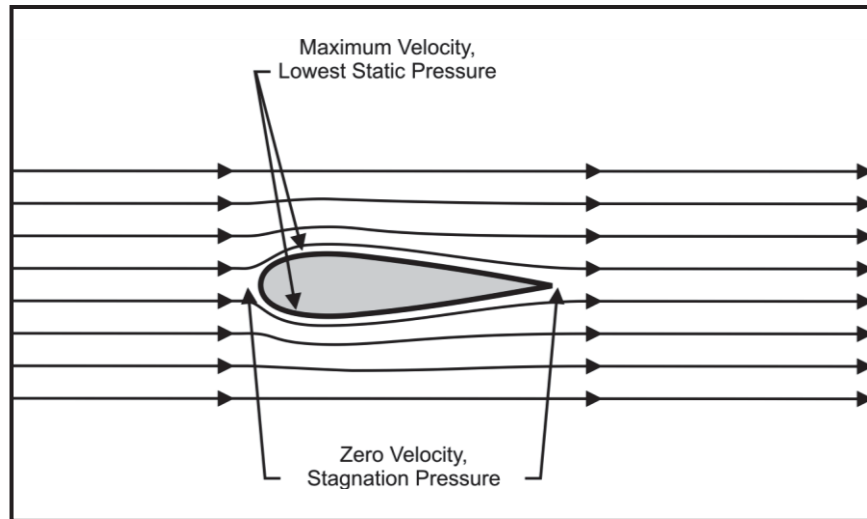

Figure 2-28 Streamlines Around a Symmetric Airfoil

As it travels along the airfoil, the airflow on the top and bottom surfaces reaches a maximum velocity at the point of maximum airfoil thickness (and minimum streamtube width). The airflow velocity then decreases until the flow reaches the trailing edge where the upper and lower airflow meet. At the trailing edge, the velocity slows to near zero velocity, forming another area of high static pressure called the trailing edge stagnation point.

As previously discussed, Bernoulli's equation explains what happens next as a result of the air's flow from leading edge to trailing edge. Since we are not doing any work to the airstream, the total pressure remains constant and thus only the static pressure and dynamic pressure are allowed to vary.

$$P_s + \frac{1}{2} \rho V^2 = \text{constant}$$

The increase in airflow velocity at any point over an airfoil causes dynamic pressure to increase and static pressure to decrease at that point. These changes in pressure, along with friction, are responsible for the aerodynamic force on an airfoil.

Now consider a cambered airfoil or a symmetrical airfoil at some positive AOA. As the air travels over the curved upper surface, there is a greater velocity increase and static pressure decrease over the upper surface than the lower surface. Therefore, a pressure differential develops between the upper and lower surfaces. That differential, combined with the resistance of the air to the passage of the airfoil, creates a force on the airfoil. The sum of those forces is The **Total Aerodynamic Force (TAF)** on the body.

221. TOTAL AERODYNAMIC FORCE

The Total Aerodynamic Force can be divided into components parallel and perpendicular to the relative wind that we know as **Lift** and **Drag**. Again, the angle between the chord line and the relative wind is known as the AOA. Although the static pressure on both upper and lower surfaces may be less than atmospheric pressure, remember that it is the net pressure differential between the surfaces which, when multiplied by the blade area, produces the TAF. The direction and magnitude of the TAF changes with changes in AOA and velocity. This complicates analysis of the airfoil's aerodynamic qualities and makes the TAF difficult to use in predicting aircraft performance. Dividing the TAF into two component forces simplifies analysis. The component that is perpendicular to the relative wind is called lift and the component which acts parallel to and opposes the motion of an airfoil through the air is called drag (Figure 2-29).

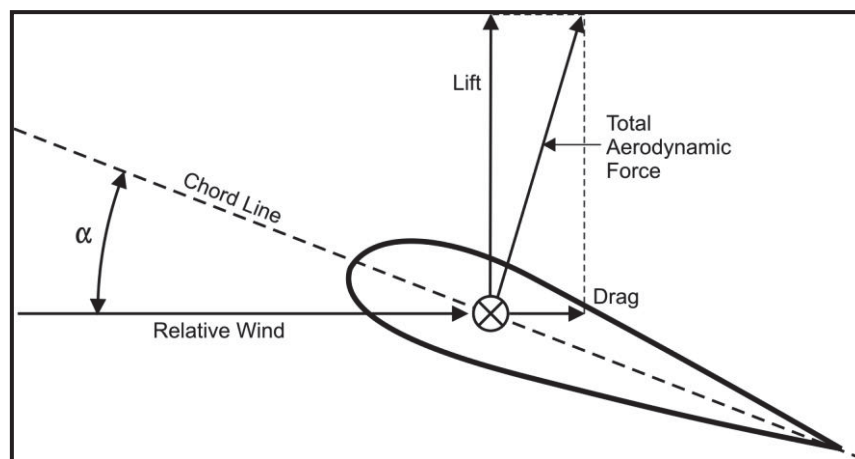

Figure 2-29 Total Aerodynamic Force

To get a true force that we can compare to a weight to be lifted, the pressure difference must be multiplied by the area over which it acts: the wing (or rotor blade) area. Additionally, because dynamic pressure over the wing drives the pressure differences, it is important in how much Total Aerodynamic Force is generated. In fact, dynamic pressure itself depends upon airspeed and density, as discussed in the previous chapter.

A review of the discussion to this point will indicate that at least five factors affect Total Aerodynamic Force:

1. **Airfoil shape.** Cambered airfoils produce more lift at a given AOA than symmetric ones.
2. **AOA.** A higher AOA causes higher flow speed and lower pressure on the upper surface.
3. **Blade area.** The area over which the pressure differences act directly affects total force because pressure is force per unit area.
4. **Relative wind.** Dynamic pressure changes with relative wind.

5. **Air Density.** Air density affects dynamic pressure by determining the amount of air that can be pushed in the flow (mass flow).

Because the relative wind, AOA, blade area and shape of the rotor blade are dependent on span location (distance along the blade), pitch angle, airspeed, blade twist and taper, the TAF is a term generally applied to the force at a specific location along the blade length, hence the “blade element diagram” is a representation of a single spot along a blade and not the total force created by the entire blade.

All five of those factors are reflected in the equation for aerodynamic force (airfoil shape and AOA are buried in the coefficient of force (C_F) term):

$$AF = qSC_F = \frac{1}{2}\rho V^2 SC_F$$

There are actually two other factors that affect Total Aerodynamic Force: Compressibility and Viscosity. At the speeds at which helicopters operate, and the environments to which they are limited, we can assume compressibility and viscosity to be constant. We will thus not further deal with them, except for a brief consideration of compressibility during the study of high-speed flight.

Because Lift and Drag are both component parts of the Total Aerodynamic Force, they are affected by the same factors:

$$L = qSC_L = \frac{1}{2}\rho V^2 SC_L$$

$$D = qSC_D = \frac{1}{2}\rho V^2 SC_D$$

The C_L and C_D terms in the above equations are called, respectively, **Coefficient of Lift** and **Coefficient of Drag**. They are useful for comparing performance of airfoils regardless of size or airspeed because they are dimensionless. This allows scale models to be tested in a wind tunnel, and performance characteristics can be recorded then compared on a graph (Figure 2-30). Figure 2-30 plots C_L as it varies with AOA. These curves are for three different airfoils: one symmetric, one negative camber, and one positive camber. The shape of the C_L curve is similar for most airfoils. The point where the curves cross the horizontal axis is the AOA where the airfoil produces no lift.

Using such a graph, for example, one could see that a cambered airfoil tends to have a higher maximum lift coefficient (C_{Lmax}) than a symmetric airfoil, and that the higher lift coefficient occurs at a lower AOA. The sudden loss of lift that occurs at angles of attack higher than that for maximum lift is called stall, and exists at high angles of attack for all airfoils. A stall is characterized by high drag and greatly reduced lift that results from separation of the airflow from the airfoil’s surface.

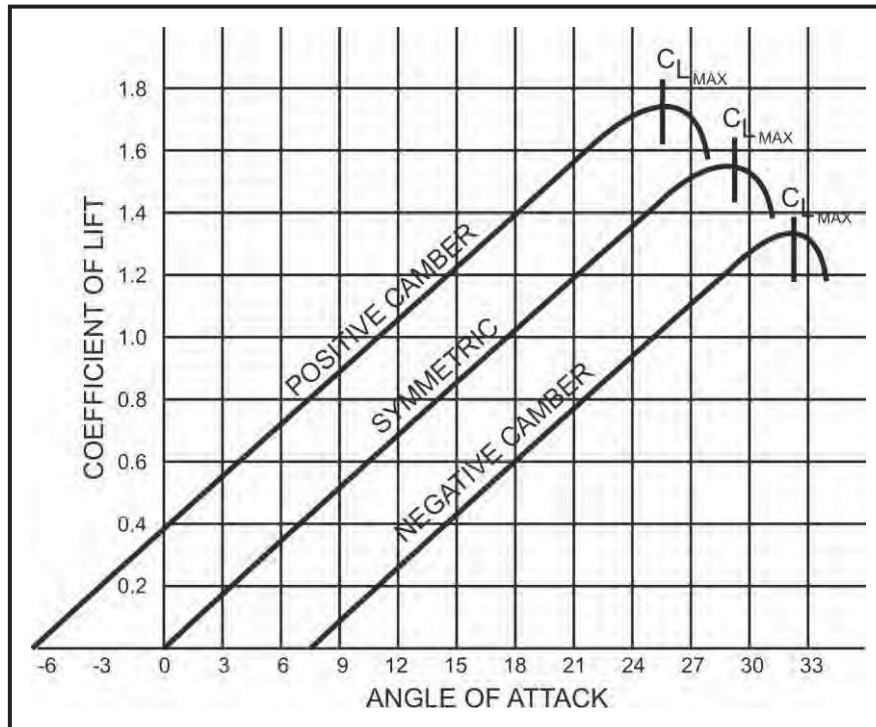

Figure 2-30 Coefficient of Lift Versus AOA Curve

Several important points need to be understood from the following sections:

1. Lift and Drag are defined with reference to the direction of the relative wind, so if the relative wind shifts, so will the direction of Lift and Drag components.
2. The AOA is affected by the direction of the relative wind, and in turn affects the value of Lift and Drag through their coefficients, as we will see.
3. Lift and Drag are determined by the square of the speed of the relative wind, so if the relative wind changes, as with forward flight, the value of Lift and Drag will change considerably.

222. LIFT AND THE LIFT EQUATION

Lift is the component of the total aerodynamic force of an airfoil that is perpendicular to the relative wind (Figure 2-31). The illustration of the lift equation, accompanied by a simple explanation, helps the understanding of how lift is generated. The point is not the math but understanding what an aviator can change and what he cannot.

The **lift equation** is as follows:

$$L = \frac{1}{2} \rho V^2 S C_L$$

Where L = lift force

$1/2$ = constant

ρ (*rho*) = density of the air (in slugs per cubic foot)

V^2 = airspeed (in feet per second) squared

S = surface area (in square feet)

C_L = coefficient of lift

The shape or design of the airfoil and the AOA determine the coefficient of lift. The aviator has no control over the airfoil design. However, he has indirect control over the AOA through manipulation of pitch angle. This is one element of the lift equation over which the aviator has some control. The aviator cannot affect the value of *rho*, but must be cognizant of the significant performance degradation associated with high DA. S represents the surface area of the airfoil, a design factor also unaffected by aviator input. Finally, there is V , representing relative wind velocity or airspeed.

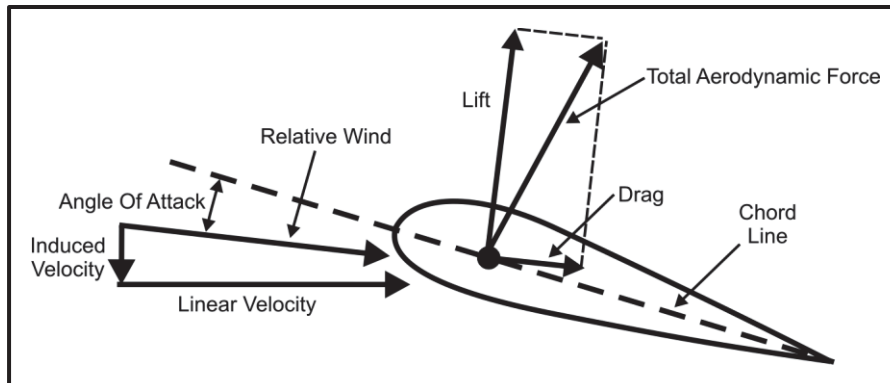

Figure 2-31 Forces Acting on an Airfoil

223. DRAG AND THE DRAG EQUATION

Drag is the component of the total aerodynamic force of an airfoil that is parallel to the relative wind (Figure 2-31). It results from pressure differences between the front and rear faces of an object (airfoil) in an airflow, as well as frictional losses between the surface and the passing air. Drag is often defined as the force that opposes the motion of an airfoil through the air.

The illustration of the drag equation accompanied by a simple explanation can help (in addition to the lift equation) in understanding how drag is generated. The point is not the math but understanding what an aviator can change and what he cannot.

The **drag equation** is as follows:

$$D = \frac{1}{2} \rho V^2 S C_D$$

Where D = drag force

$1/2$ = constant

ρ (*rho*) = density of the air (in slugs per cubic foot)

V^2 = airspeed (in feet per second) squared
 S = surface area (in square feet)
 C_D = coefficient of drag

Just as in lift, the most readily apparent effects are due to dynamic pressure and surface area. An increase in q ($\frac{1}{2} \rho V^2$) or S results in more interactions between air particles and airfoil surfaces which result in greater overall drag. The many other factors effecting the creation of drag are represented by C_D .

The shape or design of the airfoil and the AOA determine the coefficient of drag. As with the lift equation, the aviator has no control over the airfoil design. However, he has indirect control over the AOA through manipulation of pitch angle. This is one element of the drag equation over which the aviator has some control. Again, the aviator cannot affect the value of ρ , but must be cognizant of the significant performance degradation associated with high DA. S represents the surface area of the airfoil, a design factor also unaffected by aviator input. Finally, there is V, representing relative wind velocity or airspeed. It is the only other factor that the aviator can change.

C_D may be plotted against AOA for a given aircraft with a constant configuration. Note that the C_D is low and nearly constant at very low angles of attack. As AOA increases, the C_D rapidly increases and continues to increase. Since there is always some resistance to airflow, drag will never be zero; therefore, C_D will never be zero. Figure 2-32 shows a generic plot of C_L and C_D for varying AOA and then the ratio of lift over drag (L/D), which designers use to find the optimal operating range for an airfoil/aircraft. However, while L/D calculations work very well for fixed wing aircraft, due to the many extra variables in helicopter flight with a turning rather than stationary airfoil/wing, rarely will you see helicopters analyzed based on L/D calculations.

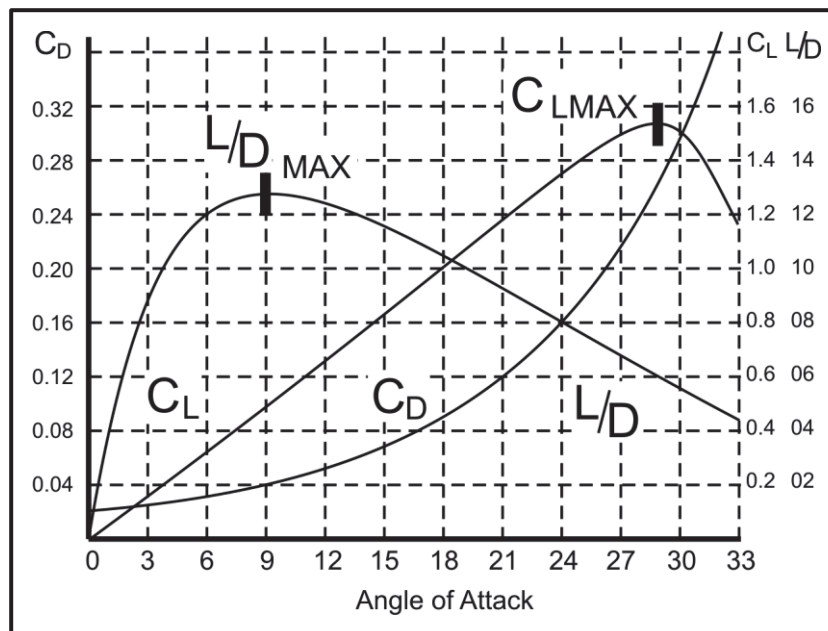

Figure 2-32 CD vs. AOA

The **total drag** on a helicopter has three components: **parasite drag**, **profile drag** and **induced drag**.

Drag/Airspeed Relationship. Figure 2-33 illustrates the relationship between the different drag components and airspeed.

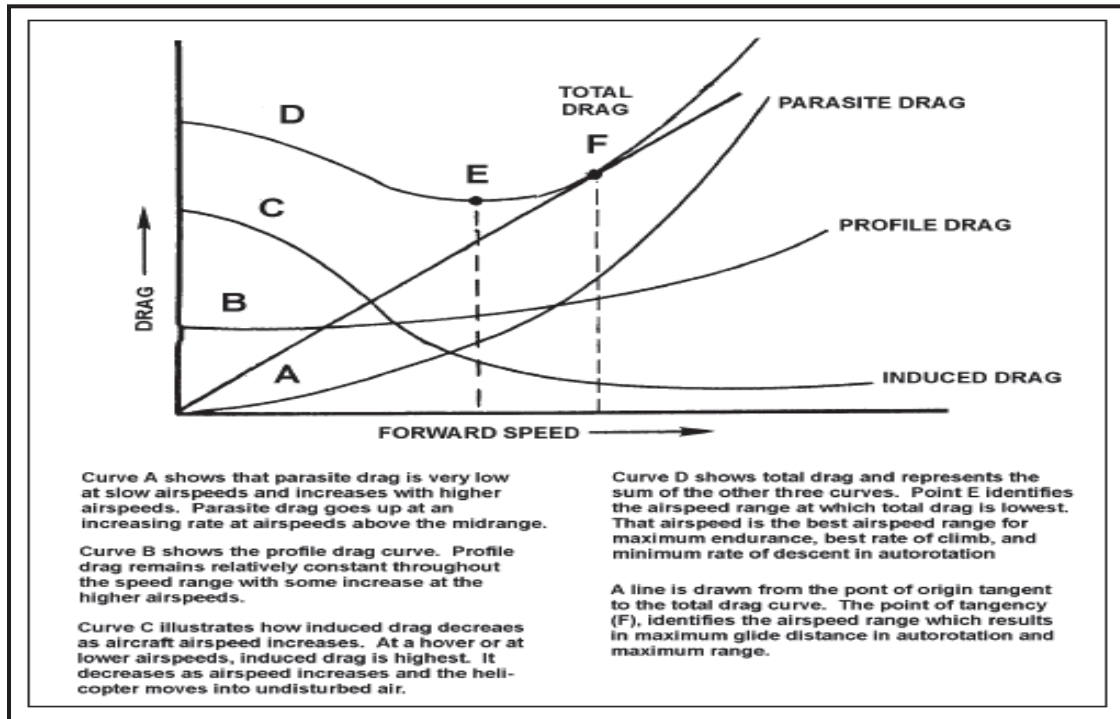

Figure 2-33 Drag and Airspeed Relationship

Parasite drag is the drag incurred from the non-lifting portions of the aircraft. It includes the form drag and skin friction associated with the fuselage, engine cowlings, mast and hub, landing gear, wing stores, external load, and rough finish paint. Form drag is related to both the size and shape of the aircraft or substructures. Skin friction drag results from the various layers of air near the aircraft skin surface sliding over one another and creating a force retarding the aircraft's motion (drag) because of the viscosity of the air. Surface roughness generates turbulent flow which increases skin friction drag. Many operators' manuals contain two sets of performance charts, one set for clean configuration and one set for high drag associated with the mounting of optional external fuel tanks or other mission equipment. Parasite drag increases exponentially with forward airspeed and dominates the drag curve at high airspeeds (Figure 2-33).

Profile drag is the drag developed by moving the rotor blades through the air. It has three components: skin friction, form, and wave drag. This is parasite drag, but called by a different name for the following reason. At a hover the rotating blades will generate parasite drag even if the aircraft is stationary without any forward speed. This is unlike an airplane which must move its fuselage (and attached wings) through the air to generate parasite drag.

At a stationary hover the blade tips may be at a speed of 300 knots, thereby generating skin friction and form drag on the blades, even though the fuselage has no forward speed. Accordingly, the blade parasite drag is labeled “profile” drag to differentiate it from the standard parasite drag which will affect the non-lifting portion of the aircraft as forward airspeed is increased. The name “profile” is used because blade parasite drag is a function of the shape of the blade airfoil, which is its two-dimensional “profile.” Profile drag is nearly constant at middle forward flight speeds, but increases moderately at higher airspeeds. At very high airspeeds, profile drag increases rapidly with the onset of blade stall or compressibility.

Skin Friction drag is drag due to wasted energy as the air rubs against the airfoil surface. It increases with surface roughness.

Form drag is the result of the very large difference in static pressure between air flowing near the leading edge (stagnation point) and that moving along the trailing edge. Just as high pressure below an airfoil combined with low pressure above it causes lift, high pressure on the forward portion of an airfoil combined with lower pressure on the after portion of the airfoil causes drag.

Wave drag is the result of shock wave formation and is present only at transonic and supersonic speeds; it is effectively zero for subsonic speeds below a very high speed known as the Drag Divergence Mach number. This form of drag would only be encountered in high speed operations, at the tip of the advancing rotor blade.

Induced drag is a result of the induced flow trailing edge downwash created by blade tip vortices. These vortices (previously discussed in Section 219) are only generated when the blades are producing lift. Due to the tip vortices, the relative wind actually departs the trailing edge of the blade with a downwash angle it did not have at the nose of the blade. If the relative wind at the nose of the blade and the trailing edge downwardly modified relative wind are combined, the average relative wind over the entire blade is inclined downward at the rear as compared to the free stream relative wind. Since lift is perpendicular to the “average” relative wind, the lift generated is inclined aft at the same angle that the relative wind is inclined downward by the induced velocity. This results in a component of lift acting in a rearward direction, which is known as “induced drag” (Figure 2-34). High angles of attack, which produce more lift, generate stronger vortices and greater trailing edge downward velocities that increase induced drag. In rotary-wing aircraft, induced drag is highest while hovering and decreases with increasing airspeed (Figure 2-33).

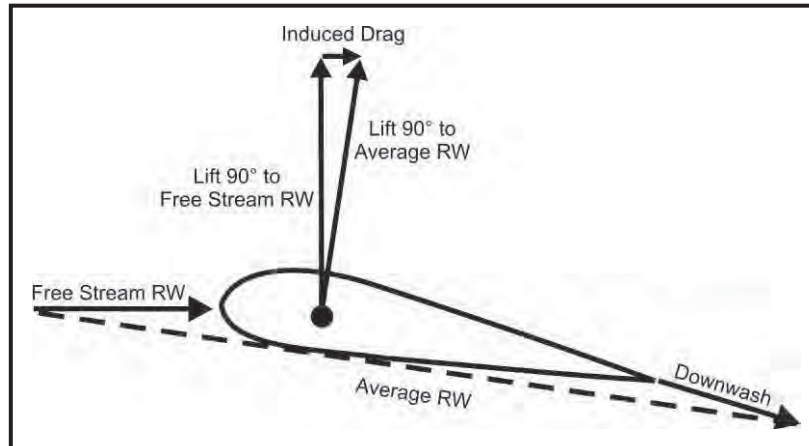

Figure 2-34 Production of Induced Drag

224. PITCHING MOMENT

Now let us investigate the different aerodynamic characteristics of airfoils regarding the AC and center of pressure for each type. The center of pressure is the point along the chord where the distributed lift is effectively concentrated. On a symmetrical blade, the moment is zero. For a nonsymmetrical airfoil, the AC is the point along the chord where all changes in lift effectively take place and where the sum of the moments is constant for any AOA.

On symmetrical airfoils, the center of pressure is co-located with the AC. The center of pressure of the upper and lower surfaces of a symmetrical airfoil act directly opposite each other. Because the AC and center of pressure are co-located, no moment is produced even though the total lift force changes with change in AOA (Figure 2-35, left).

On nonsymmetrical airfoils, the center of pressure of upper and lower surfaces do not act directly opposite each other, and a pitching moment is produced. As the AOA changes, the location of the distributed pressures on the airfoil also changes. The net center of pressure (sum of upper and lower) moves forward as AOA increases and aft as AOA decreases, producing pitching moments (Figure 2-35, right). This characteristic makes the center of pressure difficult to use in aerodynamic analysis. Since the moment produced about the AC remains constant for pre-stall AOA, it is used to analyze airfoil performance with lift and drag coefficients. The AC is located at the quarter-chord position on most subsonic airfoils and near half-chord on most supersonic airfoils.

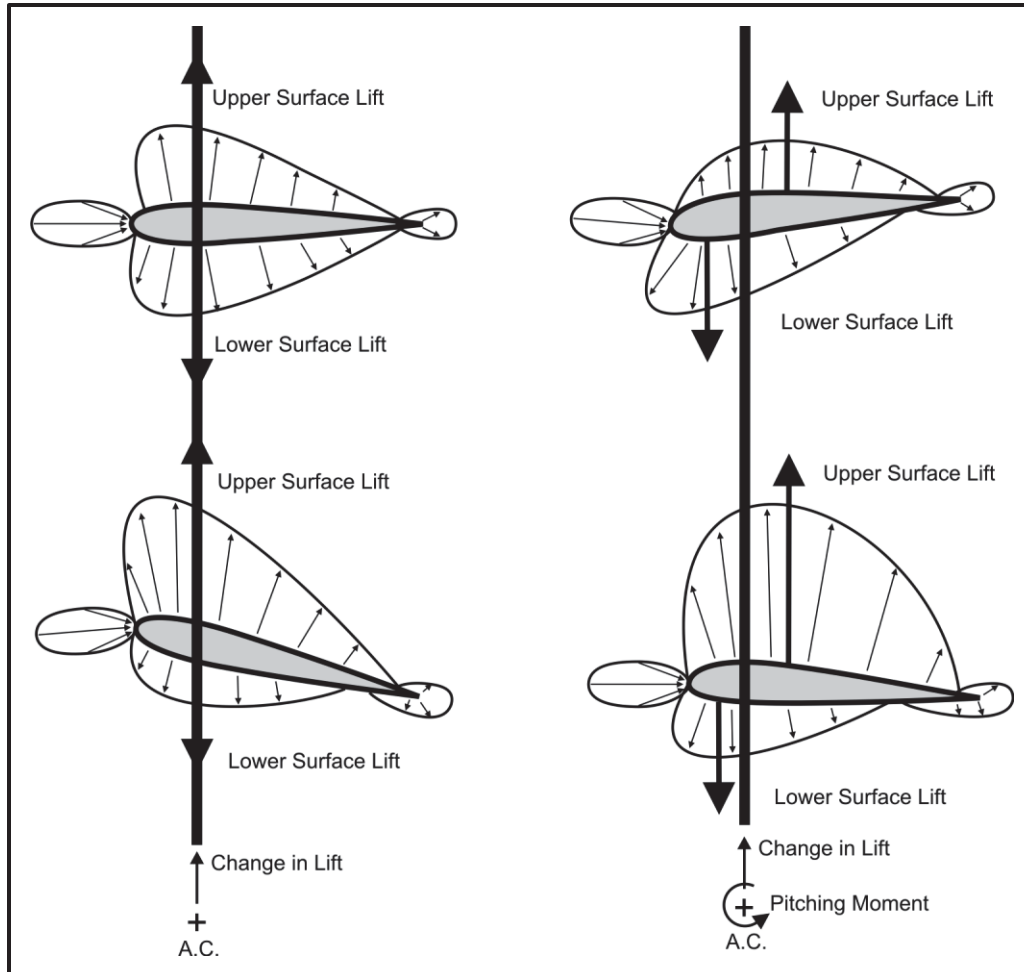

Figure 2-35 Pitching Moments in Airfoils

Pitching moments are an important consideration for airfoil selection. Torsional loads are created on the blades of positively cambered airfoils due to the nose down pitching moment produced during increased AOA. These torsional loads must be absorbed by the blades and flight control components, and initially this resulted in structural blade failure and excessive nose-down pitching at high speeds. Early helicopter engineers consequently chose symmetrical airfoils for initial designs, but have since developed cambered blades and components with high load-bearing capacity and fatigue life.

For the TH-57, rotor blade designers combined the most desirable characteristics of symmetrical and nonsymmetrical blades, resulting in the “**droop-snoot**” design (Figure 2-36). This incorporates a symmetrical blade and a nonsymmetrical "nose" by simply lowering the nose of the blade. The resulting nonsymmetrical blade performance characteristics include low pitching moments and high stall AOA.

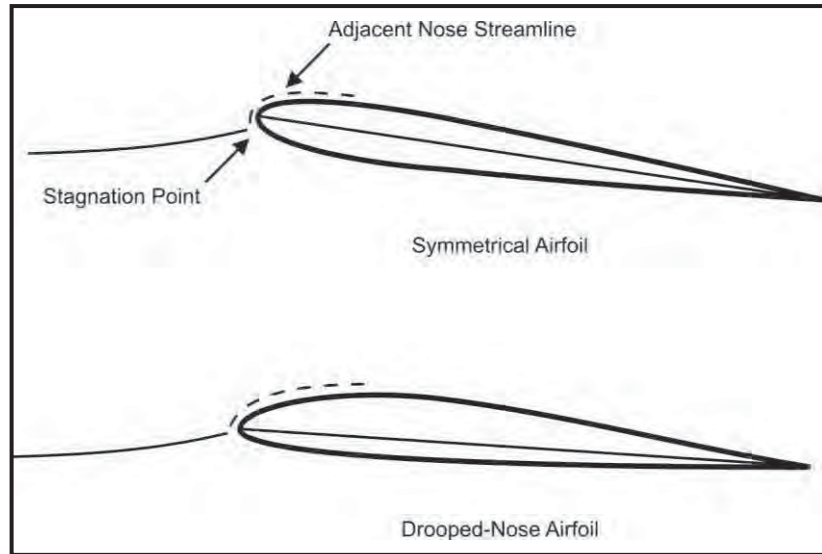

Figure 2-36 “Droop Snoot” Design Airfoil

The definitions of Center of Pressure and Aerodynamic Center are reviewed below:

Center of Pressure. A point along the chord where the distributed lift is effectively concentrated at a given AOA and the sum of the moments is zero. On symmetric airfoils its location is fixed; on cambered airfoils it moves forward as AOA increases.

AC. The point about which **no change in pitching moments occurs with changes in AOA.** The AC is normally located at the quarter chord position on most subsonic airfoils and near half chord on most supersonic airfoils.

Summary of differences between symmetric and cambered airfoils. By looking back at Figure 2-30, the reader should discern that symmetric and cambered airfoils perform differently in at least three important ways:

1. Symmetric airfoils produce no lift at zero degrees AOA; cambered airfoils produce some lift at zero degrees AOA.
2. In general, a cambered airfoil produces more lift at a given AOA than a symmetric one.
3. Cambered airfoils tend to have higher maximum lift coefficients than symmetric airfoils.

Consideration of pitching moment reveals one other important difference:

4. Symmetric airfoils have zero pitching moment about the AC. Cambered airfoils have a nose down pitching moment about the AC (Figure 2-35). This is an important consideration in the design of rotor blades due to the constantly changing AOA during each revolution.

225. AERODYNAMIC FORCES ON THE AIRCRAFT/TOTAL ROTOR THRUST

Up to this point, we have been discussing aerodynamic forces on the rotor blades and system. When we start discussing how the helicopter flies in later chapters, you must also look at how the forces apply to the aircraft itself. **Main rotor thrust** is the sum total of all the force/thrust vectors produced by the rotor blades along its entire span and throughout 360° of rotation. As previously discussed, it is perpendicular to the rotor disk or plane of rotation; therefore it is the vertical force if the plane of rotation is horizontal. In terms of Newton's Second Law ($F = m \cdot a$), rotor thrust is the mass of air through the rotor, multiplied by the change in velocity of the air ($T = m \cdot \Delta v$).

Newton's law of acceleration states that the force required to produce a change in motion of a body is directly proportional to its mass and the rate of change in its velocity. This means that motion is started, stopped, or changed when forces acting on the body become unbalanced. Rate of change (acceleration) depends on the magnitude of the unbalanced force and on the mass of the body to which it is applied. This principle is the basis for all helicopter flight: vertical, forward, rearward, sideward, or hovering. In each case, the **main rotor thrust**, also called **total rotor thrust** or just **rotor thrust**, generated by a rotor system is always perpendicular to the tip path plane (Figures 2-37 through 2-40). For this discussion, this force is divided into two components, vertical and horizontal. The vertical component opposes aircraft weight while the horizontal component opposes drag and acts to accelerate or decelerate the helicopter in the desired direction. Aviators direct the aircraft in a desired direction by tilting the tip path plane. At a hover in a no-wind condition, all opposing forces are in balance; that is, they are equal and opposite. Therefore, the vertical component of thrust and weight are equal, resulting in the helicopter remaining stationary (Figure 2-37).

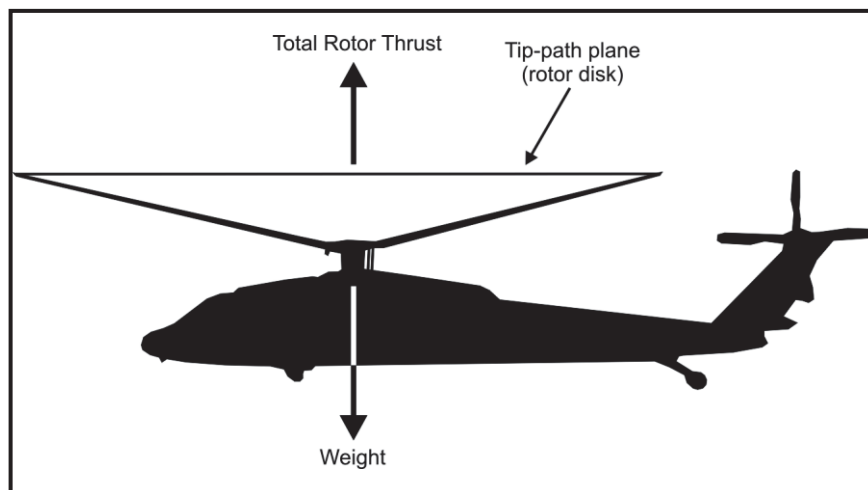

Figure 2-37 Balanced Forces, Hovering, No Wind

To make the helicopter move in some direction, a force must be applied to cause an unbalanced condition. Figure 2-38 illustrates an unbalanced condition in which the aviator has changed the attitude of the rotor disk resulting in the displacement of the thrust vector from vertical and increased the magnitude of the total rotor thrust. The total rotor thrust vector can now be viewed

as being made up of two components, a vertical (lift) vector and a horizontal (thrust) vector, resulting in a total force forward of the vertical. No parasite drag is shown because the aircraft has not started to move forward yet.

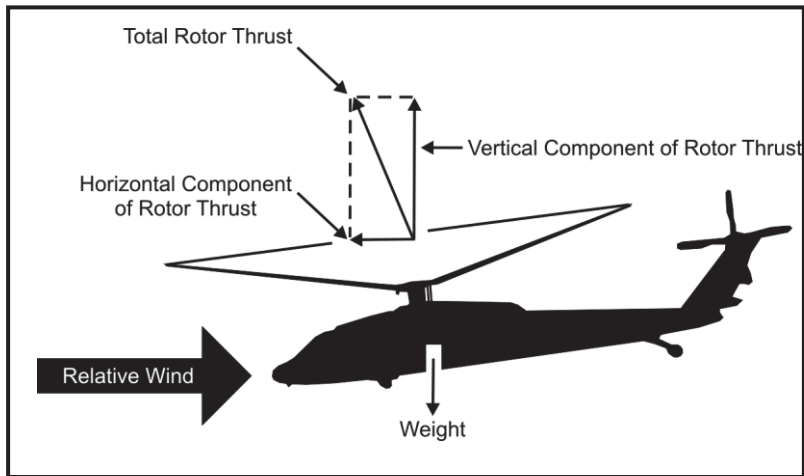

Figure 2-38 Unbalanced Forces Causing Acceleration

As the aircraft begins to accelerate in the direction of the applied horizontal thrust, parasite drag develops. When parasite drag increases to be equal to thrust, the aircraft will no longer accelerate because the forces are again in balance (Figure 2-39) as the aircraft has achieved steady-state (unaccelerated) flight. Total rotor thrust had to be increased to maintain lift equal to weight.

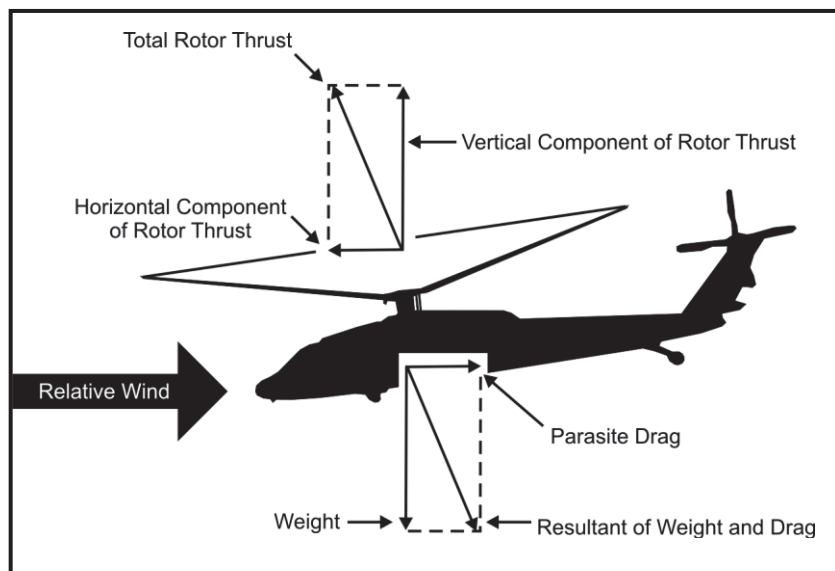

Figure 2-39 Balanced Forces, Steady-State Flight

To return the aircraft to a hover, the aviator must change the disk attitude to unbalance the forces (Figure 2-40). By tilting the rotor disk aft, the horizontal (thrust) force acts in the same direction as parasite drag and airspeed decreases.

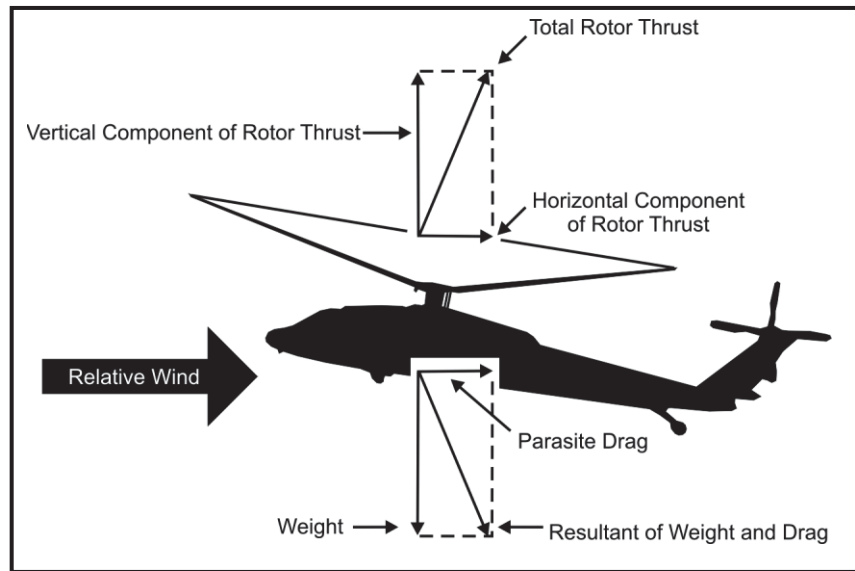

Figure 2-40 Unbalanced Forces Causing Deceleration

Although the vertical component is often called lift, and the horizontal component is often called either thrust or the propulsive force, these alternate terms are not recommended for use by the student due to their potential for confusion with other variables. Lift and Total Aerodynamic Force will be used in this course only as they apply to the blade element diagram.

226. MAIN ROTOR DRAG (IN-PLANE AND H-FORCE)

The horizontal component of the lift vector on the blade element diagram represents the induced drag at a specific location on one blade and can be added to profile drag to arrive at rotor drag. When this rotor drag is integrated along the entire span of the rotor blade and throughout 360° of rotation, **in-plane drag** for the rotor system is calculated. Because the drag of the retreating blade (lower linear velocity) is less than that of the advancing blade, the resultant rotor drag opposes the aircraft's movement. This drag has been termed the **H-force** because it is acting about the hub. Analyzing H-force is beyond the scope of this course.

227. TAIL ROTOR THRUST

Tail rotor thrust is primarily lateral to counteract main rotor torque, but may have a vertical component if canted. Tail rotor thrust is important for a number of reasons which will be discussed in later chapters, including: translating tendency, loss of authority/effectiveness, hovering attitude, compensation by cyclic in forward flight, and the left roll of retreating blade stall. Its importance in sideward flight and dynamic rollover will also be discussed.

THIS PAGE INTENTIONALLY LEFT BLANK

CHAPTER TWO REVIEW QUESTIONS

1. An airfoil with the same shape on top and bottom of its chord line is called a/an _____ airfoil, as compared to an airfoil with different shapes above and below the chord line, which is called a/an _____ airfoil.
2. With a/an _____ airfoil, the center of pressure does not move significantly with changes in AOA.
3. With a _____ airfoil, the lift distribution changes back and forth as the AOA changes.
4. The _____ Theory explains the concept that any device that produces a net aerodynamic force must exert an equal and opposite force on the air.
5. _____ drag is created as a result of the production of lift.
6. Regardless of AOA, the upper surface lift and lower surface lift of a symmetrical airfoil will act _____ each other, and a twisting force on the blade is/is not present.
7. Pitching moments are characteristic of the _____ airfoil.
8. AOA is found between the chord line and the _____.
9. The _____ is defined as the plane described by the rotating tips of the rotor blades.
10. The vertical flow of air through the rotor system is _____.
11. Draw and label a blade element diagram for powered flight.
12. In powered flight, based on the blade element diagram, increased rotational velocity with constant induced velocity shifts the relative wind vector toward the _____.
13. The net aerodynamic force developed perpendicular to the relative wind is _____.
14. The drag component parallel to the relative wind is _____.
15. In powered flight, as relative wind shifts toward the horizontal plane, the AOA _____.
16. Changes in the pitch angle directly/inversely affect AOA.

17. In the Lift Equation, $L = \frac{1}{2} \rho v^2 S C_L$ define the variables:

L _____ ρ (*rho*) _____

v _____ S _____

C_L _____

18. Rotor blade "pitching moments" are eliminated by using a _____ airfoil.

- a. tapered
- b. non-symmetrical
- c. neutral stability
- d. symmetrical

19. With no other change, an increase in the induced velocity will cause a decrease in the

- a. pitch angle
- b. lift
- c. linear flow
- d. drag

20. Induced drag is created as a result of the production of _____.

- a. thrust
- b. lift
- c. induced velocity
- d. none of the above

THIS PAGE INTENTIONALLY LEFT BLANK

CHAPTER TWO REVIEW ANSWERS

1. symmetrical . . . non-symmetrical
2. symmetrical
3. non-symmetrical
4. Momentum
5. induced
6. opposite . . . is not
7. non-symmetrical
8. relative wind
9. tip path plane
10. induced velocity
11. See figure 2-15.
12. tip path plane or horizontal plane
13. lift
14. profile drag
15. increases
16. directly
17. $L = \text{lift}$, ρ (*rho*) = air density, $v = \text{velocity}$, $S = \text{surface area}$, and $C_L = \text{coefficient of lift}$
18. d
19. b
20. b

CHAPTER THREE AIRFOIL DESIGN

300. INTRODUCTION

The purpose of this chapter is to aid the student in understanding airfoil design. Airfoil design considerations include both performance and rotor configuration requirements. Performance criteria for engine compressors and turbines, as well as hovering and forward flight, will be discussed further in later chapters. Rotary wing airfoil design requires an understanding of symmetry, twist, taper, compressibility, inertia, and solidity. Engineers also look at aspect ratio (AR) and figure of merit (FM) when designing rotor blades, but those topics will not be discussed here.

301. LESSON TOPIC LEARNING OBJECTIVES

1. **Terminal Objective:** Partially supported by this lesson topic:

Upon completion of this unit of instruction the student will demonstrate familiarity with various airfoil design considerations.

2. **Enabling Objectives:** Completely supported by this lesson topic:
 - a. Recall the definition of taper and state why it is used in helicopter design.
 - b. Recall the definitions of geometric and aerodynamic twist and state why they are used in helicopter design.
 - c. Recall the definition of compressibility and methods used to counter its effects.

302. REFERENCES

1. Fundamentals of Aerodynamics, NAVAVSCOLSCOM-SG-111
2. Rotary Wing Aerodynamics for Naval Aviators
3. Fundamentals of Flight
4. Helicopter Aerodynamics
5. Helicopter Performance, Stability, and Control

303. STUDY ASSIGNMENT

1. Review Chapter Three.
2. Answer the Review Questions.

304. GENERAL

As discussed in Chapter Two, symmetric blades minimize undesirable pitching moments while cambered airfoils provide better stall characteristics and more lift for a particular angle of attack. The droop snoot design of the TH-57 therefore combines some of the advantages of both. The use of cambered designs alters chord-wise lift distribution, which is discussed in a bit more detail in the next paragraph on leading edge suction. There are several other modifications to airfoils which address challenges more specific to rotary wing flight. Twist and taper, for example, also improve span-wise lift distribution and are discussed in later sections of the chapter. The concepts of compressibility, inertia, and solidity round out areas of concern for rotary wing airfoil design.

305. LEADING EDGE SUCTION

From the aforementioned discussions of continuity and the Bernoulli relationship, it might appear that the greatest pressure differential about the blade would occur at the point of greatest airfoil thickness. However, as illustrated in Figure 3-1, it is clear from examination of the pressure distribution about the airfoil that the greatest decrease in pressure actually occurs forward of the thickest section of the airfoil.

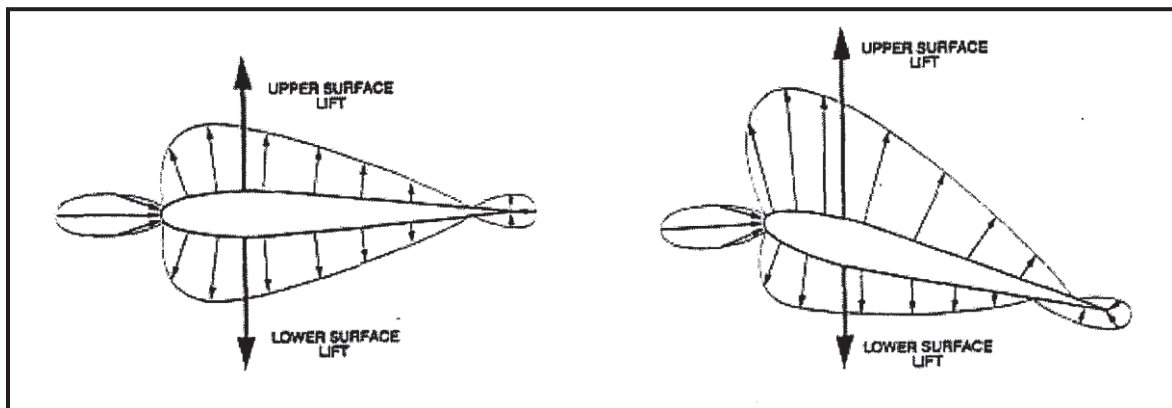

Figure 3-1 Pressure Distribution and Leading Edge Suction

This has been best described by Euler to be a result of leading edge suction. Looking at the derivation of the Bernoulli equation by Euler (Figure 3-2), note the acceleration component in the first line (dV).

3-2 AIRFOIL DESIGN

Euler	$dp = -\rho V dV$
	$\int dp = -\rho \int V dV$
	$p_2 - p_1 = -\rho \left(\frac{V_2^2}{2} - \frac{V_1^2}{2} \right)$
	$p_1 + \frac{1}{2} \rho V_1^2 = p_2 + \frac{1}{2} \rho V_2^2$
Bernoulli	$P_T = P_s + \frac{1}{2} \rho V^2$

Figure 3-2 Bernoulli Equation as Derived by Euler

This acceleration term, which describes the rapid change in velocity from the stagnation point (where $V=0$) to the point of maximum thickness, accounts for the significant pressure differential forward on the airfoil. The acceleration term disappears with the derivation of the Bernoulli equation. However, this rapid acceleration forward on the airfoil does explain the pressure distribution, and has been termed “leading edge suction.” The three primary equations for studying pressure around an airfoil are recapped below.

Continuity:	$A_1 V_1 = A_2 V_2$
Bernoulli:	$P_T = P_s + \frac{1}{2} \rho V^2$
Euler:	$dP = -\rho V dV$

Figure 3-3 Continuity, Bernoulli, and Euler Equations

306. TWIST AND TAPER

The distribution of lift along a rotor blade is not uniform because speed varies along the span. The linear velocity at a point on a rotating blade depends on the blade’s angular speed (often expressed in rpm), and the point’s distance from the center of rotation:

$$\text{Velocity} = (\text{Angular velocity}) \times (\text{distance from the axis})$$

The outboard portions of the rotor blades have the highest speeds and thus provide most of the lift. The increase in lift along the span does not vary with the radius, but with the radius squared. This uneven lift distribution produces excessive blade bending and coning angles. To alleviate the problem, the rotor blades can be twisted so that the blade root has a higher AOA than the blade tip. This is known as geometric twist.

Geometric twist improves helicopter performance by making induced velocity distribution and, therefore, lift along the blade more uniform. When blade twist is used to even out the induced flow across the rotor disk, it can significantly improve performance. A rotor without blade twist tends to produce higher induced velocities in the outer portion of the disk than in the inner portion (Figure 3-4). The optimum condition, however, is with uniform induced velocity over the entire disk. A blade with geometric twist has greater pitch at the root than at the tip. A progressive reduction in AOA from root to tip creates a balance of lift throughout the rotor disk. It also delays the onset of retreating blade stall at high forward speed due to reduced AOA. The application is usually modified by high-speed considerations. Experience has shown that the large amount of blade twist optimum for hover performance (as much as 30°) will generate high oscillating blade loads and vibration at high speeds. No twist or low twist angles reduces the vibration at high speed, but creates inefficient hover performance. The usual design compromise is to use moderate values of 6 – 12 degrees, which provide most of the benefits of ideal twist in hover while avoiding most of its disadvantages in forward flight.

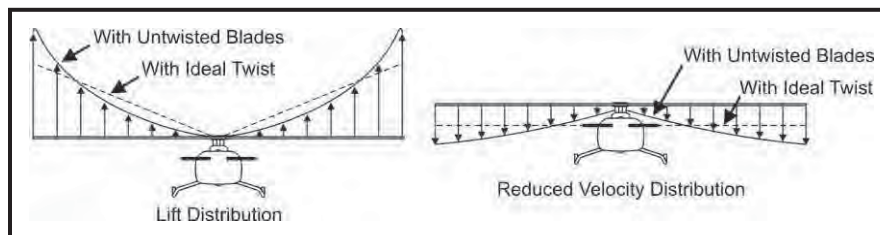

Figure 3-4 Blade Twist

As an alternative to geometric twist, the shape of the airfoil may be altered. A blade with aerodynamic twist has an airfoil shape near the root that produces a greater lift coefficient at anticipated angles of attack than the airfoil shape used near the tip. Examples of geometric twist and aerodynamic twist are depicted in Figure 3-5.

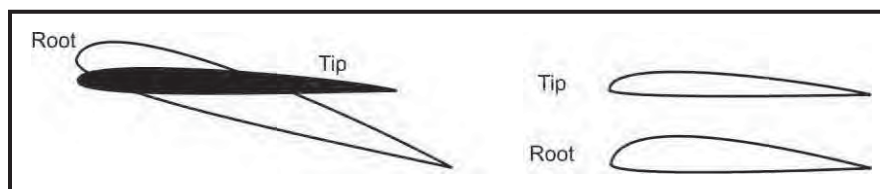

Figure 3-5 Geometric combined w/aerodynamic and Aerodynamic Blade Twist

As yet another way to control lift along the blade's span, surface area can be altered. Designers alter the lift profile in forward flight by maximizing the lift to drag ratio. Near the blade tip the chord is reduced thereby reducing the blade section lift and drag. This modification specifically addresses the advancing blade. If the tip sections have less surface area than the root sections it tends to even out the lift a little bit. The reductions in surface area are recognized as blade taper (Figure 3-6).

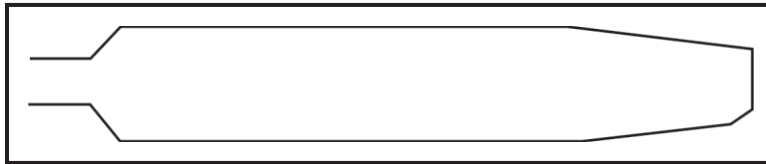

Figure 3-6 Blade Taper

Most helicopter rotor designs use a combination of geometric twist, aerodynamic twist, and blade taper to create a more ideal lift distribution.

307. INERTIA

Newton's first law of motion: An object remains at rest or in uniform motion in a straight line unless compelled to change its state by the action of an external force. Inertia governs how an aircraft reacts to directional control inputs to the flight control system, but, more importantly for the helicopter pilot, also governs the reaction of the rotor system to a loss of engine power.

A high inertia rotor system will tend to allow the pilot greater reaction time before rotor speed decays, but will be slower to regain lost rpm. A low inertia rotor system, on the other hand, loses rpm much more quickly if the collective is not lowered rapidly, but is able to regain rpm much more quickly than a high inertia system.

308. SOLIDITY

When using the basic lift equation, S represents the blade area.

$$L = \frac{1}{2} \rho V^2 S C_l$$

However, when considering the total rotor thrust required by the rotor system, the process is a bit more complicated and designers start getting into the solidity (σ or sigma) of the rotor disk, i.e., how much of the actual disk area is rotor blades and how much is airspace.

Blade area, S , may be represented by:

$$S = A = bcR, \text{ where } b = \text{number of blades, } c = \text{blade chord, and } R = \text{rotor radius}$$

Rotor system solidity, σ , is defined as the ratio of the total blade area to the disk area.

$$\sigma = \frac{A_b}{A} = \frac{bcR}{\pi R^2} = \frac{bc}{\pi R} \quad \text{Where: } A_b = \text{total blade area, } A = \text{disk area}$$

Solidity can then be used with the coefficient of thrust (C_T) to compute the blade loading coefficient (mean lift coefficient) or thrust coefficient or solidity for the entire rotor disk using the following equations:

$$\frac{c_T}{\sigma} = \frac{T}{\rho A (\Omega R)^2} \frac{A}{A_b} = \frac{T}{\rho A_b (\Omega R)^2}$$

Solidity and blade loading affect the size of the rotor blades and diameter of the rotor disk required to meet mission requirements. Given the solidity necessary for a particular mission and weight, selection of the appropriate number of blades, with additional consideration for forward flight performance (i.e., retreating blade stall) and autorotation characteristics, can be completed.

The assumption here is that the chord of the blade remains constant from the center of rotation to the blade tip. While this is a very simplified way to view the blade, it yields viable results for solidity because the inner portions of the rotor blade contribute little to the overall thrust production. Making corrections for the chord change on the blade tip is legitimate and is done by means of the equivalent thrust-weighted solidity, σ_e .

309. AIRFOIL DESIGN FOR COMPRESSIBILITY

The solutions typically used to deal with advancing blade compressibility effects are sweeping the leading edge of the rotor blades back, varying the airfoil thickness along the span, and varying the airfoil section along the span.

Sweep reduces the velocity that the blade tip "sees" thereby delaying drag divergence and reduces the $C_{L \max}$ of the airfoil. Variation of airfoil thickness and variation of airfoil section serve to change the properties of the airfoil such that as the rotational velocity increases out towards the end of the blade, the thickness decreases or the overall qualities of the airfoil change to take advantage of the increase in speed. An example of these solutions can be found on the British Experimental Rotor Program (BERP) blade that was flown on a Westland Lynx in 1986. BERP blades reduce effective blade tip Mach number with tip sweep thereby delaying the onset of compressibility losses. The retreating blade stall is delayed by a blade tip notch which generates a vortex that reenergizes the flow and the asymmetrical blade tip shape keeps the blade AC closer to the rest of the blade, thereby reducing twisting effects.

CHAPTER THREE REVIEW QUESTIONS

1. _____ compensates for increased rotational velocity from blade root to tip by increasing/decreasing blade pitch from root to tip.
2. _____ occurs when the velocity over the blade tips exceeds the speed of sound.
3. Compressibility causes the nose of the airfoil to _____, which causes extreme _____ forces in a rotor blade.
4. Geometric twist on a rotor blade is limited due to its negative characteristics in which of the following situations?
 - a. Hovering flight
 - b. Flaring
 - c. Ground effect
 - d. Forward flight

CHAPTER THREE REVIEW ANSWERS

1. geometric twist . . . decreasing
2. Compressibility
3. pitch down . . . twisting
4. d

CHAPTER FOUR ROTOR SYSTEM DYNAMICS

400. INTRODUCTION

The purpose of this chapter is to aid the student in understanding aircraft design. Aircraft design considerations include both performance and rotor configuration requirements. Main rotor types and individual blade actions are discussed here in detail. Rotor system dynamics also requires an understanding of coning and geometric imbalance.

401. LESSON TOPIC LEARNING OBJECTIVES

1. **Terminal Objective:** Partially supported by this lesson topic:

Upon completion of this unit of instruction the student will demonstrate familiarity with the dynamics of various rotor systems.

2. **Enabling Objectives:** Completely supported by this lesson topic:
 - a. Describe feathering and its role as well as cyclic and collective pitch control.
 - b. Describe flapping and how it is accomplished in each system.
 - c. Recall the definition of the physical and aerodynamic forces acting on the main rotor head, including lift, drag, centrifugal, inertia and coning.
 - d. Describe how geometric imbalance affects rotational blade movement (lead/lag), and how it is compensated for or eliminated in different rotor systems.
 - e. Differentiate between and characterize the three types of rotor systems in use today in Navy/Marine Corps aviation.

402. REFERENCES

1. Fundamentals of Aerodynamics, NAVAVSCOLSCOM-SG-111
2. Rotary Wing Aerodynamics for Naval Aviators
3. Fundamentals of Flight
4. Helicopter Aerodynamics
5. Helicopter Performance, Stability, and Control

403. STUDY ASSIGNMENT

1. Review Chapter Four.
2. Answer the Review Questions.

404. BLADE ACTIONS

Rotation. The rotation of the rotor blades is the most basic movement of the rotor system and produces the **rotational velocity (V-rot)**. During hover, airflow over the rotor blades is produced by rotation of the rotor system. The blade speed will vary according to the distance or radius from the center of the main rotor shaft. A typical rotor system with an arbitrary rotor diameter of 34 feet and rotor speed of 300 rpm may be used to demonstrate rotational velocities. In this example, blade tip velocity is 520 feet per second or approximately 300 knots. At the blade root (nearer the rotor shaft or blade attachment point), the blade speed is much less because the distance traveled at the smaller radius is much less. Halfway between the root and tip (mid-span), the blade speed is 150 knots, or one-half the tip speed. While the airspeed differential between root and tip is extreme, the lift differential is even more extreme because lift varies as the square of the velocity. As velocity is doubled, lift increases four times. This means that the lift at mid-span would be only one-fourth as much as the lift at the blade tip (assuming no twist and that the airfoil shape and AOA are the same at both points).

A discussion of rotor system control must begin with an understanding of degrees of freedom. A degree of freedom will be defined as the ability to move around an axis. An airplane fuselage, for example, has three degrees of freedom: pitch, roll, and yaw. A helicopter has the same three degrees of freedom with regards to fuselage attitude and it has another three degrees of freedom regarding rotor blade actions. To equalize forces, dampen vibrations, and use the rotor disk productively, designers focus on these three degrees of freedom for the rotor system. Each degree of freedom provided to the rotor head has a mechanical or effective (virtual) hinge associated with it. The three types of hinges, degrees of freedom, and their uses are described below.

1. **Feathering (pitch change).** Feathering is the rotation of the blade about its span-wise axis. It permits changes in blade pitch angle. Collective or cyclic inputs translate to feathering the blades at one or more position.
 - a. Collective Feathering – changes all blades the same amount and direction.
 - b. Cyclic Feathering – changes pitch on blades according to azimuth position with opposite blades changing pitch equally but in opposite directions.

Main rotors utilize both cyclic and collective feathering with separate controls. Anti-torque tail rotors utilize only collective feathering controlled primarily by pedal inputs.

2. **Flapping.** Flapping is the upward and downward rotation of just a few degrees by a rotor blade about a horizontal hinge (or effective horizontal hinge) during rotation about the mast.

4-2 ROTOR SYSTEM DYNAMICS

Flapping takes place around the **trunnion bearing** (a horizontal teetering hinge mounted directly over the mast) in the semi-rigid system. Flapping occurs around **horizontal hinge pins** mounted at the head in the fully articulated system. Lastly, a rigid system allows flapping primarily through the flexibility of the hub and some in the blade material. In order to maneuver the helicopter the rotor disk must be tilted. The tips of the rotor blades therefore must be allowed some vertical movement. Flapping occurs as a result of aerodynamic forces that are generated by cyclic changes to pitch or by a phenomenon called **dissymmetry of lift**.

Dissymmetry of lift was noticed in the early days of rotary wing development when rigidly attached blades were used. As soon as Juan de la Cierva's autogyro gained appreciable forward speed (even before taking flight), it would roll to the left. The relative wind over the tip of the advancing blade at the three o'clock position is the sum of the speed due to rotation and the aircraft's forward speed. At the nine o'clock position the relative wind is the speed due to rotation minus the forward speed. A portion of the retreating blade actually has airflow that moves from the blade's trailing edge to its leading edge. In forward flight, every point on the advancing side of the disk has a higher relative wind speed than its counterpart on the retreating side. Because lift is proportional to the relative wind speed squared, there is significantly more lift on the advancing side of the disk than the retreating side. This situation is called **dissymmetry of lift** and will be discussed in greater detail in Chapter 10.

Following Cierva's invention of the flapping hinge, in order to compensate for dissymmetry of lift, designers implemented a horizontal hinge which allows the blades to flap. As an advancing blade encounters higher relative wind velocity, it generates additional lift and flaps up. The vertical motion of the blade upward generates an increased induced velocity. This tilts the relative wind downward (vector direction), decreasing the AOA and reducing lift.

A blade on the retreating side encounters lower wind velocity so it generates less lift and flaps down. The vertical motion downward generates a decreased induced velocity that tilts the relative wind upward (more horizontal), resulting in a larger AOA and therefore more lift. The effects of flapping on the advancing and retreating sides compensate for the effects of dissymmetry of lift.

3. **Lead/Lag.** Lead/lag, or hunting, the third degree of freedom on a rotor blade, is the fore and aft movement of blades about a **vertical hinge**. Lead/lag is allowed in order to relieve stress forces caused by dissymmetry of drag and conservation of angular momentum.

Drag on a rotor blade as it travels around the rotor arc changes in the same way that lift does. Lift and drag are both affected by relative wind, so when the lift changes it makes sense that the drag does also, and often in a dissymmetric manner. As the drag increases and decreases, the blade responds by trying to slow down or speed up.

405. PHASE LAG

In a linear system, an applied force causes a displacement. For example, the ball in part A of Figure 4-2, when passing over an air jet, would tend to be deflected in the direction of the applied force. Its maximum displacement would occur at some time after the force was applied.

The same thing happens in a rotational system, but rather than achieving maximum displacement at some linear distance away, the object achieves maximum displacement at some angle away. If the ball observed in part A of Figure 4-1 was put on a string, rotated, and subjected to an air jet it would become displaced. It wouldn't reach maximum displacement immediately, however. It would begin moving up at the point where the force was applied but reach full displacement at some later point.

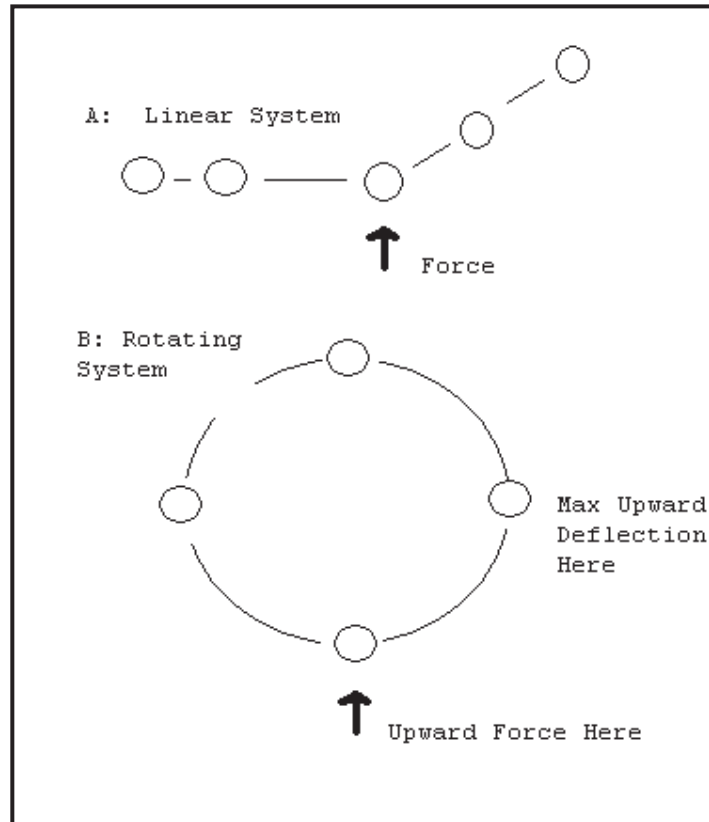

Figure 4-1 Deflections in Linear and Rotating Systems

In part B of Figure 4-1 the maximum displacements are shown to occur 90 degrees after the applied force. This delay in maximum displacement is called phase lag, and is a property of all rotating systems acted on by a periodic force. For a system that is hinged at the axis of rotation the phase lag is 90 degrees. An applied force causes maximum displacement 90 degrees later in the cycle, in the direction of rotation. A system that is hinged at some distance from the axis of rotation (like a fully articulated rotor head) has a phase lag of slightly less.

The key to understanding the relevance of phase lag is to first understand what actually causes the aircraft to pitch or roll. In a semi-rigid rotor system, the single force which causes the helicopter to pitch or roll is the total rotor thrust acting through the **virtual axis (perpendicular to the tip path plane)**, discussed in Chapter 5). As the virtual axis is tilted, the total rotor thrust vector is offset from the aircraft center of gravity and creates a pitching/rolling moment. This is the only significant force causing pitch or roll during most maneuvers. With a trunnion bearing

co-located at the axis of rotation (mast), any asymmetrical force about the trunnion will only tilt the tip path plane and apply no direct force to the mast. Although coupling forces in the fully articulated and 'rigid' rotor systems contribute to maneuvering forces, no force coupling occurs in the semi-rigid main rotor system. Force coupling does occur in the semi-rigid system between total rotor thrust and tail rotor thrust, which will be discussed in Chapter Nine for hover attitude, and as later described for retreating blade stall and uncommanded right roll.

Next, let's examine the mechanism for tilting the total rotor thrust vector. The only way to tilt the virtual axis is to tilt the tip path plane. So how do we tilt the tip path plane? The key here is displacement. The asymmetrical forces applied to a rotating rotor system, whether due to cyclic feathering or due to flapping from dissymmetry of lift, can only affect displacement of the tip path plane. The rotor is not a rigid ring, but rather two blades which periodically experience this asymmetrical force. Phase lag describes the concept that a periodic force applied to this rotating, non-rigid system will cause maximum displacement 90 degrees after the maximum force in the direction of rotation. Helicopter controls apply a force 90 degrees prior to the desired response. For example, to pull the rotor disk up at the 12 o'clock position (nose-up pitch) the blade pitch (and thus the angle of attack and lift) is increased at about the 3 o'clock position and decreased at the 9 o'clock position. To tilt the disk to the right, the blade pitch is increased at the 12 o'clock position and decreased at the 6 o'clock position.

406. PHASE LAG VERSUS GYROSCOPIC PRECESSION

The rotor system is not a gyro; however it sometimes behaves in a way that may be likened to a gyro. Just as an analogy is a comparison based on similarities in some respects between things that are otherwise dissimilar, phase lag in a non-rigid system can be compared to the effects of precession that occur in a rigidly mounted gyroscope. A gyro exhibits gyroscopic precession in response to an applied force, while the rotor system responds 'similarly' using the principle of phase lag discussed in the next section. The phenomenon of precession occurs in rigid rotating bodies that manifest an applied force 90 degrees after the application in the direction of rotation. The force is actually described as causing the rigid body to rotate as if acted upon by a different force 90 degrees later. Although precession is not a dominant force in rotary-wing aerodynamics, aviators must consider it because rotating rigid components may exhibit some of the characteristics of a gyro.

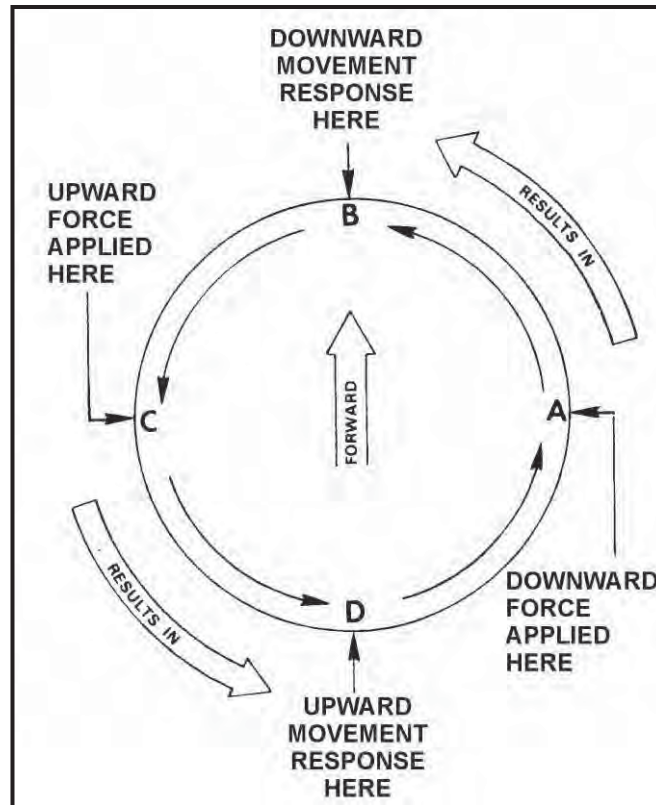

Figure 4-2 Phase Lag

Figure 4-2 illustrates the effects of phase lag on a typical rotor disk when force is applied at a given point. A downward force applied to the disk at point A results in maximum downward movement (displacement) of the disk at point B. The association of a rotor's movement with phase lag and precession stems from similarity to the effects of a force on a gyro rather than its similarity to an actual gyro. Both a gyro and a rotor are circular systems and respond to applied forces somewhat similarly, but through completely separate mechanisms. However, numerous writings and pilots use the terms interchangeably even though they are not the same thing.

407. CONTROL INPUTS

Cyclic and Collective Pitch. Aviator inputs to the collective and cyclic pitch controls are transmitted to the rotor blades through a complex system. This system consists of levers, mixing units, input servos, and stationary and rotating swashplates and pitch-change arms. In its simplest form, the movement of the collective pitch control causes the stationary and rotating swashplates mounted centrally on the rotor shaft to translate vertically (move up and down). The movement of the cyclic pitch control causes the swashplates to rotate (tilt) as if on a gimbal; the direction of tilt is controlled by the direction in which the aviator moves the cyclic. Their unique design allows the swashplates to both elevate and tilt together, effectively changing a non-rotating input to the stationary swashplate into a rotating output from the rotating swashplate.

Cyclic Pitch Change. A change in cyclic stick position causes the rotor blades to change pitch independently about the rotor disk (cyclic feathering). By aerodynamic reaction the blades will climb or descend as they rotate around (Figure 4-3). In this way, the **virtual axis** is tilted in the direction of desired flight. To pass through points A and B, the blades must flap up and down on a hinge or teeter on a trunnion. Although the virtual axis is tilted in the direction of desired flight as previously discussed, control inputs to the rotor system are actually made such that the point of lowest blade pitch in the plane of rotation occurs 90° prior to the direction the virtual axis is tilted.

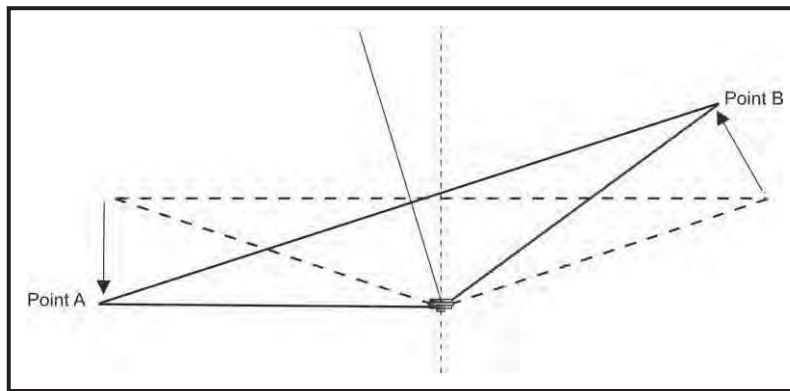

Figure 4-3 Rotor Flapping Due to Cyclic Input

A cyclic movement in one direction decreases blade pitch at the point in the rotor disk 90° earlier while increasing blade pitch by the same amount 90° later. The decrease in lift resulting from a decrease in blade pitch angle and AOA causes the blade to flap down with the blade reaching its maximum down-flapping displacement 90° after lowest blade pitch in the direction of rotation. An increase in lift resulting from an increase in blade pitch angle and AOA causes the blade to flap up; the blade reaches its maximum up-flapping displacement 90° later in the direction of rotation. Figure 4-4 shows the resulting change to the attitude of the rotor disk. The cyclic pitch change causing blade flap must be applied to the blades 90° of rotation before the lowest flap and highest flap are desired. To tilt the rotor disk forward, the lowest cyclic pitch on the blade needs to be over the right side of the helicopter and the highest cyclic pitch over the left side. Phase lag is accounted for when control systems/mixing units are designed and it is ensured that when the cyclic is pushed forward, the action tilts the swashplate assembly to place the cyclic pitch accordingly. The rotor always tilts in the direction in which the aviator moves the cyclic.

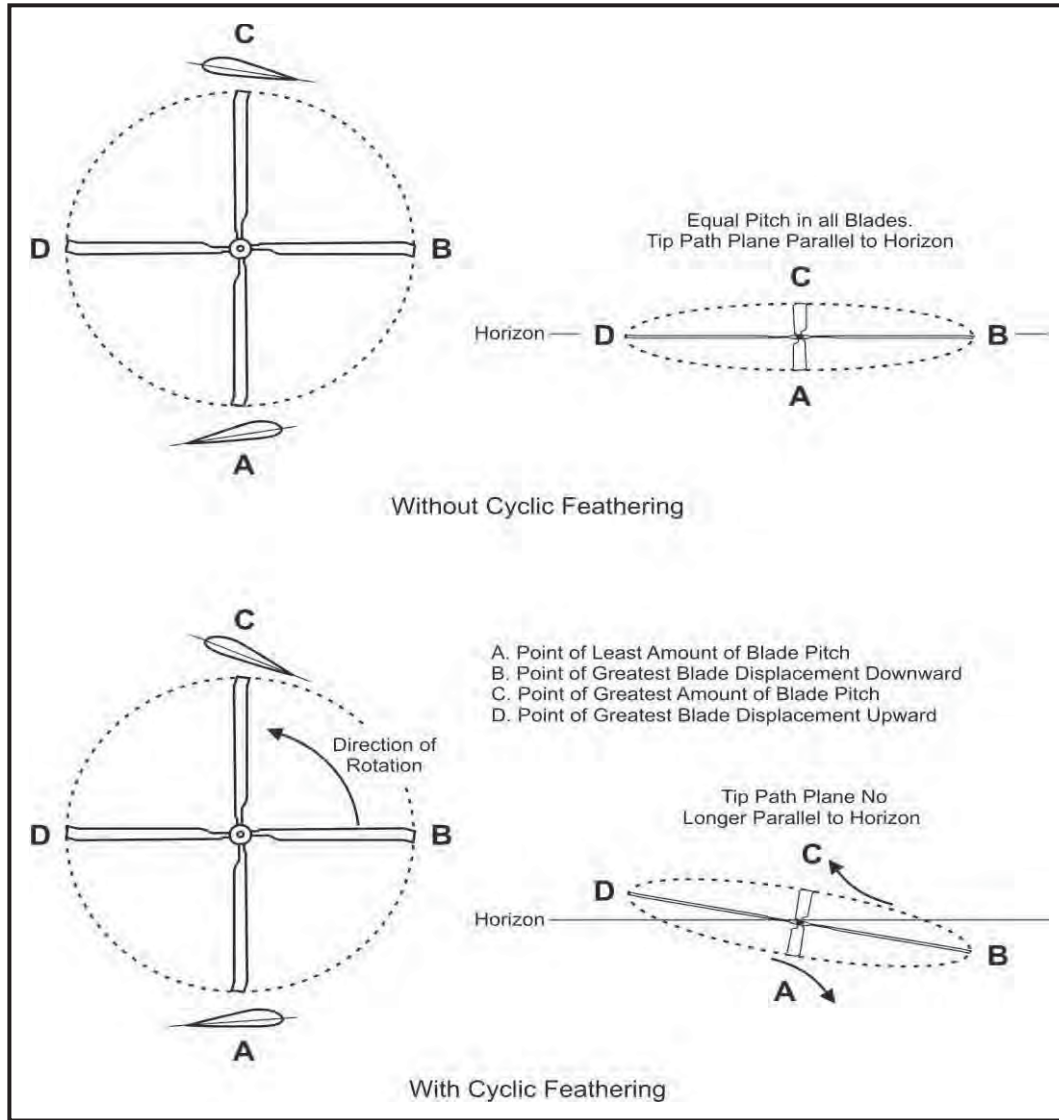

Figure 4-4 Phase Lag

The relationship between cyclic control inputs, flapping and rotor disk response is summarized in Figure 4-5.

Cyclic displacement	Greatest blade pitch, force, and flapping velocity upward	Highest flapping displacement	Least blade pitch, force, and greatest flapping velocity downward	Direction of disk tilt, lowest flapping displacement
Forward	9 O'clock	6 O'clock	3 O'clock	12 O'clock
Right	12 O'clock	9 O'clock	6 O'clock	3 O'clock
Aft	3 O'clock	12 O'clock	9 O'clock	6 O'clock
Left	6 O'clock	3 O'clock	12 O'clock	9 O'clock

Figure 4-5 Relationship Between Cyclic Inputs and Rotor Response

Cyclic Pitch Variation. Figure 4-6 illustrates the typical cyclic pitch variation for a blade through one revolution with the cyclic pitch control full forward. The degrees shown are for a typical aircraft rotor system; the figures would vary with the type of helicopter. With the cyclic pitch control in the full-forward position, the blade pitch angle is highest at the 9 o'clock position and lowest at the 3 o'clock position. The pitch angle begins decreasing as it passes the 9 o'clock position and continues to decrease until it reaches the 3 o'clock position; the pitch begins to increase and reaches the maximum pitch angle at the 9 o'clock position. Blade pitch angles over the nose and tail are about equal.

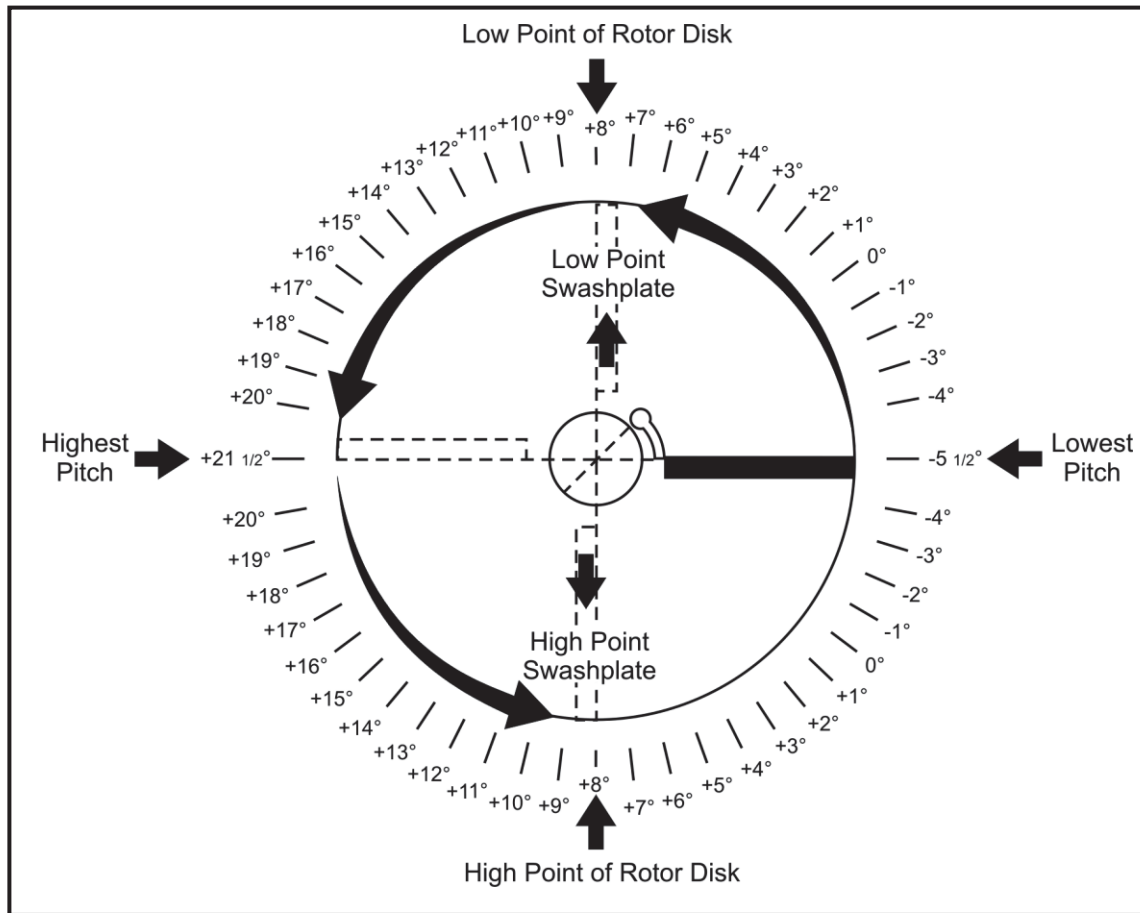

Figure 4-6 Cyclic Pitch Variation-Full Forward, Low Pitch

Figure 4-6 shows that the blades reach a point of lowest flapping over the nose 90° in the direction of rotation after the point of lowest pitch angle. Highest flapping occurs over the tail 90° in the direction of rotation after the point of the highest pitch angle. Simply stated, the force (pitch angle) that causes blade flap must be applied to the blade 90° of rotation before the point where the aviator desires maximum blade flap displacement.

A pattern similar to that in Figure 4-6 could be constructed for other cyclic positions in the circle of cyclic travel. In each case, the same principles apply. Points of highest and lowest flapping will be located 90° in the direction of rotation from the points of highest and lowest blade pitch.

408. CONING

Coning is the upward displacement of the rotating rotor blades due to a combination of aerodynamic (lift) and centrifugal forces. The rotating blades of a helicopter produce very high centrifugal loads on the hub and blade attachment assemblies. In fact, the centrifugal force on the rotor system can be many times the weight of the load actually lifted (Figure 4-7).

In the example, the centrifugal force on a 48,000 pound helicopter is on the order of 80,000 pounds. Centrifugal force plays an important role in flapping, coning blade strength, and blade shape during operation.

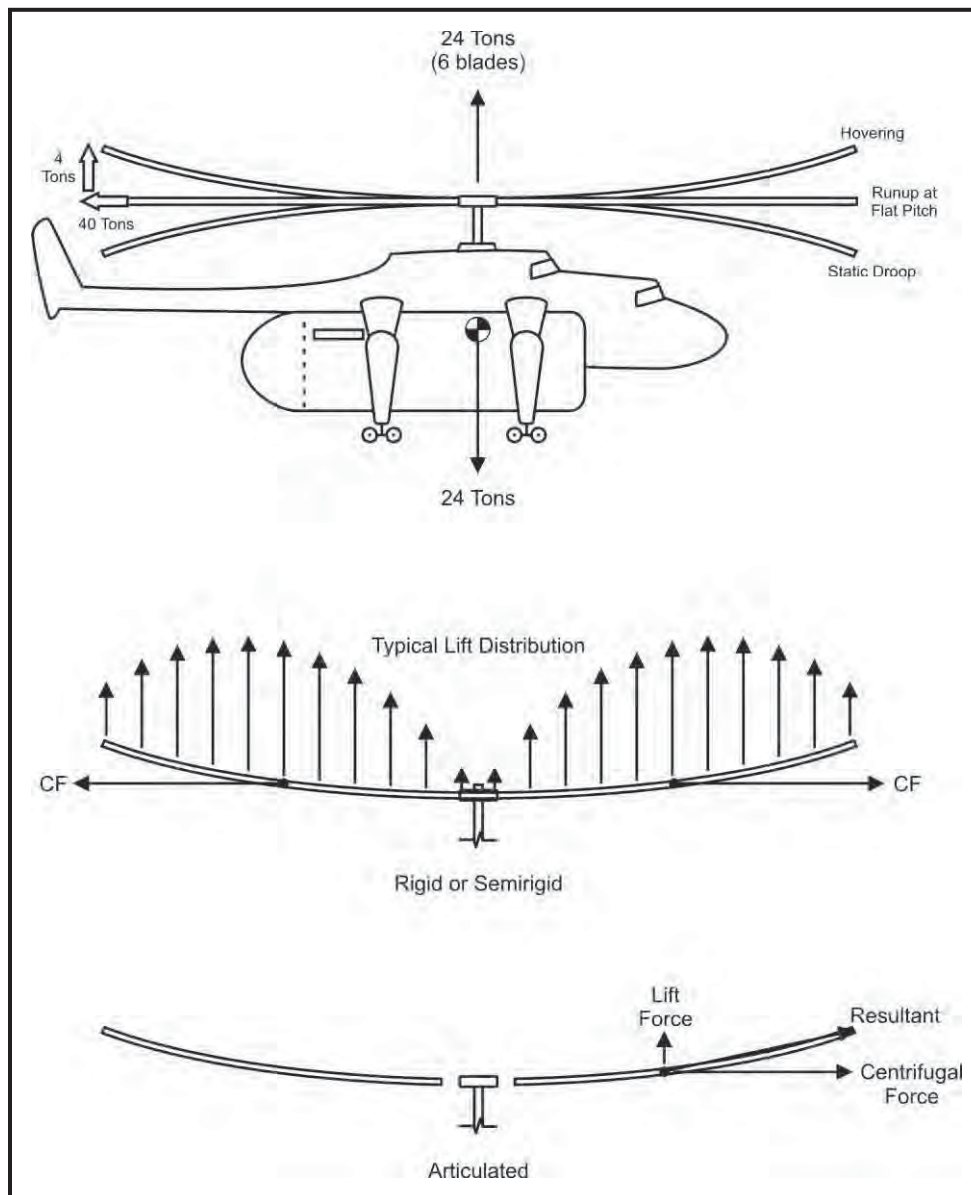

Figure 4-7 Centrifugal Force and Coning

In rotary-wing aircraft, this is the dominant force affecting the rotor system. All other forces act to modify it. As a rotor system begins to turn, the blades begin to rise from the static position because of centrifugal force. At operating speed, the blades extend effectively straight out when the rotor system is at flat pitch (collective full down) and not producing lift. As the aircraft develops lift during takeoff and flight, the blades rise above the straight-out position and assume a coned position. The balance of forces establishes the blade at an angle from the flat plane that is referred to as a **coning angle**. Alteration of lift or centrifugal force establishes a different coning angle. A horizontal force of 40 tons balanced by a lifting force of 4 tons on a given blade would yield a coning angle of $\tan^{-1}(4/40) = 6^\circ$. The amount of coning depends on rpm, gross weight, and G-forces experienced during flight. Excessive coning can occur if rpm is too low, gross weight is too high, an aircraft is flying in turbulent air, or the G-forces experienced are too high. This excessive coning can cause undesirable stresses on the components and a decrease in lift because of a decrease in effective disk area (Figure 4-8).

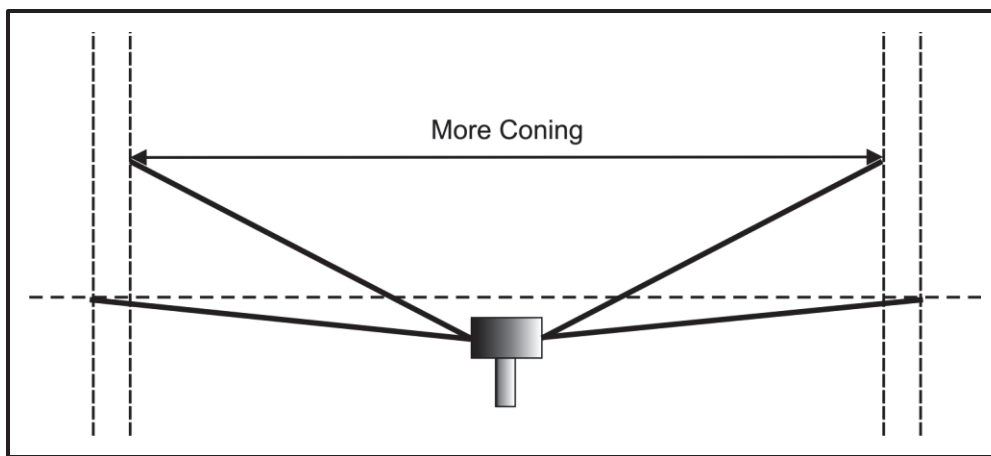

Figure 4-8 Disk Area vs. Coning

If you work out the geometry, coning of 5 or 10 degrees decreases disk area by 0.7% and 3% respectively. If total rotor thrust is to be maintained equal to weight, disk loading must increase proportionally, or if blade pitch is not increased to maintain thrust, total rotor thrust would decrease by a corresponding 0.7% or 3%.

409. GEOMETRIC IMBALANCE

A more dramatic influence on advancing blade and retreating blade speeds is inertial forces that follow the Law of Conservation of Momentum. As a blade flaps, the distance from its CG to the axis of rotation (the mast) is changed. The mast is also described as the mechanical or shaft axis. This movement of the CG causes a **geometric imbalance** in the rotor system. Starting from its original coned position in equilibrium, a blade that flaps up moves its CG (CG - where the weight of the blade seems to be concentrated) toward the center of rotation. A down-flapping blade moves its CG further from the axis of rotation. Figure 4-9 illustrates the changes, with variations exaggerated for clarity.

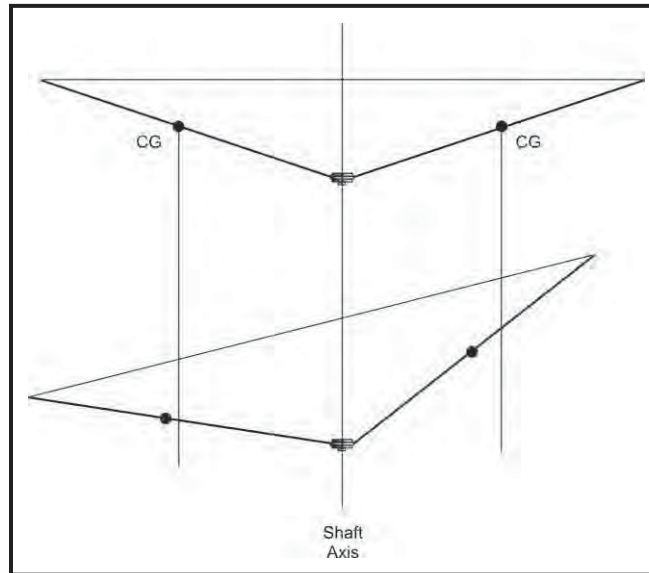

Figure 4-9 CG Shifts with Flapping

Conservation of Angular Momentum dictates that a system will attempt to keep constant momentum as it rotates. The equation for angular momentum is

$$\text{Angular Momentum} = \text{Mass} \times \text{radius}^2 \times \text{angular velocity}$$

The mass of each blade remains constant, so if radius (distance from the axis to the blade CG) changes, angular velocity has to change. Increased radius causes decreased angular velocity and decreased radius causes increased angular velocity. To make these changes the blade will tend to speed up or slow down. If it is not free to do so, it will move as much as it can by bending its structure. This bending force, applied periodically, is felt in the helicopter as a vibration and can be very hard on rotor blade materials not designed to withstand it. The effect which follows the Law of Conservation of Angular Momentum is known as Coriolis effect. Therefore, if a rotor blade flaps up, and the upward flapping causes the blade to speed up as well, the blade is demonstrating Coriolis effect (just as a figure skater in a spin rotates faster if they pull their arms in).

Attaching the rotor blade with a vertical hinge pin permits leading and lagging independent of other blades in the system. This freedom of motion relieves hub stresses associated with conservation of angular momentum and dissymmetry of drag. However, should a blade lead or lag excessively, or get stuck in an extreme position due to a faulty dampener, this geometric imbalance caused by an offset CG may cause severe aircraft damage. The CG of the rotor system as a whole is ideally located at the center of all rotor systems' components and produces the least lateral vibrations when coincidental with the axis of rotation (mast). Geometric imbalance from an offset rotor system CG has been known to destroy an aircraft due to lateral vibrations.

Another way to relieve stresses associated with conservation of angular momentum is

underslinging. Note that the blades represented in Figure 4-10 are attached at the horizontal pivot point (flapping hinge or trunnion bearing). As the left blade would flap up with the CG moving **inward** radially, the opposite blade would flap down, with its CG moving **outward** radially. In addition to the CGs moving in opposite directions radially, the amount of CG shift is clearly large, with both of those factors contributing to geometric imbalance.

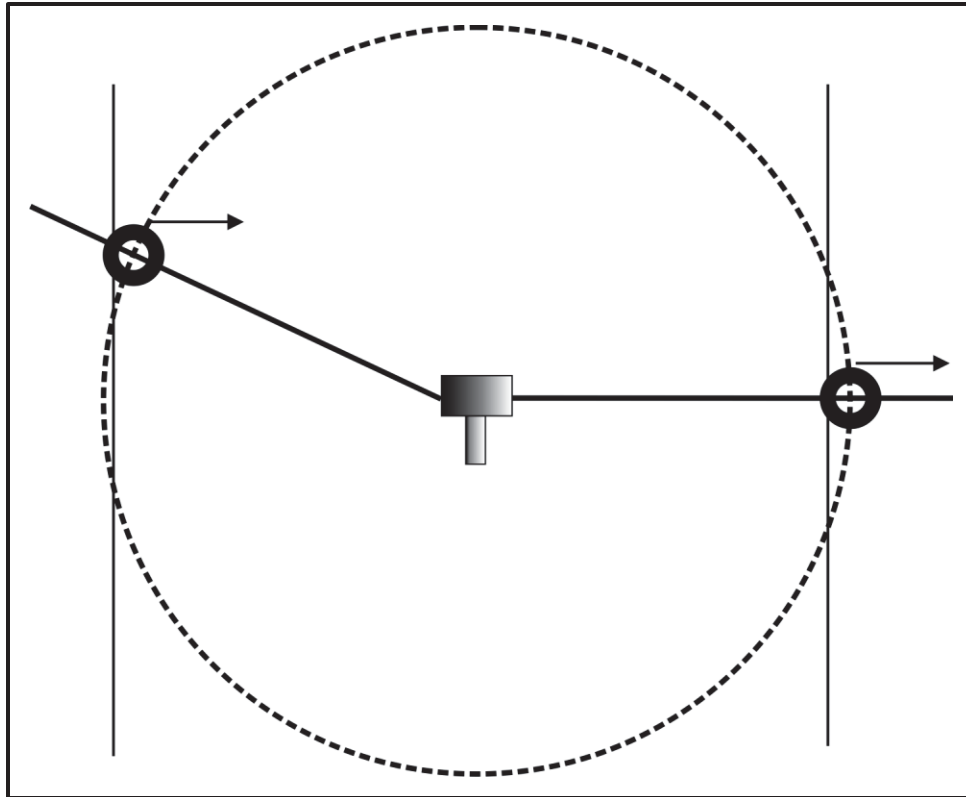

Figure 4-10 Geometric Imbalance

Underslinging is designed to put the blade center of mass level with the flapping (teetering) hinge, under normal operating conditions. As the blades move due to flapping and commanded rotor tilt, each blade center of mass remains approximately the same distance from the axis of rotation (Figure 4-11). The underslung blades have CGs that rotate equally with little radial CG travel. For example, if the blade on the left flaps up, the opposite blade would flap down, with both CGs changing radius from axis of rotation negligibly and in the same direction. Under normal operating conditions, underslinging eliminates the source of geometric imbalance for teetering rotor systems without the need for lead-lag hinges.

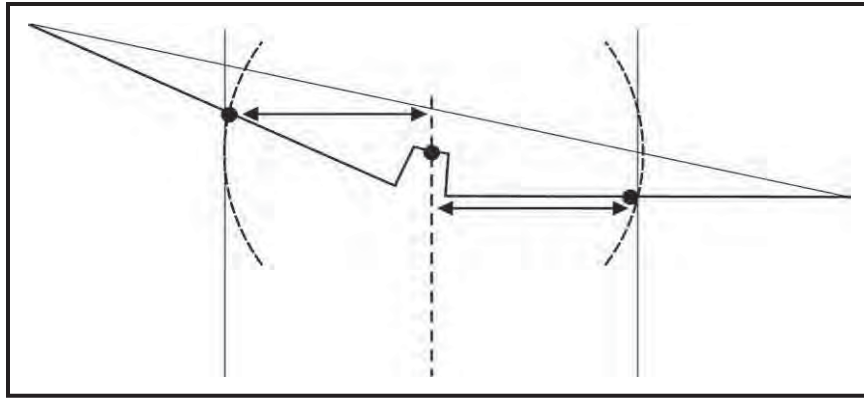

Figure 4-11 Underslinging Compensation for Geometric Imbalance

Because some lead-lag stresses due to dissymmetry of drag are still present in a teetering system, the blade attachment points near the hub tend to be more robust than those of fully articulated rotor heads.

Lastly, the rigid rotor is designed without hinges, but rather with flexible composites that allow for lead/lag and are capable of withstanding the tremendous hub and blade stresses associated with geometric imbalance and rapidly changing aerodynamic forces.

CHAPTER FOUR REVIEW QUESTIONS

1. Unequal radius of rotor blade centers of mass causes _____
_____.
2. The force that tends to pull the rotor blades outward from the hub is called _____.
3. Vertical movement of the rotor blade is called _____.
4. The rotation of rotor blades about their span-wise axis that changes the blade pitch is called _____.
5. Flapping and coning cause the center of mass of a blade to move closer to the rotor hub. This movement of the centers of mass is called _____.
6. As the center of mass of a blade moves closer to the rotor hub, the Law of Conservation of Angular Momentum tells us that the speed of the blade will increase / decrease.
7. Movement of a rotor blade around a vertical hinge pin accounts for the change in speed of the rotor blade and is known as _____.
8. In order to tilt the rotor disk forward, blade pitch must decrease at the _____ and increase at the _____ positions.
 - a. 90
 - b. 360
 - c. 180
 - d. 270

CHAPTER FOUR REVIEW ANSWERS

1. geometric imbalance
2. centrifugal force
3. flapping
4. feathering
5. geometric imbalance
6. increase
7. lead and lag
8. a, d

CHAPTER FIVE AIRCRAFT AND ROTOR SYSTEM DESIGN

500. INTRODUCTION

The purpose of this chapter is to aid the student in understanding aircraft design. Aircraft design considerations include both performance and rotor configuration requirements. Performance criteria for engine, hovering, engine-out, and forward flight, as well as payload and maneuver capabilities will be discussed in later chapters. Main rotor configurations and design options are discussed here, as well as a number of design modifications of interest.

501. LESSON TOPIC LEARNING OBJECTIVES

1. **Terminal Objective:** Partially supported by this lesson topic:

Upon completion of this unit of instruction the student will demonstrate familiarity with various rotorcraft configurations.

2. **Enabling Objectives:** Completely supported by this lesson topic:
 - a. Differentiate between and characterize the three types of rotor systems in use today in Navy/Marine Corps aviation.
 - b. Describe the effects of main rotor torque on the movement of the fuselage about the vertical axis and methods of countering it.
 - c. State the means by which an aircraft with more than one main rotor maintains directional control.

502. REFERENCES

1. Fundamentals of Aerodynamics, NAVAVSCOLSCOM-SG-111
2. Rotary Wing Aerodynamics for Naval Aviators
3. Fundamentals of Flight
4. Helicopter Aerodynamics
5. Helicopter Performance, Stability, and Control

503. STUDY ASSIGNMENT

1. Review Chapter Five.
2. Answer the Review Questions.

504. ROTOR SYSTEMS DESIGN CHARACTERISTICS

The significant difference between the rotary and fixed wing generation of lift is, of course, the fact that rotor blades rotate around a central point. Like any other wing, a rotor blade responds to airspeed, AOA, and air density by generating lift, drag, and possibly a pitching moment. Because of the dynamics of rotation, however, velocity varies from inboard to outboard stations along the blades in all conditions, as well as on either side of the rotor disk in forward flight. Differences in lift that occur as a result of velocity variations make stability and control more complex. The system also must compensate for inertial forces that are generated as a result of rotating the blades about the mast.

Although the popular design option of a single main rotor with a tail-mounted anti-torque rotor has been proven practical over time, there are numerous other options that have been explored with varying degrees of success. The use of multiple counter-rotating main rotors for torque management was actually far more popular than the single rotor in the early years of development. More than two main rotors were used in many different designs. Two main rotors were used in designs varying from the tandem concept popular today, to the less common coaxial, synchropter, and side-by-side designs, which could include tilt-wing and tilt-rotor. Also, the single rotor design itself has resulted in varying tail rotor designs as well as other anti-torque alternatives. The three primary rotor systems are therefore the single main rotor, counter-rotating rotor, and tilt-rotor. Torque balance and control mechanisms for the various systems are discussed in Chapter 6.

In addition to the main rotor system configuration, there are a number of other characteristics that need to be considered. The size, tip speed, number of blades, direction of rotation, and airfoil type are all important issues. In considering airfoil characteristics, inertia, symmetry, twist, taper, compressibility, and solidity are important considerations, and will be discussed later in the text. Even before any of these issues are discussed, the mission of the helicopter needs to be evaluated. Whether the aircraft is to be fast and maneuverable or whether it may be much slower and capable of higher hover efficiency is an important consideration prior to rotor system design. Autorotational capability is another important consideration. Rationale behind some of these main rotor system design decisions follows below.

Size. From momentum theory, it is clear that a constant flow of air is necessary to support the weight of the helicopter during flight. A smaller diameter system may be compact and weigh less, but has to move the same mass of air through a smaller disk area, thus has higher disk loading. A larger diameter rotor (lower disk loading) requires less power in a hover and provides a lower rate of descent during autorotation, but is obviously heavier.

Tip speed. A higher speed reduces required blade area, weight and stall concerns. A lower speed minimizes compressibility and noise concerns with improved hover performance.

Number of blades. The number of blades is selected based on cost and performance. Obviously, fewer blades cost less and reduce rotor weight, but may not provide the performance required. More blades also reduce vibrations and noise signature.

Direction of rotation. This choice has proven to make little difference, except in the case of experienced pilots transitioning from one type to another, primarily due to learned habits associated with pedal control. Americans have chosen a right-side advancing blade while French and Russian designs have chosen a left-side advancing blade. Main rotor design options and many other innovations will be discussed later in the chapter.

505. ROTOR AXIS

When discussing the rotor system, there are three axes used. The first is the **control axis**, a line perpendicular to the plane of the swashplate. The pilot controls the swashplate tilt through the cyclic and the control axis represents where the pilot would like the rotor thrust pointed. The **virtual axis** is defined by the total rotor thrust acting perpendicular to the tip path plane through the head. The disk appears to rotate around the virtual axis. Finally there is the **mechanical or shaft axis**, the physical axis to which the rotor head is attached and the axis it actually turns around, regardless of tilt. The mechanical axis is the mast from the transmission and is aligned closely with the aircraft CG. In a no-wind hover, the three axes could be aligned (Figure 5-1). To maneuver the aircraft the pilot will position the control axis, aerodynamic forces tilt the disk and therefore the virtual axis, creating a moment between the virtual axis and the aircraft CG. This will be discussed further in Chapter 7.

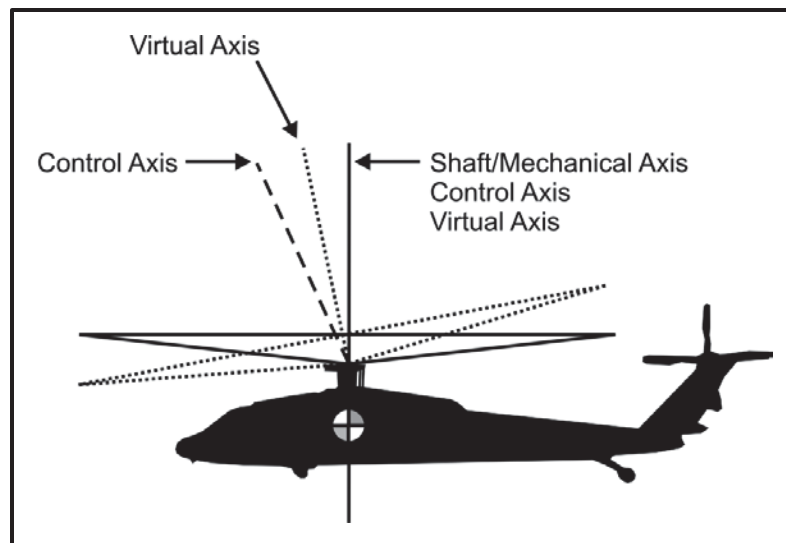

Figure 5-1 Axis of Rotation

506. MAIN ROTOR TYPES

The three kinds of rotor system configurations commonly used in helicopter main rotor design are the semi-rigid, fully articulated, and rigid rotor systems (Figure 5-2). All allow for flapping and compensate for geometric imbalance. These systems allow for pilot control of the rotor blades through use of the cyclic and collective controls.

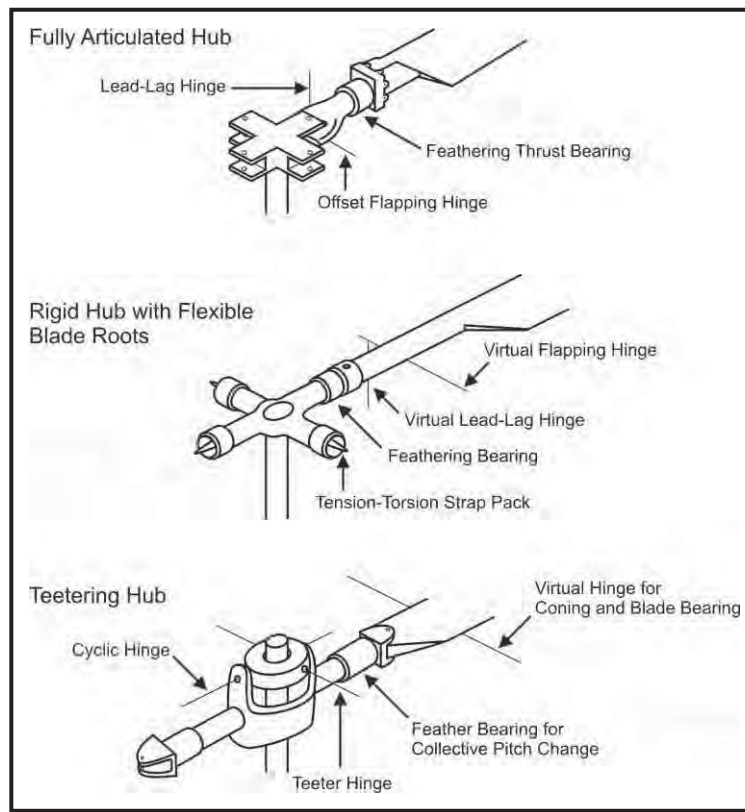

Figure 5-2 Rotor Configurations

The fully articulated rotor system incorporates more than two blades. Lead/lag is possible by use of vertical hinge pins. Horizontal hinge pins allow for flapping. The movement of each blade is independent of the other blades and independent in respect to the rotor head.

The term rigid as applied to rotor systems is generally misleading due to the considerable flexibility in the systems. "Hingeless" may be a better description in most cases. The hub itself bends and twists in order to provide for flapping, lead-lag, and pitch control.

The semi-rigid rotor system uses two rotor blades and incorporates a horizontal hinge pin (trunnion bearing) only for flapping. A semi-rigid rotor system flaps as a unit with the blades moving equally but in opposite directions (i.e., one is flapping up and the other flapping down). Pitch change movement is also allowed. We will spend most of our time investigating this system since it is the type you will become most intimately familiar with first.

Semi-rigid rotor systems are attractive due to their simplicity. They are limited to two blades, have fewer parts to maintain, and do not use lead-lag hinges. So how does the semi-rigid system compensate for geometric imbalance? Remember, the semi-rigid system uses underslinging. This underslung mounting is designed to align the blade's center of mass with a common flapping hinge so that both blades' centers of mass vary equally in distance from the center of rotation during flapping. The rotational speed of the system will vary imperceptibly, but this is restrained

by the inertia of the engine and flexibility of the drive system. Only a moderate amount of stiffening at the blade root is necessary to handle this restriction. Simply put, underslinging effectively eliminates geometric imbalance.

507. SINGLE MAIN ROTOR

The single main rotor design utilizing a tail rotor for anti-torque has been the most common main rotor configuration for over half a century. It was Igor Sikorsky's eighteenth attempt, however, before he settled on this proven concept. Due in part to poor power plants, the previous thirty years of helicopter design produced combinations of multiple main rotors, in an effort that all power could be utilized to provide lift. With the improvement of lightweight materials which reduced the penalty associated with a tailboom, tail rotor drive shaft, gearboxes and rotor system, the benefits of a tail rotor for both anti-torque and directional control were recognized. In a hover, typically 85% of engine power is used to overcome main rotor profile and induced drag, while the remaining power is consumed by tail rotor, accessory drive, and transmission losses.

The single main rotor has a lower induced flow than the coaxial, synchropter, and overlapping tandem designs that are discussed later. The single main rotor may also have fewer moving parts than those necessary with multiple main rotors. The single main transmission may reduce the total weight necessary for the transmission and combining gearboxes of other designs. However, a single main rotor rotating in one direction (counterclockwise when viewed from above for American-made helicopters) imparts a moment on the fuselage which, if left unbalanced, would cause the fuselage to rotate in the opposite direction about the vertical axis (clockwise for American-made helicopters). This moment is compensated for by placing an anti-torque tail rotor a certain distance from the center of gravity of the aircraft.

The tail rotor provides directional control and trim, as well as its anti-torque function, which is augmented by the tailboom and tail fin in forward flight. In a single rotor helicopter, movement of the directional control pedals will vary the collective pitch of the tail rotor blades to do this. Therefore, during a no-wind hover, a pedal turn to the left in the TH-57 would cause the tail rotor to demand more power. Tail rotors and the NOTAR (No Tail Rotor) system for anti-torque are discussed in much more detail in Chapter 6.

508. TIP BOOST

Tip-driven main rotors avoid the requirement for an anti-torque system. The earliest attempts included tip-mounted propellers. Tip-burning jets and rockets were also evaluated. Ramjets were thought to be an ideal propulsion system, due to their high efficiency at the subsonic speeds which main rotor blades are limited to, but noise and problems with autorotational capability proved challenging. The more fuel-efficient pulsejet was also utilized, but proved to be even noisier than the ramjet. Even the potential for hydrogen peroxide rockets was evaluated, but flight endurance was limited.

The pressure jet design was used in the Kellett-Hughes XH-17 Flying Crane which was test flown between 1952 and 1955. Compressed air from the engine was ducted to the rotor tips, mixed with fuel and ignited to drive the rotor blades. Although the design worked and demonstrated a heavy

lift capacity, development of the XH-17 and follow-on XH-28 ceased due to cutbacks in research and development budgets towards the end of the Korean War. No additional development appears to have been done since that time.

509. MULTIPLE MAIN ROTORS

Multiple main rotors turning in the opposite direction solve the problem of torque by maintaining a balance of their opposing moments. Multiple rotor helicopters (tandem, coaxial, and side-by-side, or synchropters) still need to meet the demands of induced power, profile power, and accessory loads, but do not expend power through a tail rotor. This may lead one to conclude that more of the engine’s power can be used to generate lift. Unfortunately, tests of tandem and coaxial helicopters have shown that power requirements do not significantly improve with such approaches. The reason is the deleterious effects of airflow interference discussed below.

Flow from one rotor disk affects the flow from another, and reduces efficiency to the point that induced power rises significantly (Figure 5-3). Spacing the rotor discs closer together (reducing S_1 , the mast separation) increases the interference and associated power drain.

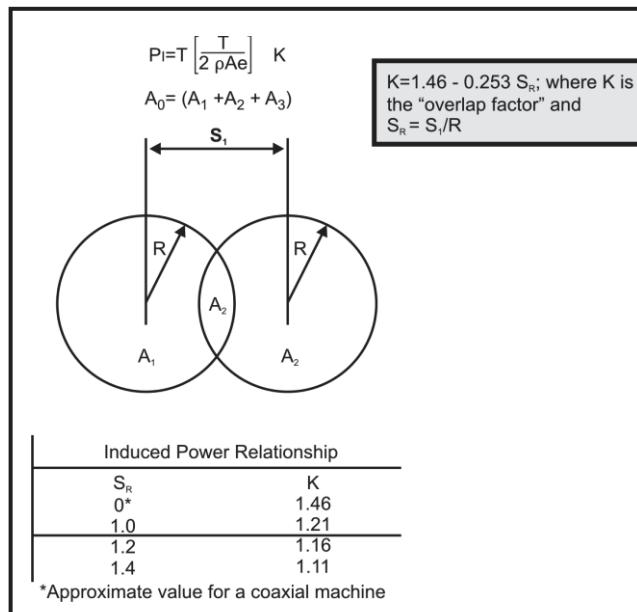

Figure 5-3 Flow Effects from Overlapping Rotors

As an example, using the table in Figure 5-2, a CH-46E has the following increased power requirements:

Example: CH-46E

$S_1 = 33'4"$, $R = 25'6"$, $S_1/R = 1.3 \rightarrow K \cong 1.13$, what this means is that compared to a similar single rotor machine, the tandem requires about 10-15% more induced power. Coincidentally, a single rotor helicopter uses between 5% and 15% additional power to operate the tail rotor. There are other operating limitations, however, that may make use of a tandem rotor helicopter preferable for some missions, among them greater CG operating limits and less sensitivity to wind direction.

5-6 AIRCRAFT AND ROTOR SYSTEM DESIGNS

510. TANDEM ROTOR DESIGN

The tandem rotor design places one horizontal main rotor behind the other, turning in opposing directions. The opposing torques applied by an even number of equally sized multiple main rotors turning in opposite directions counteract each other. Torque effect will be discussed further in Chapter 6. Although the pilot will apply cyclic, collective, and pedal inputs like any other helicopter, the controls are linked in somewhat different ways to each of the two main rotor systems to produce the desired effect.

The collective control works similar to any other helicopter, applying collective feathering (blade pitch inputs) equally and collectively to both main rotors. Similarly, the cyclic control applies the usual cyclic feathering to bank the aircraft laterally, whether in flight or at a hover.

However, the cyclic control applies differential collective pitch to the front and rear rotor, to change the pitch attitude of the aircraft, with a change in pitch attitude still providing a horizontal component to the total thrust vector to accelerate or decelerate the aircraft.

The pedals apply differential (opposite) cyclic feathering inputs to each of the two rotor systems. A left hovering turn is therefore produced by the forward rotor tilting to the left while the rear rotor tilts to the right, and conversely for a right hovering turn.

Like most other systems, in tandem-rotor helicopters, the forward and aft rotor systems are tilted forward because of the transmission mounting design. This tilt helps to decrease excessive nose-low attitudes in forward flight. Most tandem-rotor helicopters hover at a nose-high attitude of about five degrees. Some models will automatically compensate for this nose-high attitude through automatic programming of the rotor systems.

511. COAXIAL ROTOR DESIGN

Coaxial helicopters also do not need a tail rotor because the two rotors turn in opposite directions and cancel out each other's torque. All of the engine power is therefore available to produce lift, albeit airflow interference ($K = 1.46$) is at its greatest due to a mast separation (S_1) of zero (Figure 5-3). One rotor is located on top of the other. Depending on which rotor produces more lift, the helicopter will turn to the left or right because of the torque. Helicopters originally designed with this configuration could not reach a high cruising speed because the drag was too large. Only after the development of the rigid rotor was it possible to build the two rotors closer together and reduce the drag considerably. Counter-rotation in coaxial helicopters does carry a weight penalty of requiring more complex gearboxes and swashplates.

The original Coaxial ABC (Advancing Blade Concept) helicopter had two-speed rotors. The slower speed in cruise was necessary so that the advancing blade tip would not approach the speed of sound. Retreating blade stall was also alleviated somewhat because there was no longer the necessity to send the retreating blade to high AOA as the other rotor's advancing blade was accounting for dissymmetry of lift. As the next-generation ABC aircraft are currently being tested, many innovative developments have been incorporated to address previous limitations. The Sikorsky X2 Technology Demonstrator conducted its first test flight in August 2008. It incorporates the counter-rotating coaxial rotor design with a pusher propeller (Figure 5-4).



Figure 5-4 Sikorsky's X2 TECHNOLOGY™ Demonstrator

512. SYNCHROPTER DESIGN

The twin-rotor synchropter is a system with two rotors that mesh into each other, much like a gearwheel. Like the tandem rotor, this configuration doesn't need a tail rotor because the torque is compensated for by the opposite rotation of the rotors. This system was developed during the early days of helicopter flying but fell into disuse. Today, this kind of rotor arrangement is used with the Kaman K-MAX, a single-seat helicopter mainly used for external load transportation. Synchropters are in many ways like the coaxial design, but a few differences exist. When the blades are set at autorotative AOA during the autorotation of an intermeshing type synchropter, the yawing moments created by side flow through the rotors create an unstable yaw moment. This has been corrected by the addition of more stabilizer area, commonly two large vertical fins.

513. TILTROTOR / TILTWING

As the name implies, it uses tiltable engine and propeller assemblies, or **proprotors**, for lift and propulsion. For vertical flight the proprotors are angled upright to direct their thrust downwards, providing lift. In this mode of operation the aircraft is essentially identical to a helicopter. As the aircraft gains speed, the engines/proprotors are slowly tilted forward, eventually aligning themselves as in a conventional twin turboprop aircraft. In this mode the wing provides the lift, and the wing's greater efficiency helps the tiltrotor achieve its high speed. To land in the turboprop configuration, however, the proprotors must be tilted upward partially for ground clearance.

In vertical flight, the tiltrotor uses controls very similar to a twin or tandem-rotor helicopter. Yaw is controlled by tilting its rotors in opposite directions. Roll is provided through differential power or thrust. Pitch is provided through rotor cyclic or nacelle tilt. Vertical motion is controlled with conventional rotor blade pitch and either a conventional helicopter collective

control lever (as in the Bell/Augusta BA609) or a unique control similar to a fixed wing engine control called a thrust control lever (TCL) (as in the Bell-Boeing V-22 Osprey).

The tiltrotor's advantage is significantly greater speed than a helicopter. In a helicopter the maximum forward speed is defined by the tip speed of the advancing and retreating rotor blades due to retreating blade stall. This limits modern helicopters to cruise speeds of about 150 knots. However, in a tiltrotor, retreating blade stall is alleviated by using the rotors as propellers in high-speed flight. The proprotors are perpendicular to the flight path in the high-speed portions of the flight regime and thus never suffer this reverse flow condition. Therefore, the tiltrotor has relatively high maximum speed – over 340 knots has been demonstrated in the two types of tiltrotors flown so far, and cruise speeds of 250 knots (460 km/h) are achieved easily. Turboprop speeds are limited to about 400 knots by propeller tip compressibility losses.

514. DESIGN MODIFICATIONS

In addition to the many options for main rotor design, there have been many other designs tested to improve flight performance. Some of these include stabilizer bars, blade dampers, droop stops and folding blades discussed in other parts of the text. The Sikorsky S-76D for example, incorporates a dual-speed rotor system with active vibration control to improve performance and reduce rotor noise. Propulsion devices have also been developed, and will be discussed below.

515. PROPULSION DEVICES

The large forward horizontal force required to overcome parasite drag at high speeds is conventionally provided by a pronounced forward tilt of the disk. The use of auxiliary propulsion devices has been shown to decrease the tilt necessary, also decreasing the onset of retreating blade stall and power required to the main rotor.

Numerous experimental and production alternatives have been developed, including jet engines attached on each side of a UH-1 and other aircraft, the pusher prop on the Cheyenne and the X2 as previously mentioned, as well as those of the NOTAR and the British Lynx, which set the conventional helicopter speed record.

The early NOTAR had a gimbaled nozzle on the tailboom, normally directed for anti-torque at a hover, but available for thrust in forward flight. An extra 700 HP from the Lynx engine, which is limited by the transmission, is exhausted through a converging nozzle yielding 600 lbs of thrust, so this aircraft, while being quite fast, could not establish a steady-state hover.

On the drawing board are plans for an X-WING design, which also requires auxiliary propulsion. Retreating blade stall and compressibility effects are alleviated by using an elliptical airfoil shape that employs circulation control for "pitch" change, a wing, and engines for high-speed propulsion.

THIS PAGE INTENTIONALLY LEFT BLANK

CHAPTER FIVE REVIEW QUESTIONS

1. The resultant upward displacement of the rotor blades due to _____ and _____ is called coning.
2. The type of rotor system which is limited to two rotor blades is the _____.
3. The _____ rotor system does not incorporate mechanical hinges for flapping or lead/lag motion.
4. A vertical hinge pin is provided for lead/lag in the _____ rotor system.
5. Compensation for lead/lag motion in the semi-rigid rotor system is accomplished by blade _____.
6. In a hover, typically 85% of engine power is used to overcome main rotor profile and induced drag, while the remaining power is consumed by _____, _____, and _____.
7. In a single rotor helicopter, movement of the directional control pedals will
 - a. vary rpm of the tail rotor
 - b. vary the collective pitch of the tail rotor blades
 - c. tilt the tail rotor
 - d. control the aircraft movement about the pitch axis
8. During a no-wind hover, a pedal turn to the _____ in the TH-57 would cause the tail rotor to demand _____ power.
 - a. right ... less
 - b. right ... more
 - c. left ... less
 - d. right ... the same
9. A system having an even number of rotor systems of the same mass and design, rotating in opposite directions
 - a. is not as efficient as tail rotor helicopters
 - b. cannot control movement about the vertical axis
 - c. is effective because the rotor systems operate at different speeds
 - d. is effective since both torque effects balance each other out

CHAPTER FIVE REVIEW ANSWERS

1. centrifugal force . . . blade lift
2. semi-rigid
3. rigid
4. fully-articulated
5. underslinging
6. tail rotor, accessory drive, and transmission losses
7. b
8. a
9. d

CHAPTER SIX TAIL ROTOR DESIGN

600. INTRODUCTION

The purpose of this chapter is to aid the student in understanding tail rotor design. Tail rotor design considerations include both performance and rotor configuration requirements. The discussion of tail rotor effects in this chapter will focus upon American standard main rotor rotation direction for simplicity. Tail rotor configurations and design options and individual blade actions are discussed here in detail, as well as a number of design modifications of interest.

601. LESSON TOPIC LEARNING OBJECTIVES

1. **Terminal Objective:** Partially supported by this lesson topic:

Upon completion of this unit of instruction the student will demonstrate familiarity with various rotorcraft configurations and airfoil design considerations.

2. **Enabling Objectives:** Completely supported by this lesson topic:
 - a. Describe effects of main rotor torque on the movement of the fuselage about the vertical axis and methods of countering it.
 - b. State the means by which an aircraft with more than one main rotor maintains directional control.

602. REFERENCES

1. Fundamentals of Aerodynamics, NAVAVSCOLSCOM-SG-111
2. Rotary Wing Aerodynamics for Naval Aviators
3. Fundamentals of Flight
4. Helicopter Aerodynamics
5. Helicopter Performance, Stability, and Control

603. STUDY ASSIGNMENT

1. Review Chapter Six.
2. Answer the Review Questions.

604. TORQUE EFFECT

For purposes of uniformity, conventional main rotor direction is chosen to be counterclockwise as viewed from above. A single main rotor imparts a moment on the fuselage which, if left unbalanced, would cause the fuselage to rotate clockwise around the vertical axis. This moment is compensated for by placing an anti-torque tail rotor a certain distance from the center of gravity of the aircraft. The thrust of the anti-torque tail rotor multiplied by the distance to the CG results in a moment in the opposite direction to that generated by the main rotor. If the forces and moments involved are considered in combination, however, as in Figure 6-1, it is apparent that the moments balance but the forces do not. The unbalanced force of the tail rotor causes a right **translating tendency** that is most noticeable in a hover and occurs to a lesser extent in forward flight. This will be discussed later in the chapter and in Chapter 9 Hovering Flight. Additionally, any change in power setting will change the torque and therefore yaw. The effects of wind on the tail rotor's effectiveness must also be considered if the helicopter is to be usable in a wide range of operating conditions.

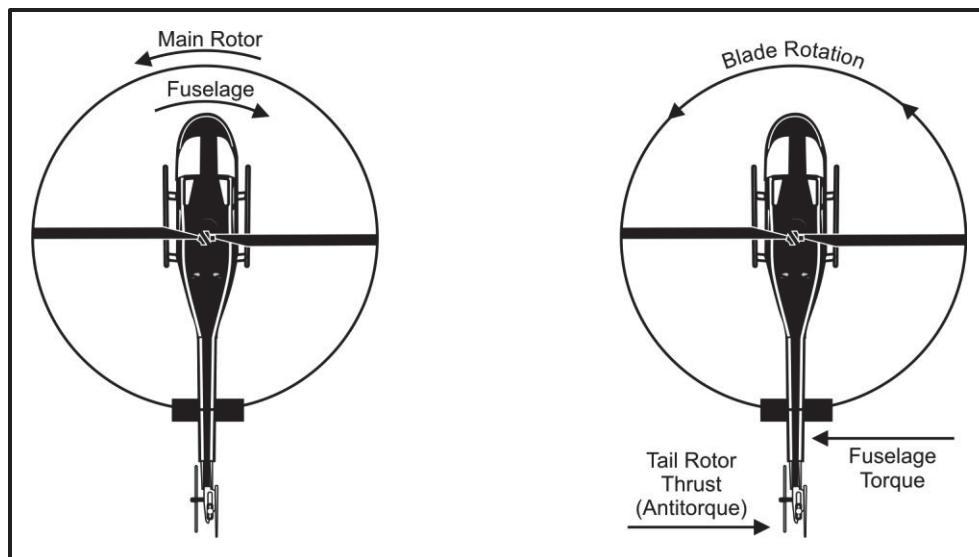

Figure 6-1 Tail Rotor Unbalanced Force

Pilots of helicopters with a clockwise rotation (and thus a left main rotor moment) simply need to consider the effects in the opposite direction. Again, NOTAR, tip boost, or the opposing torques applied by an even number of equally sized multiple main rotors turning in opposite directions may also be used to counteract this effect.

Figure 6-2 below illustrates the method of torque balance and directional control for both the tail rotor configuration and alternate methods.

6-2 TAIL ROTOR DESIGN

Helicopter Configuration	Torque Balance	Directional Control
		Yaw Moment
Single MR, TR	TR Thrust	TR Collective
Coaxial	MR diff torque	MR diff collective
Tandem	MR diff torque	MR diff cyclic
Side-by-side	MR diff torque	MR diff cyclic

Figure 6-2 Yaw Control Mechanisms for Various Configurations

605. TAIL ROTOR DESIGN

Installation of a tail rotor solves the problem of countering main rotor torque. Conventional tail rotors have proven effective over time due to the production of adequate yaw control at the expense of very little power. A tail rotor must balance the main rotor torque at full power with enough thrust to still provide directional control. The tail rotor must also provide adequate yaw control in autorotation. The principle behind the operation of the standard configuration is fairly simple. There are, however, several configurations and design issues to be considered. The size, tip speed, airfoil, number of blades, spacing, direction of rotation, cant, and whether to select a tractor or pusher are all issues of concern.

Size – A smaller diameter system reduces weight and center of gravity concerns, as well as ground clearance. A larger rotor requires less power to counter main rotor torque.

Tip speed – Similar to the main rotor, a higher speed reduces blade area, weight and stall concerns. Lower speed minimizes compressibility and noise concerns.

Airfoil – The size and shape of the airfoil depend on whether the benefits of camber outweigh the simplicity of symmetry. Because the tail rotor is so much shorter than the main rotor, a more cambered airfoil might be chosen.

Number of blades – Once the desired shape and size of the airfoil is determined, the number of blades is selected based on cost and performance. Obviously, fewer blades cost less, but may not provide the performance required.

Spacing - Blades may be spaced in different ways. For example, the H-60 has four blades spaced equidistant and in the same plane, while the AH-64 Apache has two pair of blades offset both more acutely and in different planes.

Thrust direction – While it may not be obvious, tail rotors are designed to provide thrust in both directions. During power-off flight (autorotation for example) when no torque is available from the rotor system, the tail rotor must be able to provide thrust in both directions for heading control. The TH-57 tail rotor tail blade pitch limits are approximately 20° left and 10° right of neutral, thus it can produce thrust to push the tail in either direction if needed. However, since it

is not equal (since most flight is powered and requires more T/R thrust), “centered pedals” are actually producing a right thrust force since the mid-point would be approximately 5° left pitch.

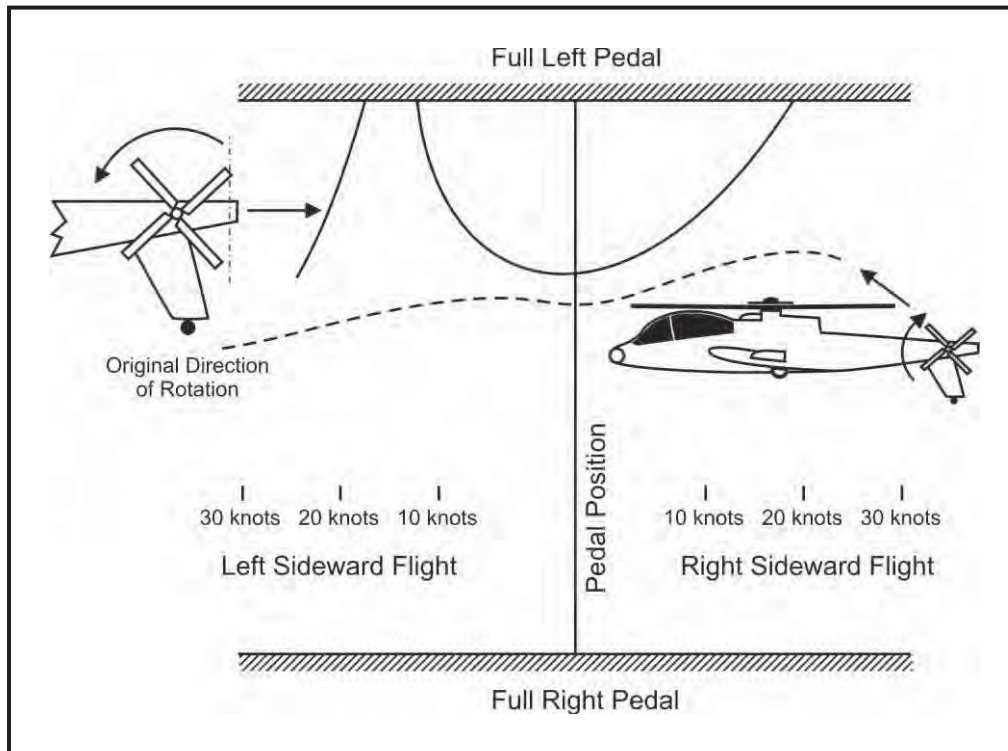

Figure 6-3 Impact of Tail Rotor Direction

Direction of rotation – Many helicopters were initially designed with a tail rotor that rotated with the top of the tail rotor (blade closest to the main rotor) moving forward. The reasoning was that during low altitude operations less debris would be kicked forward by the advancing blade. In test, however, developers discovered that such an arrangement produced problems with left pedal effectiveness in left sideward flight. When the designers reversed the direction of rotation a marked improvement in performance occurred and the designers also benefited from less noise from the tail rotor due to this direction of rotation. The influence of direction of rotation on pedal position is demonstrated by the test results shown in Figure 6-3 for the Cheyenne helicopter. In the figure, lines indicate how much pedal throw was required during left and right sideward flight with each tail rotor rotation direction on a developmental helicopter. The depicted results indicate that the effect of rotation direction was dramatic, even to the point of showing a lack of adequate tail rotor control authority in left sideward flight with the top-forward rotation. The reason for this phenomenon is ingestion of the main rotor’s tip vortices by the tail rotor. Rotating the blades clockwise when viewed from the aircraft’s left side (right side of figure 6-3) moved the most important lift-producing segments of the tail rotor disk far enough away from main rotor vortex impingement to improve performance significantly.

Cant – Because of geometric advantage, a tail rotor can be canted and provide a significant lift component. For example, a thirty-degree cant would only reduce the anti-torque force 13% to 87% of thrust, yet provide 50% of that thrust to aircraft lift production. Thus far, designers have gone no further than approximately twenty degrees to provide adequate torque and stability.

6-4 TAIL ROTOR DESIGN

Pusher or puller (tractor) - The amount of interference the tail rotor experiences depends on which side of the vertical fin the tail rotor operates. A pusher, as shown in Figure 6-4, draws air past the vertical fin and a tractor blows air onto the vertical fin (airflow from right to left). For the American type of main-rotor rotation, the pusher is mounted on the left side of the fin and the tractor on the right. The pusher-type mounting forces less high velocity air onto the vertical fin, so it has less associated interference effects; however, the vertical fin itself can restrict airflow into the tail rotor blades. Some helicopters have a cutout in the vertical fin to allow the air to flow more freely. For other reasons, however, including ground clearance on canted rotors and placement of control mechanisms, many designers choose to accept the relatively small losses associated with a tractor-type mount.

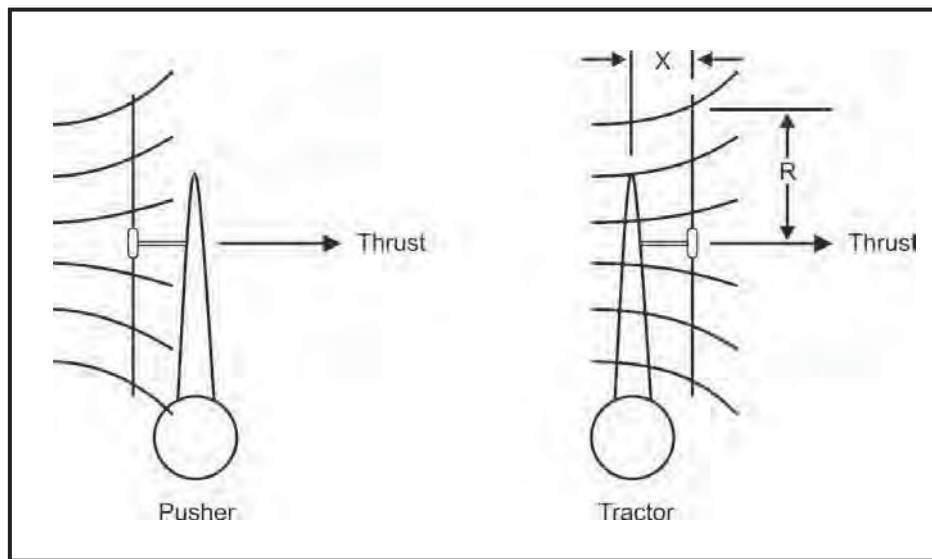

Figure 6-4 Tail Rotor Configurations

Use of a ducted fan instead of a tail rotor – Some designers have chosen to use a ducted fan (fenestron) that is imbedded in the tail to generate thrust, rather than the traditional tail rotor. Such an arrangement offers many advantages (at the possible expense of added weight). A ducted fan is shielded by the surrounding structure from forward-flight generated winds. This negates the dissymmetry of lift problem. It also tends to be quieter (depending on speed and blade layout) because the fan generates little, if any, tip vortices and is shielded from interaction with the main rotor's vortices. Additionally, the fan operates efficiently because it has reduced tip losses and pressure effects on the lip of the shroud help draw in air. The performance benefit realized as a result allows designers to use a fenestron that is 30% smaller than a conventional tail rotor yet produces the same effect. Finally, a shrouded tail rotor provides improved safety for personnel operating around the aircraft on the flight line while the aircraft is turning.

Tail rotor flapping – Just like the main rotor, the tail rotor experiences dissymmetry of lift between the advancing and retreating blades. The difference is that the advancing blade is on "bottom" and the retreating blade is on the "top" (depending on direction of tail rotor rotation). This dissymmetry must be counteracted by a flapping hinge. Designers have built in a hinge that changes blade pitch as the tail rotor blade flaps. It is called a **delta-three hinge**, and it differs

from a normal attachment, as shown in Figure 6-5, by having an angled attachment point or pitch change links mounted at an angle, depending on the manufacturer. As a blade attached to a delta-three hinge flaps up, the hinge attachment pulls on the pitch change rod to generate a decrease in pitch angle. Likewise, during a downward flap the attachment point pushes up to increase pitch. The result is increased flapping effectiveness and reduced magnitude of flapping to accomplish the same effect. **The TH-57 uses a delta-three type tail rotor design.**

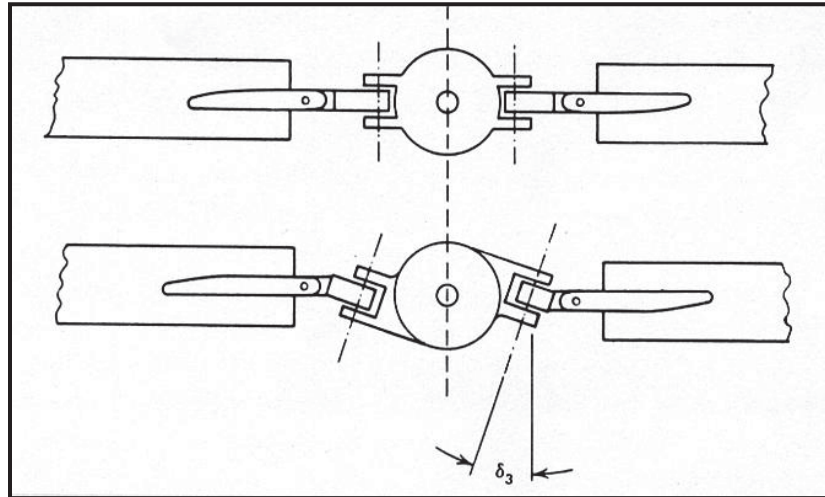

Figure 6-5 Plain Flapping Hinge and Delta-Three Hinge

Left and right hand turns – One characteristic of tail rotors that pilots may notice in-flight is their effect on main rotor power requirements. In some helicopters, rpm builds in a right hand turn and decreases in a left hand turn. In a right turn the requirement for anti-torque decreases because the aircraft is turning in a direction that it tends toward naturally. Due to main rotor moment, the power that was going to the tail rotor before the turn is no longer required, so it goes to the main rotor and rpm increases. The opposite is true in the case of left turns. Another way to think about this is that the tail rotor is similar to the main rotor system. Since the tail rotor is subject to the same drag forces, power is required to overcome these forces. Therefore, different pitch angles on the tail rotor blades require different power settings. As pitch angle is increased (left pedal), power required will increase.

Other methods of anti-torque control - The conventional tail rotor design is the simplest solution to the anti-torque problem, but other solutions exist. Approaches used to date include tandem counter-rotating rotors, coaxial counter-rotating rotors, side-by-side counter-rotating rotors, and use of high velocity air in a NOTAR (no tail rotor) design.

606. NOTAR (NO TAIL ROTOR)

An innovative anti-torque system for the single main rotor helicopter without the use of a tail rotor has been appropriately labeled the NOTAR system, using circulation theory principles discussed in Chapter 2.

6-6 TAIL ROTOR DESIGN

Using the natural characteristics of helicopter aerodynamics, the **NOTAR** anti-torque system provides safe, quiet, responsive, FOD-resistant directional control. The enclosed variable-pitch composite blade fan produces a low pressure, high volume of ambient air to pressurize the composite tailboom. The air is expelled through two slots which run the length of the tailboom on the starboard (right) side, causing a boundary-layer control called the “Coanda Effect.” The result is that the tailboom becomes a “wing,” flying in the downwash of the rotor system, producing up to 60 percent of the anti-torque required in a hover. The balance of the directional control is accomplished by a rotating direct jet thruster (Figure 6-6).

In forward flight, the vertical stabilizers provide the majority of the anti-torque, however directional control remains a function of the direct jet thruster.

The **NOTAR** anti-torque system eliminates all of the mechanical disadvantages of a tail rotor, including long drive shafts, hanger bearings, intermediate gearboxes and ninety-degree gearboxes.

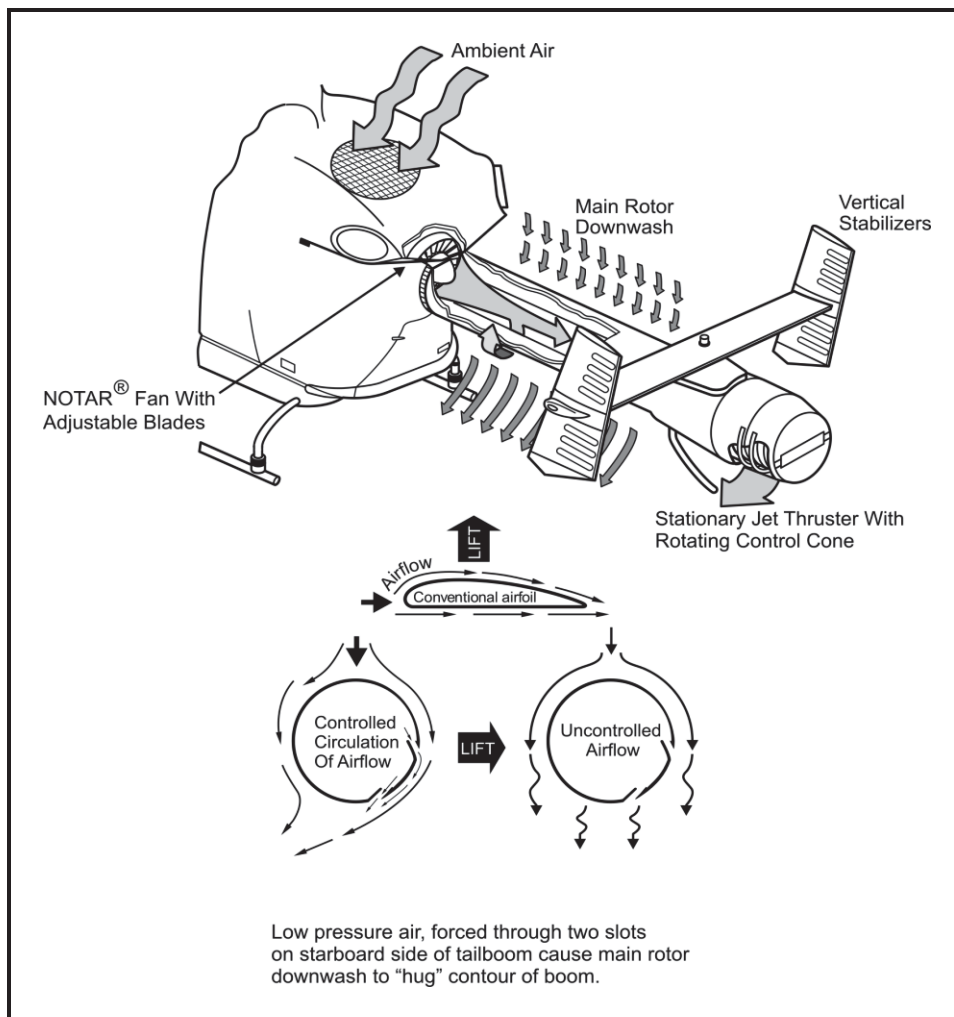

Figure 6-6 NOTAR Anti-torque System

Another method that uses this aerodynamic principle was developed by BLR (Boundary Layer Research) Aerospace and has been tested by NASA on Bell 204B and New Zealand UH-1H aircraft. Used in combination with a standard tail rotor configuration, this latter technique, instead of accelerating the flow on the right side of the tailboom, disrupts the flow on the left hand side through the use of tailboom strakes to produce the same effect and reduce tail rotor loading.

In addition to civilian helicopters, the Navy and Marine Corps has evaluated these products for use on the UH-1 and AH-1 aircraft.

607. VERTICAL STABILIZER

A vertical stabilizer can help quite a bit in reducing the amount of tail rotor thrust required in forward flight. Shaped like a wing, a vertical stabilizer provides lift (thrust) in the direction of anti-torque (Figure 6-7). The vertical stabilizer can be either a cambered airfoil or a symmetrical airfoil mounted on an offset angle, as is the case on the TH-57. The higher the aircraft's velocity, the more the vertical stabilizer will be contributing to the anti-torque effort. At higher speeds, tail rotor power requirements are significantly reduced, therefore more engine power is now available to drive the main rotor system.

Design tradeoffs have precluded the production of any military helicopters that can actually fly in level, balanced flight with a complete tail rotor failure because of the power interactions between the tail rotor and vertical fin. Making a large enough tail fin that could completely compensate for a lost tail rotor would compromise sideward flight capability. The Apache and Blackhawk, however, were designed to be able to fly straight in a controlled descent (at a specified airspeed) without the tail rotor operating.

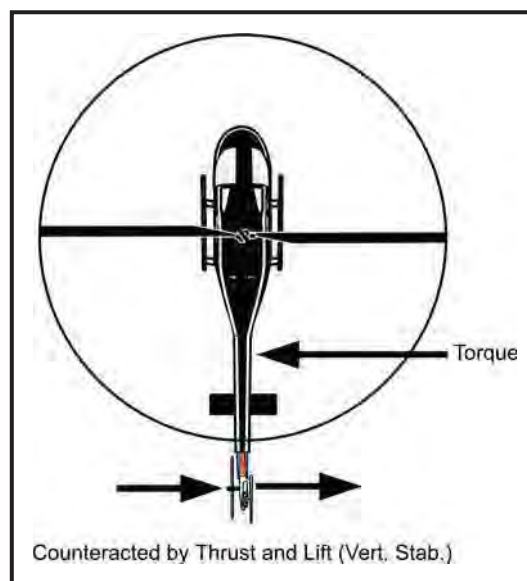

Figure 6-7 Vertical Stabilizer

6-8 TAIL ROTOR DESIGN

608. TRANSLATING TENDENCY AND HOVER ATTITUDE

While the tail rotor system produces anti-torque effect, it also produces thrust in the horizontal plane, causing the aircraft to drift right laterally in a hover (Figure 6-8), for a counterclockwise rotating, single-rotor helicopter. The aviator must compensate for this right **translating tendency** of the helicopter by tilting the main rotor disk to the left. This lateral tilt creates an equal but opposite main rotor force to the left that compensates for the tail rotor thrust to the right. These two horizontal forces, however, are often offset from each other vertically. The main rotor force to the left coupled with the tail rotor force to the right commonly causes a left skid low hover attitude during flight. Both translating tendency and hover attitude are discussed in much more detail in Chapter 9.

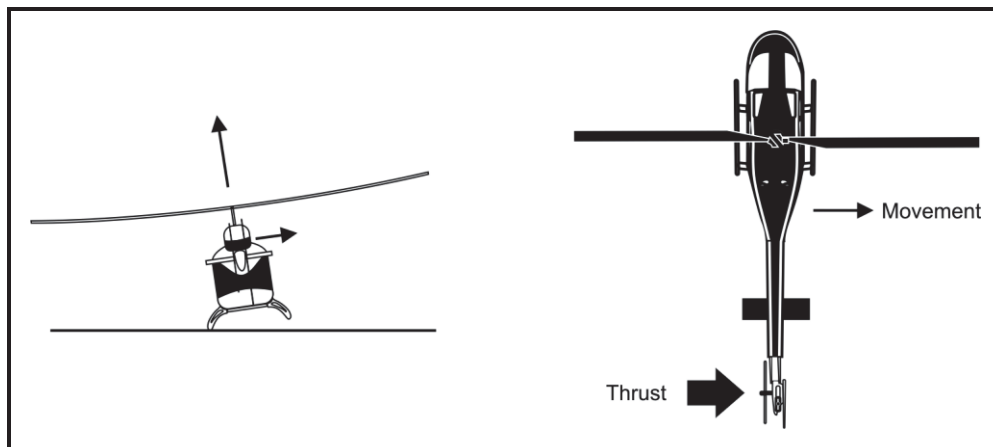

Figure 6-8 Translating Tendency

609. WEATHER VANING

In a no-wind hover, the tail rotor provides all of the anti-torque compensation. As the aircraft moves into forward flight, the tail rotor is assisted in this compensatory effort by the weather-vaning effect and the vertical stabilizer. The increased parasitic drag produced on the longitudinal surface of the aircraft as the relative wind increases causes the aircraft to "steer" into the relative wind. This weather-vaning effect will increase proportionally with airspeed and provide minor assistance to the anti-torque effect (Figure 6-9).

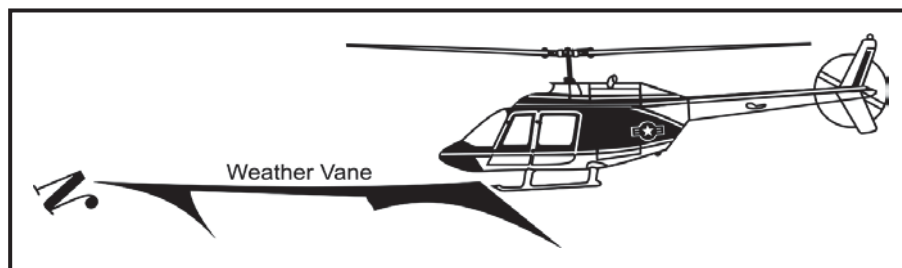

Figure 6-9 Weather Vaning

610. TAIL ROTOR FAILURES AND ISSUES

Anti-torque malfunctions may occur through a number of mechanisms: a loss of the entire gearbox/components; a fixed pedal setting, left, right, or neutral; driveshaft failure; loss of tail rotor authority/loss of tail rotor effectiveness (LTA/LTE). Also, even though an engine failure removes the need for anti-torque compensation, directional control at touchdown may be limited in a number of situations.

1. LTA and LTE

The ability of the tail rotor to provide anti-torque and yaw control can be greatly reduced by two factors that are easily confused. LTA is related to power available to the main and tail rotor. LTE is related to the direction from which the wind strikes the tail rotor in a hover and tends to be labeled as an aerodynamic phenomenon compared to LTA, which is most often described as a mechanical phenomenon.

2. LTA

This occurs when power required for hover exceeds power available. Power supplied to the main rotor is delivered as a torque at a certain rpm.

$$\text{Power} = \text{Torque} \times \text{rpm}$$

When the engines are providing the maximum that they are capable of at 100% rpm it will translate to a certain amount of torque. If the pilot demands more performance by continuing to increase collective the AOA on the main rotor blades will increase. Lift will increase, but so will drag. Because power is a constant, the main rotor response to the increased drag will be an increase in torque and a decrease in rpm.

Tail rotor thrust **required** for flight is a function of main rotor torque. Tail rotor thrust **available** is a function of rpm squared. When the main rotor slows down it also slows down the tail rotor, providing less tail rotor thrust. Thus, the **increased tail rotor thrust required to counteract increasing main rotor torque with drooped turns is not available**. The pilot can call for more tail rotor thrust by increasing tail rotor torque with increased left pedal, but at some point the ability to increase tail rotor AOA runs out. When tail rotor thrust required exceeds tail rotor thrust available, LTA occurs and the nose of the aircraft yaws to the right.

3. LTE

This is a wind issue. With a crosswind or tailwind the tail rotor continues to function but can suffer from degraded ability to provide thrust. LTE is also known as Unanticipated Right Yaw (URY), or Unanticipated Left Yaw (ULY) in helicopters with clockwise rotating main rotors. The reason for the alternate terminology is that some feel the term “loss of tail rotor effectiveness” is misleading. The tail rotors of helicopters in general use have exhibited the capability to produce at least some measure of thrust during all approved flight regimes.

Five relative wind azimuths associated with LTE have been identified through flight and wind tunnel tests. The helicopter can be operated safely in these relative wind regions if proper attention is given to controlling the aircraft, but if a right yaw rate is initiated for some reason, the yaw rate may increase at a dangerous rate. The wind azimuth regions (relative to the nose of the aircraft) of concern are listed here (Figure 6-10), and explained in subsequent sections:

- a. Weathercock stability (120 - 240 degrees)
- b. Tail rotor vortex ring state (VRS) (210 - 330 degrees)
- c. Main rotor disk vortex interference (285 - 315 degrees)
- d. AOA reduction (060-120 degrees)
- e. Loss of translational lift (all azimuths)

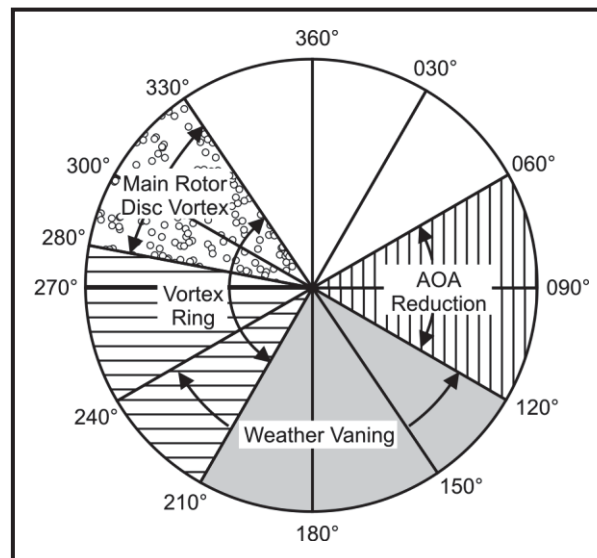

Figure 6-10 Effects of Wind Direction on Directional Control

4. Weathercock Stability (120 - 240 degrees)

Winds within this region will attempt to weathervane the nose of the aircraft into the relative wind. This characteristic comes from the fuselage and vertical fin. The helicopter will make an uncommanded turn either to the right or left depending upon the exact wind direction unless a resisting pedal input is made. If a yaw rate has been established in either direction, it will be accelerated in the same direction when the relative winds enter the 120 - 240 degrees area unless corrective pedal action is made.

5. Tail Rotor VRS (210 - 330 degrees)

Winds within this region will cause the tip vortices generated by the tail rotor blades to be recirculated through the rotor, in the same way that main rotors re-ingest wake vortices in an improperly executed descent. The resultant VRS of the tail rotor causes tail rotor thrust variations that result in unsteady yaw forces. If a right yaw rate is allowed to build, the helicopter can rotate into the wind azimuth region where weathercock stability will then accelerate the right turn rate. Pilot workload during VRS will be high; therefore, the pilot must concentrate fully on flying the aircraft and not allow a right yaw rate to build.

6. Main Rotor Disk Vortex (285 - 315 degrees)

Winds within this region can cause the main rotor vortex to be directed onto the tail rotor. The effect of this main rotor disk vortex is to change the tail rotor AOA. Initially, as the tail rotor comes into the area of the main rotor disk vortex during a right turn, the AOA of the tail rotor is increased. This increase in AOA requires the pilot to add right pedal (reduce thrust) to maintain the same rate of turn. As the main rotor vortex passes the tail rotor, the tail rotor AOA is reduced. The reduction in AOA causes a reduction in thrust and a right yaw acceleration begins. This acceleration can be surprising, since the pilot was previously adding right pedal to maintain the right turn rate. Analysis of flight test data during this time verifies that the tail rotor does not stall but the helicopter will exhibit a tendency to make a sudden, uncommanded right yaw.

7. AOA Reduction (060 - 120 degrees)

In a right crosswind, the relative wind shifts toward a tail rotor blades' chord line because of effectively increased induced velocity (Figure 6-11). The shifted relative wind impacts at a lower AOA, which develops lower lift and results in less thrust. The pilot will automatically compensate by adding more left pedal, but in some cases can reach pedal travel limits before adequate thrust can be generated.

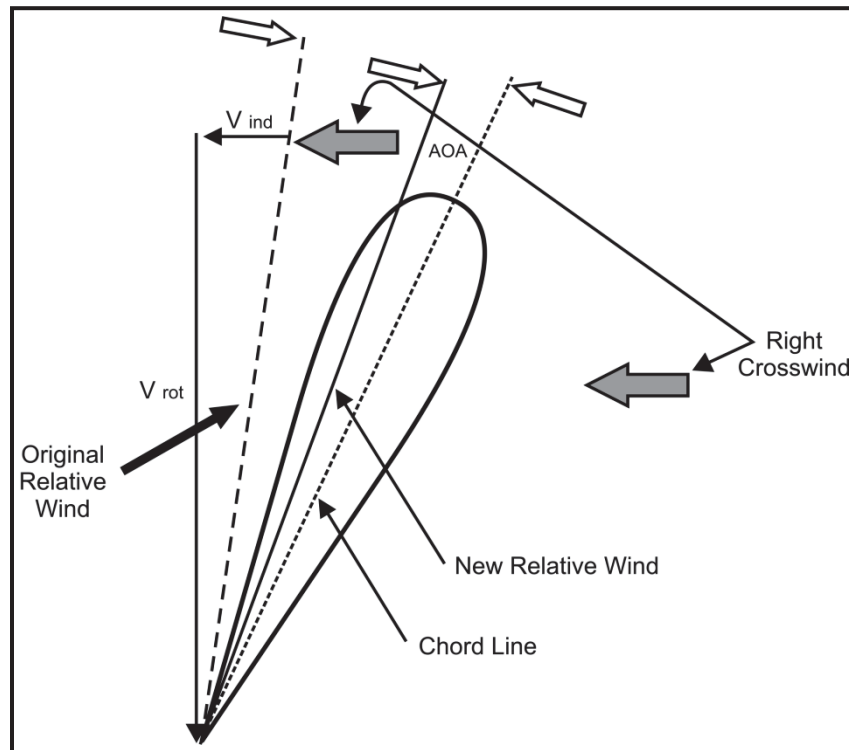

Figure 6-11 LTE in a Right Crosswind

8. Loss of Translational Lift (All Azimuths)

The loss of translational lift results in increased power demand and additional anti-torque requirements. If the loss of translational lift occurs when the aircraft is experiencing a right turn rate, the right turn will be accelerated as power is increased unless corrective action is taken by the pilot.

9. Recovery Technique

If a sudden unanticipated right yaw occurs, the following recovery technique should be performed:

- a. Pedal - Full left; simultaneously, cyclic - forward to increase speed.
- b. As recovery is affected, adjust controls for normal forward flight.
- c. If control inputs do not work, autorotate.

10. Tail Rotor Failure and Engine Failure

Loss of engine power. Should the aircraft lose power the aircraft will tend to yaw left. The yaw inputs made prior to the engine failure compensate for a much greater torque than that which is

instantly delivered with a reduction in engine power. The tail rotor continues to provide thrust whether it is powered by one engine in a single engine failure, or through windmilling in a complete engine failure. Initial response to engine failures must include a right pedal input.

Tail rotor failure. Tail rotor failure, whether a control failure (stuck pedal) or a complete loss of tail rotor thrust, can be a survivable event. With a control failure, most designs allow for the tail rotor to operate at some intermediate setting. If the pilot chooses an appropriate speed, balanced flight associated with that tail rotor setting can be attained.

A complete loss of tail rotor thrust requires more attention to airspeed. With increased airspeed the main rotor operates more efficiently so it generates less torque. As velocity increases, both the power required and anti-torque required decrease until the aircraft reaches its minimum power required or "bucket" airspeed. After the bucket airspeed the power and anti-torque required again increases up to V_{NE} . The best airspeed to fly during a tail rotor failure would be that requiring the least amount of anti-torque. An even better option is to fly in the flight regime in which the engines produce no torque, that is, an autorotation. However, the impact of the vertical stabilizer (fin) must be taken into account as indicated below.

A vertical stabilizer can help quite a bit in reducing the amount of tail rotor thrust required in forward flight. Shaped like a wing, a vertical stabilizer provides lift (thrust) in the direction of anti-torque. The higher the aircraft's velocity the more the vertical stabilizer will be contributing to the anti-torque effort. Design tradeoffs have precluded the production of any military helicopters that can actually fly level with a complete tail rotor failure because the power interactions between tail rotor and vertical fin tend to be like those shown in Figure 6-12. Making a tail fin that could completely compensate for a lost tail rotor would compromise sideward flight capability. The Apache and Blackhawk, however, were designed to be able to fly straight in a controlled descent (at an appropriate airspeed) without the tail rotor operating. Depending on actual flight conditions, the TH-57 B/C NATOPS manual states:

“The vertical fin provides directional stability at cruise airspeeds. It is offset $5\frac{1}{2}^\circ$ to relieve tail rotor loading at high forward speeds and is constructed of aluminum honeycomb. At speeds of approximately 95 KIAS and above, enough lift is generated by the vertical fin to require a slight amount of right rudder.”

This may seem to imply that with a complete loss of tail rotor thrust, at an appropriate speed, the helicopter would fly in relatively balanced flight. However, as previously discussed, since tail rotor blade pitch limits are approximately 20° left and 10° right, centered pedals may still be producing a right thrust force since the mid-point would still be approximately 5° left pitch. This issue is still under investigation but worthy of further discussion.

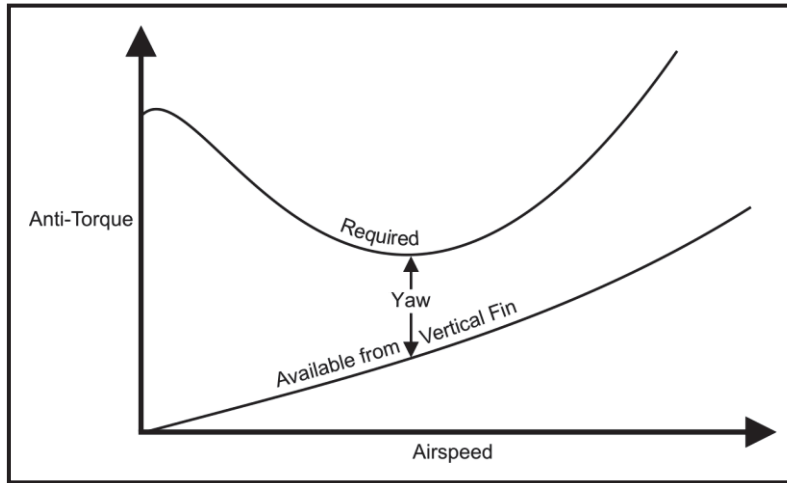

Figure 6-12 Fly Home Capability After Loss Of Tail Rotor Thrust

THIS PAGE INTENTIONALLY LEFT BLANK

CHAPTER SIX REVIEW QUESTIONS

1. In a helicopter with a single main rotor, what will happen to the fuselage when you add power without adjusting the pedals?
 - a. Yaw to the right due to torque effect
 - b. Yaw to the right due to anti-torque
 - c. Yaw to the left due to anti-torque
 - d. Yaw to the left due to torque effect

2. Which of the following function(s) does the tail rotor serve?
 - a. To control the aircraft about the lateral axis
 - b. As an anti-torque device
 - c. Both A and B above
 - d. To control the aircraft about the pitch axis

3. At cruise airspeed the rudder pedals are approximately even as tail rotor loading decreases due to:
 - a. linear flow increasing across the advancing blade
 - b. wind and horizontal stabilizer
 - c. weather vaning and the vertical stabilizer
 - d. vertical stabilizer

4. As engine torque increases in a U.S.-made helicopter, the fuselage will tend to yaw to the left / right .

5. In addition to the anti-torque effect produced by the tail rotor, the sideward thrust produced by the tail rotor results in an effect on the aircraft known as _____
_____ .

6. During a no-wind hover, a pedal turn to the _____ in the TH-57 would cause the tail rotor to demand _____ power.
 - a. left ... more
 - b. right ... more
 - c. left ... less
 - d. right ... the same

7. The force that tends to make a helicopter fuselage rotate in opposition to the main rotor is called _____ .

8. To counter the torque effect, a single-rotor helicopter requires a/an _____ .

9. To make a hovering turn to the left in no-wind conditions, one must increase/decrease tail rotor thrust.
10. How does tail rotor thrust affect vertical takeoffs and landings?
11. Power required by the tail rotor to maintain heading while increasing collective setting will increase/decrease, therefore increasing/decreasing power available to the main rotor system.
12. The _____ effect and _____ provide anti-torque compensation in forward flight.
13. When hovering with the wind from the front left quadrant at 15-20 kts, some instability (directional) may be experienced due to _____.
14. Instability caused when hovering with wind from the 6 o'clock position is known as _____.
15. Instability experienced when hovering with a left crosswind at 10-15 kts may be due to the tail rotor entering _____.

THIS PAGE INTENTIONALLY LEFT BLANK

CHAPTER SIX REVIEW ANSWERS

1. a
2. b
3. c
4. right
5. translating tendency
6. a
7. torque effect
8. anti-torque device
9. increase
10. Tail rotor thrust causes a right drift requiring left cyclic for vertical takeoffs and landings. This is why the right skid lifts off first and touches down last.
11. increase, decreasing
12. weather vaning, vertical stabilizer
13. main rotor vortex interference
14. weathercock instability
15. VRS

CHAPTER SEVEN STABILITY AND CONTROL

700. INTRODUCTION

The purpose of this chapter is to aid the student in understanding the concepts of stability and control as they relate to helicopter aerodynamics. This lesson topic will also introduce the concepts of the virtual axis and its effect on stability and control through the CG.

701. LESSON TOPIC LEARNING OBJECTIVES

1. **Terminal Objective:** Partially supported by this lesson topic:

Upon completion of this unit of instruction, the student aviator will identify the factors that affect helicopter stability and control.

2. **Enabling Objectives:** Completely supported by this lesson topic:
 - a. Recall the definition of static stability and dynamic stability.
 - b. Recall the definition of control, controllability, control authority, and control sensitivity.
 - c. Recall the definition of and state the relationships between CG, mechanical axis and virtual axis.
 - d. Describe how the effect of the location of a helicopter's CG affects control.
 - e. Identify causes for departure from controlled flight.
 - f. Recall the definition of torque effect.
 - g. State the means by which we control the helicopter about the vertical axis.
 - h. Describe problems created by use of a tail rotor system to counteract torque.
 - i. State two means by which tail rotor loading is reduced in forward flight.
 - j. Recall the definition of aircraft trim and explain its importance.

702. REFERENCES

1. Fundamentals of Aerodynamics, NAVAVSCOLSCOM-SG-111
2. Rotary Wing Aerodynamics for Naval Aviators

3. Fundamentals of Flight
4. Helicopter Aerodynamics

703. STUDY ASSIGNMENT

1. Review Chapter Seven.
2. Answer the Review Questions.

704. GENERAL

From our discussion so far, it may seem that in a hover, all forces balance out, and once a stable position has been set (collective setting to produce enough power, cyclic position to maintain a position over the ground, and enough anti-torque compensation to offset torque effect), no further control inputs are required to maintain a hover. It will become readily apparent as you embark on a mission to hover that this is not the case. Helicopters are inherently unstable in a hover; response to control inputs are not immediate, and rotor systems produce their own gusty air, all of which must be corrected for constantly by the pilot. As Harry Reasoner was quoted to say:

“An airplane by its nature wants to fly, and if not interfered with too strongly by unusual events or incompetent piloting, it will fly. A helicopter does not want to fly. It is maintained in the air by a variety of forces and controls working in opposition to each other. And if there is any disturbance in this delicate balance the helicopter stops flying immediately and disastrously.”

Stability and controllability are both very important but have a contradictory relationship. A highly stable aircraft would be very easy to fly in a given flight condition because it would resist any **unwanted** changes or deviations, but would be of little use for most missions because it would also resist **desired** changes in flight path, altitude, or acceleration. A highly controllable aircraft that responded instantly and quickly to pilot inputs or changing flight conditions would be easy to maneuver, but would be exhausting to fly because the pilot would have to constantly correct for any deviations caused by gusts or slight control movements, even in straight and level flight. Designers seek to achieve the proper balance between stability and controllability during the design of a helicopter, providing stability to make flight predictable, but enough controllability to offer pilots the ability to maneuver as much as needed in anticipated mission profiles.

705. STATIC STABILITY

Stability and control are essential components of an aircraft's usefulness. A good aircraft must have adequate stability to provide a uniform flight condition despite random disturbances encountered in flight and minimize pilot workload. It also must respond properly to control inputs so that a pilot can use the full range of the aircraft's performance capabilities.

Stability. When an aircraft is not accelerated by any moments or forces it is in a state of equilibrium. By Newton's first law, an aircraft in equilibrium will continue in its established condition of flight until it is acted upon by an unbalanced force. Note that the equilibrium state can be a hover, straight and level flight, a steady-state turn, or even a descent. It is easiest to consider the equilibrium cases of hover or straight and level flight. Stability is the tendency to return to a given state of equilibrium when disturbed.

Static Stability. Static Stability is the **initial tendency** of a system, once disturbed, to return **toward** an equilibrium, or trimmed position.

Positive Static Stability. If an object has an initial tendency toward its original equilibrium position after a disturbance, it is said to possess **positive static stability**. Consider a ball inside a bowl (Figure 7-1). The ball's equilibrium position is at the bottom of the bowl. If the ball is moved from this position toward the rim of the bowl its initial tendency, when released, is to roll back toward the bottom of the bowl. It has positive static stability.

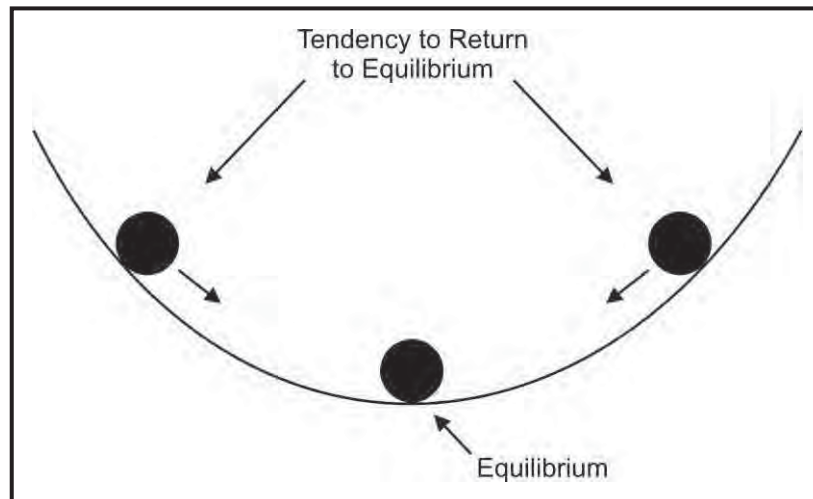

Figure 7-1 Positive Static Stability

Negative static stability. Negative static stability is the initial tendency to continue moving away from equilibrium following a disturbance. If the bowl is upside down, the ball's new equilibrium position is top dead center (Figure 7-2). If the ball is moved away from its equilibrium position and released, its initial tendency is to roll farther away from equilibrium. The ball exhibits negative static stability.

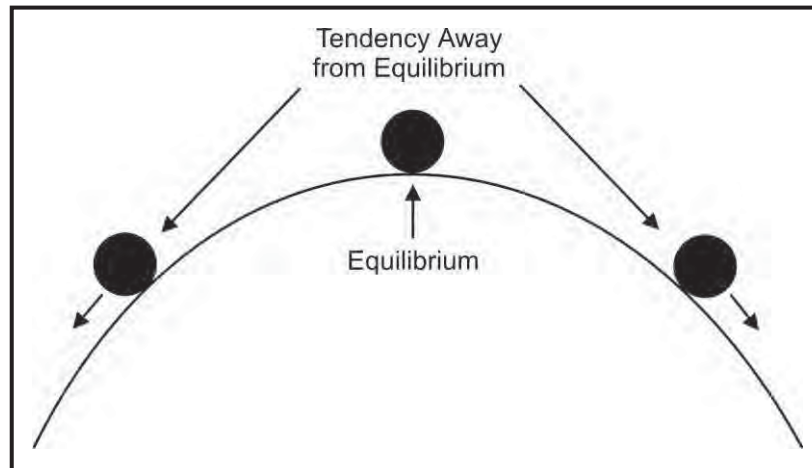

Figure 7-2 Negative Static Stability

Neutral static stability. Neutral static stability is the initial tendency to accept a displacement as the new equilibrium position. If the ball is on a flat surface, it is in equilibrium in its initial position. If it is moved away from the initial position, it has no tendency to move toward or away from the spot (Figure 7-3). The ball now demonstrates neutral static stability.

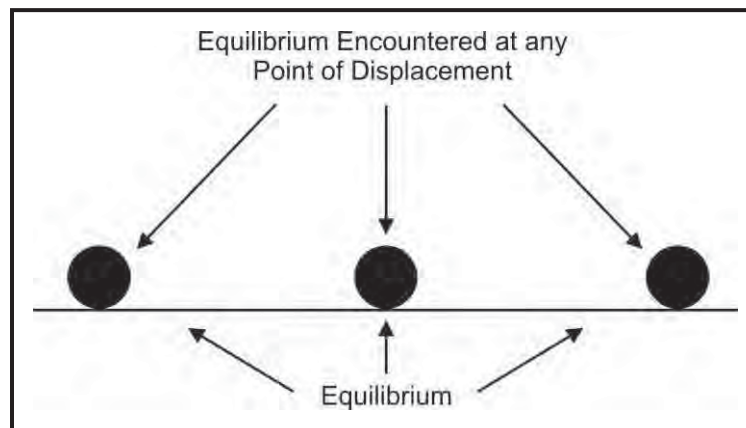

Figure 7-3 Neutral Static Stability

Stability is always discussed with respect to a certain motion variable, like AOA. Different types of stability may exist with different motion variables. Stability can also be discussed with respect to motions about any aircraft axis. For example, it is usual to discuss a helicopter's directional stability in terms of what the aircraft does in yaw, following a disturbance in sideslip angle.

Helicopters are designed to be as close as possible to positive static stability in as many axes as possible. Thus, in roll, pitch, yaw, airspeed, sideslip, and other potential flight parameters designers seek to approach positive static stability. The few parameters that cannot be made

statically stable are made as close to neutral stability as possible, and are adjusted to act slowly enough for pilots to comfortably control them. Two stability characteristics of the main rotor that helicopters tend to exhibit involve speed and AOA changes discussed later.

706. DYNAMIC STABILITY

Static stability reveals nothing about whether the object ever settles back to its original equilibrium position. Instead, one must look to dynamic stability to determine the long-term outlook on the object. For the study of the dynamic stability of an object to be useful, it must first possess positive static stability. If the object has negative static stability, the likelihood of it ever seeing equilibrium again is zero. If the object has neutral static stability, there is no motion once the object is disturbed.

Dynamic stability is the tendency of a system, **over time**, to return to an equilibrium or trimmed, condition. Positive dynamic stability exists if the system eventually returns to equilibrium. A neutrally dynamically stable system does not get any closer or further from equilibrium after time goes by. A system with negative dynamic stability eventually continues in the direction of the disturbance. Dynamic stability concerns itself with the resulting motion in time. If a helicopter is disturbed from equilibrium, the time history of the resulting motion indicates the dynamic stability of the system.

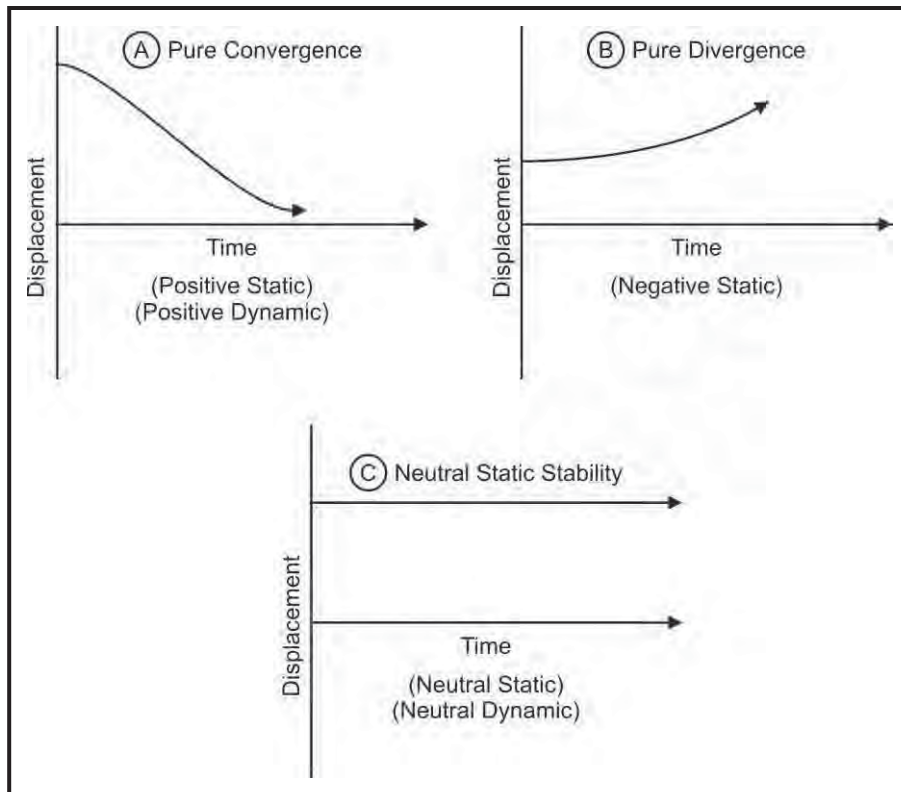

Figure 7-4 Time History Plots, with Damping

Figure 7-4 illustrates some time plots given an initial displacement. The system moves to

equilibrium over time (A, convergence) and is stable, moves away from equilibrium (B, divergence) and is unstable, or remains where it was displaced (C) and is called neutrally stable. Consider the ball in Figure 7-1. After it is released, the natural expectation is for it to roll back to the bottom and up the other side. It would roll back and forth, oscillating less and less about the equilibrium position until it finally came to rest at the bottom of the bowl. This object possesses **positive dynamic stability**. Note that although the ball passes through the equilibrium position, it is not in equilibrium again until it has stopped moving. Because the ball rolls a shorter distance up the sides of the bowl each time, the motion is described as a **damped oscillation** (Figure 7-5).

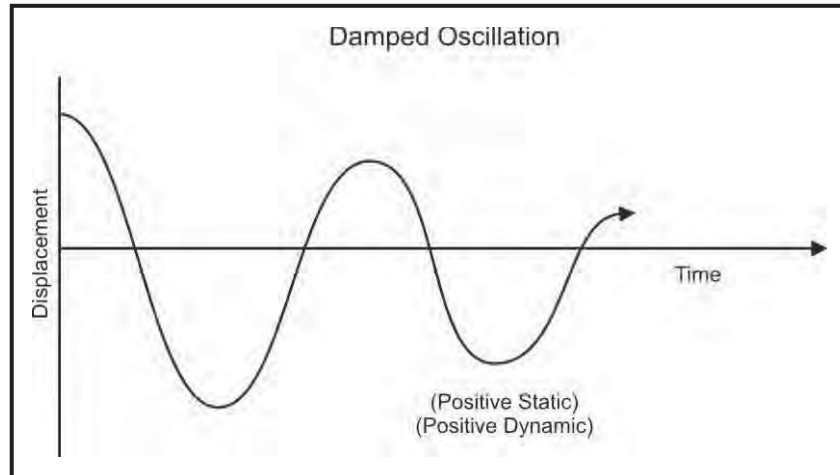

Figure 7-5 Positive Dynamic Stability

If the ball oscillates about the equilibrium position and the oscillations never dampen out, it possesses **neutral dynamic stability**. Figure 7-6 depicts its displacement relative to equilibrium over time. This motion is called an **undamped oscillation**. Very lightly damped oscillations studied over a short period of time exhibit something akin to neutral static stability.

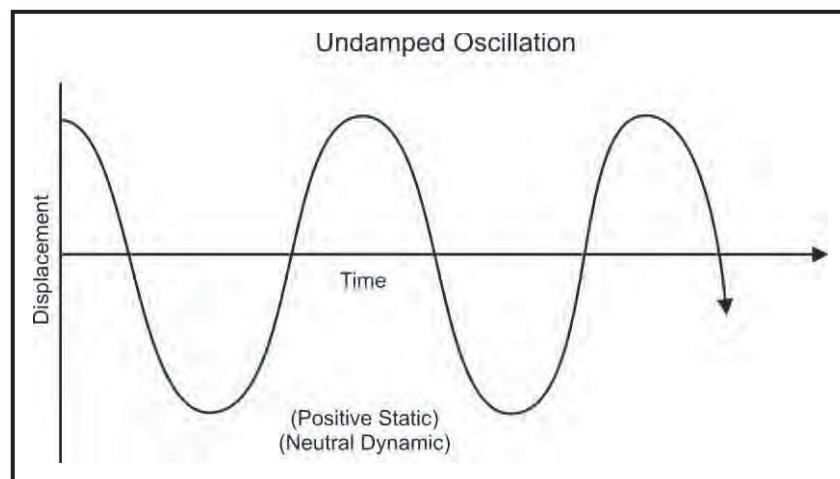

Figure 7-6 Neutral Dynamic Stability

If, somehow, the ball did not slow down (Figure 7-1), but continued to climb to a higher and higher position with each oscillation, it would never return to its original equilibrium position. Figure 7-7 depicts **negative dynamic stability**. Obviously this motion is impossible with the ball in Figure 7-1, but occasionally aircraft behave this way. This motion is called a **divergent oscillation**.

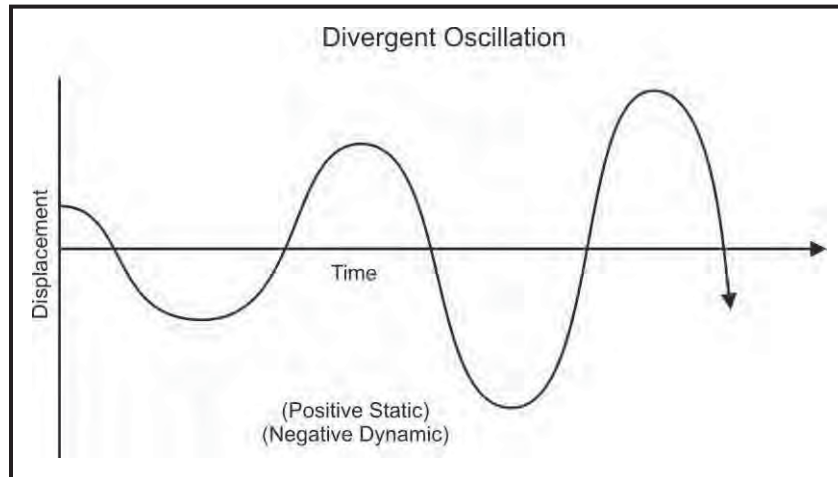

Figure 7-7 Negative Dynamic Stability

If an object does not have positive static stability, it cannot have positive dynamic stability. If an object has positive static stability, it can have any dynamic stability. In other words, static stability does not ensure dynamic stability, but static instability ensures dynamic instability. If an object is dynamically **stable**, the displacement from equilibrium will be reduced until the object is again at its original equilibrium. It must have both positive static and positive dynamic stability. If an object is dynamically **unstable**, the displacement may or may not increase, but the object will never return to its original equilibrium.

707. CENTER OF GRAVITY (CG)

The CG is considered the balancing point of a body for weight and balance purposes, as will be discussed shortly. The CG is determined by summing moments about a datum and dividing by the weight. When the CG is not aligned with the mechanical axis, the cyclic control must be sufficiently displaced to compensate the unbalanced CG condition. The helicopter fuselage will be tilted so that the heaviest end or side will be lower in a hover. Subsequently changing the CG of the aircraft will require the cyclic control to be repositioned. If cargo, fuel, or personnel are loaded or unloaded, the new CG will require compensating with cyclic. An aft CG will require forward cyclic and forward CG will require aft cyclic. Corresponding lateral cyclic inputs are required for lateral CG displacements. The limit of cyclic authority plays the most important role in determining the CG limits of a helicopter. However, the CG limit is not defined by the full displacement of the cyclic; the limit must be maintained within the cyclic authority to ensure adequate control and a margin of safety.

If the safe CG limits are exceeded, the aircraft will enter uncontrollable flight. Full cyclic displacement will be unable to compensate for the extreme CG, and the aircraft will roll or pitch in the direction of the extreme CG, likely resulting in aircraft damage or destruction (uncommanded right roll, low G flight/mast bumping, LTE).

CG Limits. Stability and controllability are greatly affected by an aircraft's CG. The CG is defined as the imaginary point at which the total weight of a body can be considered to be concentrated. In fact, if a line was attached to an aircraft at its CG, the airframe could be lifted without rotating because it would be balanced evenly about that point. In a similar manner, the CG of an aircraft will determine the fuselage attitude of the aircraft in both a hover and forward flight, and will determine the amount of controllability and stability of the helicopter about all three axes.

To calculate the location of the CG in the design phase, engineers determine the weight of each component and its location relative to the centerline, waterline and nose of the aircraft. Then, all of the components' moments relative to the CG are determined by multiplying the weight of the component by the distance to a datum point of the aircraft to get a total moment. The total weight of all the components is added up to get a total weight. We can then divide the total moment, in units of inch-pounds (in-lbs), by the total weight, in units of pounds (lbs), to get the distance of the CG from the aircraft's datum point. In the case of the TH-57, the datum is defined as the nose of the helicopter, and the moment arms are measured in inches behind the nose of the aircraft. A moment is determined by multiplying the moment arm (inches) by the weight in that particular area (passengers, fuel, baggage, etc.). Once the moments are summed, the sum is divided by the total weight, and this quotient will be the arm of the CG behind the nose in inches. When all is said and done the designers ensure that the CG is in its most optimal position for the missions and flight profiles of the aircraft. **In general, a more forward CG, within limits, results in a more stable aircraft, since the main rotor's contribution to AOA instability is decreased.**

By the military specification against which aircraft are tested, a minimum of ten percent (sometimes 12-15 percent) control margin must exist for flight at a CG limit. The CG limits, then, are established such that the pilot has at least the minimum control margin available when flying at a CG limit. What must be recognized is that the **helicopter CG limits are established for a static, stabilized flight condition, where dynamic maneuvers are not involved.** In order for the pilot to stop or reverse a dynamic maneuver when operating at a CG limit, it will be necessary to use some or all of the available remaining control margin. If a pilot is operating at or near a CG limit it is imperative to maintain a very "stable" flight profile by limiting the amount of aggressive or dynamic maneuvers.

CG limits are affected by the type of rotor system (Figure 7-8). A semi-rigid rotor that has a small CG range can be improved by using a longer rotor mast. A fully articulated or rigid rotor has its CG range established based upon control authority through the hinge point or effective hinge point. Tandem rotor helicopters are very versatile cargo aircraft because their CG range, originating between the two rotors, is very broad in the cabin area.

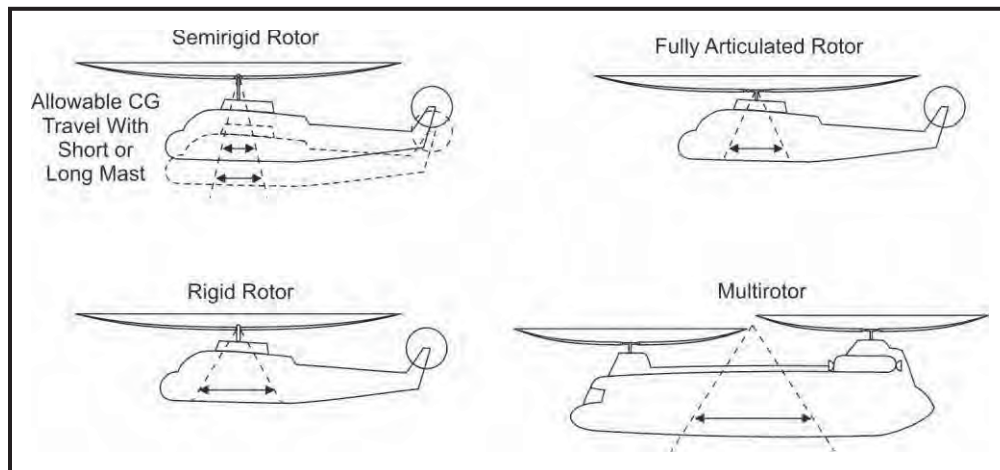

Figure 7-8 Effect of Rotor Systems on CG Travel

708. HELICOPTER STATIC STABILITY AND MANEUVERABILITY

The helicopter is inherently unstable because it tends not to stay in equilibrium. Since the helicopter is unstable, the pilot has to spend much of his time keeping the helicopter on the desired flight path. Many helicopters are now built with auto flight control systems so that, with greatly reduced pilot workload, they will maintain heading, trim, and/or altitude in forward flight. However, the TH-57 does not have such a system and therefore requires constant vigilance in both the hover and in-flight regimes.

Equilibrium occurs when the sum of the forces and moments around the CG are equal to zero. An aircraft in equilibrium will travel in a constant direction at a constant speed, developing no moments that would cause it to rotate around the CG. Since an aircraft can rotate around three different axes, we must consider its stability around each of these axes. **Lateral stability** is stability of the lateral axis around the longitudinal axis (roll). **Longitudinal stability** is stability of the longitudinal axis around the lateral axis (pitch). **Directional stability** is stability of the longitudinal axis around the vertical axis (yaw). Each motion requires a separate discussion.

Some basic assumptions must be made to simplify this discussion. First, the disturbances will be small enough to keep the change in pitch attitude and degree of yaw and roll small enough so that the aircraft does not approach any unusual attitude. **Disturbances are external and not caused by the pilot.** The pilot applies no inputs to correct the displacement from equilibrium. Any moment that corrects the airplane's attitude is the result of the design of the aircraft.

Any discussion of aircraft stability requires an explanation of how the rotor system, fuselage, vertical stabilizer, horizontal stabilizer, etc, affect the longitudinal, lateral, and directional stability of the airplane. This is critical to understanding why the rotor disk is tilted or coned a particular way, why the tail is where it is, and why the vertical stabilizer is as big as it is. This discussion will revolve around conventional helicopters, that is, helicopters with a single main rotor and tail rotor.

A helicopter's **maneuverability** is the ease with which it will move out of its equilibrium position. Obviously, **maneuverability and stability are opposites**. A stable aircraft tends to stay in equilibrium and is difficult for the pilot to move out of equilibrium. The more maneuverable an aircraft is, the easier it departs from equilibrium, and the less likely it is to return to equilibrium. If an aircraft needs to move quickly from its trimmed equilibrium attitude, it will have weak stability. Of course, this means the aircraft will be more difficult to fly in equilibrium and will require more of the pilot's attention. The mission of a specific aircraft dictates the compromises between stability and maneuverability the designer will have to make. With a basic understanding of static stability, it is possible to discuss each aircraft component and its individual contribution to static stability. Afterwards, the effect of all the components can be used to discuss the overall static stability of the aircraft.

709. LATERAL STATIC STABILITY

Lateral stability is stability of the lateral axis around the longitudinal axis. An aircraft has lateral stability if, after some disturbance causes it to roll, it generates forces and moments that tend to reduce the bank angle and restore the aircraft to a wings-level flight condition. When a helicopter rolls, the thrust vector points to the inside of the turn and reduces the vertical component of lift. Since weight still acts downward with the same force, the aircraft descends. The horizontal component of lift pulls the airplane to the side, thus creating a sideslip relative wind. This sideslip relative wind acts on the various components of the aircraft causing stability or instability.

710. DIHEDRAL EFFECT

As seen in the T-34 (Figure 7-9), when an aircraft is laterally sideslipping, dihedral wings cause an increase in AOA and lift on the down-going wing. The up-going wing has a reduced AOA and a decrease in lift. This difference in lift creates a rolling moment that rights the aircraft and stops the sideslip. Wings that are straight have neutral lateral static stability. Dihedral wings are the greatest positive contributors to lateral static stability on an airplane.

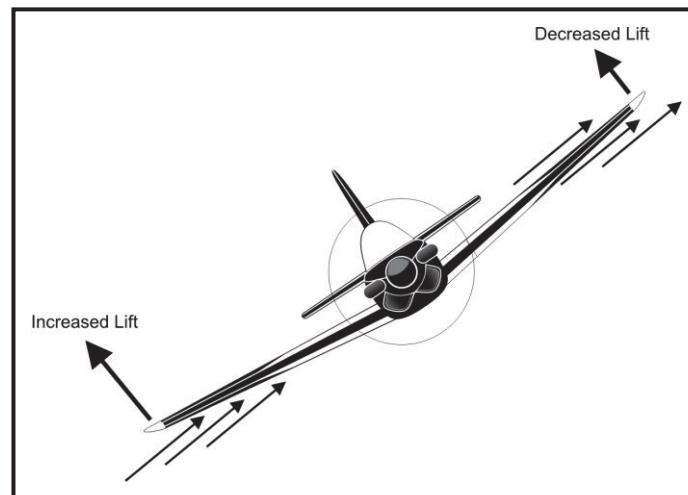

Figure 7-9 Lateral Dihedral Effect

The coning of the helicopter rotor blades may appear to resemble a lateral dihedral, but in fact, they are not. The total thrust vector is the determining factor and is providing no lateral stability through any lateral dihedral. Dihedral effect can, however, also be applied to longitudinal stability, where it does apply to the helicopter, as will be discussed later.

711. THE FLYING WING MODEL

Each major component or sub-component of an aircraft has its own AC, and thus its own effect on static stability. For every AC, there is a moment about the aircraft's CG that is either stabilizing or destabilizing. To examine specific stability conditions, the simplified "flying wing" model can be used. Choosing the flying wing model allows the stability effect of the wing itself to be studied without the complicating effect of other aircraft components.

An aircraft experiences four main forces in equilibrium flight: lift, thrust, weight, and drag. Recall that these forces act around the CG. For this discussion of longitudinal stability only lift and weight need be addressed. Figure 7-10 shows these two forces in equilibrium on the flying wing model "aircraft."

Lift is acting through the AC, which is at a distance from the CG, creating a moment (Figure 7-10). It should be understood that the flying wing is considered to be "trimmed" into equilibrium, and that no rotation should be occurring from the current configuration of forces.

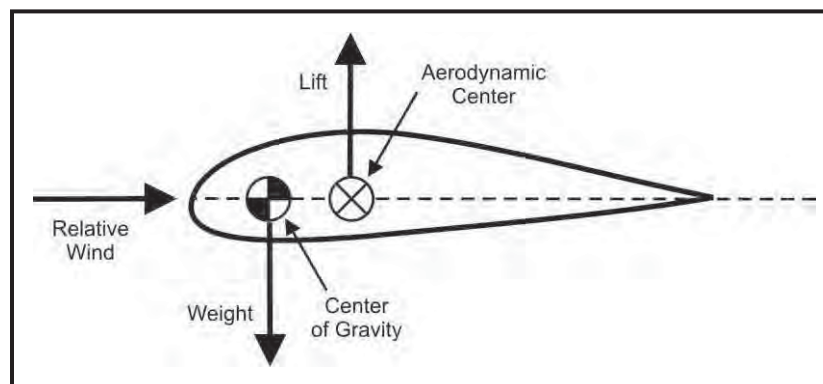

Figure 7-10 Flying Wing Model

If a disturbance were to increase the AOA on the airfoil, lift would increase. If the CG is closer to the leading edge than the AC, the increase in lift develops a moment that pitches the nose of the aircraft down. This will decrease the AOA back toward its original value, returning the aircraft to equilibrium. This flying wing has positive longitudinal static stability because of its initial tendency to return to an equilibrium condition (Figure 7-11, left). This can be generalized to say that **if a component's AC is behind the aircraft's CG, the component will be a positive contributor to longitudinal static stability.**

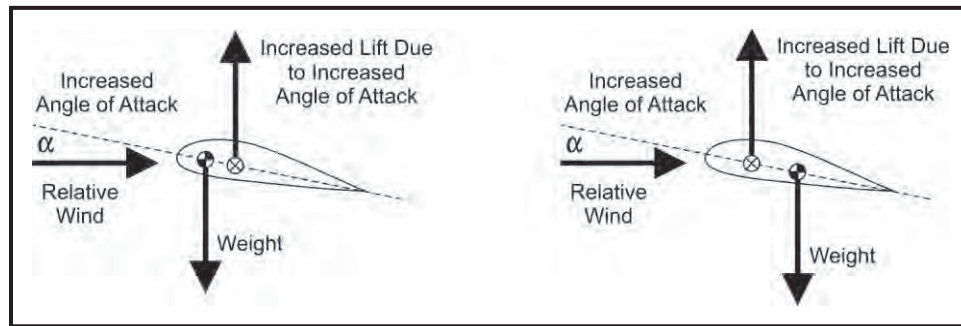

Figure 7-11 Positive and Negative Longitudinal Static Stability

If, instead, the AC is closer to the leading edge than the CG, a disturbance that increases AOA would pitch the nose up (Figure 7-11, right). This will increase AOA further, which would increase the pitching moment and cause the flying wing to diverge from equilibrium. This can be generalized to say that **if a component's AC is in front of the aircraft's CG, the component will be a negative contributor to longitudinal static stability.**

Using these two generalized statements, the effect of any component on the aircraft's stability can be classified as positive or negative contributors.

712. THE FUSELAGE AND LONGITUDINAL STABILITY

The fuselage shape is very similar to an airfoil and thus will produce lift. The fuselage's AC is usually located ahead of the aircraft's CG. If a disturbance causes an increase in AOA, the fuselage will produce greater lift, producing a destabilizing effect. **The fuselage is a negative contributor to longitudinal stability.**

713. HORIZONTAL STABILIZER / STABILATOR

Longitudinal trim can be a problem at high forward speed. Since a large forward horizontal force is required to overcome parasite drag, the disk is tilted forward appreciably. This creates a nose-down moment about the CG. The aircraft assumes excessive nose-down attitudes at high speed unless some other restoring moment is provided. Fixed **horizontal stabilizers** do this by supplying an aerodynamic downforce proportional to fuselage AOA. Thus as speed is increased the nose-down tendency caused by forward rotor tilt is partially compensated for by nose-up moments created by the horizontal surfaces.

The horizontal stabilizer is also designed to stabilize the helicopter around the lateral axis. As mentioned earlier, the horizontal stabilizer provides a longitudinal dihedral effect. Its contribution to longitudinal static stability is determined by the moment it produces around the CG. Since its AC is well behind the helicopter's CG, **the horizontal stabilizer will have the greatest positive effect on longitudinal static stability.** The pitching moment can be increased by increasing the distance between the aircraft's CG and the stabilizer's AC, or by enlarging the horizontal stabilizer. Thus, for a short aircraft or one with a CG that is very far aft, a large

7-12 STABILITY AND CONTROL

horizontal stabilizer may be required. For an aircraft with a longer moment arm, a smaller horizontal stabilizer will suffice. In addition to providing a more level attitude during high speed flight, the horizontal stabilizer increases the CG range of the helicopter and compensates for AOA instability.

On some helicopters **synchronized elevators** are provided, where a horizontal surface attached to the fuselage is mechanically or electrically controlled to rotate with stick movement. This gives download control somewhat independent of fuselage AOA, thus permitting (assuming proper gearing between surface and stick) relatively level fuselage trim attitudes throughout the speed envelope. For sync-elevators not to create unwanted nose-down pitching moments during maneuvering, they are often fitted with a spoiler on their upper surface or have negative camber.

A **stabilator** is servo actuated in accordance with airspeed and minimizes nose-up attitude during low speed and hover by programming downward during transition to a hover to align itself with main rotor downwash. Its capabilities also minimize nose-down attitudes during high speed flight.

714. AIRSPEED STABILITY

When a sudden change in airspeed (i.e. a gust) occurs, helicopter main rotors tend to return toward equilibrium, as follows: An increase in airspeed causes flapping and blowback, which slows the aircraft down. As the aircraft decelerates back toward its original airspeed, the flapping response becomes smaller until the aircraft achieves its original airspeed and all excess flapping is eliminated. The result is that a trimmed helicopter, when disturbed, tends to return to its trimmed state as depicted in Figure 7-12. It exhibits **positive static stability**.

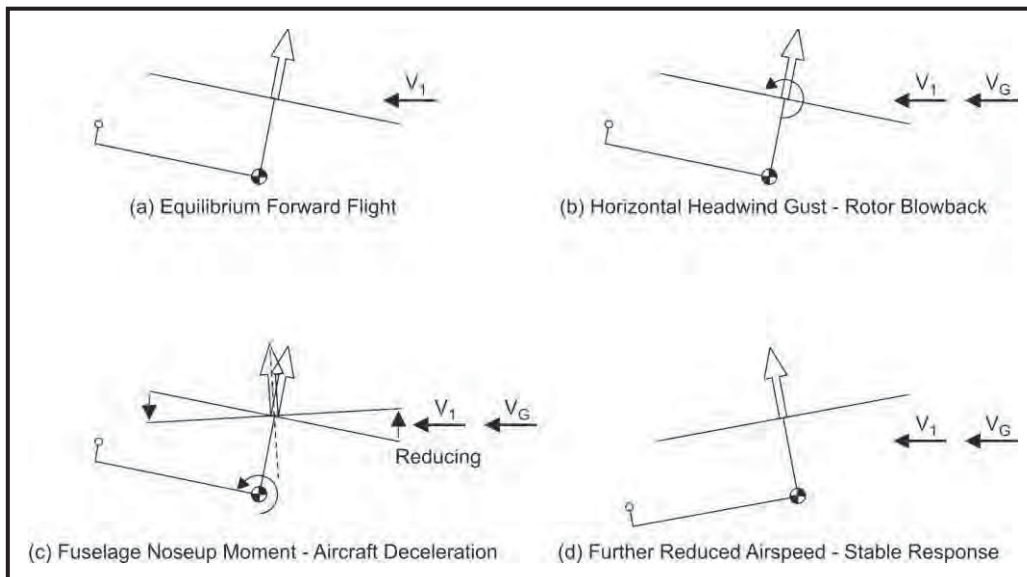

Figure 7-12 Airspeed Stability

715. ANGLE-OF-ATTACK INSTABILITY

When a sudden change in vertical airflow impacts the rotor disk, the helicopter's response is to continue deflecting away from equilibrium, as follows: An increase in upflow increases the AOA on all rotor blades. The advancing side of the disk, however, has a higher relative wind velocity so it generates more lift with the AOA change. This phenomenon is consistent with the advancing side of the disk being the "most effective blade" as discussed in Chapter 10. Phase lag causes the higher lift on the advancing side to result in movement of the rotor up at the 12 o'clock position and down at the 6 o'clock position. Such motion results in an overall increase in AOA on the entire rotor, which continues to cause a rearward tilt (Figure 7-13). The fact that the rotor tends to move further away from equilibrium means that in this regime the rotor has **negative static stability**. Typically, AFCS and horizontal stabilizers are more commonly used to compensate for main rotor AOA instability.

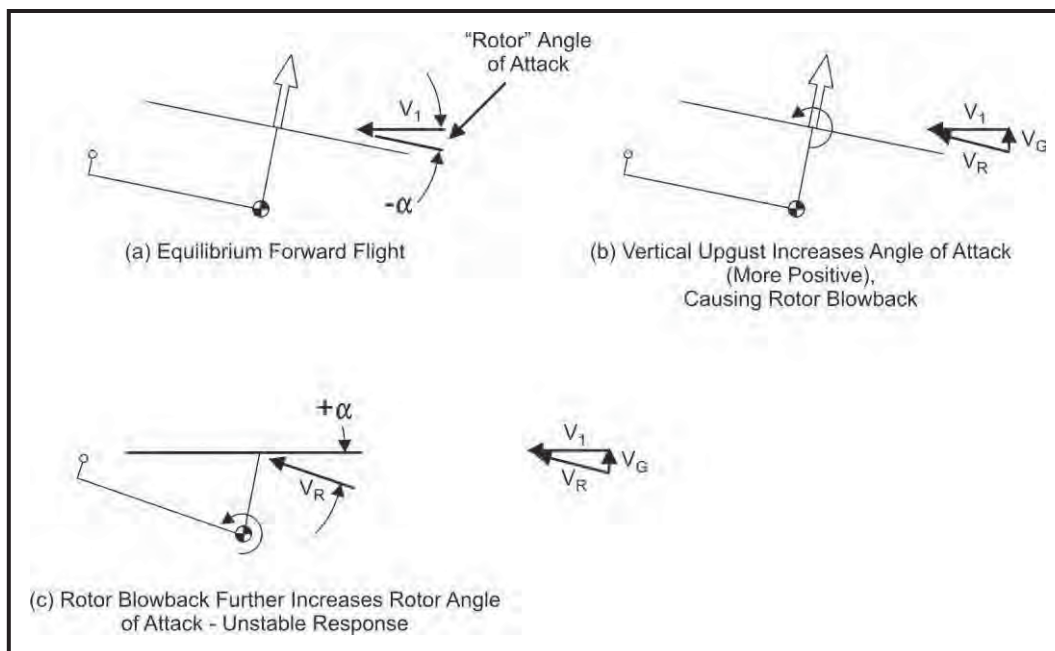

Figure 7-13 AOA Instability

Horizontal Stabilizer/Synchronized Elevator Contribution. The various forms of stabilizers/elevators previously discussed function to help overcome the main rotor's contribution to AOA instability, permit greater CG travel, and give a more level fuselage attitude in forward flight by supplying a counteracting moment. The stabilator also minimizes low speed/hover nose-up as well as high speed nose-down attitudes.

716. DIRECTIONAL STATIC STABILITY

Directional static stability is stability of the longitudinal axis around the vertical axis. When an aircraft yaws, its momentum keeps it moving along its original flight path for a short time. This

condition is known as a **sideslip**. The angle between the longitudinal axis and the relative wind is called the **sideslip angle**. The component of the relative wind that is parallel to the lateral axis is called the **sideslip relative wind**. Reaction to the sideslip will determine a component's contribution to directional static stability. We will examine the effects of the fuselage and the vertical stabilizer on directional static stability.

717. THE FUSELAGE AND DIRECTIONAL STABILITY

The fuselage is a symmetric airfoil with its AC forward of the aircraft's CG. At zero AOA or zero sideslip it produces no net lift. When the aircraft enters a sideslip, an AOA is created on the fuselage. The lift produced at the fuselage AC pulls the nose away from the relative wind, thus causing an increase in the sideslip angle. Therefore, **the fuselage is a negative contributor to the aircraft's directional static stability**.

718. THE VERTICAL STABILIZER

The vertical stabilizer is the greatest positive contributor to the directional static stability of a conventionally designed helicopter. The vertical stabilizer is an airfoil mounted far behind the aircraft's CG. A sideslip causes the vertical stabilizer to experience an increased AOA. This creates a horizontal lifting force on the stabilizer that is multiplied by the moment arm distance to the aircraft's CG. The moment created will swing the nose of the aircraft back into the relative wind. This also serves to partially unload the tail rotor at high forward speeds. This is identical to the way a weather vane stays oriented into the wind. There is an inverse relationship between tail size and moment arm length. The smaller the distance to the CG, the larger the vertical stabilizer must be and vice versa. It is not always desirable to have a large vertical stabilizer because of sideward flight limitations.

719. CONTROL

Control. Control (or maneuverability) is the application of forces or moments to a helicopter to achieve or maintain a desired condition of flight. There are a number of related terms that are commonly used in discussions of aircraft control:

1. **Controllability** is a helicopter's ability to accept pilot inputs and generate appropriate control inputs to achieve desired flight conditions.
2. **Control power** or **control authority** refers to the maximum moment that can be generated on the aircraft by application of the cockpit controls.
3. **Control sensitivity** refers to the moment generation capability per unit of control displacement (e.g., per inch of cyclic movement).
4. **Control effectiveness** refers to the degree to which pilot and appropriate control inputs achieve the desired effect at the control surface, especially due to aerodynamic, as opposed to mechanical, factors.

720. MECHANICAL VERSUS VIRTUAL AXIS

Recall from Chapter 5, when discussing the rotor system, there are three axes used:

The **control axis**, a line perpendicular to the plane of the swashplate. The pilot controls the swashplate tilt through the cyclic and the control axis represents where the pilot would like the rotor thrust pointed.

The **virtual axis** is defined by the total rotor thrust acting perpendicular to the tip path plane through the head. The disk appears to rotate around the virtual axis.

The **mechanical or shaft axis**, the physical axis to which the rotor head is attached and the axis it actually turns around, regardless of tilt. The mechanical axis is the mast from the transmission and is aligned closely with the aircraft CG.

All helicopters are controlled by adjusting the magnitude and direction of thrust provided by all installed rotor systems (main rotor, tail rotor, and, in the case of multiple rotors, each main rotor). The thrust vector, displaced from the CG, generates a moment to rotate the aircraft. When the total rotor thrust is angled, the virtual axis is displaced from the CG by a distance (Figures 7-14 and 7-15). This force (thrust), when multiplied by the distance, yields a moment that rotates the aircraft. Once the helicopter is oriented in a new direction, the rotor's thrust pulls the helicopter in that direction. Flight path is determined by the balance between the main rotor's thrust and other forces (drag, weight/load factor, centripetal force).

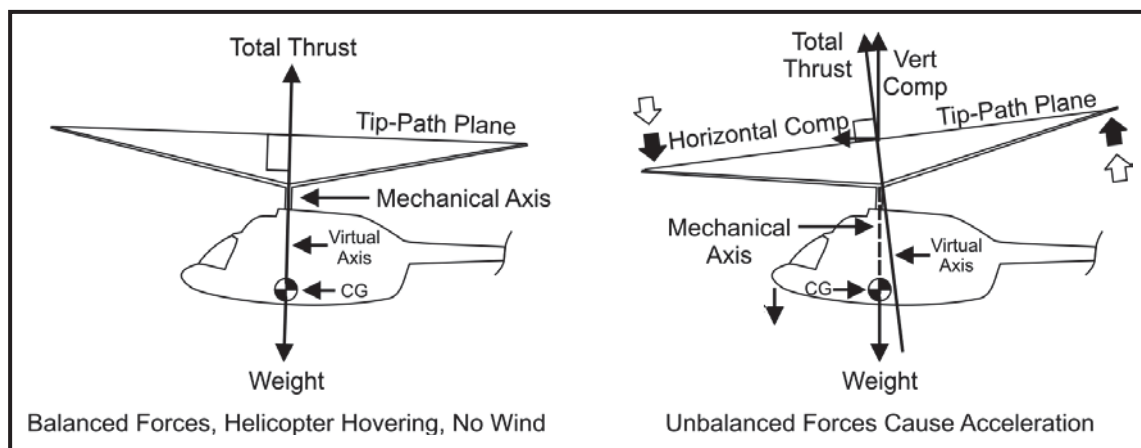

Figure 7-14 Mechanical vs. Virtual Axis

The amount of tilting available from the main rotor thrust vector limits the CG range about which the pilot can create moments to control the aircraft both laterally and longitudinally. If the CG is outside these limits the pilot's control authority can be exceeded.

The fuselage of the helicopter has considerable mass and is suspended from a single point (single-rotor helicopters). It is free to oscillate laterally or longitudinally like a pendulum.

However, unlike a pendulum which has a fixed pivot point, a helicopter is more complicated since the “pivot point” actually moves (disk tilts), which can change the relationship between the CG and the thrust, creating additional torque moments. When the tip path plane shifts, the total aerodynamic force and virtual axis will shift, but the mechanical axis and the CG, which is ideally aligned with the mechanical axis, lag behind. As the CG attempts to align itself with the virtual axis, the mechanical axis which is rigidly connected to the fuselage also shifts, and the aircraft accelerates.

In the case of high-speed forward flight, the nose of the aircraft would be low due to the tilt of the rotor disk and moment due to fuselage drag. To compensate for this, a cambered horizontal stabilizer is incorporated to provide a downward lifting force on the tail of the aircraft. Therefore, the aircraft fuselage maintains a more level attitude during cruise flight due to the moment created by the stabilizer.

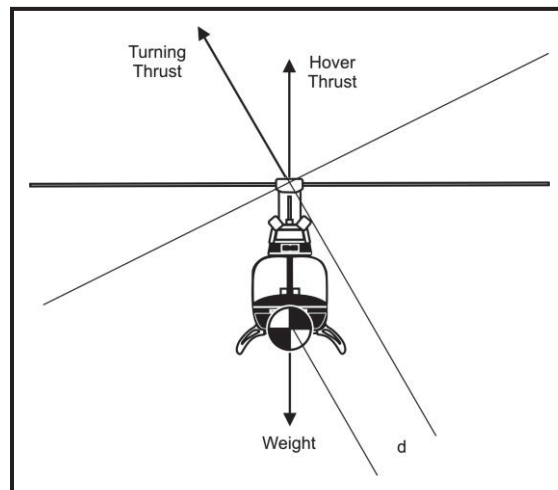

Figure 7-15 Turning vs. Hover Thrust

Pendular Action. Normally, the fuselage follows rules that govern pendulums, balance, and inertia. Rotor systems, however, follow rules governing aerodynamics, dynamics, and gyroscopics. These two unrelated systems have been designed to work well together, in spite of the apparent conflict. However, other factors affect the relationship of the rotor system and fuselage. These factors are overcontrolling, cyclic-control response, and shift of attitude.

721. PILOT / AIRCRAFT INTERACTION

Having discussed how an aircraft's stability characteristics react to various external forces, we must also consider the interaction of the pilot and the aircraft. In a helicopter, **pilot induced oscillations (PIO)** are short period oscillations of pitch and roll attitude. PIO occurs when a pilot is trying to control airplane oscillations that happen over approximately the same time span as it takes to react. This most commonly occurs with the overcorrections associated with either first learning to hover or when transitioning to a new aircraft, but it can also result from over-reaction to a gust or thermal. For example, a gust of wind causes the nose to pitch up. The natural longitudinal stability of the helicopter will normally compensate. However, if the pilot tries to push the nose down, his input may coincide with the stability correction, causing the nose

to overcorrect and end up low. The pilot then pulls back on the stick causing the nose to be high again. Since the short period motion of PIO is of relatively high frequency, the amplitude of the pitching could reach dangerous levels in a very short time. **If PIO is encountered, the pilot must resist the urge to overcontrol.**

Overcontrolling. Overcontrolling occurs when the aviator moves the cyclic control stick, causing rotor tip-path changes that are not reflected in corresponding fuselage-attitude changes. Misalignment of the virtual and mechanical axes is a principal cause of pilot induced instability during helicopter flight. Because the results of cyclic inputs are not manifested in instantaneous fuselage attitude changes, there is a tendency for inexperienced pilots to initiate corrections with excessively large inputs. As the fuselage catches up with the tip path plane, the pilot realizes the gravity of his error and attempts to correct with an equal and opposite input, creating the same problem in another direction. Called "pilot-induced oscillation," this situation can be described as "getting behind the motion." Since this phenomenon is unpredictable and does not always occur, the best advice to a pilot in this situation is: relax for a second and let the aircraft settle down (Figure 7-16). Correct cyclic control movements (free of overcontrol) cause the rotor tip-path and the fuselage to move in unison. Overcontrolling may not cause erratic airspeed and altitude control; they may result from a lack of knowledge of attitude flying techniques.

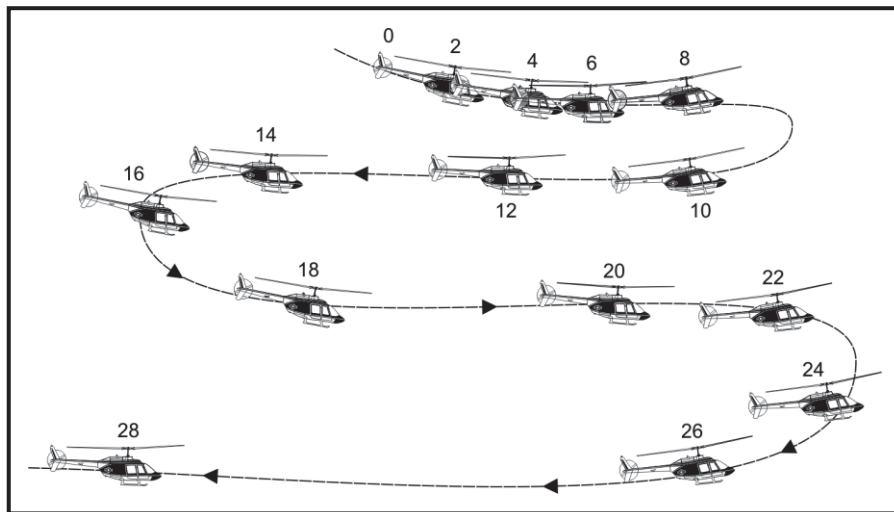

Figure 7-16 Overcontrolling

Cyclic Control Response. The rotor response to cyclic control input on the single-rotor helicopter has no time lag. Rotor blades respond instantly to the slightest touch of the cyclic control. The fuselage response to lateral cyclic however is noticeably different from the response to fore and aft cyclic applications. Normally, considerably more fore and aft cyclic movement is required to achieve the same fuselage response as that achieved from an equal amount of lateral cyclic. This is not a lag in rotor response; rather, it is due to more fuselage inertia around the lateral axis than around the longitudinal axis (Figure 7-17). For single rotor helicopters, the normal corrective device is the addition of a synchronized elevator or stabilator attached to the tailboom. This device produces lift forces that keep the fuselage of the helicopter in proper alignment with the rotor at normal flight airspeed. This alignment helps to reduce blade flapping and extends the allowable CG range of the helicopter; however, it is ineffective at

slow airspeeds.

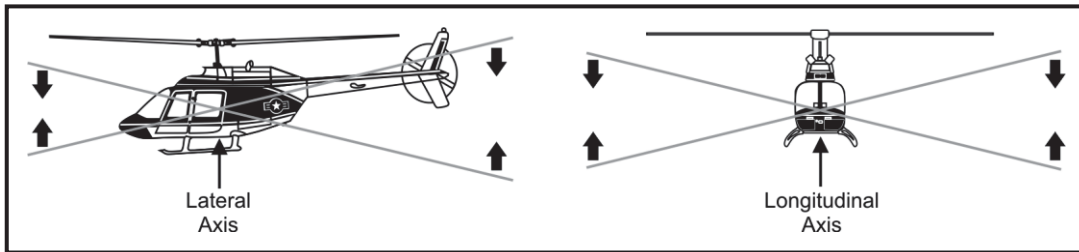

Figure 7-17 Cyclic Control Response Around the Longitudinal and Lateral Axis

Rotors that are attached to the hub by a flapping hinge use centrifugal force to augment the rolling moment imposed in control changes. Teetering systems have all control moments translated to the helicopter mast through the trunnion bearing (Figure 7-18).

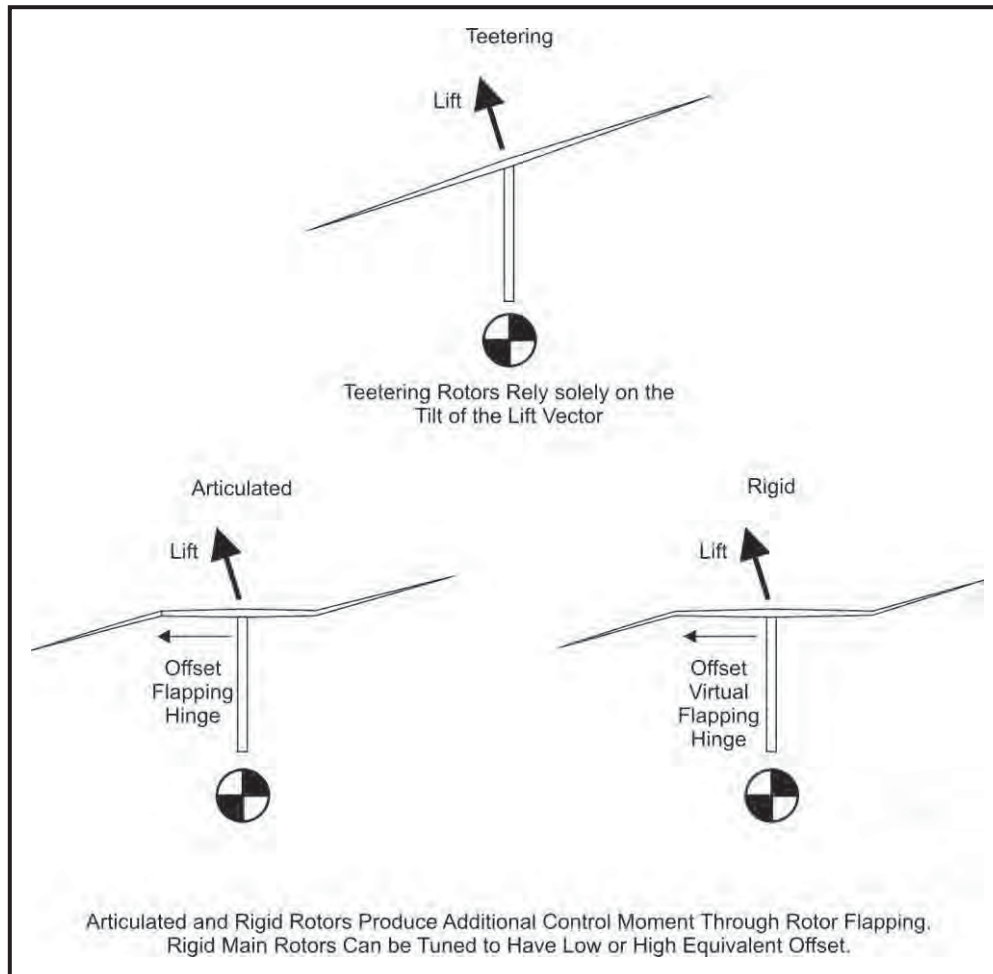

Figure 7-18 Hub Control Moments

Shift of Attitude. Fuel cells normally have a slight aft CG. As fuel is used, the CG migrates forward causing a more nose-low attitude. Because of the fuel expenditure and the lighter

fuselage, aircraft pitch attitudes tend to shift slightly lower. As fuel loads are reduced, drag affects the lighter fuselage more, which results in a slight shift to a more nose-down attitude during flight.

722. CONTROL MECHANISMS

As seen in Figure 7-19 below, torque balance and control mechanisms vary greatly among different configurations. Note in a single MR, the TR provides both torque balance and directional (yaw) control. In a tandem configuration torque balance is provided by having the two rotor systems spinning in opposite directions, while directional control is provided by applying differential cyclic pitch to the two rotor systems.

Helicopter Configuration	Torque Balance	Longitudinal Control	Lateral Control	Height Control	Directional Control
		Pitch Moment	Roll Moment	Vertical Force	Yaw Moment
Single MR, TR	TR Thrust	MR cyclic	MR cyclic	MR collective	TR collective
Coaxial	MR diff torque	MR cyclic	MR cyclic	MR collective	MR diff collective
Tandem	MR diff torque	MR diff collective	MR cyclic	MR collective	MR diff cyclic
Side-by-side	MR diff torque	MR cyclic	MR diff collective	MR collective	MR diff cyclic

Figure 7-19 Control Mechanisms for Various Configurations

723. TRIMMED FLIGHT

Trim. An aircraft is said to be trimmed if all moments in pitch, roll, and yaw are equal to zero. Strictly, an aircraft may be in trim and be rotating about one or more of its axes if that rotation is occurring at a constant rate. Usually, however, we speak of trimming the aircraft for zero rotational rates, and further define it as the attainment of an equilibrium condition “hands off.” This requires, in addition to the zero moment, **zero control force**. The external set of forces on the aircraft determines whether the aircraft is in equilibrium and the internal flight control system mechanism determines whether the condition can be achieved with zero control force.

Hover Trim. Consider the balances of external forces required to achieve equilibrium in a zero wind hover (Figure 7-20). It can be seen that several conditions must be met simultaneously for total equilibrium to exist:

1. The vertical component of rotor thrust must balance aircraft weight.
2. The rotor thrust must be tilted to the left so that its horizontal component balances the tail rotor thrust to the right (otherwise right drift would result). This can be accomplished with slight left cyclic stick or a preset tilt in the rotor hub.

7-20 STABILITY AND CONTROL

3. Since, for the configuration shown, the horizontal component of rotor thrust acts above the line of action of the tail rotor thrust (and is of equal magnitude), a resultant left rolling moment would exist if the CG were vertically below the rotor hub. By hovering with the fuselage in a slight left roll attitude, the vertical component of lift balances the left rolling tendency.
4. The longitudinal CG position must be in line with the rotor thrust line (this determines the equilibrium pitch attitude in hover). For an aft CG, a nose-up attitude is required, and for a forward CG, a nose-down attitude is required.
5. The main rotor torque (tending to yaw the fuselage to the right) is balanced by the tail rotor thrust acting through its long moment arm to the CG.

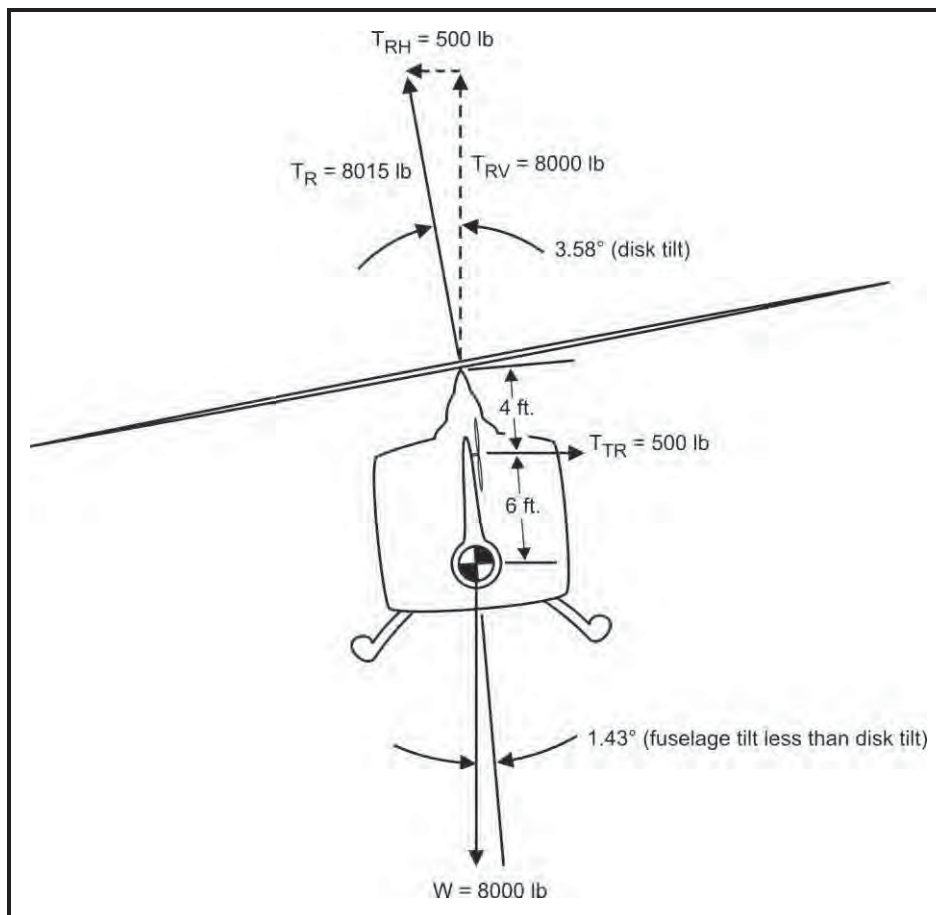

Figure 7-20 Hover Trim

With all forces and moments balanced, the helicopter hovers in its "trimmed" attitude. Note that by positioning the tail rotor sufficiently high (close to rotor hub height) the left rolling tendency is minimized and the helicopter requires little or no bank for equilibrium. Also, the trimmed attitude is dependent on gross weight as well as the CG position. If the gross weight is increased, more rotor torque is required, necessitating more tail rotor thrust. This also increases the amount of disk tilt required to balance side forces. The rolling tendency therefore increases with the

buildup of the two side forces (for the case of the main rotor hub above the tail rotor hub). Hence, more bank to the left is required to displace the CG to the right of the vertical rotor thrust component, thus restoring roll equilibrium. Any lateral displacement of the CG also causes a change in the fuselage trimmed roll attitude.

In hover in a right crosswind, several additional effects determine the trim attitude and the required control displacements:

1. The main rotor torque decreases due to translational lift (as in forward flight) requiring less tail rotor thrust (less left pedal) and less disk tilt (less left stick).
2. The main rotor "blows back," in this case to the left, requiring more right (or less left) cyclic stick (into wind) to keep it in its place.
3. Aerodynamic side forces (parasite drag) on the fuselage tend to drift the aircraft left, requiring additional right (or less left) stick.
4. Aerodynamic side forces on the tailboom and vertical stabilizer tend to weathercock the aircraft to the right (into wind) requiring left pedal increases and more disk tilt (more left stick).

As can be appreciated, these effects each influence both the required stick and rudder positions and the equilibrium flight attitude. For a given steady wind, however, there is some combination of control positions for which all forces and all moments are balanced, and trim is again achieved.

Forward Flight Trim. In forward flight, especially at high speed, strong aerodynamic forces on the fuselage and tail surfaces influence the requirements for trim. The vertical tail, for example (or any tail surfaces that have vertical components), is capable of exerting side forces when a local sideslip condition exists at the tail. This may occur by purposely setting the vertical tail at some angle of incidence relative to the longitudinal aircraft axis or by flying the entire helicopter in a slight sideslip (e.g., one quarter of a ball width at 100 knots). Side forces to the right produce a left yawing moment, which decreases the need for tail rotor thrust.

Longitudinal trim can be a problem at high forward speed. Since a large forward horizontal force is required to overcome parasite drag, the disk is tilted forward appreciably. This creates a nose-down moment about the CG. The aircraft assumes excessive nose-down attitudes at high speed unless some other restoring moment is provided. Horizontal tail surfaces do this by supplying an aerodynamic downforce proportional to fuselage AOA. Thus as speed is increased the nose-down tendency caused by forward rotor tilt is partially compensated for by nose-up moments created by the horizontal surfaces or through the use of "sync-elevators," as described in section 713.

The stability and control characteristics are both measured from a given trimmed condition. If the aircraft is not trimmed, its free flight behavior following a disturbance is affected by the out-of-trim condition as well as the aircraft's basic stability, and the true character of the latter is masked.

Trim potential, stability and controllability are necessarily tied together. Theoretically an unstable aircraft cannot be trimmed, since the slightest atmospheric disturbance will cause it to continuously depart from the original condition. A stable configuration may be easy to trim but controllability could be a problem because the system will resist attempts to change attitude.

THIS PAGE INTENTIONALLY LEFT BLANK

CHAPTER SEVEN REVIEW QUESTIONS

1. If an aircraft demonstrates an initial tendency to return toward its trimmed flight condition following any external disturbance it is said to have _____
_____.
2. As a trimmed helicopter encounters a gust, airspeed increases, and the rotor flaps to restore the aircraft to its trimmed condition. This is an example of _____ stability.
3. As a trimmed helicopter encounters an upward gust in forward flight, the gust produces a higher AOA on the advancing blade than the retreating blade. This is an example of _____ stability.
4. Why is cyclic authority lost when CG is out of limits?

5. The apparent axis of rotation of the main rotor system is called the _____.
6. The actual axis of rotation is called the _____.
7. When the virtual axis is displaced, the _____ will attempt to align itself with it, causing _____.
8. The center of mass of the entire aircraft is called the _____.
9. How does a multi-rotor headed helicopter account for torque effect?

10. When all of the moments about the pitch, roll, and yaw axes are zero, the aircraft is considered to be _____.
11. When an aircraft's CG is out of limits, a catastrophic result may be _____
_____.
12. Which of the following statements is characteristic of geometric imbalance in the semi-rigid rotor system?
 - a. Cannot be eliminated due to the span wise rigidity of the blades
 - b. Is compensated by adjustment of the blade root counter weights,
 - c. Is nearly eliminated by aligning the blade's center of mass with the center line of the flapping hinge
 - d. Is compensated through the alignment of the blade's centers of pressure and the rocking hinge

13. What will occur when the centers of mass in the rotor blades are at different radii to their mechanical axis?

- a. Geometric imbalance
- b. Geometric precession
- c. Flapping
- d. Gyroscopic precession.

14. With an engine loss in a hover, the pilot must move the _____ to the _____ when the failure occurs as the tail rotor effect is eliminated.

- a. collective. . . up position
- b. collective ... down position
- c. cyclic ... left
- d. cyclic ... right

THIS PAGE INTENTIONALLY LEFT BLANK

CHAPTER SEVEN REVIEW ANSWERS

1. static stability
2. airspeed
3. AOA instability
4. The virtual axis cannot be tilted enough to offset the extreme CG
5. virtual axis
6. mechanical axis
7. mechanical axis . . . acceleration
8. CG
9. The rotor systems turn in opposite directions, canceling the torque effect.
10. trimmed
11. departure from controlled flight
12. c
13. a
14. d

CHAPTER EIGHT ENGINE AND AIRCRAFT PERFORMANCE

800. INTRODUCTION

The purpose of this chapter is to aid the student in understanding the role of helicopter aerodynamics principles in both engine performance (power available) and aircraft performance (power required).

801. LESSON TOPIC LEARNING OBJECTIVES

1. **Terminal Objective:** Partially supported by this lesson topic:

Upon completion of this unit of instruction the student will understand the factors that determine and affect power required and power available for flight.

2. **Enabling Objectives:** Completely supported by this lesson topic:

- a. Describe how power required to hover is affected by changes in gross weight, altitude, DA, and rotor speed.
- b. Use a chart to determine airspeed for maximum range and maximum endurance/rate of climb IAW NATOPS.
- c. Describe effect of wind on maximum range airspeed.
- d. Describe the physical properties that limit engine performance.
- e. Use a chart to convert torque to shaft horsepower IAW NATOPS.
- f. Use a chart to determine power (torque) available and power required to hover in ground effect (HIGE) and out of ground effect (HOGE) IAW NATOPS.
- g. Use a chart to determine distance required to clear an obstacle on takeoff IAW NATOPS.
- h. Describe conditions which can cause an aircraft's power required to exceed its power available and recovery procedures.
- i. State the environmental factor which most significantly affects power available.
- j. State the effect the tail rotor will have on power available to the main rotor.

802. REFERENCES

1. Fundamentals of Aerodynamics, NAVAVSCOLSCOM-SG-111
2. Rotary Wing Aerodynamics for Naval Aviators
3. Fundamentals of Flight
4. Helicopter Aerodynamics
5. NAVAIR 01-H57BC-1 NATOPS

803. STUDY ASSIGNMENT

1. Review Chapter Eight.
2. Answer the Review Questions.

804. GENERAL

Helicopter aircraft and engine performance require an understanding of the power required curves, power available, and the relationship between them.

Power is required to overcome the drag produced by the two rotors and the fuselage. The power available to meet this power requirement is produced by a turboshaft engine with numerous rotor and stator blades designed using aerodynamic principles. After these principles are covered, an overview of various engine malfunctions with their aerodynamic causes is presented. A brief introduction to aircraft performance is included here to establish general principles. Turbojet aircraft produce thrust directly from their engines and do not turn a propeller or rotor. As such, jet aircraft performance charts only slightly resemble helicopter drag curves (Figure 8-1). For each pound of drag generated by the aircraft at a specific airspeed, a pound of thrust must be generated by the jet in order to maintain level flight. Thrust is the force opposite the acceleration of air particles by the jet engine. The amount of thrust produced by a jet engine is directly proportional to fuel flow and therefore endurance and range performance may be determined from an aircraft total drag curve.

The differences between the two types of performance curves can be attributed to the different contributions of profile and induced drag in the helicopter. The helicopter rotor also produces thrust, but the production of thrust is not directly related to the fuel flow for turbo-shaft engines. Turbo-shaft fuel flow is more closely related to how much power is being produced by the engine. Accordingly, a total drag curve cannot be used in the same way as a performance chart for helicopters.

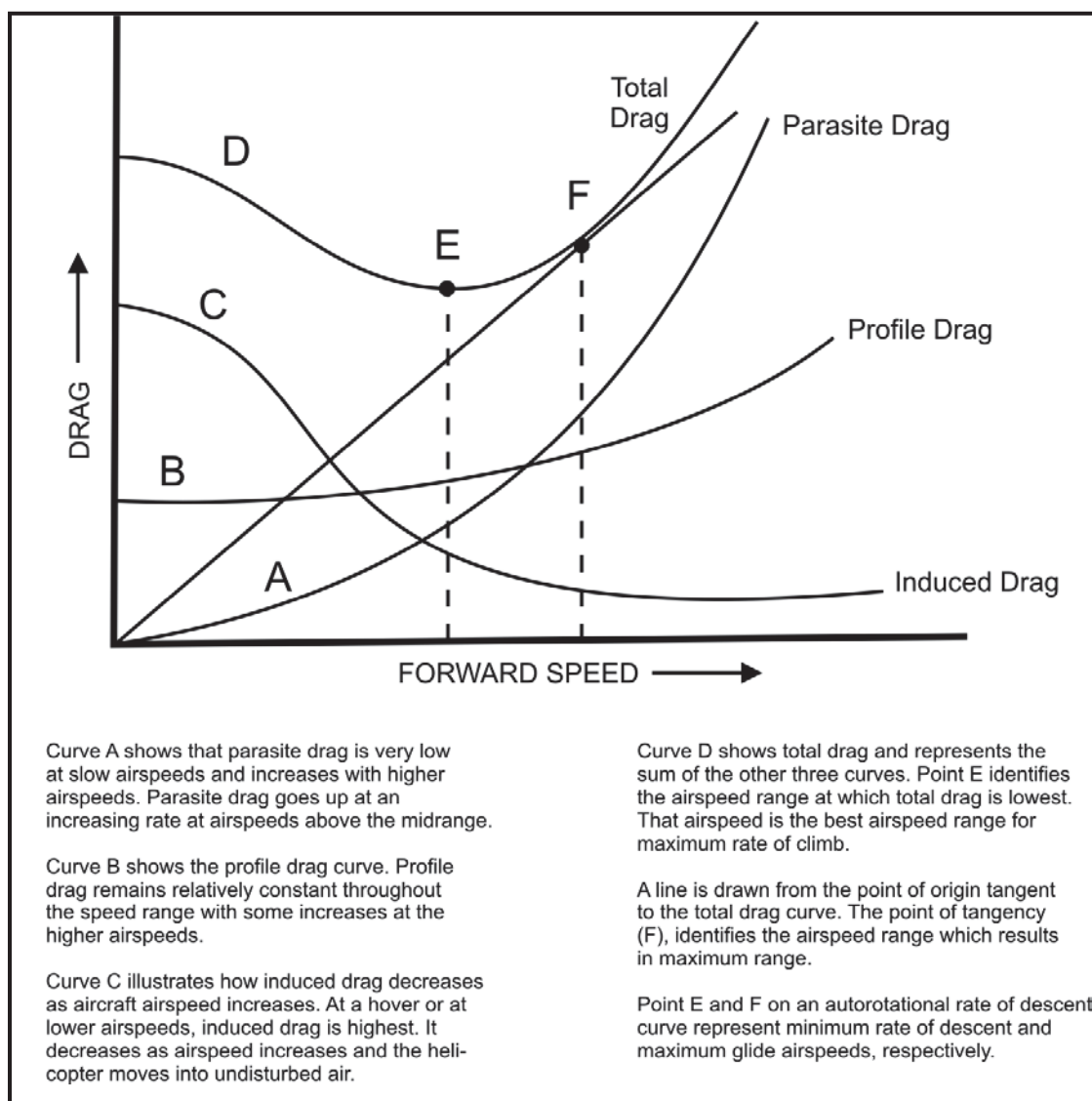

Figure 8-1 Total Drag Curve

Instead, “**power required curves**” (or more specifically, “**fuel flow curves**”) are presented in operator’s manuals for use in mission planning. Power is simply the rate of doing work. James Watt, the Scottish inventor who improved upon the steam engine, calculated that a horse can do 550 foot-pounds of work in one second. A mathematical variation of that calculation provides that if drag is multiplied by the aircraft velocity (and divided by 325, if knots are used), each point on an aircraft’s drag curve may be re-plotted as a point on a power required curve. Such a power required curve is shown in Figure 8-2 and although very similar to the drag curve, the points may not be identical. For this reason, most discussions of helicopter performance centers on power required curves rather than drag curves. Note that this is a “power vs. airspeed” relationship (power is on the vertical axis) and not a “drag vs. airspeed” relationship. Power required curves can be plotted using “torque,” horsepower or fuel flow since they are all related to power.

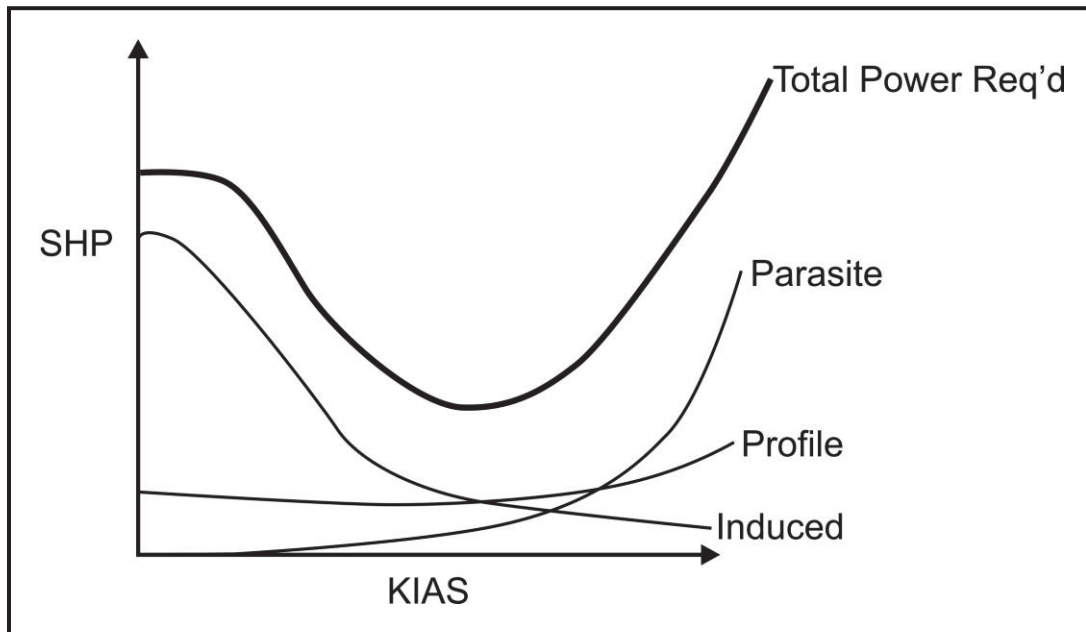

Figure 8-2 Power Required Versus Airspeed Curve

Most turbine helicopters are equipped with a gauge for measuring torque which may be viewed by the aviator in the cockpit. Since power equals torque times rpm, if the rpm remains constant, the torque is a direct representation of current engine power output. Further, a fuel flow scale is usually provided opposite the torque scale of a cruise chart, thereby enabling the aviator to convert torque directly to fuel flow.

It is important to note that the lowest point on the power required curve (Figure 8-2) is the point of minimum power required (best lift to drag ratio) and not necessarily the point of minimum drag (as is the lowest point on the total drag curve). The point of minimum power results in the lowest fuel flow and is therefore the airspeed for **maximum endurance**. The airspeed for minimum power is slower than the airspeed for minimum drag because a decrease in velocity to the minimum power airspeed decreases the power required, even though flying at any airspeed below minimum drag actually increases drag. However, because the bottom of the drag curve is nearly flat, the slight increase in drag is more than offset by the decrease in velocity, which slows the work rate and therefore results in an overall reduction in power required.

805. POWER REQUIRED

Now that we have discussed how rotor blades and rotor systems work, let's investigate how they work with a helicopter fuselage and all of the forces that come into play. For a helicopter to remain in steady, level flight, these forces and moments must balance. These forces exist in the vertical plane (Figure 8-3), horizontal plane, and about the CG in the form of pitching moments.

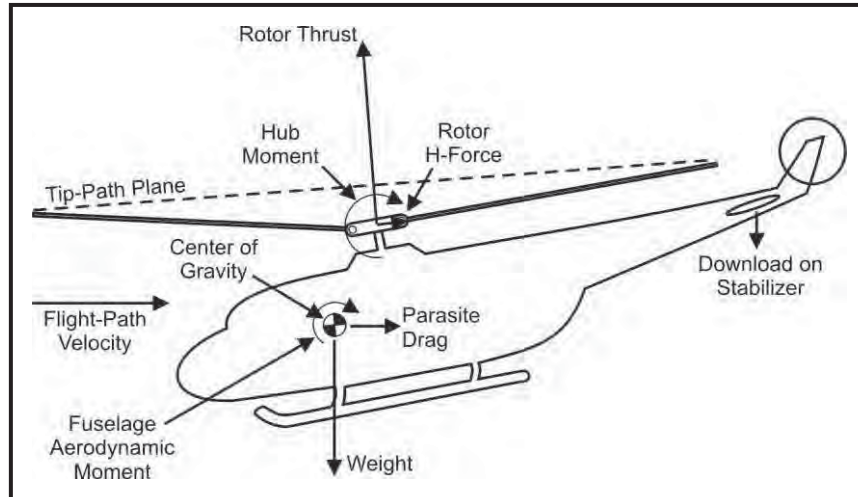

Figure 8-3 Aerodynamic Forces Affecting Power Required

To begin the discussion of these forces, we will discuss the types of power required due to these various forces (Figure 8-4).

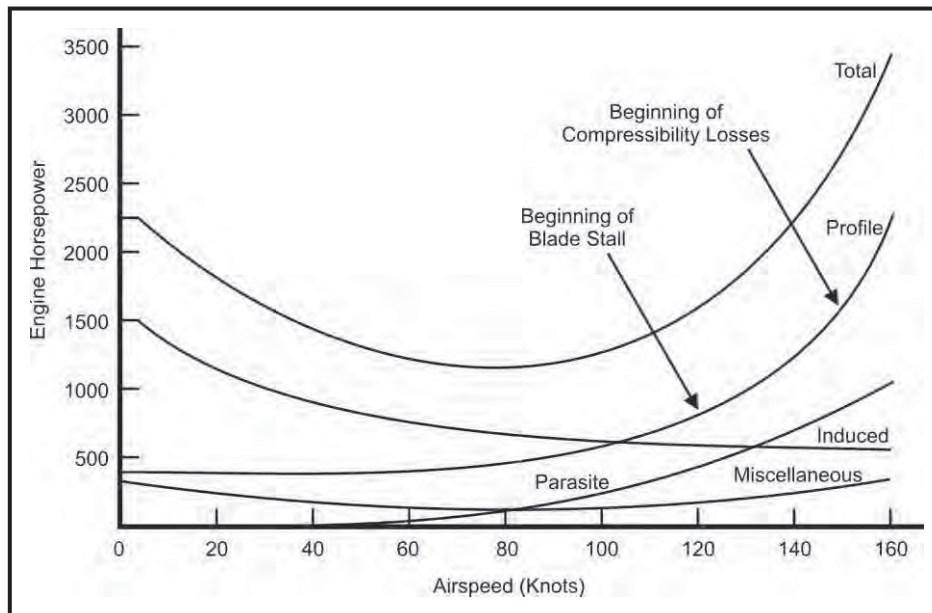

Figure 8-4 Power Required Curves Versus Airspeed

How much power does it take? In a hover, two types are necessary - induced and profile power. **Induced power** is power associated with the production of rotor thrust. This value is at its highest during a hover (60 – 85 percent of total main rotor power) and decreases rapidly as the helicopter accelerates into forward flight. During forward flight, the increase in mass flow of air introduced to the rotor system reduces the amount of work the rotors must produce to maintain a constant thrust (this concept will be explained in greater detail in a later section). Therefore, induced power required continues to go down with increasing airspeed.

Profile power, which can be thought of as "main rotor turning power," accounts for 15 – 40 percent of main rotor power in a hover and is used to overcome friction drag on the blades. It increases slightly with increasing airspeed.

In forward flight, **parasite power** joins forces with induced and profile power to overcome the parasite drag generated by all the aircraft components, excluding the rotor blades. Parasite power can be thought of as the power required to move the aircraft through the air. This power requirement increases in proportion to forward airspeed cubed. Obviously, this is inconsequential at low speed, but is significant at high speed and is an important consideration for helicopter designers to minimize drag. This is a challenging task due to design tradeoffs of the high weight and cost of aerodynamically efficient designs versus structural requirements dictated by required stiffness, mechanical travel, and loads.

In addition to the drag curves which are the basis for the power required curves, there is a fourth power requirement, labeled "miscellaneous" in Figure 8-4, which is taken into account when power required curves are developed for specific rotorcraft. This is the power required to run the tail rotor and accessories such as generators, hydraulics, etc. Accessory power requirements remain relatively constant independent of airspeed, while tail rotor power required tends to decrease with increasing airspeed as previously discussed. Depending on the charts used, this additional power requirement is sometimes combined with the profile power requirement, creating a "total rotor profile power" required to maintain a given rotor rpm, taking into account the rotor profile drag as well as the tail rotor and accessory requirements.

The smaller horizontal force, H-force, is produced by the unbalanced profile and induced drag (or inplane drag in some books) of the main rotor blades. Tilting the rotor disk forward from a fraction of a degree at low speed to about 10° at max speed compensates for this. We will not be getting into additional discussions about H-force in this workbook.

Different flight regimes are performed more efficiently at different forward speeds. The bowl-shape of the power required curve graphically illustrates the reason why (Figure 8-5). Optimum speeds determined by this curve are maximum loiter time (endurance), minimum rate of descent in autorotation, best rate of climb and maximum range airspeed; although these optimal speeds are discussed in more detail in Chapter Ten, they are briefly introduced here.

Best rate of climb airspeed is formed at the point where the difference is a maximum between power required and power available. The bottom of the curve is called the **bucket airspeed**. Since the goal of achieving maximum loiter time is making the available fuel last as long as possible, and since fuel flow is proportional to engine power, maximum loiter time should also be at this point.

Near this speed, minimum rate of descent in an autorotation is also found, since the power required to keep the aircraft airborne is at a minimum.

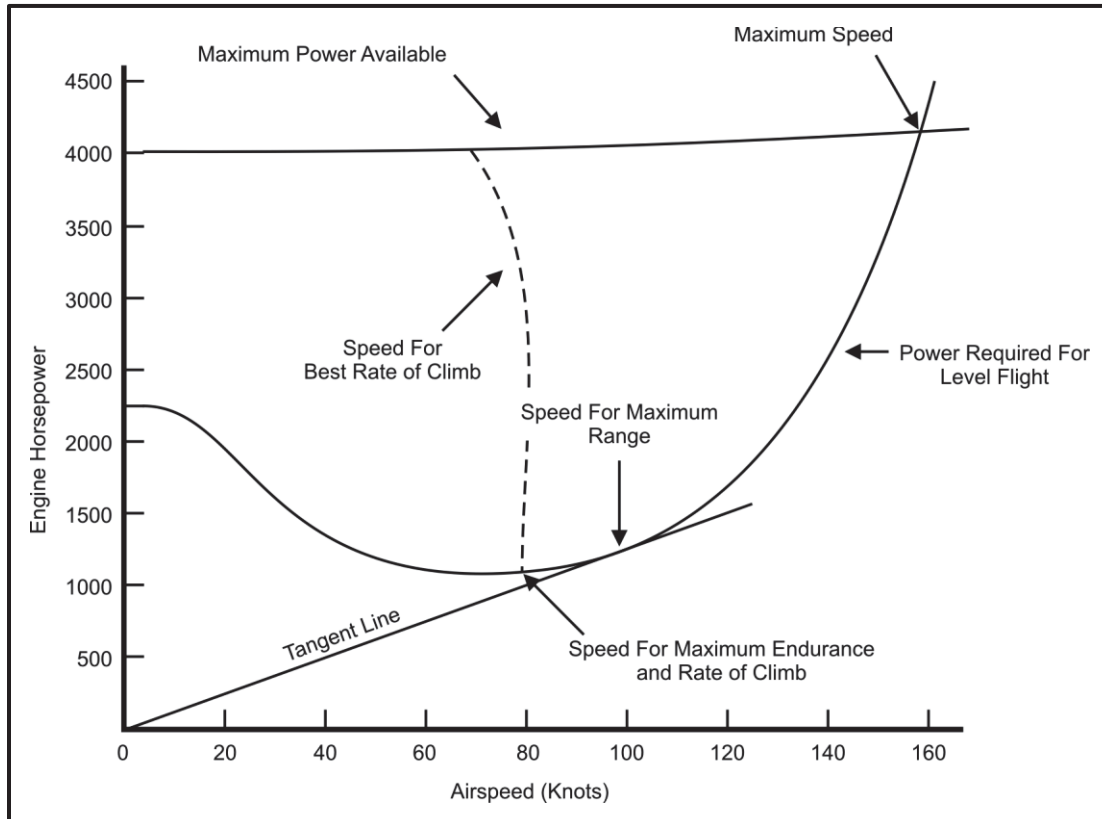

Figure 8-5 Optimum Airspeeds

The point on the power required curve corresponding to the point of minimum drag versus airspeed on the drag curve is at an airspeed greater than that for minimum power (bucket airspeed). This is the airspeed for **maximum range** and is where the ratio of fuel flow to velocity is at a minimum value. This point is shown in Figure 8-5 and 8-6 at the point of tangency of the power required curve and a straight line drawn from the origin, providing the best power or fuel flow to airspeed (thus drag) ratio. Maximum range speed is found on the fuel flow curve by drawing a line tangent to the curve from the origin (Figure 8-6). This ratio of speed to fuel flow shows the distance one can travel on a pound of fuel on a no-wind day. If there is a headwind, the line should be originated at the headwind value, which derives a higher speed and lower range. For a tailwind, the optimum airspeed decreases, but the range increases significantly. On generic charts like the one above, the speed for maximum range and autorotation maximum glide distance sometimes appear to be the same. Best airspeed for maximum glide in an autorotation is also affected by headwinds and tailwinds just like maximum range airspeed. However, when using aircraft specific charts, that is not usually the case and the two speeds are different, as you will learn for the TH-57. The TH-57 NATOPS has specific charts for determining the maximum glide range airspeed and minimum rate of descent airspeed. These will be covered in a later chapter.

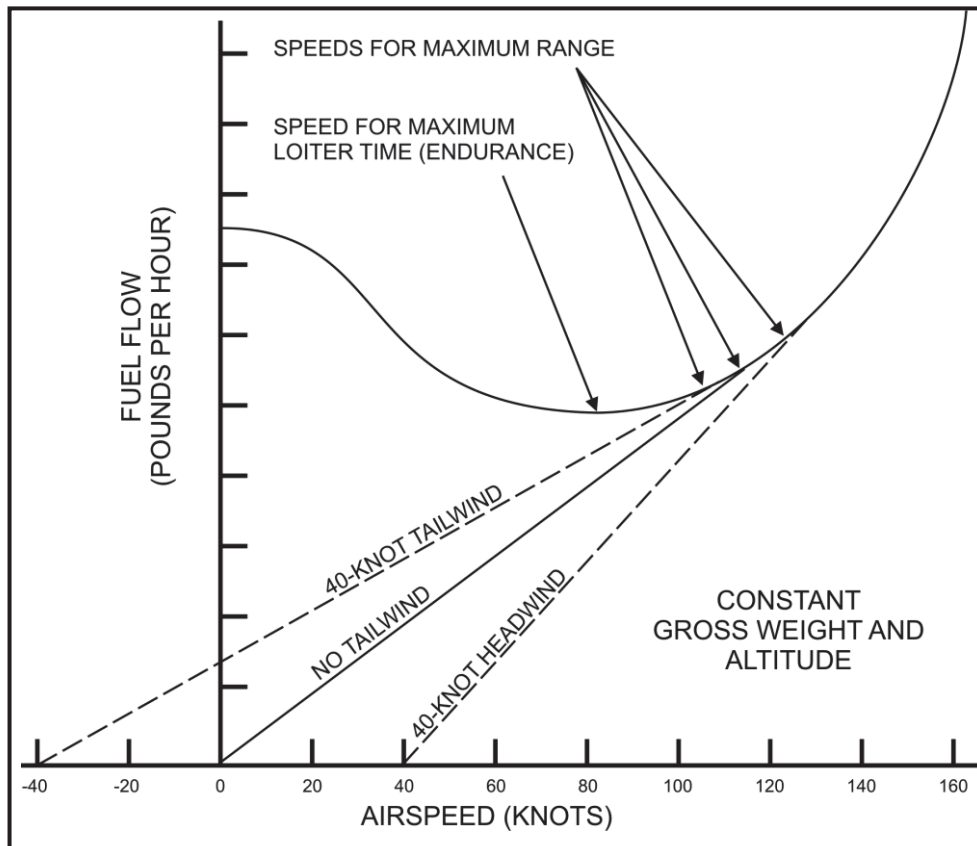

Figure 8-6 Maximum Range Airspeed Adjustment for Winds

806. POWER AVAILABLE

Air density (DA) is the environmental factor which most significantly affects power available. Less dense air requires that the engine works harder to produce the same amount of mass flow. Power available is directly affected by density to such a degree that power available at a given DA can be calculated by simply multiplying power available at standard sea level by the density ratio in the ambient conditions.

$$\text{Power}_{\text{avail}} = \text{Power}_{\text{sea level}} \times \text{density ratio } (\sigma)$$

This is generally true in regions of relatively normal temperature variation. However, in locations of extremely wide temperature variations such as the desert environment, the temperature can have an extra degrading effect on engine power available. This information is found from close inspection of the NATOPS power available charts and requires a large temperature variation to realize.

Other factors limiting power available. Operating conditions that affect fuel flow or airflow directly affect the ability of the engine to generate power. Some of those factors follow:

1. Fuel Flow Limitation (cold) - As temperature decreases the density of air increases so the

8-8 ENGINE AND AIRCRAFT PERFORMANCE

fuel flow must increase in order to maintain the stoichiometric fuel/air ratio for complete combustion. However, the amount of fuel flow through the fuel nozzles has a limit; therefore at cold temperatures the fuel/air ratio will not be optimum, and incomplete (lean) combustion will occur, resulting in less power available.

2. Turbine Temperature Limitation (hot) - The materials used to build turbines have definite stress and temperature limits. To avoid unacceptable creep or component failure, turbine temperature must be limited. Depending on aircraft manufacturer this can be called exhaust gas temperature (EGT), turbine outlet temperature (TOT) or turbine inlet temperature (TIT).
3. N_g -Gas Generator Limitation (hot) - As the OAT increases the density of air decreases, therefore the gas turbine has to rotate faster in order to deliver the same mass flow rate. This increased rotational speed required at higher temperatures can approach limits that have been established to counter centrifugal loads on the gas turbine blades.
4. Age of the engine - Compressor blades erode with time, and their degradation results in loss of blade area that will degrade engine performance.
5. Component rating degradation - Transmission components have material limitations, so their torque capacity must be considered.
6. Humidity/Moisture Effect - Increases in humidity/moisture have a counteracting effect in that the associated decrease in air density is detrimental while the reduced combustor inlet temp (T3) is beneficial. Hence humidity/moisture has a negligible effect on gas turbine engines.
7. Torque limits - drive train limits, including drive shaft and transmission.
8. Airspeed effects (ram air) - Airspeed increases the flow rate into the engine, but at the speed at which rotorcraft operate this effect is negligible.

NATOPS Charts. Familiarization with all performance charts in the NATOPS is of paramount importance. While the pilot must master interpretation of all the charts, this course will introduce the student to the determination of power (torque) available/required to hover IGE/OGE, distance required to clear an obstacle, and conversion of torque to shaft horsepower, among other things. *Therefore, the student is expected to become familiar with all NATOPS performance charts prior to class.*

807. EFFECT OF TAIL ROTOR ON POWER AVAILABLE

Since the engine drives both the main rotor and the tail rotor, the tail rotor does not affect the power available that the engine produces; rather, it requires that the power be shared between the two rotor systems, reducing power available for the main rotor. The tail rotor uses 5-15% of the total power available, therefore leaving only 85-95% for the main rotor. Although other frictional losses of the drive train may be significant, the tail rotor robs the greatest amount of power from the main rotor. So when does the tail rotor make its greatest demands on the engine power available? As one might imagine, when the greatest requirements are on the main rotor;

for example, in the climb, termination of a steep approach, when power required to perform a maneuver is equal to or exceeding the power available, and/or when rotor rpm is drooping, the main rotor system is creating the greatest amount of torque, therefore, the anti-torque requirements from the tail rotor are greatest. However, since the main rotor and tail rotor are driven by a common system, when main rotor rpm droops, tail rotor demand is highest and it is most sensitive to its own decreased rpm.

It should be clear then that for each of these maneuvers, the time to insure adequate power is available to maintain tail rotor and main rotor authority is prior to the maneuver. This highlights the critical importance of in-depth performance planning prior to flight, as well as careful re-evaluation during flight should the mission require any alteration to the planned flight. When the margin for error is minimal, unnecessary maneuvering should be kept to a minimum, and increased vigilance is required to be best prepared for any unanticipated situation. As with any other aspect of aviation, expect the unexpected, and then vortex ring state (VRS), PR Exceeds PA, or even an engine failure won't catch you unprepared.

808. POWER REQUIRED EXCEEDS POWER AVAILABLE

When power required for a maneuver exceeds power available ($P_R > P_A$) under the ambient conditions, an uncommanded descent or deceleration will result. Aggravating factors include: high G-loading, high gross weight, high DA, rapid maneuvering (quick stops), slow spool up time, loss of wind effect, loss of wind direction, and loss of ground effect (transiting from the deck of a ship).

$P_R > P_A$ Indications. Power required exceeding power available becomes dangerous when operating in close proximity to obstructions where the pilot may not have maneuvering airspace to recover prior to impacting the obstacle. Along with the uncommanded descent or deceleration, rotor droop and associated loss of tail rotor authority (LTA) may result.

In addition to proper performance planning and situational awareness of the above aggravating factors, the pilot should avoid excessive maneuvering, high descent rates, and downwind takeoffs and landings, especially in environmental conditions where power available may be marginal.

Power required exceeding power available is differentiated from vortex ring state (VRS) by uncommanded descent being associated with max allowable torque and/or rotor droop and possible LTA. VRS is not normally associated with either rotor droop or LTA. VRS and LTA will be discussed in more detail in a later chapter.

Induced power. Induced power requirements change as forward airspeed is introduced. The requirement for a mass flow of air still exists, but forward velocity increases the mass flow rate so the rotor does not need to apply as much work on the air, thus less power is required. At speeds beyond that at which the tip vortices are outrun (speed for translational lift) the rotor disk acts in a manner that is similar to a conventional wing. In the induced velocity equations V_f is forward velocity and V_{ih} is induced velocity in a hover. Density, disk area and thrust (weight) are the same terms used in the past. When we combine this change in induced velocity with our original power equation ($P = F \times V$) we get the induced power required equation in forward

flight.

$$Power_{induced} = \frac{T^2}{2\rho A_{Disk} V_f}$$

This is an approximation based on fixed-wing aircraft and does not apply in hovering flight. The equation for a helicopter is much more complex so the equation above is often used for explanation purposes since it gives a good solution once moderate airspeeds are achieved (on the order of 40 knots or so). The equation shows that the induced power requirement is inversely proportional to forward flight speed and directly proportional to weight. A plot of induced power required vs. forward airspeed at a constant altitude and weight is presented in Figure 8-7.

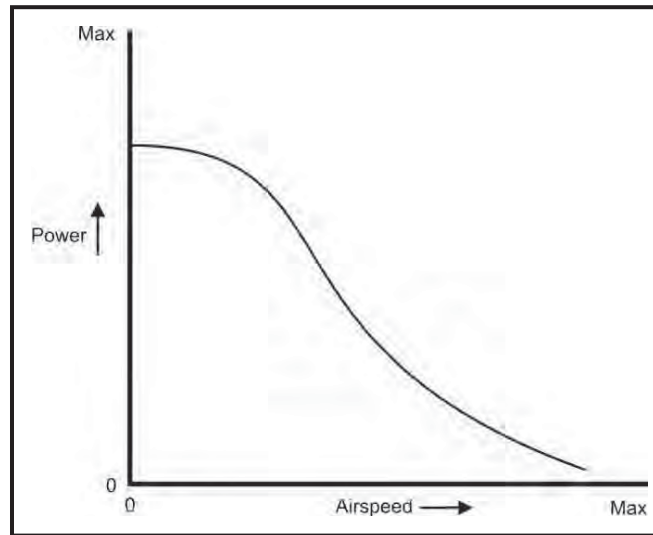

Figure 8-7 Induced Power Required

Parasite power. Just as high induced power requirements can cause a power required exceeding power available situation at a hover or slow airspeeds, parasite power requirements can cause the situation at higher speeds. Recall that parasite drag increases with airspeed, therefore the power to overcome parasite drag increases with the cube of the airspeed (v^3) (Fig 8-8).

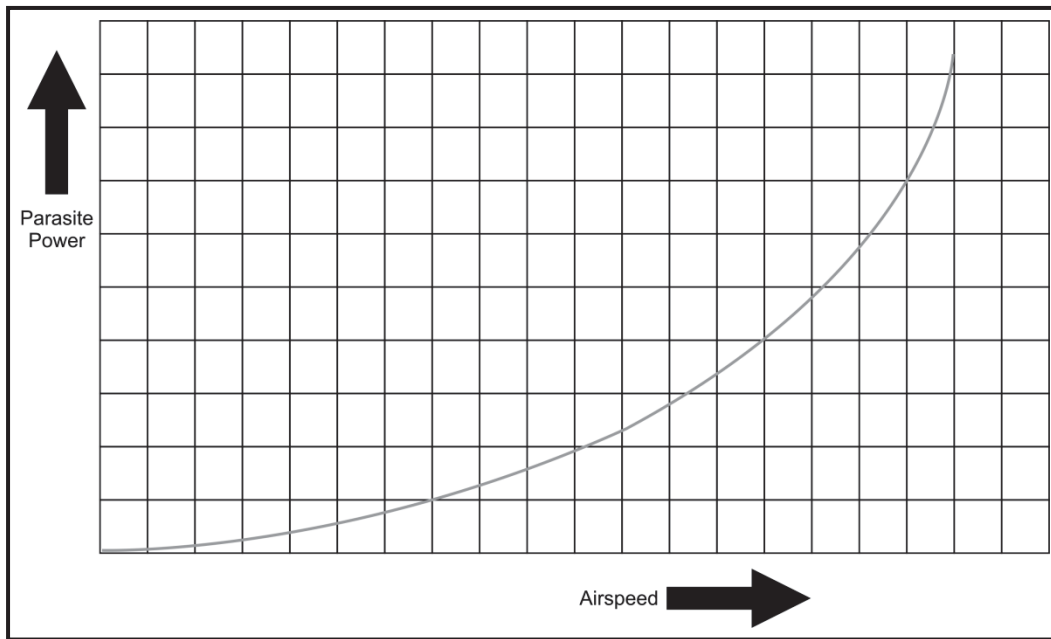

Figure 8-8 Parasite Power Required

The point where power required exceeds engine power available at high speed is commonly referred to as V_H or the maximum speed in level flight at maximum power without an uncommanded descent developing. V_H should not be confused with V_{NE} (Velocity never exceed) which is a structural limitation. V_{NE} of an aircraft is the V speed which refers to the velocity that should never be exceeded due to risk of structural failure, due to calculated factors such as wing, tail, or airframe deformation or due to aeroelastic 'flutter' (unstable airframe or control oscillation). V_{NE} is specified as a red line on many airspeed indicators. This speed is specific to the aircraft model, and represents the edge of its performance envelope in terms of speed.

Excess Power. Because power required exceeding power available is often associated with lower airspeeds, the induced power requirement may become critical. As airspeed decreases during the approach or maneuvering, induced power required increases, so deceleration with a constant collective setting moves the helicopter into a regime where excess power (difference between available and required) steadily decreases (Figure 8-9). Each aircraft is inherently different, and experiences a different amount of translational lift at different airspeeds. The determining factor in the amount of "extra lift" available is determined by the slope of the induced power required curve. Typically, translational lift is experienced during transition from hover into forward flight at airspeeds between 13 - 24 knots, depending on disk size, blade area, and rpm.

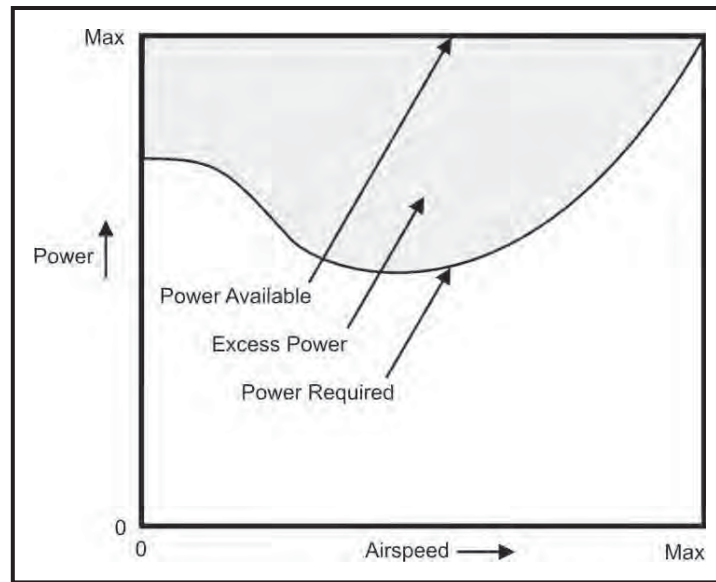

Figure 8-9 Decrease in Excess Power as Airspeed Decreases

It is a fact that when a helicopter transitions from forward flight to a hover, it experiences decreased performance because of increased induced power requirements that stem from the tip vortices that are generated in a hover. As airspeed decreases to near 13 - 24 knots the entire rotor begins to experience recirculation of vortices, and vortices impact the fuselage and tail. Power required increases and if power available is marginal, or the aircraft is not in ground effect, conditions are ripe for an uncommanded descent, rotor droop, and/or LTA.

809. CASE STUDY – POWER REQUIRED, EXTREME EXAMPLE

Knowing how altitude affects one's helicopter can be essential when operating on the margins of performance. An extreme example of a high DA and gross weight situation is the Mount Everest rescue of 1996 in which a Nepalese helicopter pilot volunteered to rescue climbers after the area contract pilots refused to accept the mission due to the altitude and poor weather conditions.

LtCol Maden K. C. of the Royal Nepalese Army understood very well the power requirements of his single-engine AS 350. He knew that higher altitude would increase his power required, and that at high DAs turbo shaft engines provide less horsepower. Based upon his calculations, however, he figured that with weight adjustments and careful control of airspeed he could perform a higher rescue than had ever previously been achieved.

On May 13, 1996, LtCol Maden rescued two climbers, an American and a Taiwanese, at an elevation of 20,000 ft. on the slopes of the highest peak in the world. He flew 2500 ft. above the helicopter's 20,000 ft. service ceiling to get over a ridgeline where he was successful in locating the climbers. After several landing attempts that resulted in a decrease in rpm and loss of altitude, he realized the need to shed some weight so he continued down the mountain to a lower elevation to drop off his copilot. As the afternoon sun began setting, he still knew the helicopter

would have a difficult time hovering **in-ground-effect** so a no-hover landing was attempted. Concerned with the firmness of the snow, he hoped for hardpack and got it. He stayed light on the skids and took one climber at a time, staying in ground-effect until he could push the nose of the helicopter over to pick up airspeed while following the down-sloping terrain. He successfully picked up the second climber in the early evening and is credited with performing the highest helicopter rescue in the world.

Only through his familiarity with the austere flying environment and precise understanding of power available versus power required was LtCol Maden able to successfully achieve such a mission!

In conclusion, a change in aircraft configuration, gross weight and environment should activate a switch inside our helmet telling us to closely review the power computation sheet and understand what these changes do to helicopter performance. Above all, fly the charts!

CHAPTER EIGHT REVIEW QUESTIONS

1. A primary limiting factor on the operation of a turbine engine is _____, and its effect on the turbine blades.
2. Using Figure 23-4 from the TH-57 NATOPS, what shaft horsepower equates to 70 % torque? _____
3. Using Figure 23-5 from the TH-57 NATOPS, determine maximum torque (Q) available for PA = 4000', OAT = 40°C. _____
4. Using Figure 24-1 from the TH-57 NATOPS, determine torque required to hover at 2 feet at PA = 5000', GW = 3100 lbs, and OAT = 30 °C. _____
5. Using Figure 24-1 from the TH-57 NATOPS, determine torque required to HOGE at the gross weight and atmospheric conditions listed in question #4 above. _____
6. Using Figure 24-2 from the TH-57 NATOPS, determine takeoff distance needed to clear a 75' obstacle if a max hover height of 20' is used. _____
7. Using Figure 26-1 from the TH-57 NATOPS, at PA = Sea Level GW = 3200 lbs, and OAT = 15 °C, determine maximum range and maximum endurance airspeeds. _____
8. Increases in helicopter weight cause what reaction?
 - a. An increase of power required at all airspeeds
 - b. A reduction of power available
 - c. An increase in power available
 - d. An increase of maximum excess power
9. With cockpit indications of increased rate of descent, high N_g , high TOT, and decaying N_r , the pilot is experiencing
 - a. retreating blade stall
 - b. VRS
 - c. power required greater than power available
 - d. excessive blade flapping
10. If settling is encountered with a reduced airspeed at maximum power, what should be regained to ensure level flight?
 - a. Original power
 - b. Original torque
 - c. Original airspeed
 - d. Original angle-of-attack

CHAPTER EIGHT REVIEW ANSWERS

1. exhaust gas temperature
2. 220 shaft horsepower
3. 97%
4. 80%
5. 98%
6. 600'
7. Max endurance = 52 KIAS, Max range = 110 KIAS
8. a
9. c
10. c.

NATOPS PART XI QUESTIONS

1. Regular use of this chapter is recommended for the following four reasons:

2. The information presented is primarily intended for _____, but it may also be used in _____.
3. What do hash lines indicate on the charts?
4. What do shaded regions indicate on the charts?
5. Name the four data bases used to derive the charts.

6. Solve for TAS given the following:

IAS = 102 knots

OAT = 22 °C

PA = 4000 feet

7. For a given torque at 100% N_r find the shaft horsepower.

Torque = 60%

Torque = 88%

Torque = 100%

8. Given a PA and OAT combination find the Calibrated Torque percent (5 Minute Operation).

10,000 PA, 0 °C

6,000 PA, 20 °C

SL, 40 °C

9. Given a PA and OAT combination find the Calibrated Torque percent (Continuous Operation).

10,000 PA, 0 °C

6,000 PA, 20 °C

SL, 40 °C

10. Find the Calibrated Torque given the following information:

2500' PA
10 °C
3000 lbs
four foot skid height

11. Determine the Maximum Continuous skid height given the following information:

2500' PA
22 °C
3000 lbs

12. Determine the HOGE max gross weight given the following information:

1800' PA
15 °C

13. Determine the time, distance and fuel to climb at maximum torque from sea level to 4000 PA given the following information:

3000 lbs
22 °C

14. Determine the rate of climb or descent given the following calibrated torque change:

3000 lbs
35.5% Q

15. At 10,000 feet PA and a OAT of 25 °C what is the maximum gross weight at which the helicopter can sustain a 100 fpm climb at 50 KIAS?

THIS PAGE INTENTIONALLY LEFT BLANK

NATOPS PART XI ANSWERS

1. Regular use of this chapter is recommended for the following four reasons:
 - a. Knowledge of Performance Margin will allow better decisions
 - b. Situations requiring max performance will be easily recognized
 - c. Familiarity will make computation quick
 - d. Accurate estimation of effects of variables
2. flight planning, flight
3. Limit lines
4. Precautionary or time-limited operation
5. Name the four data bases used to derive the charts.
 - a. Flight Test Data – Test pilot, specific conditions, calibrated instruments
 - b. Derived from Flight Test Data – Flight test data from similar aircraft (small corrections made)
 - c. Calculated Data - Non-Flight testing of the complete aircraft
 - d. Estimated Data - Based on aerodynamic theory, not verified by flight test.
6.
 - a. Convert IAS into CAS using the Airspeed Calibration Chart. 100 KTAS
 - b. Find “one over square root of sigma” from the DA/Temperature Conversion Chart. 1.09
 - c. $TAS = CAS$ (“one over square root of sigma”). 109 KTAS
7.
 - a. 190 SHP
 - b. 280 SHP
 - c. 318 SHP
8.
 - a. 93%
 - b. 100%
 - c. >100%

9.
 - a. 83%
 - b. 86%
 - c. 89%
10. 76%
11. 10 feet
12. 3200 lbs
13.
 - a. 2.5 min
 - b. 2.6 Nm
 - c. 1.25 gal
14. 1000 fpm
15. 3200 lbs

THIS PAGE INTENTIONALLY LEFT BLANK

CHAPTER NINE HOVER PERFORMANCE

900. INTRODUCTION

The purpose of this chapter is to aid the student in understanding the basic aerodynamic theories of hovering flight as it relates to helicopter aerodynamics. This lesson topic will introduce the concepts of induced velocity, vortices, ground effect, and translating tendency.

901. LESSON TOPIC LEARNING OBJECTIVES

1. **Terminal Objective:** Partially supported by this lesson topic:

Upon completion of this unit of instruction the student will analyze the aerodynamics associated with hovering flight.

2. **Enabling Objectives:** Completely supported by this lesson topic:
 - a. Describe a vortex, how it is formed, and how it affects induced velocity and the efficiency of the rotor system.
 - b. List effects of AOA, AR, weight, and DL on vortex strength.
 - c. Recall the definition of ground effect, and describe how it affects power required.
 - d. Recall the definition of translational lift as related to wind conditions in hovering flight, and describe how it affects power required.
 - e. Using a blade element diagram, show how the AOA is affected by ground effect and translational lift.
 - f. On a conventional helicopter, describe how tail rotor thrust affects hover attitude.
 - g. Explain the effects of wind on a helicopter during hovering turns.

902. REFERENCES

1. Fundamentals of Aerodynamics, NAVAVSCOLSCOM-SG-111
2. Rotary Wing Aerodynamics for Naval Aviators
3. Fundamentals of Flight
4. Helicopter Aerodynamics

903. STUDY ASSIGNMENT

1. Review Chapter Nine.
2. Answer the Review Questions.

904. GENERAL

Aerodynamics of hovering flight. For a helicopter to hover, the lift produced by the rotor system must equal the total weight of the helicopter. An increase of blade pitch (through application of collective) that increases the AOA generates the additional lift necessary to hover. As you recall from Newton's Second Law ($F=ma$), the rotor blades must accelerate large amounts of air through the rotor system in a downward direction to generate the lifting force (Figure 9-1).

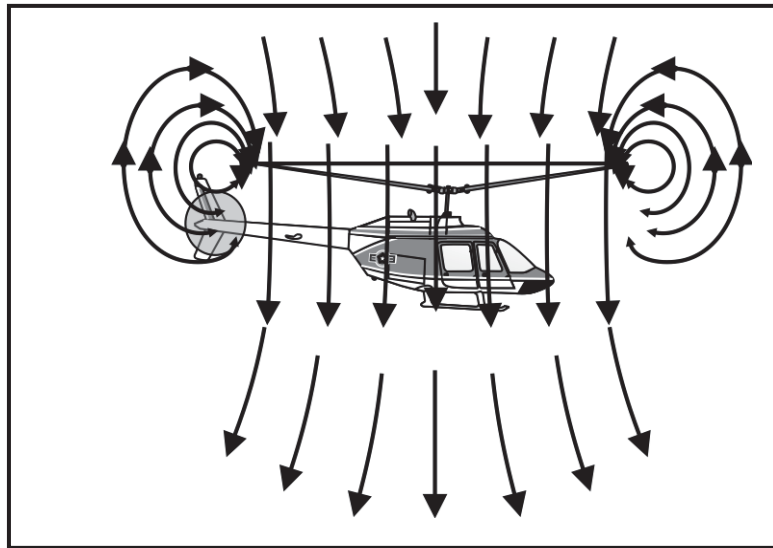

Figure 9-1 Hovering Flight

This vertical movement of air contributes the induced velocity component to relative wind, which alters the AOA of the airfoil (Figure 9-2). With a downward airflow (during a hover) altering the relative wind, the AOA is changed so that a less vertical aerodynamic force is produced. To compensate for the loss of this vertical component of lift, the aviator must add additional collective to adequately increase the total aerodynamic force.

9-2 HOVER PERFORMANCE

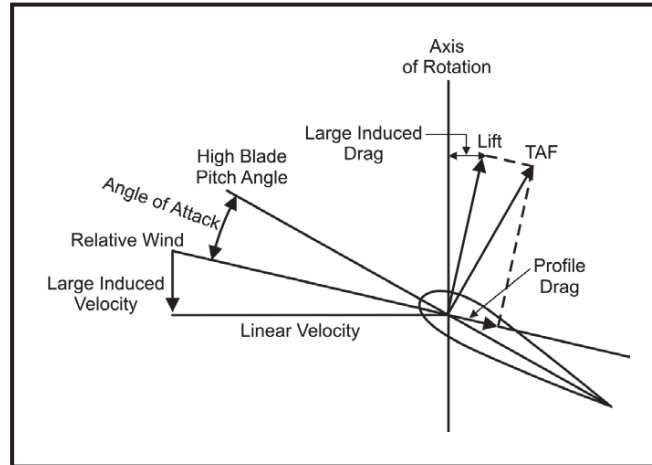

Figure 9-2 Hovering Flight - Blade Element Diagram

Hovering flight in a no-wind condition is characterized by a higher power requirement than translational flight due primarily to increased blade tip vortices and increased induced flow (downwash). In a no-wind condition, the tip path plane remains horizontal. As previously discussed in Chapter 2, at a hover, the rotor-tip vortex (air swirl at the tip of the rotor blades) reduces the effectiveness of the outer blade portions. In addition, the vortices of the preceding blade affect the lift of the following blades in the rotor system. When maintaining a stationary hover, this continuous creation of vortices (combined with the ingestion of existing vortices) is the primary cause of high power requirements for hovering. Blade tip vortices contribute to both the induced velocity and increased induced drag described below.

Evaluation of hovering flight also requires an understanding of translational velocity (V_{tran}) as discussed in Chapter 2. A no-wind hover assumes zero translational velocity due to zero wind and zero groundspeed. An aircraft with 20 knots forward groundspeed and a 20-knot direct tailwind exhibits the aerodynamics of a no-wind hover ($V_{\text{trans}} = 0$). However, the aircraft may also be described as in the hovering flight regime with minimal wind and/or minimal drift, as depicted in Figure 9-3. It is important to note that an aircraft lifting off to a zero groundspeed “hover” in a 40-knot headwind is actually flying at 40 KIAS. The following discussion of the aerodynamics of hovering flight will assume a zero translational velocity component.

Momentum Theory. A generic plot of power required for various airspeeds (Figure 9-3) shows that a large power requirement exists at a hover, a regime for which the momentum theory is held valid. Because hover is the capability that makes helicopters useful, the issue of power required in that regime is worthy of further investigation. Power required for helicopter flight has three components (Figure 9-3). The two that affect power requirements in the hovering flight regime are Induced Power and Profile Power.

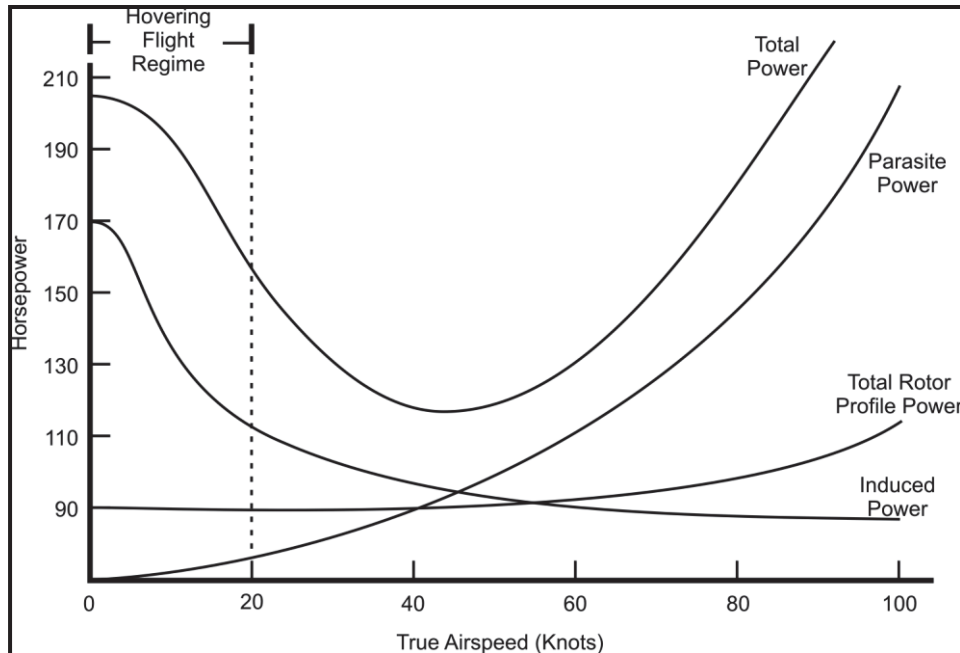

Figure 9-3 Power Required vs. Airspeed

Blade Element Theory. From a Blade Element approach, an increase in weight or decrease in density requires a higher AOA from each blade, and that implies increased drag. Thus, calculations using the momentum theory produce similar results to those that would be expected from blade element theory. An alternative way of looking at induced power would be to picture it as the power required to overcome induced drag that is associated with generating lift.

905. INDUCED VELOCITY AND INDUCED POWER

The power required to generate lift is known as induced power. The power expended through the rotor to lift a rotorcraft's weight can be calculated by considering the acceleration of air downward that is necessary to accomplish the feat. Accelerating a mass of air downwards produces a force that, by Newton's second law, overcomes the aircraft weight in order to produce hover.

Induced Power = power required to overcome aircraft weight

Power = Force pushing on air (F) x Velocity (V) of the air after acceleration

By Newton's second law, for a system with a constantly moving mass

Force = (change in mass per second)(change in velocity)=(dm/dt)(dv)

By continuity $dm/dt = \rho AV$ for air

By substitution $F=dm/dt dv= \rho AVdV$

9-4 HOVER PERFORMANCE

Because a rotor accelerates air from a static condition far above, to a certain induced velocity at the rotor (v_i) and $2v_i$ in the fully developed wake below (per mathematical analysis of energy transfer and confirmation by physical tests), we can substitute v_i for V and $2v_i$ for DV .

$$\text{Thrust (T)} = \rho A V dV = \rho A v_i 2v_i = 2 \rho A v_i^2$$

Solving for induced velocity yields:

$$v_i = \sqrt{\frac{\text{Thrust}}{2 \rho A_{\text{disk}}}}$$

Recalling that power = $F \times V$, the force is Thrust and the velocity is v_i , so Power = $T \times v_i$, and substituting for v_i :

$$\text{Power}_{\text{induced}} = \text{Thrust} \times \sqrt{\frac{\text{Thrust}}{2 \rho A_{\text{disk}}}}$$

From the induced power equation, it can be seen that an increase in weight (thrust) increases the induced power required, as might be expected. A close look at the equation also reveals that a decrease in density (which corresponds to an increase in altitude) increases induced power required. The increase in power required also makes sense because to achieve the same force with a small quantity of air (low density) as that with a high density, the lower density air must be accelerated more, and that requires more power. An increase in disk area is also seen to decrease induced power required at a hover.

906. VORTICES

Every wing that operates in the real, three-dimensional world generates a tip vortex. It is a result of the same pressure differentials that are used to produce lift. The reader will recall from Chapter 2 that some of the high pressure air from the lower surface travels around the wingtip in its quest to reach the lower pressure air on the top surface. Following lower pressures, air travels up past the tip and inward, but is blown aft by the relative wind. The combination of upward flow, tendency to flow from the tip toward the wing root on the top surface, and rearward relative wind produces a spiral flow like that shown in Figure 9-4.

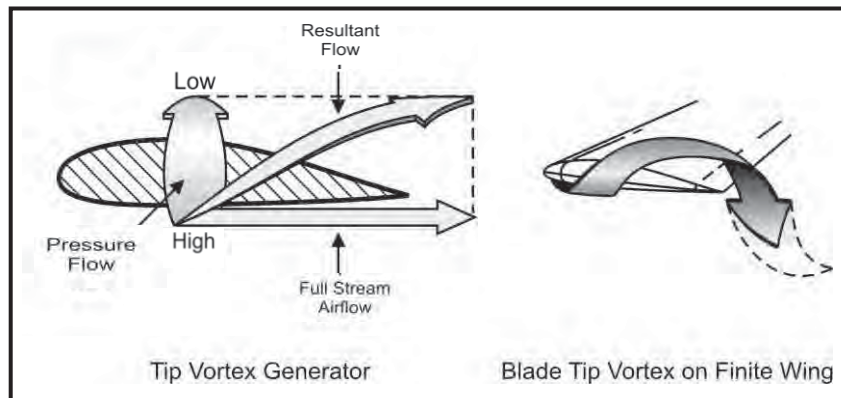

Figure 9-4 Generation and Shape of Tip Vortices

The spiral flow is called a wingtip vortex. As covered previously, the increased downwash associated with wingtip vortices produces induced drag, or drag due to lift. The vortices generated by a wing in motion, however, remain in existence for some time after the wing has passed. Their strength is directly related to the lift produced when they were generated. Everything that involves creation of more lift, therefore, increases the intensity of the tip vortices. Tip vortices left behind an aircraft after it passes are referred to as wake turbulence (Figure 9-5).

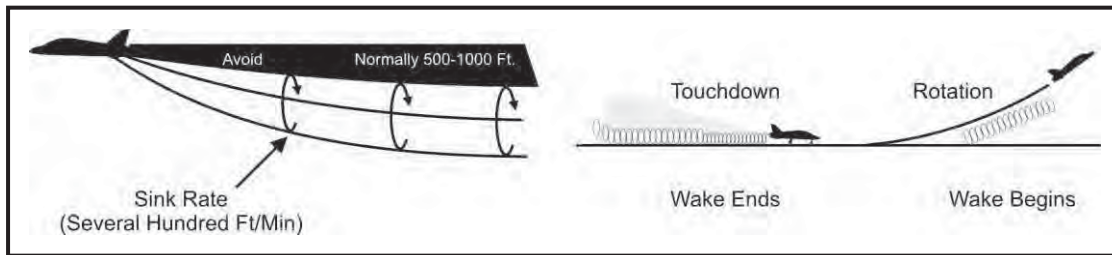

Figure 9-5 Vortex Behavior

Tip vortex strength is strongly influenced by the amount of lift produced and how concentrated the lift is over the wing's surface. As a result, high AOA and increased weight directly result in higher wake turbulence. A heavy fixed wing aircraft during takeoff generates a great deal of wake turbulence because it is at its heaviest weight during takeoff. During takeoff the aircraft is at relatively low speed; therefore it generates lift at a high AOA. Similarly, during landing a heavy fixed wing aircraft generates a good deal of turbulence as it is operated at high AOA at a slow approach speed.

Two other factors, aspect ratio (AR) and wing loading, also affect tip vortex strength, because they quantify how concentrated lift is on the wing surface.

Wing loading's effect on vortex strength can be understood by considering the lift equation:

$$\text{Lift} = (\text{dynamic pressure}) * (\text{wing area}) * (\text{lift coefficient})$$

If wing area is reduced and dynamic pressure remains constant, the only way to keep lift the same is to increase wing lift coefficient. But a higher lift coefficient implies a stronger wingtip vortex because of the increased pressure differential required. So an aircraft with a smaller wing area (and higher wing loading) generates stronger wake turbulence than one of the same weight with a larger wing. For this reason, the FAA made an exception on its wake turbulence classifications that are normally based on aircraft weight. The Saab 340 and the ATR 42 for example, although they have maximum certificated gross takeoff weights that would put them in the "Small" aircraft category, remain in the "Large" category. Their wing size, combined with their wing design and final approach speed, fosters wake turbulence that is significant enough to justify classification as a higher weight aircraft.

Helicopter performance and vortex generation is affected by a factor that is similar to wing loading, but it is based upon disk area so it is called disk loading (DL). Like wing loading, DL

9-6 HOVER PERFORMANCE

relates the lift generated to the area of the surface producing the lift. In this case, the area in question is the circular area inside the rotor disk. A higher DL implies greater downwash and stronger vortices.

When a rotary wing aircraft hovers, tip vortices follow the travel of each blade tip and a spiral pattern of disturbed vortex air results. A heavier aircraft or hovering out-of-ground effect produces larger vortices. As the helicopter moves forward at increasing speeds, frictional effects of the passing airflow collapse vortices that do not rotate at 90° to the flow. As a result, tip vortices that trail behind a helicopter in forward flight are restricted to the lateral tip areas, and the wake turbulence is similar to that generated by a fixed wing aircraft.

The patterns of travel for vortices in flight and near the ground are shown in Figure 9-6.

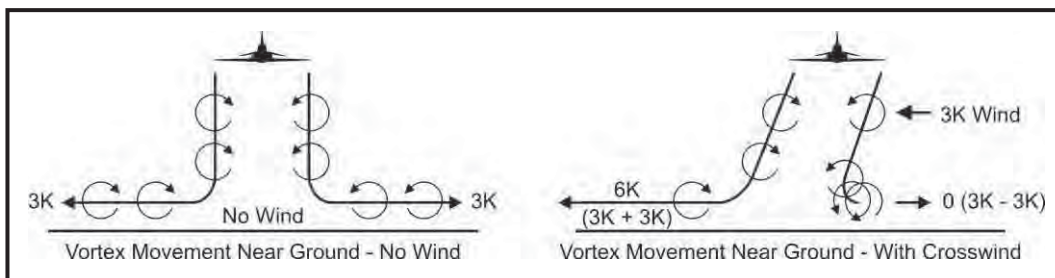

Figure 9-6 Vortex Activity Near the Ground

General vortex characteristics are as follows:

1. **Vortex Strength:** increases with increases in weight, AOA, and DL, and decreases with increases in AR
2. **Vortex Sink Rate:** varies with vortex strength-500 fpm max
3. **Vortex descent limit:** 900 ft (vertical separation)
4. **Vortex radial velocity:** along ground: 5 knots (8.5 ft/sec) - depending on crosswind
5. **Vortex Dissipation:** depends on meteorological conditions. Vortices dissipate faster in turbulent conditions.

907. WAKE VORTICES

There are several possible aircraft reactions to encountering another aircraft's wake turbulence depending on what part of the vortex the aircraft encounters (Figure 9-7). Also, if you are flying in another helicopter's downwash, the vertical velocity downward will make the rotor “see” a climbing condition, thus requiring more power to maintain position.

Vortices are an important hazard in the vicinity of heavy aircraft, and can make flight in close proximity to a similar-sized aircraft rougher. Strong wake turbulence can generate dangerous

downwash and rapid changes in vertical forces for nearby aircraft (Figure 9-7). Therefore, in high density areas pilots need to be aware that the vortices they generate may imperil small aircraft that are operating nearby.

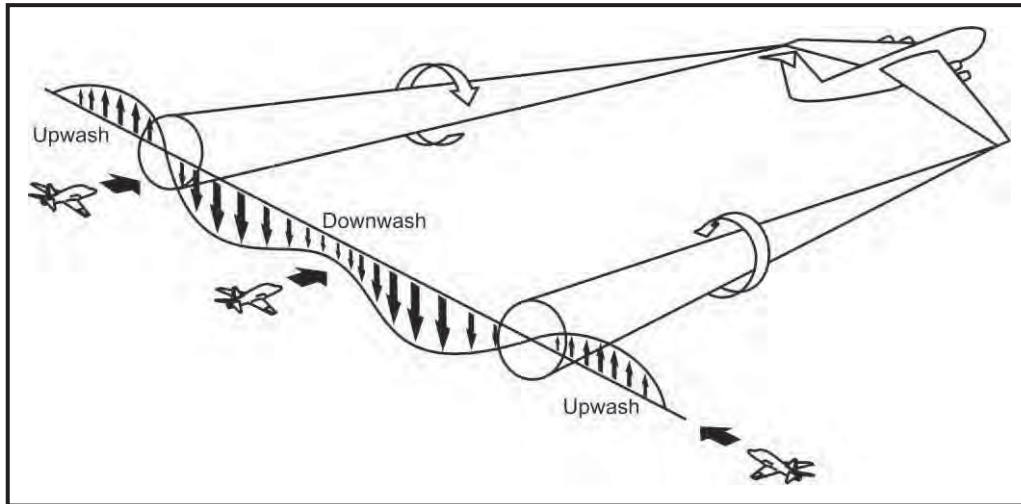

Figure 9-7 Aircraft Reactions to Wake Turbulence

In addition to their wake vortices, helicopter pilots have to consider the effects of their downwash on other aircraft. A helicopter's main rotor's downwash produces high velocity outwash vortices to a distance of approximately three times the aircraft's rotor diameter. Pilots of small aircraft are cautioned by FAA publications to avoid operating within three rotor diameters of any helicopter in a slow taxi or in a hover. Helicopter pilot awareness of small aircraft can also greatly help mitigate the hazard. A small aircraft taxiing dangerously close may be cause to briefly land the helicopter and lower blade pitch to reduce both vortices and downwash velocity.

908. HOVER OUT-OF-GROUND-EFFECT (HOGE)

At an altitude any greater than one rotor diameter above the ground or other surface, i.e., a ship's deck, pinnacle or roof-top approach, etc, the power required to hover remains nearly constant, given constant conditions (such as wind). Figure 9-8 shows airflow and blade element diagram OGE hover. The large uninterrupted induced flow and large vortices are associated with an increased angle of incidence, a larger induced drag, and a lift vector inclined well to rear of vertical. This results in an increased power requirement when compared with the helicopter benefiting from being in ground effect (IGE). Although ground effect is airspeed independent, it is most relevant to the helicopter during the hovering phase of flight due to the higher power requirement of hovering versus translational flight.

9-8 HOVER PERFORMANCE

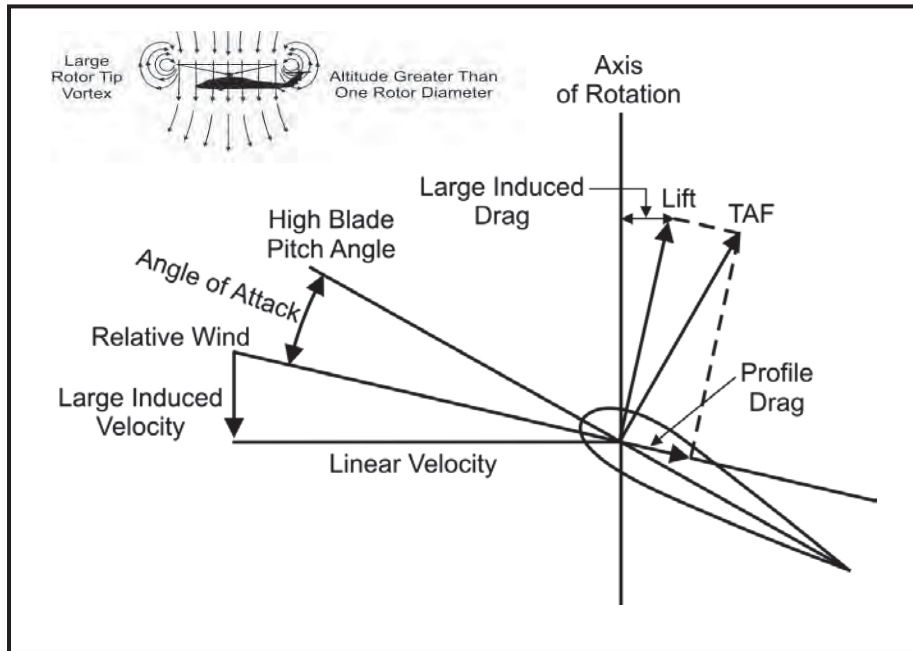

Figure 9-8 HOGE

909. HOVER IN-GROUND-EFFECT (HIGE)

While the helicopter is in a hover and in other flight conditions close to the ground, it encounters ground effect, a favorable aerodynamic phenomenon which requires less power. Less power is required due to less induced drag to overcome while “in ground effect.” Ground effect is therefore defined as the increased efficiency of the rotor system within one rotor diameter of a flat surface.

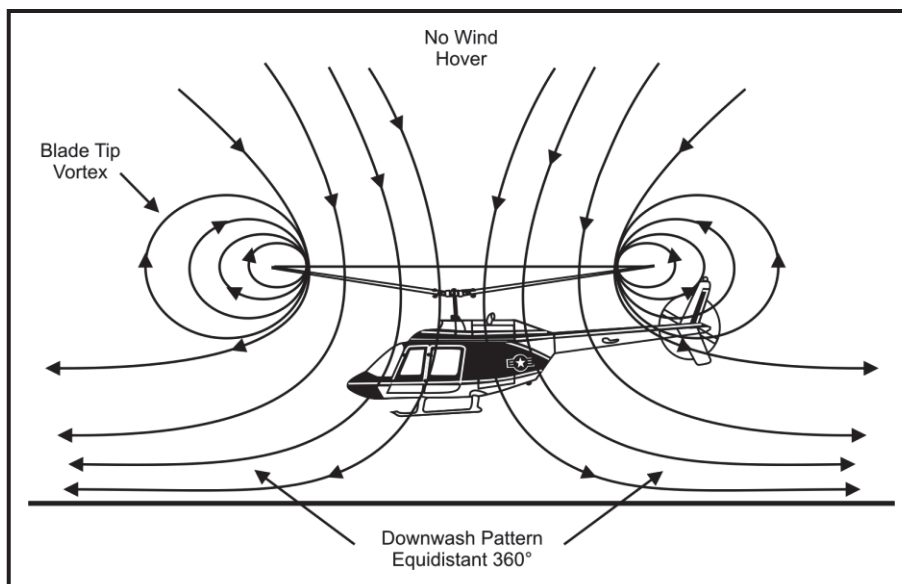

Figure 9-9 Airflow in Hovering Flight

For a helicopter of a given weight the rotor produces the same total lift (equal to the weight) whether hovering OGE or IGE. A noticeable decrease in power required, however, exists in close proximity to the ground. The reason is an increase in rotor efficiency when the downwash field is altered by the presence of the ground (Figures 9-9 and 9-10). In subsonic flow, any disturbance in the flow field is felt to some extent everywhere else in the field. Thus, the flow direction and magnitude around the rotor are altered by the presence of the ground - the closer to the ground, the stronger the effect. Note that the increased rotor efficiency due to ground effect is measured from the ground to the rotor disk, and not to the fuselage or landing gear. Figure 9-10 shows the aerodynamics of an IGE hover. The most significant factor to be noted on the blade element diagram is the reduced induced drag of the lift vector due to the smaller induced velocity when in ground effect.

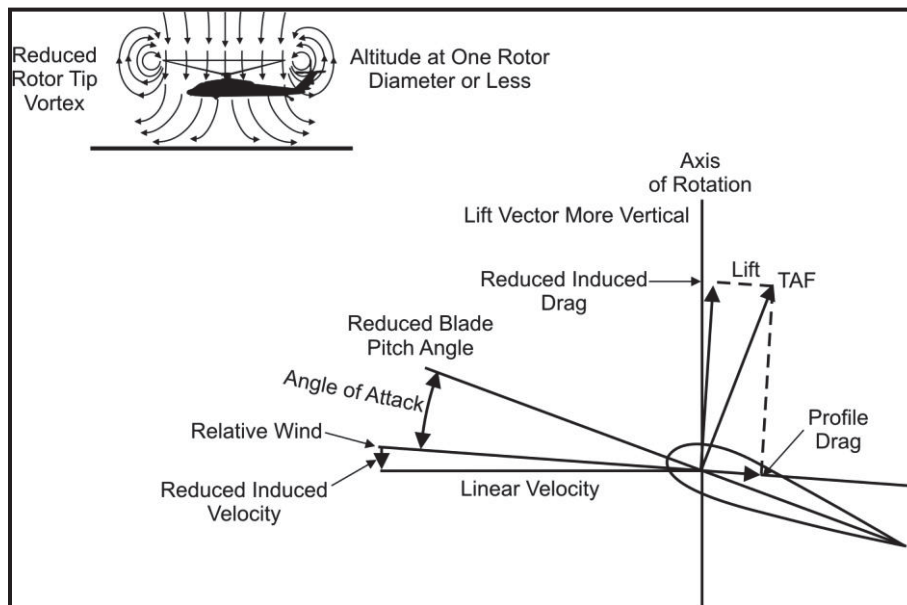

Figure 9-10 HIGE

Increased AOA, forward tilt of the lift vector, and increased efficiency with smaller tip vortices increase the net aerodynamic force acting upward to support the weight of the aircraft. So, for the same amount of power, more weight can be lifted in ground effect than OGE. At a rotor hub height equal to one-half rotor diameter, an increase of approximately eight to nine percent in lifting capability is gained. Performance improves even more at lower altitudes (Figure 9-11). The curve shifts slightly left for tandem rotors.

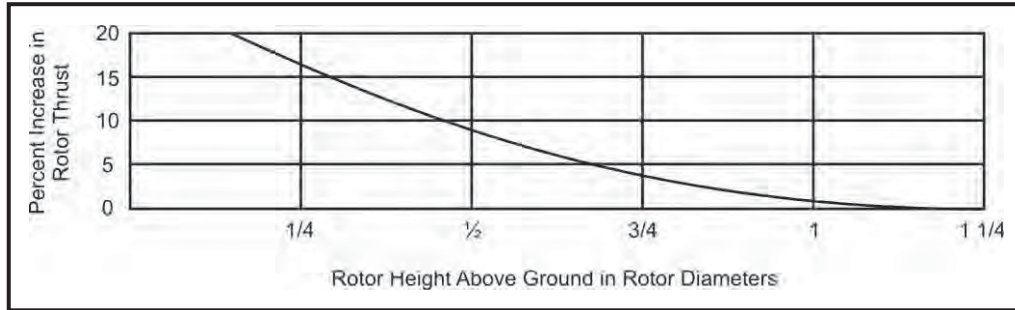

Figure 9-11 Thrust Improvement Due to Ground Effect

It should also be noted that the curve applies to hovering over firm, flat terrain. Over water, energy is absorbed from the air stream in producing wave motion, and over tall grass, energy is used in producing horizontal drag forces on each blade of grass. Consequently, when compared to hovering over hard surfaces at **the same rotor height** (above the water surface or from the **base** of the grass), the ground effect is **smaller** than is indicated in the operator's manual. Ground effect is not affected by surface winds or airspeed to a significant degree. Both **in-ground effect (IGE)** and **out-of-ground effect (OGE)** are critical elements on a rotary-wing performance planning card.

We will now examine in more detail the two reasons for the increased efficiency of the rotor system caused by the interference of the airflow when near the ground: a decrease in induced velocity, and a reduction in the size and impact of rotor tip vortices produced.

Induced Velocity IGE. The first reason is that the proximity of the helicopter to the ground interrupts the airflow under the helicopter by altering the velocity of the induced flow. The induced velocity decreases as the aircraft approaches the ground, which in turn reduces the amount of induced drag, allowing a more vertical lift vector and a more efficient rotor system.

At the surface induced velocity is zero; thus the flow at the rotor disk is slowed. The reduced induced velocity (Figure 9-12) has two effects: it increases the AOA without moving the blade pitch (so more lift is produced), and tilts the lift vector forward with the relative wind shift.

Since all of the induced velocities are reduced in ground effect and the velocity of air which flows through the rotor system and reaches the ground goes to zero, induced drag is reduced and less engine power is required.

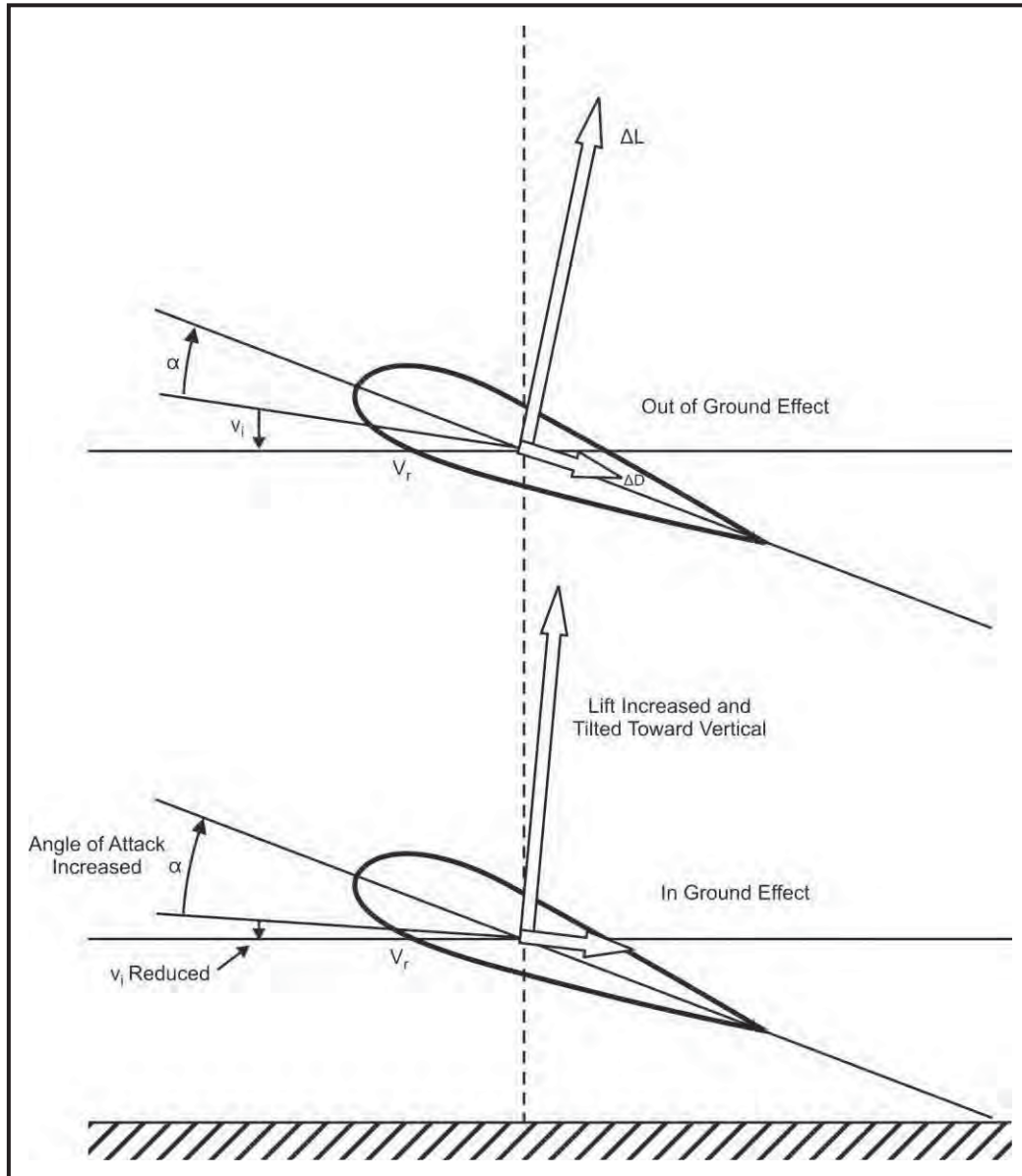

Figure 9-12 Effect of the Presence of the Ground on Induced Velocity

As the helicopter moves vertically from the ground to a distance OGE (approximately one rotor diameter), the blades “see” a greater induced velocity because the flow of air in the wake below the rotors is unimpeded. Combined with rotational velocity, the relative wind is pointed slightly more downward, tilting the lift vector aft, increasing the induced drag and power required to hover. The power savings in ground effect can amount to as much as 10 to 20%.

Vortex Generation IGE. When operating near enough to some surface for ground effect to exist, the outward flow of air tends to restrict vortex generation because the air tends to adhere to a smooth surface and reduces recirculation (Figure 9-13). The presence of the ground blocks full development of the tip vortices that tend to sap power from the blades in an OGE hover. The

smaller vortices thus result in the outboard portion of each blade becoming more efficient and also reduce overall system turbulence caused by ingestion and recirculation of the vortex pattern.

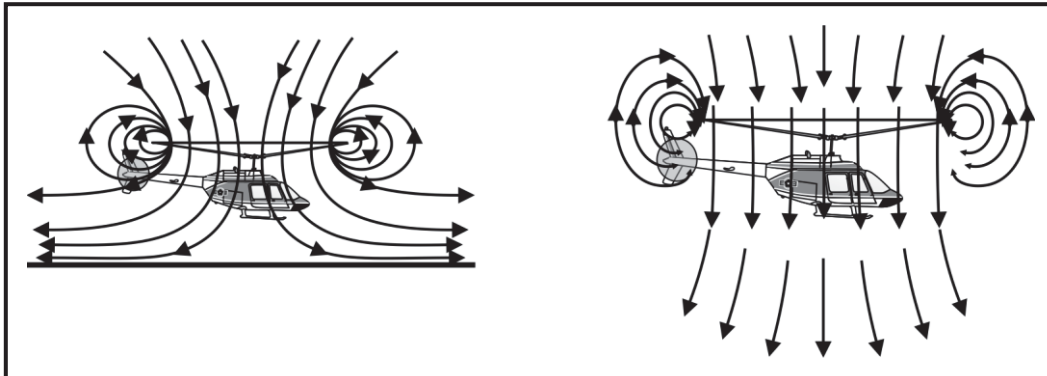

Figure 9-13 Tip Vortices In and OGE

The average pressure difference, ΔP , across the disk is the same whether hovering in ground effect or not. The concept of a “bubble of high pressure air” beneath the helicopter, which some people refer to, is inaccurate. The idea of a finite volume of air at a pressure higher than the ambient atmosphere is an unnecessary simplification of the real case. Also, the concept of a cushion of denser air is entirely false. There is essentially no increase in air density beneath the helicopter compared to anywhere else in the flow.

In a hover, the tip vortices of one revolution impinge on the vortices of the following revolutions, causing an uneven path for the vortices, which eventually destroy each other. These tip vortices affect the induced velocity through the rotor system and, due to this impingement and resultant unsteadiness in the flow field, a rotor system in a hover creates its own gusty air, requiring the pilot to constantly correct to maintain a hover. Additionally, some air can flow upward in the center of the disk where induced velocity is low, causing what is known as the “fountain effect” (Figure 9-14). **All of these factors require constant control adjustments to compensate for them when trying to maintain a steady hover.**

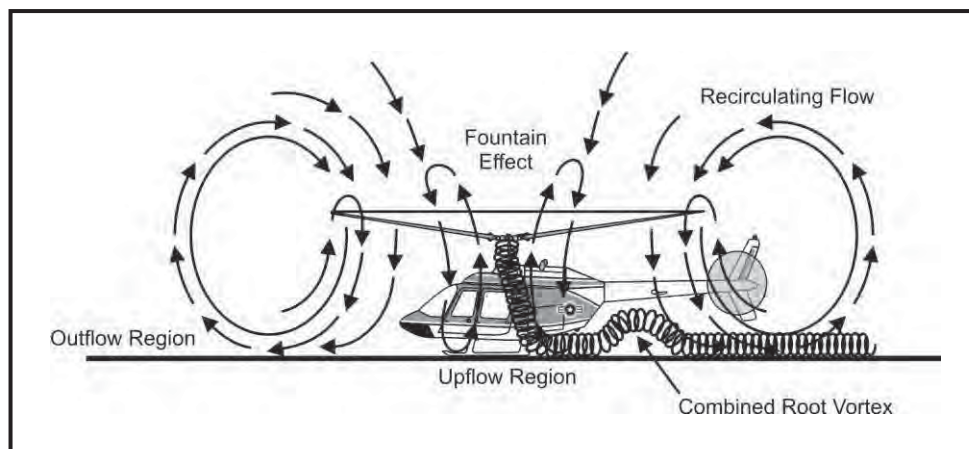

Figure 9-14 Vortices

To balance the tip vortices, another vortex is formed at the blade root which writhes around erratically through and around the main rotor system. This root vortex has an equal and opposite effect on the tip vortex, which the pilot must correct. This usually manifests itself in heading changes as the root vortex impinges on the tail rotor and generally occurs when within one rotor diameter of the ground. Main rotor vortices can also affect the tail rotor during specific wind conditions and are covered in the TH-57 NATOPS Manual.

Ground Effect corrected for Fuselage Height. Another consideration is the actual height at which ground effect occurs, compared to the height shown on a radar altimeter. Fleet aircraft measure their height above the ground by noting the distance from a radar altimeter transmitter and receiver that are placed somewhere on the belly of the fuselage, and set to zero when the skids or wheels are on the ground. The height of the rotor above the ground is what really matters in calculating ground effect. To accurately predict what reading on the radar altimeter would give a certain performance enhancement in ground effect, one would have to account for rotor height and radar altimeter (fuselage) height. For example, using measurements presented in Figure 9-15, a TH-57 that shows a radar altitude reading of 25 feet would have its rotor at approximately 33 feet from the ground, so it would be at the upper limit of practical ground effect.

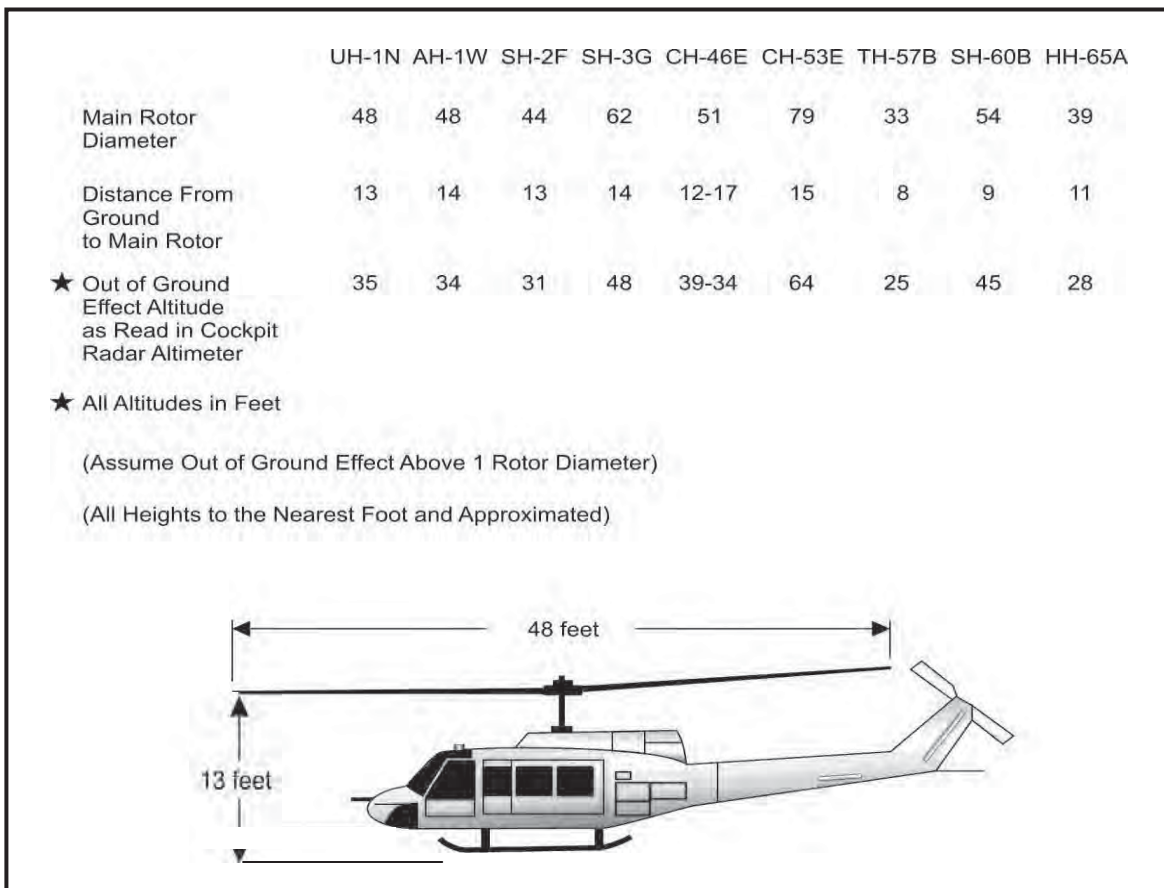

Figure 9-15 Distance from Rotor to Ground/Radar Altimeter Reading Zero

Unfortunately, the greatest potential benefits of ground effect are usually unobtainable because the rotor cannot usually be placed at less than about 1/4 diameter above the ground.

910. POWER REQUIREMENTS

Power is the amount of work done per unit time. If we know that work is force applied over a distance or $F \times D$, then we can express power as $(F \times D)/\text{time}$ or more simply as force times velocity or FV for linear systems. In rotational systems, power = torque x rpm, so for a constant rpm, torque becomes a direct measure of power. General mechanical work is measured in units of foot-lbs, so work per unit time is ft-lbs/sec. One horsepower is defined as 550 foot-pounds per second:

1 horsepower = 550 ft-lbs/sec or 33,000 ft-lbs/min

An engine with one horsepower is capable of providing 550 foot-pounds of work each second or moving 550 pounds one foot per second.

Hover Performance. As previously discussed, the largest power requirement exists at a hover or high airspeed (Figure 9-16). As can be seen depicted along the vertical axis at a no-wind (zero airspeed) hover, the two factors that affect hover power requirements are Induced Power and Profile Power. Note the rapid decrease in induced power and profile power associated with a 20-30 knot airspeed or crosswind component. This “translational lift” benefit will be discussed in detail in the forward flight chapter.

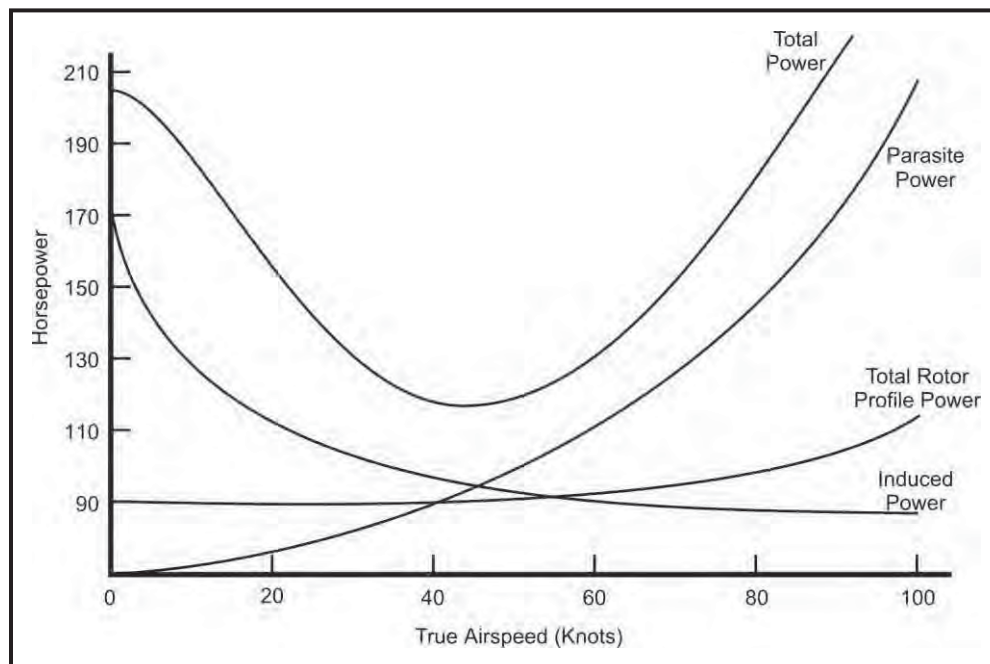

Figure 9-16 Power Required vs. Airspeed

Induced Power. The power required to generate lift is known as induced power. The power expended through the rotor to lift a rotorcraft's weight can be calculated by considering the acceleration of air downward that is necessary to accomplish the feat as was shown in Section 905. To recap:

$$Power_{induced} = Thrust \times \sqrt{\frac{Thrust}{2\rho A_{disk}}}$$

From the equation, it can be seen that an increase in weight (thrust) increases the induced power required, as might be expected. A decrease in air density (which corresponds to an increase in altitude) also increases induced power required. Finally, an increase in disk area also decreases hover induced power required.

Profile Power. The power required to overcome the drag of the rotor blades is known as profile power. As each blade encounters relative wind due to rotation it generates a drag force through friction and pressure differentials. Multiplying the resistance force (drag) by the distance to the center of rotation on many elements (Figure 9-17) of each blade yields a total torque requirement. Turning the blades faster generates more relative wind, greater drag, and in turn greater torque required.

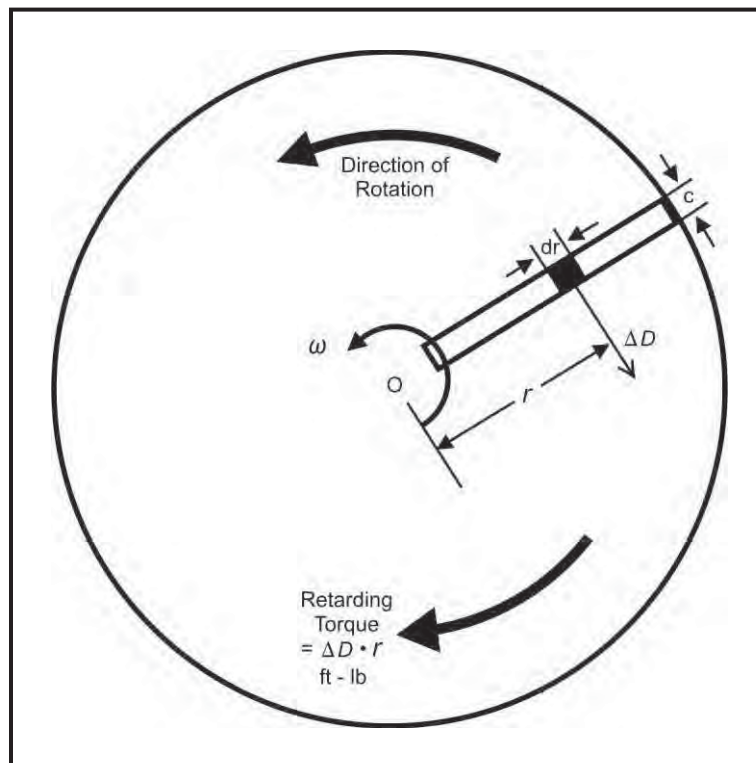

Figure 9-17 Drag and Torque on Rotor Blade

$$\text{Power}_{\text{Profile}} = \frac{1}{8} C_d \rho V_{\text{tip}}^3 A_{\text{DISK}} \sigma_b$$

Bottom line: from this equation, it is apparent that lower density actually decreases profile power required, and a rougher surface (increased C_d) on the blade increases profile power required. Higher altitude (lower density) decreases profile power required, higher disk area increases profile power required, and the increase in the ratio of rotor blade area of the rotor disk area increases the profile power required.

Another influence on profile power that might be gained from looking at the equation is the influence of tip speed variations through tip speed adjustments. A small rpm decrease in hover might seem to be slightly beneficial to performance from a profile drag viewpoint. When rpm is decreased, however, lift decreases, so the pilot increases C_L by increasing the AOA, which also increases C_D . Since profile power decreases with rpm **cubed**, while the profile drag coefficient increases approximately **parabolically (squared)** with AOA up to the stall region, profile power required may decrease. But if AOA gets too high (heavy gross weights, high DA) at low rpm, profile drag increases greatly while the lift curve slope decreases, resulting in increased power required. So an rpm decrease in hover can be advantageous only if the rotor blade can go to a high enough AOA without excessive pre-stall losses.

In a single rotor helicopter, part of any benefit gained will be offset by the increased tail rotor thrust required due to the increased main rotor torque at lower rpm. Increasing the tail rotor thrust in that situation would be difficult because the tail rotor also would be working at a decreased rpm. The risk of loss of tail rotor authority (LTA) that is implied makes it sensible that **hover operation at reduced rpm is normally not recommended**.

Total Hover Power. Adding Induced and Profile power yields total power required to hover:

$$P_{\text{Total}} = P_{\text{Induced}} + P_{\text{Profile}}$$

As discussed in Chapter 3, the figure obtained by this analysis is not entirely accurate in real life because some blade flow losses, flow rotation, and non-uniform inflow are not addressed by momentum theory.

Figure of merit (F.M.) is a measure of how efficient a rotor is at producing lift in a hover. It is the induced power divided by the total power required. Maximizing the figure of merit involves reducing profile power and other losses. Tests have shown that the best figure of merit that designers can expect is about 0.75 - 0.80, and often is much lower.

$$\text{F.M.} = \frac{\text{Induced Power in Hover}}{\text{Total Hover Power}}$$

For a hovering rotor, the typical figure of merit around 0.75 means that profile drag roughly accounts for about one-quarter of the total **power required**. The other three-quarters is induced power. For this reason, changes that affect induced power are more important in a hover than those that affect profile power. So, although increased DA reduces profile power required,

overall hover power required goes up with increased DA because induced power (the dominant component of hover power required) goes up with DA. Likewise, a larger rotor reduces induced power required so hover power required goes down with a larger rotor, even though a larger rotor increases profile power required.

Hovering performance degrades significantly with altitude because power available also decreases as power required increases. Induced power requirements, dominating hover performance, increase total hover power required as air density decreases. At the same time that the hover power requirement **increases** with altitude, the engine power available **decreases** with altitude (after the engine is no longer torque-limited by the gearboxes). The two effects combine to decrease net power margin with increasing altitude (Figure 9-18).

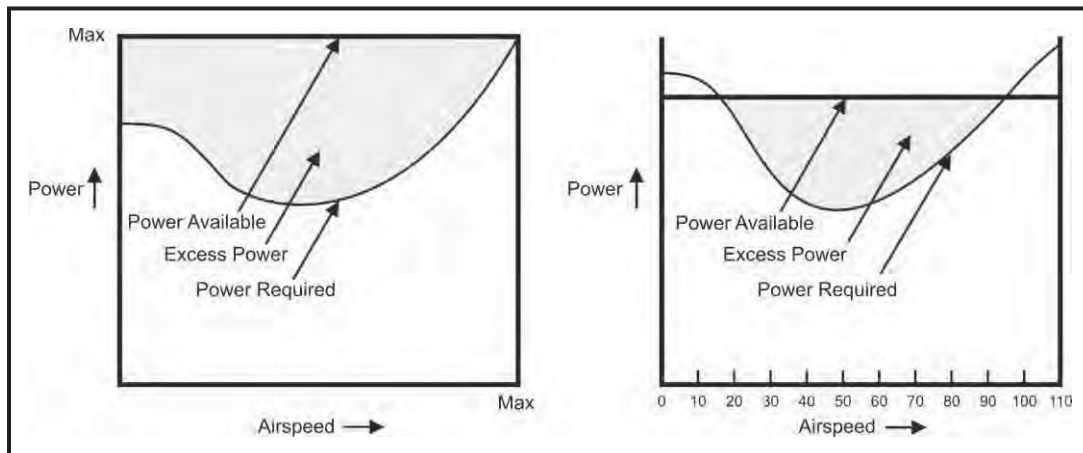

Figure 9-18 Power Available vs. Power Required as Altitude Increases

Changes to induced, profile and total power with weight, altitude and rpm changes are summarized in Figure 9-19.

	$P_{induced}$	$P_{profile}$	P_{total}
↑ weight	↑	↑ (due to C_D)	↑
↑ altitude	↑	↓	↑
↑ rpm	N/A	↑	↑

Figure 9-19 Changes to Hover Power with Weight, Altitude, and rpm

In addition to powering the main rotor, the engines must handle other loads, including driving the tail rotor, overcoming gearbox friction, and powering accessories. Performance data in the NATOPS manuals include the complete power requirement for the helicopter, and show, therefore, the **actual** power required for a given condition.

911. TRANSLATING TENDENCY

As previously discussed in Chapter 6, during hovering flight, the counterclockwise rotating, single-rotor helicopter has a tendency to drift laterally to the right. The **translating tendency**

(Figure 9-20) results from right lateral tail-rotor thrust that is exerted to compensate for main rotor torque (main rotor turning in a counterclockwise direction). The aviator must compensate for this right translating tendency of the helicopter by tilting the main rotor disk to the left. This lateral tilt creates a main rotor force to the left that compensates for the tail rotor thrust to the right. Helicopter designers may also employ main rotor mast tilt and cyclic lateral lead to compensate for the right translating tendency.

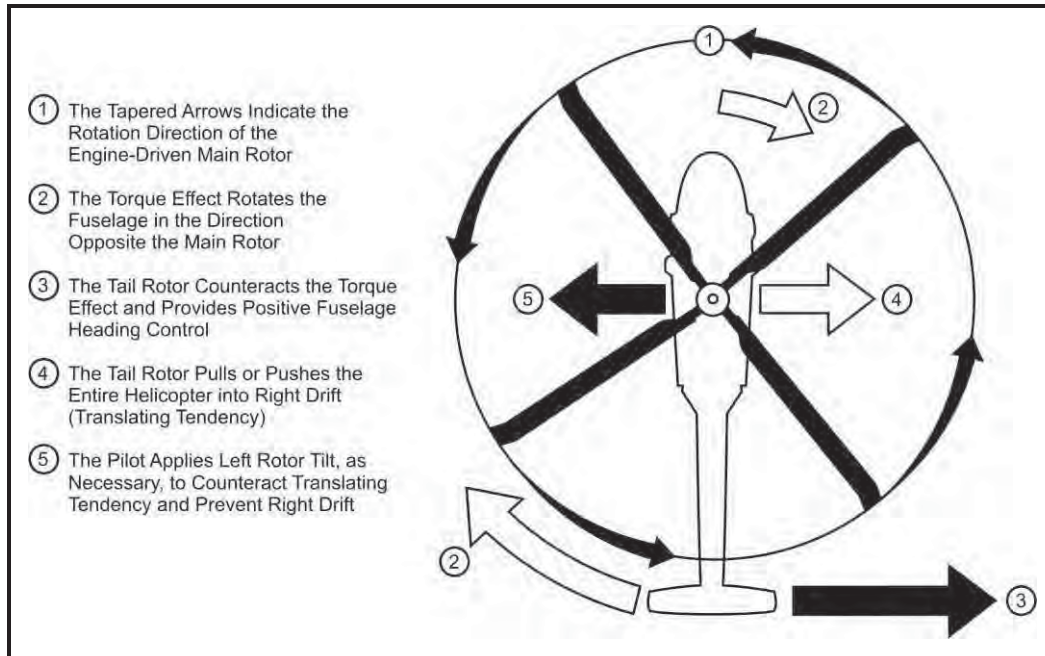

Figure 9-20 Translating Tendency

The transmission may be mounted so that the mast is tilted slightly left when the helicopter fuselage is laterally level. A main rotor mast that is tilted to the left generates a component of thrust that pushes the helicopter toward the left, opposing the tail rotor's rightward force.

Cyclic lateral lead is an adjustment to flight control rigging that mechanically compensates for increases in collective by adding a small roll input to keep the tip path plane canted to the left. Flight control rigging may also be designed so that the rotor disk is tilted slightly left when the cyclic control is centered due to programmed mechanical inputs, automatic flight-control systems, or stabilization augmentation systems.

912. HOVER ATTITUDE

Single Rotor Helicopter. The correction for translating tendency, however, introduces an undesirable left roll. The tail rotor pushing to the right below the level of the main rotor, which is pushing to the left, forms a couple that rolls the helicopter to the left. To compensate for this rolling tendency, many designers place the tail rotor on a boom that goes as close as possible to the main rotor hub's vertical level without suffering too much rotor wake interference. This positioning of the tail rotor reduces the moment arm of the generated couple. Additionally, many helicopters have a main rotor mast that is slightly offset from center. The net result of such modification is that the helicopter hovers with the left wheel/skid low.

A fuselage suspended under a semi-rigid rotor system remains level laterally unless the load is unbalanced or the tail rotor gearbox is lower than the main rotor (Figure 9-21). The fuselage remains level because there is no offset between the rotor mast and the point where the rotor system is attached to the mast (trunnion bearings). Because the trunnion bearings are centered on the mast, the mast does not tend to follow the tilt of the rotor disk during hover. In addition, the mast does not tend to remain perpendicular to the tip path plane as it does with the fully articulated rotor system (explained below). Instead, the mast tends to hang vertically under the trunnion bearings, even when the rotor disk is tilted left to compensate for the translating tendency (Figure 9-21, B). Because the mast remains vertical, the fuselage hangs level laterally **unless** other forces act on the fuselage. Note that the tail rotor on the TH-57 operates below the main rotor hub; therefore the fuselage hangs left skid low in hover.

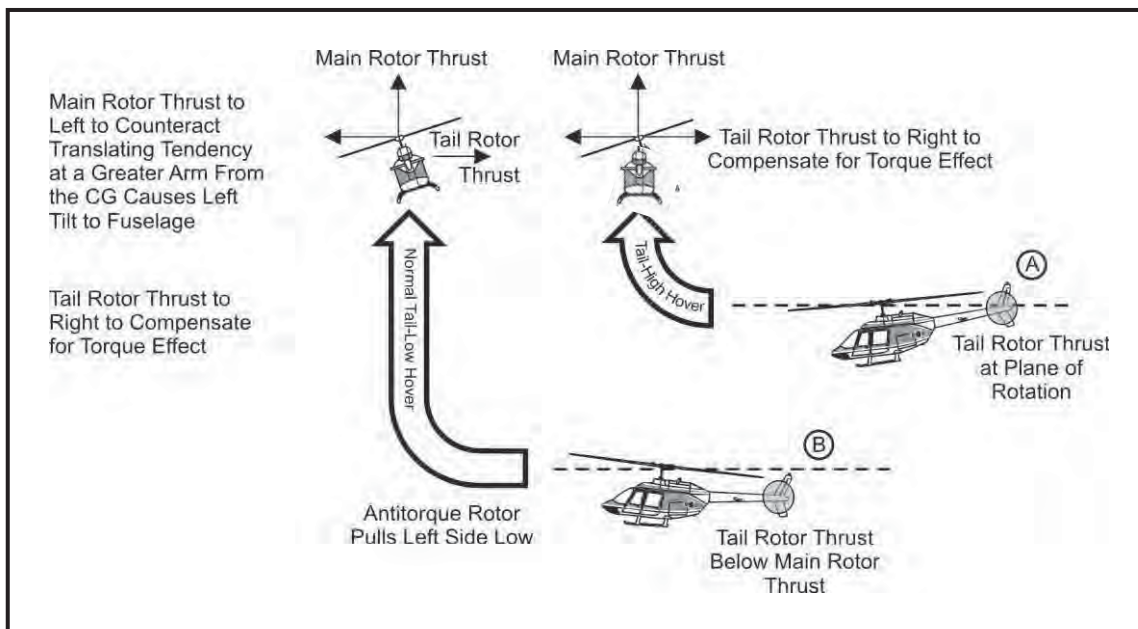

Figure 9-21 Semi-Rigid Rotor System and Effect of Tail Low Attitude

Because of the forward tilt of the mast, when the fuselage of the helicopter is tail low, the tail rotor gearbox is probably lower than the main rotor. Main rotor thrust acting to the left, above tail rotor thrust to the right, causes the fuselage of the helicopter to tilt laterally to the left (Figure 9-21, A). Although main rotor thrust to the left is equal to tail rotor thrust to the right, it acts at a greater distance from the CG, creating a greater turning moment on the fuselage. This is more pronounced in helicopters with semi-rigid rotor systems than those with fully articulated rotor systems. Tail rotor thrust acting at the plane of rotation of the main rotor would not change the attitude of the fuselage (Figure 9-21, B). The main rotor mast in semi-rigid and fully articulated rotor systems may be designed with a forward tilt relative to the fuselage. During forward flight, forward tilt provides a more level longitudinal fuselage attitude, resulting in reduced parasite drag; during hover, it results in a tail-low fuselage attitude.

The design of most fully articulated rotor systems includes an offset between the main rotor mast

and the blade attachment point. Centrifugal force acting on the offset tends to hold the mast perpendicular to the tip path plane (Figure 9-22, A). When the rotor disk is tilted left to counteract the translating tendency, the fuselage follows the main rotor mast and hangs slightly low on the left side (Figure 9-22, B).

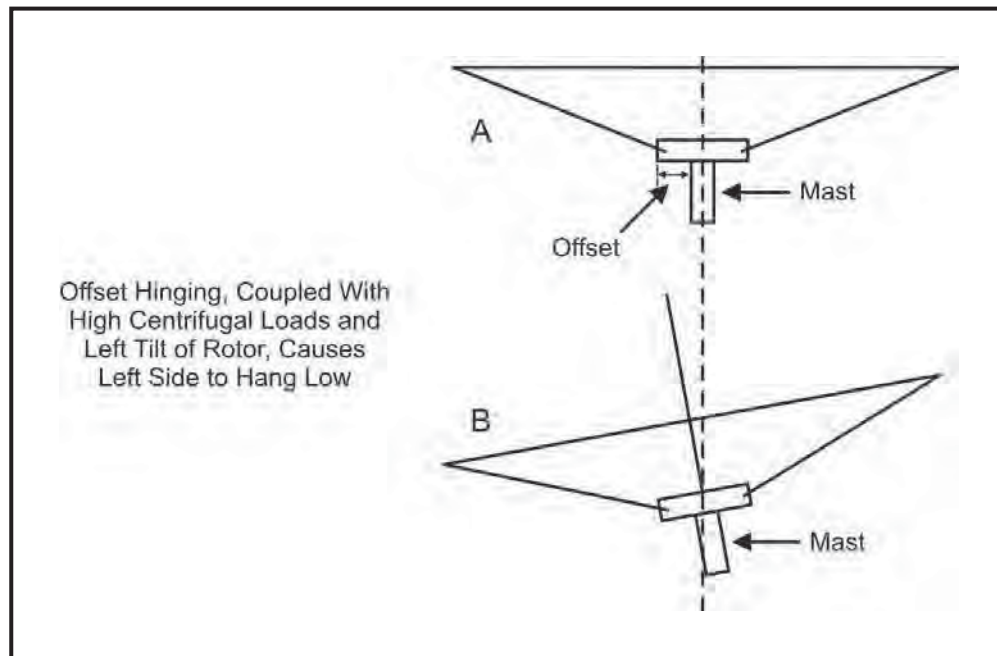

Figure 9-22 Fully Articulated Rotor System

Tandem-Rotor Helicopter. In tandem-rotor helicopters, the forward and aft rotor systems are tilted forward because of the transmission mounting design. This tilt helps to decrease excessive nose-low attitudes in forward flight. Most tandem-rotor helicopters hover at a nose-high attitude of about five degrees. Some models will automatically compensate for this nose-high attitude through automatic programming of the rotor systems.

913. HOVERING FLIGHT

To a greater extent than fixed-wing aircraft, flying a helicopter requires constant coordination between the flight controls, especially during hovering flight. By way of an example: to execute the takeoff, you add collective to increase lift – increased collective also increases the torque effect so you need to counter that with left rudder pedal (anti-torque) as you add the collective. Of course, as the helicopter becomes light on the skids, the tail rotor also causes a translating tendency in addition to providing anti-torque, so you will need to start applying some left cyclic to prevent the right drift. A combination of the left cyclic and right thrust of the tail rotor will then cause the fuselage of the aircraft to tilt to the left; therefore, the aircraft will lift off the right skid first, followed by the left skid and hover in the “left skid low” attitude. Landing from a hover would be a reverse of the process and the **aircraft should touch down left skid first**. All this, of course, assumes balanced loading of the aircraft and no crosswinds. Any wind or change in the wind will require corrective control inputs. A strong enough crosswind from the right, for example, may be enough to compensate for the translating tendency or even require right cyclic to compensate rather than the anticipated left cyclic input!

9-22 HOVER PERFORMANCE

Hovering “pedal turns” can be made using the mast, the nose, or the tail of the aircraft as the center of rotation but typically it will be the mast for a tail-rotor configured aircraft. This coordinated maneuver requires situational awareness of the aircraft and any obstacles, including the ground, as well as the changing effects of any wind present as the aircraft turns through the wind line. In a right pedal turn with a headwind for example, main rotor vortices can be blown into the tail rotor, reducing its effectiveness and increasing yaw rate. As the aircraft is turned out of the wind line, wind on the vertical stabilizer will initially slow the rate of turn but as the tail passes through the wind line, rate of turn will increase. Since turns to the left require more power (more tail rotor thrust required), clearing turns are normally conducted to the left first to ensure adequate power is available.

The prescribed hover height is designed to provide a margin of safety for training as well as emergencies. Unnecessary training below that altitude is risky. Hover and landing attitude can be affected greatly by winds, especially when winds are gusty. A significant tailwind may not only degrade engine performance (depending on engine layout, hot exhaust gases can be re-ingested raising the inlet air temperature), but may lead to an excessive tail low attitude (due to back stick necessary to hold position), especially in a turn when ground references are changing. It is therefore prudent to avoid hovering and landing with an adverse wind whenever possible. Challenges by adverse winds to tail rotor effectiveness during turns, especially due to main rotor interference, weathercock instability, and tail rotor VRS, are discussed in detail in Chapter 12 and your NATOPS manual.

Power loss in a hover: based on the previous discussion of the control inputs necessary to hover the TH-57, it should be obvious that with a power loss or engine failure in a hover, control inputs will need to be adjusted. Since left rudder was added to compensate for engine torque as you pulled up into the hover, if the engine fails, the torque on the rotor system has been eliminated therefore requiring the addition of right rudder pedal (or less left pedal) or the aircraft will start yawing to the left. If you remove the left pedal inputs, there will be less tail rotor thrust which means less translating tendency, so you will need to remove some of the left cyclic you had previously added or the aircraft will be drifting to the left as you touchdown.

THIS PAGE INTENTIONALLY LEFT BLANK

CHAPTER NINE REVIEW QUESTIONS

1. Ground effect is caused by a reduction of _____ due to helicopter operations within _____ rotor diameter of the ground.
2. As AOA increases, vortex strength increases/decreases.
3. As a wing's AR increases, vortex strength increases/decreases.
4. As an aircraft's gross weight increases, vortex strength increases/decreases.
5. As rotor DL increases, vortex strength increases/decreases.
6. On a blade element diagram, as the induced flow vector increases, AOA increases/decreases.
7. On a blade element diagram, how does translational lift affect induced flow?
8. As a conventional helicopter lifts into a hover, the right skid leaves the ground first due to offset of the main rotor to counteract _____ .
9. Rotor tip vortices are
 - a. a function of the DA
 - b. created by high pressure air above the airfoil flowing to low pressure area beneath it
 - c. created by low pressure air below the airfoil flowing to high pressure area beneath it
 - d. created by high pressure air below the airfoil flowing to low pressure area above it
10. Wingtip vortex intensity is not affected by
 - a. lift
 - b. angle-of-attack
 - c. weight
 - d. parasite drag
11. As the helicopter arrives within one rotor diameter's distance of a smooth surface relative wind becomes more horizontal due to a/an:
 - a. increase in linear flow
 - b. decrease in induced flow
 - c. decrease in linear flow
 - d. increase in induced flow

12. Ground effect
- increases with an increase in airspeed
 - decreases with an increase in airspeed
 - is not affected by airspeed
 - is most effective when greater than one rotor diameter from the ground
13. Since the tail rotor is a thrust producer, in what direction does the tail rotor cause the helo to drift (conventional design/ CCW rotating main rotor)?
- Left
 - Right
 - Forward
 - Backward
14. During a hovering right turn with a headwind, you may experience a sudden uncommanded right yaw caused by
- Main rotor vortices
 - Increased tail rotor angle-of-attack
 - Sudden left pedal inputs
 - CG being located at the forward limit
15. One factor which decreases power required while hovering in ground effect is:
- reduction of induced velocity
 - increased linear flow
 - reduction of linear flow
 - flapping

THIS PAGE INTENTIONALLY LEFT BLANK

CHAPTER NINE REVIEW ANSWERS

1. induced velocity, 1
2. increases
3. decreases
4. increases
5. increases
6. decreases
7. translational lift reduces the induced flow vector
8. tail rotor thrust
9. d
10. d
11. b
12. c
13. b
14. a
15. a

CHAPTER TEN FORWARD FLIGHT PERFORMANCE

1000. INTRODUCTION

The purpose of this chapter is to aid the student in understanding the basic aerodynamics of forward flight. This lesson topic will also introduce retreating blade stall, compressibility and optimum airspeeds.

1001. LESSON TOPIC LEARNING OBJECTIVES

1. **Terminal Objective:** Partially supported by this lesson topic:

Upon completion of this unit of instruction, the student aviator will demonstrate the ability to analyze the aerodynamics associated with forward flight.

2. **Enabling Objectives:** Completely supported by this lesson topic:

- a. Identify on a rotor disk the areas of high AOA and low AOA.
- b. Recall the definition of translational lift, state the phenomena which cause it, and describe its effect on power required.
- c. State the effect of dissymmetry of lift on a rotor system and explain how the effect is overcome.
- d. Describe the effect of phase lag on helicopter control.
- e. Describe pendulum effect and know when a pilot will encounter it.
- f. Describe transverse flow effect and its cause.
- g. Recall the definition of blowback, and describe its effect on helicopter attitude and airspeed.
- h. Plot on a rotor disk the typical velocity distribution for a rotor system in forward flight.
- i. Recall the definition of retreating blade stall, its cause, contributing factors, effects on flight, and corrective action.
- j. Recall the definition of compressibility, its cause and the effects on flight, and corrective action.

- k. Identify the minimum and maximum single engine airspeeds from a given helicopter performance chart.
- l. Recall the definition of bucket airspeed and explain its usefulness.

1002. REFERENCES

1. Fundamentals of Aerodynamics, NAVAVSCOLSCOM-SG-111
2. Rotary Wing Aerodynamics for Naval Aviators
3. Fundamentals of Flight
4. Helicopter Aerodynamics

1003. STUDY ASSIGNMENT

1. Review Chapter Ten.
2. Answer the Review Questions.

1004. GENERAL

Airflow in Forward Flight. The aerodynamics of forward flight are more complex than those of hovering flight because the relative wind velocities that each blade element encounters change throughout the cycle of rotation. In this unsteady aerodynamic field, lift forces and stresses on the blades change constantly. Airflow across the rotor system in forward flight varies greatly from airflow at a hover. As introduced in Chapter 2, in forward flight air flows opposite the flight path of the aircraft. The velocity of this flow of air equals the forward speed of the helicopter. Because the blades of the helicopter turn in a circular pattern, the velocity of the airflow across a blade depends on the position of the blade in the plane of rotation at a given instant, its rotational velocity, and the airspeed of the helicopter.

Therefore, the linear velocity at each blade segment varies continuously as the blade rotates. The highest velocity of airflow occurs over the right side (3-o'clock position) of the helicopter (advancing blade in a rotor system that turns counterclockwise) and decreases to rotational velocity over the nose. It continues to decrease until the lowest velocity of airflow occurs over the left side (9-o'clock position) of the helicopter (retreating blade). As the blade continues to rotate, the velocity of the airflow then increases to rotational velocity over the tail. It continues to increase until the blade is back at the 3-o'clock position.

The advancing blade (blade A) moves in the same direction as the helicopter (Figure 10-1). The linear velocity equals the rotational velocity of the blade plus translational velocity of aircraft forward airspeed. The retreating blade (blade C) moves in a flow of air that is moving in the opposite direction of the helicopter. The linear velocity of this blade equals the rotational velocity of the blade minus the translational velocity of aircraft forward airspeed. The blades

10-2 FORWARD FLIGHT PERFORMANCE

over the nose and tail (blades B and D) are essentially at right angles to the airflow created by aircraft forward airspeed; thus the linear velocity over the nose and tail is approximately equal to the rotational velocity.

This results in a change to the velocity of the airflow all across the rotor disk and a change to the lift pattern of the rotor system.

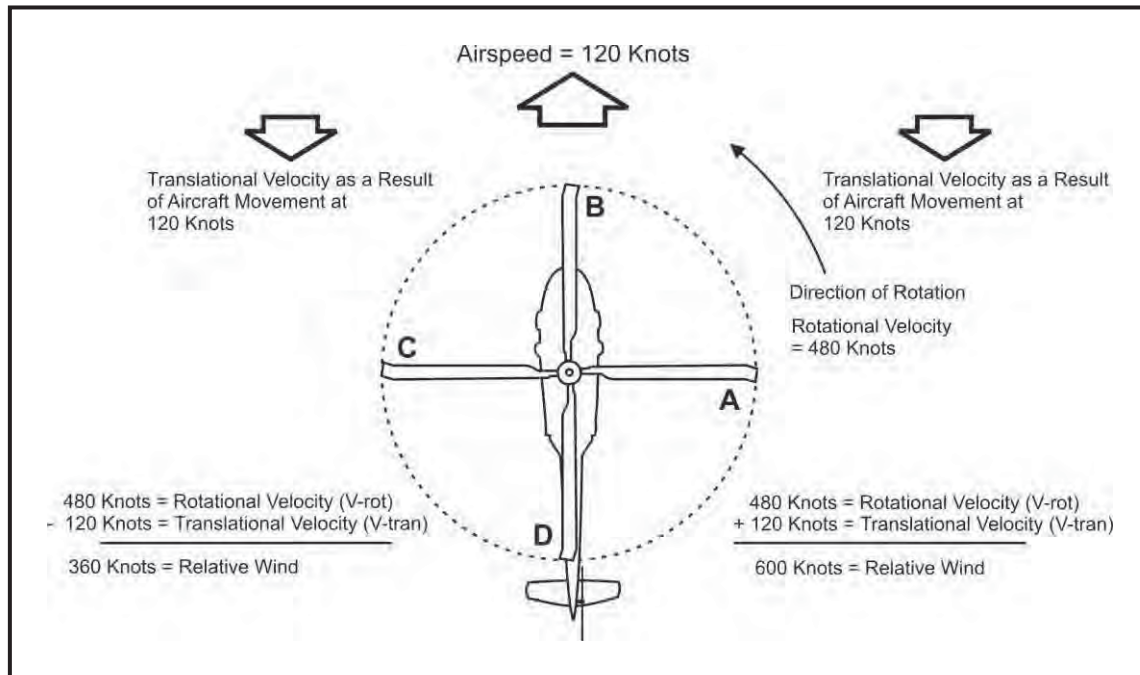

Figure 10-1 Differential Velocities on the Rotor System Caused by Forward Airspeed

Relative wind variation. The relative wind consists of linear velocity plus induced velocity. The linear velocity on a blade element consists of the velocity, V_{rot} (Figure 10-1), due to rotation, combined with an additional velocity component, V_{tran} , due to motion of the aircraft and/or winds. The linear velocity vector experienced by a blade section is the **vector sum** of V_{rot} and V_{tran} . When the blade is at the 90° azimuth position (advancing blade) the two velocities add arithmetically to produce the highest airspeed felt by the section. Progressing toward the hub, total velocities decrease as velocity due to rotation ($V_{rot} = \text{rpm} \times \text{radius}$) gets smaller with decreased radius. The wind velocity at the hub is equal to the flight velocity. By vector addition it is apparent that on the retreating side, flow actually goes from the blade's trailing edge to the leading edge in the region called the **region of reversed flow**. Reversed flow ends at the point where velocity due to rotation equals flight velocity. At other azimuth positions, the vectors V_{trans} and V_{rot} are not collinear; hence their vector sum results in a relative wind that is not perpendicular to the leading edge. Studies on swept wing aircraft have shown that the relative wind that matters is that which is perpendicular to a wing's leading edge. As a result, wind speed variations occur with azimuth on the rotor disk, as well as radius. A plot of the overall effect could appear quite complex, but its appearance is not the important thing here.

The point to remember is that velocity changes as the blade moves around the rotor disk. As a result, lift and drag vary at points around the disk.

Because forward flight impacts disk performance, engineers index its magnitude by referencing it to tip velocity. The relationship between the rotational velocity and an aircraft's forward speed is known as the **advance ratio**, μ :

$$\mu = V/V_{TIP}$$

This value is used in performance prediction and power requirement equations.

AOA Variation. The airspeed variations on the disk, particularly those between advancing and retreating blades, cause a large lift dissymmetry at a fixed pitch. The solution to the dissymmetry of lift, as noted in Chapter Four, is flapping. Flapping works by changing AOA as the blade moves around the rotor disk. Thus, one would expect that the AOA around the disk is not constant. Figure 10-2 shows approximations for the AOA around a rotor disk. The AOA does indeed change as the blade travels around.

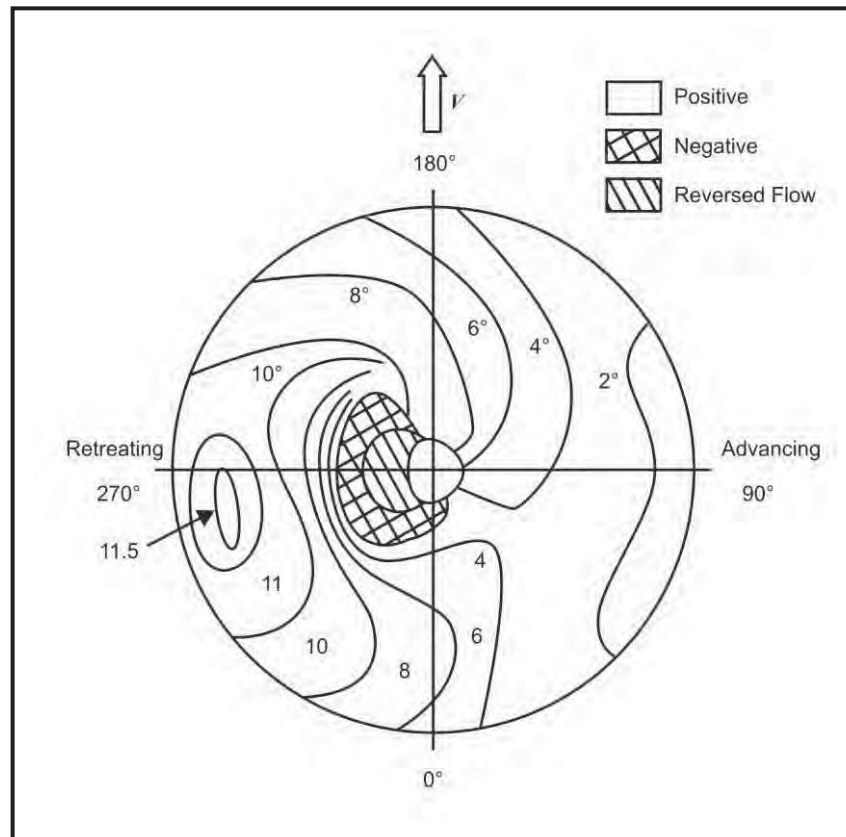

Figure 10-2 AOA Distribution

Flapping isn't the only contributor to AOA changes, however. To compensate for lift lost in the region of reverse flow, pilot inputs increase the AOA on the retreating side. Control inputs also tilt the disk forward so that forward velocity is generated, and are used to counteract a multitude of other effects. When one considers that AOA corrections also have to be entered with

consideration for phase lag, it's no wonder that the AOA distribution diagram is not at all as symmetric as might be expected. The existence of tip vortices further complicates prediction of AOA at various disk locations.

Depending upon what assumptions are made in developing the model, the flight regime selected (climb, descent, or level), and the mathematical sophistication applied, different aerodynamicists develop different AOA maps (Figure 10-2). But, regardless of the exact model used, experts agree that a rotor disk in forward flight has the following characteristics:

1. AOA is lowest at the 90° position.
2. AOA is highest in the vicinity of the 270° position.
3. The region near the hub on the retreating side has reverse flow.
4. AOA is not symmetric between the fore and aft portions of the disk.
5. Maximum AOA occurs inboard from the blade tip.

1005. TRANSITION FROM HOVER TO LOW SPEED FLIGHT

Power required in forward flight. Power required for forward flight involves induced, profile, and parasite power. As in the hover case, induced power deals with generation of lift and profile power deals with drag on the rotor. In forward flight, power is also required to overcome drag on all other components on the airframe as they are pushed through the air.

Induced power. Induced power requirements change as forward airspeed is introduced. The requirement for a mass flow of air still exists, but forward velocity increases the mass flow rate so less pumping power is required. At speeds beyond that at which the tip vortices are outrun (speed for effective translational lift) the rotor disk acts in a manner that is similar to a conventional wing. At low to medium speeds the velocity of the air being pushed downward by the rotor disk (the induced velocity) is calculated by correcting the hover induced velocity:

$$V_{induced} = \sqrt{-\frac{1}{2}V_f^2 + \sqrt{\left(\frac{1}{2}V_f^2\right)^2 + V_{ih}^2}}$$

where induced velocity in a hover is

$$V_{ih} = \sqrt{\frac{Thrust}{2\rho A_{disk}}}$$

At medium to high speeds the overall deflection of the flow is much simpler, and induced velocity can be calculated more directly:

$$V_{induced} = \frac{T}{2\rho A_{Disk} V_f}$$

In the induced velocity equations, V_f is aircraft forward velocity (V-trans) and V_{ih} is induced velocity in a hover (V-ind). Density, disk area and thrust (weight) are the same terms used in the past.

When we combine this change in induced velocity with our original power equation ($P = F \times V$) we get the induced power required equation in forward flight.

$$Power_{induced} = \frac{T^2}{2\rho A_{Disk} V_f}$$

The equation shows that the induced power requirement is inversely proportional to forward flight speed and directly proportional to weight. A plot of induced power required vs. forward airspeed at a constant altitude and weight is presented in Figure 10-3.

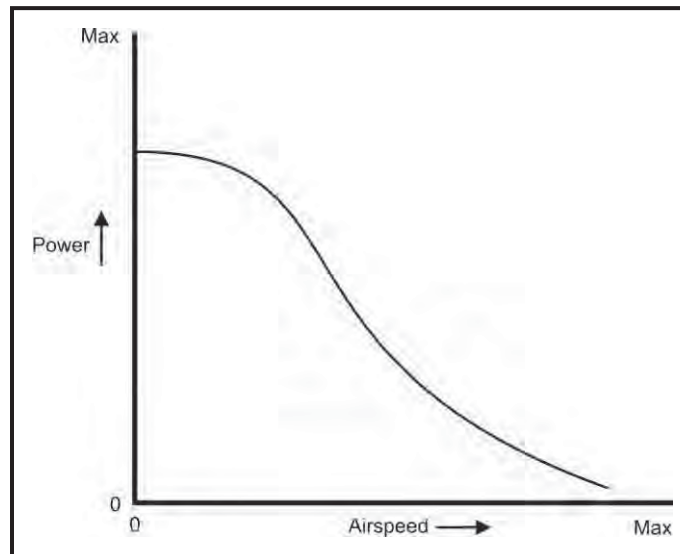

Figure 10-3 Induced Power Required

Profile Power. Unlike induced power, profile power required increases with velocity. Recall that profile drag is skin friction and form (pressure) drag on rotor blades, so it is calculated using an adaptation of the standard drag equation: $D = C_D q S$. Dynamic pressure (q) increases with velocity squared, so profile drag increases as the velocity increases. The equation for profile power in forward flight is almost identical to that for the hover case with the addition of one variable, advance ratio. Advance ratio, as stated previously, is a ratio that relates forward speed to blade tip speed.

$$\mu(\text{advance ratio}) = \frac{\text{Velocity of Aircraft}}{\text{Blade Tip Velocity}} = \frac{V_f}{\Omega \times R}$$

10-6 FORWARD FLIGHT PERFORMANCE

Based upon calculations and tests, aerodynamicists determined that the profile power equation for a hover only needed a slight adjustment to account for forward flight effects.

The profile power for hover is:

$$Power_{Profile} = \frac{1}{8} C_d \rho V_{tip}^3 A_{DISK} \sigma_b$$

With the forward flight adjustment it became:

$$Power_{Profile} = \frac{1}{8} C_d \rho A_D V_{tip}^3 (1 + 4.65 \mu^2) \sigma_b$$

The equation reflects that profile power is definitely affected directly by density and forward flight speed. The Profile Power vs. Airspeed curve is depicted in Figure 10-4.

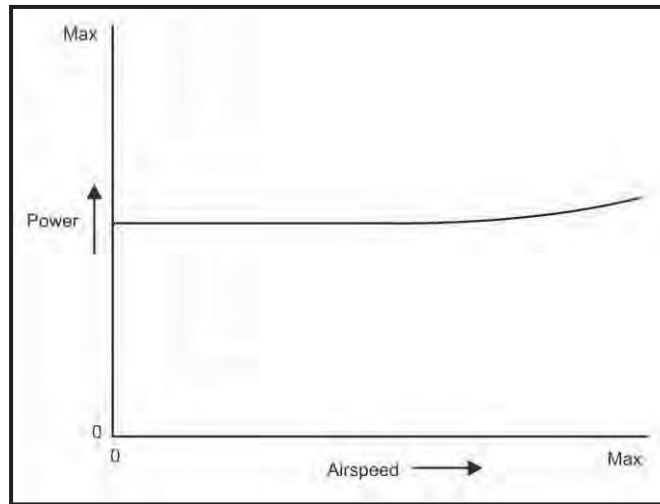

Figure 10-4 Profile Power Required vs. Airspeed

Parasite Power. Parasite power is the power required to overcome drag in forward flight on everything but the rotors. Pushing the fuselage, landing gear, external fuel sponsons, armor plating, ordnance, antennas, and everything else on the aircraft through the air takes a force that is collectively called parasite drag. The rate at which that force must be applied is the parasite power. As objects in the air flow become larger or more "draggy," the power required to overcome parasite drag increases.

Total parasite drag is the sum of parasite drag on each component, plus interference factors. It is calculated for each component in the same way that profile drag was calculated on a rotor blade:

Drag = $C_D q S$ for each component, where C_D is the drag coefficient for the specific item and S is the surface area of the specific item. The total drag is:

$$D = (C_D qS)_{fuselage} + (C_D qS)_{fuel\ tank} + (C_D qS)_{ordnance} + (C_D qS)_{hoist} \dots \text{etc.}$$

To make calculations easier, an **equivalent flat plate area (EFPA)** is defined. EFPA is the surface area that a flat plate with a drag coefficient of one would have to have to equal the drag of the item. For example: If frontal area of a helicopter is 40 sq. ft and its drag coefficient is $C_D = .6$, drag with a q of 10 lb/ft^2 is

$$\text{Drag} = C_D qS = .6 \times 10 \times 40 = 240 \text{ lb.}$$

A flat plate with a C_D of one and the same q would have to have an area of:

$$S = \text{Drag} / C_D q = 240 / 1 \times 10 = 24 \text{ sq ft. This is the EFPA.}$$

The advantage to finding an EFPA for each item is that the drags can be easily added together. With $C_D = 1$ and $S = \text{EFPA}$ for each item:

$$\begin{aligned} D &= (C_D qS)_{\text{fuse}} + (C_D qS)_{\text{fuel}} + (C_D qS)_{\text{ord}} + (C_D qS)_{\text{hoist}} \\ &= 1 \times q \times (S_{\text{fuse}} + S_{\text{fuel}} + S_{\text{ord}} + S_{\text{hoist}}) \end{aligned}$$

In fact, total EFPA can be added up and multiplied by dynamic pressure to get total drag. EFPA is available for different configurations and items in tables.

Multiplying drag by velocity yields parasite power, so

$$P_p = D \times V_f = q (\text{EFPA}) V_f = \frac{1}{2} \rho V_f^2 (\text{EFPA}) V_f = \frac{1}{2} \rho (\text{EFPA}) V_f^3$$

Thus, it should be apparent that parasite power varies with changes to EFPA (which depends on aircraft configuration), and with the cube of forward velocity. Figure 10-5 graphically shows the relationship between parasite power and airspeed.

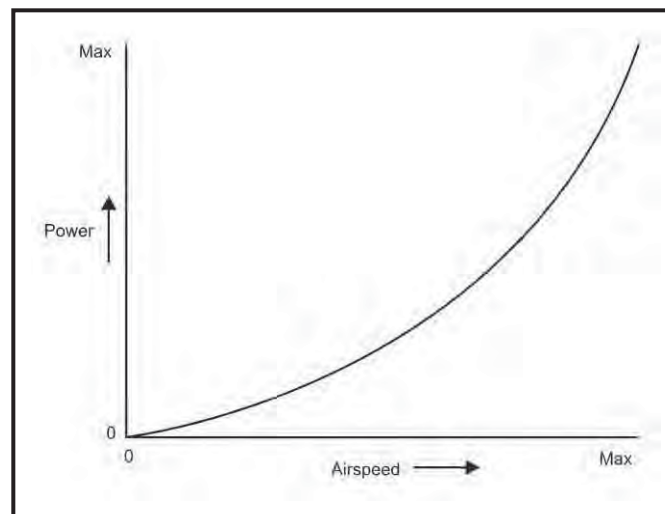

Figure 10-5 Parasite Power Required vs. Airspeed

EFPA can be altered by reducing the size or shape of aircraft components and additions. It takes more power to move a non-aerodynamically shaped object through the air than one that is designed as a lift-generating surface. The fuselage, sponsons, external fuel tanks, and missile launchers all contribute to providing unwanted resistance against the wind, thus they are shaped to move the air around the object with the least amount of turbulence.

Total Power Required. Total power required in forward flight is simply the sum of induced, profile and parasite power. The decrease in induced power required with airspeed (Figure 10-6), coupled with increasing profile and parasite power requirements, gives the overall curve a distinctive shape. With losses due to engine installation and other power demands added, the chart could be usable for flight performance prediction. In fact, just such a chart is used every day; however, variations in the power requirements due to altitude (density), gross weight, and temperature must be considered, so the result is a series of curves. Not all manufacturers represent their data in the same way; some depict it on its side (as with Bell products, like the TH-57).

As shown earlier, the power required curves (Figure 10-6) show that the **power required to hover is quite high due to the high induced velocity required to produce the necessary thrust. The power required then decreases quite rapidly in the middle ranges of speed as a result of decreasing induced power losses. It builds up again at the higher speeds under the influence of profile and parasite drag.**

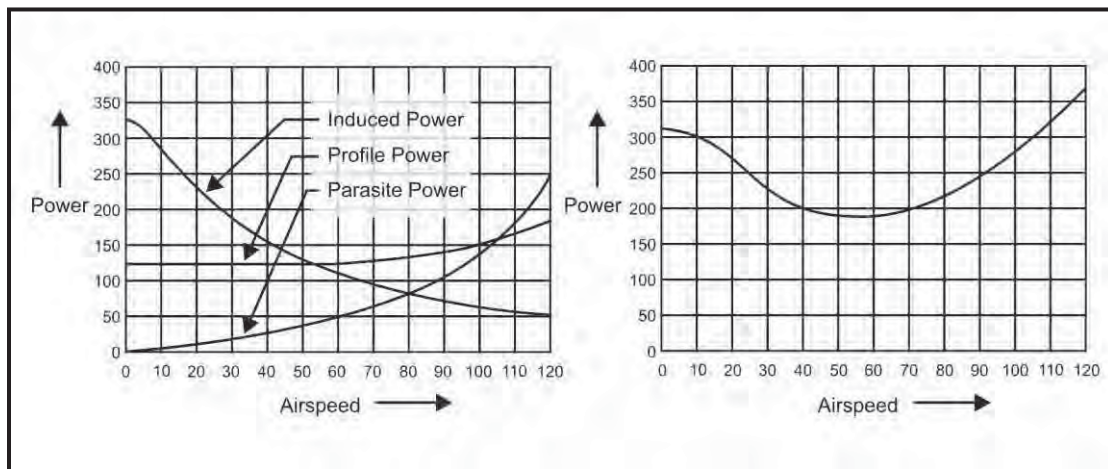

Figure 10-6 Power Required Curves

Induced, profile, and parasite power requirements are affected differently by altitude, gross weight, and temperature. The effect of changes in any of those variables on the total power required depends upon which type of power requirement is dominant at a given airspeed. In the hover/low velocity range the total power required curve will shift the same direction as does the induced power. In the medium to high airspeed range profile power requirements are most important. At very high airspeeds parasite power requirements are dominant. So an increase in altitude, for example, would move the total power required curve up most at low airspeeds,

where the induced power dominates, and move it up to a much smaller degree at medium to high airspeeds. Altitude increase, and associated lower density air, could conceivably move the power required curve down at very high airspeeds where induced power requirements have little influence because the thinner air produces less profile and parasite drag. Unfortunately, most helicopters are incapable of achieving such high speeds, thus the power required continually increases with the useable window of airspeed.

Figure 10-7 depicts the effects of changing various conditions (variables) on the left, and the effect on the three types of power required. For each variable, the chart depicts either an increase, decrease, or no effect on drag based on an **INCREASE** in that variable (condition). If we were to decrease the variables on the left the arrows in the chart would be reversed.

Condition ↑	Induced power	Profile power	Parasite power
Altitude	↑	↓	↓
Weight	↑	No direct effect	
Velocity	↓	↑	↑
Main rotor rpm	No direct effect	↑	No effect
Configuration	Wt change?	No effect	↑
Dominant range	Hover/low A/S	Medium/high A/S	High Airspeed

Figure 10-7 Effect of an Increase in Various Conditions on Power Required

1006. DOWNWIND TAKEOFF PROBLEM

As all experienced helicopter pilots know and have probably applied at some point, it is a fact that flight is possible at altitudes where hover is not possible, if sufficient airspeed can be attained. On a high DA day or operating at high gross weights you can develop a power deficit that can be overcome by flying in ground effect until minimum airspeed for flight is achieved. Sometimes acceleration after takeoff is unnecessary because winds in the area (whether natural or generated by ship maneuvering) are of sufficient speed to provide translational lift.

Properly applied, this beneficial wind effect makes helicopter operations more versatile and safe. However, in a downwind condition the improved hover capability can set up an unprepared pilot for trouble. The power required when taking off from a no-wind hover starts out high (point 1) and then decreases as one moves to the right, down the power curve (Figure 10-8). Hovering with a wind over the rotor is the same as flying at the same velocity of the wind, so the power required for a helicopter to hover is essentially the same whether in a headwind or tailwind of the same magnitude, and both correspond to point 2.

10-10 FORWARD FLIGHT PERFORMANCE

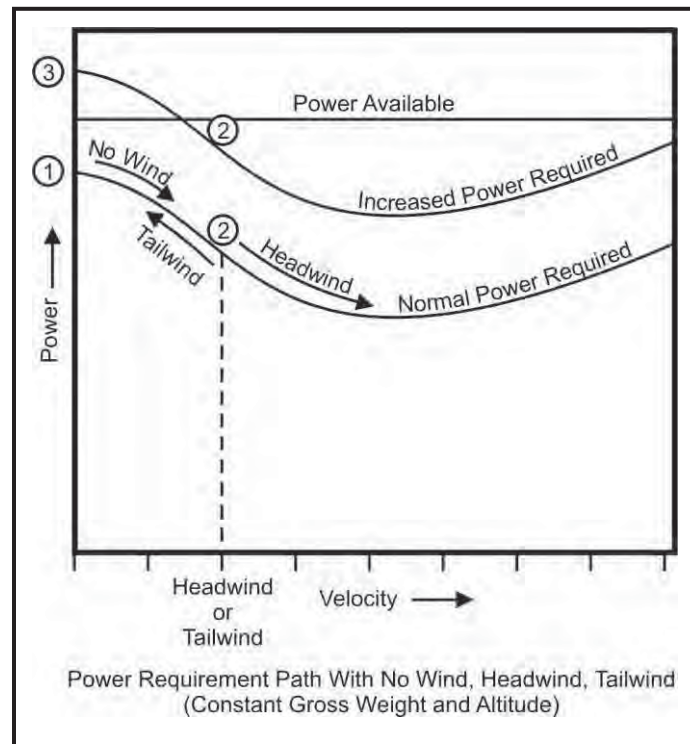

Figure 10-8 Tailwind Power Requirement

The differences in power requirements between headwind and tailwind takeoffs occur as one starts moving forward either **into** the wind or **with** the wind. (For this simplified analysis we are assuming a constant altitude and neglecting weather-vaning tendencies, or any interaction between the main rotor and the tail rotor/other main rotor). For an upwind departure (headwind), power required starts at point 2 and decreases as airspeed/groundspeed is gained and the power solution moves to the right down the power curve.

For a downwind departure (tailwind), power required initially **increases** as airspeed decreases (tailwind minus forward velocity) but at the same time groundspeed increases, so the power solution moves to the left from point 2 (Figure 10-8) and up the “backside of the power curve.” When forward velocity matches tailwind velocity in a downwind departure, the helicopter is essentially in a hover at point 1 (with regards to airspeed over the rotor, not ground speed), and requires the maximum power input. Subsequent airspeed increases cause the solution to start back down the power curve to the right in the same fashion as a no wind hover solution.

Because the majority of naval helicopters utilize a pitot-static velocity sensing system that is only reliable when facing into the wind at airspeeds of approximately 40 knots, pilots must rely upon outside sources and visual cues to approximate the wind condition.

With excess power available a downwind takeoff may be possible, but it does introduce a measure of risk. As gross weight increases, the power required curve moves up but the power

available remains unchanged (Figure 10-9). Hence, a problem arises when the power required curve shifts up above the power available curve (or the power available curve drops down). One may be able to hover with a large tailwind (point 2) but as groundspeed increases and airspeed decreases, a point is reached (point 3) beyond which power required exceeds power available (Figure 10-8). The resulting “power required exceeding power available” condition presents a real hazard. A partial loss of engine power could also cause the power deficit that induces settling.

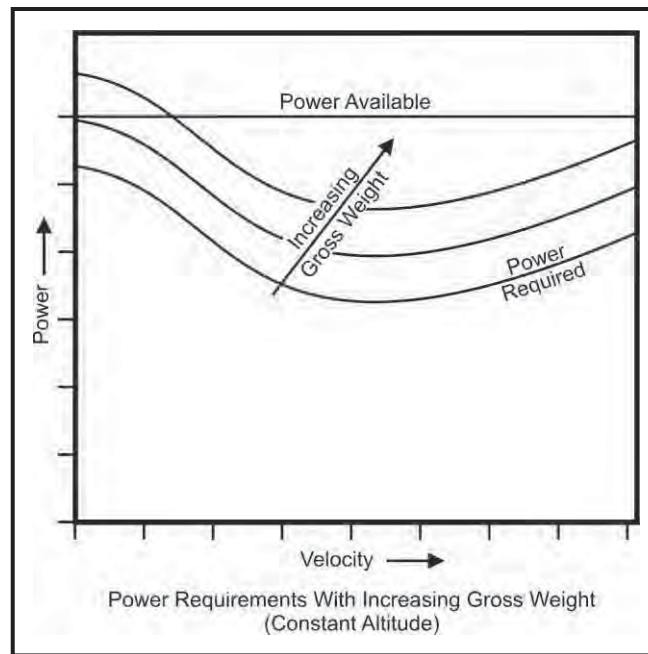

Figure 10-9 Power Required Shift With Gross Weight

Once it is apparent that a downwind takeoff has unwisely put the aircraft into a power deficit situation, what are the recovery options? A turn to try to get back into the wind will increase the apparent weight, depending on the G-load induced from the angle of bank (AOB). This will shift the power required curve up, which is detrimental. It appears, then, that once one accepts a downwind takeoff, they are “stuck” with it, both literally and figuratively. One way to shift the power required curve down and decrease weight would be to jettison external cargo/aux fuel tanks/ordnance. Another option would be to shift the power available curve up by possibly going to manual fuel/emergency throttle (on helicopters so equipped). The former solution could cost the government some money in lost/damaged gear, and the latter could cost the government an engine, but at least the crew and aircraft might be saved. Regardless of the outcome, **“Downwind departures should normally not be accepted and are performed at the crew’s own risk.”**

1007. TRANSLATIONAL FLOW AND TRANSLATIONAL LIFT

The hovering rotor produces lift due to the rotation of the blades. The rotor in forward flight also produces lift due to the rotation of the blades but has the added component of its translation

10-12 FORWARD FLIGHT PERFORMANCE

through the air. This translation, whether it is forward, sideward or rearward, changes the flow characteristics on the rotor disk, which then changes the power requirements. The dramatic reduction of power requirements associated with forward speed is due largely to reductions in induced power requirements. The efficiency of the hovering rotor system is improved with each knot of incoming wind gained by horizontal movement or surface wind. As the flow moves through the rotor more horizontally, rather than straight down and around in a vortex, the rotor operates more efficiently. The rotor encounters undisturbed air, rather than recirculating vortices. The more horizontal flow of air reduces induced drag, so induced power required also decreases. This increase in rotor efficiency is called **translational lift**.

If induced power were the only determinant of power required, the benefits of translational lift would be felt to some degree at all airspeeds. The effects of profile and parasite power requirements, however, take on greater significance at higher airspeeds. Further, the effect of vortices is less significant at higher airspeeds so most of the benefit of translational lift is noticed at lower airspeeds. As airspeed increases, induced power required decreases, so acceleration with a constant collective setting moves the helicopter into a regime where excess power (difference between available and required) steadily increases (Figure 10-10). Each aircraft is inherently different, and experiences a different amount of translational lift at different airspeeds.

The amount of "extra lift" available is determined by the slope of the induced power required curve. Typically, translational lift is gained with every knot of airspeed experienced during the transition from hover into forward flight and is **most noticeable** at airspeeds between 13 – 24 knots, depending on disk size, blade area, and rpm.

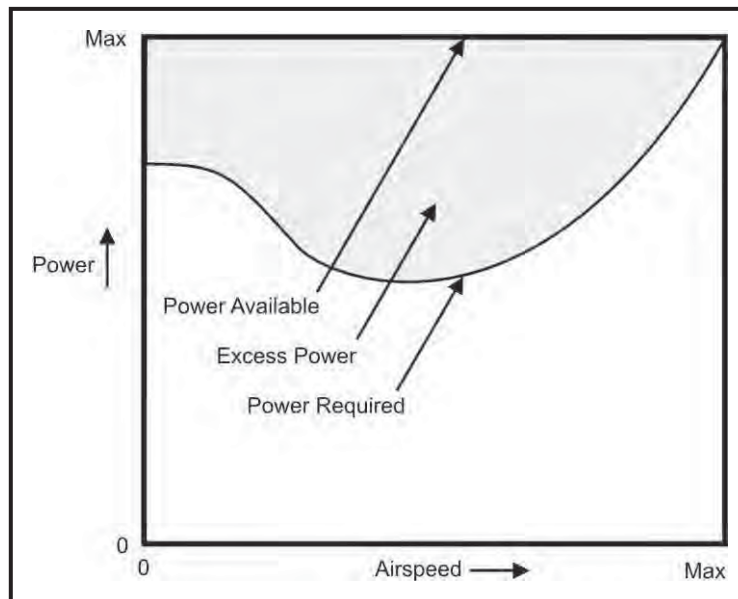

Figure 10-10 Initial Increase in Excess Power as Airspeed Increases

1008. EFFECTIVE TRANSLATIONAL LIFT

During hover and initial transition, vortices are cycled through the rotor, but even at the lowest airspeeds the greater flow of air through the system begins to counteract induced drag. As speed surpasses 6 - 15 knots the forward edge of the disk begins to encounter non-circulating air and the overall flow becomes more horizontal. Rotor blades at the front experience improved performance because they are operating in undisturbed air even as the aft portion of the disk continues to operate in a vortex. The rapidly changing lift as blades move from the efficient forward portion of the disk to the vortex-impeded aft portion of the disk is felt as a lateral vibration. Additionally, the effect of the vortex hitting the helicopter fuselage and tail throughout this transition augments the shudder. As airspeed surpasses 13 - 24 knots the entire rotor outruns recirculation of vortices, and vortices impact the fuselage and tail less. This point is called “**effective translational lift**” (Figure 10-11).

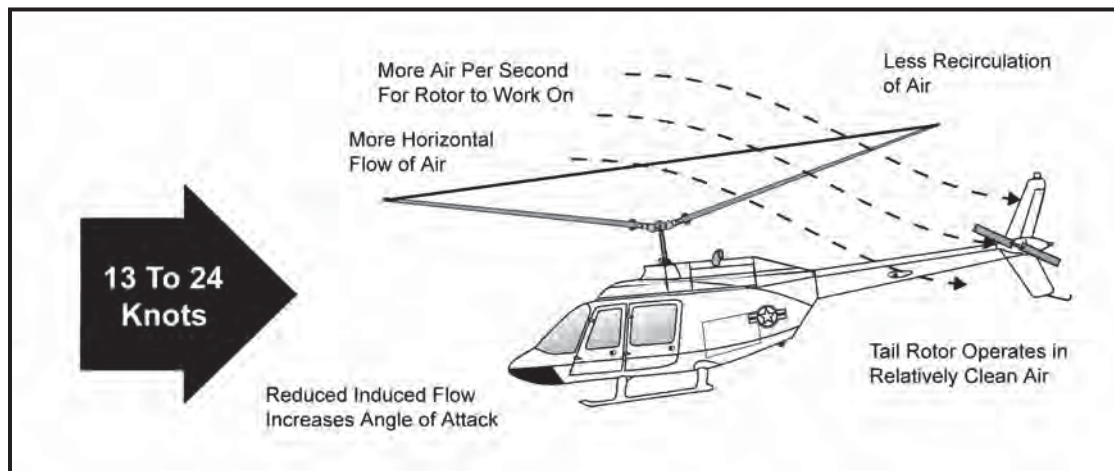

Figure 10-11 Effective Translational Lift (ETL)

At this point, the rotor no longer flies into its own vortices but continually flies into undisturbed air. The flow of air through the rotor system is more horizontal, induced flow is reduced, which also reduces induced drag, and the AOA is subsequently increased, all of which makes the rotor system operate more efficiently. At the point where effective translational lift is reached, there is typically a noticeable increase in rotor efficiency which results in a pronounced development of a positive rate of climb. This increased efficiency continues to a slightly lesser extent with increased airspeed until the best climb airspeed is reached, when total drag is at its lowest point. Airspeeds greater than this will result in lower efficiency because of increased parasite drag.

If the transition of the helicopter into forward flight is gradual, increasing translational lift will normally provide an adequate increase in lift to compensate for the slight forward tilt in the total thrust vector resulting in less of a vertical component (Figure 10-12). **If the cyclic is moved forward too quickly during the transition to takeoff without additional power being applied, the result will be a loss in the lift component of rotor thrust before airspeed increases sufficiently to provide an offsetting increase in translational lift. The result will be that the aircraft settles and may strike the ground.**

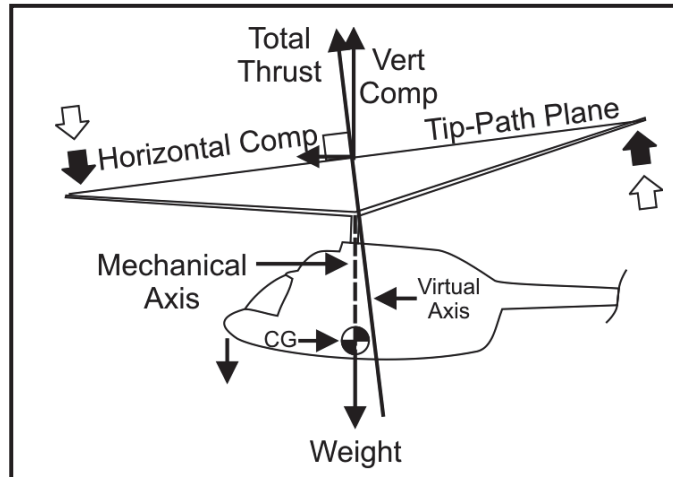

Figure 10-12 Tilted Total Thrust Vector

1009. TRANSVERSE FLOW EFFECT

A rotor in forward flight encounters air flow that is opposite the direction of travel but deflects the flow downward. As a result, air passing through the rear portion of the rotor disk has a greater downwash angle (induced velocity) than air passing through the forward portion. The downward flow at the rear of the rotor disk causes a reduced angle of attack, resulting in less lift. The front portion of the disk produces an increased angle of attack and more lift because airflow is more horizontal (Figure 10-13).

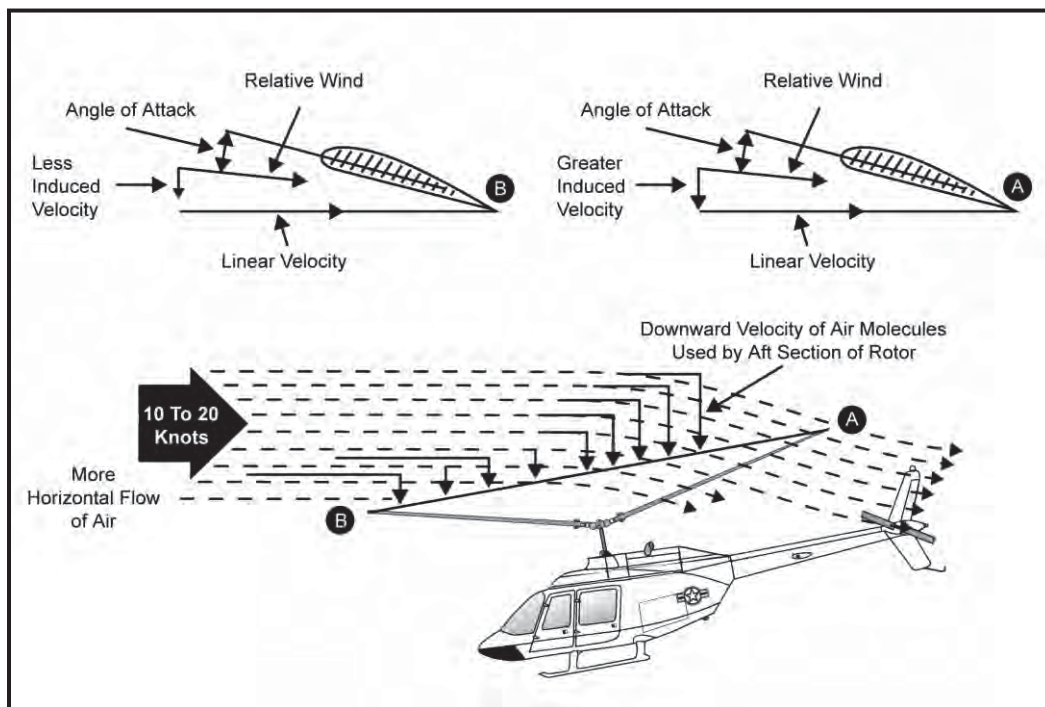

Figure 10-13 Transverse Flow Effect

A second reason for the increase in induced velocity in the aft rotor disk section is coning. The horizontal airflow may actually create an upwash in the forward disk section, but due to coning, strikes the aft section from above due to simple geometry, as depicted in Figure 10-14.

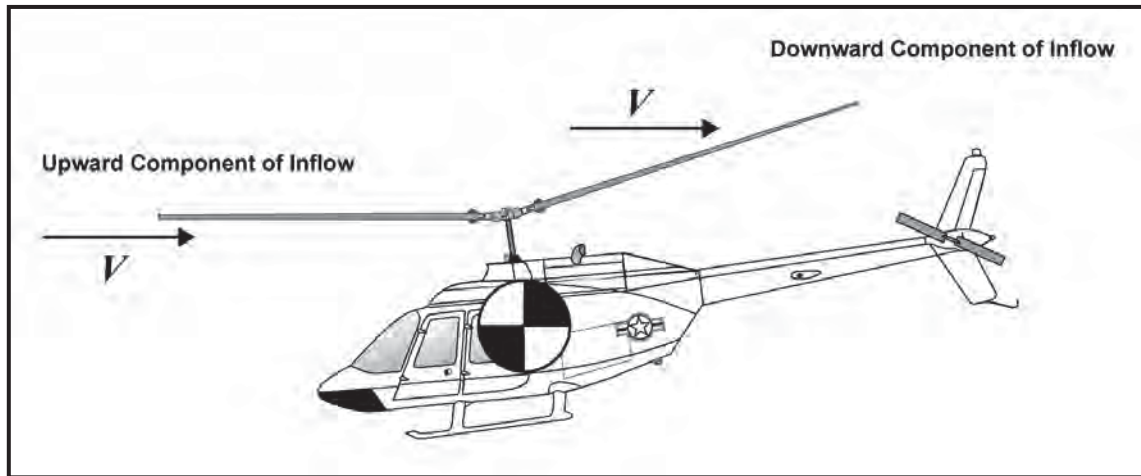

Figure 10-14 Transverse Flow Effect Due to Coning

Due to phase lag, the difference in lift between the fore and aft portions of the rotor disk is manifested 90 degrees later in the direction of rotation, resulting in a right tilt to the disk and a right rolling motion or drift. This right drift tendency caused by the difference in lift between the fore and aft portions of the rotor disk is called the **transverse flow effect** i.e., the helicopter drifts to the right as if a transverse wind (crosswind) was pushing it sideways.

Additionally, this asymmetrical induced velocity across the disk causes unequal drag (induced drag) in the fore and aft portions of the rotor disk and results in vibration that is easily recognizable by the aviator. This vibration is sometimes mistakenly thought to be an indication of effective translational lift since they both occur in the same speed range.

Although transverse flow effect occurs with any forward velocity, it is most noticeable during takeoff (between 10 and 20 kts) and, to a lesser degree, during a deceleration for landing. Coning continues to contribute to transverse flow effect in forward flight but at higher airspeeds the downward flow due to deflection occurs further aft, and may not affect the rear portion of the rotor as much. Additionally, the effects of flapping on the advancing blade will have a greater effect on the disk tilt.

To summarize, the induced velocity (flow) differential causes two effects:

1. Unequal lift distribution, felt 90 degrees after application because of phase lag, causes a helicopter to roll right as airspeed increases. The pilot (or, in some cases, the AFCS) compensates with left cyclic.
2. Unequal drag associated with lift variation in the fore and aft parts of the disk produces vibrations that are easily recognizable by the pilot. The vibrations are more noticeable for most helicopters between 10 and 20 knots.

1010. DISSYMMETRY OF LIFT

Dissymmetry of lift is the differential (unequal) lift between the advancing and retreating halves of the rotor disk caused by the different wind flow velocity across each half. This difference in lift would cause the helicopter to be uncontrollable in any situation other than hovering in a calm wind. As you recall from the discussion in Chapter Four, dissymmetry of lift was noticed in the early days of rotary wing development when rigidly attached blades were used. As soon as the aircraft gained appreciable forward speed (even before taking flight), it would roll to the left. The reason for such a reaction is thus: because lift is proportional to the relative wind speed squared, there is significantly more lift on the advancing side of the disk than the retreating side.

In examining the advancing and retreating blades, there are two variables of concern in the lift equation: velocity and coefficient of lift. V_{rot} from rotor rpm and V_{trans} from aircraft motion control the velocity. As the pilot sets a certain aircraft speed, the difference in linear velocity between the advancing and retreating blades remains unalterable by the pilot. This leaves coefficient of lift as the one variable remaining that can compensate for dissymmetry of lift. This is accomplished through blade flapping alone (or with cyclic feathering inputs, in some helicopters, through flight control rigging or AFCS inputs based on forward cyclic stick position).

Blade Flapping. When blade flapping compensates for dissymmetry of lift, the upward and downward flapping motion vectorally changes the induced flow velocity. This changes the AOA on the advancing and retreating blades, which changes the lift coefficient (recall there is a direct relationship between angle of attack and lift coefficient, which is specific for every different airfoil).

Advancing Blade. As the relative wind speed of the advancing blade increases, the blade gains lift and begins to flap up (Figure 10-15). It reaches its maximum upflap velocity at the 3-o'clock position, where the wind velocity is the greatest. This upflap creates a downward flow of air and has the same effect as increasing the induced velocity by imposing a downward vertical velocity vector to the relative wind, which decreases the AOA.

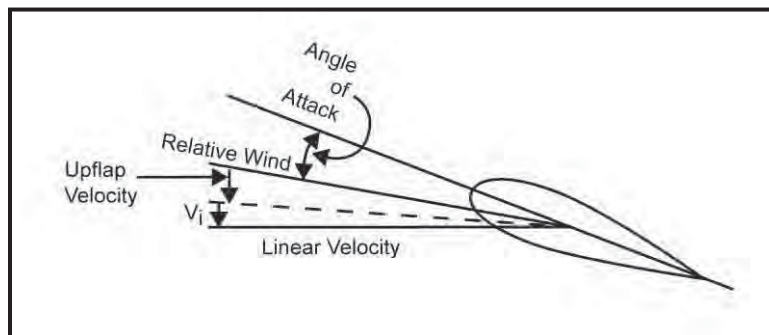

Figure 10-15 Flapping (Advancing Blade - 3-O'Clock Position)

Retreating Blade. As the relative wind speed of the retreating blade decreases, the blade loses lift and begins to flap down (Figure 10-16). It reaches its maximum downflap velocity at the

9-o'clock position, where the wind velocity is the least. This downflap creates an upward flow of air and has the same effect as decreasing the induced velocity by imposing an upward vertical velocity vector to the relative wind, which increases the AOA.

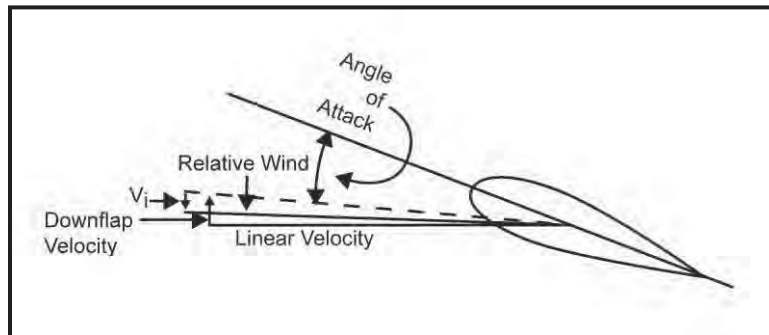

Figure 10-16 Flapping (Retreating Blade - 9-O'Clock Position)

Over the Aircraft Nose and Tail. In forward flight, the airflow is parallel to the leading edges of the blades over the nose and tail, therefore linear velocity is unaffected.

The net result of flapping is an equalization, or symmetry of lift across the rotor system. Up flapping and down flapping do not change the total amount of lift produced by the rotor system. However, as blade flapping compensates for dissymmetry of lift, the rotor disk is tilted to the rear, called blowback.

1011. BLOWBACK

Flapping solves the problem of dissymmetry of lift but introduces the problem of blowback. Increasing lift on the advancing portion of the rotor disk causes the blades to flap up, and the retreating side's decreasing lift causes the blades to flap down. Since phase lag causes maximum displacement to occur 90° after the maximum applied force, the maximum up displacement occurs at the twelve o'clock position and maximum down displacement occurs at the 6 o'clock position. The net effect is that with increasing forward speed the rotor head tilts aft. This tendency to tilt aft with increasing speed is longitudinal flapping called blowback.

Another way to look at blowback involves the three different axes associated with helicopter control: the shaft, virtual (or thrust), and control axes, discussed in Chapter Five. In a no-wind hover the control axis and the thrust vector (virtual axis) of the rotor lie in the same plane, and may even line up with the shaft axis. A rapid application of cyclic pitch while the helicopter is hovering and before forward speed is built up would show the control axis and the virtual axis on the same line but separated from the shaft axis. As forward airspeed is attained, the action of the blades in overcoming dissymmetry of lift causes a separation of the control axis and the virtual (thrust) axis of the rotor. This phenomenon is called "blowback" of the rotor. The progression is illustrated in Figure 10-17.

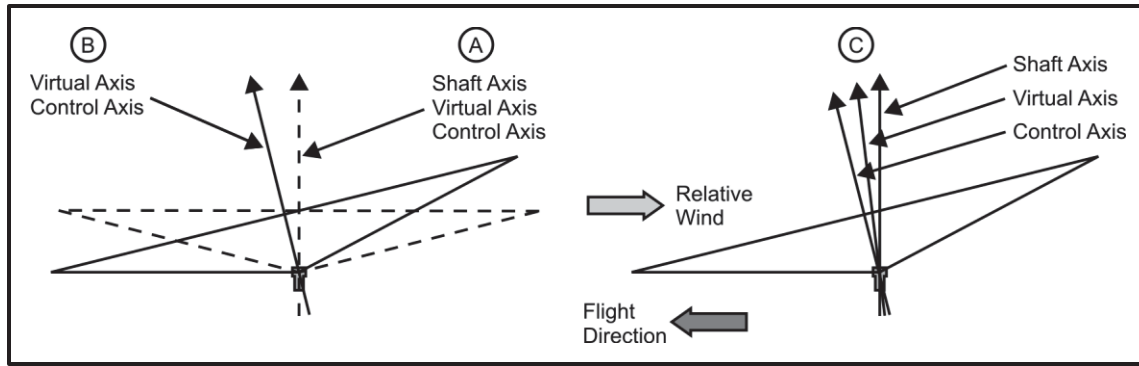

Figure 10-17 Rotor System Axes in Hover and in Forward Flight

Compensating for blowback is fairly simple, and done automatically by experienced helicopter pilots. As the aircraft accelerates, the pilot simply inputs more forward cyclic, beyond that initially input to cause the original tip path plane displacement. This is called cyclic feathering.

To compensate for blowback, the aviator must continue to move the cyclic forward as the velocity of the helicopter increases. Figure 10-18 illustrates the changes in pitch angle as the cyclic is moved forward at increased airspeeds. At a hover (no wind and ignoring translating tendency), the cyclic is centered and the pitch angle on the advancing and retreating blades is the same. At low forward speeds, moving the cyclic forward reduces the pitch angle on the advancing blade and increases the pitch angle on the retreating blade. This causes a slight rotor tilt. At higher forward speeds, the aviator must continue to move the cyclic forward. This further reduces the pitch angle on the advancing blade and further increases the pitch angle on the retreating blade. As a result, there is even more tilt to the rotor than at lower speeds.

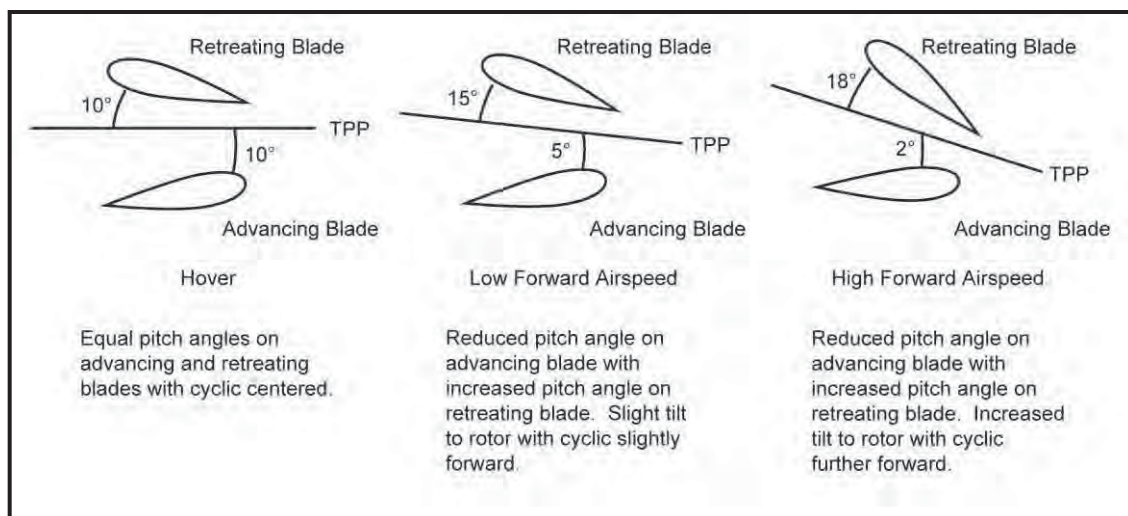

Figure 10-18 Blade Pitch Angles

This horizontal component of rotor thrust generates higher helicopter airspeed. The higher airspeed induces blade flapping to maintain symmetry of lift. The combination of flapping and

cyclic feathering maintains symmetry of lift and the desired attitude on the rotor system and helicopter.

When decelerating the helicopter, dissymmetry of lift decreases as the airspeed differential between the advancing and retreating blades decreases. Therefore there is less flapping and less blowback of the rotor disk. This will cause the nose of the aircraft to drop and re-accelerate the aircraft unless the pilot gradually increases back stick pressure (aft cyclic feathering) to maintain the desired nose attitude for the desired airspeed he is slowing to.

1012. PENDULUM EFFECT

As the helicopter transitions to a hover from a decelerating glideslope as in a normal approach, it often experiences an uncommanded nose-up tendency, not nose-down as described above. This is referred to as **Pendulum Effect**, and it occurs in response to increased collective pitch. The change in total rotor thrust changes the moment to the CG which changes the trim solution of the helicopter. This overrides the effects of decelerating rotor blowback and causes the nose of the aircraft to pitch up (Figure 10-19), which must be compensated for with forward cyclic.

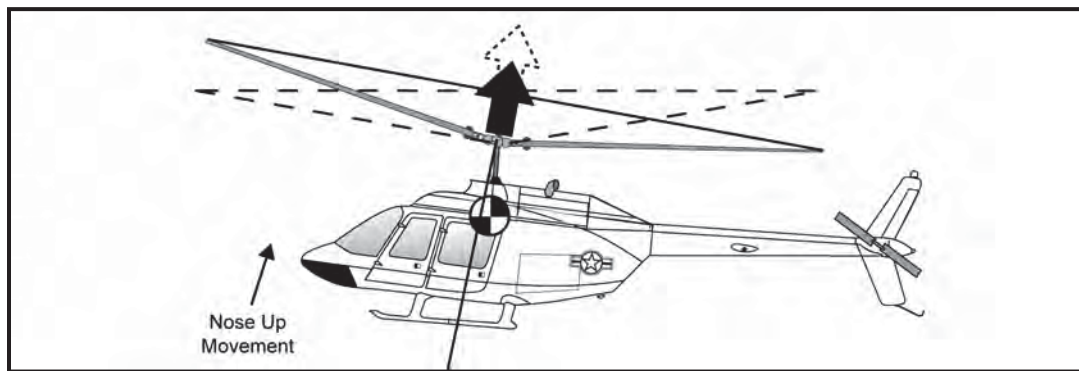

Figure 10-19 Pendulum Effect

In summary, as a single-rotor aircraft transitions from hover to forward flight, the nose rises, or pitches up, and the aircraft rolls to the right. The combined effects of dissymmetry of lift, phase lag, translational lift, and the transverse flow effect cause these tendencies. Aviators must correct with additional forward and left lateral cyclic input to maintain a constant rotor disk attitude.

1013. GROUND VORTEX

Occasionally during a discussion of takeoff operations, pilots will hear the term “ground vortex” mentioned. As previously discussed, in a hover the rotor downwash travels outward from the aircraft after impacting the ground. The height of this outward traveling airflow is approximately equal to $1/3$ the rotor diameter and has a curling tendency. This is called the **ground vortex**. The speed of the vortex as it moves further from the aircraft slows due to friction from the ground. As the helicopter moves forward, it catches up with the ground vortex, and the rotor downwash mixes with increased relative wind to create a rotating vortex, which

eventually causes an increased downwash through the rotor system. This simulates a climbing situation, increasing power required. Eventually this vortex is overrun at a higher speed. These flow patterns are depicted in Figure 10-20. Since the rotor is 13 feet above the ground in a standard 5 foot hover for the TH-57, a normal takeoff profile will usually keep the TH-57 from experiencing the effects of a ground vortex to any significant degree.

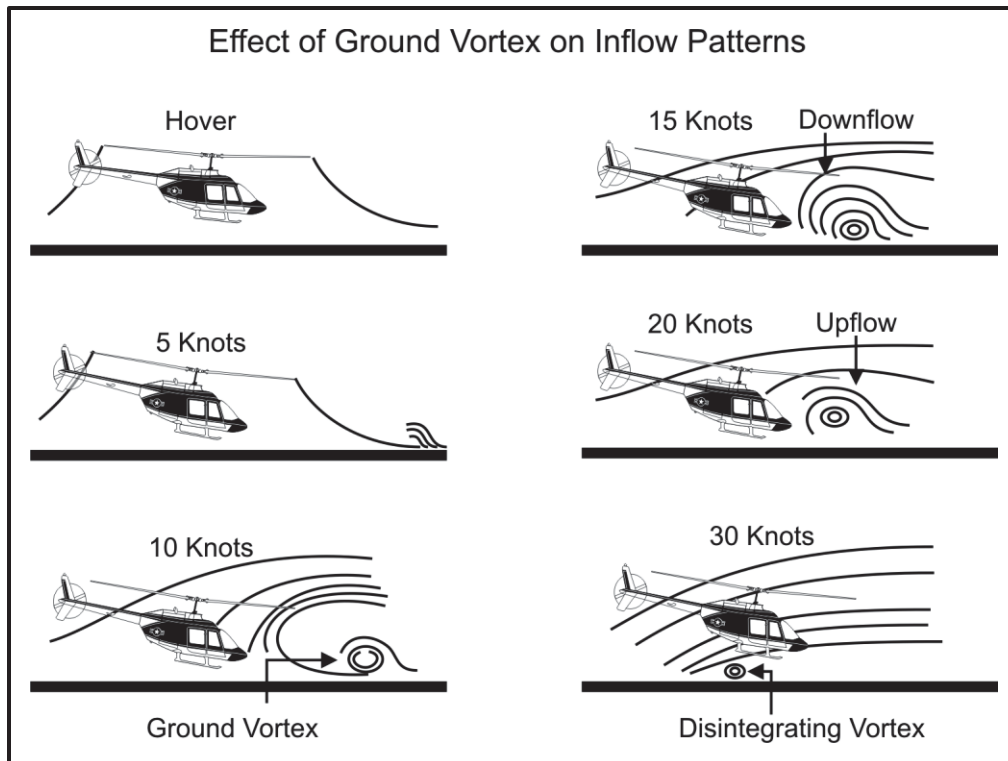

Figure 10-20 Ground Vortex

1014. RETREATING BLADE STALL

Retreating Blade. The limitation that the retreating blade encounters in high speed flight is blade stall. It occurs as a result of reduced local relative wind velocities, flapping, and the increased forward cyclic that must be applied to attain and maintain high speed flight.

The relative wind at any point on the rotor blade is the sum of the V_{rot} , V_{trans} , and V_{ind} . V_{rot} depends upon the rate of rotation of the rotor blades (rotor rpm) and distance from the hub. V_{trans} adds to the linear velocity on the advancing side but acts in the opposite direction on the retreating side.

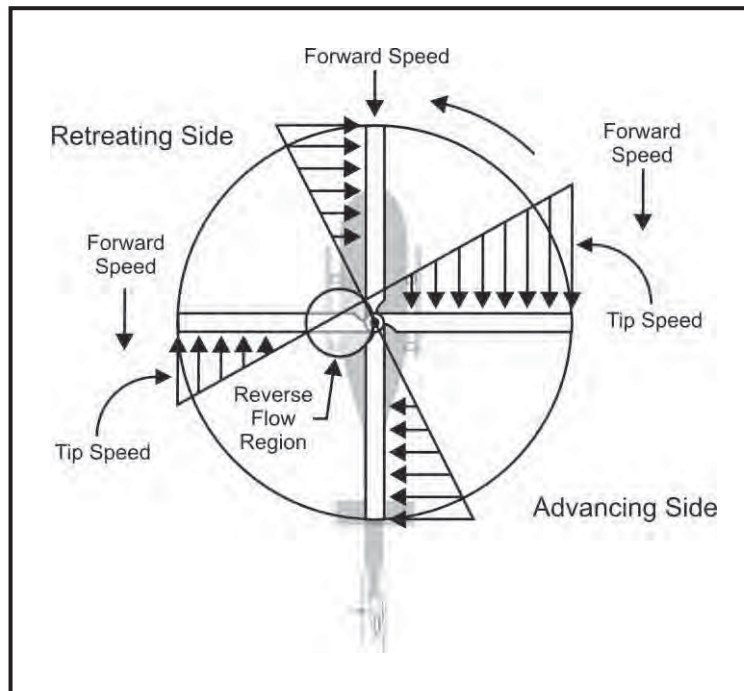

Figure 10-21 Velocity Distribution in Forward Flight

Figure 10-21 shows how relative wind velocity changes at points on the blade as one moves out from the hub and around the rotor arc. The Reverse Flow Region in the figure grows and becomes very important in high speed flight. In that region the speed due to rotation is less than the helicopter's forward speed, so air actually flows from the rotor blade's trailing edge to the leading edge. As airspeed increases, the growth of the region of reverse flow means that a smaller disk area on the retreating side produces lift. To compensate, AOA is increased on the portions outside the region of reverse flow. In addition, AOA must be increased at all points on the retreating blade to compensate for decreasing relative wind that results from subtracting forward speeds from rotational velocities.

Flapping makes the problem worse. However, it is necessary to allow the blade to flap to overcome the dissymmetry of lift caused by variations in relative wind due to forward flight. Recall that the idea of flapping was to increase lift on the retreating side by increasing AOA when the blade fell (decreasing induced velocity). The falling blade encounters an upward relative wind as it falls (Figure 10-22).

The upward wind moves the overall relative wind lower and increases the AOA. The tip of the retreating blade at the nine o'clock position gains the most AOA from flapping because the nine o'clock position has maximum downflap velocity, and the tip flaps down the fastest because of its distance from the hub.

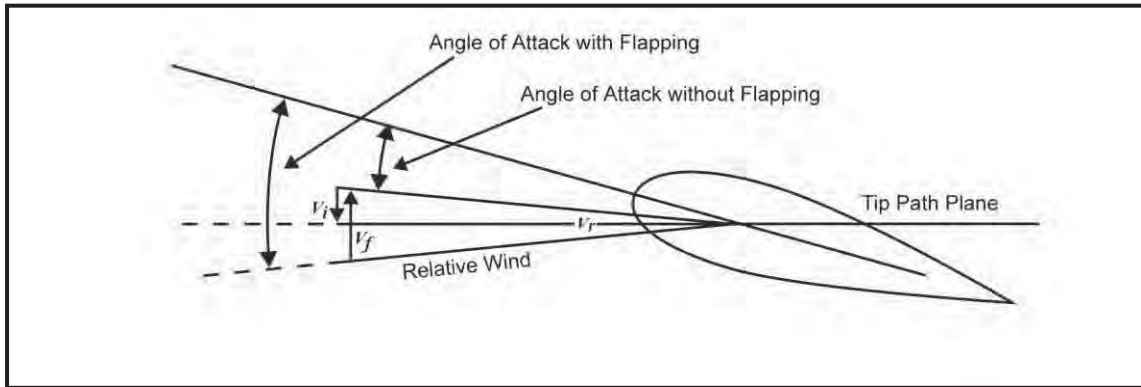

Figure 10-22 Retreating Blade Flapping

The AOA distribution around the rotor disk looks something like the diagram in Figure 10-23. In high speed flight, when the AOA is already increased because of speed effects, flapping increases AOA to a point that is closer to stall AOA.

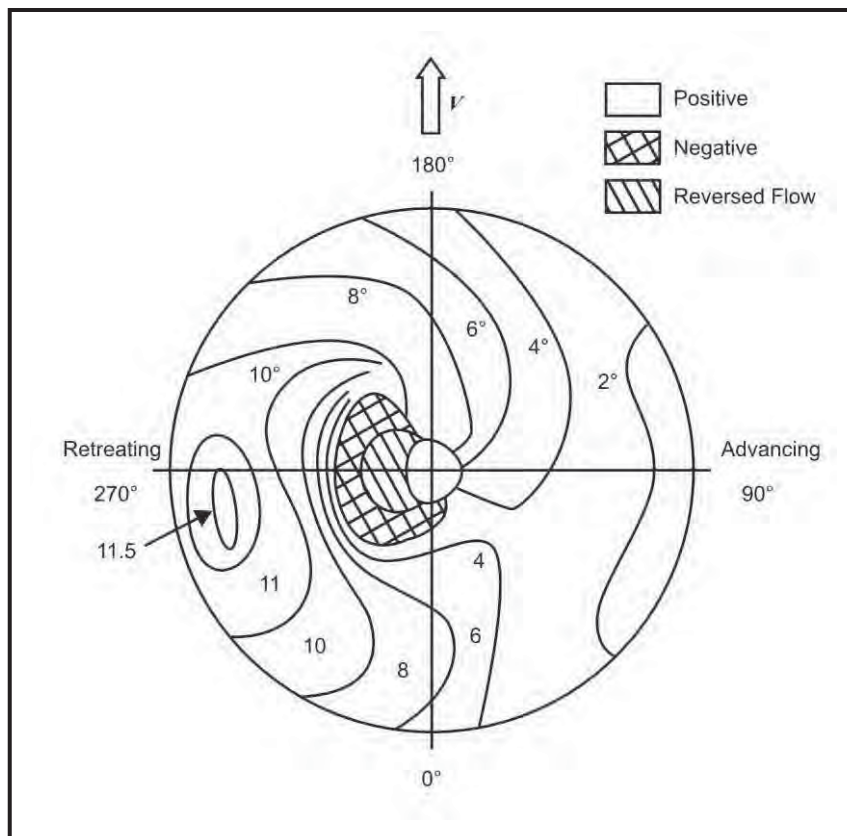

Figure 10-23 AOA Distribution

One other factor increases the AOA on the retreating side even more: the disk angle that must be used to generate forward speed. The helicopter is accelerated by tilting the disk forward.

Because of phase-lag, the mechanism to tilt the disk forward is an increase in AOA on the retreating side blades. At some point, airspeed effects, flapping of the retreating blade, and increased forward cyclic input combine to increase AOA beyond stall at the tip, where AOA is highest. If forward speed is increased even more, the stall region grows inboard. The combination of a blade stall region with a reverse flow region greatly reduces lift area (Figure 10-24).

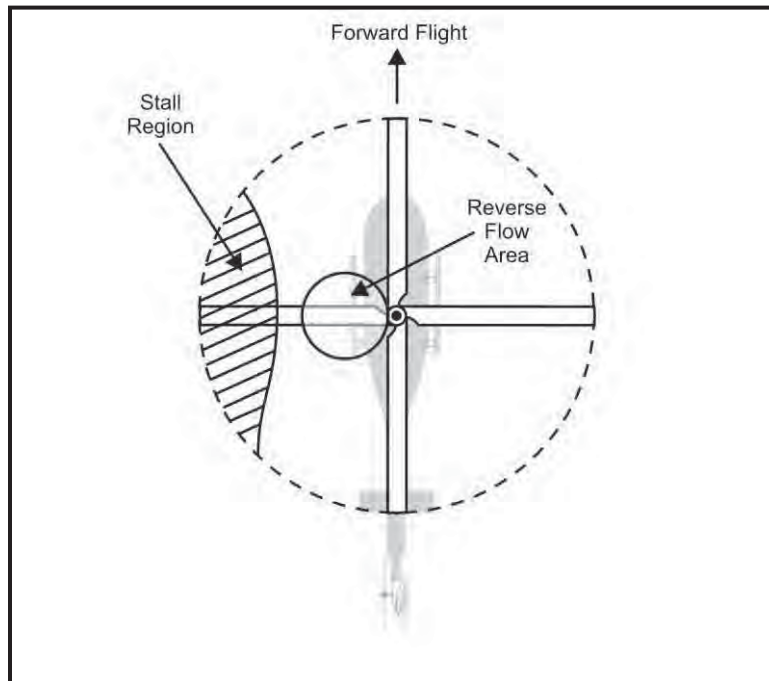

Figure 10-24 Retreating Blade Stall Region

The sudden loss of lift and increase in drag experienced by a blade as it passes through the stall region, followed by increased lift and decreased drag after passing through the stall, causes a periodic disturbance. This periodic disturbance is felt as a pronounced vibration much like a vibration might be felt if a car tire had a flat spot. Compensating for the additional drag requires more power to keep the hub turning at a constant rpm, so an increase in power required is another indication of blade stall.

When retreating blade stall occurs, the effects are very noticeable. Because the first area affected is the tip near the nine o'clock position, a loss of lift will first be manifested at that point. Because of phase lag, however, the change will not be fully felt until about 90° later. For this reason, a definite indication of retreating blade stall is a sudden drop in the blade disk at the 6 o'clock position, which is felt as a pitch up. As the stall region grows and cross coupling occurs, a roll is likely to develop. The cross coupling is a result of the sudden pitch up leading to a sudden tail-low attitude. Prior to the pitch up, the high anti-torque requirement and nose-low attitude placed the tail rotor thrust vector near the level of the main rotor, where a large degree of left cyclic was necessary to counteract the tail rotor thrust. A pitch up then results in both of these forces contributing to a rapid left roll.

Blade Stall Indications

1. Vibrations (asymmetrical AOA distribution)
2. Increased power required to overcome the dragging stalled region
3. **Pitch up and possible roll to the left** (counterclockwise rotating main rotor systems)

Recovering from retreating blade stall is simply a matter of recognizing possible causes and eliminating them. Retreating blade stall occurs because of excessive AOA, so factors that require higher AOA are contributors.

Factors That Lead to Retreating Blade Stall

1. Low Rotor rpm – reduces blade relative wind, requiring higher AOA to generate lift.
2. High Gross Weight – requires more lift, which means higher AOA.
3. High DA – requires more AOA because less air is moved across the blade per second.
4. G-loading – effectively increases weight.
5. High Airspeed – reduces retreating side relative wind while requiring higher pitch angle on the retreating blade to achieve disk tilt.

Recovering from blade stall involves eliminating the contributing factors.

Blade Stall Recovery (anything to decrease pitch or forward velocity)

1. Increase Rotor rpm.
2. Reduce Gross Weight.
3. Descend.
4. Reduce G-loading – reduce AOB.
5. Reduce Airspeed.

It is possible that the helicopter will assist in recovery naturally. When retreating blade stall occurs, the aircraft's natural tendency is to pitch up, which decreases forward velocity and the AOA of retreating blades.

1015. COMPRESSIBILITY

Because the forward speed of the helicopter is added to the rotational velocity of the advancing blade, the highest relative wind velocities occur at the tip of the advancing blade. When the Mach number of the tip section of the advancing blade exceeds the **Critical Mach number** for the rotor blade section, the results are compressibility effects. The principal effect of compressibility is a large increase in drag and rearward shift of the airfoil aerodynamic center (AC). Compressibility effects on the helicopter increase the power required to maintain rotor rpm and cause rotor roughness, vibration, cyclic shake, and an undesirable structural twisting of the rotor blade. Compressibility effects become more severe at higher lift coefficients (higher blade angles of attack) and higher Mach numbers.

Adverse Compressibility Conditions. The following operating conditions represent the conditions that contribute to compressibility:

1. High airspeed.
2. High rotor rpm.
3. High gross weight.
4. High DA.
5. High-G maneuvers.
6. Low temperature—the speed of sound is proportional to the square root of the absolute temperature; therefore, it decreases as temperature decreases.
7. Turbulent air—sharp gusts momentarily increase the blade AOA and thus lower the Critical Mach number to the point where compressibility effects may be encountered on the blade.

Corrective Actions. Corrective actions are any actions that will decrease the AOA or velocity of the airflow. There are similarities in the critical conditions for compressibility and retreating blade stall, with one notable exception: compressibility occurs at high rotor rpm, and retreating blade stall occurs at low rotor rpm. With the exception of rpm control, the recovery technique is identical for both. Such techniques include decreasing:

1. Blade pitch by lowering collective, if possible.
2. Rotor rpm.
3. Severity of maneuver.
4. Airspeed.

Critical Mach Number. Critical Mach Number is the flow speed at which the **local** velocity at some point on an airfoil first reaches sonic speed. Because airfoils speed up flow on the upper surface to generate lift, the flow over the top is faster than the free stream. When the free stream past a section of the rotor blade is going about Mach .72, at the point of maximum velocity over the airfoil’s surface the local speed may reach Mach 1.0, or the speed of sound (Figure 10-25). That flow Mach number, .72, is known as the Critical Mach Number. Actual Critical Mach Number depends upon the shape of the airfoil.

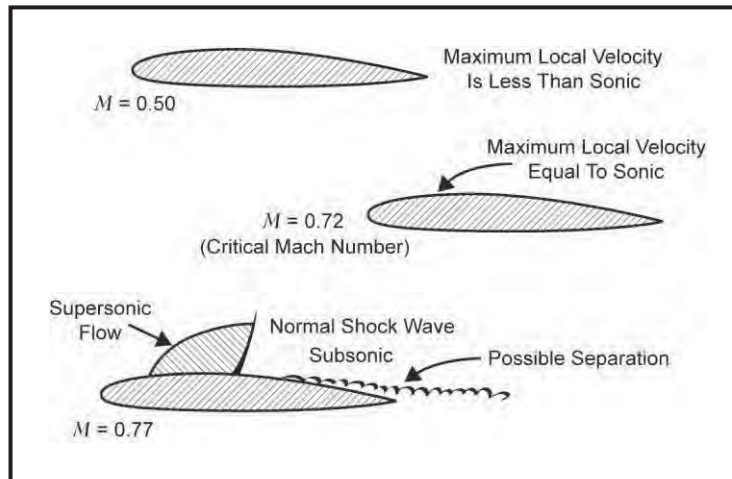

Figure 10-25 Critical Mach Number

Drag Divergence Mach Number (M_{DD}). Drag Divergence Mach is a speed that exists above the critical Mach number but below sonic velocity. At speed above the Critical Mach Number, air becomes more and more compressible. It begins to form a shock wave that increases drag and disrupts flow. As the flow over the airfoil moves faster and faster, stronger shock waves begin to form on the airfoil. The flow disruption and strong pressure disturbances greatly increase drag and cause airflow separation. Drag due to compression starts out small at lower speeds, but at some point before sonic velocity begins to dramatically increase. The mach number at which the drag dramatically increases is called Drag or Force Divergence Mach Number (Figure 10-26).

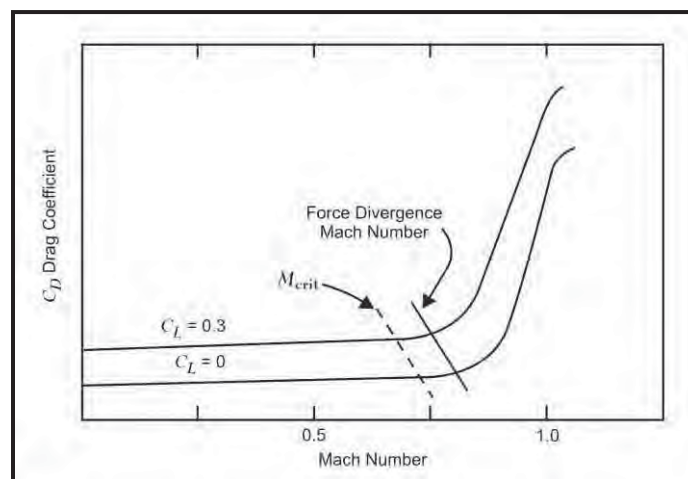

Figure 10-26 Drag Increase with Mach Number

The highest speed encountered by the blades in forward flight occurs at a rotor blade's tip as it passes the 3 o'clock position. At that point the velocity equals the rpm times the blade radius, plus the helicopter's forward velocity. When velocity at the tip on the advancing side approaches M_{DD} an increase in power is required to overcome extra drag. The fact that drag increases at one point on the rotor disk and not at others is felt as a vibration. Also, as compressibility increases near M_{DD} on the advancing blade, there is an increase in vibrations and structural stress as the AC of the rotor blade migrates rearward in the transonic region. An additional undesirable effect is noise as blades repeatedly "break the sound barrier" as they go around the disc's advancing side.

The solutions typically used to deal with advancing blade compressibility effects are sweeping the leading edge of the rotor blades back, varying the airfoil thickness along the span, and varying the airfoil section along the span. Sweep reduces the velocity that the blade tip "sees" thereby delaying drag divergence and reduces the C_L max of the airfoil.

Variation of airfoil thickness and of airfoil section serve to change the properties of the airfoil. As the rotational velocity increases out towards the end of the blade, the thickness decreases or the overall qualities of the airfoil change to take advantage of the increase in speed. An example of these solutions can be found on the British Experimental Rotor Program (BERP) blade that was flown on a Westland Lynx in 1986, which set the current world helicopter speed record of 249.1 mph (400.87 kph).

Westland Lynx. BERP blades reduce effective blade tip Mach number with tip sweep thereby delaying the onset of compressibility losses. The retreating blade stall is delayed by a blade tip notch which generates a vortex that reenergizes the flow, and the asymmetrical blade tip shape keeps the blade CG closer to the rest of the blade thereby reducing twisting effects. An extra 700 HP from the engine, which is limited by the transmission, is exhausted through a converging nozzle yielding 600 lbs of additional thrust so this aircraft, while being quite fast, cannot establish a steady-state hover.

Other designs that were tested to reduce the effects of high speed on the advancing or retreating blades are the following:

Advancing Blade Concept (ABC). Retreating blade stall was alleviated by incorporating a coaxial main rotor system which has an "advancing blade" on both sides of the aircraft.

X-WING. Retreating blade stall and compressibility effects were alleviated by using an elliptical airfoil shape that employed circulation control for "pitch" change, a wing, and engines for high speed propulsion.

Tiltrotor. Retreating blade stall was alleviated by using rotors as propellers in high speed flight, with turboprop speeds limited to about 400 knots by propeller tip compressibility losses.

1016. BLADE REGIONS**1. No-Lift Areas**

The no-lift areas in forward flight are reverse flow, negative stall, and negative lift.

2. Reverse Flow (Part A)

Part A of Figure 10-27 shows reverse flow. At the root of the retreating blade is an area where the air flows backward from the trailing to the leading edge of the blade. This is due to the wind created by forward airspeed being greater than the rotational velocity at this point on the blade.

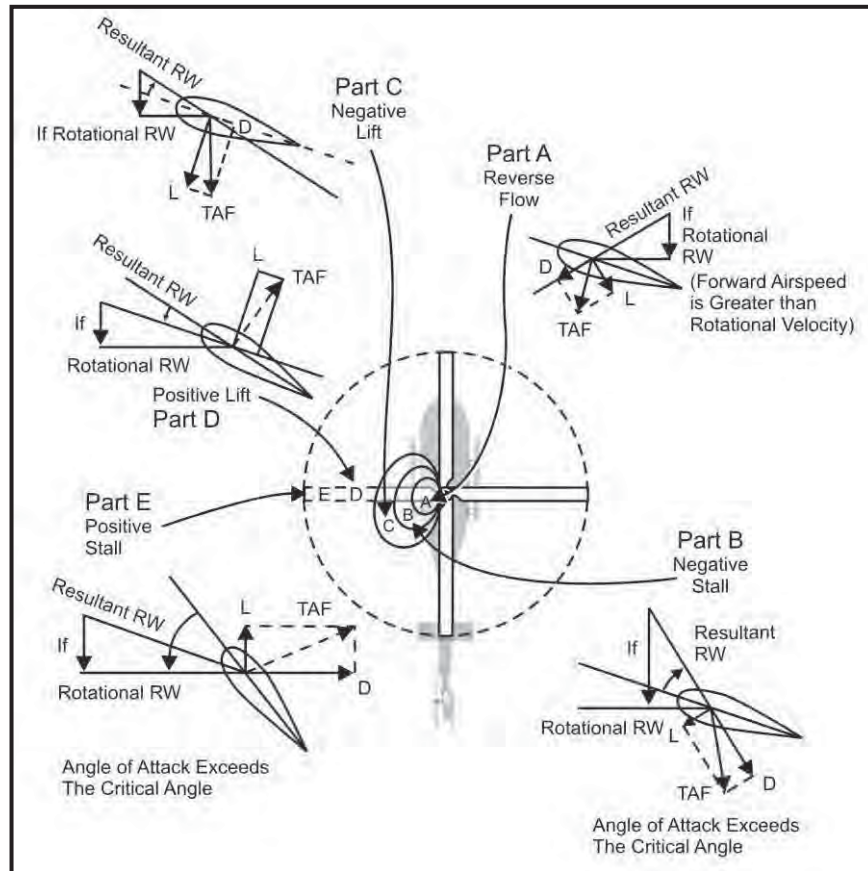

Figure 10-27 Blade Areas in Forward Flight

3. Negative Stall (Part B)

Part B of Figure 10-27 shows negative stall. In the negative stall area, rotational velocity exceeds forward flight velocity, causing the resultant relative wind to move toward the leading edge. The resultant relative wind is so far above the chord line that a negative AOA above the critical AOA results. The blade stalls with a negative AOA.

4. Negative Lift (Part C)

Part C of Figure 10-27 shows negative lift. In the negative lift area, rotational velocity, induced flow, and blade flapping combine to reduce the AOA from a negative stall to an AOA that causes the blade to produce negative lift.

5. Positive Lift (Part D) and Positive Stall (Part E)

Parts D and E of Figure 10-27 show positive lift and positive stall. That portion of the blade outboard of the no-lift areas produces positive lift. In the positive lift area, the resultant relative wind produces a positive AOA. Under certain conditions, it is possible to have a positive stall area near the blade tip. Section 1014 covers retreating blade stall.

1017. REVIEW OF OPTIMUM AIRSPEEDS

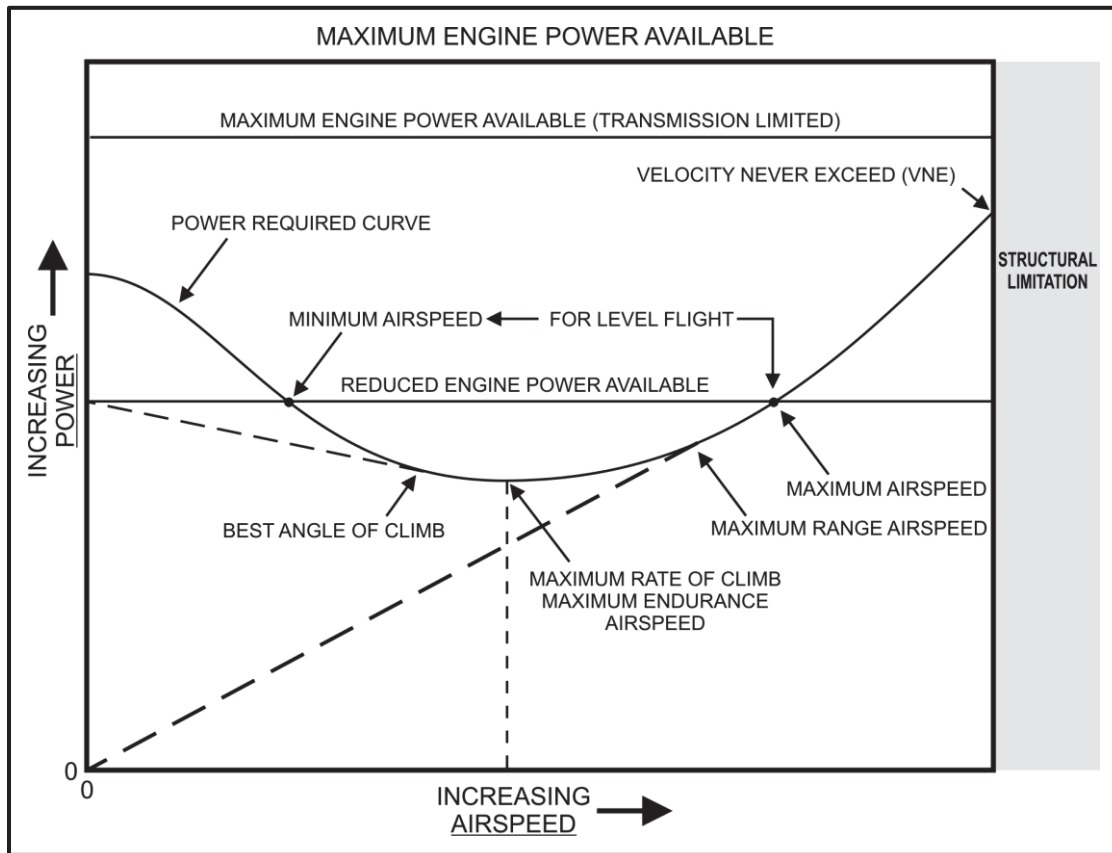

Figure 10-28 Optimum Airspeeds

Optimum Airspeeds. Choosing appropriate level-flight airspeed is an important part of obtaining the most appropriate performance for a mission. Airspeeds for maximum speed, maximum range, and maximum endurance are distinct, and vary with aircraft loading and environment. In a given set of conditions, one performance parameter may be more crucial than others, so flight at the airspeed that would maximize that potential makes sense. For example, if holding while awaiting deck landing space is important, the pilot should fly at the airspeed that gives the best endurance. In a long over-water mission, best range may be appropriate. Maximum speed is required in a time critical situation. Fortunately, the required airspeed for any of these situations is easily found on a power required versus airspeed chart.

Speeds for endurance and range. As a previous lesson pointed out, power required varies with weight, altitude, and airspeed. The chart section of a NATOPS manual contains power required curves that are divided up typically by PA (pressure altitude). They depict power requirements at a variety of aircraft weights in a format similar to that used here (Figure 10-29). Recall that for the TH-57 charts, Bell has them standing on end. The shape of this curve has been likened, by some, to be just like a collective position curve; the collective is highest in a no-wind hover, decreases with increasing forward airspeed to the "bucket," and increases again as airspeed approaches V_{NE} .

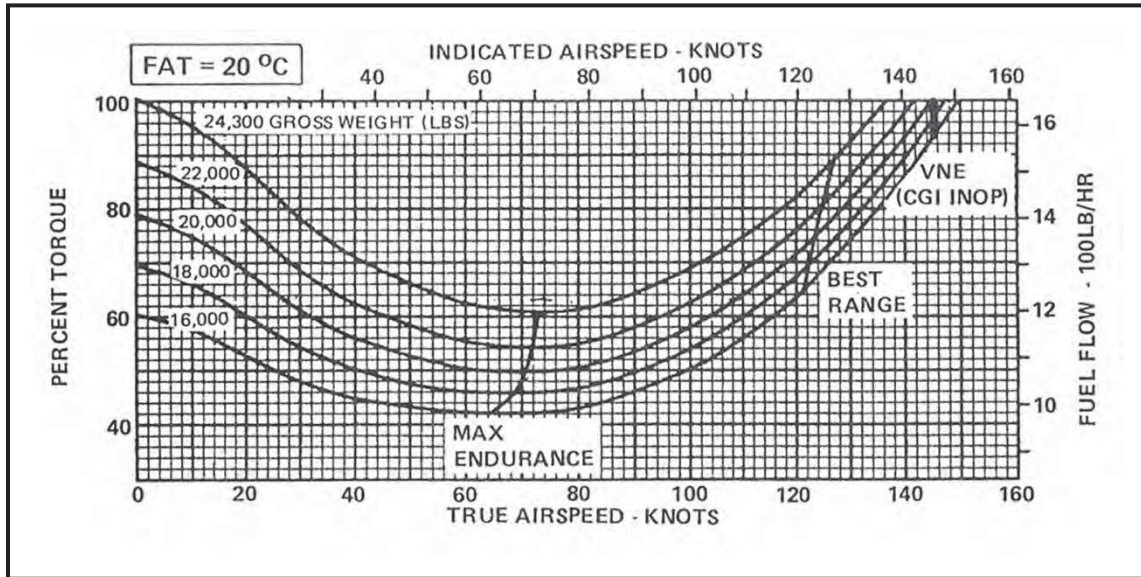

Figure 10-29 Power Required Chart (CH-46E)

The power required curve also depicts fuel flow required at various airspeeds because power has a direct relationship to the amount of fuel introduced into a gas turbine. In a no-wind hover, power required is the highest, so fuel flow is also the highest. Power and fuel flow decrease as forward velocity is increased toward the "bucket", and then increase again as airspeed approaches V_{NE} . Thus, a relationship between fuel flow and forward speed can be visualized.

As can be seen from Figures 10-28 and 10-29, minimum fuel flow occurs at the bucket airspeed, so the bucket airspeed is identified as the point of maximum endurance.

The airspeed for maximum range is determined by drawing a tangent line from the origin to the fuel flow/power required curve (notice that in Figure 10-29 a best range airspeed line has already been added). The slope, or the change in the vertical direction with respect to the change in the horizontal direction, is fuel flow/airspeed. Units of the slope are lb/hr divided by NM/hr. When the hours are cancelled in the slope, the units of slope are pounds of fuel used per nautical mile traveled. Minimizing the slope translates to finding the point at which the least fuel is burned for each nautical mile of travel (pound/NM). The least fuel per nautical mile is the same as the most distance covered for the least amount of fuel used, or **maximum range**.

The fuel per nautical mile can also be used to determine range capability with a given amount of fuel onboard. The inverse of the slope at a point in Figure 10-28 is airspeed divided by fuel flow, or NM / lb fuel. Nautical mile range per pound of fuel is known as specific or unit range. It is a very useful parameter for range estimates, as the following example shows:

Example. Using Figure 10-29, one can determine that a CH-46E at a gross weight of 20,000 lbs would need to fly 124 KTAS for maximum range. Fuel flow at that speed (dual engine) would be roughly 1375 lbs/hr. Dividing the fuel flow by the airspeed yields pounds of fuel per nautical mile: $(1375 \text{ lbs/hr}) / (124 \text{ NM/hr}) = 11.09 \text{ lb/NM}$.

Thus, for the given conditions the engines would consume 11.09 lbs of fuel per nautical mile traveled. Such a figure is not very useful in planning. The inverse, however, gives an indication of how far the helicopter could go on a tank of gas. The inverse of 11.09 lb/NM is .090 NM/lb, so the aircraft would travel for .090 NM (547 feet) per pound of fuel aboard. If the CH-46E in question had 200 pounds of fuel on board (per engine) it would be capable of flying for 18.0 NM in a no wind scenario.

So how do winds factor into this situation? Winds do not affect endurance airspeed because distance over the ground is not important in endurance calculations. Endurance solely deals with time aloft at minimum power, minimum amount of fuel burned, and airspeed felt at the rotor is the same whether wind is present or not.

Maximum range, however, **is** affected by winds because it involves maximizing movement over the ground with minimal fuel flow. Speed over the ground is faster with a tailwind and slower with a headwind, so the origin (zero point) of the airspeed axis must be shifted by the amount of the headwind (Figure 10-30). Thought of another way, with a headwind the aircraft does not go as far and with a tailwind it goes further.

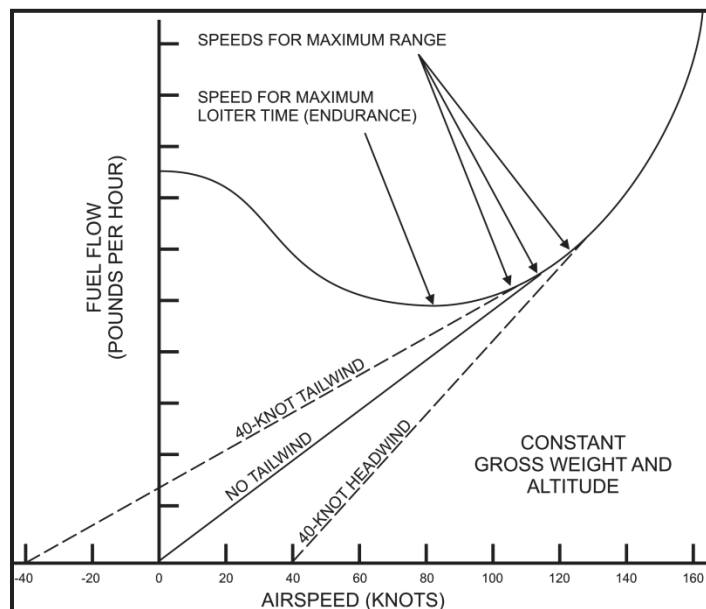

Figure 10-30 Fuel Flow vs. TAS

The pilot must select the airspeed to fly in a headwind or tailwind that will give him the most "bang for the buck," that is, the most distance traveled for the fuel with the given winds.

If the helicopter in the example flies a maximum range profile at 124 KTAS, it will not go as far in a 40-knot headwind, and it will go further with a tailwind. Shifting the origin (right for a headwind and left for a tailwind) and drawing the tangent from that point yields the airspeed needed to maximize range over the ground.

Repeated use of the above system of determining wind correction has given results at typical maximum range airspeeds that are predictable even without chart work. A good rule of thumb, based upon consistently close approximations, is to add 1/4 of the headwind component on to no-wind maximum range airspeed and to subtract 1/6 of the tailwind component. It should be noted that these percentages will change with gross weight, ambient air conditions, and aircraft T/M/S. The aviator is recommended to thoroughly sift through his own power and airspeed charts in order to validate these trends. The difference between the two adjustments has to do with the shape of the curve and the effect of shifting the origin and the resulting point of intersection of the tangent line.

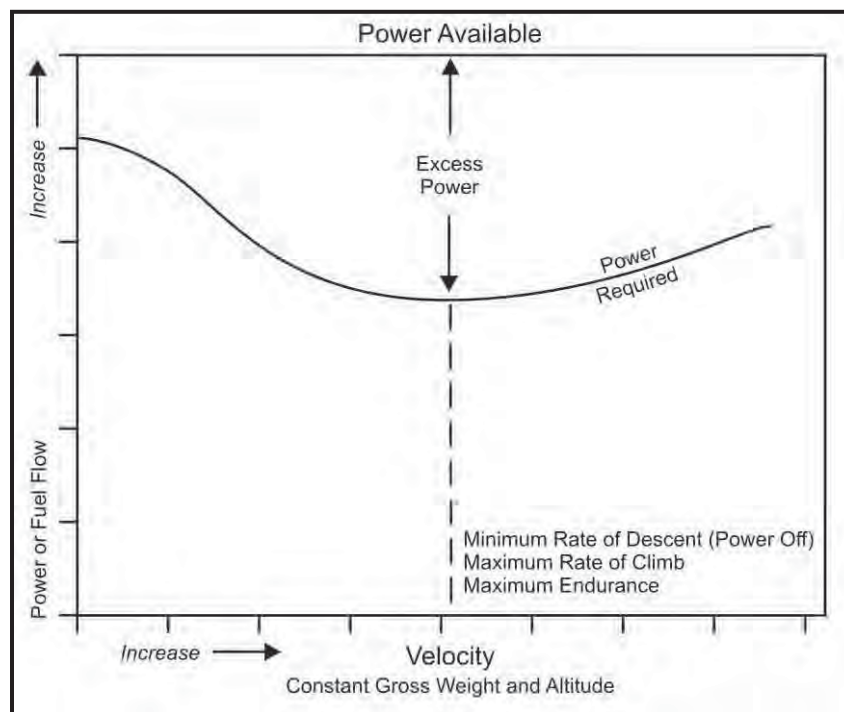

Figure 10-31 Excess Power

Maximum rate of climb and minimum rate of descent. The airspeed to fly for maximum endurance (the bucket airspeed) is also suitable for maximizing performance in two other regimes: maximum rate of climb and minimum rate of descent with power off. Maximum rate of climb occurs at the bucket because minimum power required subtracted from a fairly constant power available yields the largest amount of excess power available (Figure 10-31). If airspeed

is maintained constant, excess power can be used to climb or maneuver. Likewise, in a descent, the point of minimum power required for flight is the point at which power deficit, which relates directly to sink rate, would occur in a power-off situation. Note that max endurance and max rate of climb are found at the bucket of a power chart, while minimum rate of descent is found at the bucket of an autorotation chart (discussed in Chapter Eleven). Maximum glide airspeed is obtained using a similar method as that used for maximum range, but is also determined from an autorotation chart for the TH-57 aircraft.

How does fuel consumption change with altitude? The specific fuel consumption of the gas turbine varies with two primary operating parameters: temperature and power output. The specific fuel consumption is defined as nautical miles per pound of fuel.

As density is decreased, both the fuel flow and SHP decrease proportionally, so it can be said that density variations do not by themselves influence specific fuel consumption (disregarding profile and parasitic drag). However, as altitude is increased, temperature normally decreases. Because the turbine may deliver a given thrust output with less fuel at a lower inlet temperature, the specific fuel consumption normally improves (decreases) with altitude. If the atmosphere can be considered to be standard, the specific fuel consumption decreases to the tropopause and then remains constant until the efficiency of the compressor begins to break down at sufficiently high altitudes. The standard atmosphere has a temperature decrease up to the tropopause (approx. 36,000 feet).

Specific fuel consumption also varies quite noticeably with power output. The gas turbine is designed so that it operates most efficiently at high power outputs. This means that the specific fuel consumption is lowest at higher power settings, and that 100% N_g is the optimum speed for greatest efficiency. Note that total fuel consumption does not go down at high power settings; specific fuel consumption, or pound of fuel per hour per SHP does. For a given amount of shaft horsepower output, the least amount of fuel is burned (highest efficiency) at high power settings. This situation poses an interesting problem for helicopters. Because helicopters use turboshaft engines, the fuel efficiency of the aircraft is determined by the efficiency of both the engine and the rotor system. An increase in DA requires more work by the rotor system for the same flight profile. Engine efficiency gains at altitude are balanced by rotor efficiency losses. Actual fuel efficiency obtained at altitude thus depends upon rotor system efficiency, installed aircraft engine characteristics, work output requirement, and total fuel load. In general, at low gross weights one gets better range at higher altitude while at high gross weights a better range is achieved at sea level (Figure 10-32).

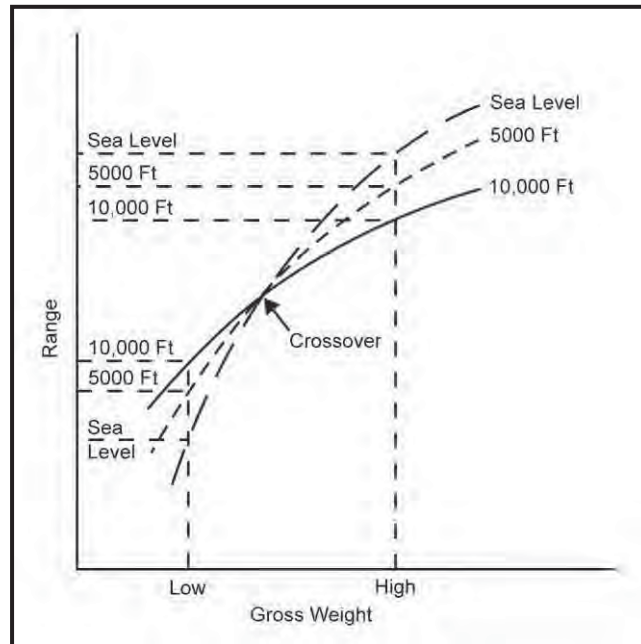

Figure 10-32 Max Range Altitude vs. Gross Weight

As might be expected, fuel flow increases at higher gross weights. As aircraft gross weight increases, power required increases and hence fuel flow increases. Also, the airspeed for maximum range also increases due to the shift in the power required curve (Figure 10-29). In fact, a look back at Figure 10-29 reveals that maximum range and endurance airspeeds increase with increasing gross weight. This is true because increased gross weights shift the power required curve up and to the right. This trend is universally true for maximum endurance airspeeds, but varying shapes of the power required curve for some helicopters make the trend of best range airspeed unpredictable. A survey of several fleet helicopters reveals that maximum range airspeed shifts depend upon the aircraft and operating environment.

For example, the AH-1W (Figure 10-33) and SH-60B (Figure 10-34) show decreased maximum range airspeed at higher gross weights for the conditions given.

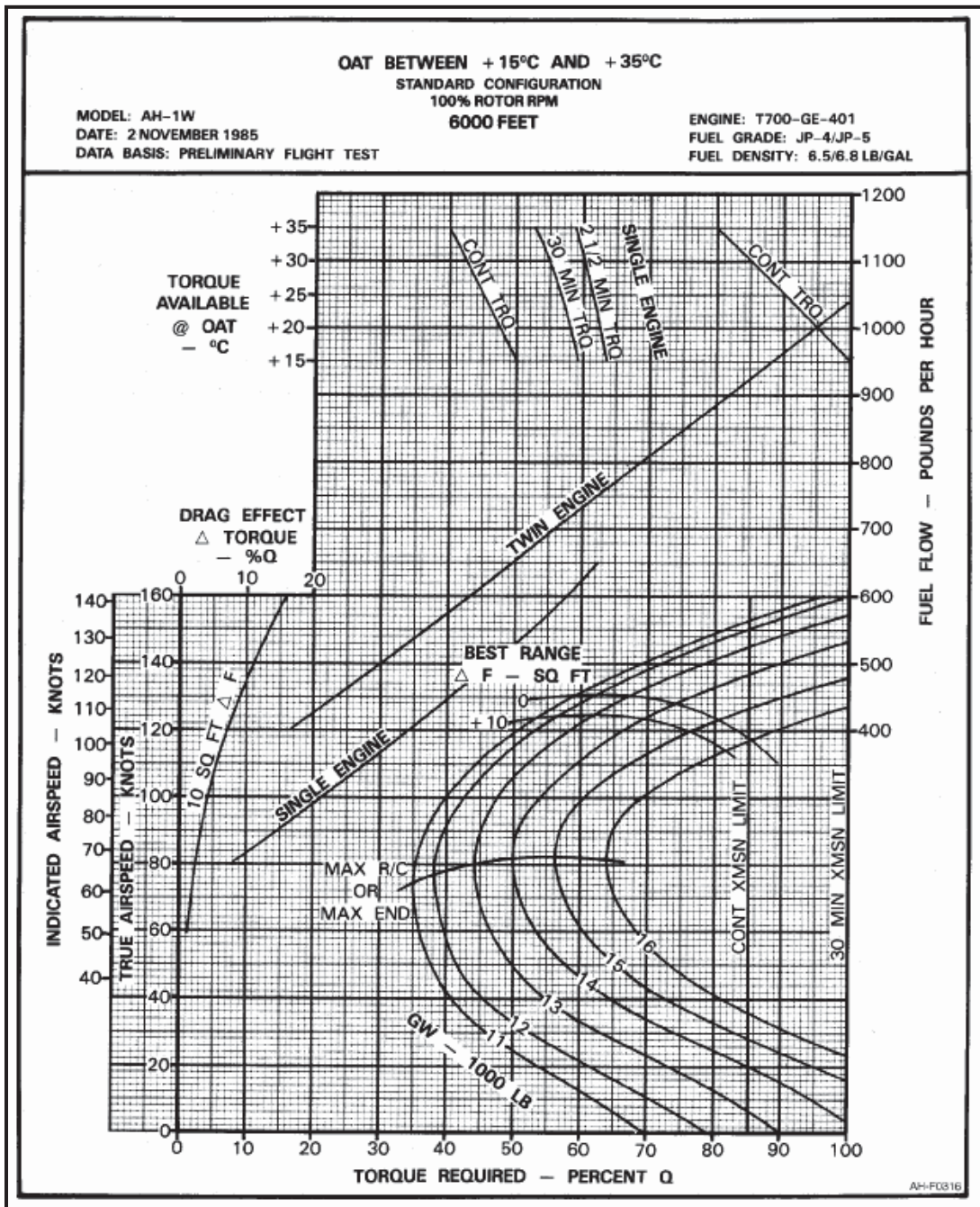

Figure 10-33 AH-1W - Max Range Airspeed vs. Gross Weight

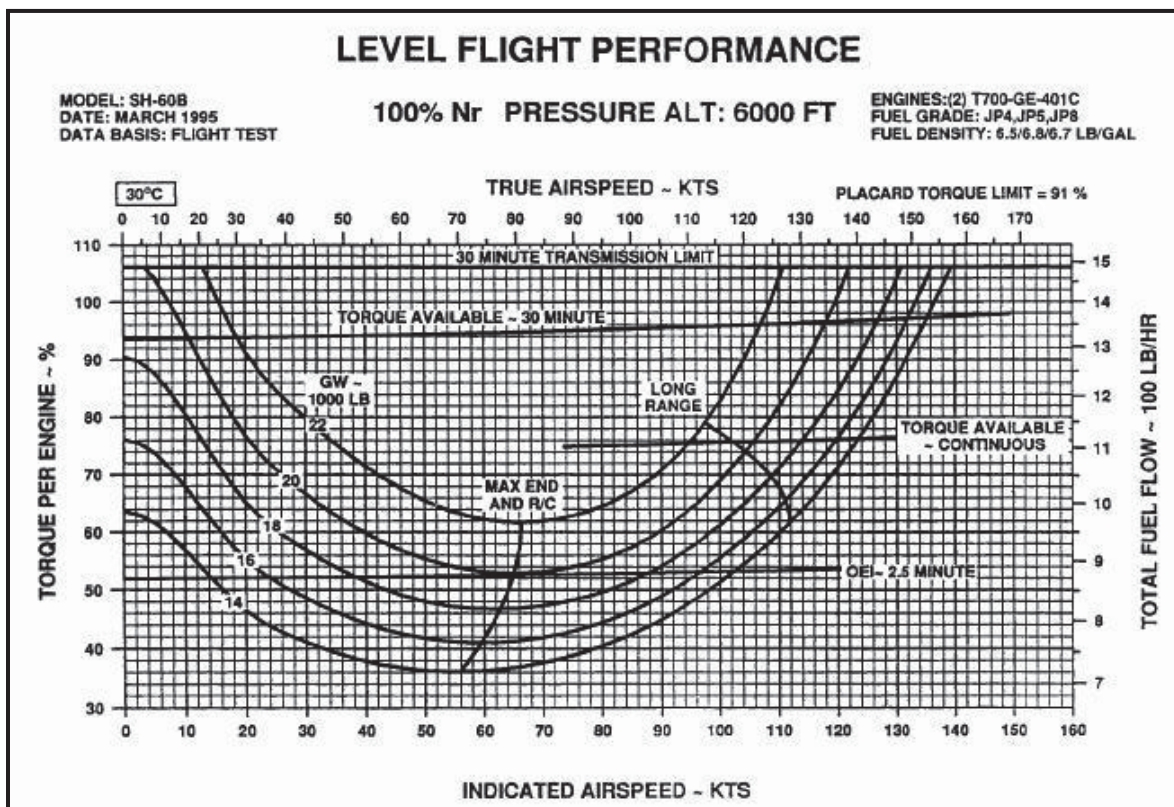

Figure 10-34 SH-60B – Max Range Airspeed vs. Gross Weight

Effect of rotor speed on range and endurance. In some situations, a helicopter may consume less fuel at a rotor speed below 100%. This benefit only occurs when profile power is a major contributor to power required, so it only applies to a certain extent. When the rotor speed gets too slow the increase in AOA required to generate lift at a slower rotational speed generates excessive drag forces.

In addition to possible drag increases, decreasing N_r for fuel efficiency can present other problems. Decreased main rotor speed produces lower tail rotor speed, so loss of tail rotor efficiency can increase power demands and, in the most extreme case, make LTA more likely. Additionally, in the event of an engine failure, rotor rpm will decay to dangerous levels more quickly.

Nonetheless, it is true that in some cases a decrease in N_r can yield a decreased fuel flow that will increase range and endurance. The overall trend in reducing N_r and its effects on fuel flow are depicted in Figure 10-35. As the figure shows, fuel flow increases below 100% N_r at high gross weights because the rotor system is attempting to lift a heavier aircraft at slower than optimal rotor speed. This feature is overwhelmingly obvious with the CH-53D but the trend is the same for all aircraft.

Thus, fuel conservation benefits occur primarily at lower percentages of maximum gross weight. Even at lower gross weights, use of this technique should be carefully considered for its necessity, thoroughly planned, and not used routinely. One hundred percent N_r is established by designers for good reasons, and is the best rotor speed for most operations.

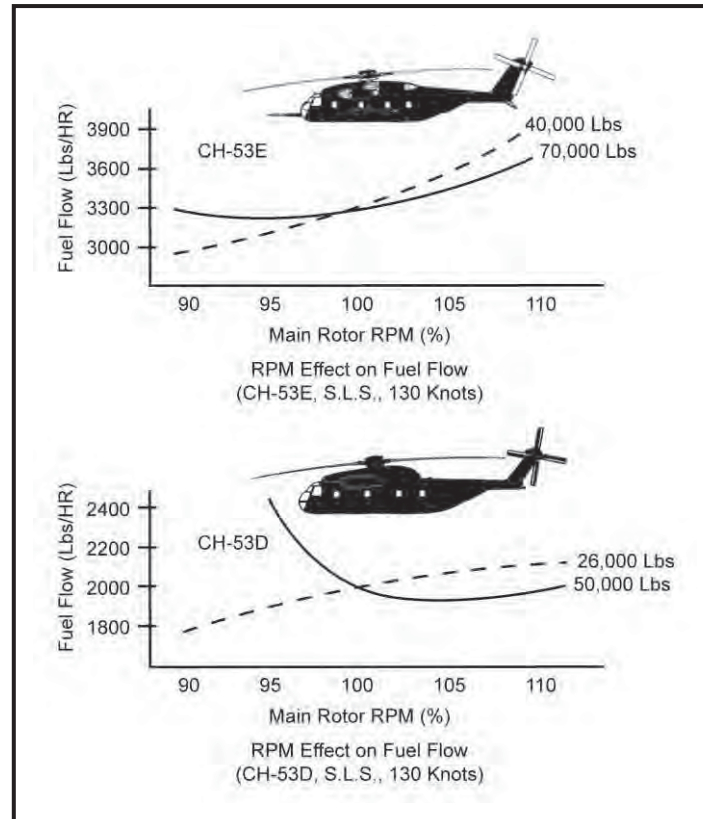

Figure 10-35 rpm vs. Fuel Flow

Another use for Bucket Airspeed. Several fleet helicopter mishaps involving gearbox failures have addressed the selection of an airspeed to fly in cases of impending catastrophic component failure while flying over water. NATOPS manuals provide some guidance in this area, and it is no coincidence that recommended speeds are generally in the vicinity of that recommended for maximum endurance. The best airspeed would be that which demands the lowest power requirements, thereby imposing the smallest load on the defective transmission/gearbox components in an attempt to delay failure. The smallest load occurs at the bucket airspeed, which is the same as the airspeed for maximum rate of climb, airspeed for minimum rate of descent in a power-off situation, and airspeed for maximum endurance. In at least one case (the CH-53E), an airspeed range is recommended for main gear box oil system failure, but the text recommends specifically that airspeed be reduced to minimum power required for flight: the bucket.

Therefore, for a given gross weight and altitude, one airspeed, the bucket, provides the performance point which maximizes potential climb rate for achieving

communication/navigation reception, minimizes fuel flow if required to loiter until assistance arrives and/or a positive fix is obtained, provides for a minimum rate of descent in the event of a power loss and subsequent ditching, and minimizes the mechanical loads on the failing components to the point of possibly delaying their demise long enough to reach terra firma or some other suitable platform.

The bucket is a very useful airspeed to keep in mind. Although the bucket shifts a little with changes in gross weight (fuel burnoff) and altitude, an average speed target that works well for the most common operating profiles is worthy of remembering. In fact, some NATOPS manuals define a "best" airspeed that implies some average value over the normal gross weight/altitude operating range.

Of course, nothing supersedes sound judgment and good headwork in adjusting to a particular emergency situation. Selection of the most favorable airspeed can depend on desired closure rates, maximum range requirements or other considerations once catastrophic failure is imminent.

Excess Power. Power available (P_A) is almost constant throughout all velocities, hence, maximum excess power occurs at the "bucket" airspeed where power required (P_R) is a minimum (Figure 10-36). The airspeed for maximum excess power equates to airspeed for maximum rate of climb, as previously discussed.

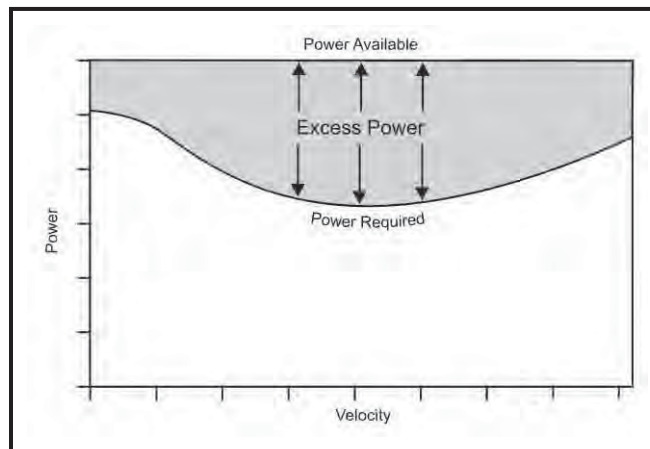

Figure 10-36 Excess Power

Best Angle of Climb. Excess power in a HOGE means that the best angle of climb is straight up. If power is not sufficient for a vertical climb, then the best angle of climb occurs at an airspeed that involves maximum vertical velocity per unit of horizontal velocity. That airspeed is obtained by drawing a tangent line from the power available line at zero airspeed to the power required curve (Figure 10-37). The tangent yields the best rate of climb for the least velocity or the most vertical distance traveled for the least horizontal distance traveled, because it identifies the point at which the most excess power occurs relative to the true airspeed. Typically, best rate of climb is denoted by V_Y and best angle of climb by V_X (Figure 10-38). Both are affected by altitude and gross weight variations due to their association with the power required curve. An increase in weight shifts the power required curve up and to the right so that the V_X airspeed

increases as the aircraft gets heavier. It also happens that V_X tends to be about 3/4 of V_Y .

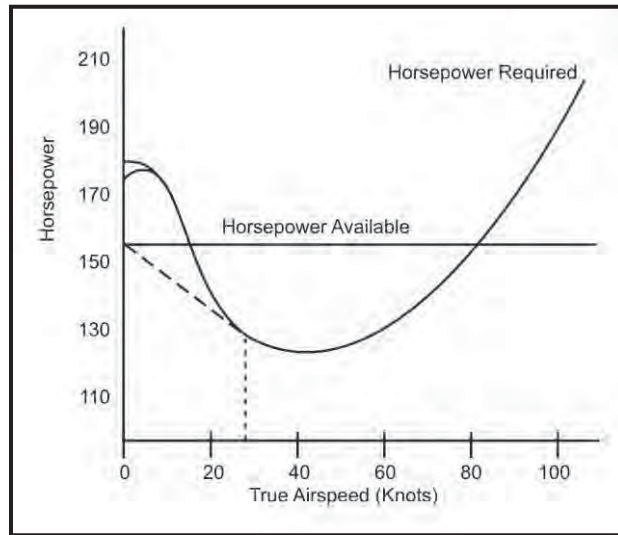

Figure 10-37 Best Angle of Climb

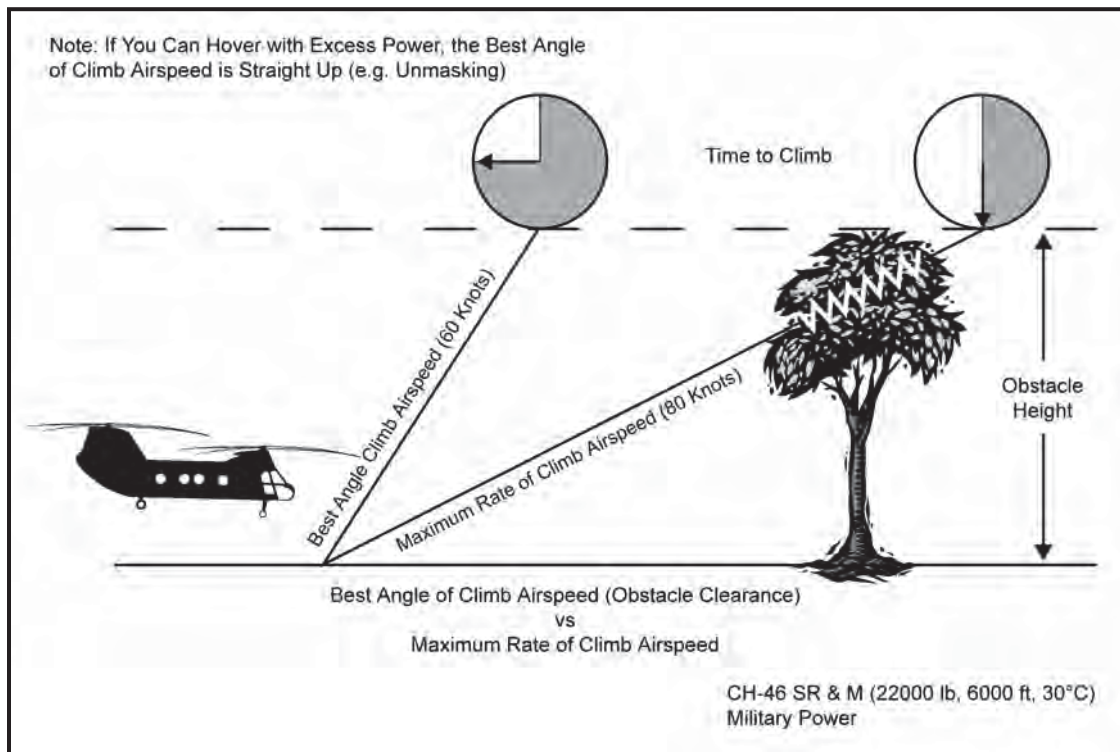

Figure 10-38 Rate of Climb vs. Best Angle of Climb

CHAPTER TEN REVIEW QUESTIONS

1. Translational lift is caused by an increase of _____ introduced to the rotor system and a decrease of _____.
2. When a helicopter enters forward flight, the advancing blade generates more lift than the retreating blade, causing _____.
3. _____ causes the nose to pitch up/down because of blade flapping over the nose caused by the combined effects of _____ and _____.
4. As forward speed increases, the "no lift" areas of the rotor system move _____.
5. The phenomenon requiring control inputs 90° ahead of the location of desired result is: _____.
6. List the indications of retreating blade stall _____

7. High gross weight and low rotor rpm increase the likelihood of retreating blade stall. _____. (True/False)
8. The proper procedure when encountering blade stall is to apply forward cyclic and full up collective. _____ (True/False)
9. Two design factors which limit a helicopter's forward speed are _____ and _____.
10. During the initial phases of dissymmetry of lift, the retreating blade feels decreasing linear velocity, thus initially decreasing _____ and decreasing aerodynamic force causing the blade to flap _____.
 - a. induced velocity... down
 - b. AOA ... up
 - c. AOA ... down
 - d. induced velocity... up
11. Translational lift increases available lift due to:
 - a. increased linear velocity
 - b. decreased linear velocity
 - c. increased mass flow
 - d. increased induced velocity

12. Dissymmetry of lift is eliminated in a fully articulated rotor head by
- horizontal hinge pins
 - vertical hinge pins
 - blade dampers
 - underslung mountings
13. Because of the effects of blowback while accelerating in forward flight, what must you do to maintain a level flight attitude?
- Hold the cyclic constant
 - Trim in nose-up
 - Trim in nose-down
 - Yaw the helicopter and reduce drag
14. Which of the following actions should NOT be the pilot's reaction if the aircraft experiences a sudden nose-up pitch while flying at high airspeeds?
- Increase rpm
 - Down collective
 - Forward cyclic
 - Jettison external load
15. Which of the following characteristics best describes powered flight Best Range Airspeed?
- Unaffected by wind
 - Greatest distance traveled for the least fuel burned
 - Higher with prevailing tailwind
 - Maximum excess power
16. Given a plot of power available and required versus velocity, which of the following statements is characteristic of maximum rate of climb velocity?
- It is that velocity that corresponds to the point on the power required curve where a line drawn from the origin becomes a tangent.
 - It is that velocity where there is maximum fuel consumption.
 - It is that velocity corresponding to range.
 - It is that velocity where there is maximum excess power.
17. Powered flight Best Range Airspeed will
- be constant for a given helicopter
 - increase with a headwind
 - be directly proportional to power available
 - decrease with a headwind

THIS PAGE INTENTIONALLY LEFT BLANK

CHAPTER TEN REVIEW ANSWERS

1. mass flow of air, induced velocity
2. dissymmetry of lift
3. blowback, up, dissymmetry of lift, phase lag
4. left of center
5. phase lag
6. vibration, loss of longitudinal control, cyclic feedback, violent pitch oscillation.
7. True
8. False
9. retreating blade stall and compressibility
10. c
11. c
12. a
13. c
14. c
15. b
16. d
17. b

CHAPTER ELEVEN DESCENDING FLIGHT

1100. INTRODUCTION

The purpose of this chapter is to aid the student in understanding the aerodynamics of descending flight. This lesson topic will introduce the concepts of the normal approach, transition to hover, VRS, autorotation, and the height-velocity diagram.

1101. LESSON TOPIC LEARNING OBJECTIVES

1. **Terminal Objective:** Partially supported by this lesson topic:

Upon completion of this unit of instruction the student will analyze aerodynamics associated with power-on and power-off descending flight.

2. **Enabling Objectives:** Completely supported by this lesson topic:

- a. List the four flow states of a rotor system in a descent.
- b. Recall the definition of Pendulum effect and describe when and how it occurs.
- c. Recall the definition of VRS, conditions for occurrence, and recovery procedures.
- d. Recall the definition of autorotation, pro-autorotative force, and anti-autorotative force.
- e. Draw and label a blade element diagram for autorotation.
- f. State the three phases required to transition from powered to unpowered flight.
- g. State the effects of a flare in autorotation.
- h. State the variables that affect autorotative descent.
- i. Identify maximum glide airspeed on a power vs. airspeed chart.
- j. List the four flow regions along a rotor blade in autorotative flight.
- k. State the purpose of the height-velocity diagram.
- l. Identify safe and unsafe areas of an H-V diagram, describing reasons for operation in safe areas, and effects of gross weight, DA, and rotor speed (N_r) on it.

1102. REFERENCES

1. Fundamentals of Aerodynamics, NAVAVSCOLSCOM-SG-111
2. Rotary Wing Aerodynamics for Naval Aviators
3. Fundamentals of Flight
4. Helicopter Aerodynamics

1103. STUDY ASSIGNMENT

1. Review Chapter Eleven.
2. Answer the Review Questions.

1104. GENERAL

When a helicopter is descending, the aerodynamic flow state through the rotor is not the same as in level flight at the same speed. Performance is directly affected by rate of descent and velocity. Traditionally, four different flow states have been identified for descending flight: normal thrusting state (which also describes hover and climb, in addition to slow descent), vortex ring state (VRS), autorotative state, and windmill brake state. For simplicity, the following brief analysis is conducted under the assumption of zero forward velocity.

Flow States and Descending Flight. Beginning with the normal thrusting state, we will use an analogy of a tunnel fan (Figure 11-1). There are three possibilities of normal thrust – hover, climb, and slow descent. For a hover, envision the fan turned off with the rotor producing a downward flow. For a climb, think of a fan pulling air down through the tunnel and rotor, increasing the induced flow through the rotor. For a slow descent, reverse the direction of the fan to blow air up the tunnel, decreasing the rotor downwash, but not enough to reverse the downwash near the rotor.

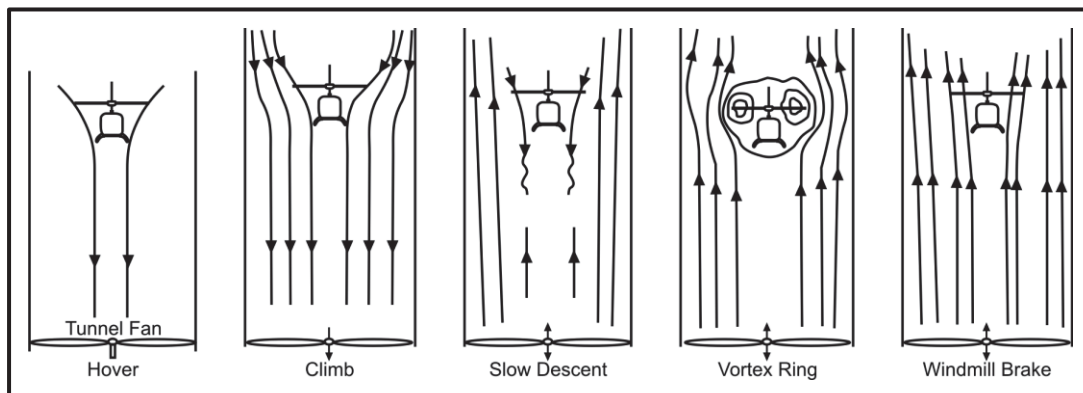

Figure 11-1 Flow States of Flight

Now turn the speed of the fan enough to equalize the flow of air going up the tunnel with the rotor-induced downwash. At this point, rotor tip vortices are not allowed to move from the vicinity of the rotor, enveloping the outer rim of the rotor in a bubble of air. Thrust developed by the rotor becomes essentially negligible, and the helicopter descent rate increases dramatically. This is known as VRS. The onset of VRS varies with types of helicopters because the onset varies proportionally in regards to descent rate and hover induced velocity. VRS will be discussed in much greater detail later in the chapter.

As the fan is turned up to maximum, the net flow becomes upward through the rotor. This is representative of both the autorotative and the windmill brake states. The rotor actually takes some energy from the passing wind and slows it down, but since rotor systems can't store or dissipate energy like windmills generating electricity, the point is academic - the length of time you will remain airborne is simply a function of terminal velocity.

1105. AERODYNAMICS OF THE NORMAL APPROACH

Normal Thrusting State. During hover and fairly low-rate descents, the velocity of the air induced through the disk exceeds the rate of descent itself. The resulting induced velocity profile is similar to that shown in Figure 11-2. All flow through the rotor is downward (relative to the rotor), but not necessarily of equal magnitude along the span because relative wind speed and AOA vary from root to tip. Thrust is quite steady, and a constant requirement for power from the engine is required to maintain rpm. This condition exists from hover to descent rates up to approximately 70% of the ideal hovering induced velocity.

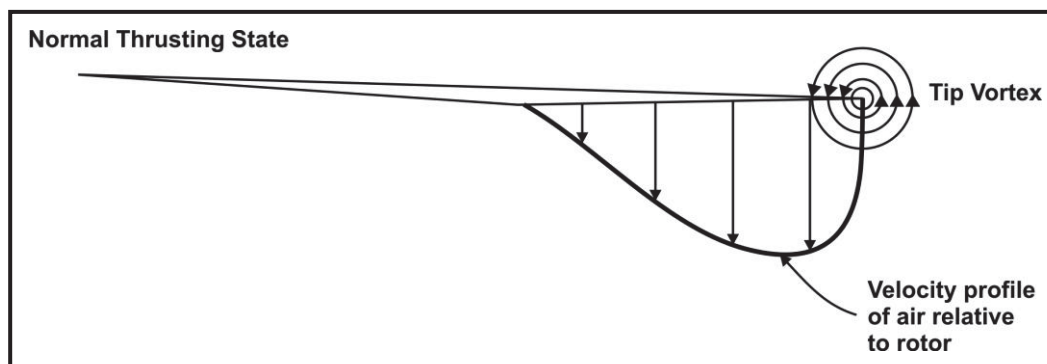

Figure 11-2 Velocity Profile in Normal Thrusting State

1106. TRANSITION TO HOVER

As previously discussed in the transition from hover to forward flight, there is less induced flow and reduced vortices in forward flight, but as the aircraft decelerates, downwash increases and the rotor system becomes less effective. As the aircraft slows, dissymmetry of lift and therefore flapping decreases (less blowback) and the nose of the aircraft will want to drop. Deceleration requires a continual and gradual addition of aft cyclic as blowback diminishes, until the desired airspeed is achieved. Recall though, that at the bottom of the approach there is a tendency for the

nose to pitch up due to **pendulum effect**. During deceleration, aft cyclic causes the tip path plane to tilt rearward, which tilts the virtual axis to the rear of the mechanical axis. When the aircraft loses translational lift, it is common to increase collective to arrest the descent and maintain the desired approach path. If a significant pitch application occurs when the virtual axis is tilted significantly to the rear, the rotor thrust will be applied forward of the CG momentarily and cause the aircraft to pitch up.

Smooth control inputs, as well as transitioning into ground effect to compensate for the loss of translational lift, will minimize the magnitude of pendulum effect. During termination of the approach once in ground effect, a nearly continuous decrease of collective pitch will be necessary to maintain the approach path to the surface due to the increased efficiency of the rotor system very near the ground.

1107. POWER REQUIRED EXCEEDS POWER AVAILABLE

This condition is presented in this chapter since it is most commonly encountered during an approach while attempting to arrest a rate of descent. However, it can also be encountered on takeoff and during flight. The name of this state defines itself. Some texts will refer to this condition as “settling with power” but it is recommended to **not** use that term as it causes confusion with some pilots and is also sometimes used to discuss vortex ring state (discussed in Section 1108). As previously discussed in Chapter 8, when **power required exceeds power available** under the ambient conditions, an uncommanded rate of descent will result. The uncommanded descent can be associated with maximum torque and/or rotor rpm droop, as well as a possible decrease in tail rotor effectiveness.

Factors which can cause or aggravate this situation include:

1. High G loading.
2. High gross weight.
3. Rapid maneuvering.
4. Engine spool up time from low to high power settings.
5. Loss of wind effect.
6. Change of wind direction.
7. Loss of ground effect.

While lowering the collective will regain rotor rpm, it will initially reduce lift and increase rate of descent. Power required exceeding power available becomes especially dangerous when operating in close proximity to obstructions where the pilot may not have enough altitude or maneuvering space to recover prior to impacting an obstacle.

Should the indications of an uncommanded descent associated with maximum torque, rotor rpm droop, and/or decrease in tail rotor effectiveness occur, comply with NATOPS procedures for “power required exceeds power available.”

Pilots can easily avoid this situation through proper preflight planning and using sound judgment when considering entry into a high power required flight regime.

1108. CASE STUDY – POWER REQUIRED EXCEEDS POWER AVAILABLE

A flight of two CH-53D's was performing troop insertions to a black lava field under high DA conditions. The LZ was devoid of visual cues which normally aid in judging rate of closure and wind direction. Their point of origin was a tower-controlled field a short distance away. Upon lifting from the point of origin, tower reported winds 300/10G15. Upon arrival at the LZ, the Forward Air Controller (FAC) reported wind from 270. The flight landed in the LZ on course of 270, disembarked troops and departed for the second pickup.

Once the second wave of troops was loaded and power checks completed, the flight called for departure, and tower reported winds 330/8G12. On final approach to the LZ, the flight assumed a loose cruise formation and set up for a normal approach on a course of 270, with wind actually 60 degrees to the right, from 330. The PAC for Dash 2 reduced power to establish a glideslope on final approach, and noticed little difference between his current approach and the previous one. On short final, the PAC adjusted course to the left to avoid ground support vehicles located along their approach path and allowed the helicopter to slow to between 30 and 40 KIAS at an altitude of 100 feet AGL.

The combined effect of low airspeed and a leftward slide away from the wind line effectively eliminated translational lift. The cumulative effects of high DA conditions, high gross weight, and loss of effective translational lift placed Dash 2 in a situation where power required exceeded power available. The rate of descent initiated by the PAC further exacerbated the situation, causing the helicopter to descend uncontrollably. When the PIC realized the severity of the situation, the helicopter was in a near-vertical descent. He pushed both speed control levers full forward in attempt to increase power, then assumed control of the aircraft. The PIC noticed that the collective was already at its upper limits, so he pushed the nose forward and lowered the collective slightly to attempt a waveoff. Dash 2 impacted the lava field short of the LZ with very little forward airspeed and a high rate of descent. The tail pylon and left main landing gear separated from the aircraft. The nose gear collapsed and the left auxiliary fuel tank was torn from the sponson. With the removal of the tail pylon, the helicopter lifted ten feet off the ground and pivoted counterclockwise; it then impacted the ground for a second time and rolled onto its side.

Lessons learned from this case study:

1. High DA has an adverse effect on power available and HOGE power.
2. Loss of effective translational lift can cause power required to exceed power available.

1109. VORTEX RING STATE (VRS)

VRS is an uncontrolled rate of descent caused by the helicopter rotor encountering disturbed air as it settles into its own downwash. In this condition, even though the aircraft may have plenty of engine power, the aircraft continues to descend rapidly. This condition may occur in powered descending flight at low airspeeds while OGE. VRS is also called “power settling” in the Naval Aviation community, and “settling with power” in US Army and FAA publications. The more specific and unambiguous term is VRS and precludes unnecessary confusion of terms.

Figure 11-3 shows the normal induced flow velocities along the blade span during hovering flight. Downward velocity is highest at the blade tip where blade speed is highest. As blade speed decreases nearer the center of the disk, downward velocity is less.

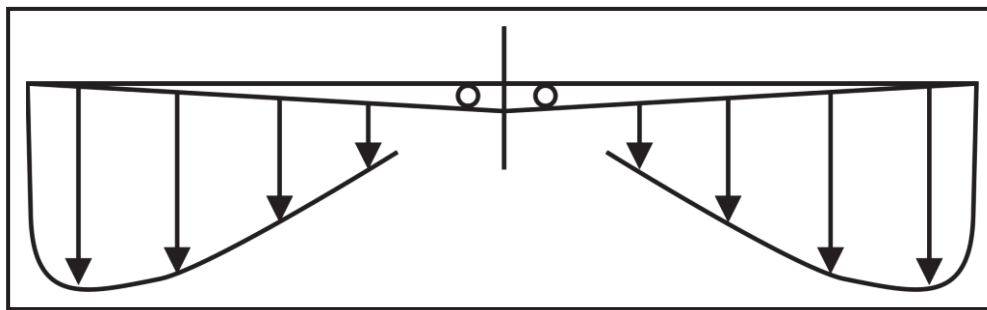

Figure 11-3 Induced Flow Velocity During Hovering Flight

Under certain conditions, the helicopter may descend at a high rate, which exceeds the normal downward-induced flow rate of the inner blade sections (inner section of the rotor disc).

Therefore, the airflow of the inner blade sections is upward, relative to the disk (Figure 11-4). This produces a secondary vortex ring in addition to the normal tip vortex system. The secondary vortex ring is generated about the point on the blade where airflow changes from down to up.

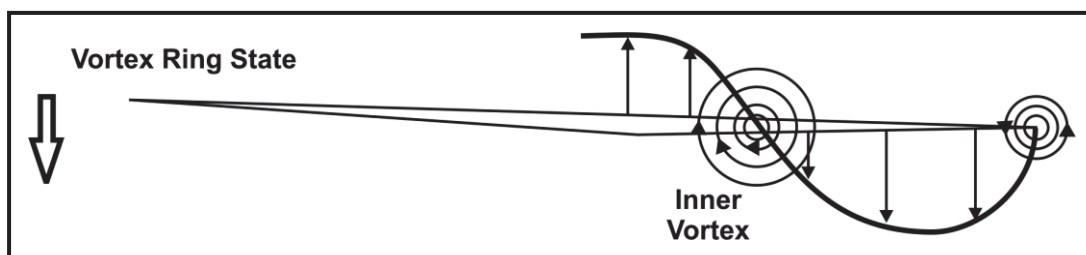

Figure 11-4 Vortex Ring State (VRS)

Those areas impacted by the vortices do not produce appreciable lift and encounter unsteady air. The loss of lift area and turbulent flow produce a deficit of overall thrust and excessive thrust fluctuations, even though power is still being supplied from the engine. Energy provided by the

engine may be considered to be wasted upon accelerating the vortices in circular paths, without accelerating flow downward to generate thrust. Pilots are warned to avoid situations that create this condition (i.e., steep approaches at high rates of descent).

Figure 11-5 shows the induced airflow velocity pattern along the blade span during a descent conducive to vortex ring state. The descent is so rapid that induced flow at the inner portion of the blades is upward rather than downward. The upflow caused by the descent has overcome the downflow produced by blade rotation and pitch angle.

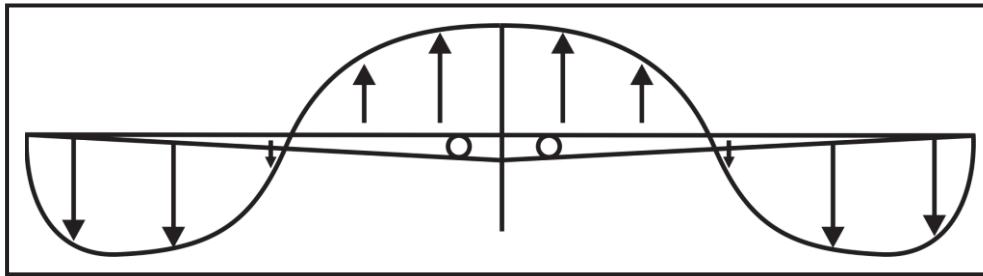

Figure 11-5 Induced Flow Velocity Before VRS

If this rate of descent exists, with insufficient power to slow or stop the descent, it will enter the VRS (Figure 11-6).

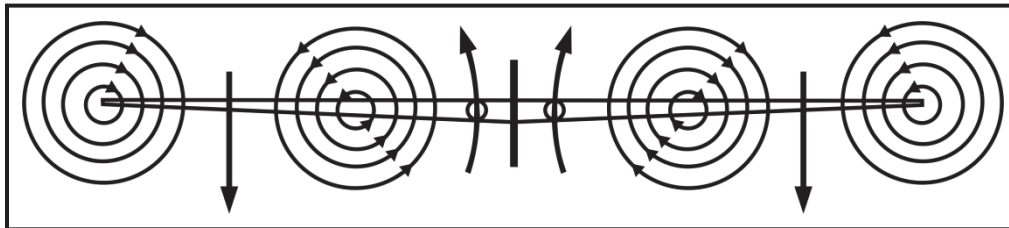

Figure 11-6 VRS

During this VRS, roughness and loss of control occur because of the turbulent rotational flow on the blades and the unsteady shifting of the flow along the blade span. When descent rates are between 70% and 125% of induced velocity, helicopters exhibit large variations in thrust, increased vibration, and a tendency to accelerate the descent. The unsteadiness of the flow has been seen during wind-tunnel tests of model rotors using smoke for flow visualization.

Figure 11-7 shows a sequence of events based upon interpretation of the smoke patterns. According to this model, the rotor is continually pumping air into a big bubble under the rotor. This bubble fills up and bursts every second or two, causing large-scale disturbances in the surrounding flow field. The bubble appears to erupt from one side and then another, causing the rotor thrust to vary and the rotor to flap erratically in pitch and roll, requiring prompt reaction. This is what causes the loss of control effectiveness. Recovery includes lowering the collective and forward cyclic to fly out of the condition. **Increasing the collective only serves to aggravate the situation.**

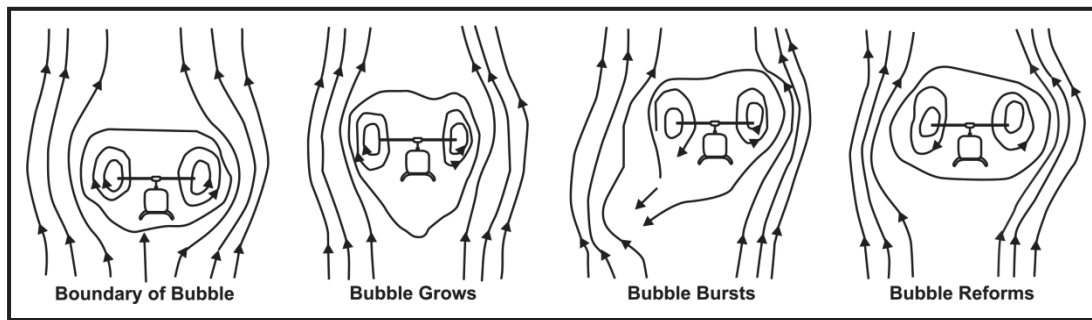

Figure 11-7 Vortex Ring State

Based on wind tunnel and flight tests, flight in the VRS begins at $1/4$ -induced velocity, peaks at $3/4$ induced velocity, and disappears at $1 1/4$ times the induced velocity. Depending on their disk loading (DL), various helicopters enter this phenomenon at a descent rate of 300 - 600 feet per minute and must exceed 1500 - 3000 feet per minute to get clear of it. Staying in this state for any length of time depends on maintaining a nearly vertical flight path. There is some evidence a glideslope of about 70° is worse than a true 90° descent. Approaches with glide slopes less than about 50° with forward speeds between 15 and 30 knots will introduce enough fresh air into the rotor system to blow the tip vortices away from the rotor and free it from the clutches of VRS. **The TH-57 should avoid descent rates greater than 800 ft/min, less than 40 KIAS, and descent angles greater than 45 degrees.**

Figure 11-8 shows the power and pitch settings required to maintain constant rotor thrust in vertical descent for a typical helicopter. Notice the increase in rate of descent with collective increase during VRS conditions.

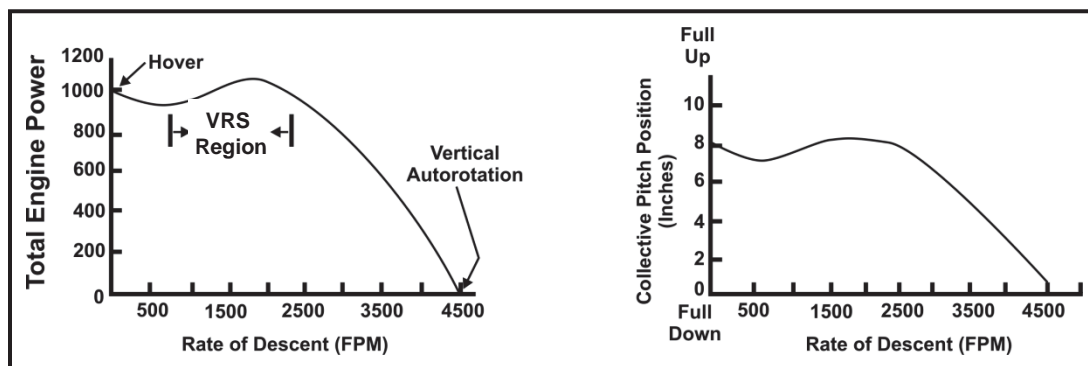

Figure 11-8 Power and Pitch to Maintain Constant Thrust

After a helicopter is descending fast enough to pass through the worst of the unsteadiness in VRS, it will achieve vertical autorotation. Usually there is still a little induced downflow through portions of the rotor disk, but most of the flow will be upwards. This mixed-flow condition technically qualifies the rotor to be in the VRS, but the difference in collective setting differentiates the states. Entering unpowered descent and flight will get one out of VRS, but due to the usual proximity to the ground, combined with the high rate of descent associated with this

11-8 DESCENDING FLIGHT

phenomenon, catastrophic results are likely. The hazards of operation in the VRS were first discovered in main rotor systems, but tail rotors may encounter VRS in conditions such as right hovering turns and left sideward flight (for helicopters with main rotors which turn counterclockwise when viewed from above). Not all helicopters experience these troubles, but for those which are susceptible, a common symptom is a sudden increase in rate of turn. This is discussed in greater detail in Chapter 12.

VRS parameters with forward velocity considered. The descriptions of flow states offered above were simplified by considering only purely vertical flight with no forward airspeed. In descents with forward airspeed, similar states exist, but the rates of descent at which they occur and the symptoms of their existence to the pilot are different. In the case of VRS, it is worthwhile to identify the exact conditions under which it occurs so that pilots can avoid it. To do so, vertical descent rate and horizontal speed are plotted on a VRS diagram (Figure 11-9). In the figure, straight lines emanating from the origin represent lines of constant descent angle. Any two of the variables on the chart (vertical speed, horizontal speed, or descent angle) can be used to determine the third one. Velocities are multiples of the rotor's induced velocity, i.e.

$$1.25V_i = 1.25 \left(v_i = \sqrt{\frac{Thrust}{2\rho A_{disk}}} \right) \text{ and } V_i/101.4 \text{ is a conversion from feet/sec to knots.}$$

Superimposed on this grid are parameters for VRS occurrence, plotted as a region with dimensions that have been determined through theory and flight studies. Parameters for horizontal and vertical speeds are shown as multiples of induced velocity, so the figure is generic and may be used for any rotorcraft at any weight and DA.

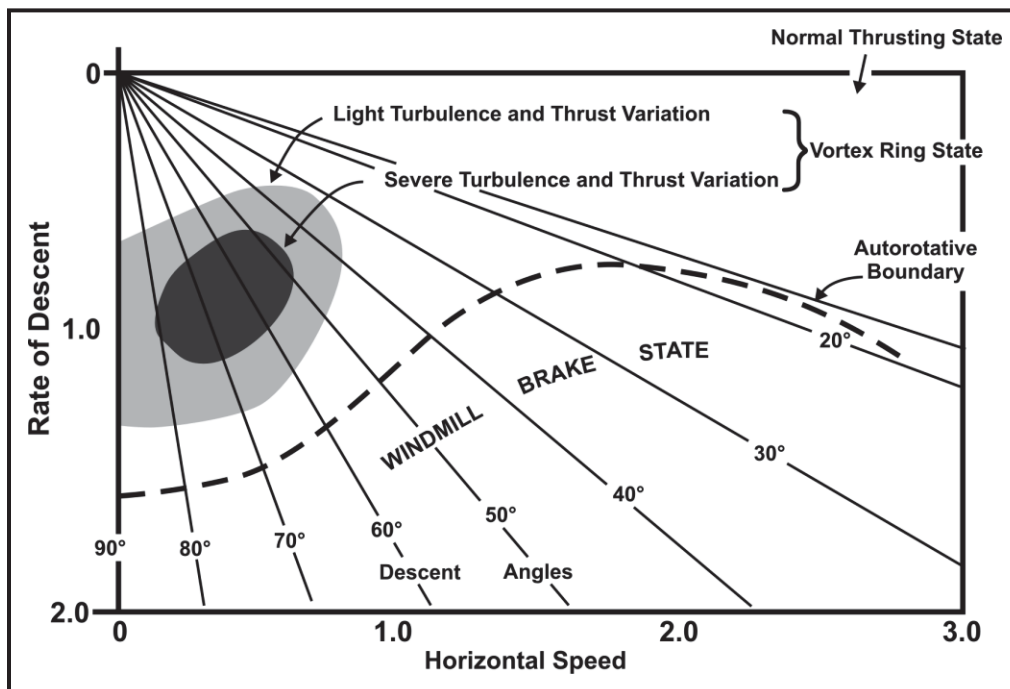

Figure 11-9 VRS Diagram

Recognizing and Reacting to VRS. The best way to deal with VRS is to avoid it. Failing that, a pilot can react to telltale symptoms with actions that directly counteract the causes. The keys are avoidance, recognition, and proper reaction. Using Figure 11-9 and what is known about how VRS develops, several strategies for avoiding the condition can be determined. Avoiding descent angles greater than 30° will allow operations that are completely free of VRS effects. This is not as difficult as it may seem when one considers that a typical autorotative descent occurs at about a 17-20 degree descent angle. The mechanism of VRS can only occur when contact with the tip vortices is maintained at a range of descent rates, forward speed is insufficient to outrun the vortices, and power is applied to generate vortices.

A more focused generic VRS chart is offered in Figure 11-10 and a TH-57 chart in Figure 11-11. Before using the chart to check out an individual aircraft's VRS parameters, remember that it is based upon a specific induced velocity, which depends upon weight and DA. If either of those factors is significantly different than the baseline values, the generic chart should be used.

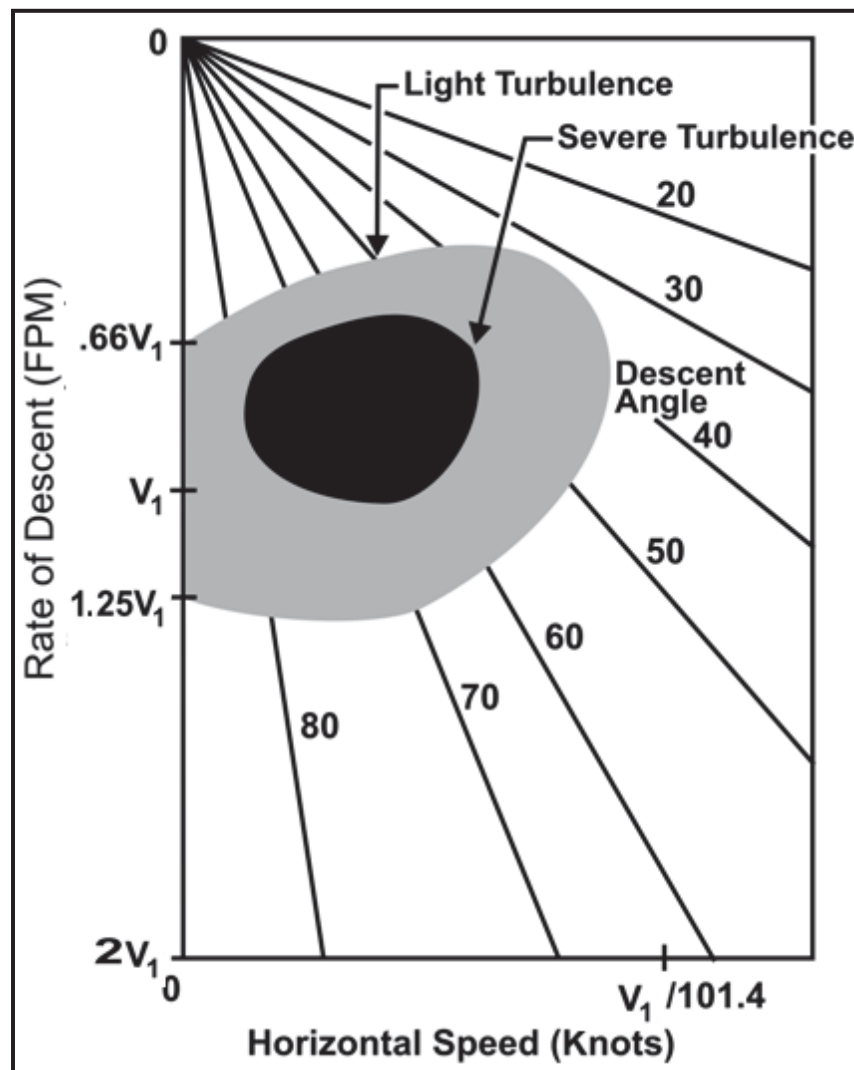

Figure 11-10 Generic VRS Diagram

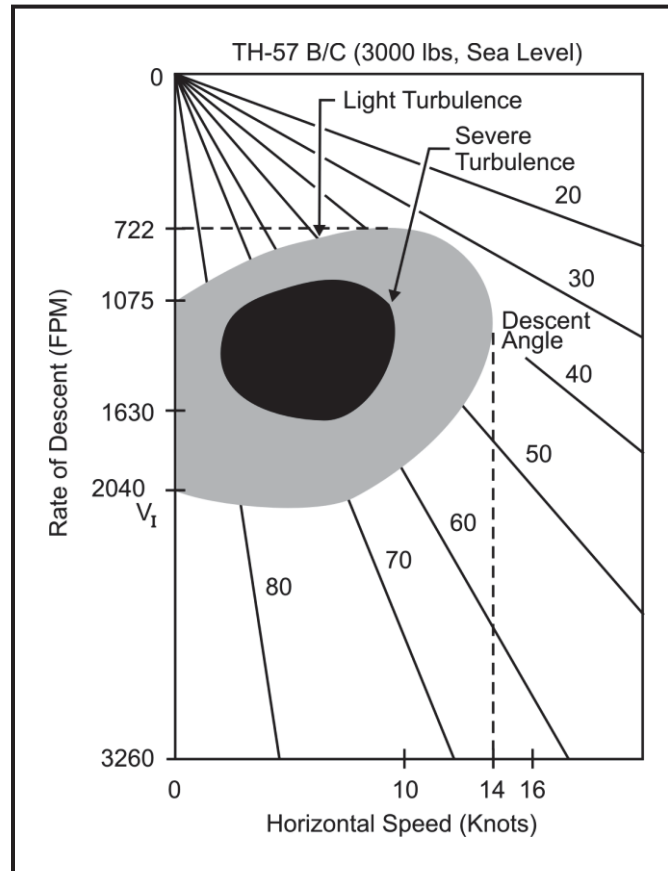

Figure 11-11 TH-57 B/C (3000 lbs, SEA LEVEL)

The typical NATOPS envelope, which was developed based upon a Vietnam-era Huey, provides a good yardstick. It specifies **less than 40 knots airspeed and greater than 800 feet per minute as the regime to avoid**. More generically, we can specify the following:

VRS Entry Conditions.

1. Descent with some power (to generate induced flow)
2. Descent rate of 0.7-1.25 induced velocity (to descend with the vortices)
3. Low Airspeed (to avoid outrunning the vortices)

The following flight conditions are conducive to vortex ring state:

1. Steep approach at a high rate of descent.
2. Downwind approach.
3. Formation flight approach (where vortex ring state could be caused by the turbulence of preceding aircraft).

4. Hovering above the maximum hover ceiling.
5. Not maintaining constant altitude control during an OGE hover.
6. During mask/unmask operations.

Recognizing VRS involves identifying the results of the condition. Because VRS is an unsteady state that occurs unevenly across a rotor, particularly in slow forward flight, uneven aerodynamic forces will be generated on the rotor. Those uneven forces will be felt by a pilot as turbulence or vibrations. An extreme descent rate develops because of lost lift. Use of collective to counter the lost lift may help in mild cases, but often is ineffective because increased AOA on the rotor blades only makes the vortices stronger.

Indications

1. Turbulence and vibrations
2. Loss of control effectiveness (rotor is in a zero or low net thrust condition). Collective response is ineffective and increasing collective can serve to speed up the recirculation of airflow through the rotor system and increase the rate of descent.
3. Extreme descent rates

Recovery is a matter of escaping the recirculating air. Motion can be vertical (lowering collective for descent below vortices), forward (lowering the nose to gain airspeed and outrun the vortices) or lateral (moving to the side using cyclic displacement). Increasing airspeed is preferred because it involves less loss of altitude. Tandem-rotor helicopters may have some success with a lateral displacement. Entering an autorotation is effective in the rare case where altitude permits, because it involves lowering collective, gaining airspeed, and descending below vortices. Tilt-rotor aircraft have the option of tilting lift nacelles to escape the vortices.

Recovery from VRS may be affected in one or a combination of the following ways:

1. During the initial stage (and if a large amount of excess power is available), a large application of collective pitch may arrest the rapid descent; if this is done carelessly or too late, however, this collective increase can aggravate the situation, resulting in more turbulence and an increased rate of descent. The TH-57 NATOPS contains the following warning: **Increasing collective has no effect toward recovery and will aggravate vortex ring state.**
2. In single-rotor helicopters, the aviator can accomplish recovery by applying forward cyclic to increase airspeed and arrest the upward induced flow of air and/or by lowering the collective (altitude permitting). Normally, gaining airspeed is the preferred method because less altitude is lost.
3. In tandem-rotor helicopters, fore and aft cyclic inputs may prolong the situation due to the length of the twin rotor disk area. By lowering thrust (altitude permitting) and/or applying lateral cyclic or pedal input to move sideways out of the downwash quicker, the aviator can accomplish

recovery.

Continuing to lower the collective to minimum pitch transitions the helicopter from VRS to vertical autorotation state. A majority of the flow will be upwards through the rotor system, but due to the presence of induced down flow, one may still classify it as being in VRS (Figure 11-12).

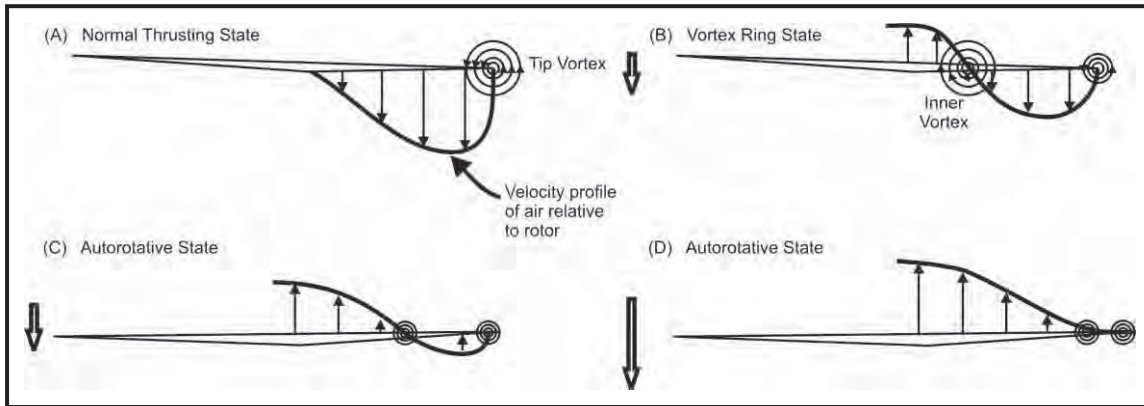

Figure 11-12 Flow States

There are differences, though. The lift vector becomes tilted forward (Figure 11-13), providing enough power to drive the tail rotor and gearboxes without the engine. Drag of the blades is also overcome.

Momentum theory is invalid for rates of descent encountered in vortex ring state, however, as seen in Figure 11-14, autorotation is near the edge of the shaded area.

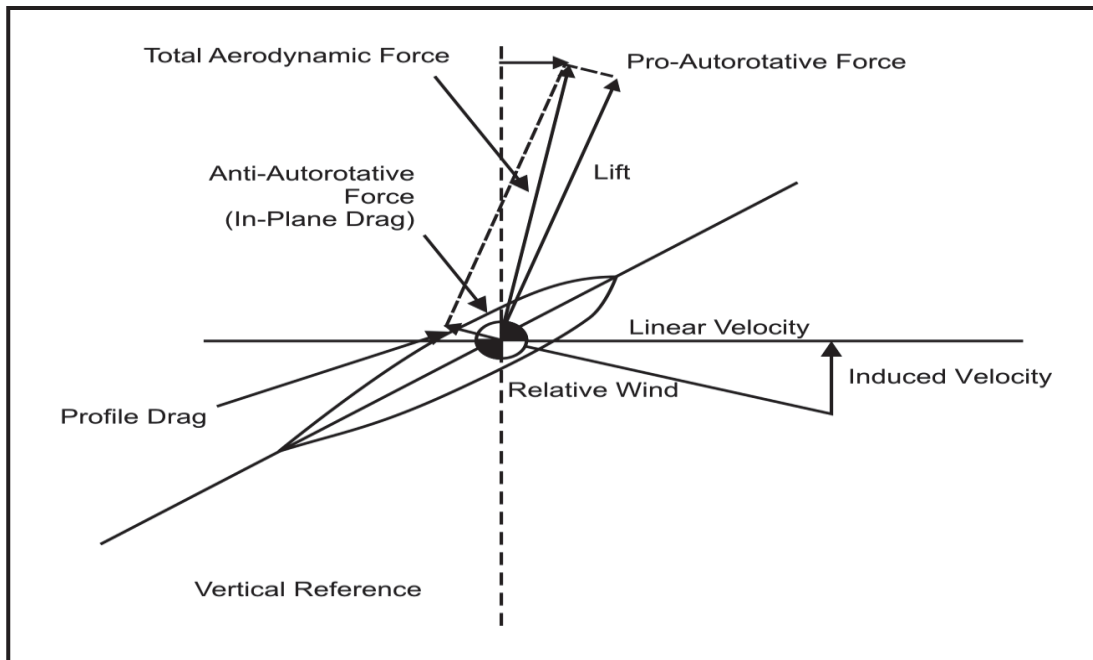

Figure 11-13 Blade Element in Autorotation

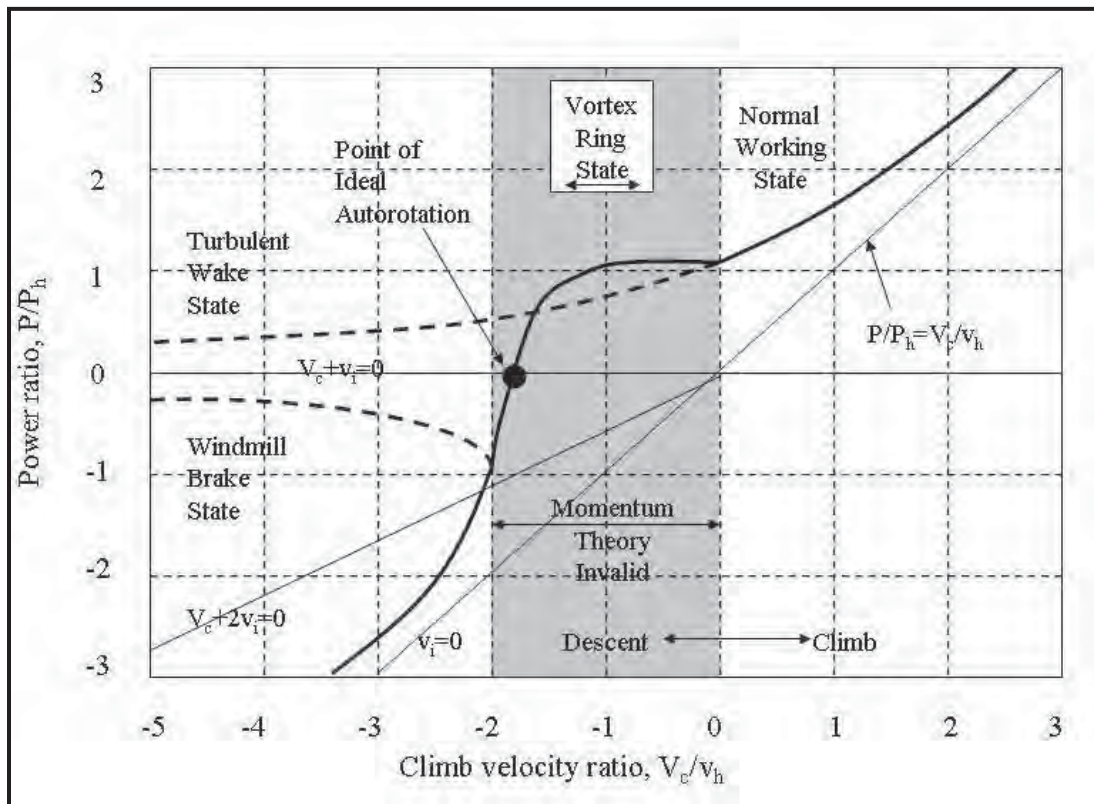

Figure 11-14 Power Ratios in Climb and Descent

1110. CASE STUDY – VORTEX RING STATE

The squadron was tasked to conduct naval gunfire support as the spotter for the ship's 5-inch gun. Most spotters have the luxury of being on a fixed platform from which the fields of fire are clear and unobstructed. In this setup, the aircrew needed to figure out a way to maintain eyes-on for the entire duration of the exercise. Flying the classical dog-bone pattern would have rendered them blind for a few seconds on each pass, so the crew decided against it. Instead they opted to put the helicopter in a 300-foot hover near a reference cliff, which afforded constant eyes-on. In making this decision they accepted two known risks: single engine failure at zero airspeed and vortex ring state. Their performance planning revealed that 300 feet was sufficient to recover single engine airspeed in case of an engine failure. They thoroughly reviewed and briefed this emergency and felt comfortable that the risk was mitigated with the extra altitude. Vortex ring state was briefed as a possibility at greater than 800 fpm and less than 40 kts; it was, however, considered by the aircrew very unlikely to occur. Their orientation was such that the PAC was in the right seat, giving him clear visibility to the range. The non-flying pilot (NFP) was in the left seat and ensured clearance from the cliffs. During the course of fire the PAC inadvertently gained a few hundred feet of altitude. He decided to give the flight controls to the left seat so he could continue spotting effectively for the ship. As the left seat accepted the flight controls and began correcting back to 300 feet the helicopter began to shake and was oscillating in pitch. A

descent began to build as the pilots reasoned that they may have gotten into VRS. The PAC properly applied forward cyclic and reduced collective to get out of the disturbed air, and recovered the helicopter low over the water.

Lessons:

1. VRS avoidance is the best option.
2. Proper preflight planning is mandatory for avoidance.

1111. AUTOROTATION

Autorotation is the stable descent of the helicopter with the main rotor driven only by its aerodynamic forces. Momentum theory does not provide the best estimate of balance of power in autorotation, compared to blade element theory. Still, the reversal of the induced velocity adds power to balance the profile power losses in the rotor, as indicated below:

$$P = T(v_i) + P_0 = 0$$

where $T(v_i)$ is the induced power and P_0 is the profile power. Since the induced velocity is reversed, v_i would have a negative sign and the total power is zero.

Compared to the VRS, vertical autorotation state is a stable condition where collective pitch settings will vary the rate of descent and rotor speed. Higher rotor speeds are attained with lower pitch settings, lower rotor speeds with higher settings. This leads to the next logical assumption, a desired range of rotor speed must exist. An excessively high rotor speed produces overstressful centrifugal loads on hubs and blade roots, which can in turn overstress the tail rotor. Rotor blades will stall at a very low rotor speed. Although 75-110 percent of normal rotor speed is generally safe, operating limits for the TH-57 are 90-107%. In this range, rate of descent is approximately twice the hover induced velocity. This rate of descent is comparable to a helicopter descending under a parachute.

Autorotation, however, does not usually occur after entering VRS. It usually follows an engine failure if the pilot initiates corrective action in a timely manner. This action centers on meticulous energy management focusing on rotor rpm and forward airspeed.

Autorotative State. Beyond the VRS, things settle down again as the rotor descends faster than the induced vortices. At rates of descent between 125% and 180% of induced velocity, the rotor enters autorotation and no power is required to maintain rpm. During autorotation, a large portion of the flow through the rotor is upward (Figure 11-15), but that upward flow is used to power the rotor. The rotor blades produce enough thrust to establish equilibrium flight at reasonable rates of descent that can be controlled for landing. Potential energy changes associated with the descent are converted to kinetic energy in the rotor head at a rate just sufficient to provide the power requirement for sustained, controllable descent. The autorotative flow state is the boundary between conditions where power must be delivered to the rotor to prevent rpm decrease and where power must be extracted from the rotor to prevent speed increase.

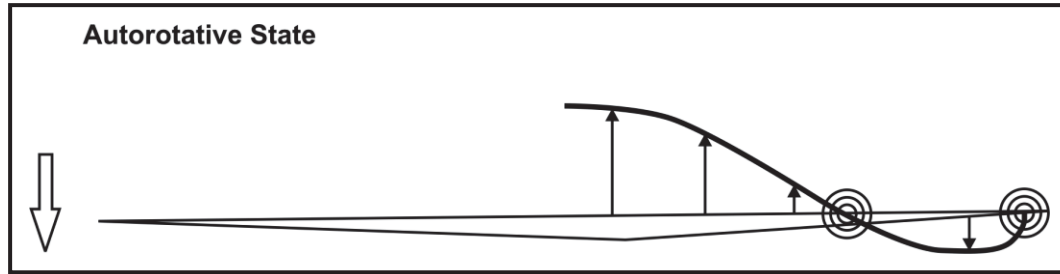

Figure 11-15 Autorotative State

Aerodynamics of Vertical Autorotation. During powered flight, rotor drag is overcome with engine power. When the engine fails or is deliberately disengaged from the rotor system, some other force must sustain rotor rpm so that controlled flight can be continued to the ground. This energy comes from the rate of decrease in potential energy as the helicopter loses altitude. Airflow during a high rate of descent provides the energy to overcome blade drag and to turn the rotor. When the helicopter descends in this manner, it is in a state of autorotation. In effect, the aviator exchanges altitude at a controlled rate in return for energy to turn the rotor at an rpm that provides aircraft control and a safe landing. The helicopter has potential energy based on its altitude above the ground. As this altitude decreases, potential energy is converted into kinetic energy used in turning the rotor. The aviator uses this kinetic energy to slow the rate of descent at a controlled rate and affect a smooth touchdown.

The rotor will initially slow down, feeding on its own energy (inertia) due to the power loss. Lowering the collective with little or no delay will stop this decay. If N_r is allowed to decay too much, the rotor will stall, allowing the helicopter to assume flying qualities of a brick. The increasing upflow of air through the rotor system effectively reverses the airflow, tilts the lift vector forward, and increases thrust, which can now be managed by the pilot through small pitch changes through the collective by controlling N_r (in-plane drag).

Most autorotations are performed with forward airspeed. For simplicity, the following aerodynamic explanation is based on a vertical autorotative descent (no forward airspeed) in still air. Under these conditions, forces that cause the blades to turn are similar for all blades regardless of their position in the plane of rotation. Therefore, dissymmetry of lift resulting from helicopter airspeed is not a factor. During a vertical autorotation, the rotor disk is divided into three regions: driven, driving, and stall (Figure 11-16).

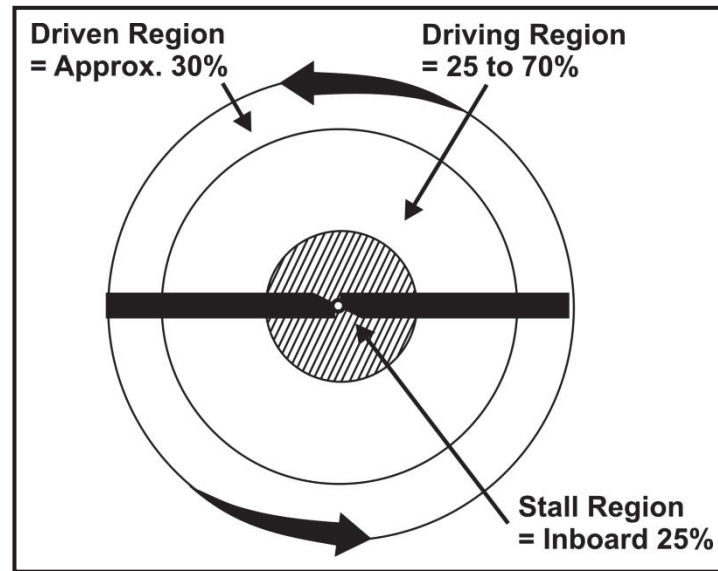

Figure 11-16 Blade Regions in Vertical Autorotation Descent

Figure 11-17 also illustrates the three regions. Additional information in the figure pertains to force vectors on those regions and two additional points that are points of equilibrium. This figure serves to locate those regions/points on the blade span and depict the interplay of force vectors. Force vectors are different in each region because rotational relative wind is slower near the blade root and increases continually toward the blade tip. In addition, blade twist gives a more positive AOA in the driving region than in the driven region. The combination of the inflow up through the rotor with rotational relative wind produces different combinations of aerodynamic force at every point along the blade.

1. Driven Region

This region (Figure 11-17, A) is also called the **propeller, prop or anti-autorotative region** and is nearest the blade tip. It normally consists of about 30% of the disk radius. It produces lift, but it also opposes rotation and continually tends to decelerate the blade. In the driven region, the total aerodynamic force acts behind the axis of rotation, resulting in anti-autorotative forces exceeding pro-autorotative forces, which tends to slow the rotation of the blade. The size of the region varies with the blade pitch setting, rate of descent, and rotor rpm. When changing any of these factors, the aviator also changes the size of the driven region and the size of the other regions along the blade span.

2. Points of Equilibrium

There are two points of equilibrium on the blade between the driven and driving regions (point B) and between the driving and stall regions (point D). At these points, total aerodynamic force is aligned with the axis of rotation and lift and drag are produced, but overall there is neither acceleration nor deceleration force developed.

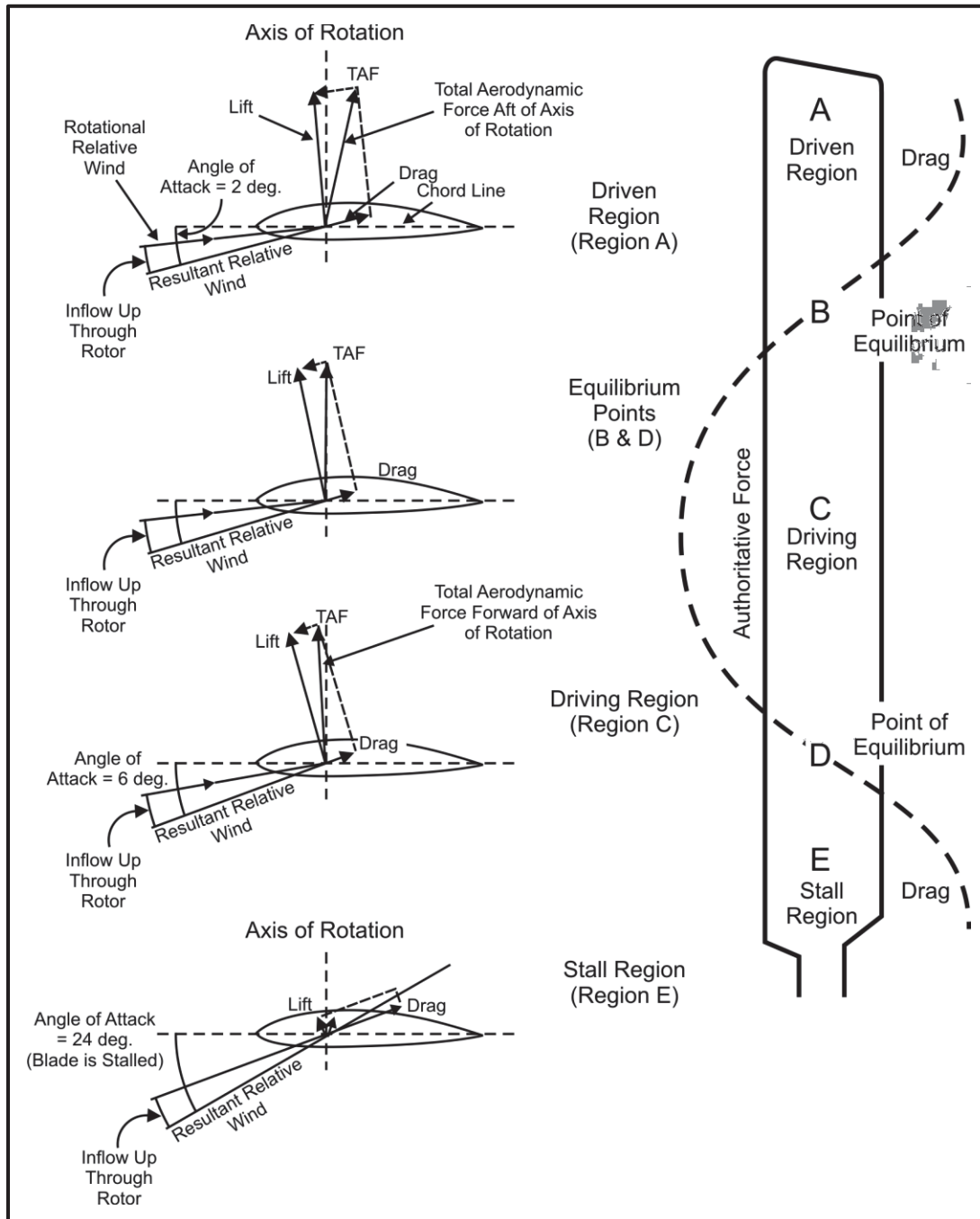

Figure 11-17 Force Vectors in Vertical Autorotative Descent

3. Driving Region

This region (Figure 11-17, C), also called the **autorotative or pro-autorotative region**, extends from about the 25 – 70 percent radius. It lies between the driven and stall regions. It is

11-18 DESCENDING FLIGHT

identified as the area of autorotative force because it is the region of the blade that produces the force necessary to turn the blades during autorotation. Total aerodynamic force in the driving region is inclined slightly forward of the axis of rotation and produces a continual acceleration force with pro-autorotative forces exceeding anti-autorotative forces. This direction of force supplies thrust, which tends to accelerate the rotation of the blade. The size of the region varies with the blade pitch setting, rate of descent, and rotor rpm. When changing any of these factors, the aviator also changes the size of the driving region and, of course, the size of the other regions on the blade span.

4. Stall Region

This region (Figure 11-17, E) includes the inboard 25% of the blade radius. It operates above the stall AOA and causes drag, which tends to slow the rotation of the blade.

The aviator manipulates these regions to control all aspects of the autorotative descent by adjusting the collective pitch. For example, if the collective pitch is increased, the pitch angle increases in all regions. This causes point of equilibrium B to move inboard and point of equilibrium D to move outboard along the blade span, thus increasing the size of the driven and stall regions while reducing the driving region. Reducing the size of the driving region decreases the acceleration force and, of course, rotor rpm. The aviator can achieve a constant rotor rpm by adjusting the collective pitch so that blade acceleration forces from the driving region are balanced with the deceleration forces from the driven and stall regions. An easy way to remember this is more pitch angle means more drag and therefore less rpm, while less pitch means less drag and therefore more rpm, if everything else remains constant.

1112. AERODYNAMICS OF AUTOROTATION IN FORWARD FLIGHT

Autorotation in forward flight is still an equilibrium state of descent in which upward airflow powers the rotor while lift balances weight enough to prevent downward acceleration. The actual equilibrium state established depends upon characteristics of the aircraft, entry procedures, and variables set during the descent. These factors will determine rate of descent and how effective the flare arrests descent rate prior to landing.

Aerodynamic forces in forward flight (Figure 11-18) are produced in exactly the same manner as in vertical autorotation. However, because forward speed changes the inflow of air up through the rotor disk, this changes the location and size of the regions on the retreating and advancing sides of the rotor disk. Because the retreating side experiences an increased AOA, all three regions move outboard along the blade span with the stall region growing larger and an area nearest the hub experiencing a reversed flow due to forward velocity exceeding rotational velocity. Because the advancing side experiences a decreased AOA, the driven region takes up more of that blade span.

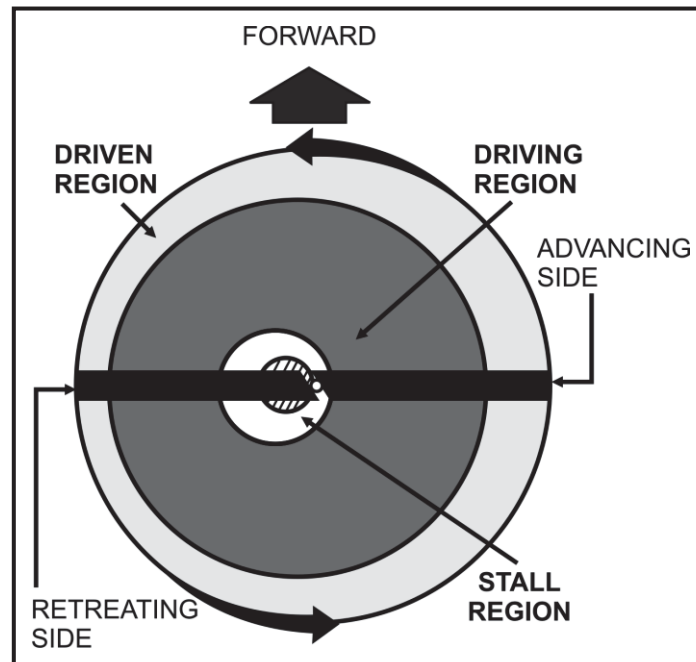

Figure 11-18 Autorotative Regions in Forward Flight

Main Rotor Flow Regions in an Established Autorotation. As stated above, the rotor blade has four flow regions during forward autorotation rather than the three in a vertical autorotation. The four regions, then, as plotted on Figure 11-18 and 11-19, are:

1. Stall region - AOA is greater than AOA for stall due to the low rotational velocity.
2. Autorotative region (driving) – in-plane thrust is higher than in-plane drag, provides lifting and driving forces.
3. Propeller region (driven) / dragging region – in-plane drag is higher than in-plane thrust, producing lift with high drag.
4. Reverse flow region (forward flight) - region that exists in forward flight autorotations due to forward speed overtaking rotational velocity.

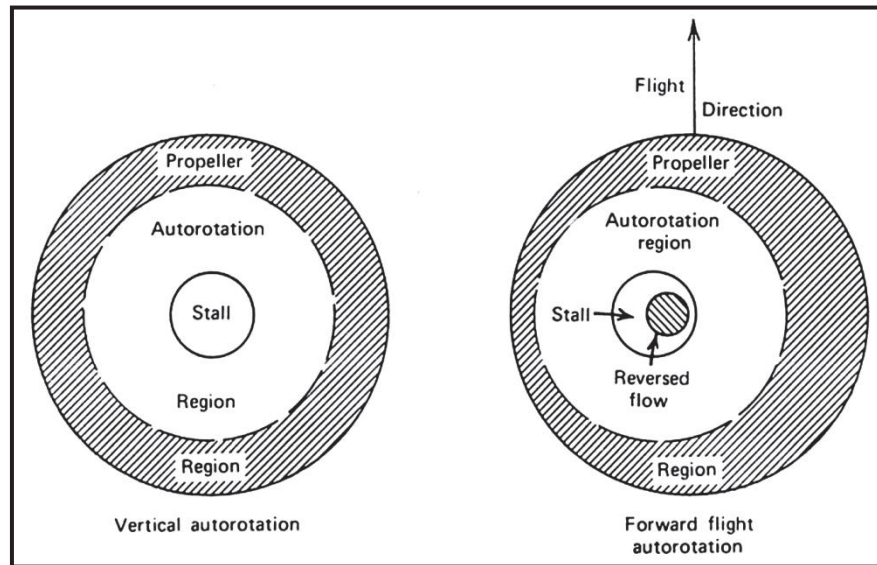

Figure 11-19 Rotor System Flow Regions

1113. AUTOROTATION DESCENT VARIABLES

Performance in the descent depends upon the forces acting upon the rotor. Airspeed affects the aerodynamic force on all blades and total power required for flight. Most autorotations are flown at a 13-17 degree glide angle which offers the lowest descent rate in autorotation. It is worth noting that very low speed autorotations, while possible, have very high associated descent rates. Aircraft trim and gross weight also affect power required, so they also affect performance. As an aircraft moves further out of trim the parasite drag increases, power required increases, and hence descent rate increases. Gross weight determines rpm at a given collective pitch. At high gross weight, more blade pitch is required to maintain a desired rpm, so higher gross weights result in a slower rate of descent, assuming all other variables remain the same. Rpm also varies in descent with altitude (both PA and DA). Higher DA requires higher blade pitch to maintain a given rpm but, due to the lower air density, a higher rate of descent will still occur. Functional check pilots will notice higher “auto turns” at high DAs.

As will be shown in class, it is interesting to note that the TH-57 B/C NATOPS Autorotational Glide Characteristic Chart states that “Autorotational descent performance is a function of airspeed and is essentially unaffected by density, altitude and gross weight” while at the same time, in the operating limitations section, includes a chart indicating “gross weight restriction for safe landing after engine failure” based on weight and density altitude! The reason for the first comment may be due to the fairly light weight of the TH-57 and small operating weight range. In contrast, the H-53E autorotation chart, for a weight of 40,000 pounds shows a minimum rate of descent of 3,700 FPM at 78 Kts while a 60,000 pound acft shows a minimum rate of descent of 2,450 FPM at 90 Kts IAS (100% NR and sea level/standard day).

The factors affecting autorotative descent performance are:

1. Airspeed
2. Trim
3. Gross Weight
4. DA
5. rpm

Rpm tradeoffs. rpm is adjusted by varying collective. Adjusting rpm in an autorotation definitely affects rate of descent and energy stored in the rotor. Selection of a good autorotation rotor speed depends upon what performance is desired. High rpm stores energy well and but involves a higher descent rate. Low rpm provides a slower descent and longer glide, but provides less stored power for use in the flare. Taken to an extreme, low rpm can stall an excessive portion of the rotor and make recovery extremely difficult. Specific considerations follow:

High rpm

1. Centrifugal loads on hub.
2. Excessive propeller region so higher rate of descent.
3. Rotational energy to trade off in a flare.
4. Good for high inertia systems which would have difficulty building rpm rapidly in a flare.

Low rpm

1. Higher AOA therefore a slower rate of descent.
2. Excessive stall region if rpm gets too low resulting in an increase in rate of descent.
3. Less rotational energy to trade off in a flare.
4. Good for low inertia systems which can build rpm rapidly in a flare.
5. Rotor blades lose centrifugal stiffness and cone upwards which reduces the effective disk area, increases material stresses, and increases the rate of descent.

1114. PHASES OF AUTOROTATION

Autorotations may be divided into three distinct phases: entry, steady-state descent, and

deceleration (flare) and touchdown. Each phase is aerodynamically different from the others.

Level Powered Flight at High Speed. Figure 11-20 shows the airflow and force vectors for a blade in this configuration. The lift and drag vectors are large, and the total aerodynamic force is inclined well to the rear of the axis of rotation. An engine failure in this mode will cause rapid rotor rpm decay. To prevent this, the aviator must lower the collective quickly to reduce drag and incline the total aerodynamic force vector forward, nearer the axis of rotation.

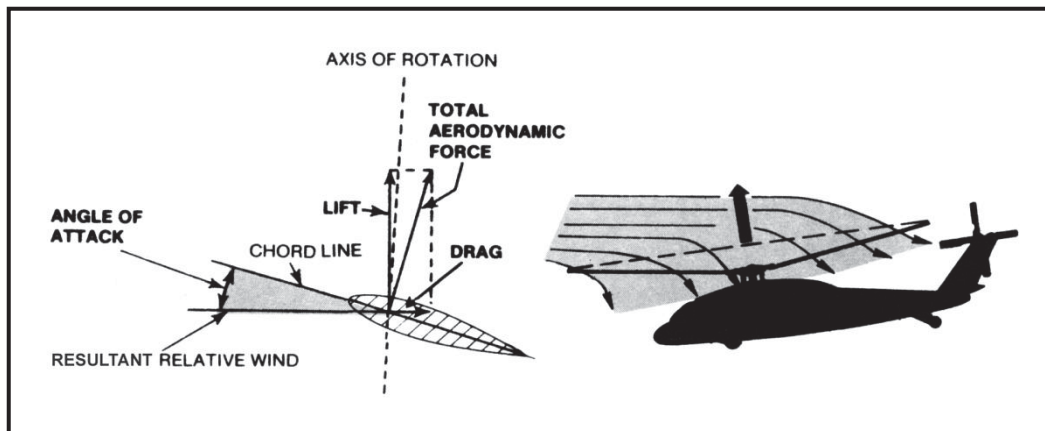

Figure 11-20 Force Vectors in Level-Powered Flight at High Speed

Entry. Entry is a combination of Figures 11-21 and 11-22 below. This phase is entered after loss of engine power. The loss of engine power and rotor rpm is more pronounced when the helicopter is at high gross weight or high forward speed or in high-DA conditions. Any of these conditions demand increased power and a more abrupt reaction to the loss of that power. In most helicopters, it takes only seconds for the rpm decay to fall into a minimum safe range, requiring a quick response from the aviator.

After an engine failure the pilot enters an autorotation by lowering the collective. AOA lessens as airflow begins to move less downward, then shifts to an upward flow. The net result is that lower AOA and less pitch make a smaller aerodynamic force that is not tilted as far aft (Figure 11-21). Vertical force is reduced, so a descent begins, but the associated reduction in drag keeps the rotor from losing too much rpm.

Collective Pitch Reduction. Figure 11-21 shows the airflow and force vectors for a blade immediately after power loss and the subsequent collective reduction, yet before the aircraft has begun to descend. Lift and drag are reduced, with the total aerodynamic force vector inclined further forward than it was in powered flight. As the helicopter begins to descend, the airflow begins to flow upward from under the rotor system. This causes the total aerodynamic force to incline further forward until it reaches an equilibrium that maintains a safe operating rpm (Figure 11-23).

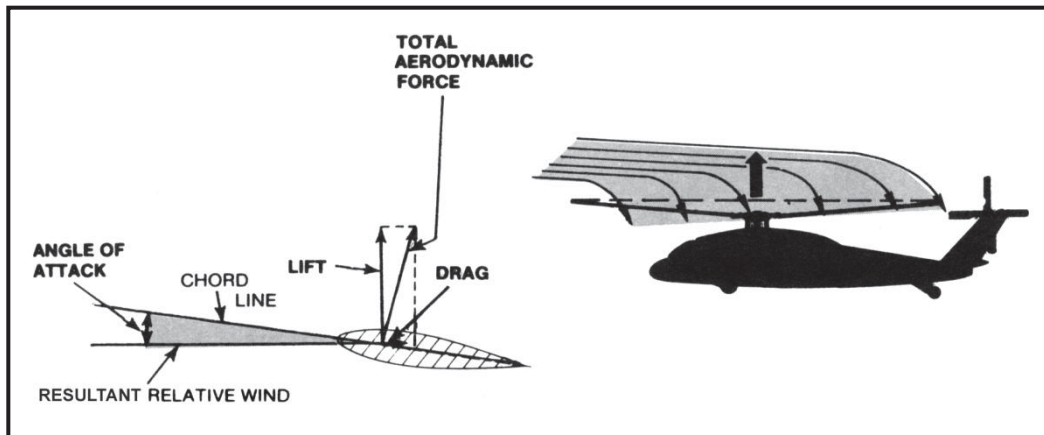

Figure 11-21 Force Vectors After Power Loss – Reduced Collective

Possible aircraft initial reactions will be based upon sudden loss of torque on the main rotor. Thus, the helicopter will yaw left due to a reduction in anti-torque required (before pedals are adjusted), and may roll right due to residual tail rotor force. The primary concern, however, should be with controlling rpm. To make the entry a success, blade pitch must be lowered in a timely manner. The rate of rotor speed decay will determine how quickly the collective must be lowered, and the rate of decay in turn will be determined by rotor inertia and power required. Rotor inertia is a rotor head's resistance to changes in velocity. A high-inertia rotor head will tend to remain at the same rpm longer after a loss of power or in a flare than a low-inertia rotor head. Power required is related to induced power, so it is affected by density and airspeed. In practical terms, this means that the following factors affect successful autorotation entry:

1. Rotor blade pitch (dependent on flight condition - airspeed, gross weight, climb/descent, etc.)
2. Rotor inertia
 - a. High inertia - rpm builds and decays slowly.
 - b. Low inertia - rpm builds and decays rapidly.
3. Pilot reaction time. Figure 11-22 depicts rotor speed decay based on reaction time for high-inertia and low-inertia rotor heads.

4. Entry altitude (time to establish a stabilized autorotation)
5. Entry airspeed

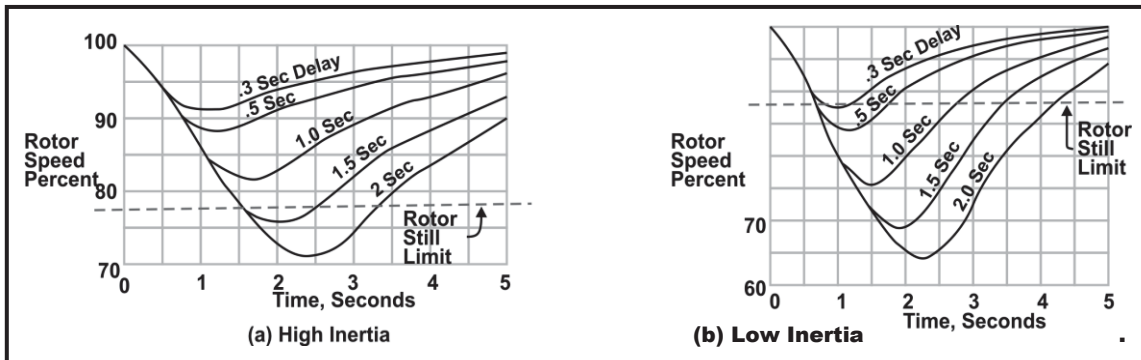

Figure 11-22 Rotor Speed vs. Pilot Reaction Time

Steady-State Descent. Figure 11-23 shows the airflow and force vectors for a blade in a steady-state autorotative descent. Airflow is now upward through the rotor disk because of the descent. This upflow of air creates a larger AOA, although blade pitch angle has not changed since the descent began. Total aerodynamic force on the blade is increased and inclined further forward until equilibrium is established, rate of descent and rotor rpm are stabilized, and the helicopter is descending at a constant angle. Angle of descent is normally 13 - 17 degrees, depending on airspeed, DA, wind, and the type of helicopter.

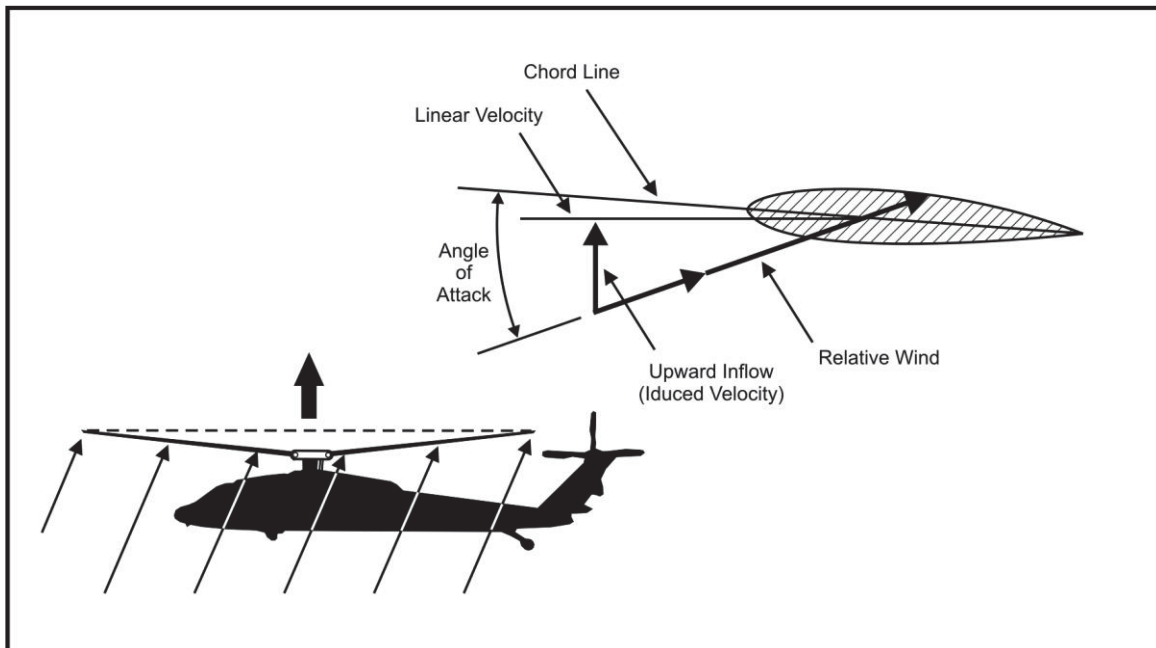
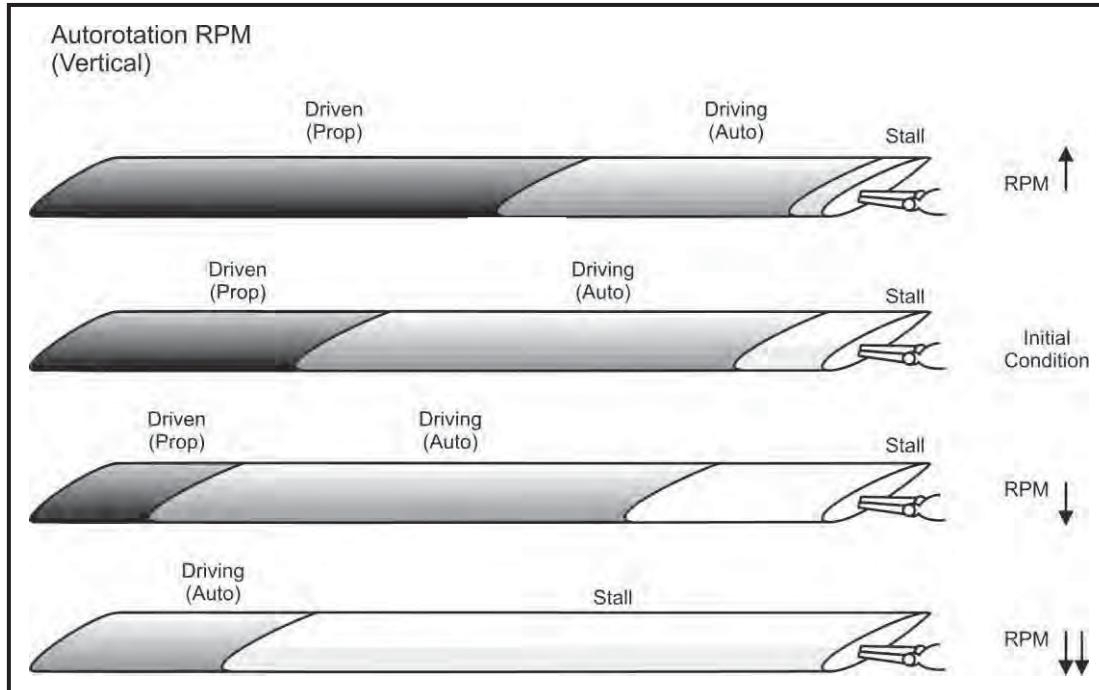

Figure 11-23 Force Vectors in Autorotative Steady-State Descent

When autorotation is established, upflow tilts the relative wind downward, which moves the net aerodynamic force forward. In a stabilized autorotation the component of lift in the horizontal direction balances out the horizontal component of drag so that drag does not reduce the rotor rpm (Figure 11-23).

Rpm Stability. In an autorotation, transient changes in aircraft attitude or wind shifts can change the airflow through the rotor system, therefore affecting rpm. However, the rotor system demonstrates rpm stability in response to small changes. Figure 11-24 graphically describes the blade region variations with rpm changes. In autorotation, the blade is at flat pitch (or near flat pitch), which is designed to maintain a constant rpm at a given descent rate. When an external force (winds/airflow etc., vice a change in collective setting) causes a small transient increase in the rpm, the regions shift inboard, enlarging the driven (prop) region and associated drag, while also reducing the moment arm for the driving (auto) region on the blades. This reduction in the driving region causes the rpm to decrease back towards the original rpm. Just the opposite happens with slight decreases in rpm. Thus, for minor rpm variations, the rotor system has rpm stability.

However, with a large decrease in rpm, even though the driving region of the blade increases, the stall region and drag it produced also increases. The increased moment arm for the driving region may not be sufficient to regain the lost rpm before the aircraft reaches the ground.

**Figure 11-24 Rpm Response to Small rpm Variations**

Since the amount of blade surface producing positive autorotative driving force varies according

to rpm and this driving force is synonymous with thrust produced, it is obvious the pilot has additional control over rate of descent by changing pitch through collective application. Excessively high N_r produces less driving force and a higher rate of descent, and very low N_r leads to low driving force in proportion to high drag associated with a stalled profile. There is an optimum rpm range (94-95 percent for the TH-57), which produces the greatest net driving force and minimum descent rate. It is in the best interest of the pilot to strive for this rpm range until reaching flare altitude. **The pilot must monitor rpm throughout the autorotation to ensure rpm stays within limits.**

Now that steady state autorotation has been achieved, the pilot has the option of stretching his glide to a distant landing zone (LZ) or increasing his loiter time in the air, provided sufficient altitude exists.

Rate of Descent and Glide Distance in Autorotation. Rather than using power required/power available charts for autorotation, many NATOPS manuals contain charts specifically for autorotation (Figure 11-25). Helicopter airspeed is probably the most significant factor that affects rate of descent in autorotation. The rate of descent is high at very low airspeeds, decreases to a minimum at some intermediate speed, and increases again at faster speeds. Minimum rate of descent occurs at the bucket airspeed because this is where the minimum power is required to remain airborne. If there is an available field immediately in front of you, you may use this speed for extra time aloft to ensure crew readiness for landing or make a prudent radio transmission, but there are other factors which enter the ball game as the helicopter approaches the ground.

Just suppose the engine failed and there wasn't a suitable landing site immediately in front of you, but there was one further away. What should one do? Luckily, for pilots in a somewhat stress-inducing situation, the solution is fairly logical and in line with normal reaction-fly at maximum glide range airspeed. Maximum glide distance occurs where the ratio of power required to airspeed is a minimum so that the aircraft will fly the furthest horizontally with the smallest descent rate. A line drawn from the point of origin tangent to the total drag curve illustrates the airspeed for maximum glide distance, much the same as for powered flight. However, for the TH-57, a glide distance curve has been added to the autorotation chart to simplify the process. Again, there are tradeoffs, and in this case, higher speed and distance over the ground reduces time aloft.

The airspeeds for minimum rate of descent and maximum glide distance vary by helicopter type. Individual operator's manuals cover this information.

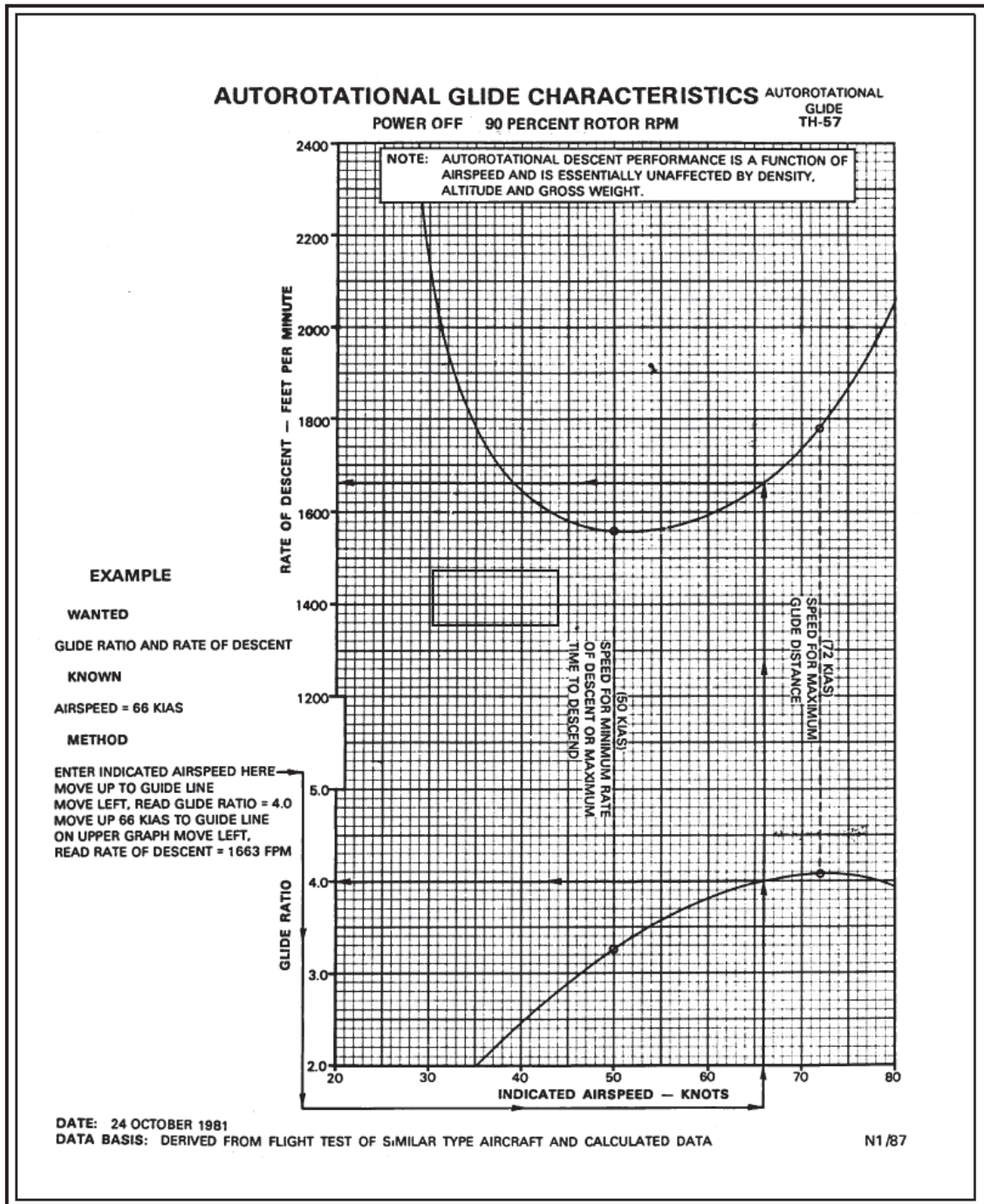

Figure 11-25 Autorotational Rate of Descent Compared to Airspeed

As the ground becomes more in focus, the range of safe airspeed/rotor rpm combinations narrows, and precise management of kinetic energy is necessary. At this point, your new goal is to reduce the kinetic energy along the flight path to zero at the same time ground contact is made, while trading off the stored kinetic energy in rotor rpm for thrust to maintain power requirements for flight before the blades reach a stalled condition.

Deceleration and Touchdown. From either of the two extreme airspeed range examples previously discussed (max glide/min rate of descent), we will assume a suitable LZ is now easily within range. If we were at max glide at a high forward speed and associated high rate of descent, it is only logical we slow down (low rate of descent at ground contact = less pain). How slow? Minimum rate of descent sounds logical. But, even at this airspeed, the helicopter's landing gear cannot absorb the amount of energy the helicopter is carrying at ground contact. Therefore, it may be advantageous to carry five to ten knots extra airspeed over minimum rate of descent airspeed at flare altitude - banking on another tradeoff – extra forward airspeed for high rotor rpm. The fact is, maximum range airspeed is associated with greater rate of steady-state descent, but the greater flare through minimum rate of descent airspeed to maximum decelerative attitude provides a greater decelerative force both horizontally and vertically than a flare started from min rate of descent speed. The challenge, therefore, is timing the deceleration approximately from max range airspeed, which is more difficult than from the standard auto at min rate of descent.

The Last 100 Feet. It can be assumed that autorotation ends at 100 feet (depending on aircraft and speed), and the landing procedure then begins. To execute a power-off landing for rotary-wing aircraft, the aviator exchanges airspeed for lift by decelerating the aircraft during the last 100 feet. When executed correctly, deceleration is applied and timed so that rate of descent and forward airspeed are minimized just before touchdown. At about 15 feet, this energy exchange is essentially complete. The primary remaining control input is application of collective pitch to cushion the touchdown. Because all helicopter types are slightly different, aviator experience in that particular aircraft is the most useful tool for predicting the useful energy exchange available at 100 feet and the appropriate amount of deceleration and collective pitch needed to execute that exchange safely and effectively to land the aircraft successfully.

This may seem like a very large chunk to swallow, but if taken in small bites, the process becomes much easier. Specific procedures for the TH-57 aircraft are in the NATOPS and Contact Flight Training Instruction (FTI).

Flare and Touchdown. Figure 11-26 shows the airflow and force vectors for a blade in an autorotative deceleration. To make an autorotative landing, the aviator reduces airspeed and rate of descent just before touchdown. The aviator can partially accomplish both actions by applying aft cyclic, which changes the attitude of the rotor disk in relation to the relative wind. A nose-up cyclic flare (Figure 11-26) at 75-100 feet AGL (for the TH-57) **tilts the rotor disk rearward** which inclines the resultant thrust of the rotor system to the rear, **slowing forward speed**. It also increases AOA on all blades by changing the direction of airflow through the rotor system. The resulting increase in AOA creates more lift along with the lift vector becoming more vertical,

which **decreases rate of descent**. Moreover, the downward shift in relative wind tilts the lift vector at blade element more forward, resulting in a larger pro-autorotative force; **this increases rotor rpm**. The increase in rpm can be used to cushion the landing but must be monitored to prevent overspeeding the rotor head. Additionally, the flare exposes more of the fuselage to the airstream, thereby **increasing fuselage parasitic drag**, further aiding in slowing the aircraft down. The flare should be maintained in an effort to reach a point where forward speed is five to ten knots at close proximity to the ground (10-15 feet). At this point, increasing collective increases thrust (trading rpm for lift) and augments braking action, using up part of the stored rotational energy. Due to the aft-tilted thrust vector and the addition of collective, the pilot must put in a little forward cyclic to level the aircraft and use that last rotational energy by pulling collective to cushion the landing. Since there is no torque from the engine, drivetrain drag may cause the fuselage to “follow” the rotor system when collective is pulled, causing the nose to yaw to the left and requiring some right rudder, the opposite of powered flight. The key is to maintain heading control throughout the autorotation using the rudder pedals as necessary.

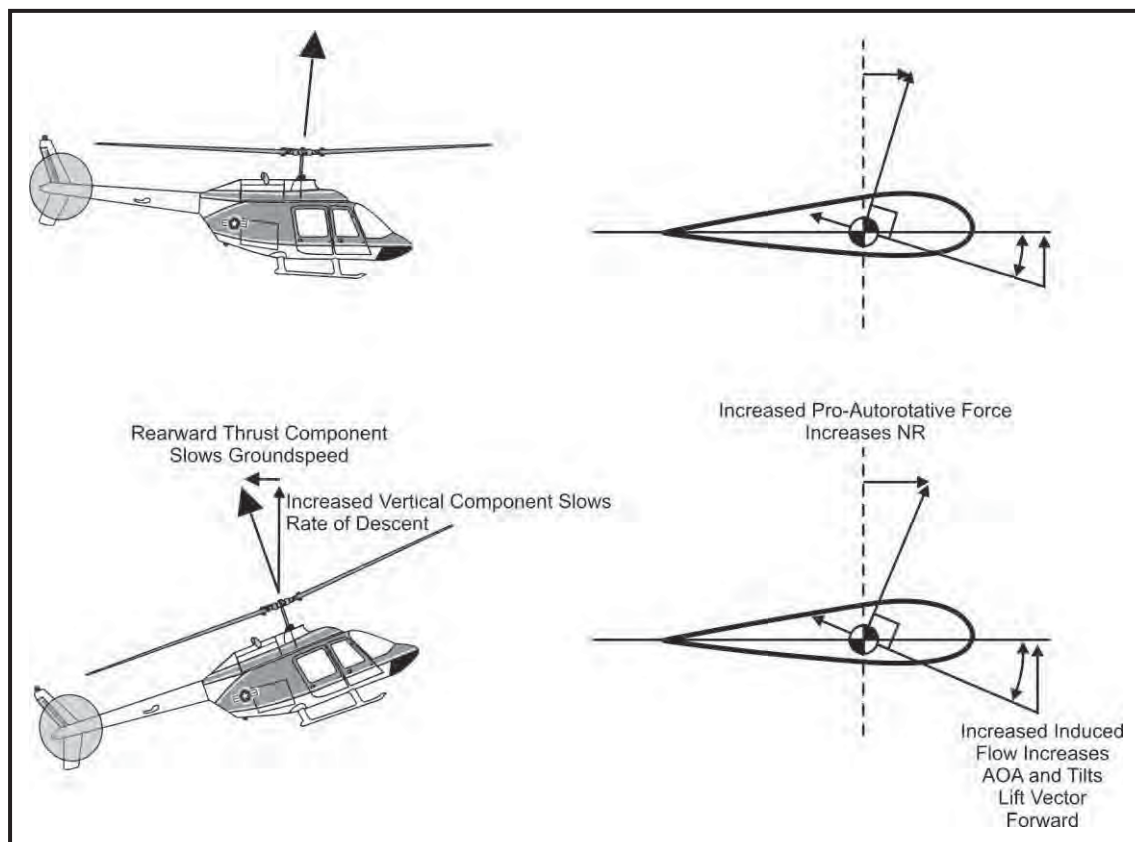

Figure 11-26 Blade Element and Thrust During Steady State Auto and Flare

If one chooses to arrive at flare altitude at less than minimum rate of descent airspeed, there is little or no forward speed to trade off for this advantageous increase in rotor rpm and braking action. Forward speed is already low, and if too much flare is combined with an improperly timed flare (too high), forward speed may reduce to zero at a high altitude. This condition is known as becoming “vertical,” and since the rotor system already has little stored energy, there

will not be enough thrust available with collective increase to slow rate of descent at touchdown to a non-destructive level.

Arriving at the altitude for maximum decelerative effectiveness just prior to collective pull is extremely useful because it involves trading kinetic energy from the descent for kinetic energy in the rotor. If the attitude was achieved and held for an extended period of time, the reduction in velocity would cause a greatly increased descent rate, which would increase the size of the stall region on the blades and cause a loss of rpm.

Factors affected by the flare are:

1. rpm
2. Thrust vector direction and magnitude
3. Fuselage attitude

1115. WINDMILL BRAKE STATE

Windmill Brake State. If the rotor somehow entered a descent at a rate in excess of approximately 180% of induced velocity, too much potential energy would be diverted to powering the rotor. Excessive rotor speed would create a very dangerous condition. In the windmill brake state virtually all flow is “up” relative to the rotor (Figure 11-27), and energy may be extracted from the system. This is the condition in which windmills extract energy from the passing air, but it is not a normal operating state for any helicopter. The one time that a rotorcraft is put into a descending flow state that approaches windmill brake is during the cyclic flare of an autorotation. During that transient phase, kinetic energy is increased in the rotor by increasing upflow in order to make it available for use in the landing. **However, rpm must be monitored and controlled to prevent excessive buildup and overspeeding of the rotor head.**

NOTE

An overly aggressive cyclic maneuver in powered flight could also cause temporary entry into windmill brake state and overspeed the rotor system.

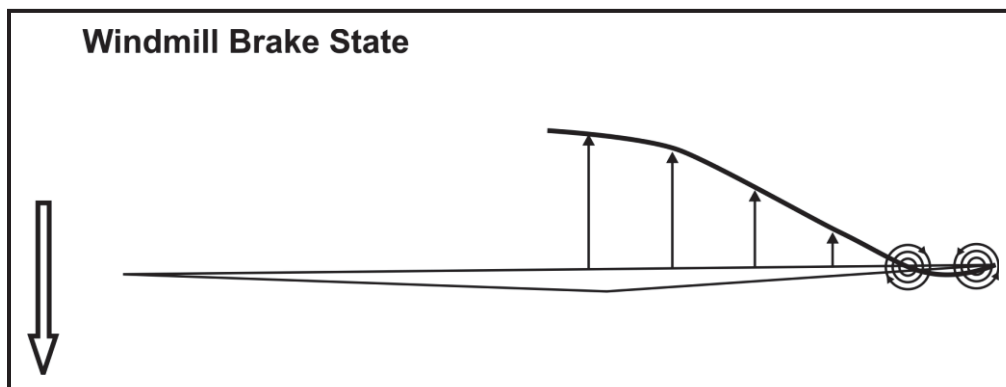

Figure 11-27 Windmill Brake State

1116. HEIGHT-VELOCITY DIAGRAM

No matter how well the pilot can execute an autorotation, there remain some combinations of initial altitudes and airspeeds from which a safe autorotational landing will be extremely difficult to perform. In fact, at some combinations of altitude and forward speed, it is almost impossible to demonstrate safe autorotative landings at a vertical touchdown speed within the design limits of the landing gear. The boundaries of these combinations define the height-velocity diagram or "The Deadman's Curve." (Figure 11-28)

The purpose of an H-V diagram is to identify the portions of the flight envelope from which a safe landing can be made in the event of a sudden engine failure. The H-V diagram (Figure 11-28) also generally depicts two areas to be avoided: The low-airspeed/high-hover altitude (low flight altitude) region and the high-airspeed/low-altitude region. These are named with respect to takeoff from the IGE Hover. At a hover, 200 – 300' is considered a high altitude. Above 60 KIAS, flight below 20' would be considered low altitude.

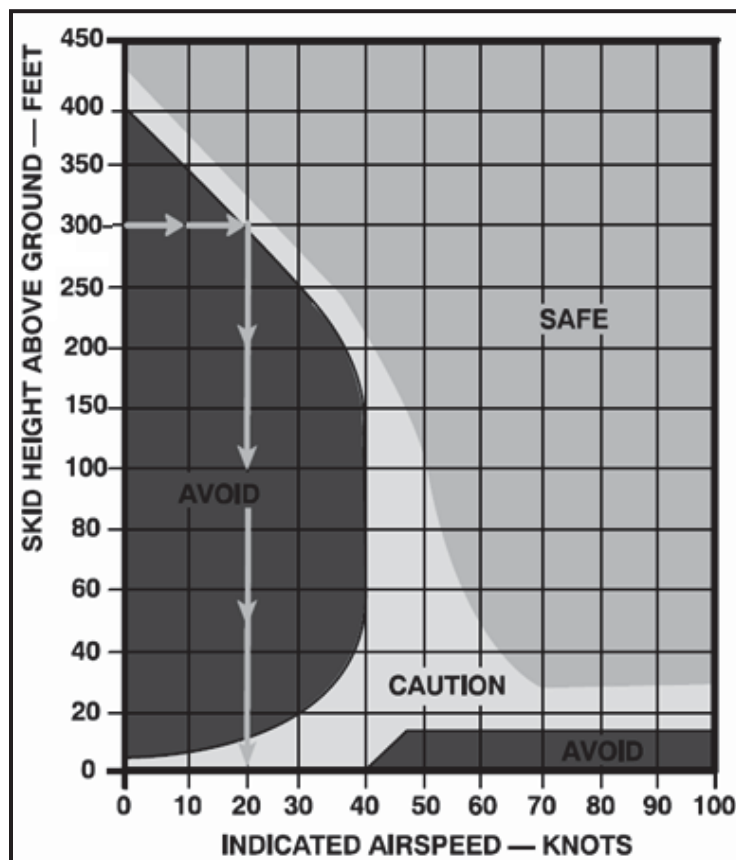

Figure 11-28 TH-57 H-V Diagram

There are H-V diagrams for each type of helicopter. They are found in their respective NATOPS

manuals. Helicopter pilots should be familiar with these diagrams.

Taking a closer look at the H-V diagram in Figure 11-29, we see several definite points define the curve, the first being the low hover height. Up to this height, a pilot can handle a power failure by coming straight down, using collective increase to cushion the landing. Above that altitude in combination with low speed, the rotor blades will slow down and stall if collective setting remains constant, or the helicopter will impact the ground too hard if collective is lowered. Enough altitude does not exist to acquire enough forward airspeed by the time flare altitude is reached to successfully execute a flare.

This height is a function of:

1. the power required to hover.
2. rotor inertia.
3. blade area and stall characteristics.
4. the capability of the landing gear to absorb the landing forces without sustaining damage.

The unsafe hover area runs from the low hover height to the high hover height. Above this altitude, there is enough altitude to make a diving transition into forward flight autorotation and execute a normal flare.

Beyond the knee of the curve, a power failure is survivable at any altitude above the high-air-speed/low-altitude region.

The three problems associated with the high-air-speed/low-altitude region are as follows:

1. pilot reaction time,
2. lack of time and altitude for the induced flow to reverse before ground impact, and
3. possibility of tail rotor stinger strike in response to cyclic flare to trade altitude for airspeed.

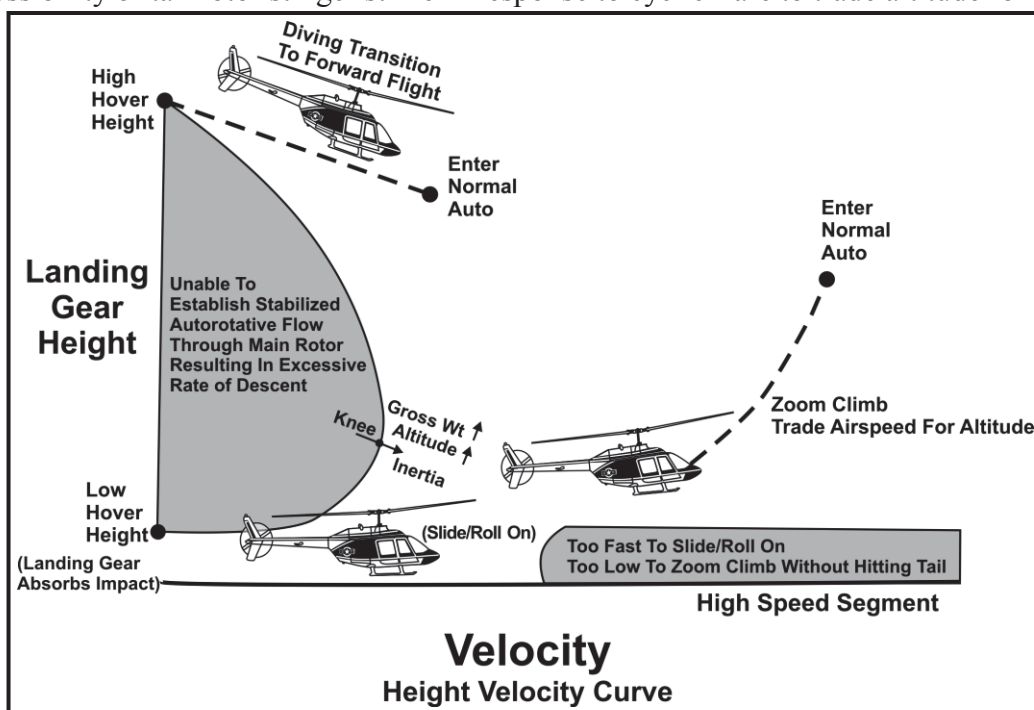

Figure 11-29 Generic Height Velocity Diagram

Skilled test pilots, who try to make their reactions simulate those of the average reaction time of a pilot, establish H-V diagrams. This is done by specifying a definite delay time following the engine failure before initiating control input. The military assumes their pilots may be distracted during an engine failure due to focused attention to assigned missions, allowing a two-second delay before response during any flight condition.

A few regions of operation are apparent on the H-V diagram.

1. **Low-speed region.** The largest region noticed on the diagram occurs where potential energy is not sufficient to offset low aircraft kinetic energy state for transition to an autorotative glide path. In other words, not enough altitude is available to establish a steady-state glide and minimum flare airspeed. When the engine fails in this sector a rapid rate of descent will occur, but with little or no forward airspeed a flare will not be capable of arresting the descent prior to landing. Application of collective will cause the rpm to decay excessively resulting in a hard landing (limited rotor rotational kinetic energy available).
2. **Low-altitude/high-speed region.** At low altitude and high speed, a quick cyclic flare can transfer kinetic energy to the rotor, provided time is sufficient to initiate the maneuver before ground impact. In the low-altitude/high-speed region, velocity is too great for a safe taxiing auto, but altitude is too low for flare initiation. By the time the pilot reacts (using typical reaction time) with a flare or zoom climb, the tail sinks enough to impact the ground.
3. **High hover height.** At altitudes above the low airspeed avoid region, the pilot can enter autorotation by making a diving transition to forward flight, reaching the desired autorotation airspeed and then executing a normal flare.
4. **Low hover height.** Below the low airspeed avoid region the helicopter can simply be landed straight down with no forward airspeed and cushioned with collective and/or landing gear. Rotor stored kinetic energy is traded in the cushion.

The size of the avoid region is affected by several variables. Pilot response time varies, but charts are drawn on the basis of average pilot response times. Airspeed affects the ability to establish an autorotation at an acceptable rate of descent. Rotor inertia determines how quickly the rotor loses speed. A low-inertia system would be more likely to lose valuable rpm before establishment of autorotation, so it would have a larger avoid area than a helicopter with high rotor inertia. Increased gross weight increases power required for flight, which in turn increases rate of descent and thus increases the size of the avoid area. DA decreases rotor efficiency and increases power required, so it has the same effect as increased gross weight on size of the avoid

area.

The variables that directly affect the size of the height-velocity diagram avoid area are:

1. **Rotor Inertia.** High inertia reduces shaded region because rpm does not decay as fast as a low-inertia system. High inertia moves the “knee” left.
2. **Gross Weight.** Power requirements increase. High gross weight moves the “knee” right.
3. **DA.** Same effect as gross weight. High DA moves the “knee” right.

H-V Guidelines in the TH-57. During normal takeoff, airspeed should be 40 KIAS by 20’ AGL and 65 KIAS by 50’ AGL to minimize the risk near the H-V diagram avoid areas, transitioning through the caution area into the green area as quickly as possible.

NOTE

The NATOPS manual states that:

“Protracted operations in the AVOID and CAUTION areas of the height-velocity diagram shall not be made.”

It does not state that they are prohibited. Mission operations such as rescue hoisting, FAST roping, externals, etc., all require “high” altitude hovers. One just needs to realize that if an engine failure occurs during those operations, options may be limited!

THIS PAGE INTENTIONALLY LEFT BLANK

CHAPTER ELEVEN REVIEW QUESTIONS

1. _____ is the self-sustaining rotation of the rotor blades in unpowered flight.
2. Pro-autorotative force is the vertical/horizontal component of lift/profile drag.
3. What is the anti-autorotative force in the rotor system? _____
4. For unpowered flight, induced flow is perpendicular/parallel to the tip path plane and comes from above/below the rotor disk.
5. The three conditions required to enter an autorotation are _____, _____, and _____.
6. How does the flare in an autorotational descent affect the aircraft? _____
7. Minimum rate of descent in unpowered flight is achieved by _____.
8. The unshaded areas of the H-V diagram identify the portions of the flight envelope from which a _____ can be accomplished in the event of a _____.
9. Using Figure 11-25, the Autorotational Glide Characteristics Chart, determine maximum glide airspeed.
10. List the four flow regions along a rotor blade in forward flight autorotation: _____, _____, _____, _____.
11. What is the self-induced rotation of a rotor system in unpowered flight?
 - a. Autorotation
 - b. Inertia
 - c. Autogyration
 - d. Rotary flight
12. When the pro-autorotative forces equal in-plane drag, the rotor rpm will be:
 - a. fluctuating
 - b. decreasing
 - c. increasing
 - d. stabilizing

13. The force which enables the pilot to regain rpm during autorotative flight is:
- momentum
 - anti-autorotative force
 - pro-autorotative force
 - inertia
14. Anti-autorotative force _____ when the pilot _____ the collective in autorotative flight.
- increases ... lowers
 - does not change ... lowers
 - decreases ... raises
 - decreases ... lowers
15. The induced flow in an autorotation is:
- perpendicular to the relative wind
 - perpendicular to the induced drag
 - same as in powered flight
 - reversed from powered flight
16. An autorotative flare will increase rotor rpm and decrease
- A/S and rate of descent
 - engine rpm and rate of descent
 - engine N_g and rate of descent
 - A/S and engine rpm
17. Rotor speeds above the optimum rpm
- will cause an increase in the rate of descent
 - will cause a decrease in the rate of descent
 - will not affect rate of descent
 - will improve the range that can be traveled
18. When does VRS take place?
- When power required exceeds power available
 - When power available exceeds power required
 - When retreating blade stalls
 - When aircraft settles in its own vortex

19. Concerning the height-velocity (HV) diagram, what conditions should be avoided?
- Low-altitude, slow-air-speed
 - High gross weight and DA
 - High-air-speed at altitude
 - Low-altitude, high-air-speed
20. Your aircraft's power required is greater than power available. Placing the collective down will
- decrease the rate of descent at that air-speed
 - intensify the VRS
 - reverse the air-flow, reduce the in-plane drag, and stop the rate of descent
 - increase the rate of descent

CHAPTER ELEVEN REVIEW ANSWERS

1. autorotation
2. horizontal, lift
3. in-plane drag
4. perpendicular, below
5. lower collective, reverse airflow, control N_r
6. reduce rate of descent, reduce forward airspeed, increase N_r
7. flying at the minimum rate of descent airspeed as determined from the Autorotational Glide Characteristics Chart in NATOPS.
8. safe landing, loss of engine power
9. 72 KIAS
10. propeller, autorotation, stall, reversed flow
11. a
12. d
13. c
14. d
15. d
16. a
17. a
18. d
19. d
20. d

CHAPTER TWELVE FLIGHT PHENOMENA

1200. INTRODUCTION

The purpose of this chapter is to aid the student in understanding the aerodynamic theories of various flight phenomena. This lesson topic will introduce concepts such as maneuvering hazards, mast bumping, vibration analysis, tail rotor issues, ground resonance and dynamic rollover.

1201. LESSON TOPIC LEARNING OBJECTIVES

1. **Terminal Objective:** Partially supported by this lesson topic:

Upon completion of this unit of instruction the student will identify factors that lead to undesirable flight phenomena and preventive action.

2. **Enabling Objectives:** Completely supported by this lesson topic:

- a. Recall the definition of load factor and describe its relationship to maneuvering flight.
- b. Explain which factors define the flight envelope and are driving factors in the development of the V-N diagram.
- c. Recall the definition of mast bumping, its causes, and recovery procedures.
- d. Describe helicopter vibrations and their sources.
- e. Recall the definition of main rotor vortex interference with the tail rotor.
- f. Recall the definition of weathercock instability.
- g. Recall the definition of tail rotor VRS.
- h. Recall the definition of ground resonance and air resonance in helicopters, its cause and effects, and recovery procedures.
- i. Recall the definition of dynamic rollover, its cause(s), and recovery procedures.
- j. Explain causes of fuselage blade strikes and preventive measures.

1202. REFERENCES

1. Fundamentals of Aerodynamics, NAVAVSCOLSCOM-SG-111
2. Rotary Wing Aerodynamics for Naval Aviators
3. Fundamentals of Flight
4. Helicopter Aerodynamics

1203. STUDY ASSIGNMENT

1. Review Chapter Twelve.
2. Answer the Review Questions.

1204. GENERAL

Maneuvering flight can place both the aircraft and the pilot under stress. Knowing the maneuvering limitations is critical. In combat, the aircraft may be flown on the edge of the envelope, as dictated by the mission or to save lives. In training, the student will be introduced to the envelope gradually. Develop a comfort zone. Learning the dangers associated with flight discussed in this chapter, as well as the methods for their avoidance/recovery, are critical to a career in aviation. Just as important are two ground maneuvers discussed in detail: ground resonance and dynamic rollover.

1205. MANEUVERING FLIGHT / G-LOADING

Maneuvering flight occurs when a pilot makes control inputs to remove the aircraft from equilibrium and accelerate it in any direction. In a helicopter, the mechanism for applying the force that gives such acceleration is changing the thrust or tilt of the rotors. A forward disk tilt causes acceleration and a lateral tilt causes turning.

1. Level Turn Performance

Level turns are the starting point for all discussions of maneuvering flight. The main rotor thrust required in a turn is a function of bank angle and weight. As Figure 12-1 shows, in straight and level flight the thrust from the main rotor is equal to the weight of the aircraft, as long as the aircraft is not accelerating or decelerating. When an AOB is introduced the thrust vector is put at an angle with the horizon that can be divided into horizontal and vertical components (Figure 12-2). The force vectors and AOB are isolated for consideration in Figure 12-3.

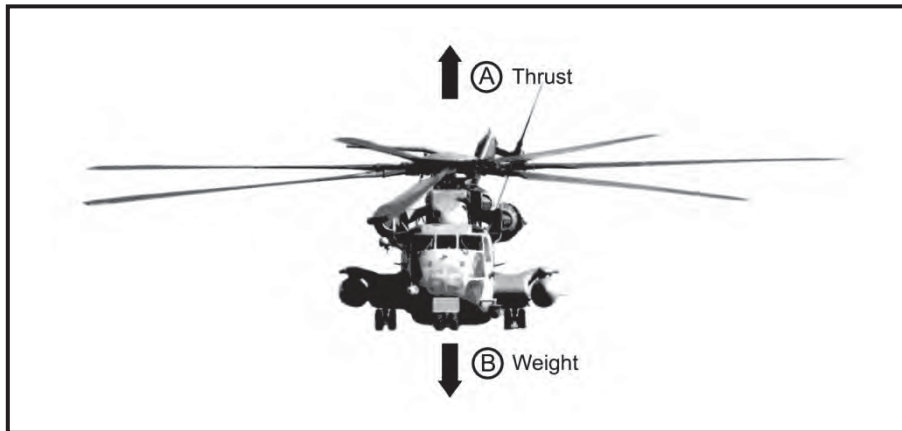

Figure 12-1 Straight and Level Flight

In a turn, the horizontal component of lift, called centripetal force, accelerates the aircraft toward the center of the turn. In straight and level flight (constant altitude, constant direction), total lift is equal to weight, but **in a turn, only the vertical component of the thrust vector (TV) opposes weight**. If the pilot does not increase the total lift vector, the aircraft will lose altitude because weight will be greater than the TV's vertical component. The increased lift is normally obtained by increasing the AOA, that is, pulling back on the stick. As the stick is pulled aft, the aircraft and pilot experience "G-forces."

From trigonometry, the cosine of an angle in a right triangle is equal to the length of the opposite side divided by the length of the longest side (hypotenuse). Applying that relation to the triangle of Figure 12-3 yields:

$$\cos AOB = \frac{\text{vertical component}}{\text{total rotor thrust}}$$

and by rearranging terms:

$$\text{total rotor thrust} = \frac{\text{vertical component}}{\cos AOB}$$

To keep from losing altitude, the vertical component must equal weight, so total thrust required can easily be calculated using AOB and weight. Just divide the weight by the cosine of the AOB.

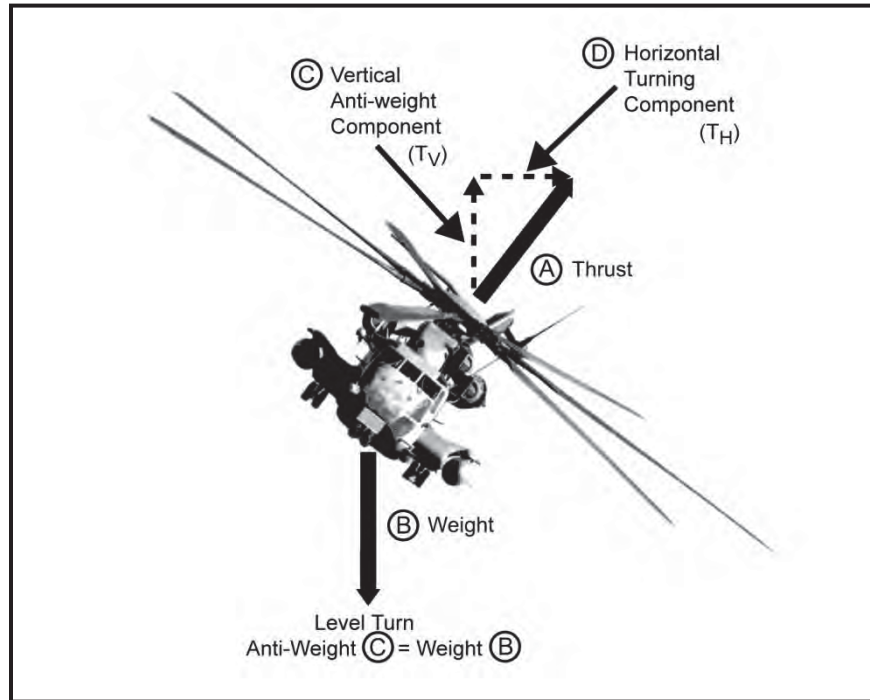

Figure 12-2 Maintain Altitude By Increasing Thrust

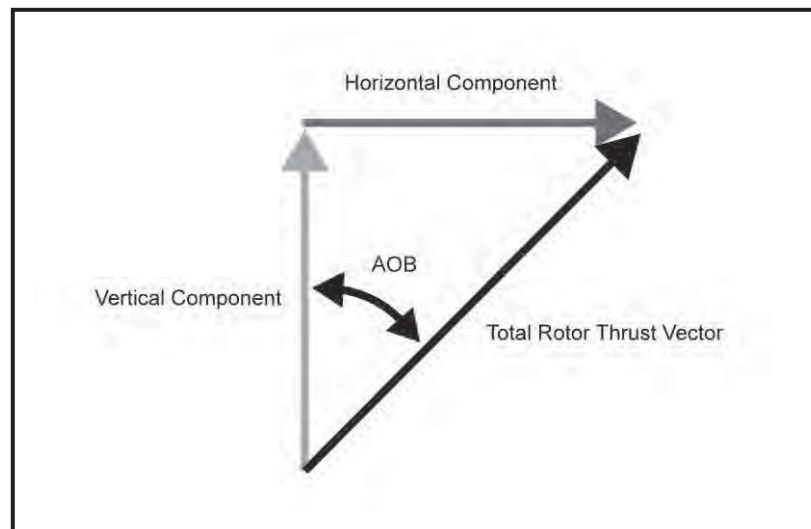

Figure 12-3 Force Vectors in a Turn

Taking the cosine of various angles of bank and then calculating the inverse of those values produces some interesting results (Figure 12-4). Remember that the total thrust required for a level turn would be the weight of the helicopter multiplied by the $1/\text{COS}$ AOB term in the last column of the table. For example, at 15° AOB total thrust required would be equal to 1.04 times the weight. Stated another way, one could say that there is 4% more power required in a 15° AOB turn to maintain level flight than would be required in straight and level flight. A 20,000 pound aircraft, in that case, would require 20,000 pounds of thrust to fly straight and level, but

would need 20,800 pounds of thrust to fly level at 15° AOB. At 30° AOB an additional 3,000 pounds would be required, and at 60° an additional 20,000 pounds of thrust would be required in order to maintain altitude. If the pilot did not increase thrust in this situation the aircraft would descend.

AOB (φ)	COS AOB	Load Factor 1/COS AOB
0°	1.00	1.00
15°	0.97	1.04
30°	0.87	1.15
45°	0.71	1.41
60°	0.50	2.00
90°	0.00	Infinity

Figure 12-4 Cosine and Inverse of Cosine for Various Angles of Bank

Because the 1/COS AOB term is so important and so frequently used, it is defined as a separate term: "load factor" and is so labeled in Figure 12-4. **Load factor (n)** is the ratio of total lift to the aircraft's weight. Load factor is equivalent to the number of times the earth's gravitational pull felt by the aircraft and pilot, so is often referred to as "G". One "G" is what we experience just sitting or taxiing around on the ground.

$$n = \frac{L}{W} = \frac{1}{\cos\phi} \quad \text{or} \quad L = W \cdot n$$

Load factor is given the variable n or N in most aerodynamic or engineering texts. In maneuvering flight, the amount of lift produced by an aircraft is equal to its weight (W) multiplied by its load factor (n). Phi (φ) is the AOB associated with the load factor (n). The increase in thrust required with increasing load factor translates directly to increases in power required (Figure 12-5), which reduce excess power.

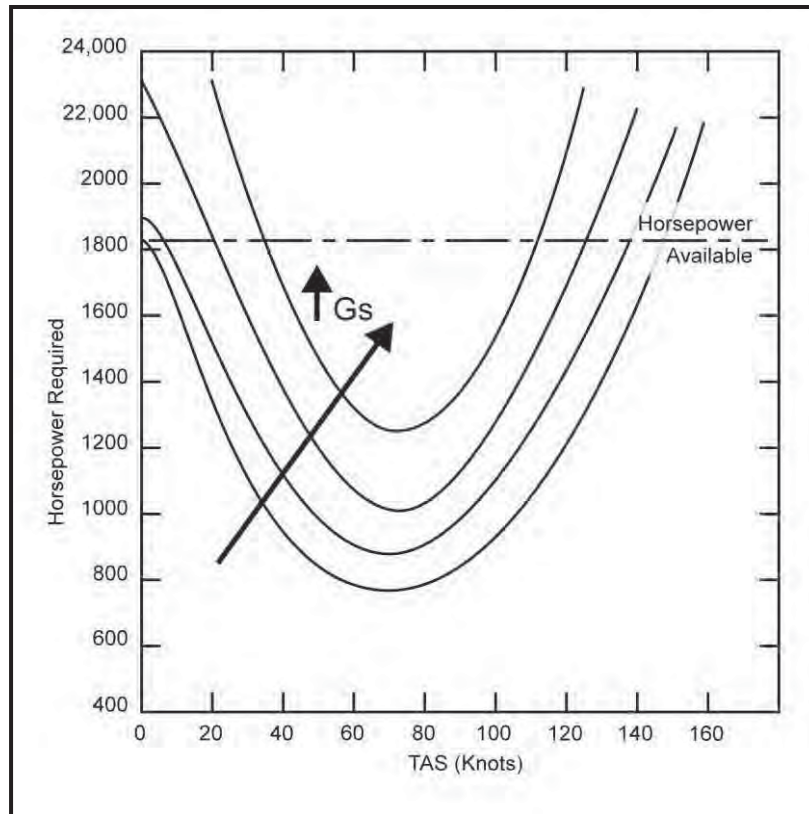

Figure 12-5 Power Required For Various Load Factors

Turn performance is measured using two different parameters, turn rate and turn radius. **Turn rate (ω)** is the rate of heading change, measured in degrees per second. **Turn radius (r)** is a measure of the radius of the circle the flight path scribes. Turn performance in a level coordinated turn is controlled only by airspeed and AOB. Weight, altitude, load factor, stalling AOA, engine performance, and DL may limit either the airspeed or AOB. This would limit maximum turn rate or minimum turn radius; however, the actual performance would still be determined using only airspeed and AOB. The formulas for determining the turn rate and turn radius for an aircraft in coordinated flight are:

$$\omega = \frac{g \tan \phi}{V} \qquad r = \frac{V^2}{g \tan \phi}$$

Where: ω = turn rate r = turn radius
 V = velocity ϕ = AOB
 g = gravitational acceleration

If velocity is increased for a given AOB, turn rate will decrease, and turn radius will increase. An example of this would be turning a very sharp corner on a bicycle at 5 mph versus trying to turn the same corner at 30 mph. **If AOB is increased for a given velocity, turn rate will increase, and turn radius will decrease.**

You can see that maximum turn rate and minimum turn radius would be achieved in a 90° AOB turn, at the aircraft's minimum velocity. However, there are limits on AOB and velocity. Maximum AOB to maintain level flight is limited by the limit load factor. If an aircraft's limit load is 2 G's, the maximum AOB where it could maintain level flight will be 60°.

2. Coordinated Flight

The turn-and-slip indicator gives the pilot a visual indication of coordinated flight. It consists of a turn needle and a ball suspended in fluid. If the ball is centered, the aircraft is in coordinated flight (Figure 12-6). If the ball is displaced in the same direction as the turn, the aircraft is in a slip. If the ball is displaced in the opposite direction as the turn, the aircraft is in a skid.

Whenever the aircraft becomes uncoordinated during flight, the corrective action is to alter the amount of rudder being used. This simply means to apply rudder in the direction the ball is displaced. Therefore, if the ball is displaced to the right, apply right rudder. A memory aid to remember the proper rudder correction is "Step on the ball."

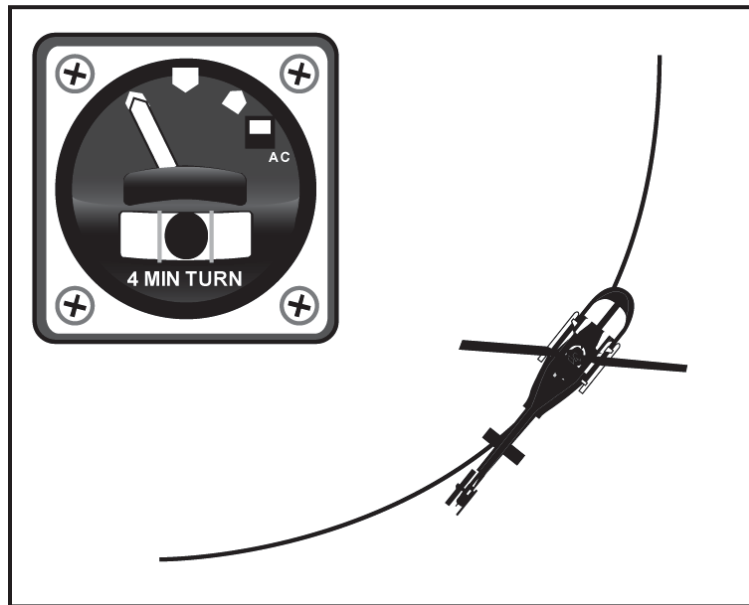

Figure 12-6 Coordinated Flight

A **skid** is caused by using too much rudder in the desired direction of turn (Figure 12-7). The yawing movement is toward the inside of the turn and the balance ball is deflected toward the outside due to centrifugal force. **In a skid, turn radius will decrease and turn rate will increase.**

A **slip** is caused by insufficient rudder in the desired direction of turn (Figure 12-7). The yawing movement is toward the outside of the turn, and the balance ball is deflected toward the inside due to gravitational pull. **In a slip, turn radius will increase and turn rate will decrease.** Slips are useful for crosswind landings (commonly described as "wing down, top rudder"), or when trying to increase the airplane rate of descent without increasing airspeed.

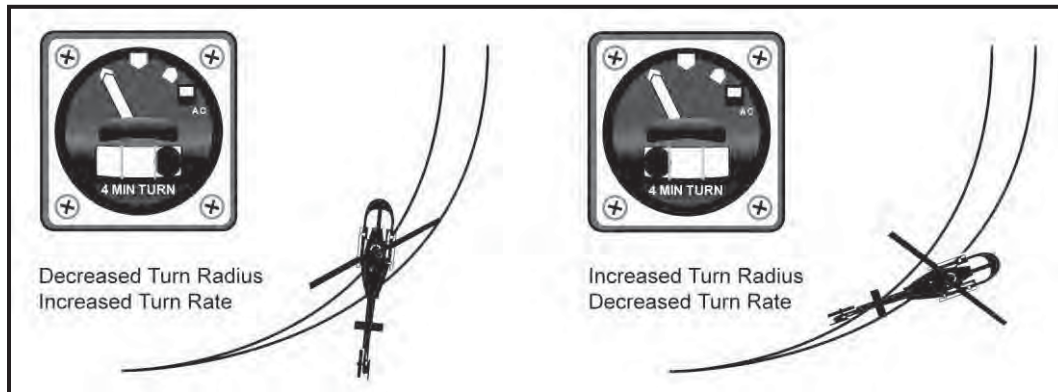

Figure 12-7 Skid and Slip

3. G-Loading

Load factor, or G load, times aircraft weight equals the **apparent weight** in a turn. The rotor system must supply thrust equal to the apparent weight. The main rotor of a helicopter in a 45° AOB turn would need to generate the power required to lift 1.41 times the gross weight of the aircraft. If the aircraft in question was at or near max gross weight or the DA was high, it is quite possible that power required could exceed power available. Higher positive or negative G's may also impact pilot performance.

As load factor approaches positive three G's, the heart struggles to maintain blood pressure in the upper extremities and blood will begin to drain from the head and neck. Skin begins to sag under its own weight and the face begins to deform. Further increases in G loading without precautionary measures may cause visual distortions or temporarily loss of consciousness. If consciousness is not regained quickly, the aircraft could plow into the ground at high speed.

As load factor approaches negative three G's, blood will begin to collect in the head and neck, increasing pressure and volume. This can be accompanied by a "full-feeling" or even pinpoint hemorrhaging of capillaries in the skin, sinuses, and eyeballs. Exceeding negative three G's may cause "red out" or eventually brain aneurysms as blood vessels burst in the brain. The pilot will tolerate positive G's better than negative G's.

Accelerated flight ('G' loads) can be established by using aft cyclic and/or collective control. The collective provides a **sustained maneuvering capability** in the sense that the helicopter's energy can be maintained. Maneuvering with aft cyclic provides a **transient 'G' capability** since speed eventually bleeds off to a lower speed where less 'G' is available. Using the cyclic to maneuver can provide transient maneuver capability until transient rotor thrust decays with speed reduction. Sustained maneuvering must be done with collective (power) input in order for the helicopter to maintain its speed and energy.

It should be quite obvious from Figure 12-4 that power required dramatically increases as the AOB increases. Defined as the level turn equation, a plot of load factor versus AOB is presented in Figure 12-8. The figure graphically shows the highly non-linear relationship that occurs at

angles of bank greater than 60°. As bank angle increases, minor bank angle variations require increasingly larger load factor adjustments. Note that load factor required for a level turn is a function of **bank angle (φ) only and is airspeed, weight and altitude independent**. The cumulative effect of bank angle changes is also important. Going from 15 – 30 degree AOB (a 15° change) only requires 11% more power. Going from 45 – 60 degree AOB (also a 15° change) takes 59% more power.

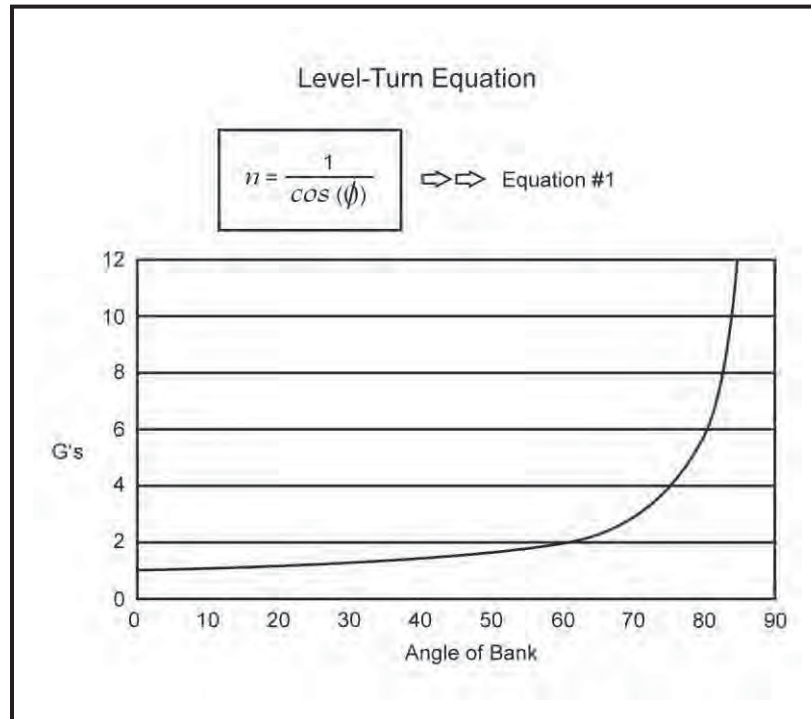

Figure 12-8 Load Factor vs. AOB

The danger of high AOB turns close to the ground, where helicopters fly, is the speed at which a descent occurs. Figure 12-9 is a graph of altitude (AGL) and time to impact for various angles of bank. A helicopter at 300' AGL, for example, that is placed in a 45° AOB turn **with airspeed and power constant**, will impact the ground in approximately 8.2 seconds.

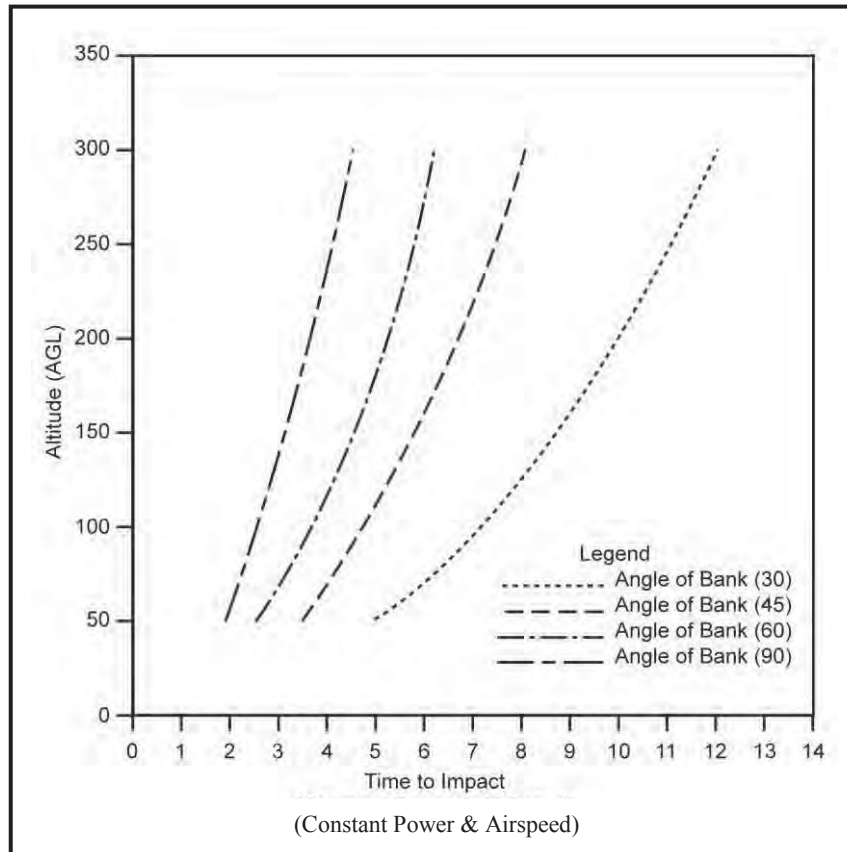

Figure 12-9 Time To Impact vs. Altitude at Constant Airspeed and Power

1206. OVERBANK

Overbank is that AOB that exceeds the intended AOB. The problems associated with banking an aircraft beyond a planned load factor have been expressed by aerodynamicists in the overbank equation. The equation was developed to determine how an aircraft would be affected if a task-saturated pilot applied inputs for a given bank angle but allowed the aircraft to roll into a higher AOB. In a level turn, the vertical component of Thrust (T), lift, is reduced to thrust times cosine of the angle of bank (AOB) and lift must still equal weight, therefore thrust must be increased for a given AOB. Using the force analysis in Figure 12-10, the overbank equation offers a way to calculate downward acceleration (in feet per seconds squared) that would result from overbanking an airplane or helicopter. **Over time, a vertical acceleration turns into a descent rate and altitude loss.**

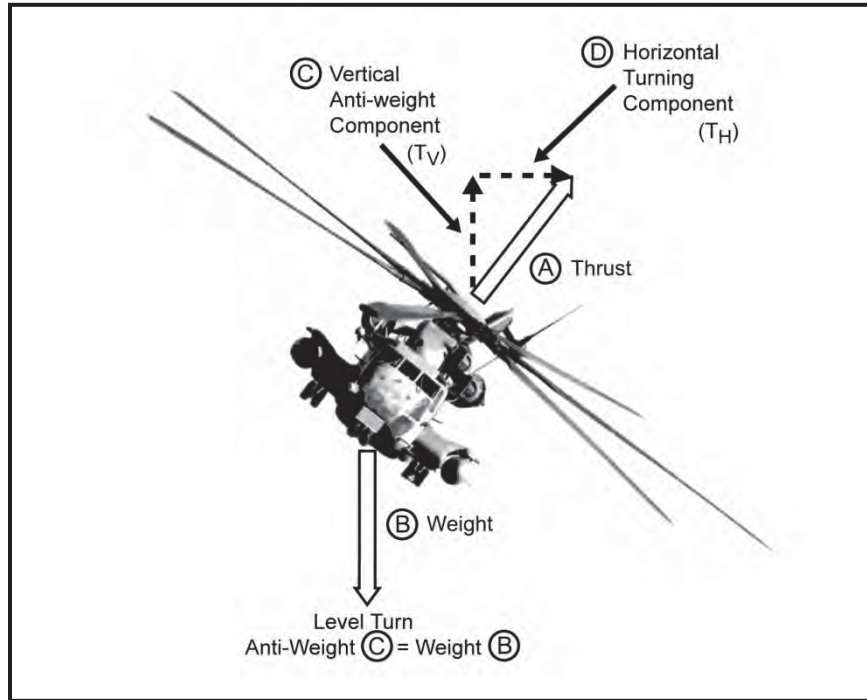

Figure 12-10 Overbank Equation Development

The overbank equation is best understood by viewing a plot of its values, but it has three variables a_z , intended AOB and overbank so it requires a 3-D graph or simplifying assumptions. For illustration in Figure 12-11, the five-degree and ten-degree overbank cases are shown at varying entry angles of bank. Notice that a five-degree or ten-degree bank angle error causes much more severe downward acceleration when started from a higher planned AOB. At a starting load factor of one, the downward acceleration associated with an inadvertent bank of five degrees or ten degrees is fairly negligible. With a load factor of two (as would be found at an AOB of 60°), both five-degree and ten-degree overbanks cause significant downward acceleration.

If z is the downward direction, W is weight, a_z is acceleration down, m is mass, g is acceleration due to gravity, T is thrust, AOB is made up of the planned AOB (ϕ) plus the overbank (∂), then load factor in the equation develops as follows:

$$\sum F_z = ma_z = W - T \cos(\phi + \partial)$$

$$a_z = \frac{W}{m} - \frac{T}{m} \cos(\phi + \partial) = \frac{W}{m} - \frac{T}{m} (\cos\phi \cos\partial - \sin\phi \sin\partial)$$

$$T = ngm$$

$$W = gm$$

$$a_z = \frac{gm}{m} - \frac{ngm}{m} (\cos\phi \cos\partial - \sin\phi \sin\partial)$$

$$a_z = g \left(-n(\cos\phi \cos\partial - \sin\phi \sin\partial) \right)$$

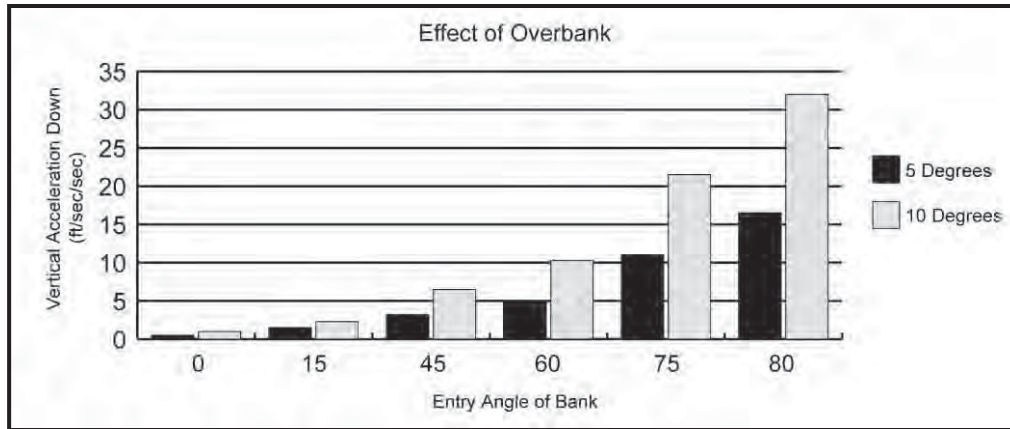

Figure 12-11 Effect of Overbank on Vertical Acceleration

Overbank Vertical Sink Rate and Altitude Loss: Applying some integration to the acceleration terms in the overbank situation yields an equation for velocity and distance traveled over time. As seen in Figure 12-12, overbank acceleration causes a steady ramp-up of vertical velocity as time passes.

$$v = a_z \cdot t$$

In turn, distance traveled builds as a function of time squared.

$$d = \frac{1}{2} \cdot a_v \cdot t^2$$

This makes overbank much more dangerous than a constant rate of descent because the initial sink rate may go undetected. **By the time the pilot detects the rapidly increasing VSI, the aircraft may already be in extremis.**

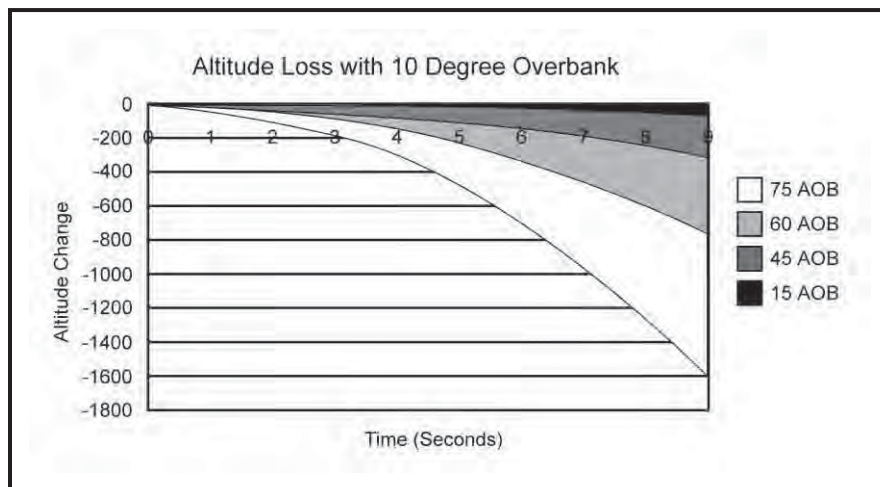

Figure 12-12 Loss of Altitude With 10° of Overbank

1207. DIVE PULLOUT

Another hazardous maneuver is a pullout from a dive at low altitude. During a dive pullout, the aircraft must overcome centrifugal force associated with the pullout in addition to the aircraft's weight (Figure 12-13).

An even less desirable condition can occur if the aircraft is rolled during a pullout. Often, during "failed" wing-over maneuvers, a pilot attempts to simultaneously roll wings level while pulling up. This "rolling pullout" is discouraged in fixed-wing aircraft because of the potential to easily overstress the aircraft. Helicopter pilots are discouraged from performing a "rolling pullout" because, while the potential for overstress is not as great, at a low altitude the reduction in the aircraft's pull-up capability while attempting the rolling pullout may prevent successful completion of the maneuver before ground impact.

Attempting to pull up from a dive, while simultaneously rolling wings level, divides thrust from the main rotor between two actions. The aircraft's ability to "apply G's" to pull up from the dive is **reduced by up to 1/3**. Because the thrust available is limited, there will be a further reduced G-generating capability while performing the maneuver at a higher gross weight.

If, for example, an aircraft is capable of generating 2 G's during dive recovery, it may only generate 1.3 G's during a rolling pullout. In a low altitude environment, such thrust may not be sufficient to recover.

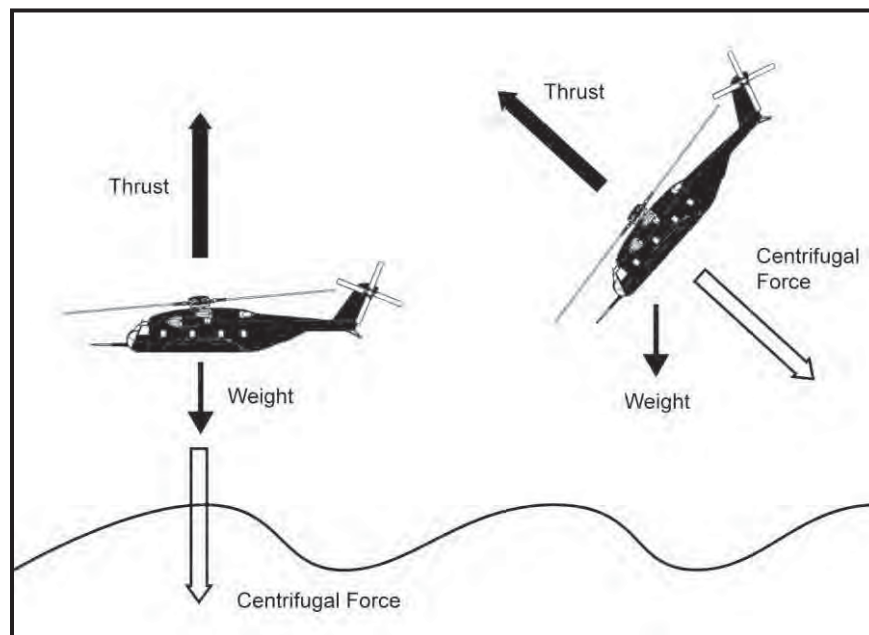

Figure 12-13 Dive Pullout

1208. CASE STUDIES – MANEUVERING FLIGHT

1. During a tiger cruise flight demonstration, the pilots decided to show the flight capability of the H-60 by performing a backward takeoff and departure from the ship. The H-60 successfully completed a number of low passes and wingover course reversals. On the last attempts the reversal was initiated from a lower altitude than the previous ones. At the top of the maneuver the aircraft reached nearly zero velocity and the stab programmed to the full down position. The aircraft descended rapidly and though the pilot was able to level the wings and nose, he was unable to arrest the descent. Hitting belly first with max power on the head caused the aircraft to bounce off the water while sustaining the loss of the stabilator. On the second bounce the aircraft began to violently roll and yaw. The crew chief egressed after motion stopped but the pilots were killed.
2. Another incident involved an approved mission to photograph, transfer passengers, and act as plane guard for a rubber boat raid. The helicopter made several low, fast passes by the ship, and then made a port-to-starboard pass around the stern to a position abeam the starboard bridge wing. At that point the PAC made a sliding 90-degree stopping turn to face the bridge. On a subsequent approach, the helicopter made a 60-90 degree nose-up climb, sharp right turn (70 – 100 degree AOB), and nose-down descent to flat water entry. The pilots flew a perfectly good aircraft into a maneuver which produced an unrecoverable rate of descent for the altitude remaining, and they lost their lives for it.

Lessons learned from these case studies:

HOGE power does not guarantee the ability to arrest a given rate of descent. Forces get their desired effect only after the requisite amount of time has elapsed. In this case, there was not enough time (altitude) for the descent to be stopped.

1209. FLIGHT ENVELOPE / V-N DIAGRAM

A helicopter's design is dictated by the expected use. Performance and load bearing requirements are set by the customer in the case of military aircraft or by the FAA and the engineering and sales departments for civil aircraft. Anticipated strength requirements to meet design criteria at a range of speeds are consolidated in a V-n diagram.

The **V-n diagram** or **V-G diagram** is a graph that summarizes an aircraft's structural and aerodynamic limitations at a particular weight, altitude and configuration. The horizontal axis is indicated airspeed. The vertical axis of the graph is load factor, or G's. V-n diagrams define the **maneuvering envelope** for fixed-wing aircraft (Figure 12-14) and rotary-wing aircraft (Figure 12-15). Helicopter NATOPS manuals typically do not have V-n diagrams because most helicopters do not have G-meters, therefore pilots are unable to gauge loading. Rather, AOB limitations are developed with consideration for associated load factors and general maneuver restrictions keep the aircraft in the envelope.

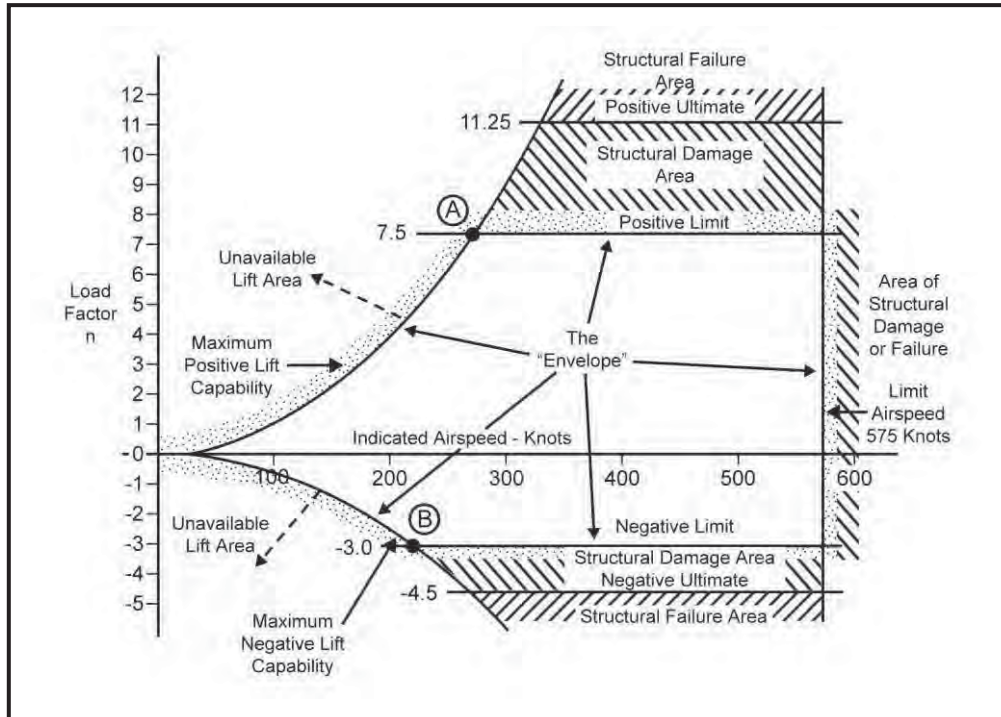

Figure 12-14 V-n Diagram for Fixed Wing Aircraft

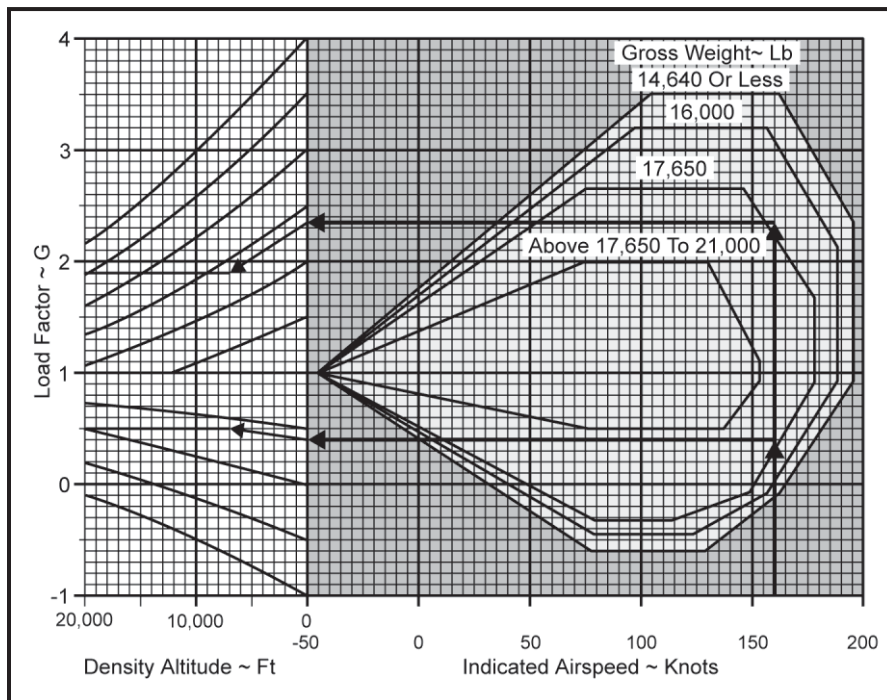

Figure 12-15 AH-64 Apache V-n Diagram

Several critical factors are identified on the V-n diagram. Even though NATOPS typically does not include a V-n diagram, consideration of the following factors goes into development of those maneuver limits and are worth knowing about before flying in critical situations:

Limit Load Factor. The top and bottom of the V-n diagram are established by the structural limit line, or limit load factor. Limit load factor is the greatest load factor an aircraft can sustain without any risk of permanent deformation. It is the maximum load factor anticipated in normal daily operations. If the limit load factor is exceeded, some structural damage or permanent deformation **may** occur. Aircraft will have both positive and negative limit load factors.

Overstress/Over-G is the condition of possible permanent deformation or damage that results from exceeding the limit load factor. This type of damage will reduce the service life of the aircraft because it weakens the aircraft's basic structure. Overstress/over-G may occur without visibly damaging the airframe. Inside the aircraft are a variety of components, such as hydraulic actuators and engine mounts, which are not designed to withstand the same loads that the airframe can.

Ultimate load factor. Ultimate load factor is the maximum load factor that the aircraft can withstand without structural failure. There will be some permanent deformation at the ultimate load factor, but no actual failure of the major load-carrying components should occur. If you exceed the ultimate load factor, structural failure is imminent (something major on the aircraft **will** break). The ultimate load factor is 150% of the limit load factor.

Increases in gross weight and altitude require increases in AOA and lifting forces so that the G envelope is reduced due to increased structural bending and blade flapping limits.

So far, in the roughly 70 years that helicopters have been operating, no really high load-factor maneuver has been identified as a prohibitively hard to attain design consideration. Because rotor blades are attached to the aircraft with a hinge or a relatively soft blade root, and because centrifugal force tends to bend the blade down, a rotor blade flaps up but doesn't bend significantly when developing high thrust. As a consequence, the pilot need not worry about causing a permanent set while doing an extreme maneuver. This is not to say, however, that no structural damage has been done. Experience shows that high load-factor maneuvers raise the level of oscillatory loads in the blades, hub, control system, and rotor-support structure. Usually the pilot has a sense of these loads in the level of vibration he feels. Depending on the design of the various components, the higher-than-normal oscillatory loads may cause fatigue damage that shortens the useful life of the part.

Lift Limit. The left-hand side of the V-n diagram is the lift limit. **This is the maximum load factor available at a given airspeed.** An aerodynamic limit of rotor thrust exists at speeds less than maneuver speed because air mass flow through the rotor is decreasing and the rotor can't generate high transient thrust levels. Attempted hard aft cyclic maneuvering at low speeds will result in further reduced speed and "G available." Many helicopters have the capability of generating in excess of four transient G's at high speed; it is unusual for a helicopter to be able to sustain more than two G's.

Limit Airspeed. The vertical line on the right side is called the **redline airspeed**, or V_{NE} (Velocity never-to-exceed). Redline airspeed is the highest airspeed that an aircraft is allowed to fly. Flight at speeds above V_{NE} can cause structural damage. **V_{NE} is determined primarily by excessive structural loads and power available, but may also be affected by controllability limits, M_{CRIT} , or airframe temperature.**

Excessive structural loads may be encountered on components other than the main structural members. Control surfaces, stabilizers, and other external components are often not able to withstand the same forces that the wings (rotor disc) or fuselage can withstand. Maneuvering at very high airspeeds may create sufficient forces to twist or break at their attachment point.

If an aircraft or component (**advancing blade**) reaches its critical Mach number (M_{CRIT}) and is not designed to withstand supersonic airflow, the shock waves generated may damage the structure of the aircraft. Redline airspeed for these aircraft will be slightly below the airspeed at which they will achieve M_{CRIT} .

Redline airspeed may also be used to set limits on airframe temperature. As airspeed increases, the aircraft encounters more air particles producing friction which heats up the airframe. This heating can be extreme and hazardous at high speeds. Once the temperature becomes excessive, the airframe may suffer creep damage.

Controllability may determine the redline airspeed on aircraft with conventional control systems. At high airspeeds, dynamic pressure may create forces on the control surfaces which exceed the pilot's ability to overcome. Or, due to the aeroelasticity of the control surfaces, full deflection of the cockpit controls may cause only small deflection of the control surfaces. In either case, the pilot will be unable to provide sufficient control input to safely maneuver the aircraft.

In fixed wing aircraft, the never exceed airspeed is established to preclude structural damage from flutter. In a helicopter, never exceed speed is based upon power available or component wear considerations.

V_{AFT} . The maximum allowable rearward speed. This may be a structural limit, but rotor/airframe configuration and rearward visibility from the cockpit are also factors, and V_{AFT} may be made as high as it is thought safe to test for.

Maneuvering Speed. The intersection of lift limit and structural limit lines occurs at the maneuvering airspeed. Maneuvering airspeed (V_a), also known as the corner airspeed, **is the maximum speed at which full control deflection can be abruptly applied without overstressing the aircraft.** V_a varies with aircraft weight, just as the size of the maneuvering envelope changes with weight. Above maneuver speed, the rotor can generate high aerodynamic loads in excess of the limit load or can be pushed into retreating blade stall. Below maneuver speed an aerodynamic limit of rotor thrust exists. At the maneuver speed the aircraft can achieve limit load at a low speed, so it offers maximum turn rate and minimum turn radius.

Gust loading. Gust loading refers to the increase in the G load due to vertical wind gusts. The load imposed by a gust is dependent upon the velocity of the gust. The higher the velocity, the

greater the increase in load. If an aircraft were generating the limit load factor during a maximum performance turn and hit a vertical gust, the gust will instantaneously increase the AOA of the airfoils and increase the lift on the rotor blades, enough to raise the G load above the limit load factor. This is why **"intentional flight through severe or extreme turbulence and thunderstorms is prohibited"** in many aircraft.

Vertical gusts of up to 30 feet per second may be encountered in moderate turbulence. This could produce up to two G's of acceleration on the aircraft. Because gust loading is cumulative with pilot-induced loading, **the limit load factor due to pilot-induced loads should be reduced to two-thirds of the normal limit load factor**. For this reason, if you make the mistake of entering a thunderstorm, consideration should be given to continuing to the other side since maneuvering increases the pilot-induced loads.

Turbulence penetration also requires that you slow the aircraft to a speed that will reduce the effects of stress caused by gust loading. Since a thunderstorm gives no assurance of positive G loading, thunderstorm penetration airspeeds may reflect the intersection between the negative load and negative lift lines.

1210. MAST BUMPING

Low-G Maneuvering. Another situation that pilots can find themselves in is a maneuver where the load factor is too low. This low or zero G maneuver can wreak havoc on a teetering rotor system while a rigid (hingeless) or fully articulated rotor system is able to fly right through it. The difference is in how the different rotor systems generate control moments. A teetering rotor system relies only on main rotor thrust and its distance from the aircraft's CG in order to maneuver. A fully articulated or rigid (hingeless) rotor system uses the main rotor as a control power generator but also has control power generated through its offset flapping hinges. The centrifugal force of the rotor system acts through a couple that exists at the flapping hinges so that even in a zero G environment the aircraft will maintain some control power (Figure 12-16).

When a teetering rotor system loses its control power due to low G-loading the phenomenon known as mast bumping is likely to ensue. The problem occurs when the rotor head tilts (with respect to the mast) and contacts the mast; in other words - when the rotor flaps excessively. Flapping amplitudes usually reach only a very small proportion of the maximum allowed for maneuvers within the envelope, but several conditions can increase the probability of mast contact while operating.

Probable causes of mast bumping include turn-up/shutdown with controls not centered, slope operations, operation in gusty winds, abrupt cyclic inputs, low G maneuvers (TERF, GUN RUN), engine/MDS failure, or hard landings. During any one of these conditions, aside from turn-up or shutdown, the aircraft reaction is an uncommanded right roll that can rapidly develop into mast bumping with an improper pilot response. Of most concern is in-flight mast bumping, because it can rapidly lead to loss of an aircraft.

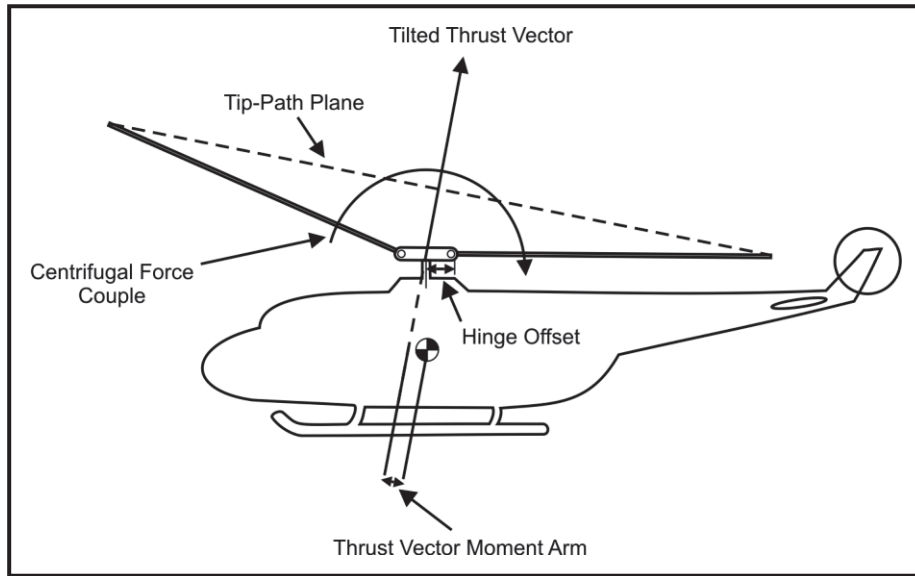

Figure 12-16 Sources of Rotor System Control Moments

In-flight mast bumping does not occur unless flapping is well outside normal parameters. High forward flight speeds at high gross weights and DAs result in flapping angles of approximately 15% or less of the maximum allowable for a typical semi-rigid system. To actually exceed the maximum flapping limits, a low-G maneuver is usually required.

A pilot changes pitch or roll attitude by using cyclic to tilt the rotor thrust vector with respect to the mast. That action generates an unbalanced moment about the aircraft CG, and fuselage attitude is changed. (Figure12-17)

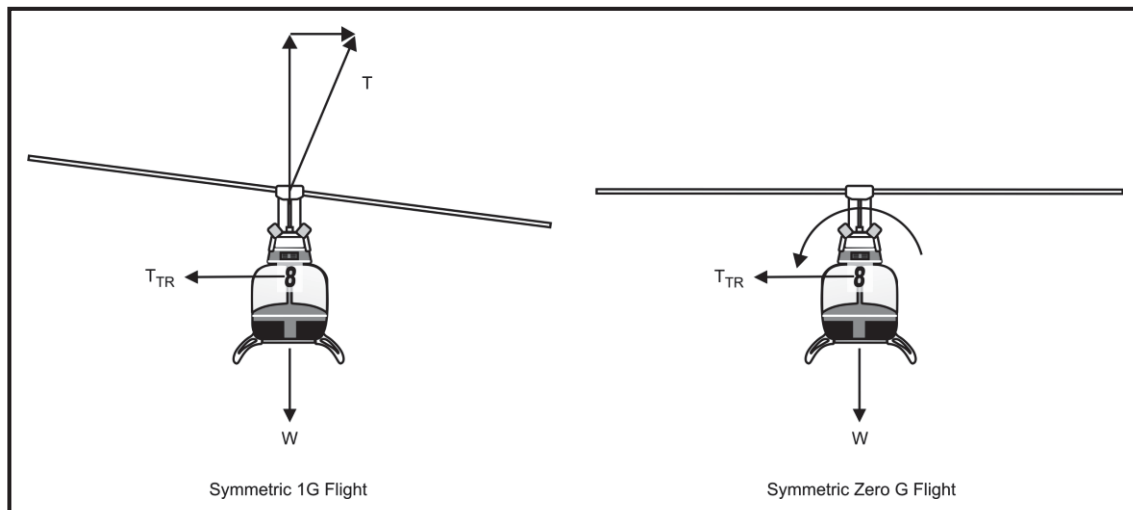

Figure 12-17 Thrust Vector Tilt

When the helicopter is put into a turn with a reduction in collective, a situation like that in Figure 12-17 develops. Note that rotor thrust is tilted slightly left so that the horizontal component of main rotor thrust will balance the tail rotor thrust and provide for lateral equilibrium. The pilot has induced a condition of near zero thrust by reducing collective in conjunction with relatively rapid forward cyclic application. Consequently, with no force to balance tail rotor thrust, left yaw, right sideslip, and most importantly right roll result even though lateral cyclic remains neutralized.

As the roll accelerates, the tip path lags the fuselage rolling motion slightly, depending on the roll rate and other design characteristics of the rotor. This results in a condition in which the clearance between rotor and shaft is reduced. They are no longer perpendicular.

The clearance reduction in the turn is minor, however, and will not in itself lead to mast bumping. But recall that the aircraft is continuing to roll to the right, despite neutral lateral stick. Instinctively, the pilot would counter with left cyclic in order to stop the right roll. Response to the left lateral control will cause upward flapping on the advancing (starboard) side of the rotor disk, thereby further decreasing the clearance between the rotor head and the mast on the retreating (port) side. Such an input to a **loaded** rotor would tilt the thrust vector opposite the direction of the roll, thereby creating a moment tending to return the aircraft to the proper roll attitude. In the zero (or low) G condition, however, rotor thrust is virtually nonexistent and no restoring moment results from tip path tilt. The unwary pilot, with the instinctive left lateral input, would quickly cause the rotor to contact the mast. The torsional driving load, in conjunction with bending loads due to this contact, could then cause a mast failure.

The best action to prevent mast bumping is to avoid the low/zero G condition. If a pilot inadvertently does fly in a low-G condition, however, the following corrective action is recommended:

The first concern must be restoration of the thrust vector, i.e., reload the rotor. Once rotor thrust is restored, the pilot will again regain normal attitude control through the use of cyclic pitch. While both aft cyclic and collective inputs will restore rotor thrust, collective application will also change engine power output. Extensive contractor flight tests with a production model gunship have indicated the possibility of rotor underspeeds or gearbox overtorques (depending on altitude) when utilizing collective to recover from low-G roll. Yaw trim difficulties were also found likely. Aft cyclic application, however, was found to quickly restore control power and decrease right roll rate. Since this method was found not to cause any of the disadvantages of the collective recovery, aft cyclic is considered the best method of thrust restoration. Once thrust is regenerated in this manner, left lateral cyclic may be used in roll recovery.

1211. VIBRATION ANALYSIS

Everything from your eyeballs to your aircraft has a natural frequency (ω_n). This natural frequency is determined by the components' mass and stiffness and is normally modeled as a spring mass system in various modes of bending, and torsion.

$$\omega_n = \frac{\sqrt{\text{Stiffness}(\text{lbs}/\text{ft})}}{\sqrt{\text{Mass}(\text{lbsec}^2/\text{ft})}} = \sqrt{k/m}$$

Nodes are points where no motion occurs. As such, a node is a good place to suspend the rotor system or locate crew or passenger seats for maximum comfort and minimum vibration.

The main source of vibrations for helicopters comes from the main rotor system. Vibrations referred to as 1P, 2P, and 3P vibs are equal to the main rotor rotating frequency or multiples of that frequency (vibrations per revolution). The frequency of the main rotor is a function of the speed at which it rotates in revolutions per minute (Figure 12-18). Multiplying the frequency (in rad/sec) by the rotor blade radius (in feet) yields the speed at which the rotor blade tips travel in feet per second. For example: the CH-46E rotor turns at approximately 264 revolutions per minute. Multiplying 264 by 2π and dividing that number by 60 gives the frequency of one cycle as 27.64 rad/sec or 27.64 Hz. This is the frequency that the main rotor drives the rest of the fuselage with, and if any component has a natural frequency equal to this or a multiple of this frequency, that component will get into resonance when the rotor is turning at 100% N_r . The speed of the blade tips on the same CH-46E would be 27.64 x 25.5 or 705 fps.

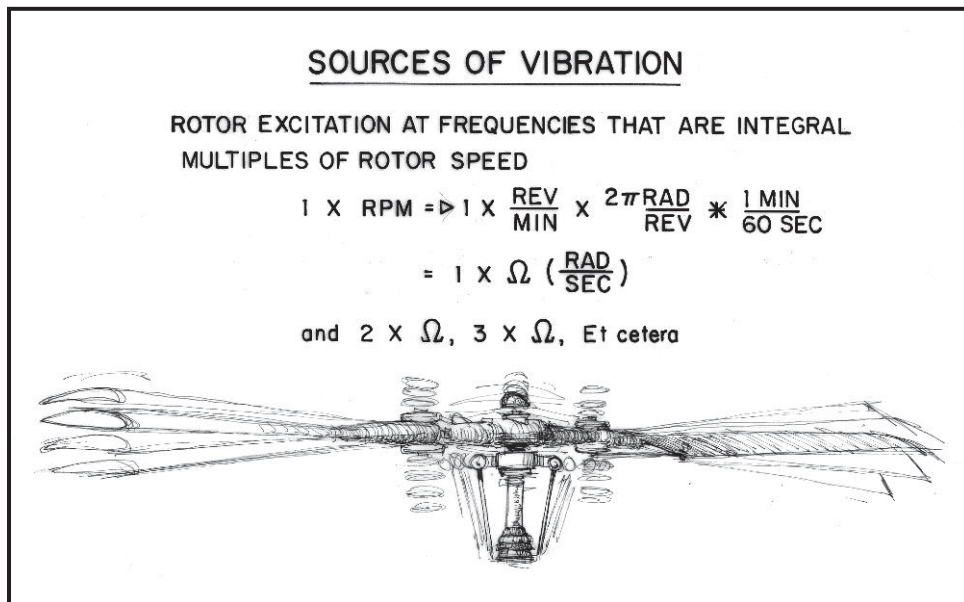

Figure 12-18 Main Rotor Rotating Frequency

Figure 12-19, Vibration Analysis, provides a quick reference for basic analysis of vibrations typically felt in the cockpit while flying. The number or beats of vibration related to the main rotor blades can vary depending on the number of rotor blades installed, i.e., on an H-53E with seven blades, several blades could be out of track rather than just one.

CATEGORY	INDICATIONS	CAUSE
LOW FREQUENCY (most common)	1:1 LATERAL 1:1 VERTICAL	MRB out of balance MRB out of track
	2:1	Inherent in two-bladed helicopter. Increase indicates worn rotating control part of rotor hub part.
MEDIUM FREQUENCY	4:1 TO 6:1	Change in A/C ability to absorb normal vibrations. Loose component (landing gear most common), loose cargo etc.
HIGH FREQUENCY	TOO FAST TO COUNT BUZZ IN PEDALS	Anything that rotates or vibrates at the speed of the tail rotor (transmission, engine, driveshaft).

Figure 12-19 Vibration Analysis

Tail shake. A problem that is usually worse in autorotation than in other flight conditions is “tail shake.” This has been a significant problem on the prototypes of a number of helicopter designs during their first test flights.

It is usually traced to unsteady airflow that arises at the main-rotor pylon or at the rotor hub, and reaches the position of the tailrotor or empennage surfaces with high turbulence. If the frequency of the turbulence happens to match one of the empennage’s natural frequencies, the resulting resonance causes vibrations that can be felt throughout the entire helicopter.

The usual cure for this is to install special pylon fairings that act as low aspect ratio wings. These produce tip vortices that tend to organize the flow and lower the turbulence downstream. The unsteady flow from the hub can be suppressed by the installation of a round cap or “beanie” that also produces vortices. Neither of these fixes should be done unless flight test results show that they are necessary, since both add weight and drag to the helicopter.

Sometimes even these changes are not sufficient and it is necessary to avoid resonance by adding weights which lower the natural frequencies of the vertical or horizontal stabilizer structure, or raise the natural frequency with structural stiffening.

Other sources of vibrations due to external loads or airflows through the rotor system can also cause excitement of component natural frequencies. The vibration caused by an oscillating external load has at numerous times forced aircrew to pickle the load or, in a worse case, caused the crash of an Israeli CH-53D that killed several personnel on board.

1212. HELICOPTER VIBRATIONS BY RAY PROUTY

This section is an excerpt by renowned helicopter aerodynamicist Ray Prouty, which was copied from Rotary Wing Aerodynamics for Naval Aviators, published by the Naval School of Aviation Safety. It reinforces some of the aforementioned topics and goes into some detail regarding other vibrations in our helicopters.

Helicopter Vibration

by
Ray Prouty

Of course your helicopter shakes! The reason for this dogmatic statement is that most of the time the rotor is going through the air in an unnatural state - edgewise - and the blades are subjected to rapidly varying aerodynamic environments during each revolution. The use of flapping hinges, lead-lag hinges, and cyclic pitch tend to cancel out the big effects of this unsteady situation but smaller disturbances still come through as periodically varying forces and moments applied to the structure holding the blade to the hub. In addition, the top of the fuselage and the empennage may get slapped by the downwash from each passing blade.

A big job of the designer is to find ways to minimize the effects of these various oscillating forces and moments on the rest of the helicopter - especially wherever a person or a piece of sensitive equipment is located.

Safety in numbers. One of the most effective ways to minimize vibration is to use as many blades as possible. This cuts down on the effect of an individual blade and allows an up-force from one blade to be played off against a down-force from another to smooth out the net oscillations coming down to the rotor support structure. Presumably, an infinite number of perfectly matched blades could be used to produce a rock-steady set of forces and moments just as a wing does for an airplane. For the same type of construction, each blade costs about the same to build, whether it is for a two or ten bladed rotor. So, the designer who tries to achieve a smooth-riding helicopter with many blades must also consider the economics of his choice.

Facing the hard facts of life and having chosen a finite number of blades for his rotor, he still has several things he can do to minimize the less-than-optimum results of his choice. One of the most obvious is to try to make all of his blades as nearly identical as possible in contour, weight distribution, and stiffness (identical lead-lag dampers are also important.)

Avoiding trouble. The next step is designing to avoid resonances. This applies to both the blades and airframe components - and is easier said than done. Each part of the helicopter has a certain unique natural frequency just as each string of a piano has its own natural frequency that determines its pitch. If any component (blade, fuselage, tailboom, empennage surface, seat, instrument panel, window, etc.) is continuously shaken at or near its natural frequency, it will respond, rattle, or bounce at high amplitude. (It only takes a few pounds of force to push a child high in a swing when the force is applied at the swing's natural frequency.)

A blade with a flapping hinge is in, or near, resonance with the aerodynamic forces that occur once per revolution. This type of resonance is acceptable, since it is self-curing by a process in which any big flapping motions reduce the aerodynamic imbalances that caused them in the first place. The same thing cannot be said about other potential resonance conditions that a blade might encounter.

If you hit a blade with a hammer (soft, of course), you can make it “ring” at its various natural frequencies - depending upon whether your blow excites flap-wise bending, chord-wise bending, or torsion. Figure 12-20 shows possible mode shapes for these various responses.

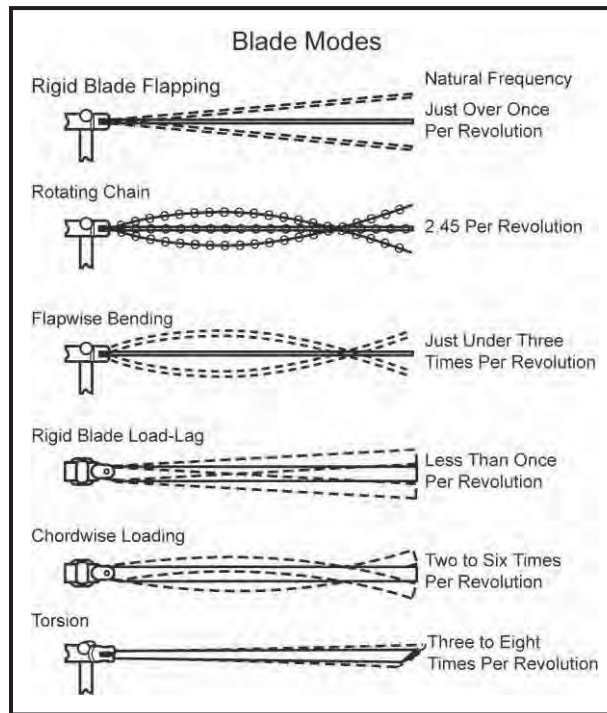

Figure 12-20 Blade Modes

No matter how much flap-wise stiffness the blade has when it is standing still, it acts much like a chain when it is up to speed. If you whirl a chain around your head and someone raps it with a stick, the chain will oscillate at its centrifugal-force-governed natural frequency which is just under 2 1/4 times per revolution with the mode shape shown in Figure 12-20. The corresponding flap-wise bending mode of a rotating blade is nearer three per rev, due to its structural stiffness. Since there are some aerodynamic excitations that peak three times per revolution in forward flight, most rotor blades are used to being in flap-wise resonance at “3P” and therefore respond at fairly high amplitudes.

Figure 12-21 is a plot of the most important natural frequencies of a typical blade as affected by rotor speed. Whenever a natural frequency crosses one of the lines representing a rotor-speed ratio, there is a possibility of a resonant condition, provided that there are sufficient aerodynamic forces at that frequency to get it going. In forward flight, the aerodynamics repeat themselves every revolution but contain peaks and valleys that correspond not only to 1P but also to multiples of rotor speed as high as you can imagine (although it is the lower ones that contain the most energy).

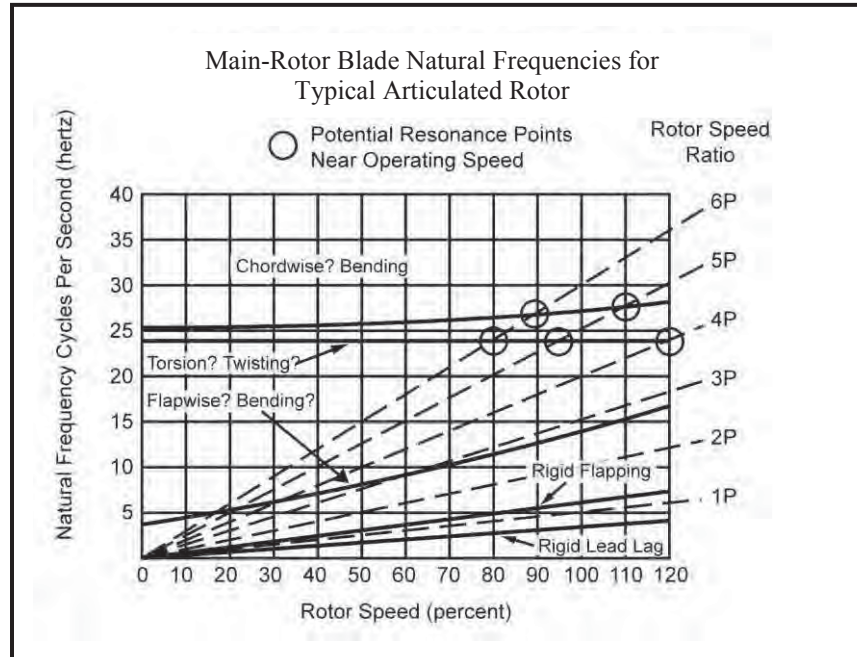

Figure 12-21 M/R Frequencies

The rotor in Figure 12-21 is in fairly good shape at 100% rpm but could get rough at 79, 89, 96, 110, and 119%. This is similar to a reciprocating engine that usually has one or more rpm to avoid because it runs rough there.

Blade resonance not only leads to high vibrations in the airframe but also to high blade stresses. For this reason, as much care must be taken in designing a tail-rotor blade as a main-rotor blade. The designer does have some control over natural frequencies by judicious selection of local weight and stiffness modifications.

Fuselage response. Whether in resonance or not, the blades will transmit some oscillatory loads to the fuselage. One of the most common is at 1P and is caused by a rotor that is out of balance or out of track. Another oscillatory load comes down the shaft at a frequency corresponding to the number of blades per revolution. Helicopters with three-bladed rotors are especially sensitive to this since the blades are near resonance at 3P and thus go up and down in unison to put a plunging force into the rotor shaft.

Other oscillatory loads associated with blade flapping and lead-lag motion are sensed at the fuselage at frequencies corresponding to the number of blades plus one and the number of blades minus one. The main rotor is not the only possible source of vibration since the tail rotor, unbalanced cooling fans, and out-of-balance drive shafts can also be sources of trouble.

Resonances in the airframe components at the various excitation frequencies are fairly common when a helicopter first flies. It is not yet possible for the dynamicist to successfully guide the designer in his placement of stiffness and weight elements to obtain an absence of the coincidence of structural natural frequencies with frequencies of possible exciting forces. The

late Bob Wagner used to give guidance to the designers by telling them to design everything **in** resonance as a way of ensuring that everything would be **out** of resonance when it was built. If this design philosophy doesn't work, local stiffening (or softening) or redistribution of fixed weights might have to be used.

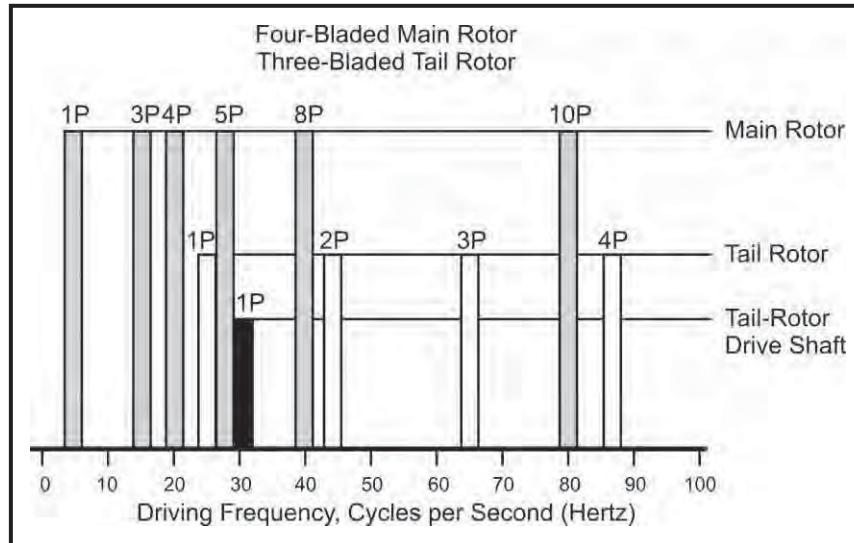

Figure 12-22 Driving Frequencies

Avoiding all of the troublesome frequencies is like trying to throw rocks through the gaps in a picket fence. Figure 12-22 shows a typical batch of frequencies that could produce high vibration.

In some cases, a resonance might exist but not be much of a problem. For example, a fuselage may be primarily excited by a rotor to bend vertically in a hump-backed mode (Figure 12-23). Two points known as “nodes” do not move. If the only seats are on or close to a node, then the crew or passengers will experience a smooth flight even though parts of the fuselage behind and ahead of them may be getting a rougher ride.

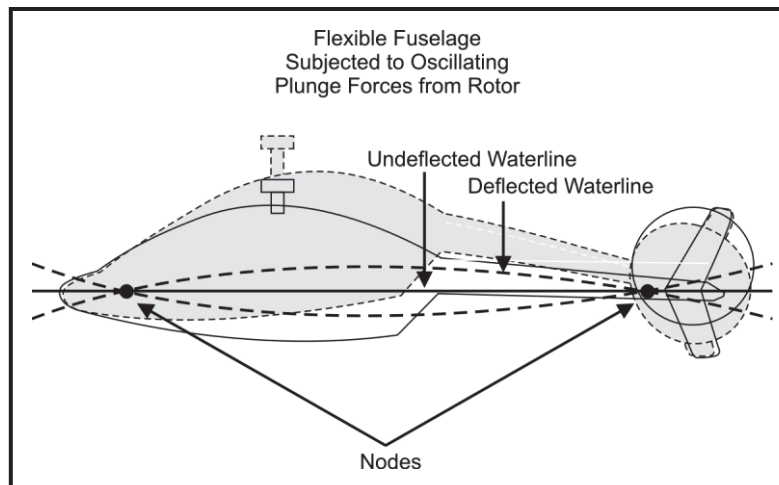

Figure 12-23 Oscillating Plunge Forces Trying to Tame the Rotor

In some cases it is possible to stop or at least reduce the oscillatory rotor loads in place. One approach is to use a vibration absorber mounted on the rotor head. One of the most familiar is the “bifilar” absorber used on some Sikorsky helicopters. These consist of hinged weights designed to swing on their pivots in the right way to eliminate oscillating inputs. Something similar is used on automatic washing machines to balance the basket during the high-speed spin cycle.

Some designers, with stars in their eyes, are now working on systems to wobble the swashplate in such a manner as to smooth out the unsteady aerodynamics at the blade. These systems, which are generically called “higher harmonic control systems,” have shown some promising trends in wind-tunnel tests. Yet another way is to install the rotor and its support system on soft mounts that pass steady loads but inhibit vibrating loads. Such systems have to be tailored to the troubling frequencies and, since there may be more than one, the design is usually a compromise.

Passive vibration absorbers. In some helicopters, resonance is used to solve a vibration problem. This is done by installing in the fuselage a mechanism in which a spring-mounted weight is deliberately tuned to be in resonance with the troublesome rotor frequency. If the design is right, the weight, as it shakes up and down, will put back into its support structure an oscillating force that is equal and opposite to whatever is causing the shake. This is an old technique first developed to minimize the vibration of high-speed steam turbines as they became unbalanced in service.

A vibration absorber is like the portrait of Dorian Gray. Out of sight in a closed box, it absorbs all the bad stuff while the rest of the helicopter flies calmly along.

If the designer is clever, he may not have to use extra weights for his vibration absorbers. Sikorsky used batteries and Bell developed the NodaMatic system that allows some models to use the transmission as the moving weight.

Roughness in the landing flare. A takeoff is usually smooth but a landing through the same speed regime is almost always rough. The reason for this difference is that, in a typical landing approach, the blade-tip vortices will initially be going up from the rotor due to the rate of descent but when the helicopter comes to a hover, the vortices must be going down. Thus, at some point, during the landing, the tip vortices will be in the plane of the rotor where they will be struck by each blade in turn. Each vortex acts as a small but powerful whirlwind and causes abrupt changes in the local AOA as the blades pass over, under, and through them. It is no wonder then that this “rocky road” makes the rotor impart high oscillatory loads down the shaft, until the helicopter slows to a condition where the tip vortices are blown down free of the rotor.

There is a landing technique that the pilot can use to minimize the shakes. It is primarily aimed at getting the vortices to pass through the rotor quickly at high speed - since there they are spread out more than they will be later. The technique consists of doing a moderate flare at about 50 knots and continuing to a hover with a gentle flat deceleration using collective to hold altitude or if possible to make a slight climb. And, of course, a landing into the wind will produce less shaking than a downwind landing.

After all this discussion, it should come as no surprise to learn that more than half of the problem-solving types in a helicopter engineering organization are employed in trying to give you a smoother ride.

1213. MAINTENANCE / FATIGUE / FAILURE

Controlling Routine Vibrations. Because the main rotor operates periodically, it naturally tends to produce vibrations. If any component is not properly balanced or tracked it will exacerbate the tendency to vibrate, and may produce noticeable, pronounced vibrations at harmonics of the main rotor. Two of the most noticeable and correctable sources are blade imbalance or tracking differences.

A blade that does not travel in the same path as others experiences different aerodynamic forces, and imparts a different force on the blade that follows it. Referred to as an **out-of-track condition**, the result is felt as a **1P vertical** vibration. The correction technique for this aerodynamic problem is an aerodynamic solution: **the blade's trim tab is bent to change the flight path, or the link bearings are adjusted** to change the AOA, which will in turn change the flight path.

A blade that is **out of balance** will displace the CG in the same manner as noted above for ground resonance. The system moves toward the new CG (that due to uneven mass distribution is not at the axis), but by the time it moves the mass has been displaced as the blade moves on. As a result, the entire system wobbles around seeking to center on a moving CG that it cannot catch. This is felt as a **1P lateral vibration**. To correct it **mass is added or removed** from improperly weighted blades.

In addition to the effects of vibration, stress and strain also result from normal and excessive loads. A **load** is a stress-producing force that is imposed upon an aircraft or component. **Strength** is a measure of a material or component's resistance to load. There are two types of strength: Static strength and fatigue strength. **Static strength** is a measure of a material's resistance to a single application of a steadily increasing load or force. When the static strength of a component has been exceeded, static failure occurs. **Static failure** is the breaking (or serious permanent deformation) of a material due to a single application of a steadily increasing load or force. Essentially, failure occurs when the material or component stops resisting the load. For instance, a pencil breaks when too much force is applied and its static strength is exceeded. Once broken, there is no more resistance to the force being placed on the two broken halves.

Fatigue strength. Fatigue strength is a measure of a material's ability to withstand a cyclic application of load or force, i.e., numerous small applications of a small force over a long period of time. Each application of force may not even cause the material to noticeably deform or bend, but that force will cause microscopic damage to the component in the form of a tiny crack. The next time the force is applied, the damage gets worse and the crack gets bigger. Eventually, the crack will grow large enough that the next application of that small force will cause the component to break apart. **Fatigue failure** is the breaking (or serious permanent deformation) of a material due to a cyclic application of load or force.

Breaking a wire coat hanger by bending it back and forth demonstrates an extreme form of fatigue failure. Typical fatigue failure will occur without any outwardly visible bending or damage until the failure actually occurs. Aircraft may experience fatigue failure on many components. Aircraft components are designed to withstand repeated loads, but not forever.

Service life is the number of applications of load or force that a component can withstand before it has the probability of failing. Fatigue strength plays a major role in determining service life. Service life may apply to an individual component or to the entire airframe, and is typically expressed in hours of operation.

The structural limits of an airplane are primarily due to the metal skeleton or airframe. **For a helicopter, the main and tail rotor systems provide a constant source of vibration that compounds the problems normally experienced by airplanes.** Airframe components determine the maximum load that the aircraft can withstand. The two greatest loads on an airplane are lift and weight. Since weight doesn't vary greatly from one moment to the next, lift will be the force that causes the maximum load to be exceeded for an airplane. **Due to rotational forces, a helicopter rotor system experiences a load many times greater than the aircraft weight.**

Structural considerations determined by the aircraft's mission and desired service life force a manufacturer to meet certain limits, such as maximum load factor, airspeed and maneuvering limitations. These design limits include the limit load factor, ultimate load factor, redline airspeed, and maneuvering parameters.

Limit load factor. Limit load factor is the greatest load factor an aircraft can **sustain** without risk of permanent deformation. It is the maximum load factor anticipated in normal daily operations. If the limit load factor is exceeded, some structural damage or permanent deformation **may** occur. Aircraft will have both positive and negative limit load factors.

Overstress/Over-G. Overstress/Over-G is the condition of possible permanent deformation or damage that results from exceeding the limit load factor. This type of damage will reduce the service life of the airplane because it weakens the airplane's basic structure. Overstress/over-G accelerates fatigue failure of components, and may occur without visibly damaging the airframe. Inside the aircraft are a variety of components, such as hydraulic actuators and engine mounts, which may not be designed to withstand the same loads that the airframe can. Before the airframe experiences static failure these components may break if overstressed. The wing (rotor system) may not depart the aircraft if the limit load factor is exceeded, but if an engine mount breaks, a fire could result from fuel spewing on hot engine casing. Any time an aircraft experiences an overstress, maintenance personnel must inspect it to determine if damage or permanent deformation actually occurred. **Always report an overstress to maintenance.**

Whether or not deformation or damage occurs depends on the elastic limit of the individual components. If a rigid metal object is subjected to a steadily increasing load, it will bend or twist. When the load is removed, one of two things may happen. If the component returns to its original shape, the bending or twisting is called elastic deformation. If the component was stressed heavily enough and stays in its new, bent or twisted shape, it is considered plastic deformation.

The **elastic limit** is the maximum load that may be applied to a component without permanent deformation. When a component is stressed beyond the elastic limit and experiences some permanent deformation, it may still be usable. If the force continues to increase, however, the component will break. To ensure that the aircraft may operate at its limit load factor without permanent deformation, the limit load factor is designed to be less than the elastic limit of individual components. This virtually guarantees the aircraft will reach its expected service life.

Ultimate load factor. Ultimate load factor is the maximum load factor that the aircraft can withstand without structural failure. There **will be some permanent deformation at the ultimate load factor**, but no actual failure of the major load-carrying components should occur. **If you exceed the ultimate load factor, structural failure is imminent** (something major on the aircraft **will** break). The ultimate load factor should be avoided since the typical aircraft is rather difficult to fly after its wings, whether fixed or rotary, tear off. The ultimate load factor is 150% of the limit load factor.

1214. GROUND RESONANCE

Resonance occurs when the natural frequency is some multiple (harmonic) of an outside forced frequency. Outside forcing frequencies include, but are not limited to:

1. PIO/PAO - pilot induced oscillation or pilot assisted oscillation through control inputs at some aircraft excitable natural frequency.
2. "Black Box" (AFCS) - electrical control inputs at a resonant frequency
3. Wind gusts at a multiple of the airframe's natural frequency.
4. Improper component damping.

Some helicopter designs are subject to sympathetic and ground resonance.

Sympathetic Resonance. This occurs when the harmonic beat between the main and tail-rotor systems and other components or assemblies interact at one of the components' natural frequency. Resulting resonance could damage the helicopter, but this type of resonance is not usually a problem because most helicopters have been designed so that the main and tail gearboxes' operating frequencies are in odd decimal ratios. The beat of one component (assembly) cannot-under normal conditions-harmonize with the beat of another component. Sympathetic resonance is thus not normally of immediate concern to the aviator.

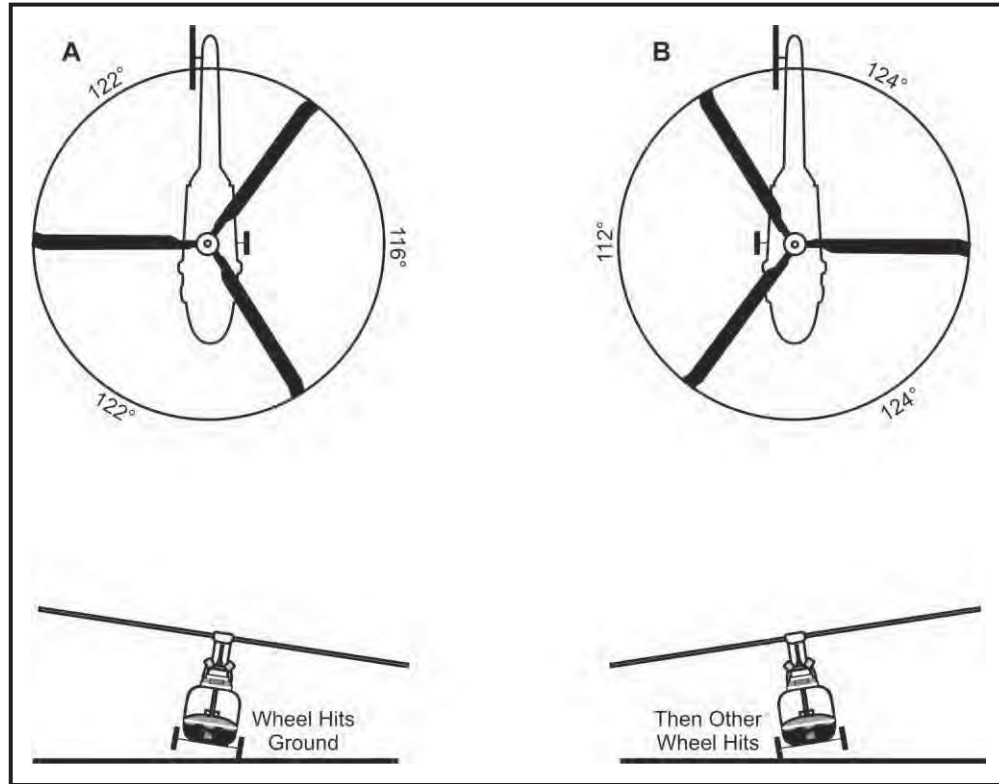

Figure 12-24 Rotor System Out of Balance

Ground Resonance. Ground resonance may develop in helicopters having fully articulated rotor systems when something causes the rotor system to become unbalanced. If this oscillating condition progresses, it can be self-energizing and extremely dangerous. Structural failure usually results. Ground resonance is most common in three-bladed helicopters with tricycle type landing gear. The rotor blades in a three-bladed helicopter are equally spaced (120°), but are constructed to allow some horizontal lead and lag action. Ground resonance occurs when the helicopter contacts the ground during landing or takeoff (Figure 12-24). If one wheel of the helicopter strikes the ground ahead of the others, a shock is transmitted through the fuselage to the rotor. Another shock is transmitted when the next wheel hits. The first shock from ground contact (Figure 12-24), causes the blades straddling the contact point to jolt out of angular balance. If repeated by the next contact (Figure 12-24), ground resonance is established. This sets up a self-energizing oscillation of the fuselage. The oscillation severity increases rapidly and the helicopter may disintegrate unless one of the following immediate corrections is made.

1. Take off to a hover if the rotor rpm is in the normal range. A change of rotor rpm may also aid in breaking the oscillation.
2. Reduce power if the rotor rpm is below the normal range. Use of a rotor brake may also aid in breaking the oscillation.

In the Navy and Marine Corps inventory, H-46 aircraft are more prone to air/ground resonance than other helicopter types (Figure 12-25). This is because H-46 rotor configuration matches the profile described above. The H-46 has a fully articulated rotor system with lead-lag hinges which normally keep the blades equally spaced and "balanced" about the center of rotation. This lead-lag motion makes the system "soft-in-plane" which means that the blades can be forced out of the balanced condition (due to improper damper servicing, hard landings, etc.) causing tremendous vibrations like an out-of-balance automobile tire. If one blade is out of alignment in a five- or six-bladed system, the balance upset is not as great. However, in a three-bladed system, if one blade is not aligned properly there is a lot of vibration (different rotor frequencies) while the blades attempt to sort themselves out. For instance, after shutdown the blades are usually displaced from their 120° equilibrium spacing, so that during the subsequent turn-up, as centrifugal force builds and the blades seek their equilibrium position of 120° apart, a wide range of frequencies is traversed by the rotor system (Figure 12-26). These are fed to the fuselage (as H-46 crews can attest), and if improper landing gear damping is present, ground resonance may occur.

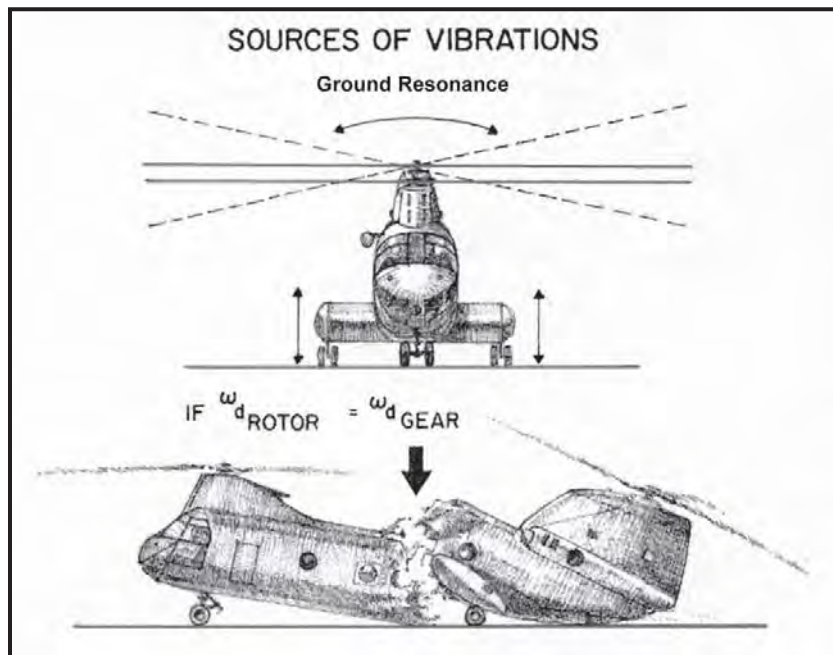

Figure 12-25 H-46 in Ground Resonance

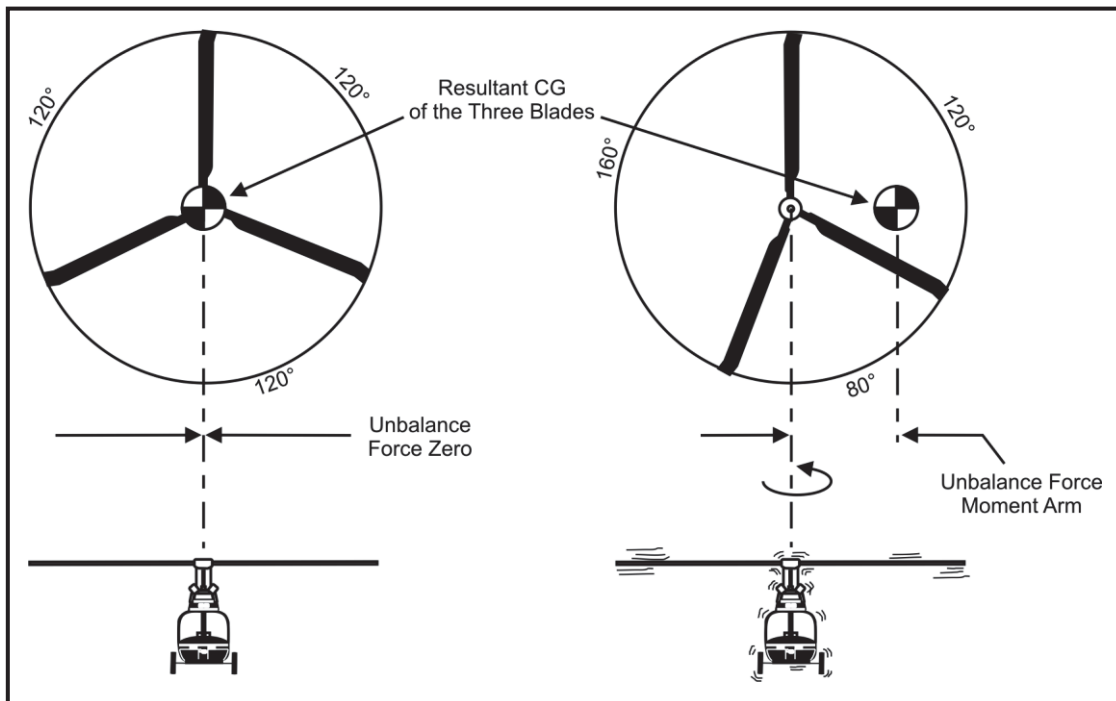

Figure 12-26 H-46 with Blade Pattern Imbalance

Conditions contributing to ground resonance - if the aircraft is not in contact with the ground there can be no “ground resonance.”

1. Rotor run up - numerous frequencies are excited as the rotor system is run up, therefore it is desired to traverse these as rapidly as possible and operate at an rpm not associated with any airframe natural frequency.
2. Light/Hard Landing - the designed damping from oleo struts and tire inflation is negated.
3. Bouncing on Landing Gear - sets up an undesirable vibration.
4. Running Landing over rough surface - sets up an undesirable vibration.
5. Shipboard Inertial Motion - sets up pitching/rolling oscillations.
6. Cargo excitation due to vehicle tires bouncing, loose cargo tiedowns etc.
7. Rotor blade flapping causes some mass imbalance.

Maintenance Factors contributing to ground resonance.

1. Improper landing gear servicing-tire inflation, oleo struts cannot provide the designed damping.
2. Improper lead-lag damper servicing-blades cannot sort themselves out if upset to an out-of-alignment condition.
3. Improper tiedown procedures-secure aircraft with a tiedown on the stub wing above the oleo strut, thereby compressing it and not allowing free travel for designed damping during start-up.
4. Defective AFCS black boxes - provide erroneous flight control inputs.

Corrective Action.

1. Rotor run up - Secure engines, apply rotor brake, apply wheel brakes to stop bouncing and rolling.
2. Landing - Get airborne, or select smoother touchdown point.

How the Engineers Design Around It. Every helicopter design is examined closely for natural and forcing frequencies. In the "old days," manufacturers would test the frequency stability of a helo by tying the aircraft down to the floor, run it at 100%, and have a pilot shake the cyclic and rudder pedals at various frequencies to see if resonance would occur. With the increased use of computers, these frequencies are now found using NASTRAN and follow-on programs, where the various resonant frequencies are found in the computer and then verified in flight test.

1215. DYNAMIC ROLLOVER

Dynamic rollover is the rotation of a rotorcraft as **it pivots about a point on the ground to which it is fixed until it exceeds a critical angle and rolls over.** The following terms must be understood before discussing the conditions that lend themselves to a dynamic rollover situation. **The three requirements for dynamic rollover are: pivot point, near lift-off thrust, and a critical roll rate.**

Static rollover angle. Static rollover angle is the angle at which the helicopter would tip over if placed on an incline that was slowly raised. Rollover in this case occurs due to the CG of the aircraft being rolled past the pivot point of the landing gear. The aircraft rolls due simply to slope angle, and could do so with no power applied or momentum in any direction.

Critical rollover angle. Critical rollover angle is the angle of bank beyond which the pilot's control power is insufficient to arrest the angular velocity about a pivot point. This angle varies with roll rate, weight, angular momentum, and thrust. An aircraft achieves critical rollover angle as a result of motion and momentum.

Lateral control limit. Lateral control limit is the angle that the rotor disk makes with the mast when the cyclic is displaced full throw either to the left or the right, usually limited by static stops. The lateral control limit determines the maximum amount of cyclic, hence tip path plane, displacement from a straight and level attitude. If the cyclic is displaced full throw to the left or right and maximum collective (torque) is applied, the aircraft will demonstrate its maximum control moment or control power about the roll axis. The same can be said about the pitch axis.

Control Power. Control Power is the effectiveness of the cyclic control in achieving changes in fuselage attitude. Control power has units of moment (foot-pound), time (second), and angular distance ($^{\circ}$). The moment is the main rotor thrust multiplied by the perpendicular distance to the CG, the angle is a measure of how far the fuselage moves under the control moment, and the time is a measure of how long the movement takes.

Moment of Inertia. Moment of Inertia is an object's resistance to change in angular momentum. It is based upon how the mass of the object (a helicopter in the case considered here) is distributed about three axes that extend from the CG (Figure 12-27).

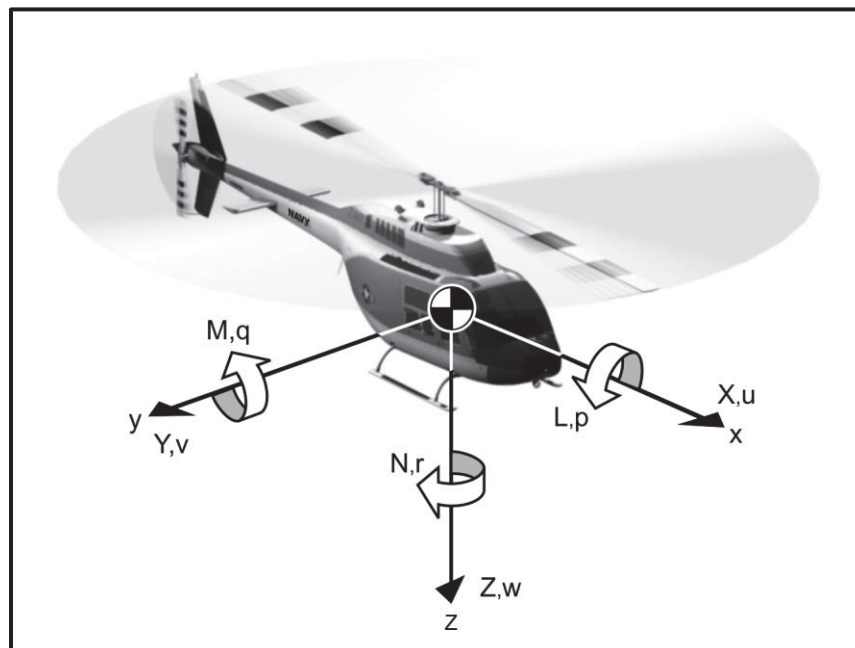

Figure 12-27 Forces and Moments About a Helicopter CG

Moment of Inertia is equal to $I = \sum m r^2$, or the sum of mass (m) times distance from the CG (r) squared for every item either installed or loaded on the aircraft.

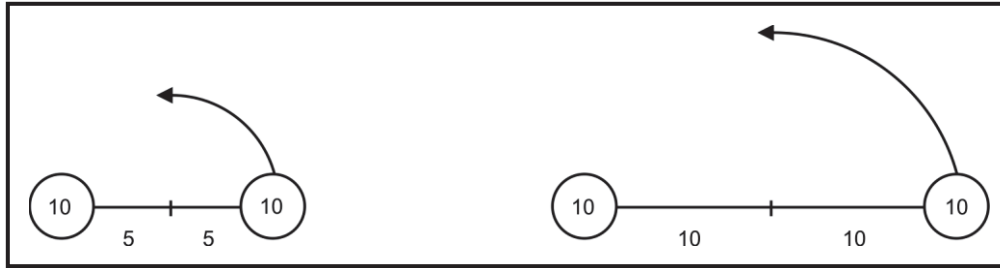

Figure 12-28 Moment of Inertia Example

The way mass is distributed affects moment of inertia because objects with mass that is further spread out from the center of rotation are harder to accelerate or decelerate. For example, Figure 12-28.

The left system has a moment of inertia about the center of:

$$(10 \times 5^2) + (10 \times 5^2) = 500$$

The right system has a moment of inertia about the center of:

$$(10 \times 10^2) + (10 \times 10^2) = 2000$$

The two systems have the same mass but moment of inertia on the right is much greater. This is why items that are supposed to rotate at a constant rate, like a flywheel, have mass concentrated as far away from the center as possible.

Likewise, the moment of inertia changes with a change in rotation point. If we rotated system B around the mass on its left end, the moment of inertia would be:

$$(10 \times 0^2) + (10 \times 20^2) = 4000$$

The effect of shifting a rotation point is easily found in more complex systems by using the following formula:

$$I = \sum mr^2 + md^2$$

where **d** is the distance from the original pivot to the new pivot point.

Moment of inertia is important because an aircraft's rotational moment of inertia defines its resistance to rotational accelerations, just as an object's **mass** dictates its resistance to linear accelerations.

To overcome inertia and cause acceleration in a **linear** system one applies a **force**, and Newton's second law applies:

$$\text{Force} = \text{Mass} \times \text{Acceleration}$$

In a **rotational** system one overcomes rotational inertia and causes angular acceleration by applying a **moment**:

$$\text{Angular Acceleration} = \text{Moment of Inertia} \times \text{Moment}$$

Once a mass is accelerated, it will tend to maintain its velocity (equilibrium) unless another force acts to slow it down. This is the principle of Conservation of Momentum. In a linear system, momentum equals mass times velocity. In a rotational system, angular momentum equals moment of inertia times angular velocity.

Linear:

$$\text{Momentum} = \text{mass} \times \text{velocity}$$

Rotational:

$$\text{Angular momentum} = \text{moment of inertia} \times \text{angular velocity}$$

Moment of inertia is really important to control if control involves rotation (as it does). In a linear system an object with a great deal of mass (like a loaded truck) requires a good deal of force to get started moving but is hard to stop once it does move. Likewise, in a rotational system an object with a high moment of inertia is hard to start rotating but is hard to stop once it does rotate.

Normal Flight Operations vs. Operations on the Ground. The rotor is designed to create a certain amount of angular acceleration about the CG in normal flight conditions. Cyclic authority is therefore rarely exceeded in flight except for extreme conditions. That is, the designed cyclic authority can overcome angular velocities about the CG created by outside forces. Now, suppose the aircraft is rotating (has angular momentum) about a point other than the CG, such as a skid or a wheel in contact with the ground. The rotational inertia is now measured about that pivot point (away from the CG), so that the **mass moment of inertia** has increased to a value of

$$I = mr^2 + md^2$$

where **d** is the distance from the aircraft CG to the new pivot point. The inertia that the rotor control system must overcome increases dramatically. In fact, in past cases of dynamic rollover, available control authority has been calculated at values of only **20-25 percent** of normal authority.

Dynamic rollover can occur in either direction and on level ground. It depends only upon angular momentum and pivot point.

Conditions for Occurrence. Because dynamic rollover is a result of angular momentum being established at the same time that moment of inertia increases, the conditions for occurrence are pretty straightforward:

1. Pivot about a fixed point on the ground to shift the point of rotation and increase moment of inertia.
2. Approximate liftoff thrust (“light on the gear”) to make momentum easier to establish.
3. Angular velocity developed to establish angular momentum.

Contributing Factors. Certain conditions can make dynamic rollover more likely. Some of these factors follow:

1. **Restraint of a point to the ground.** Anything that anchors a part of the aircraft to the ground can provide a pivot point. Failing to remove tiedowns or chains, hitting an obstruction with the landing gear, or attempting a takeoff with an obstruction next to the gear have all contributed to past mishaps. Mud or a ridged surface can, under the right circumstances, fix the gear just enough to initiate rollover, and in cold weather a wheel or skid can freeze in place.
2. **Operating on a slope.** If the helicopter is allowed to slide, or overcompensation is made in the other direction, a roll can develop. The training attention given to preventing dynamic rollover during slope operations has paid off; slope operations are now involved in only a third of dynamic rollover accidents.
3. **Pilot technique.** Usage of excessive lateral cyclic during takeoff or allowance of ground contact during lateral translations, “jerk” takeoffs, and drift during landing can rapidly develop into dynamic rollover.
4. **Disorientation in whiteout or brownout** can lead to settling, undetected drift, and rotation about a pivot point.
5. **CG shifts** due to fuel distribution or cargo/passenger changes. A CG shift changes the effective moment about the CG and the associated control authority.
6. **Tail-rotor thrust.** Historically, 9 out of 10 dynamic rollover accidents have involved rollover to the right. Many of these accidents might have been avoided if the pilot on the controls had adjusted the cyclic to compensate for tail-rotor thrust (translating tendency), especially while lifting off to a hover.
7. **Main-rotor design.** Aircraft with fully articulated or rigid heads are highly sensitive to lateral cyclic inputs. They have good control authority, and although they can be quick to develop roll rates, the cyclic is also very effective in stopping that roll rate once it’s detected.

Teetering-head helicopters, however, are slow to develop a roll rate, and cyclic inputs alone are unlikely to prevent rollover once a roll rate has developed. United States Army dynamic rollover incident records are overwhelmingly populated by teetering rotor type helicopters.

8. **Crosswinds** acting on the fuselage create a rolling moment that can either oppose or promote rollover.
9. **Main rotor thrust** component always contributes to dynamic rollover. If the helicopter has a pivot point in contact with the ground, the main rotor thrust will form a moment around that fixed point.
10. **Ship motion** translated to a pitching or rolling deck can accelerate roll or take the aircraft to an angle beyond the static rollover angle. Angular accelerations of the deck in the roll axis will virtually always increase the likelihood of rollover. Pitching accelerations which impose loads less than 1 G also increase chances for rollover.

Force and moment interactions. Figure 12-29 shows an example in which several of the above mentioned factors act together to foster dynamic rollover. The momentum shows the aircraft rolling toward the pilot's **left**. The upsetting rolling moment begins the aircraft rolling, and momentum tends to keep it moving in that direction. Lift, multiplied by the distance from the pivot point to the thrust vector, provides a rolling moment that makes the situation worse. The following forces times their distance to the pivot point help the pilot by generating moments that counteract the roll: Tail Rotor Thrust, Wind and Aircraft Weight.

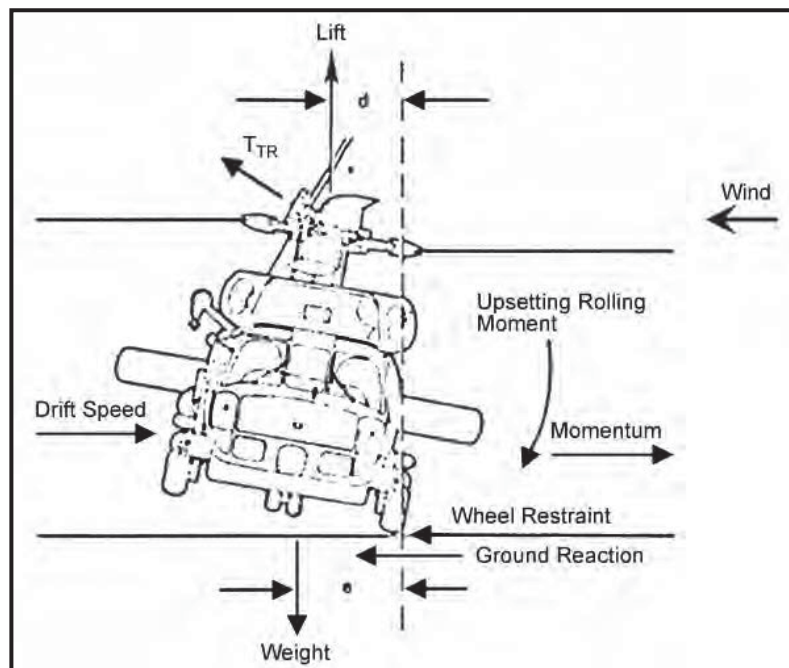

Figure 12-29 Forces Acting on Aircraft During Dynamic Rollover

If the situation was reversed and the aircraft was rolling to the pilot's **right** the following forces and moments would be acting to make the roll worse: main rotor thrust or lift, upsetting rolling moment, momentum, tail rotor thrust and wind effects. In this situation the only force that would be providing a "righting" moment is the aircraft weight.

Weight, unlike any of the other factors in this example, consistently acts in a pilot's favor in counteracting dynamic rollover. Weight is also the most powerful force at the pilot's disposal. Collective reduction imposes a moment against the roll.

As an illustration of the effect of crosswind in ship operations, consider the following incident: A CH-46 was sitting on the deck of an LPH with the rotors turning. Another helicopter launched from a nearby spot on the port side. The CH-46 pilot reported the development of an uncomfortable right rolling motion even though his flight controls were centered. Despite the pilot's best efforts (and a full complement of chains and chocks), the aircraft accelerated in a right roll and fell over the starboard deck edge.

Even in this case, the primary contributor was main rotor thrust. The pilot held the collective in the three-degree detent (standard position at flight idle for the H-46), rather than full down. Figure 12-30 shows the effect of power settings for crosswinds of 5 and 35 knots. Note that a 5-knot wind condition results in a considerably higher rollover moment at the three-degree collective setting than does the 35-knot condition with collective reduced to one degree.

The varying crosswind itself was the source of energy with two effects. First, the increasing crosswind increased the thrust coefficient, thus providing more thrust-generated rollover moment. The increased thrust also caused the tip path to "blow back" or tilt away from the wind, further increasing the likelihood of rollover. A second effect was parasite drag force that pushed on sideward helicopter surfaces. Rolling moment from this source can become quite high at higher wind speeds. In the CH-46 case provided, the downwash (ultimately sidewash) generated by the helicopter departing the adjacent spot **increased the crosswind by nearly 25 knots!**

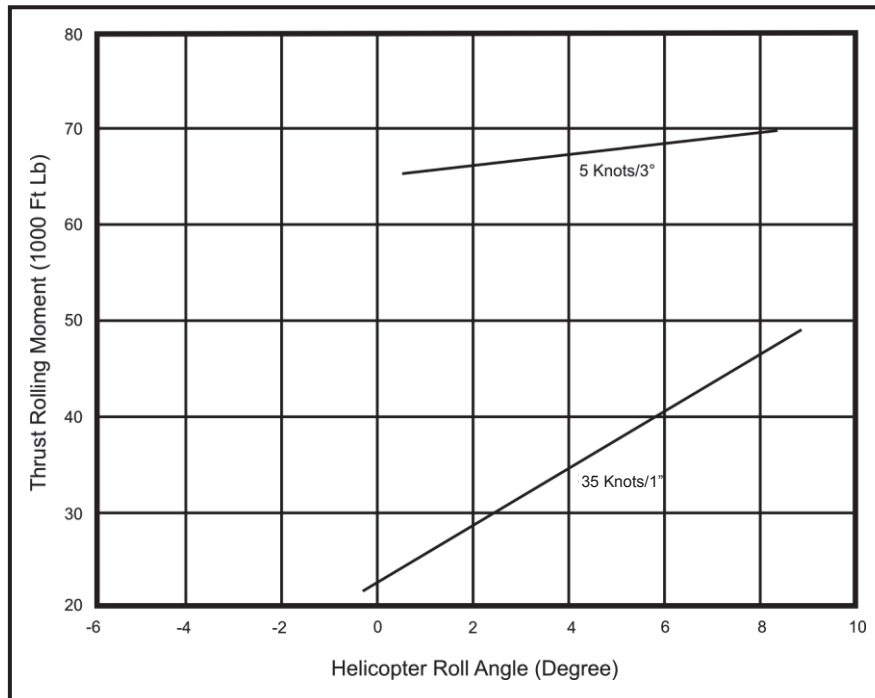

Figure 12-30 Rollover Moment for Varying Crosswinds and Collective Pitch Settings

Of course, deck accelerations and deck surface conditions present a hazard that maritime helicopter pilots routinely encounter. A simple solution is - **chains!** Properly applied, chains can keep the helicopter on its spot and on its feet. **Improperly applied chains are worse than no chains, because they give the illusion of a solution to the problem, while in the end they may be an insidious part of the cause.**

What is a properly applied chain? A **tight** chain is a properly applied chain. (Note that we're talking about a chain pulled taut to an axle tiedown and not to a mooring point located above the landing gear oleo – **a high chain can cause ground resonance.**)

Corrective Action. The one best way to prevent a dynamic rollover situation from becoming catastrophic once it has begun is to use the aircraft's weight:

1. **Smoothly reduce collective** which will eliminate the dominant rolling component and the thrust opposing aircraft weight. **Weight is the only force that will always produce a moment that helps prevent rollover, up until the aircraft reaches its static rollover angle.**
2. Input lateral cyclic opposite to the direction of roll because this reduces the moment arm of the main rotor thrust and also provides a hub moment on articulated and rigid rotors which helps prevent dynamic rollover. Lateral cyclic will not be as effective as collective reduction, but may provide the final margin needed to right the helicopter. Be alert for a potential roll in the opposite direction.

THIS PAGE INTENTIONALLY LEFT BLANK

CHAPTER TWELVE REVIEW QUESTIONS

1. The ratio of rotor thrust plus airframe lift to gross weight is called _____
_____.
2. With a helicopter weight of 3000 lbs, you pull 2 G's. In order to maintain equilibrium flight, you would need to increase / decrease thrust because the aircraft now appears to weigh _____ lbs.
3. In defining the flight envelope, a design consideration is the high loads on _____, _____, and _____ systems.
4. A low-G maneuver may cause mast bumping. _____ (True/False)
5. What other conditions are conducive to mast bumping?

6. When approaching low-G flight, avoid mast bumping by application of _____ cyclic.
7. The most common normal vibrations associated with helicopters are _____ vibrations.
8. A buzz felt on the pedals is most likely associated with vibration originating from the _____.
9. Loose external stores may cause _____ vibrations.
10. Ground resonance is a destructive phenomenon particular to hingeless rotor systems operating near the San Andreas fault. _____ (True/False)
11. _____ and _____ are the essential elements of dynamic rollover.
12. When a dynamic rollover situation is suspected, the best course of action is to _____.
13. With a fully-articulated rotor system, a hard landing may cause excessive downward flexing of the rotor system. This flexing may cause a mishap if the blades contact the _____.
14. A tailboom strike may result from touching down with an excessive _____ attitude.

15. What is the corrective action if you suspect mast bumping is about to occur during a low-G maneuver?
- Smoothly center cyclic and lower collective
 - Smoothly apply aft cyclic and center
 - Smoothly apply left pedal input and center cyclic
 - Smoothly center and apply forward cyclic
16. A _____ frequency vibration is caused by _____
- high ... loose aircraft components
 - medium ... the tail rotor
 - medium ... the drive shaft
 - low ... the main rotor
17. Excessive lateral one to one vibrations are caused by _____
- A loose aircraft component
 - A tail rotor malfunction
 - An engine malfunction
 - An imbalance in the main rotor
18. A destructive vibration occurring in the rotor system when the aircraft is in contact with the ground is
- blade flapping
 - ground effect
 - geometric imbalance
 - ground resonance
19. Which of the following sources may contribute to the rolling tendency during dynamic rollover?
- Flapping
 - Geometric imbalance
 - Tail rotor side force
 - Aft CG

THIS PAGE INTENTIONALLY LEFT BLANK

CHAPTER TWELVE REVIEW ANSWERS

1. load factor
2. increase, 6000 lbs
3. rotor blades, rotor hub, and control systems
4. True
5. Low G flight, rapid cyclic movements, max sideward or rearward flight, slope landings, flight near CG limits
6. aft
7. low frequency
8. tail rotor
9. medium frequency
10. False
11. Sideward force, ground pivot point
12. smoothly lower the collective
13. tailboom
14. nose high
15. b
16. d
17. d
18. d
19. c

CHAPTER THIRTEEN REVIEW

1300. INTRODUCTION

The purpose of this chapter is to review the key concepts that the student should be familiar with before taking the end of course exam.

1301. LESSON TOPIC LEARNING OBJECTIVES

1. Terminal Objective.

Upon completion of the review period, the student will demonstrate knowledge of the basic aerodynamic terms, concepts, and diagrams that are important to an understanding of helicopter aerodynamics.

2. Enabling Objectives.

- a. Be able to explain the terms listed and discuss how they are related.
- b. From memory, be able to draw the blade element diagram, label the components, and explain the relationship between the components.
- c. From memory, be able to draw a power required versus power available chart, label the components, and explain the relationship between the components.
- d. From memory, be able to draw a basic autorotation height velocity diagram, label the parts, and explain why the curves are drawn the way they are and their significance.

1302. STUDY ASSIGNMENT

- Review the previous chapters as necessary to meet the enabling objectives.

1303. REVIEW

Be able to discuss the terms, concepts, and relationships outlined in Figure 13-1. It is recommended that the student be able to draw and label, from memory, Figures 13-2, 13-4, and 13-5. Drawing of the pictures is not required for the examination; however, if you can draw the pictures and understand them, it will be helpful in answering test questions.

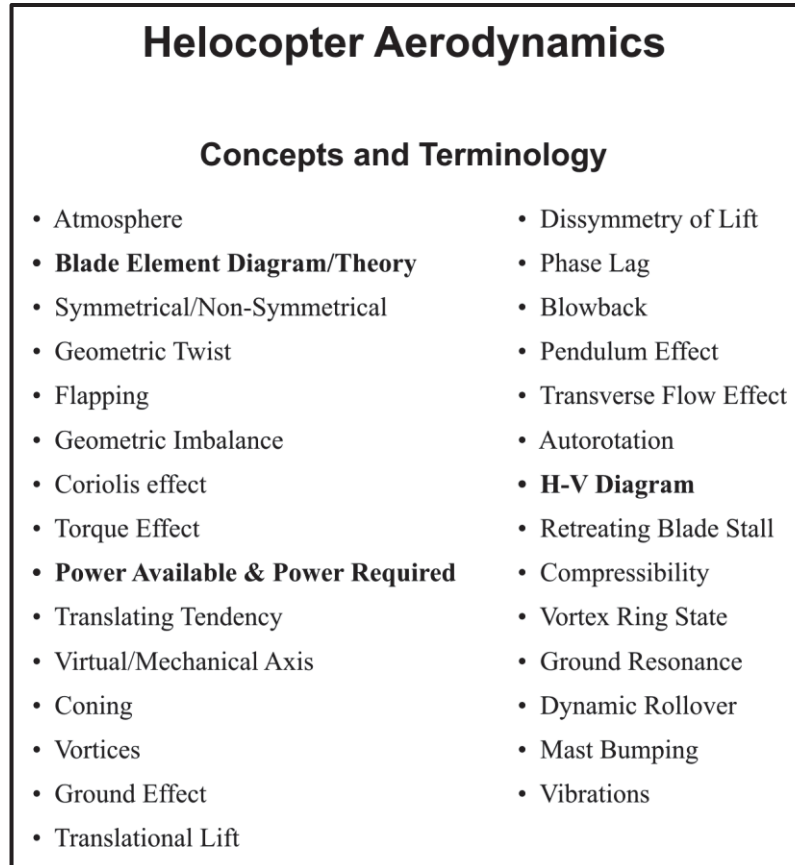

Figure 13-1 Concepts and Terminology

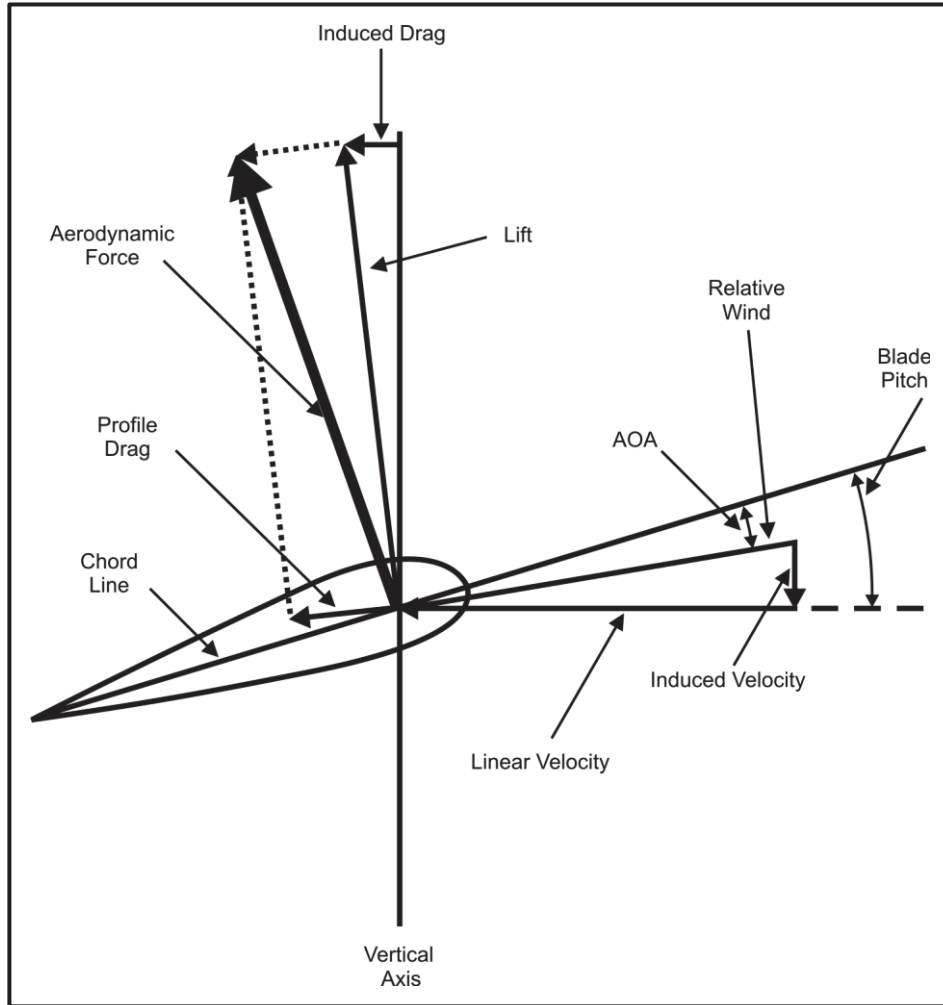

Figure 13-2 Blade Element Diagram

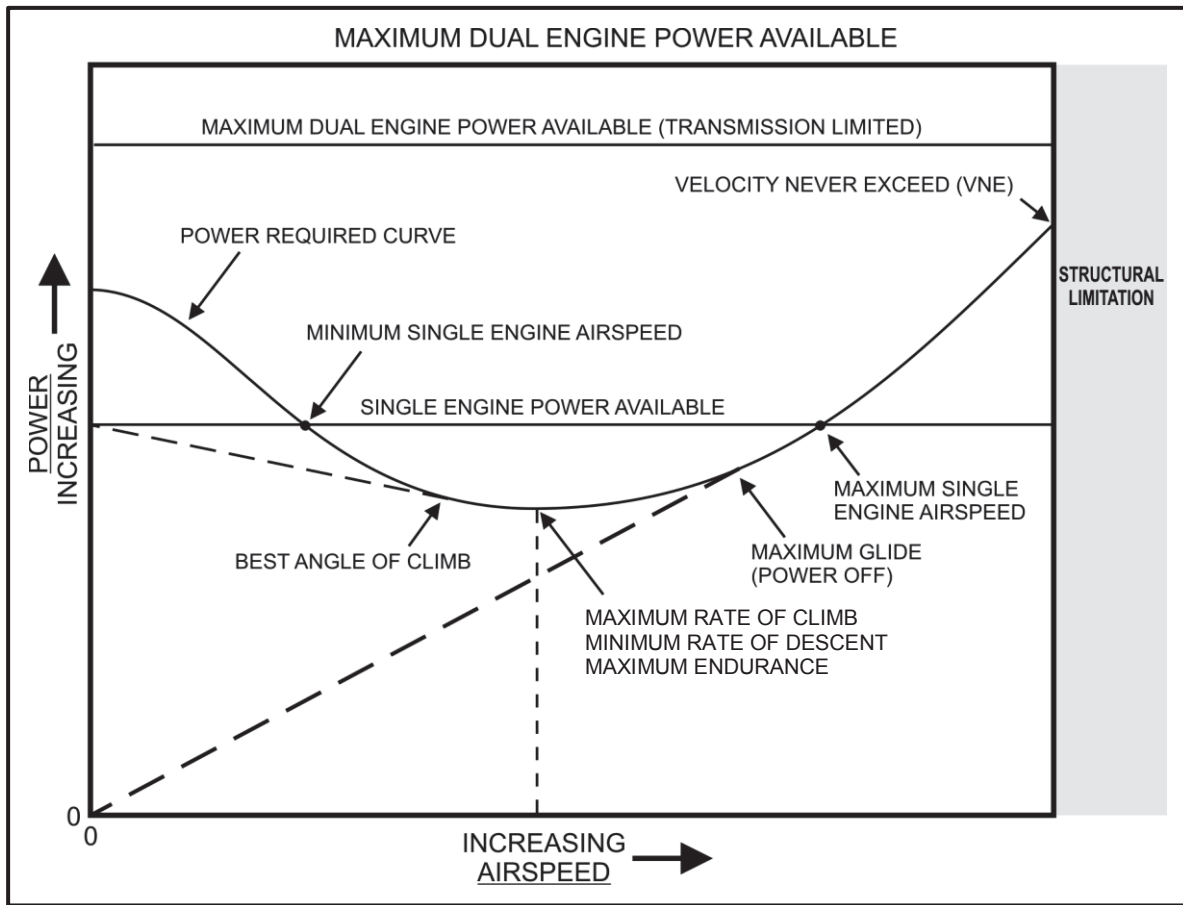

Figure 13-3 Power Required Versus Power Available

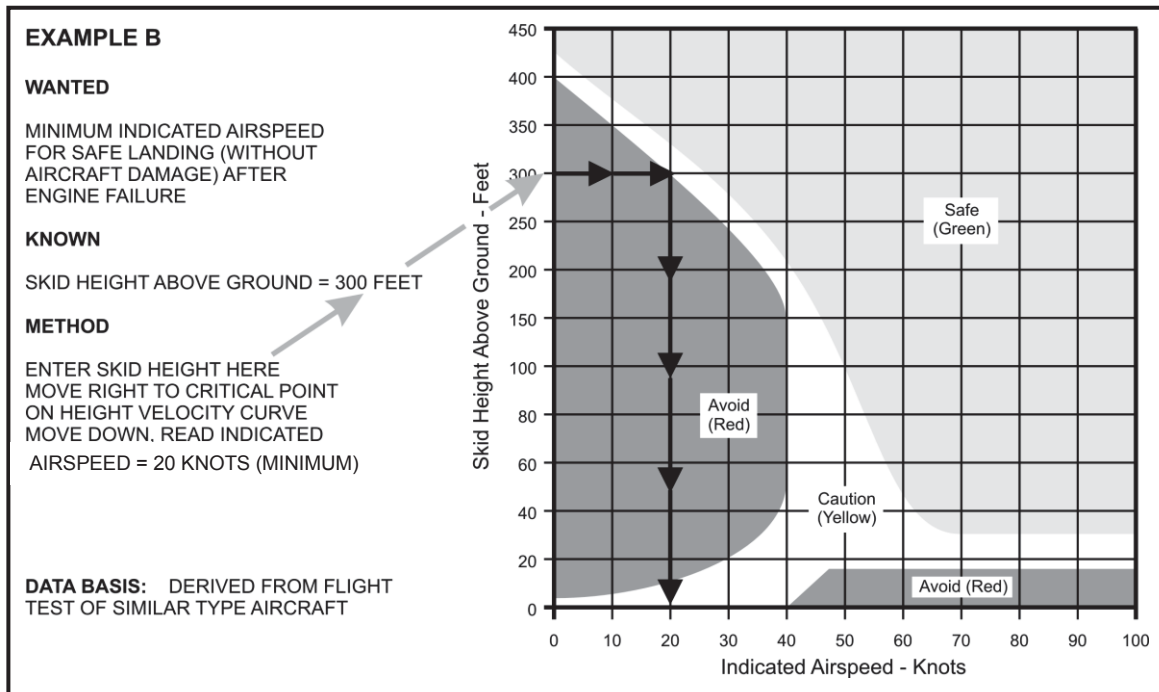

Figure 13-4 Autorotation Height Velocity Diagram

THIS PAGE INTENTIONALLY LEFT BLANK

APPENDIX A GLOSSARY

A100. GLOSSARY

Acceleration: The time rate of change of velocity. p 1-5

Advancing blade: The rotor blade experiencing an increased relative wind because of airspeed. p 2-22

Aerodynamics: ¹The science that treats the motion of air and other gaseous fluids and the forces acting on bodies when the bodies move through such fluids or when such fluids move against or around the bodies. ^{2a}The actions and forces resulting from the movement or flow of gaseous fluids against or around bodies. ^{2b}The properties of a body or bodies with respect to these actions or forces. ³The application of the principles of gaseous fluid flows and their actions against and around bodies to the design and construction of bodies intended to move through such fluids. p 1-2

Aerodynamic center (AC): Point along the chord line about which changes in AOA do not result in a change of moment. p 2-16

Aerodynamic force: The vector summation of lift and drag vectors depicted on the blade element diagram. p 1-3, 2-6, 2-26, Fig 2-32, p 2-32

Aerodynamic twist: The twist of an airfoil having different absolute angles of incidence at different span-wise stations. p 3-4

Air density/Atmospheric density: Mass of air per unit volume ($D = M/V$). It is the single most important atmospheric variable with regards to aircraft performance. p 1-9

Airfoil: A structure designed to produce lift as it moves through the air. p 1-4, 2-6, 2-20

Airfoil characteristics: ¹Any aerodynamic quality peculiar to a particular airfoil, especially to an airfoil section or profile, usually a specified AOA. Airfoil characteristics are expressed variously as the coefficients of lift or drag, the pitching moment, the zero-lift angle, the lift-drag ratio, and so on. ²A feature of any particular airfoil or airfoil section such as the actual or relative amount of span, taper, or thickness. p 2-15

Airfoil section: ¹A section of an airfoil, especially a cross section, taken at right angles to the span axis or some other specified axis of the airfoil. ²The form or shape of an airfoil section; an airfoil profile or the area defined by the profile. p 2-15

Airspeed: The speed of an aircraft in relation to the air through which it is passing. Typically in terms of forward airspeed but can be sideways or rearward also. p 1-7, 2-8

Angle-of-Attack (AOA): The angle at which a body, such as an airfoil or fuselage, or a system of bodies, such as a helicopter rotor, meets a flow. Usually expressed as the acute angle between the chord line of an airfoil and the resultant relative wind. p 2-14

Angle of climb: The angle between a horizontal plane and the flight path of a climbing aircraft. p 10-39

Angle of incidence: Fixed airfoils (wings, horizontal and vertical fins, stabilizers): the acute angle between the chord line of the airfoil and a selected reference plane, usually the longitudinal axis of the aircraft. Rotating airfoils (helicopters' main and tail rotors, propellers): the acute angle between the chord line of the airfoil and the tip path plane. Angle of incidence is normally called pitch angle for main rotor, tail rotor, and propeller blades. p 2-24

Angular acceleration: A simultaneous change in both speed and direction of movement. An example of this is an airplane in a spin. p 12-37

Anti-autorotative force: In autorotational flight, the decelerating horizontal component of the aerodynamic force along the driven and no-lift regions. p 11-17

Anti-torque device: A method used to counteract torque reaction, for example a tail rotor, Fenestron, NOTAR to name a few. p 6-2

Articulated rotor system: A rotor system in which the hub is mounted rigidly to the mast and the individual blades are mounted on hinge pins, allowing them to flap up and down and move forward and backward (lead and lag). Individual blades are allowed to feather by rotating about the blade grip retainer bearing. p 5-4

Aspect Ratio: Length of a blade divided by its width. p 9-6

Attitude: The position of a body as determined by the inclination of the axes to some frame of reference. If not otherwise specified, this frame of reference is fixed to the earth (horizon).

Autorotation: Descending flight of a helicopter without engine power where the air approaching from below the rotor disk (upward induced flow) keeps the rotor blades turning at an operational speed. May be divided into four distinct phases: entry, steady state descent, flare and touchdown. p 11-15

Axis: ¹A line passing through a body about which the body rotates or may be assumed to rotate. Any arbitrary line of reference such as a line about which the parts of a body or system are symmetrically distributed. A line along which a force is directed; for example, an axis of thrust. ²Specifically, any one of a set or system of mutually perpendicular reference axes—usually intersecting at the CG of an aircraft, rocket projectile, or the like—about which the motions, moments, and forces of roll (longitudinal), pitch (lateral), and yaw (vertical) are measured. p 2-2

Balancing tab: A moveable tab linked to the trailing edge of a control surface. When the control surface is deflected the tab is deflected in an opposite direction, creating a force which aids in moving the larger surface. Sometimes called a servo tab.

Blade element theory: Utilizes graphically depicted representation of the airflow and aerodynamic forces applied to a selected airfoil section. Gives a more accurate representation of rotor performance than does Momentum Theory. It also details the movement of individual blades around the disk. p 2-13

Blowback: The pitch-up tendency as the aircraft accelerates due to the flapping which compensates for dissymmetry of lift. The separation of the virtual axis from the control axis. p 10-18

Boundary-layer control: The control of the flow in the boundary layer about a body, or of the region of flow near the surface of the body, to reduce or eliminate undesirable aerodynamic effects and hence to improve performance. p 6-7

Camber: The curvature of the surfaces of an airfoil or airfoil section from leading edge to trailing edge. p 2-15

Camber Line: Line equidistant from the upper and lower surface of the airfoil; same as chord line for a symmetrical airfoil. p 2-15

Center of gravity (CG): The balancing point for a body, generally expressed along the longitudinal or lateral axis. p 2-16, 7-7

Center of pressure: Point along chord line about which all aerodynamic forces (distributed lift along upper and lower surfaces) are acting. p 2-15

Center-of-pressure travel: The movement of the center of pressure of an airfoil along the chord with changing AOA; the amount of this movement is expressed in percentages of the chord length from the leading edge.

Centrifugal force: The outward force created by the rotation of the main rotor and opposed by centripetal force. The large centrifugal force is what allows the weight of the helicopter to be distributed across otherwise flexible rotor blades. Centrifugal force is proportional to the square of N_r and increases dynamic blade rigidity. p 4-10

Centripetal force: The accelerative force acting on a body moving in a curved path. It is the component of force that is directed toward the center of curvature or axis of rotation. Centripetal force causes a change in the direction of the linear velocity vector of a body in motion, resulting in an acceleration of the body. Centripetal force is the out-of-balance force that causes an aircraft to turn. It is the horizontal component of lift that is directed toward the center of the turn. p 7-16, 12-3

Chord: The distance between the leading and trailing edges of an airfoil along the chord line. p 2-15

Chord line: A straight line intersecting the leading and trailing edges of an airfoil. p 2-15

Coefficient of drag (C_D): A dimensionless number indicating the inefficiency of an airfoil which is determined by AOA and airfoil design. It is derived from wind tunnel testing. p 2-29

Coefficient of lift (C_L): A dimensionless number indicating the efficiency of the airfoil which is determined by AOA and airfoil design. It is derived from wind tunnel testing. p 2-29

Collective feathering: The equal and simultaneous mechanical change of blade pitch (the angle of incidence) of all rotor blades in a rotor system. p 4-2

Compressibility: At high forward airspeeds, the advancing rotor blade creates large pressure changes, which result in significant air density changes. As the blade's velocity approaches the speed of sound, the blade becomes less efficient because of a nose-down pitching moment and a significant increase in drag. p 2-5, 3-6, 10-25

Compressible flow: Flow at speeds high enough that density changes in the fluid can no longer be neglected.

Coning: The upward displacement of the main rotor blades due to increased lift and balanced somewhat by centrifugal force. p 4-10

Coning angle: The angle between the tip path plane and the main rotor blades. p 4-11

Control surface: A movable airfoil designed to be rotated or otherwise moved to change the speed or direction of an aircraft. p 7-15, 12-17

Critical Mach number: The free-stream Mach number at which a local Mach number of 1.0 is attained at any point on the body under consideration. p 10-26

Cyclic feathering: The mechanical change of blade pitch (the angle of incidence), of individual rotor blades independently of the other blades in the system. p 4-2

Density altitude (DA): PA corrected for temperature and humidity; or, the altitude in the standard atmosphere corresponding to a particular value of air density. The denser an air mass (cold, dry air), the lower the corresponding value corrected to a standard atmosphere will be (High density = Low DA). The opposite is also true. Additionally, DA increases as temperature and/or relative humidity increases. Therefore DA is inversely proportional to atmospheric density and directly proportional to temperature and relative humidity. p 1-14

Disk Area: The area of the circle inscribed by the tip path plane with the rotors turning. The coning angle of the blades changes the disk area. p 2-12

Disk loading: The weight (thrust) of the helicopter divided by the rotor disk area (lb/sq.in).
p 2-13

Dissymmetry of lift: In forward flight the advancing blade experiences an increase in linear flow. The increased linear flow increases the lift on the advancing blade. Likewise, the retreating blade sees a decrease in linear flow and therefore a decrease in lift. Compensated for primarily by flapping. p 2-14, 4-3, 10-17

Downwash: The induced downward flow of air resulting from the passage of an airfoil (induced flow). p 2-11

Downwash angle: The angle, measured in a plane parallel to the plane of symmetry of an aircraft, between the direction of downwash and the direction of the undisturbed airstream. This angle is positive when the deflected stream is downward. (See Upwash angle.) p 2-34

Drag: The aerodynamic force in a direction opposite that of flight and caused by the resistance to movement brought to bear on an aircraft by the atmosphere through which it passes.

Droop snoot airfoil: nonsymmetrical airfoil design used by the TH-57. The droop snoot design incorporates a symmetrical blade design with a nonsymmetrical nose. A droop snoot design provides good stall characteristics at high angles of attack and produces very low pitching moments. p 2-36

Dynamic pressure: The pressure of a fluid resulting from its motion; it is equal to one-half the fluid density times the fluid velocity squared ($q = 1/2\rho V^2$). In incompressible flow, dynamic pressure is the difference between total pressure and static pressure. p 2-6

Dynamic rollover: The lateral rolling of the helicopter onto its side due to exceeding the critical rollover angle for a critical roll rate, regardless of cyclic corrections. For dynamic rollover to occur the helicopter must have a ground pivot point. p 12-34

Dynamic stability: The property that causes a body, such as an aircraft or a rocket, to dampen the oscillations set up by restoring moments and to return gradually to its original state when disturbed from the original state of steady flight or motion. p 7-5

Effective translational lift: The pronounced increase in translational lift during transition to forward flight (approximately 13-24 knots) due to the rotor disk experiencing a significantly decreased induced airflow. 10-5, 10-13, Fig 10-11, p 10-14

Empennage: The assembly of stabilizing and control surfaces at the tail of an aircraft.

Endurance: The time an aircraft can continue flying under given conditions without refueling.
p 8-2

Equivalent airspeed: Calibrated airspeed of an aircraft corrected for adiabatic compressible flow for the particular altitude. Equivalent airspeed is equal to calibrated airspeed in standard atmosphere at sea level.

Feathering: A mechanical change in the angle of incidence, or pitch, of an airfoil segment.
p 2-24, 4-2

Fin: A fixed airfoil that aids directional stability. p 2-15

Flapping: Vertical blade movement, normally about a central hinge pin, which allows the rotor disk to tilt and helps compensate for dissymmetry of lift. p 2-15

Flight path: The line connecting the continuous positions occupied or to be occupied by an aircraft as it moves with reference to the vertical or horizontal planes. p 5-9, 7-2, 7-17

Flow separation/boundary layer separation: The breakaway of flow from a surface; the condition of a flow separated from the surface of a body and no longer following its contours.
p 2-25, 10-27

Fuselage: The body to which the wings, landing gear, and tail are attached.

Geometric imbalance: Occurs when the radius of the center of mass for a single rotor blade changes due to excessive flapping and is no longer equidistant from the center of rotation relative to the individual centers of mass for the other rotor blade(s). This phenomenon may lead to excessive hunting. If the center of mass for an individual rotor blade shifts towards the center of rotation, that blade has a tendency to lead; likewise, if the center of mass shifts away from the center of rotation, the blades will have a tendency to lag. Ground resonance may result if this excessive flapping creates excessive hunting oscillations. p 4-11

Geometric twist: An engineered design of the rotor blade span-wise, that incorporates a twist beginning with an increased angle of incidence at the root of the rotor blade which decreases from the root to the tip. Geometric twist helps to distribute lift more equally across the rotor blade. p 3-4

Gravity: An attraction of two objects for each other that depends on their mass and the distance between them. p 1-5

Gross weight: The total weight of an aircraft and its contents. p 4-11

Ground effect: The increased efficiency (decreasing power requirement) of the rotor system of the helicopter beginning at approximately one rotor diameter above the surface and increasing as the helicopter approaches the ground. The aerodynamic effect can be largely attributed to the reduction of the velocity of the induced flow because the ground interrupts the airflow beneath the helicopter. Additionally, the ground interrupts the formation of tip vortices, reducing their contribution to induced flow. The decrease in induced flow increases AOA, providing an increase in lift with a reduction in blade pitch setting/power setting. p 9-9

Ground resonance: Normally associated with the fully articulated rotor system and an inoperative blade dampener, ground resonance is a destructive oscillation caused when the helicopter is in contact with the ground and one or more rotor blades are displaced due to a gust of wind, sudden control movement, or a hard landing. When this occurs, the CG of the rotor system spirals violently outward. (See Geometric imbalance) p 12-30

Ground vortex: During a normal transition to forward flight, the helicopter's downwash creates a vortex in front of the path of flight. As the helicopter accelerates, the aircraft flies through the vortex. This serves to increase the induced flow causing an increase in the power required. p 10-20

Gyroscopic precession: A phenomenon in rotating systems that results in all forces applied perpendicular to the plane of rotation being manifested 90° later from the point of force in the direction of rotation. p 4-5

Horsepower: A unit of power equal to the power necessary to raise 550 pounds one foot in one second. Thus a 1000-horsepower engine develops 1000 times 550 foot-pounds of work per second. It is common to represent this power in terms of minutes instead of seconds. Thus, equations routinely have conversion factors of 33,000. p 9-15

Induced drag: The horizontal component of lift (parallel to the tip path plane) attributed to a downward induced velocity. p 2-14

Induced flow (V-ind): Vertical/axial component of relative wind. Generally, in powered flight the induced velocity is downward and in non-powered flight the induced velocity is upward through the rotor disk. Also known as induced airflow. p 2-21

In-plane drag: The summation of all decelerating forces in the plane of rotation (induced drag + horizontal component of profile drag). p 2-40

Kinetic energy: The energy of a system because of motion. p 1-6

Lag: In a rotating system, this is the occurrence of a momentary decrease in the rotational velocity, normally about a vertical hinge pin in an articulated system. p 4-3

Laminar flow: A smooth flow in which no cross flow of fluid particles occurs, hence a flow conceived as made up of layers. p 2-7

Laminar separation: The separation of a laminar-flow boundary layer from a body.

Lateral axis: An axis going from side to side of an aircraft, rocket, missile, and so on. It is usually the side-to-side body axis passing through the CG. The axis about which pitching action occurs. Sometimes called a Transverse axis. p 2-2

Lateral stability: The tendency of a body, such as an aircraft, to resist rolling or, sometimes, lateral displacement; the tendency of an aircraft to remain wings-level, either in flight or at rest. p 7-9

Lead: Opposite of lag, or, a momentary increase in the rotational velocity in a rotating system. p 4-3

Leading edge: The forward edge of an airfoil, blade, and the like. The edge which normally meets the air or fluid first. p 2-7

Lift: The component of the total aerodynamic force (thrust on a blade element), which is perpendicular to the relative wind. p 2-8

Lift component: A force acting on an airfoil perpendicular to the direction of its motion through the air.

Lift-drag ratio: The ratio of lift to induced drag, obtained by dividing the lift by the induced drag or the coefficient of lift by the coefficient of drag.

Linear flow: Horizontal/lateral component of resultant relative wind in a rotating system, the V-rotational flow +/- the V-translational, adjusted for any existing wind condition. p 2-14

Load: ¹The forces acting on a structure. These may be static (as with gravity), dynamic (as with centrifugal force), or a combination of static and dynamic. ²Used to describe an aircraft's cargo.

Load factor: the sum of the loads on a structure, including the static and dynamic loads; expressed in units of G. p 12-5

Longitudinal acceleration: Acceleration substantially along the longitudinal axis of an aircraft, a rocket, or the like.

Longitudinal axis: A straight line through the CG of an aircraft fore and aft in the plane of symmetry. p 2-2

Mach number: The ratio of the velocity of a body to that of sound in the surrounding medium. Thus a Mach number of 1.0 indicates a speed equal to the speed of sound; 0.5, a speed one-half the speed of sound; 5.0, a speed five times the speed of sound, and so on. p 10-26

Mach wave: ¹A shock wave theoretically occurring along a common line of intersection of all the pressure disturbances emanating from an infinitesimally small particle moving at a supersonic speed through a fluid medium; such a wave is considered to exert no changes in the condition of the fluid it is passing through. The concept of the Mach wave is used in defining and studying the realm of certain disturbances in a supersonic field of flow. ²A very weak shock wave appearing, for example, at the nose of a very sharp body where the fluid undergoes no substantial change in direction. p 10-27

Maneuver: Any planned motion of an aircraft in the air or on the ground.

Maneuverability: The ease with which an aircraft will move out of its equilibrium position. Maneuverability and stability are opposites. p 7-9

Maximum endurance airspeed: The lowest point on the power required curve where the ratio of lift versus drag is maximized (also called bucket airspeed). p 8-4

Maximum range airspeed: The point where a line drawn from the origin (corrected for winds) is tangent to the power required curve. p 8-7

Maximum rate of climb airspeed: The lowest point on the power required curve. Ratio of lift versus the drag is maximized thereby allowing for the greatest power excess. (Also referred to as best rate of climb) p 8-6

Mean aerodynamic chord: The chord of an imaginary rectangular airfoil that would have pitching moments throughout the flight range the same as those of an actual airfoil or combination of airfoils under consideration, calculated to make equations of aerodynamic forces applicable.

Mean camber line: A line drawn halfway between the upper and lower surfaces of an airfoil. The curvature of the mean camber line in relation to the chord line is very important in determining the aerodynamic characteristics of an airfoil section. The maximum camber (displacement of the mean line from the chord) and the location of the maximum camber help to define the shape of the mean camber line. These quantities are expressed as fractions or a percent of the basic chord length. A typical low-speed airfoil may have a maximum camber of 4% located 40% aft of the leading edge. On symmetrical airfoils, the mean camber line and the chord line are the same. p 2-16

Mechanical axis: The extension of the centerline of the rotor mast (the actual axis of the rotor head). p 5-3

Momentum theory: Theory that helps explain rotary wing lift production, primarily based on Isaac Newton's three Laws of Motion. The action of accelerating a mass of air downward produces a reaction that lifts the helicopter. Momentum theory is most applicable in hovering and forward flight. p 2-11

Neutral stability: The stability of a body such that after it is disturbed, it tends neither to return to its original state nor to move further from it; that is, its motions or oscillations neither increase nor decrease in magnitude. p 7-4

Newton's Laws of Motion:

1. Newton's First Law (The Law of Equilibrium) "A body at rest tends to remain at rest and a body in motion tends to remain in motion in a straight line at a constant velocity unless acted upon by some unbalanced force." p 1-6
2. Newton's Second Law (The Law of Acceleration) "The acceleration (a) of a body is directly proportional to the force (F) exerted on the body, is inversely proportional to the mass (m) of the body, and is in the same direction as the force." " $F = ma$ " p 1-8
3. Newton's Third Law (The Law of Interaction)" "For every action, there is an equal and opposite reaction." p 1-8

Nonsymmetrical airfoil: An airfoil with a different shape or size above and below the chord line. p 2-17

Parasite drag: Drag incurred from components of an aircraft not contributing to lift. p 2-33

Pendulum effect: Uncommanded nose-up tendency during deceleration that occurs in response to an increase in collective pitch before mechanical and virtual axes are realigned. Compensated for by pilot-induced feathering through forward cyclic. p 10-20

Phase lag: When a rotating system in resonance receives a periodic excitation force sympathetic with the natural frequency of the system, the response to the applied force is a maximum displacement up to 90° after the force is applied. A phenomenon of the rotor system analogous to gyroscopic precession which occurs as a result of a continuous excitation force. p 4-3

Pitch angle: Angle between the chord line and the tip path plane. (See also Angle of incidence). p 2-14

Pitching moment: A moment about a lateral axis of an aircraft, rocket, airfoil, and so on. This moment is positive when it tends to increase the AOA or to nose the body upward. p 2-35

Positive G: The forward inertial force produced by a headward acceleration. The force occurs in a gravitational field or during an acceleration when the human body is so positioned that the force of inertia acts on it in a head-to-foot direction. p 12-8

Positive lift: Lift acting in an upward direction. p 10-30

Potential energy: The energy of a system derived from position. p 1-6

Power: The rate of doing work; often expressed in units of horsepower. p 1-5

Power available (P_A or P_{avail}): The amount of power an engine is capable of producing for given conditions. As DA increases, engine power available decreases. p 1-14, 8-8

Power excess/Excess power: Ratio of power available to the power required. If the ratio is less than 1 then power required exceeds the power available. p 8-12

Power required (P_R or P_{req}): The amount of power necessary to turn the rotor system at a constant speed. As the DA increases, the pitch angle of the rotor blades must increase to generate the same amount of lift. This creates more drag forces on the rotor system and therefore more power is required to maintain a constant rotor speed. p 8-4

Power required exceeds power available ($P_R > P_A$): An uncommanded rate of descent and/or loss of rotor rpm caused by the power required exceeding the power available (also called settling with power). Conditions that contribute to higher power required are high gross weights, high G-loading, rapid maneuvering, high-density altitudes, loss of ground effect, and loss of

translational lift. High DA also contributes to loss of engine power available. p 8-20, 11-4

Power Settling: A term often used interchangeably with “settling with power” by different services and texts. See “Vortex Ring State” and “power required exceeds power available” for preferred terminology.

Preconing: The engineered design used to reduce stress associated with flexing on the root of the rotor blades, the yoke, and the blade grips. p 2-3

Pressure altitude (PA): The altitude of a given pressure in the standard atmosphere. See Standard atmosphere. As pressure increases, density increases and DA decreases. Fig 1-14, p 1-12

Pressure gradient: A change in the pressure of a gas or fluid per unit of distance.

Pro-autorotative force: In unpowered flight, the accelerating horizontal component of the total aerodynamic force vector in the region where it is tilted forward of vertical/axial (driving region). p 11-19

Profile drag: Result of air friction acting on the blade element (parallel to the relative wind). NOTE: In a hover, profile drag accounts for 15-45 percent of the total power consumption. p 2-14

Rate of climb: The rate at which an aircraft gains altitude; that is, the vertical component of its airspeed in climbing. p 8-6

Rate of descent: The rate at which an aircraft descends; that is, the vertical component of its airspeed in descending; the rate at which a parachute and its burden descend.

Relative velocity: Velocity of the resultant relative wind.

Relative wind resultant: The vector resultant of the linear velocity + induced velocity as depicted on the blade element diagram. p 2-18

Retreating blade: The rotor blade experiencing a decreased relative wind because of airspeed. p 2-22

Retreating blade stall: Aggravated case of dissymmetry of lift which results in the aircraft pitching up and rolling left. As airspeed increases the retreating blade’s linear flow is reduced, the blade flaps down, decreasing induced flow and increasing AOA. Eventually, as airspeed increases further, the blade will exceed the critical AOA and will stall. With current blade designs, a helicopter’s forward airspeed is primarily limited by retreating blade stall. p 10-21

Reynolds number: The product of a typical length and the fluid speed divided by the kinematic viscosity of the fluid. It expresses the ratio of the internal forces to the viscous forces.

Rigid rotor system: Sometimes referred to as “hingeless” since the rotor blades are fixed rigidly to the hub without mechanical hinges for flapping, lead and lag (hunting), and on some

systems pitch change (feathering). Flapping and hunting occur through the flexing and bending of the composite hub or “flectures.” Some systems also allow for pitch change through the twisting of the materials rather than a pitch-change hub. Fig 5-2, p 5-3

Roll: Movement around the longitudinal axis of an aircraft. p 2-2

Rotational velocity (V-rot): The component of the relative wind produced by rotation of the rotor blades i.e., the velocity of airflow across the airfoil due to its rotation about the mechanical axis. p 2-18

Rotor disk: Area of the circle inscribed in the tip path plane.

Rotor system: General term referring primarily to the design that holds the rotor blades to the mast. The three general types of rotor systems are: fully-articulated, semi-rigid and rigid. p 5-3

Semi-rigid rotor system: A rotor system in which the blades are connected to the mast by a trunnion that allows blades to flap. Pitch change (feathering) is allowed at the hub about the blade grip retainer bearing. p 5-3

Separated flow: Flow over or about a body that has broken away from the surface of the body and no longer follows its contours.

Settling with power: Also known as “Power Required Exceeds Power Available”, is a hazardous helicopter flight condition in which the power required for a given maneuver or flight regime is greater than the power available under the current ambient conditions. The terms “settling with power” and “power settling” are used differently by Army and Navy helicopter pilots, therefore the term “power required exceeds power available” is preferred. This should not be confused with “Power Settling” which is more correctly called “Vortex Ring State.” p 8-10, 11-4

Sideslip: A movement of an aircraft such that the relative wind has a velocity component along the lateral axis. p 7-10

Skid: Rate of turn is greater than normal for a degree of bank established. p 12-7

Slip: The rate of turn is less than normal for the degree of bank established. p 12-7

Span: ^{1a}The dimension of an airfoil from end to end, from tip to tip, or from root to tip. ^{1b}The dimension of an aircraft, measured between lateral extremities. ²The dimension of an airfoil from tip to tip, measured in a straight line. Where ailerons or elevators extend beyond the tips of the airfoil proper, their extension is included in the span. Sweeping an airfoil or giving it dihedral decreases the span.

Speed: The rate at which an object moves in relation to time and distance.

Speed of sound: The speed at which sound travels in a given medium under specified conditions. p 1-12

Stabilator: A horizontal surface that pivots as a whole; it is distinct from the usual combination of fixed and movable surfaces. p 7-12

Stability: The property of an aircraft to maintain its attitude or to resist displacement and, if displaced, to develop forces and moments tending to restore the original condition. p 7-2

Stabilizer: A fixed or adjustable airfoil or vane that provides stability for an aircraft; that is, a fin or more specifically the horizontal stabilizer on an aircraft. p 6-8, 7-12

Stall: ^{1a}A condition in which a wing or other dynamically lifting body flies at an AOA greater than that for maximum lift, resulting in a loss of lift and an increase of drag. ^{1b}A loss of lift and an increase of drag brought on by a shock wave; that is, a shock stall. ²The flight condition or behavior of an aircraft flying at an angle greater than the angle of maximum lift; any of various aircraft performances involving a stall. p 2-24

Stall speed: The airspeed at which, under a given set of conditions, an aircraft will stall.

Stalling AOA: ¹The minimum AOA of an airfoil or airfoil section or other dynamic lifting body at which a stall occurs; that is, a critical AOA. ²The angle of maximum lift. p 2-24

Standard atmosphere: A model of atmospheric conditions that vary with altitude above sea level, namely: pressure, temperature, and density. The model was derived from global averages and is used in performance. p 1-11

Standard lapse rate: In a thermodynamic system, the rate of heat loss of two degrees Celsius per every 1000 feet due to an expansion of the atmosphere corresponding to an increase in altitude. Also referred to as average or adiabatic lapse rate. p 1-10

Static pressure: The atmospheric pressure of the air through which an aircraft is flying. p 1-9

Sweepback: The backward slant from root to tip (or inboard end to outboard end) of an airfoil or of the leading edge or other reference line of an airfoil. Sweepback usually refers to a design in which both the leading and trailing edges of the airfoil have a backward slant.

Symmetrical airfoil: An airfoil with the same size and shape above and below the chord line.

Tab: A small auxiliary airfoil set into the trailing edge of an aircraft control surface (or something set into or attached to another surface such as a rotor blade) and used for trim or to move or assist in moving the larger surface. Fig 2-13, p 2-16

Tail rotor: The anti-torque device of a single-rotor helicopter. Control of this rotor is through the foot pedals. p 2-3, 5-5

Tandem rotor system: A main lifting rotor is used at each end of the helicopter. The rotor systems rotate in opposite directions to counteract torque. p 5-7

Taxi: ¹The operation of an airplane or helicopter under its own power on the ground, except that movement incident to actual takeoff and landing. ²The forward movement of a helicopter at a hover is referred to as a hover taxi.

Thrust: Rotor thrust is the vector sum of forces produced in the rotor system. p 1-8

Thrust axis: A line or axis through an aircraft, rocket, and so on along which the thrust acts; an axis through the longitudinal center of a jet or rocket engine along which the thrust of the engine acts; a center of thrust. For helicopters, the total rotor thrust acts perpendicular to the tip path plane through the rotor head and is called virtual axis. p 4-5, 5-3, 10-20

Tip path plane: The path inscribed by the tips of the main rotor blades as they rotate. The tip path plane contains the rotor disk, and rotor thrust is perpendicular to the TPP. Fig 2-36, p 2-38

Tip vortex: A vortex springing from the tip of a wing because of the flow of air around the tip from the high-pressure region below the surface to the low-pressure region above it. Fig 2-22, p 2-21

Torque: Mathematically, torque is a force times a distance. It causes the fuselage to react in yaw due to the fact that the drive train turns the rotor. p 1-5

Torque effect: In a counterclockwise rotating rotor system, due to the momentum of the advancing rotor blade on the right side of the aircraft, there is an equal and opposite reaction (torque) which causes the helicopter to rotate to the right. The tail rotor counteracts torque effect. Remember Newton's Third Law of Motion which states that every action has an equal and opposite reaction. p 5-7, 6-2

Trailing edge: The rearmost edge of an airfoil. p 2-3

Trailing vortex: A vortex that is shed from a wing or other lifting body and is trailing behind it, especially such a vortex trailing from a wingtip or from the end of a bound vortex. It is sometimes referred to as wake turbulence.

Translating tendency: Tendency for a helicopter to translate laterally due to tail rotor thrust. p 6-2, 6-9, 9-19

Translational flight: Any horizontal movement of a helicopter with respect to the air.

Translational lift: The increased efficiency of the rotor system in the production of lift by increasing the horizontal mass flow of air through the rotor disk, reducing the induced flow and vortices. (See also Effective translational lift) p 10-13

Translational velocity (V-trans): Airflow through a rotor system or across a blade element due to movement of the aircraft. Added geometrically to v-rotational on the advancing blade and subtracted on the retreating blade. p 2-18

Transverse flow effect: A non-uniform induced velocity flow pattern across the rotor disk that produces a pronounced rolling tendency and lateral vibrations during transition through approximately 10-20 knots. p 10-15

Trim: The condition of a heavier-than-air aircraft in which it maintains a fixed attitude with respect to the wind axes, with the moments about the aircraft axes being in equilibrium. The word “trim” is often used with special reference to the balance of control forces.

Trim tab: A tab that is deflected to a position where it remains to keep the aircraft in the desired trim. Adjustment of a trim tab on a rotor blade causes the blade to maintain a given track or plane of motion. p 12-28

True airspeed: Equivalent airspeed corrected for error that is due to air density (altitude and temperature).

Turbulence: An agitated condition of the air or other fluids; a disordered, irregular, mixing motion of a fluid or fluid flow such as that about a body in motion through the air.

Turbulent boundary layer: A boundary layer characterized by random fluctuations of a velocity and by pronounced layer mixing of the fluid.

Turbulent flow: A flow characterized by turbulence; that is, an irregular, eddying, fluctuating flow; a flow in which the velocity of a given point varies erratically in magnitude and direction with time.

Underslinging: Attachment of the rotor head occurs with a pivot point above the blade grips and centered midway between the opposing blade centers of gravity. Semi-rigid rotor head design which compensates for geometric imbalance by keeping the individual centers of mass for each rotor blade equidistant from the center of rotation. Allows for flapping, but geometric design minimizes hunting. p 4-13

Uniform flow: An idealized flow in which the streamlines are parallel and the velocity is constant throughout.

Unsteady flow: A flow whose velocity components vary with time at any point in the fluid. Unsteady flow is of fixed pattern if the velocity at any point changes in magnitude but not direction and of variable pattern if the velocity at any point changes in direction. p 12-22

Upwash: A flow deflected upward by a wing, rotor, rotor blade, and so on. p 2-19

Upwash angle: A negative downwash angle; that is, the acute angle, measured in a plane parallel to the plane of symmetry of an aircraft, between the direction of upwash and the direction of the undisturbed airstream.

Useful load: The difference, in pounds, between the empty weight and maximum authorized

gross weight of an aircraft.

V-rotational: See “Rotational velocity.”

V-translational: See “Translational velocity.”

Vector: A quantity having both magnitude and direction. Also a graphic illustration of such a quantity. p 1-7

Velocity: ¹Speed. ²A vector quantity that includes both magnitude (speed) and direction relative to a given frame of reference. ³Time rate of motion in a given direction. p 1-3

Venturi: A converging-diverging passage for fluid that increases the fluid velocity and lowers its static pressure; a venturi tube. p 2-5

Vertical axis: An axis passing through an aircraft from top to bottom and usually passing through the CG. The axis about which yaw occurs. Also called a Normal axis. p 2-2

Vertical stabilizer: A vertical fin mounted approximately parallel to the longitudinal axis of an aircraft to which a rudder may be attached. The vertical stabilizer aids in directional stability. Also called a vertical fin. p 6-8

Virtual axis: The axis of rotation perpendicular to the tip path plane, as opposed to the mechanical axis. As the rotor disk tilts with control inputs, the virtual axis tilts and remains perpendicular to the plane of rotation. Rotor thrust acts through the virtual axis. p 4-5, 5-3

Vortex Ring State (VRS): Settling of the helicopter into its own downwash. During VRS, airflow is downward over the outer portion of the rotor disk and upward both in an area expanding outward from the hub as well as the area outside the tip path plane. This rapidly decaying phenomenon may result in zero net lift. The prescribed limits to avoid entry into VRS for the TH-57 are: avoid descent rates in excess 800 ft/min at airspeeds less than 40 KIAS, and avoid descent gradients greater than 45°. VRS has also been called “power settling,” a term commonly confused with the term “settling with power.” p 11-5

Wake Turbulence: (See Trailing vortex.) p 9-6

Weathervane: The tendency of an aircraft on the ground to face into the wind. p 6-11

Weight: A measure of the mass of an object under the acceleration of gravity.

Work: A force exerted over a given distance.

Yaw: A movement about the vertical axis. p 2-2

Zero AOA: The position of an airfoil, fuselage, or other body when no AOA exists between two specified or understood reference lines. p 2-7

Zero-lift AOA: The geometric AOA at which no lift is created. Often called the angle of zero lift or the zero-lift angle. p 2-16

APPENDIX B
REFERENCES AND READING LIST

1. Rotary Wing Aerodynamics for Naval Aviators, School of Aviation Safety, Department of the Navy, May 2004.
2. Fundamentals of Aerodynamics (NAVAVSCOLSCOM-SG-111), Naval Aviation Schools Command, Pensacola, FL, April 2008.
3. Fundamentals of Flight, FM 1-203, Headquarters, Department of the Army, October 1988.
4. Rotary Wing Flight, FM 1-51, Headquarters, Department of the Army, 16 April 1979.
5. Meteorology for Army Aviators, FM 1-230, Headquarters, Department of the Army, September 1982.
6. Anderson, John D, Fundamentals of Aerodynamics - 2nd Ed., McGraw-Hill Inc., U.S.A. 1991, 1984.
7. Anderson, John D. Jr. A History of Aerodynamics - Cambridge University Press, Cambridge, United Kingdom, 1999.
8. Dole, Charles E., Flight Theory and Aerodynamics - A Practical Guide for Operational Safety, John Wiley & Sons, Inc. 1981.
9. Hurt, Hugh. Aerodynamics for Naval Aviators (NAVWEPS 00-80T-80)., Washington, D.C.: U.S. Government Printing Office, 1960.
10. Johnson, Wayne, Helicopter Theory Dover Publications, Inc., New York New York, 1980.
11. Leishman, J. Gordon, Principles of Helicopter Aerodynamics, Cambridge University Press, Cambridge, United Kingdom, 2000.
12. Montgomery, John R, Sikorsky Helicopter Flight Theory for Pilots and Mechanics, Sikorsky Aircraft, Division of United Aircraft Corporation, U.S.A. 1964.
13. Prouty, R.W., Helicopter Aerodynamics, PJS Publications Inc., Peoria IL, 1985.
14. Prouty, R.W., Even More Helicopter Aerodynamics, PJS Publications Inc., Peoria IL, 1985.
15. Prouty, R.W., Helicopter Performance, Stability. and Control, Krieger Publishing Company, Inc., Malabar, FL, 1995.

16. Rolls-Royce, The Jet Engine, Rolls-Royce Limited, 1969.
17. Saunders, George H., Dynamics of Helicopter Flight, John Wiley & Sons, Inc., 1975.
18. Seddon, J., Basic Helicopter Aerodynamics, AIAA, 1990.
19. Spence, Charles F., editor, AIM/FAR 1998, McGraw-Hill, 1998.
20. Stepniewski, W. Z., Keys, C. N., Rotary-Wing Aerodynamics, Dover Publications, Inc., 31 East 2nd Street. Mineola. N.Y. 11501
21. Treager, Irwin E., Aircraft Gas Turbine Engine Technology, McGraw-Hill, Inc., 1970.
22. Wagtendonk, Walter J., Principles of Helicopter Flight, Aviation Supplies & Academics, Inc., Newcastle, Washington, 1996.

**APPENDIX C
INDEX**

C100. INDEX

A

Aerodynamic center	2-16
Airfoil.....	1-7, 2-6, 2-10
Airfoil characteristics.....	2-15
Airfoil section	2-15
Angle of attack (AOA).....	2-14
Angle of climb	10-39
Angular acceleration	12-37
Autorotation	11-15

B

Blade element theory	2-13
Blowback	10-18

C

Camber Line.....	2-15
Center of gravity	2-16, 7-7
Center of pressure	2-15
Centrifugal force.....	4-10
Chord.....	2-15
Chord line.....	2-15
Collective feathering.....	4-2
Compressibility	2-5, 3-6, 10-25
Coning.....	4-10
Critical Mach Number	10-26
Cyclic feathering.....	4-2

D

Disk area	2-12
Dissymmetry of lift.....	2-14, 4-3, 10-17
Dynamic pressure.....	2-6
Dynamic rollover	12-34
Dynamic stability	7-5

E

Effective translational lift	10-5, 10-13, 10-14
------------------------------------	--------------------

F

Feathering	2-4, 4-2
Flapping	4-2

G

Geometric imbalance	4-11
Geometric twist	3-4
Ground effect	9-9
Ground resonance	12-30
Ground vortex	10-20

I

Induced drag.....	2-14
-------------------	------

L

Lateral stability	7-10
Lead/Lag	4-3
Linear velocity/flow	2-14
Longitudinal axis	2-2

M

Maneuverability	7-9
Maximum airspeeds	8-4, 8-6, 8-7
Momentum Theory	2-11

N

Newton's Laws of Motion	1-6
Newton's First Law (The Law of Equilibrium)	1-6
Newton's Second Law (The Law of Acceleration)	1-8
Newton's Third Law (The Law of Interaction)	1-8

P

Pendulum effect	10-20
Phase lag	4-3, 4-5
Pitching moment	2-35
Power available	1-14, 8-8, 8-14
Power required	8-4
Power required exceeds power available	8-10, 11-4
Pro-autorotative force	11-19

R

Relative wind, resultant 2-18
 Retreating blade 2-22
 Retreating blade stall..... 10-21
 Rigid rotor system..... 5-3
 Rotational velocity (V-rot)..... 2-18

S

Semi-rigid rotor system..... 5-3
 Stabilator 7-12
 Stalling angle of attack..... 2-24
 Standard atmosphere..... 1-11
 Symmetrical airfoil 2-16

T

Tip path plane 2-38
 Torque effect..... 5-7, 6-2
 Translating tendency 6-2, 6-9, 9-19
 Translational lift..... 10-13
 Transverse flow effect..... 10-15

U

Underslinging..... 4-13

V

Vertical stabilizer 6-8
 Virtual axis..... 4-5, 5-3
 Vortex Ring State..... 11-5

THIS PAGE INTENTIONALLY LEFT BLANK