

**NAVAL AIR TRAINING COMMAND**



**NAS CORPUS CHRISTI, TEXAS**

**CNATRA P-459 (Rev. 09-14)**

---

# **FLIGHT TRAINING INSTRUCTION**



## **TACTICAL AND FORMATION ADVANCED PHASE TH-57**

**2014**



DEPARTMENT OF THE NAVY  
CHIEF OF NAVAL AIR TRAINING  
250 LEXINGTON BLVD SUITE 102  
CORPUS CHRISTI TX 78419-5041

CNATRA P-459  
N714  
11 Sep 14

CNATRA P-459 (Rev. 09-14)

Subj: FLIGHT TRAINING INSTRUCTION, TACTICAL AND FORMATION,  
ADVANCED PHASE, TH-57C

1. CNATRA P-459 (Rev. 09-14) PAT, "Flight Training Instruction, Tactical and Formation, Advanced Phase, TH-57C" is issued for all information, standardization of instruction, and guidance to all flight instructors and student military aviators in the Naval Air Training Command.
2. This publication is an explanatory aid to the Helicopter curriculum and shall be the authority for the execution of all flight procedures and maneuvers herein contained.
3. Recommendations for changes shall be submitted via CNATRA TCR form 1550/19 in accordance with CNATRAINST 1550.6 series.
4. CNATRA P-459 (Rev. 04-11) PAT is hereby cancelled and superseded.

A handwritten signature in black ink, appearing to read "M B Tatsch", is positioned above the typed name.

M. B. TATSCH  
By direction

Distribution:  
CNATRA Website

**FLIGHT TRAINING INSTRUCTION**  
**FOR**  
**TACTICAL AND FORMATION ADVANCED PHASE**  
**TH-57**  
**P-459**



## LIST OF EFFECTIVE PAGES

*Dates of issue for original and changed pages are:*

Original...0...30 Jun 04 (this will be the date issued)

Revision...1...20 July 07

Change Transmittal...1...08 Sep 08

Change Transmittal...2...04 Mar 09

Change Transmittal...3...16 Jul 09

Revision...2...25 Oct 10

Revision...3...27 May 11

Revision...4...11 Sep 14

Change Transmittal...1...05 Oct 15

**TOTAL NUMBER OF PAGES IN THIS PUBLICATION IS 184 CONSISTING OF THE FOLLOWING:**

<b>Page No.</b>	<b>Change No.</b>	<b>Page No.</b>	<b>Change No.</b>
COVER	0	5-6 (blank)	0
LETTER	0	6-1 – 6-30	0
iii – x	0	7-1 – 7-3	0
1-1 – 1-16	0	7-4 (blank)	0
2-1 – 2-7	0	8-1 – 8-68	0
2-8 (blank)	0	A-1	0
3-1 – 3-9	0	A-2 (blank)	0
3-10	1	B-1	0
3-11	1	B-2 (blank)	0
3-14 (blank)	0	C-1	0
4-1 – 4-19	0	C-2 (blank)	0
4-20 (blank)	0	D-1	0
5-1 – 5-5	0	D-2 (blank)	0

## INTERIM CHANGE SUMMARY

*The following Changes have been previously incorporated in this manual:*

CHANGE NUMBER	REMARKS/PURPOSE
1	Changes made per transmittal letter (10-05-15)

*The following interim Changes have been incorporated in this Change/Revision:*

INTERIM CHANGE NUMBER	REMARKS/PURPOSE	ENTERED BY	DATE

## **INTRODUCTION**

This Flight Training Instruction provides you amplifying information covering Confined Area Landings, Tactical Flight Maneuvers, Pinnacle Landings, External Load Operations, Search and Rescue Procedures, Shipboard Operations, Formation Flight, and Section Low-Level Formation. You have to draw upon and apply the fundamentals you have learned from the previous modules of instruction to successfully complete this module. The concepts of tactical operations and formation flight are the capstones of this stage. The objective of tactical operations is to show the versatility of helicopter operations within the fleet and various mission capabilities. The objective of formation flying is to employ and control multiple aircraft flying in close proximity to accomplish an assigned mission in a manner that will minimize the effectiveness of enemy opposition.

## **SCOPE**

This publication contains maneuvers introduced in the Formation and Tactics stages of the Advanced Helicopter Multi-Service Pilot Training System Master Curriculum Guide (CNATRAINST 1542.156 series). It is your responsibility to have a thorough knowledge of its contents.

## **CHANGE RECOMMENDATIONS**

Change recommendations to this publication may be submitted by anyone to Commander Training Air Wing FIVE, a process which improves training curricula and its associated training publications. This includes all personnel involved at every level of flight training. A Training Change Request (TCR) form should be completed and submitted for routing to the standardization office of your respective squadron. Remember, no TCR is too small.

## TABLE OF CONTENTS

<b>LIST OF EFFECTIVE PAGES.....</b>	<b>iv</b>
<b>INTERIM CHANGE SUMMARY.....</b>	<b>v</b>
<b>TABLE OF CONTENTS .....</b>	<b>vii</b>
<b>TABLE OF FIGURES.....</b>	<b>ix</b>
<b>CHAPTER ONE - HELICOPTER TACTICS.....</b>	<b>1-1</b>
100. INTRODUCTION .....	1-1
101. GENERAL PRECAUTIONS FOR TACTICAL OPERATIONS.....	1-1
102. TACTICAL OPERATIONS.....	1-2
103. POWER CHECKS.....	1-2
104. CONFINED AREA OPERATIONS.....	1-4
105. CONFINED AREA LANDING .....	1-6
106. CONFINED AREA TAKEOFF .....	1-8
107. QUICK STOP .....	1-10
108. HIGH-SPEED APPROACH.....	1-11
109. PINNACLE APPROACH/LANDING/TAKEOFF .....	1-13
110. HIGH SPEED LOW-LEVEL AUTOROTATION (DEMO ONLY).....	1-15
<b>CHAPTER TWO - EXTERNAL LOAD OPERATIONS.....</b>	<b>2-1</b>
200. INTRODUCTION .....	2-1
201. EXTERNAL LOAD OPERATIONS .....	2-1
202. EXTERNAL LOAD PICK-UP AND DROP-OFF.....	2-5
<b>CHAPTER THREE - SEARCH AND RESCUE PROCEDURES .....</b>	<b>3-1</b>
300. INTRODUCTION .....	3-1
301. SEARCH AND RESCUE PROCEDURES AND PATTERNS.....	3-1
<b>CHAPTER FOUR - SHIPBOARD OPERATIONS .....</b>	<b>4-1</b>
400. INTRODUCTION .....	4-1
401. SHIPBOARD OPERATIONS .....	4-1
402. FIELD DECK LANDING PRACTICE.....	4-1
403. DECK LANDING QUALIFICATION .....	4-6
404. SHIPBOARD INSTRUMENT APPROACHES .....	4-9
405. PRIMARY MARSHAL APPROACH (TACAN EQUIPPED SHIPS).....	4-11
<b>CHAPTER FIVE - COMMUNICATIONS.....</b>	<b>5-1</b>
500. INTRODUCTION .....	5-1
501. COMMUNICATIONS .....	5-1
502. LOOKOUT COMMUNICATIONS .....	5-4
<b>CHAPTER SIX - FORMATION FLIGHT .....</b>	<b>6-1</b>
600. INTRODUCTION .....	6-1
601. FORMATION FLIGHT.....	6-1

602.	HELICOPTER FORMATION BRIEF .....	6-19
603.	NATOPS BY-EXCEPTION BRIEF .....	6-28
<b>CHAPTER SEVEN - LOW-LEVEL FORMATION .....</b>		<b>7-1</b>
700.	INTRODUCTION .....	7-1
701.	SECTION LOW-LEVEL FORMATION FLIGHT.....	7-1
<b>CHAPTER EIGHT - NIGHT VISION DEVICES &amp; NIGHT TACTICS.....</b>		<b>8-1</b>
800.	INTRODUCTION .....	8-1
801.	NIGHT VISION GOGGLES.....	8-7
802.	NVG CREW COORDINATION.....	8-16
803.	SAFETY CONSIDERATIONS.....	8-17
804.	NVG HUMAN FACTORS.....	8-19
805.	NVG PREFLIGHT .....	8-24
806.	NVG GOGGLE/DEGOGGLE PROCEDURES.....	8-42
807.	AIRCRAFT NVG COMPATIBILITY .....	8-43
808.	NVG SCENE INTERPRETATION .....	8-44
809.	LLL CONSIDERATIONS.....	8-49
810.	NVG MANEUVERS .....	8-50
811.	NVG NAVIGATION.....	8-63
<b>APPENDIX A - GLOSSARY.....</b>		<b>A-1</b>
A100.	NOT APPLICABLE .....	A-1
<b>APPENDIX B - FDLP/SHIP QUAL CARD.....</b>		<b>B-1</b>
<b>APPENDIX C - EMERGENCY PROCEDURES.....</b>		<b>C-1</b>
<b>APPENDIX D - SAMPLE LZ DIAGRAM.....</b>		<b>D-1</b>



## TABLE OF FIGURES

Figure 1-1	Confined Area Approach and Landing .....	1-7
Figure 1-2	Confined Area Takeoff.....	1-9
Figure 3-1	Creeping Line Single Unit.....	3-6
Figure 3-2	Expanding Square Pattern.....	3-7
Figure 3-3	Sector Search.....	3-8
Figure 3-4	Windline Rescue Pattern.....	3-11
Figure 4-1	Top and Stern View of HLT (IX-514).....	4-3
Figure 4-2	Wind Limits.....	4-5
Figure 4-3	Day Pattern.....	4-9
Figure 4-4	Approach Chart Air Capable Ships TACAN.....	4-12
Figure 4-5	Approach Chart Air Capable Ships NDB (Helicopter).....	4-13
Figure 4-6	Approach Chart LPH/LHA TACAN (Helicopter) .....	4-15
Figure 4-7	NDB/TACAN Overhead.....	4-17
Figure 4-8	ELVA Pattern.....	4-18
Figure 4-9	ELVA Radio Calls.....	4-19
Figure 5-1	Lookout Responsibilities .....	5-4
Figure 6-1	Formation .....	6-2
Figure 6-2	Wing's Cruise Position .....	6-6
Figure 7-1	Combat Cruise .....	7-2
Figure 8-1	EM Spectrum .....	8-1
Figure 8-2	Illuminance and Luminance .....	8-2
Figure 8-3	Twilight Levels .....	8-4
Figure 8-4	Online Interface for the SLAP Application (Version 1.5).....	8-6
Figure 8-5	Lunar Daily Illuminance Graph.....	8-6
Figure 8-6	SLAP Application Lunar Elevation/Azimuth Chart Output Display.....	8-7
Figure 8-7	AN/AVS-9R NVG.....	8-8
Figure 8-8	Binocular Assembly .....	8-9
Figure 8-9	MCP .....	8-10
Figure 8-10	Phosphor Screen.....	8-10
Figure 8-11	Diopter Adjustment .....	8-11
Figure 8-12	NVG Mount .....	8-13
Figure 8-13	NVG Control Functions .....	8-14
Figure 8-14	NVG Battery Packs.....	8-15
Figure 8-15	NVG Inspection and Adjustment Procedures (Steps 1 through 4) .....	8-25
Figure 8-16	NVG Inspection and Adjustment Procedures (Steps 5 and 6).....	8-26
Figure 8-17	NVG Inspection and Adjustment Procedures (Step 7).....	8-27
Figure 8-18	NVG Inspection and Adjustment Procedures (Step 8).....	8-27
Figure 8-19	NVG Inspection and Adjustment Procedures (Step 9).....	8-28

<b>Figure 8-20</b>	<b>NVG Inspection and Adjustment Procedures (Step 10).....</b>	<b>8-28</b>
<b>Figure 8-21</b>	<b>NVG Binocular Assembly Mounting .....</b>	<b>8-29</b>
<b>Figure 8-22</b>	<b>NVG Alignment and Sight Picture .....</b>	<b>8-30</b>
<b>Figure 8-23</b>	<b>AN/AVS-9R Alignment Procedures (Steps 1 through 3).....</b>	<b>8-31</b>
<b>Figure 8-24</b>	<b>NVG Alignment Procedures (Step 4) .....</b>	<b>8-32</b>
<b>Figure 8-25</b>	<b>Optimal Eyepiece or Diopter Adjustment .....</b>	<b>8-34</b>
<b>Figure 8-26</b>	<b>NVG Focus Procedures .....</b>	<b>8-35</b>
<b>Figure 8-27</b>	<b>Image Defects .....</b>	<b>8-36</b>
<b>Figure 8-28</b>	<b>ANV-20/20 NVG Infinity Focus Device Front Control Panel.....</b>	<b>8-40</b>
<b>Figure 8-29</b>	<b>ANV-20/20 NVG Infinity Focus Test Pattern .....</b>	<b>8-41</b>

## **CHAPTER ONE HELICOPTER TACTICS**

### **100. INTRODUCTION**

This chapter introduces the student to the basic fundamentals of helicopter tactics. The procedures contained herein are intended to provide a foundation for tactical flying which will meet most mission requirements.

### **101. GENERAL PRECAUTIONS FOR TACTICAL OPERATIONS**

Certain general rules apply to all tactical landings. Some of the more important of these rules are:

1. Know wind direction and approximate velocity at all times. Plan landings and takeoffs with this knowledge in mind.
2. Plan the flight path for approach and takeoff to take maximum advantage of forced landing areas.
3. Operate the helicopter as near to its normal capabilities as the situation allows. The angle of descent should be no steeper than necessary to clear existing barriers and to land on a preselected spot. Angle of climb in takeoff should be no steeper than necessary to clear all barriers in the takeoff path.
4. In order to minimize the effect of turbulence and to conserve power the helicopter should be hovered at a lower altitude than normal when in a confined area. High grass or weeds will decrease efficiency of ground effect; but hovering low or taking off from the ground will partially compensate for this loss of ground effect.
5. Make every landing to a specific point, not merely into a general area. The more confined the area, the more essential it is for the helicopter to be landed precisely upon a definite point. The landing point must be kept in sight during the final approach, particularly during the more critical final phase.
6. Consideration should be given to increases in terrain elevation between the point of original takeoff and subsequent areas of operation.
7. In entering any restricted area, judge the diameter of the main rotor system to ensure clearance, but remain especially alert to prevent possible damage to the tail rotor. Not only must the angle of descent over a barrier clear the tail rotor of all obstructions, but caution must be exercised on the ground to avoid swinging the tail rotor into trees, boulders, or other objects. The pilot is responsible for ensuring personnel remain clear of the tail rotor at all times.
8. Understanding the difference between “power required exceeds power available” and “vortex ring state” may save your life. Learn and understand what each one means.

- a. “Power required exceeds power available” is a condition wherein the power required to maintain the current flight mode is in excess of the power available.
- b. “Vortex ring state” is a condition of powered flight wherein the aircraft settles in its own downwash.

## 102. TACTICAL OPERATIONS

### Application

To survive in a threat environment, a helicopter pilot must be able to operate while avoiding enemy detection. The pilot must learn to avoid enemy fields of fire to minimize the small arms threat and use and understand terrain masking techniques and various flight modes to counter an enemy threat.

Each pilot should become familiar with three flight modes: low-level flight, contour flight, and nap-of-the-earth flight. Each flight mode has a specific application and was developed to enhance survivability.

Once the mode of flight has been selected, the pilot must select the type of approach and landing to be used at the landing zone (LZ). Tactical approaches are conducted based on the anticipated threat, the initial approach point, and the final approach course. Several planning factors must be considered when determining which type of tactical approach to employ at a particular LZ. Some of these are size and configuration, helicopter performance, and size or number of aircraft in the flight.

To assist escort aircraft and allow maximum deception enroute to the LZ, a standard flight profile should be used to facilitate flight coordination between all members of the flight. In the training command, a standard 360° overhead approach is used to enter the LZ.

## 103. POWER CHECKS

### 1. Application

Power checks are conducted to determine the power available (the power the engine is capable of providing) and the power required (the power the engine will need to provide in order to accomplish the planned operation). Prior to any flight operation, the expected power required to hover in ground effect/hover out of ground effect (HIGE/HOGE) shall be computed using the tables in NATOPS. Additionally, prior to conducting any Confined Area Landing (CAL) or external load operations, an operational power check shall be conducted.

The major variables affecting power required are gross weight, density altitude (DA) (pressure altitude, humidity, outside temperature), and wind. Changes in any of these variables from the values used in the HIGE/HOGE computations will cause a difference between the computed HIGE/HOGE power required and the power actually required at the site. For example, if the aircraft is heavier than planned, actual hover torque, (power required) will be greater than

computed; if there is more wind than planned, actual hover torque will be less than computed; if DA is higher than planned, then hover torque will be higher than planned.

Power available is the power the engine can produce given a certain density altitude. As with any aircraft, a helicopter will not continue flying in any state where power required exceeds power available. In virtually all cases involving HIGE/HOGE, the power available in the TH-57 is torque limited - that is, the transmission torque/time limits will be exceeded before any engine limitation is reached if the engine is *operating correctly*. Thus, once engine performance parameters (turbine outlet temperature (TOT), turbine speed ( $N_g$ )) have been checked in limits, power available in the TH-57 can be assumed to be 85% (unlimited) and 100% (five minutes). The 100 to 110 percent torque is for transient conditions and should not be used for planning.

During preflight planning, a ten percent safety margin between HOGE power required (computed) and power available (100% Q) should be ensured. A reduction of the fuel load or a planned “burn down” of fuel may be necessary to achieve this. During the operational power check, actual torque required to hover out of ground effect shall not be greater than 90% torque before beginning CAL or external load operations. This will allow a ten percent margin between power available (100%) and power required (actual HOGE) to prevent settling with the external load or due to loss of wind effect in a CAL.

## 2. Description

To conduct an operational power check, the base HIGE/HOGE must first be calculated for a specific aircraft containing a specific fuel load and given the current environmental conditions (pressure altitude and temperature). The necessary charts required to determine the aircraft base HIGE/HOGE capability are located in the NATOPS Pocket Checklist (PCL). The checklist contains specific information on fuel loads, center of gravity, and HIGE/HOGE.

To determine the HIGE/HOGE capability of the aircraft you will need the aircraft's base weight as determined in the weight and balance (a copy of the weight and balance should be carried with you in the aircraft). From this base weight, you will add your crew complement and current fuel load. Fuel weight is available in the PCL under the Reference Data section. Once this information is combined, you will have your current operating weight.

After you have calculated your operating weight, you will need to determine your pressure altitude. This can be accomplished by setting the barometric altimeter to 29.92 and reading off the altitude.

With the pressure altitude and your operating weight, you will go into the PCL to the Hover-Torque Required chart to determine your base HIGE/HOGE information. Verify the accuracy of the calculations by establishing a 5' AGL hover for a HIGE check and then a 50' AGL hover for HOGE check.

### 3. Common Errors and Safety Notes

- a. If the power required during the operational check exceeds the calculated power required, do not continue with or undertake the planned operations until determining the cause of the actual power required exceeding the calculated power required. While errors in calculation or environmental variables differing from those used in preflight planning may account for the discrepancy between actual and calculated power required, a potentially hazardous cause may be that the aircraft gross weight is higher than the gross weight used in the planning phase. If actual power required exceeds calculated power required, and an incorrect gross weight is suspected to be the cause of the discrepancy, ensure that the current aircraft configuration is within proscribed gross weight and center-of-gravity limitations before proceeding with planned operations.
- b. Conducting a power check in a hover at 50' AGL requires operating in the AVOID area of the Height Velocity Diagram. If a transition to forward flight is accomplished from a 50' hover, the profile will also involve operations in the AVOID area of the Height Velocity Diagram. Protracted operations in the AVOID areas of the Height Velocity Diagram are prohibited and pilots should utilize caution in the performance of the hover power check and subsequent transition.
- c. If descending from 50' AGL to a lower hover or to effect a landing, avoid excessive descent rates that may lead to power required exceeding power available or entry into vortex ring state conditions.
- d. Ensure that the barometric altimeter is reset to last obtained value at the conclusion of the power check procedures.

## 104. CONFINED AREA OPERATIONS

### 1. General

Crewmembers other than the pilot and copilot are assigned to fly on almost all fleet aircraft, performing a variety of mission-unique tasks. As highly skilled individuals, they contribute to the successful completion of your mission. They assist in terrain recognition and observe for clearance of obstacles during hovering and landing. During external load operations and CALs, the crewman is the pilot's primary means of observing and relaying vital information external to the aircraft.

The crewman is responsible to the pilot for preflight briefings and procedures specific to external load operations and CALs.

### 2. CAL Brief

An example of the TH-57 crewman's brief for CALs is as follows:

- a. Aircrew seating
- b. CAL zone brief:
  - i. Height of obstacles which will determine the approach angle
  - ii. Size and topography of the LZ
  - iii. Entry Route/Possible loss of wind effect
  - iv. Power available
  - v. Departure route
- c. Pilot reports “*on final*”
- d. Descent clearance (every five seconds)
- e. Tail rotor clearance
- f. Pilot advises crew of intentions
- g. Clearance requirements:
  - i. Aircrewman
  - ii. Non-flying pilot
  - iii. Obstacle clearance (minimum ten feet)
  - iv. Turns (90° maximum)
  - v. Landing (clearance)
  - vi. Lift to hover (clearance)
  - vii. Departure (radio call, clearance)

#### **NOTES**

- 1. Always yield right-of-way to aircraft with external load.
- 2. Waveoff and hold are mandatory voice and hand signals.

### 3. Emergency Procedures

- Intercom System (ICS) failure
  - i. Alert pilot
  - ii. Waveoff or land:

If not committed to LZ – waveoff

If committed to LZ – land using push/pull method on pilot's shoulder

- iii. Troubleshoot on deck
- iv. Reposition for departure using Landing Signalman Enlisted (LSE) signals
- v. Departure clearance

## 105. CONFINED AREA LANDING

### 1. Application

The CAL and approach is a steep, power-controlled approach used when the intended point of landing is surrounded by obstacles preventing a normal approach glideslope. The techniques of utilizing power and cyclic coordination to effect a precision descent shall be used in the confined area approach and landing.

### 2. Description

Use a pattern altitude of 300 to 500 feet Above Ground Level (AGL) and 70 Knots Indicated Airspeed (KIAS). Make a reconnaissance of the LZ to ensure the area is clear and check the best arrival and departure routes. Descend to no lower than 200 feet AGL and go no slower than 50 KIAS on the reconnaissance pass. Planning the approach requires consideration of several factors. First, account for wind conditions, critical in the TH-57, and choose the best avenue of approach, taking advantage of wind effects and lowest obstruction for best entry into the zone. Second, plan the flight path to place the helicopter within autorotative distance of areas most favorable for a forced landing. Third, when it is not possible to keep the LZ in sight, specific reference points along the flight path should be selected to keep the pilot from losing the area completely while maneuvering. Finally, ensure sufficient power is available prior to attempting the approach.

When abeam the intended point of landing at pattern altitude and airspeed of 300 to 500 feet AGL and 70 KIAS, simultaneously commence a descending, decelerating turn to arrive at the 90° position with 300 feet AGL and 60 KIAS (same 90° position as in a steep approach).



Anticipate a level-off at 300 feet AGL and continue to decelerate to arrive on the courseline with 800 to 1000 feet of straightaway at 300 feet AGL. Report “*on final*” when established. Continue to decelerate to 45 KIAS while approaching the glideslope.

As the helicopter intercepts the glideslope (25 – 45 degrees), reduce power to begin the descent. Visualize the glideslope and closure rate to the intended point of landing. Adjust power as necessary to maintain the glideslope. If the glideslope becomes excessive (greater than 45°) or uncomfortable, wave off.

Once established on the glideslope, adjust the angle of descent such that the tail rotor will clear the downwind obstruction by at least ten feet and the touchdown area will be in the upwind one third of the LZ. Smooth, coordinated cyclic and collective inputs are required to maintain the glideslope without requiring excessive power (Figure 1-1).

Anticipate sloping or rough terrain in the LZ; therefore, first approach should be made to a hover before landing.

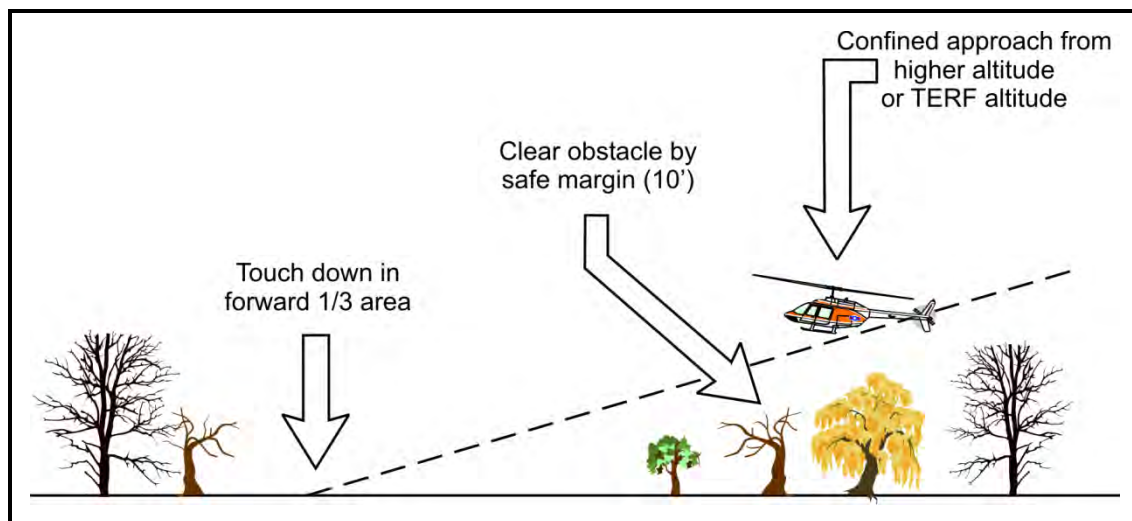

**Figure 1-1 Confined Area Approach and Landing**

### 3. Crew Resource Management

- a. Aircrewman describes confined area LZ to other crewmembers. (Communication)
- b. Pilot at Controls (PAC) reports “*on final*” when established. (Communication)
- c. Aircrewman reports “*clear right*” when established in descent. (Communication)
- d. Pilot (Left Seat) reports “*clear left*” when established in descent. (Communication)
- e. Aircrewman and Pilot (Left Seat) report “*clear right/left, tail in the zone,*” once clear of obstacles. (Communication)

#### 4. Common Errors and Safety Notes

- a. Ensure power required to land does not exceed power available.
- b. Rate of closure is critical. As the rate of closure increases, rate of descent also increases. Avoid descent rates in excess of 800 feet per minute (FPM) when airspeed is below 40 KIAS; vortex ring state may result.
- c. Whenever the glideslope exceeds 45° or the approach becomes uncomfortable, wave off.
- d. As the helicopter crosses the obstruction, ensure the crew has cleared the tail rotor. If not cleared, then wave off.
- e. Anticipate a loss of wind effect or turbulence as the helicopter nears and descends below the obstruction.
- f. Failure to reduce collective a sufficient amount when intercepting the glideslope will cause ballooning or steepening of the glide angle.
- g. While in the confined area LZ, any aircraft movement shall be cleared by all crewmembers prior to commencement. The aircraft may be turned a maximum of 90° at a time.

### 106. CONFINED AREA TAKEOFF

#### 1. Application

The confined area takeoff is a precision maneuver designed to provide proper obstacle clearance and minimal exposure to the Caution/Avoid areas of the Height-Velocity Diagram.

#### 2. Description

Prior to landing in a confined area, ensure power required does not exceed power available. If sufficient power is not available to take off from a confined area, do not land in one. Check Paragraph 103 for power check.

Select the best takeoff route optimizing wind and the lowest obstruction combination. Remember, include a minimum of ten feet of clearance from the highest obstruction on the intended flight path. If possible, the takeoff should be initiated from the downwind one third of the LZ. This will provide the most shallow departure glideslope.

Receive clearance from crewman and pilot for takeoff and call on UHF, “(Aircraft call sign), lifting CAL Zone \_\_\_\_\_.”

From a hover, check the gauges and caution lights, and smoothly increase power to establish a sufficient rate of climb and angle of ascent to clear the highest obstacle by ten feet (tip path plane above highest obstacle). When able, begin a smooth acceleration and transition to a normal takeoff. Keep the scan moving and CONTINUALLY CLEAR ALL PARTS OF THE HELICOPTER (Figure 1-2).

When clear of all immediate obstructions, maneuver as necessary to avoid other obstacles while gaining airspeed as soon as possible.

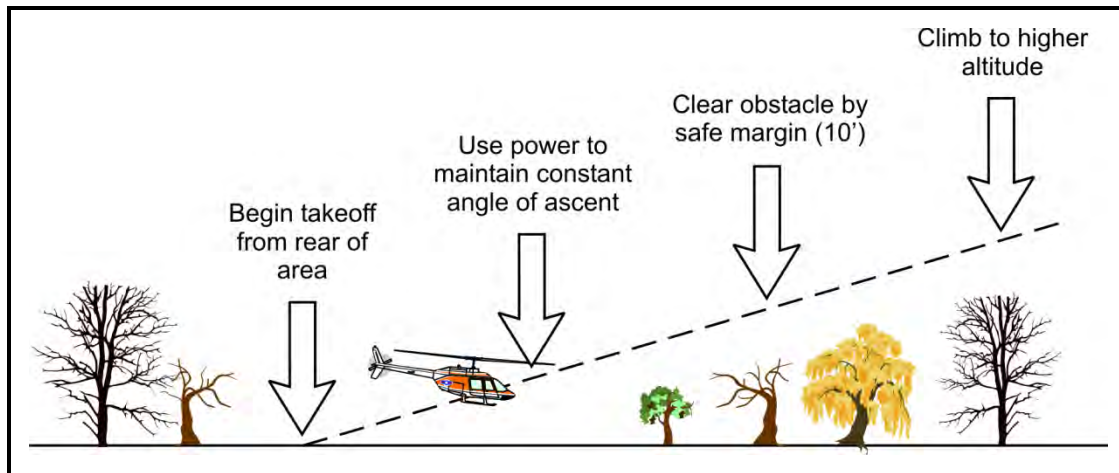

**Figure 1-2 Confined Area Takeoff**

### 3. Crew Resource Management

- a. PAC calls lifting CAL zone. (Communication)
- b. Aircrewman and Pilot (Left Seat) report “*clear right/left, out of the zone.*” (Communication)

### 4. Common Errors and Safety Notes

- a. Do not practice CALs without another aircraft available as a safety observer. Repositioning the crash crew to the confined area of the field is required if no aircraft is available.
- b. Always ensure tail rotor clearance prior to maneuvering in the zone. A tail rotor strike may occur, resulting in complete loss of tail rotor thrust.
- c. Rushing the maneuver may cause settling, poor yaw control, and loss of obstruction clearance. Confined area takeoffs are precision maneuvers and require more time and concentration than normal takeoffs.
- d. Smooth control coordination is required throughout the takeoff. Use power judiciously.

- e. Because the helicopter is below the obstructions, the wind may not provide extra lift until clear of the obstructions.

## 107. QUICK STOP

### 1. Application

The quick stop enables the pilot to develop the control coordination required to decelerate the helicopter as quickly as possible while keeping the helicopter in a safe flight envelope.

### 2. Description

Quick stop is a coordinated deceleration of the helicopter while maintaining constant heading and altitude.

### 3. Procedures

- a. Maintain 500 feet AGL and accelerate to 100 KIAS on the downwind.
- b. At the 180° position, begin a descending turn towards the coursesline and maintain balanced flight.
- c. Arrive at the 90° position at 300 feet AGL and 100 KIAS.
- d. Intercept the coursesline at 100 KIAS and continue the descent to 50 feet AGL. Establish crosswind corrections as necessary.
- e. Stabilize momentarily at 50 feet AGL, 100 KIAS, then coordinate down collective and aft cyclic to slow the aircraft while maintaining constant heading and altitude.
- f. Slow to 45 KIAS airspeed.
- g. Recover by coordinating up collective and forward cyclic while maintaining constant heading and altitude.
- h. Accelerate to 70 KIAS and resume a normal climb.

### 4. Amplification and Technique

Establish the helicopter downwind at 500 feet AGL and 100 KIAS. From the 180° position (approximately the downwind boundary), at 500 feet AGL and 100 KIAS, commence a descending turn to arrive at the 90° position at 300 feet AGL and 100 KIAS.

Continue the turn and descent, maintaining safe obstacle clearance, to arrive on the coursesline at 50 feet AGL and 100 KIAS.

Once the altitude and airspeed have stabilized, smoothly coordinate down collective with aft cyclic and right rudder to slow the helicopter as rapidly as possible while maintaining a constant heading and altitude. Simultaneous coordination of flight controls is required.

Commence the recovery by coordinating forward cyclic, up collective, and left rudder in sufficient time to recover the aircraft at 50 feet AGL and 45 KIAS. Check engine instruments and accelerate to the 70 KTS climb airspeed.

A recovery initiated at approximately 48 KIAS should enable the aircraft to decelerate to 45 KIAS.

The more the collective is lowered in coordination with aft cyclic inputs, the faster the aircraft will decelerate. If collective is not lowered enough the aircraft may not slow to 45 KIAS prior to the upwind field boundary.

### **5. Common Errors and Safety Notes**

- a. Avoid the common tendency to let the airspeed get excessively slow during the recovery.
- b. Avoid the common tendency to descend or balloon on entry due to poor cyclic and collective control coordination.
- c. The quick stop shall be initiated by the middle of the field.
- d. Safe obstacle clearance shall be maintained throughout the entire maneuver.

## **108. HIGH-SPEED APPROACH**

### **1. Application**

The high-speed approach is a maneuver used to develop the coordination to safely land the helicopter from an approach with a high rate of speed.

### **2. Description**

The high-speed approach enables the pilot to make a safe transition from high speed low-level flight to a steep approach terminating in a hover or no-hover landing.

### **3. Procedures**

- a. Maintain 500 feet AGL and accelerate to 100 KIAS on the downwind.
- b. At the 180° position, begin a descending turn towards the courseline. Maintain balanced flight.

- c. Arrive at the 90° position with 300 feet AGL and 100 KIAS.
- d. Intercept the courseline at 100 KIAS and continue the descent to 50 feet AGL. Establish a crosswind correction as necessary.
- e. Stabilize momentarily at 100 KIAS and 50 feet AGL, then coordinate down collective and aft cyclic to slow the helicopter. Maintain constant heading and altitude.
- f. Begin the descent when a 25 - 45 degree glideslope IAW contact FTI steep approach can be maintained.
- g. Terminate the approach in a hover or no-hover landing.

#### 4. Amplification and Technique

Establish the helicopter downwind at 500 feet AGL and 100 KIAS. From the 180° position (approximately the downwind field boundary), at 500 feet AGL and 100 KIAS, the pilot shall commence a descending turn to arrive at the 90° position at 300 feet AGL and 100 KIAS. Continue the turn and descent, maintaining a safe obstacle clearance to arrive on the courseline at 50 feet AGL and 100 KIAS. Establish crosswind corrections as necessary.

Once altitude and airspeed have stabilized, the pilot shall initiate a quick stop maneuver by simultaneously coordinating down collective with aft cyclic and right rudder, while maintaining a constant altitude and heading. Failure to sufficiently lower the collective or applying an abrupt aft cyclic movement will cause the helicopter to balloon. Maintain constant altitude and ground track.

Coordinate cyclic and collective to continue the deceleration to arrive at a steep approach glideslope with 50 feet AGL and 15 to 20 KTS groundspeed.

Adjust the rate of descent and rate of closure to arrive over the intended point of landing at zero groundspeed and hover altitude.

Cyclic, collective, and directional control pedals must be coordinated to slow the helicopter while maintaining a constant heading and altitude. The pilot must anticipate the distance required to decelerate the aircraft and establish the helicopter on a steep approach glideslope to the intended point of landing.

This approach may be terminated in a hover or no-hover landing. However, don't surprise your instructor. Communicate so both pilots are fully aware of your intention.

#### 5. Common Errors and Safety Notes

- a. See the "Common Errors and Safety Notes" under "QUICK STOP" (Section 107).
- b. Failure to maintain 100 KIAS until beginning the deceleration.

- c. Descending below 50 feet AGL on final.
- d. Failure to momentarily stabilize at 100 KIAS and 50 feet AGL.
- e. Allowing the aircraft to balloon.
- f. Failure to maintain heading and ground track.
- g. Failure to establish a 25 – 45 degree glideslope IAW contact FTI steep approach and maintaining a constant glideslope during the approach.
- h. An excessively nose high attitude at low altitude may result in the tailskid contacting the ground, which may cause serious structural damage to the aircraft.
- i. The nose attitude of the aircraft, once established on the steep approach glideslope, may be well above a normal steep approach due to the rapid deceleration required to perform this maneuver correctly. Anticipate arrival on the glideslope with a higher nose attitude than normal. Maintain 50 feet AGL until established on the glideslope.

## 109. PINNACLE APPROACH/LANDING/TAKEOFF

### 1. Application

The pinnacle approach and landing is a precision, power-controlled approach used when the intended point of landing is elevated above the surrounding terrain. The techniques of utilizing power and cyclic coordination to effect a normal or precision descent shall be used in the pinnacle approach and landing. The pinnacle takeoff is a precision maneuver designed to provide obstacle clearance and minimize flight in the Caution/Avoid areas of the Height-Velocity diagram when transitioning to takeoff from an elevated LZ.

### 2. Description

Perform a power check prior to attempting the approach. Use pattern altitude of 300 to 500 feet AGL and 70 KIAS. Make a reconnaissance of the LZ to ensure the area is clear and check the best arrival and departure routes. Descend no lower than 200 feet AGL and go no slower than 50 KIAS on the reconnaissance pass. Planning the approach requires consideration of several factors. First, choose the approach direction which allows for taking advantage of wind effects, provides the lowest obstruction and best entry into the zone. Second, plan the flight path to place the helicopter within autorotative distance of areas most favorable for a forced landing. Third, when it is not possible to keep the LZ in sight, specific reference points along the flight path should be selected to keep the pilot oriented while maneuvering.

When abeam the intended point of landing and at pattern altitude and airspeed, simultaneously commence a descending, decelerating turn to arrive at the 90° position at 300 feet AGL and 60 KIAS.

For the steep approach, anticipate a level-off at 300 feet AGL and continue to decelerate to arrive on the course line with 800 to 1000 feet of straightaway. Continue to decelerate to 45 KIAS while approaching the glideslope. For the normal approach, intercept the course line between 150 to 200 feet AGL, 50 KIAS, and 600 to 800 feet of straightaway.

As the helicopter intercepts the glideslope (10 – 20 degrees for normal, 25 – 45 degrees for steep), reduce power to begin the descent. Visualize the glideslope and closure rate to the intended point of landing. Adjust power as necessary to maintain glideslope. A waveoff should be executed if the glideslope becomes excessive (greater than 45°).

Once established on the glideslope, adjust the angle of descent such that the tail rotor will clear any downwind obstacles by at least ten feet. Smooth, coordinated cyclic and collective inputs are required to maintain the glideslope without requiring excessive power adjustments on final.

Anticipate sloping or rough terrain in the LZ. Plan on stabilizing in a hover prior to touchdown.

IP's may execute vertical or no hover landing on first approach. No hover landings may be executed by the Student and/or IUT after one vertical landing has been accomplished.

Select the best takeoff route optimizing wind effects and lowest obstruction combination. Remember to include a minimum clearance of ten feet from the highest obstruction on the intended flight path.

After the completion of a clearing turn, check gauges and caution lights, and smoothly increase power to establish a sufficient rate of climb and angle of ascent to clear the highest obstacle by ten feet (tip path plane above the highest obstacle). When able, begin a smooth acceleration and transition to forward flight. Keep the scan moving and CONTINUALLY CLEAR ALL PARTS OF THE HELICOPTER.

### 3. Crew Resource Management

Aircrewman describes Pinnacle to other crewmembers. (Communication)

PAC reports "*on final*" when established. (Communication)

Aircrewman reports "*clear right*" when established in descent. (Communication)

Pilot (Left Seat) reports "*clear left*" when established in descent. (Communication)

Aircrewman and Pilot (Left Seat) report "*clear right and down, clear left and down,*" once over the LZ. (Communication)

Aircrewman and Pilot (Left Seat) report "*clear right/left, out of the zone aircrewman.*" (Communication)



#### 4. Common Errors and Safety Notes

- a. Rate of closure is critical. As the rate of closure increases, the rate of descent also increases. Avoid descent rates in excess of 800 FPM when airspeed is below 40 KIAS; vortex ring state may result.
- b. Whenever the glideslope exceeds 45° or the approach becomes uncomfortable, wave off.
- c. Failure to sufficiently reduce the collective when intercepting the glideslope will cause ballooning or steepening of the glideslope angle.
- d. Ensure the aircrewman clears the landing area prior to landing. Failure to wait for the aircrewman's "*clear to land*" may result in dynamic rollover caused by excessive lateral drift or improper placement on the pinnacle.
- e. Smooth control coordination is required throughout the takeoff. Rushing the maneuver may cause settling and poor yaw control resulting in loss of obstacle clearance.
- f. Ensure the crew is adequately briefed and crew resource management (CRM) is stressed throughout the conduct of the flight.

#### 110. HIGH SPEED LOW-LEVEL AUTOROTATION (DEMO ONLY)

1. **Maneuver Description.** A high-speed low-level autorotation is an instructor-demonstrated maneuver simulating a loss of power at high airspeed and low altitude.

#### 2. Procedures

- a. Maintain 500 feet and accelerate to 100 KTS on the downwind.
- b. At the field boundary, begin a descending turn to arrive on course with the intended landing area at 100 feet AND 100 KTS.
- c. While maintaining the collective setting, smoothly rotate the twist grip to flight idle. Adjust the collective to maintain  $N_r$  limits.
- d. Smoothly apply aft cyclic, initiating a flare to dissipate airspeed and prevent the aircraft from settling.
- e. As the aircraft reaches the checkpoints of a standard autorotation, complete normal autorotation procedures.

### 3. Amplification and Technique

The key to a successful high speed low-level autorotation is smooth control inputs as the pilot dissipates excess airspeed while maintaining altitude and  $N_r$  and transitioning to normal autorotative parameters.

In the event that the pilot desires to gain altitude immediately, a more forceful flare will not only dissipate airspeed, but could result in the gain of 100 to 150 feet of additional altitude. Such a flare will also help maintain  $N_r$  initially.

As the airspeed approaches 65 KTS, smoothly adjust the nose to the appropriate descending attitude, and reduce the collective to control  $N_r$  (94 - 95% optimum). Take care to avoid a low "G" envelope as the aircraft crosses the peak of its climb.

Recover as a power recovery or full autorotation.

#### CAUTION

If a cyclic flare is initiated to gain altitude and dissipate excess airspeed, use extreme caution to avoid a less than one "G" pushover to prevent possible mast bumping. Allowing the aircraft to slow excessively at the apex will result in a reduction of mass airflow through the rotors causing  $N_r$  to decay.

## **CHAPTER TWO EXTERNAL LOAD OPERATIONS**

### **200. INTRODUCTION**

This chapter introduces the student to the basic fundamentals of external load operations. The procedures contained herein are intended to provide a foundation for external load operations, which will meet most mission requirements.

### **201. EXTERNAL LOAD OPERATIONS**

#### **1. Application**

The two basic modes of helicopter cargo transport is internal and external loading. Only external loads will be discussed in this section. The NATOPS manual of each type helicopter capable of external load operations should be consulted prior to attempting such a mission. Performance charts in the NATOPS manual include gross weight limitations, airspeed limitations, and endurance charts. The manual also gives a complete operational explanation of the cargo sling release systems.

Preflight briefings, weight and balance computation, and HIGE/HOGE computations along with aircraft systems checkout are essential steps to complete prior to commencing the operations. The aircraft discrepancy logbook should be closely screened for any trends regarding a malfunctioning cargo release or hookup system. Do not attempt this operation with an uncorrected discrepancy on the cargo release system.

The TH-57 has a detachable external cargo hook which is located at the center of gravity when installed. It is capable of lifting a 1500 pound load and has an electrical release on the cyclic and a manual release located between the pilots. The electrical release is the preferred method of releasing the load; however, do not hesitate to use the manual release if problems arise. There is also a manual release on the hook itself. Check all release mechanisms for proper operations prior to flight.

For external operations in the TH-57, an aircrewman is required in the helicopter and an additional aircrewman is required to be on the ground to attach the load to the cargo hook. The aircrewman in the cabin area shall give verbal directions to the pilot concerning pickup, drop, and status of the load during flight. The aircrewman will conduct an external load brief. An example of the aircrewman's brief prior to flight is as follows:

#### **2. Aircrewman External Load Brief**

- a. General
  - i. Site
  - ii. Doors

- iii. Cargo hook inspection
- iv. Aircrew seating
- v. External load (pendant length, weight)
- b. Pick-up Procedures
  - i. Pilot reports “*on final.*”
  - ii. Start giving verbal commands approximately 100 feet from the load.
  - iii. Start giving easy commands within approximately 30 feet from the load.
  - iv. Any required positioning over the load will be done using easy commands indicating direction and distance.
  - v. When helicopter is in position over the load:
    - (a). Advise pilot “*Steady, over the load.*”
    - (b). “*Man under.*”
    - (c). “*Hooked up.*”
    - (d). “*Man is clear.*”
    - (e). “*Easy up.*”
    - (f). “*Tension coming on.*”
    - (g). “*Tension is on.*”
    - (h). “*Load is clear.*”
    - (i). “*Clear for forward flight on the right.*”
- c. Drop-off Procedures
  - i. Pilot reports “*on final.*”
  - ii. Start giving verbal commands approximately 100 feet from the drop point.
  - iii. Start giving easy commands approximately 30 feet from the drop point.

- iv. Any required positioning over the drop point will be done using easy commands indicating direction and distance.
- v. When the helicopter is in position over the spot:
  - (a). Advise pilot, Steady, over the spot.
  - (b). Advise pilot of progress:
    - (1). *“Easy down.”*
    - (2). *“Load on deck.”*
    - (3). *“Easy down two feet.”*
    - (4). *“Steady.”*
    - (5). *“Release load.”*
    - (6). *“Load is clear.”*
    - (7). *“Clear for forward flight on the right.”*

#### NOTES

1. Clearance for forward flight is not given until cleared by hookup-man.
2. If drifting off the spot, stop the aircraft drift. Do not attempt to make corrections until advised.
3. Do not fly outside the field's boundaries, or over other aircraft in while the external load is attached.
4. Waveoff and hold are mandatory voice and hand signals.
5. Flying over personnel and buildings is prohibited when carrying external loads. Flight with the external load outside the field boundary of any site is prohibited.
6. Check paragraph 103 for power check requirements.
7. Weight and balance data shall also be computed prior to commencing external load operations. Do not exceed the maximum allowable weight and balance (center of gravity limits) of the helicopter. Partial loss of control of both the main rotor and tail rotor may result if limits are exceeded. Before any external

load operation, the rear compartment doors shall be removed, limiting forward airspeed.

d. Emergency Procedures

i. ICS Failure:

- (a). Alert pilot.
- (b). Use push/pull method on pilot's shoulder.
- (c). Execute drop.
- (d). Land and troubleshoot.

ii. Cargo Hook Failure:

- (a). Advise pilot "*Hold, no release.*"
- (b). Tension
- (c). Circuit breaker
- (d). Electrical release
- (e). Emergency "T" handle
- (f). In the event of total hook failure:
  - (1). Advise pilot for landing; ensure skids straddle pendant.
  - (2). Manually release pendant.
  - (3). Engine failure during pickup:
    - (i). Load, release
    - (ii). Aircraft, forward and left
    - (iii). Hook-up man, right
  - (4). Engine failure during transition:
    - (i). Load, release
    - (ii). Execute emergency landing.

## 202. EXTERNAL LOAD PICK-UP AND DROP-OFF

### 1. Maneuver Description

From a pattern altitude and airspeed of 300 feet AGL and 70 KIAS, execute a normal approach to arrive over the pickup point at ten feet AGL into the wind line.

With approximately 100 feet of straightaway remaining on the final approach, the aircrewman seated in the right seat in the passenger compartment will begin to give the pilot verbal directions for final lineup to the load. With the aircraft in a slow air taxi at ten feet AGL, the aircrewman will direct the pilot over the load to terminate in a hover.

Once established in a hover over the load, the aircrewman will signal ground personnel located on the right side of the helicopter, indicating “ready for hookup.” The ground personnel will then come under the helicopter to hook up the load. Minor hover attitude adjustments can be expected while accomplishing hookup. The hover adjustments will be directed by the aircrewman.

After the load is hooked up and ground personnel are clear, the aircrewman will give an “all clear,” and direct the pilot to begin lifting. The pilot must lift vertically over the load until slack is taken up from the pendant. At this point, the aircrewman will notify the pilot tension is coming on. This may not be felt if the pilot is smooth. At “tension on,” note the radar altimeter (RADALT) reading. The pilot must lift vertically until the load is clear of the ground (tension altitude plus five feet). The aircrewman will clear the pilot for forward flight. Do not allow the aircraft to sink or go below tension altitude plus five feet as you simultaneously gain airspeed and altitude on climbout.

Transition to forward flight and initial climb must be smooth and commensurate with the aircraft operating limitations. Sufficient power, not to exceed maximum allowable torque, must be applied on the initial takeoff transition to ensure that the load clears all obstacles by a safe altitude (usually 50 to 100 feet above the tallest immediate obstruction). Do not rush the transition as settling of the helicopter may result. Settling may cause the load to drag on the ground.

Climb slowly to 300 feet AGL while accelerating to 70 KIAS. The aircrewman will advise the pilot regarding the load position and status. Riding characteristics of external cargo loads vary greatly. Consult the NATOPS manual for unusual riding characteristics of different cargo. An unstable load may jump, oscillate, or rotate which can result in a loss of control and impose undue stresses on the helicopter. Jettisoning of the load may be necessary if oscillations are endangering the helicopter.

Abeam of the intended point of landing, 300 feet AGL and 70 KIAS, begin the approach to arrive at the 90° position with 150 to 200 feet AGL and 60 KIAS. Continue the decelerating descent to intercept the approach final at 125 feet AGL, 45 KIAS, and 400 to 600 feet of straightaway into the wind. With approximately 100 feet of straightaway remaining on final, the aircrewman will begin verbal directions for final alignment. The pilot must ensure that closure

rate and rate of descent are under control before continuing the approach. Only a limited amount of power will be available at the bottom of the approach to hover the aircraft.

With closure and descent rate under control, plan on terminating the approach in a hover ten feet above the original “tension on” altitude. The aircrewman will advise the pilot verbally concerning minor hover corrections. Once established in a hover over the intended drop point or zone, at the crewman's command, begin a vertical descent slowly and smoothly until the load is on the ground. The aircrewman will give advisory calls throughout the descent. Once the load is on the deck he will verbally signal the pilot to release the load.

## 2. Crew Resource Management

- a. PAC reports “*on final for the drop/pick*” to other crewmembers. (Communication)
- b. Aircrewman performs verbal dialogue 100 feet from the load. (Communication)
- c. Aircrewman signals ground personnel once established in a hover over the load “*Ready for hookup.*” (Communication)

## 3. Common Errors and Safety Notes

- a. Lift the load gently off the ground. Do not snatch the load off the ground.
- b. Because aircraft gross weight is increased by the load, anticipate and watch power required to lift the load. Remember, high power settings require more left rudder to hold the aircraft steady. An out-of-the-windline pickup may result in an overtorque.
- c. With the load attached, remain within the field boundaries and do not overfly personnel on the ground, buildings, or other aircraft.
- d. Ensure all equipment has been preflighted prior to attempting external load operations.
- e. Should a partial or complete power loss occur in flight, jettison the load before making a forced landing.
- f. Should a partial or complete power loss occur in a hover with the load attached, jettison the load immediately and execute a taxiing autorotation to the left and forward. The ground personnel will be moving rapidly to the right to clear.
- g. Excessive rates of descent at high gross weights can lead to power required exceeding power available.
- h. High power settings in a hover out of the windline may result in loss of tail rotor effectiveness.



- i. Because of electrical shock hazard, especially for large helicopters operating in rainy conditions, ground hook-up crews should touch the grounding wire or load to the hook and not grab the helo hook with their hands.

**THIS PAGE INTENTIONALLY LEFT BLANK**

## **CHAPTER THREE SEARCH AND RESCUE PROCEDURES**

### **300. INTRODUCTION**

This chapter introduces the student to the basic fundamentals of search and rescue (SAR). The procedures contained herein are intended to provide a foundation for SAR, which will meet most mission requirements.

### **301. SEARCH AND RESCUE PROCEDURES AND PATTERNS**

#### **1. Application**

This syllabus unit is primarily concerned with techniques used to search for survivors. References used in this unit are the NATIONAL SAR MANUAL (JCS 3-50), the NAVY SEARCH AND RESCUE (SAR) MANUAL (NTTP 3-50.1), and the SAR TACAID (NWP 3-22.5). Do not let the limited scope of this instruction create in your mind a misconception that searching is done **only** to find survivors. Sun Tzu's maxim, "All warfare is deception" is why you will search; it will likely be your task someday to expose an enemy's deception. This may include searching for a submarine hidden under the sea (using the AIR ASW SUPPLEMENT (NWP 3-22.5) and the ACOUSTIC RECONNAISSANCE MANUAL (NWP 3-55.3)), warships hidden in a vast expanse of open ocean (using the AFLOAT OTHT AND SURVEILLANCE MANUAL (NWP 3-20.7) and the AIR RECONNAISSANCE MANUAL (NWP 3-55.11)), or troops hidden in terrain (using the AH-1 TACMAN (NWP 3-22.5-AH1)). Even if your follow-on training will not include procedures to search out an enemy, you will be flying an aircraft that possesses the unique ability to fly at low altitude and slow airspeed. Therefore, regardless of platform, as a professional rotary-wing aviator you will be expected to be able to conduct a rational, short-notice search for survivors.

It would be helpful to read the following discussion with a copy of the SAR TACAID available for reference. The TACAID is designed so a pilot can, once notified of a SAR scenario, start at the front of the manual and work towards the back, finding all the information needed to execute a search. The TACAID is also written with the premise that it will be used only for a short-notice SAR scenario (one where the responding aircrew are quickly on-station). Consequently, it does not contain as much detail as the SAR MANUAL. Since this is your first introduction to airborne SAR, the following discussion is tailored to a short-notice, visual search scenario.

#### **2. Principles and Procedures**

Time is the most critical element in SAR. Three major constraints on the time available to conduct a SAR are: the fuel aboard your aircraft, the hours of daylight remaining, and the human body's limited ability to absorb conditions of exposure. You should always assume all survivors are incapacitated, capable of surviving only a short time, under great duress and requiring emergency medical care. Your ability to wisely manage time will greatly determine the success of your SAR.

You must have a reason to search. This is referred to as being cued. A classic SAR cueing example is the MAYDAY call. Once you have been cued, a probable location of the object for which you are searching is created. This location is referred to as the INITIAL POSITION. While the INITIAL POSITION is often a point, due to the inherent noisiness of the real world, it can quickly grow into an area. There are two main sources of noise/uncertainty - position error and movement error.

- a. **Position error.** This error represents the accuracy of the INITIAL POSITION. If the search object has been missing for a long time or only a general area is suspected, this error can be quite large. In short-notice SAR scenarios, position error is commonly a function of the means used to fix the INITIAL POSITION. For example, an aircraft's self-reported global positioning system (GPS) position will usually be more accurate than that aircraft's position as determined by a ship's radar. Position errors apply not only to the location of the search object but also to the location of the search unit. The NAVY SAR MANUAL has methods for determining position errors.
- b. **Movement error.** Drift forces are the source of movement errors. Movement errors are generally represented as velocity vectors. Since it is necessary to fix at least two positions to calculate a velocity, calculating movement errors will introduce an additional position error into the solution. However, in most short-notice scenarios, this additional position error is negligible.
  - i. **Aerospace drift.** This is the sum of drifts caused by aerodynamic forces. Sources of aerospace drift can be an aircraft glide, aerospace (ballistic) trajectory, or parachute drift. In order to determine an estimate of aircraft glide, it is often necessary to contact someone with knowledge of that airframe. Values for the last two can be found in the SAR TACAID.
  - ii. **Maritime drift.** This is the sum of drifts caused by maritime forces. Sources of maritime drift can be a leeway, sea current, wind current, or tidal current. Use of a datum marker buoy is the most accurate way to determine the total water current (the last three maritime forces combined). If unavailable, putting a smoke in the water or requesting a ship's set and drift can also establish a rough estimate of the local total water current. The NAVY SAR MANUAL has tables used to determine the leeway of various objects.
  - iii. The INITIAL POSITION corrected for movement over time is the DATUM. To determine a SEARCH AREA, a radius having a length equal to the sum of the position and movement errors plus an additional safety factor is drawn about the DATUM. This will result in a circular SEARCH AREA. However, few search patterns are adaptable to circular search areas. For most patterns, a square or rectangular search is more practical. In these cases, the circular area is simply boxed in. In many short-notice SAR scenarios, it is left to the ON-SCENE COMMANDER to assess the errors discussed above and use them to create the SEARCH AREA.

iv. Whether or not you will find the search object (your search's PROBABILITY OF DETECTION) is largely dependent upon solving two problems - choosing an appropriate COVERAGE FACTOR and choosing and precisely flying an appropriate search pattern.

(a). **COVERAGE FACTOR (C).** This term can be thought of as an expression of the trade-off between what you would like to do and what you can do. If time were not a factor, you would likely choose to search in a manner that would provide a 100% PROBABILITY OF DETECTION throughout the SEARCH AREA. As time is the critical factor, you will likely need to trade off PROBABILITY OF DETECTION in an attempt to search the entire SEARCH AREA at least once.

(1). **Definitions.** These are the basic search planning variables:

(i). **SWEEP WIDTH (W)** – This is the distance at which a target has the same probability of being detected outside of this range as being missed inside of this range. The SWEEP WIDTH values provided in the SAR TACAID are derived from experimentation and SAR after action reports. The values given in the visual tables are considered “uncorrected” and must be corrected for weather, fatigue, and aircraft speed. (This term represents what you would like to do.)

(ii). **TRACK SPACING (S)** – This is the distance between adjacent parallel search tracks. Your aircraft's turning radius and navigational accuracy are practical limits as to how much this value can be reduced. (This term will represent what you can do.)

(iii). **COVERAGE FACTOR (C)** – This term is mathematically defined as  $C=W/S$ . As an example, if you have the time available to use a TRACK SPACING (S) equal to the CORRECTED SWEEP WIDTH (W) of your search object, the resulting COVERAGE FACTOR will be one (1.0). If you do only one search, your PROBABILITY OF DETECTION will then be approximately 80%.

(2). **Determination.** Because the errors should not yet have become large in most short-notice SAR scenarios, it is assumed you will attempt to search your estimated SEARCH AREA at least once. The following is one method of determining a reasonable COVERAGE FACTOR (C):

- (i). Determine a DATUM and an estimated SEARCH AREA.
- (ii). Determine your limiting time factor (on-station time, daylight, exposure, etc.).
- (iii). Using the SAR TACAID, find the largest visual SWEEP WIDTH for the search object and correct it for weather and fatigue.
- (iv). Divide the SEARCH AREA by the value from step (iii) and your limiting time factor. The result will be your search speed. If this speed exceeds your helicopter's capability, multiply the SEARCH AREA by the limiting time factor and divide by your helicopter's fastest speed to obtain the TRACK SPACING (S). If this speed is less than 50 KIAS, use a search speed double that determined and plan to search the area twice. Continue to step (v).
- (v). Multiply step (iii) by the SWEEP WIDTH speed correction factor that is closest to the speed determined in step (iv) to obtain the CORRECTED SWEEP WIDTH (W).
- (vi). Skip this step if using your helicopter's fastest speed. Otherwise, multiply the SEARCH AREA by the time factor and divide by the helicopter speed and the CORRECTED SWEEP WIDTH (W) to obtain the TRACK SPACING (S).

#### NOTE

For COVERAGE FACTOR and PROBABILITY OF DETECTION calculations, the TRACK SPACING of a sector search is considered to be one-half the radius.

- (vii). Divide CORRECTED SWEEP WIDTH (W) by the TRACK SPACING (S) to obtain the COVERAGE FACTOR (C).
  - (viii). Using the SAR TACAID, determine the PROBABILITY OF DETECTION. If the search conditions change, repeat the process.
- (b). **SEARCH PATTERN DESCRIPTION AND PROCEDURES.** Deciding which search pattern to use is largely dictated by the size of the SEARCH AREA and accuracy of the INITIAL POSITION. During the SAR aircraft event, it will be up to you to determine the pattern(s), altitude(s), and airspeed(s) providing the best PROBABILITY OF DETECTION for your scenario. It is expected you will use the SAR TACAID in this process.

The following four patterns are the only ones taught in this unit of instruction (refer to the SAR TACAID for diagrams):

(1). **Parallel Patterns (P).**

- (i). Description. This pattern is normally used for a large SEARCH AREA where only the approximate INITIAL POSITION is known and there is an equal probability the target is anywhere in the SEARCH AREA.
- (ii). Procedures. To conduct a parallel pattern in the TH-57C, enter four user-defined waypoints into the GPS. Each waypoint represents one corner of the SEARCH AREA. Enter the SEARCH AREA abeam one of the waypoints with an offset equal to half the determined TRACK SPACING (S). Fly to a point abeam the **furthest adjacent** corner waypoint that is offset by half the TRACK SPACING (S). Use the ground track (TK) function of the GPS to determine crab angle while flying each track. Turn to reenter the SEARCH AREA abeam the waypoint and offset one and a half times the TRACK SPACING (S). Continue by increasing the offset after each track.

(2). **Creeping Line Patterns (Figure 3-1).**

- (i). Description. This pattern is a specialized version of the parallel pattern. It is used when the probable location of the target is thought to be on either side of a line between two points and there is more chance of the target being in one end of the search area than the other.
- (ii). Procedures. To conduct a creeping line pattern in the TH-57C, use the same procedures as for the parallel search, but enter the pattern at the waypoint nearest the most probable location of the search object. After entering, fly to a point abeam the **nearest adjacent** waypoint offset by half the determined TRACK SPACING (S).

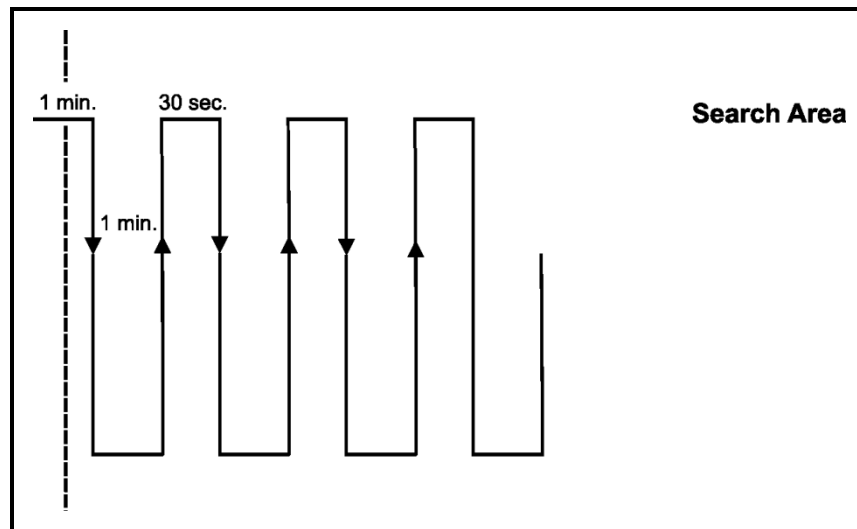

**Figure 3-1 Creeping Line Single Unit**

(3). **Square Patterns** (Figure 3-2).

- (i). **Description.** This pattern is used to search a small area where the position of survivors is known within close limits and the area to be searched is not extensive. They provide more uniform coverage than a sector search and may be expanded. Square searches are referred to as expanding square searches if they begin at the DATUM and expand outward. The full attention of the pilot will be devoted to precisely flying this pattern.
- (ii). **Procedures.** To conduct an expanding square search, enter the DATUM into the GPS as a user-defined waypoint. Once on top of DATUM, turn to the nearest cardinal radial. Start the clock. Use the TK function of the GPS to determine the crab angle necessary to track this cardinal radial. Adjust power as necessary to fly the desired groundspeed. Track outbound until reaching the appropriate TRACK SPACING (S). Note the elapsed time and turn right 90° utilizing a Slow Run Through (SRT). Restart the clock. Again, use TK function of the GPS to determine the crab angle necessary to fly a ground track corresponding to the new cardinal heading. Adjust power as necessary to maintain groundspeed. Upon reaching the time from the first leg, turn right 90° utilizing a SRT and restart the clock. Track the appropriate cardinal heading, adjust power to maintain groundspeed and use twice the initial timing. Repeat as necessary to continue expanding the square. If flown precisely, the aircraft will pass through a semi-cardinal radial halfway through three of the four turns.



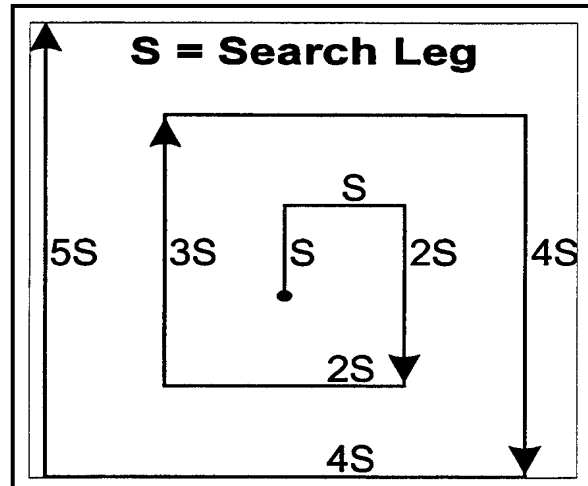
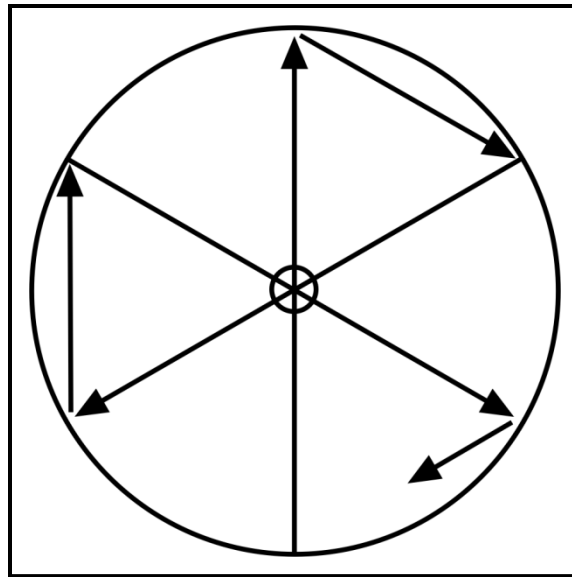

Figure 3-2 Expanding Square Pattern

(4). **Sector Patterns** (Figure 3-3).

- (i). **Description.** This pattern is used when the INITIAL POSITION is reliable or the SEARCH AREA is not extensive, and a concentration of effort is desired at DATUM because the target is difficult to detect.
- (ii). **Procedures.** To conduct a sector search, enter the DATUM as a user-defined waypoint in the GPS. On-top of the DATUM, turn to the nearest cardinal radial. A 60° sector search is normally used which consists of nine equal legs, each leg having a length equal to the radius of the search area. Upon reaching the search radius, turn right and execute a point-to-point solution to the next inbound radial. Intercept the radial and track inbound to the DATUM. Pass over the datum and track outbound on the reciprocal radial. Upon reaching the SEARCH AREA radius, turn right again and repeat. To determine the distance traveled in a sector search, multiply the search radius by 9. To determine the total time for a search, divide the distance traveled by the search speed.



**Figure 3-3 Sector Search**

- (5). **Search Pattern Precision and Effectiveness.** One of the factors that will determine the success of your search is how precisely you fly the selected pattern. Here are some factors to consider when planning and executing your search:
- (i). GPS. There is little doubt this is the most precise way to determine position available today. If installed and operable, GPS should be your primary source of navigation data. Also, many aircraft now have SAR patterns built in to the navigation computer software. If GPS is not available, there are several other less precise means for maintaining orientation.
  - (ii). Shipboard radar. The accuracy of a ship's radar is a function of its design and calibration. For example, phased array radar is considerably more accurate than generic air search radar. To minimize errors, it is often best to have the same ship that created the INITIAL POSITION vector you to that point.
  - (iii). Shipboard NAVAIDs. A position from a ship's TACAN may be used to fix the INITIAL POSITION. There are a couple of drawbacks to this method. First, ships move. This means the TACAN station you are using to determine the INITIAL POSITION is also moving. Second, at most search altitudes, you may not be able to receive the signal.

- (iv). DATUM marker buoys. If available, they should be used to mark the DATUM. They are designed to drift at a predetermined rate and have a built-in transmitter that can be used as an NDB to maintain orientation.
  - (v). Sonobuoys. If a DATUM marker buoy is unavailable, a sonobuoy can be used in the same manner. However, due to the deployed hydrophone, they do not drift at the proper rate.
  - (vi). Smokes. If no other means is available for marking DATUM, a smoke may be used. Smokes have a serious drawback. The longest burning smoke will only last between 45 and 55 minutes. If a search will last longer than this, it will be necessary to stop the search pattern to reseed the DATUM smoke.
  - (vii). Effects of wind. There is almost always wind. The best way to minimize errors created by the wind is to orient your search pattern into it as much as practicable. Also, use timing as a last resort.
  - (viii). Radius of turn. With the small track spacing typical of short-notice SARs, failing to take radius of turn into account when executing your pattern will result in it not being flown correctly.
  - (ix). Flying vs. Searching. Flying a precise pattern will require a good deal of concentration on the part of the flying pilot. This will detract from the flying pilot's ability to scan for survivors. Since all Fleet aircraft fly with an aircrew, they should be assigned to scan for survivors on the same side of the aircraft as the flying pilot (usually the right side). Additionally, if the non-flying pilot is busy performing ON-SCENE COMMANDER duties or planning the search pattern, this should also be taken into account.
- (6). Rescue Pattern Descriptions and Procedures. The goal of a SAR is the rescue. Once a survivor is found, a rescue must be commenced. The type of rescue pattern used will be determined by whether the rescue will take place during the day or night.
- (i). Day rescue. During the day, the foremost rule is this: Never take eyes off the survivor. A pattern shall be flown in such a way that whoever had sight of the survivor will be allowed to maintain visual contact.

- (ii). Night rescue. The windline rescue pattern described below permits a helicopter crew to safely conduct a night/Instrument Meteorological Conditions (IMC) rescue in minimal time. Only aircraft equipped with a coupled hover system will execute this pattern. The pattern is designed to place the aircraft into the windline with a downwind distance sufficient to allow the autopilot to fly the aircraft down a preset glideslope and into a hover at a selectable altitude.
  - 1). To conduct a simulated windline rescue pattern, perform the Landing Checklist, assume control of the helicopter, and report on instruments. Upon passing over the survivor, simulate deploying smoke or matrix lights, and call, “*On top, simulated smokes/lights away.*”

**WARNING**

Any time there is a chance of igniting aviation fuel in water; smokes shall not be used to mark the survivor’s position

- 2). While simultaneously setting 60 KIAS, utilize an SRT to turn either downwind or to place the wind on the nearest 45° in lower half of the RMI. Start the clock either when the helicopter is established 45° to the downwind line or abeam the survivor heading downwind.
- 3). A combination of wind velocity and time downwind totaling 30 suffices (e.g., wind velocity ten knots, time downwind 20 seconds, wind velocity 30 knots or greater, maintain a standard rate turn until headed into the wind).
- 4). After the proper time has elapsed, commence a turn inbound to the survivor. Depending on the direction of turn, the copilot or aircrew keeps sight of the lights marking the survivor, establishes orientation of the survivor to the lights, and informs the pilot if more or less turn is required. The warning command, “*Stand by to roll out*” shall be given by the copilot before intercepting the windline. When orientation and lineup are achieved, the copilot calls to the pilot, “*Roll out.*”
- 5). Once the aircraft has established wings level, and is oriented into the windline, the maneuver is complete.

NOTE

At this time, a descent to a hover utilizing an automatic approach system would be recommended.

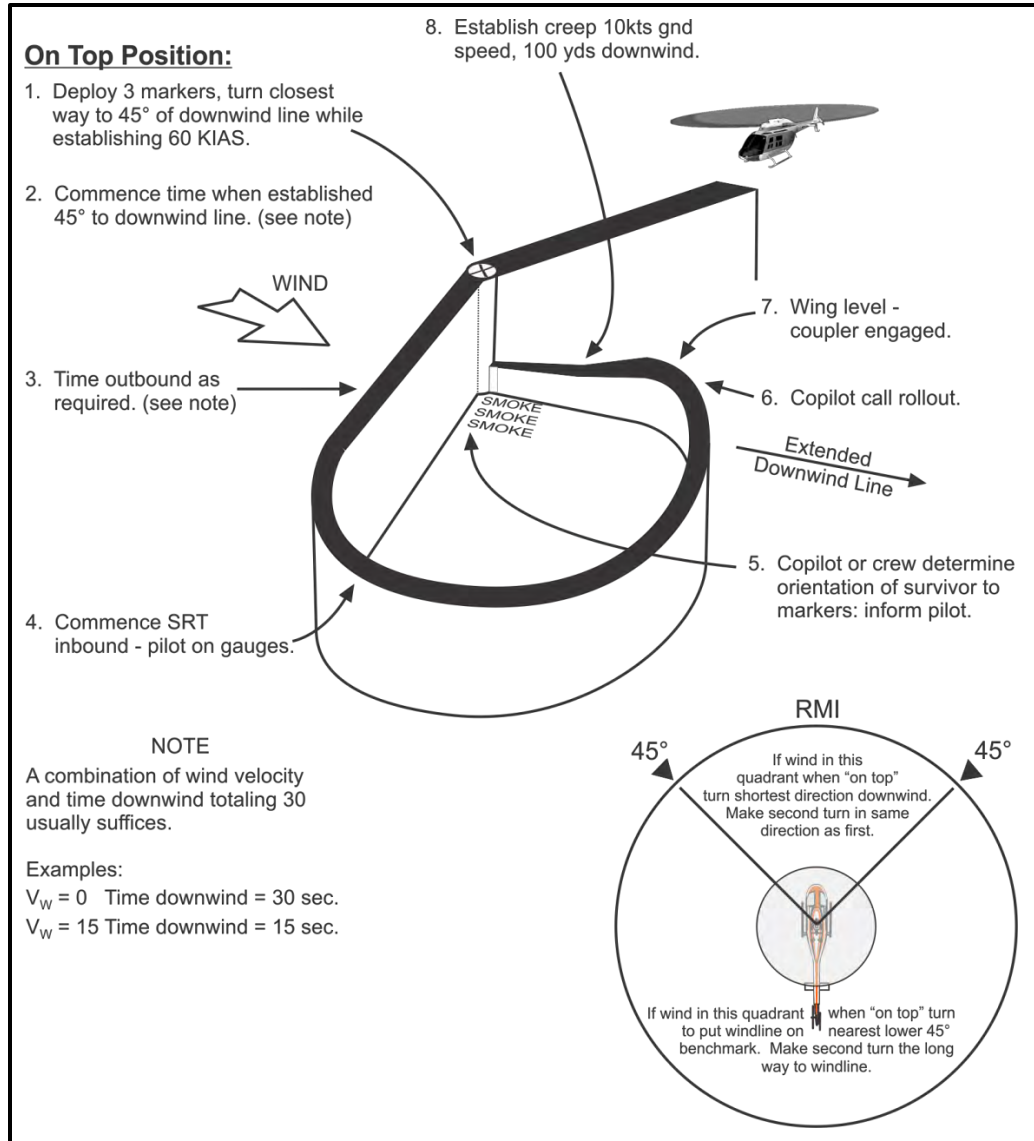

Figure 3-4 Windline Rescue Pattern

**Example SAR Scenario.** Use the SAR TACAID to follow this example:

Just prior to taking off from USS Ship on a beautiful day, you are notified of a possible SAR scenario. Your aircraft has 90 gallons of fuel. You launch at 1200 local and are provided an INITIAL POSITION 15 minutes old and ten miles away. You head towards it at 100 knots groundspeed. While enroute, you are told an F-18 pilot made a MAYDAY call stating he was bailing out at 6000 feet heading 180°. A nearby Aegis cruiser provided the INITIAL POSITION

based on the aircraft's IFF return at 6000 feet. You grab the SAR TACAID out of the NAV bag and go to work.

You brief the crew using the checklists provided in Section One, and review the laminated ON-SCENE COMMANDER checklists because you anticipate other aircraft may soon be involved. Skipping Section Two, Communications, because you do not believe it to be applicable in this scenario, you start the procedures in Section three.

First, you must determine the DATUM and the SEARCH AREA. To do this, you will need to correct the INITIAL POSITION for drift forces. Figuring the pilot successfully bailed out, you find an aerospace drift value for a high-performance aircraft is 0.8 miles. Next, you try to figure parachute drift. You know the winds at the surface are 045 at ten knots. The winds at 6000 feet were provided in your brief as being 315 at 30 knots. You make a rough average and decide to use winds from the north at 20 knots. Looking in the TACAID, the parachute drift is 1.8 miles. Since the aircraft heading and the winds are both in the same direction, you add the two forces together to get a total aerospace drift of 2.6 miles. Since you will be on-station within about 20 minutes of the distress call and the weather is beautiful, you decide that, so far, any surface drift is negligible. You add everything together and come up with a DATUM about three miles south of the initial position. Knowing the search radius is the sum of all the errors plus a safety factor, you decide to use a four-mile search radius about the DATUM. Boxing the circle, this gives a SEARCH AREA of 64 square miles.

Second, you must determine how much time is available to conduct the search. The ship tells you the water temperature is 75° F. So, exposure will not be an immediate concern. It is about nine hours to sunset, so daylight will also not be an immediate concern. It will come down to endurance. Because the ship will not be able to close your position due to shoals, it will be a 10-mile trip back for fuel. At 100 KIAS, this will take about six minutes or about three gallons of fuel at 28 gallons per hour. With ten gallons unusable, you decide to give yourself a little extra fuel in case you are on the far side of the pattern and make the BINGO 15 gallons. Minus the three gallons it will take to get to DATUM, this will leave you with about 72 gallons or about two hours and 30 minutes worth of time to search.

Third, you must determine a SWEEP WIDTH. While you know F-18s will have a one man raft in the seat pan, you are not sure whether the seat pan separated or even if the pilot will be capable of climbing into the raft. You decide to go with the worst case - just an LPU. Looking at the tables in the TACAID, the uncorrected SWEEP WIDTH for a person in the water is 0.1 NM. Reading the note at the bottom of the table, you decide to search at 300 feet and multiply the SWEEP WIDTH by four. As the weather is great and the crew is fresh, no further corrections are required and the partially corrected SWEEP WIDTH will be 0.4 NM.

Fourth, time to do some math. Dividing the SEARCH AREA by the SWEEP WIDTH and 2+30 time to search, you come up with a search speed of about 64 knots. You decide you will use a 70-knot groundspeed. Since not much time has elapsed, the search area is relatively small, and your target is relatively difficult to see, you decide to start with a sector search using four NM legs. The initial search will take about 0+30 and have a PROBABILITY OF DETECTION of about 30%. If no success, you will have time to turn the pattern 30° and repeat. This will give a

cumulative PROBABILITY OF DETECTION of about 50%. If still no success, you can then use an expanding square search until you reach BINGO fuel.

Upon reaching the DATUM, you drop a smoke to help determine the local total water current. As the pattern you have selected will take about 0+30, you should be able to reseed the DATUM with another smoke at the end of the initial search. In this way, if you have to return for fuel without the downed pilot, you will be able to update the DATUM with the local total water current and continue searching until sunset.

**Low-Level Basic Instrument Procedures.** Low Level BI maneuvers consists of Level Speed Change, and Turn Pattern, with stab on and off, either full panel or partial panel. Refer to Instrument and Navigation FTI for specific procedures.

**THIS PAGE INTENTIONALLY LEFT BLANK**



## **CHAPTER FOUR SHIPBOARD OPERATIONS**

### **400. INTRODUCTION**

This chapter introduces the student to the basic fundamentals of shipboard operations. The procedures contained herein are intended to provide a foundation for shipboard operations, which will meet most mission requirements.

### **401. SHIPBOARD OPERATIONS**

Small deck flight operations present problems not generally associated with other aviation facility ships. The small deck area, pitch and roll, obstructions, proximity to the water, and wind turbulence combine to make “small boat” operations potentially hazardous. Skill, proficiency, and Crew Resource Management are paramount to the safe, successful completion of the evolution.

The single deck qualification involves the completion of two distinct phases of training: Field Deck Landing Practice (FDLP) and Deck Landing Qualification (DLQ) aboard the Helicopter Landing Trainer (HLT) (Figure 4-1). Both the FDLP and DLQ phases will normally involve one flight of two aircraft with the mission brief being conducted by the flight leader. **Single plane events are permitted.**

To become more familiar with shipboard operations several publications should be consulted including NAVAIR 00-80T-122, HOSTAC, CV NATOPS, and LHA/LPH NATOPS.

### **402. FIELD DECK LANDING PRACTICE**

#### **1. Application**

The FDLP is used to help the pilot become familiar with the shipboard pattern. Practicing the shipboard approaches on land establishes a standardized sequence which ensures each pilot is ready for the faster pace and potentially more hazardous shipboard environment.

#### **2. Description**

The FDLP enables the pilot to practice shipboard landings at an outlying field, at a pattern altitude of 300 feet AGL and 70 KIAS.

#### **3. Procedures**

Pilot Not At Controls (PNAC) checks gauges and caution lights, then gives the LSE a thumbs up.

When cleared by the LSE, lift to a stable five-foot hover. The non-flying pilot checks the gauges and reports “*Gauges green, no caution lights, clear to slide left*”.

Upon LSE signal, commence a slide perpendicular to the line-up line, maintaining heading until clear of the spot by one rotor diameter.

When clear, transition to forward flight without stopping in a hover. Maintain takeoff power until three indications of a climb (IVSI, RAD ALT, BAR ALT) and positive indication of airspeed is reported by the PNAC.

Climb on line-up heading to 200 feet AGL at 70 KIAS and turn, with proper interval, to arrive on downwind at 300 feet AGL and 70 KIAS.

Just prior to abeam, the PAC will make a simulated radio call on ICS to the instructor pilot (IP) stating aircraft side number, abeam, seat of PAC and type approach (starboard-to-port). The IP will respond as the shipboard Helicopter Control Officer (HCO) with deck status, winds, and pitch and roll information.

At the 180° position, begin a descending, decelerating turn towards the line-up line.

Arrive at the 90° position at 200 feet AGL and 60 KIAS.

Intercept the line-up line with 800 to 1000 feet of straight-away, 125 to 150 feet AGL, and 45 to 55 KIAS.

Set the appropriate decel attitude and adjust collective to maintain a constant glideslope to arrive over the spot in a five foot hover. (You should cross the deck edge at about eight to ten feet.)

#### **4. Amplification and Technique**

Once cleared by LSE to lift, smoothly establish a solid five foot hover. The PNAC will check gauges and caution lights. When cleared, slide perpendicular to the line-up line to one rotor diameter. (This will give the illusion of flying backwards.) Sliding perpendicular gives the shortest distance to slide. When clear of the spot by one rotor diameter, transition to forward flight while maintaining takeoff power.

#### **NOTE**

When clearing the deck edge, additional power will be necessary to prevent settling due to loss of ground effect.

The PNAC will report three indications of climb (IVSI, RAD ALT, BAR ALT) as well as a positive indication of airspeed. Climb out on line-up heading to 200 feet AGL and 70 KIAS; with proper interval turn downwind. All adjustments for interval should be made on the upwind leg. Twisting the HSI course indicator to line-up heading and the wind bug to the Base Recovery Course (BRC) is helpful for orientation. The line-up line is 22° offset from the BRC.

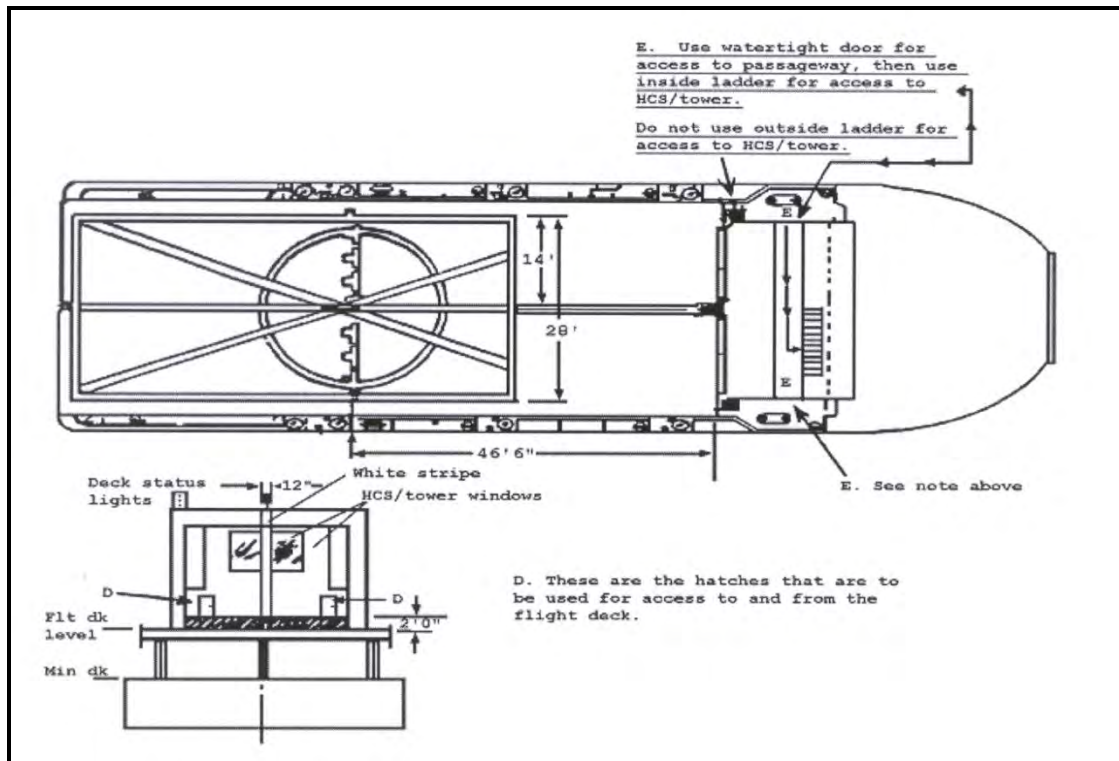

**Figure 4-1 Top and Stern View of HLT (IX-514)**

Fly the downwind at 300 feet AGL and 70 KIAS. The PNAC will ensure the Landing Checklist is complete, check for proper lighting configuration, and report the fuel state. The lighting configurations are:

Right seat approaches - Position lights steady bright.  
Left seat approaches – Position lights flashing bright.

Just prior to the abeam position, the PAC will initiate a simulated call on ICS to the instructor stating aircraft side number, abeam, seat of PAC, and type approach (starboard-to-port). The IP will respond as the shipboard HCO with deck status (green or red deck), winds relative to BRC, and pitch and roll.

**Example:** Pilot: *“(Aircraft call sign), abeam, right seat, starboard-to-port.”*

#### NOTE

All approaches are starboard-to-port in the training command.

Instructor answers: *“Roger, (aircraft call sign), you have a green deck, wind ten degrees to port at five KTS, pitch one, roll one.”*

**NOTE**

Green deck signifies clearance to land. Red deck signifies deck is not clear for landing. The reported winds should be checked in the wind envelope charts located in the back of the PCL to ensure the winds are within limits (Figure 4-2).

From the abeam position, begin a descending, decelerating turn to arrive at the 90° position at 200 feet AGL and 60 KIAS. Adjust turn and decel to intercept line-up line with 800 to 1000 feet of straightaway, 125 to 150 feet AGL and 45 to 55 KIAS.

Fly a constant glideslope to simulate crossing the deck at eight to ten feet. The PNAC will report crossing the deck edge over ICS. Continue flying glideslope to arrive at a stable five foot hover. When the LSE signals to land, the PNAC will ensure the aircraft is correctly positioned.

The PAC will smoothly execute a vertical landing maintaining line-up. The aircraft is positioned correctly when the VERTREP line is in the lower half of the chin bubble.

A waveoff will be accomplished in the following manner:

- a. Ensure the twist grip is full open,
- b. Add climb power to arrest rate of descent,
- c. Turn clear of the ship,
- d. Set climbout attitude, and
- e. Make waveoff call.

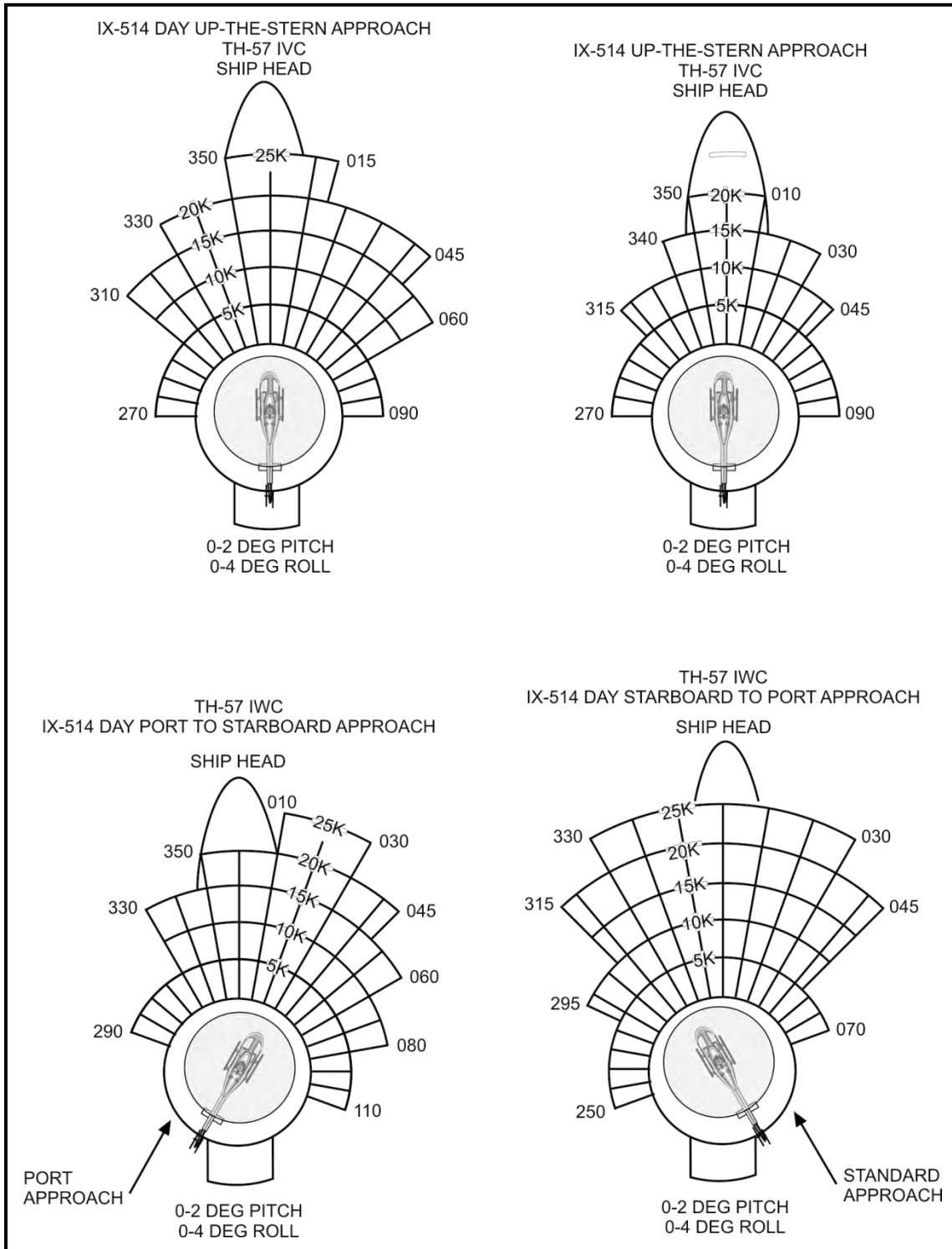

Figure 4-2 Wind Limits

## 5. Common Errors and Safety Notes

- a. Since visibility is limited in a nose-high attitude, use an early deceleration to control closure rate.

### CAUTION

High nose attitudes upon crossing the deck could result in a tail strike.

- b. Avoid extending the pattern downwind.
- c. During crew changes and passenger drops, the twist grip will remain at the full open position (100%  $N_f/N_r$ ).
- d. A waveoff signal from the LSE, HCO, or waveoff light is mandatory. If the PAC feels uncomfortable (during the approach due to a high sink rate, excessive closure rate, etc.), a waveoff should be executed.
- e. The IP shall thoroughly brief all emergencies around the flight deck. It should be clearly understood when you are committed to the flight deck, water, or flying. Two examples are: once you start sliding off the flight deck you are committed to the water or flying; once "*crossing the deck*" is called you are committed to the flight deck.
- f. Due to time and fuel constraints, avoid debriefing on deck to ensure a smooth and efficient pattern.
- g. Avoid the tendency to make an approach prior to the deck edge, then air taxiing to the spot. Do not fixate on the spot, continue to scan the entire deck.
- h. A balance should be achieved between excessive nose low attitude on transition to forward flight while minimizing flight in the avoid area of the height-velocity diagram.

## 403. DECK LANDING QUALIFICATION

### 1. Application

The DLQ pattern allows the helicopter to arrive safely on board a ship while minimizing time over water.

### 2. Description

The DLQ pattern enables the pilot to transition from cruise flight to the shipboard environment.

### 3. Procedures

Utilize the same pattern as FDLP with the following check-in and modifications.

- a. CHECK-IN: When approaching the ship, IX-514, the initial check-in will be accomplished by the lead aircraft.
  - i. Number of aircraft in the flight and side number.
  - ii. Souls on board.
  - iii. Fuel-state (in time to “splash”).
  - iv. TACAN (Sweet or Sour lock).
  - v. Will report a “See you” to IX-514.

**Example:**

**Pilot states:** “IX-514, (aircraft call sign), over.”

**HCO states:** “(aircraft call sign), IX-514, go ahead.”

**Pilot states:** “IX-514, (aircraft call sign), wingman side number \_\_\_\_, three souls each aircraft, 2+00 (time to splash given for aircraft with lowest fuel state in section), with a sweet lock, will report a see you.”

- b. The flight will make one pass up the starboard side of the ship at altitude (300 feet AGL). This will provide the Student Military Aviator (SMA) an opportunity to see the landing environment prior to the initial approach and allows the IP to visually check deck conditions. The lead aircraft will call in position for the break.

**Example:** “IX-514, (aircraft call sign), abeam for the break.”

### 4. Amplification and Technique

The flight leader will conduct a thorough NATOPS Brief and Conduct of Flight Brief for all flights.

Ensure the HLT's position is updated and the proper UHF frequency is set in the radio.

Approaching the ship, the flight leader will make the appropriate radio communications. BRC, deck status, winds, pitch and roll should be obtained as soon as possible.

Utilize the same pattern as used for FDLPs (Figure 4-3) to establish the aircraft over the flight deck in a five-foot hover. Turbulence around the deck and superstructure will make hovering

and landing more difficult. The turbulence and relative wind combine to form a burble on the approach side of the ship. The aircraft will encounter this burble on short final. Slight forward cyclic may be necessary to prevent the cessation of forward flight.

Depending upon the ship's speed, the aircraft may be into translational lift while hovering due to the relative wind across the deck; thus, the skids would touch down skid toe first.

Leveling the skids will normally start an aft drift, which must be countered with a slight forward cyclic input.

#### 5. Common Errors and Safety Notes

- a. Landing with winds, pitch, or roll outside published envelope limitations are not authorized and shall not be attempted except under extreme emergency conditions.
- b. Cross cockpit takeoffs/landings are not authorized for SMAs.
- c. Avoid using the water as part of the hover or approach scan. The waves and swells may cause vertigo and disorientation. Scan the horizon through the flight deck to maintain a level aircraft attitude.
- d. Do not cross the ship's bow without permission from the HCO.
- e. Making abrupt power changes and control inputs.
- f. A waveoff signal, whether via UHF, lights, or LSE, is mandatory. A waveoff may be initiated at any time it is necessary. When the aircraft is on the deck, a hold signal given by any of the above means is also mandatory.
- g. Deceleration early to bring closure rate under control is required to keep the LSE in sight.
- h. If the LSE is out of position, the PNAC may put his hand out of the window and wave the LSE over. A radio call may also be used.

#### **DLQ Pattern** Starboard to Port Approach

1. Take off under the LSE's guidance.
2. Once clear (one rotor diameter from Ship), transition to forward flight.
3. At 200 feet and 70 KIAS, turn downwind.
4. Establish downwind (70 KIAS, 300 feet).
5. Abeam, make radio call, check lights.



6. Turn and descend to 90° position (200 feet, 60 KIAS).
7. Intercept final (125 to 150 feet of altitude, 45-55 KIAS, 800 to 1000 feet of straightaway).

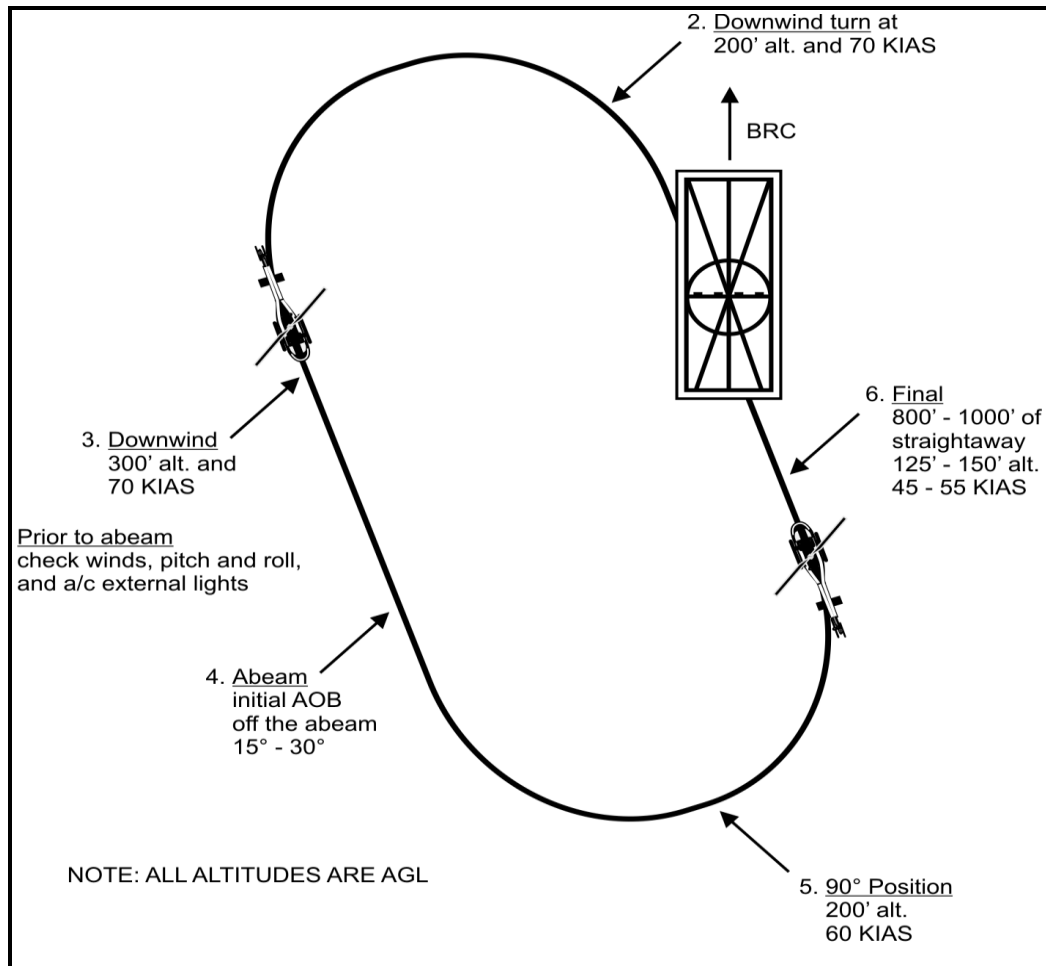

Figure 4-3 Day Pattern

#### 404. SHIPBOARD INSTRUMENT APPROACHES

##### 1. Application

To enable all weather operation, air-capable ships are normally equipped with TACAN, NDB, and/or air surveillance radar (ASR) to facilitate instrument approved IFR approaches. An air-capable ship has a control zone with a radius extending five NM and an altitude of 2500 feet Mean Sea Level (MSL), similar to Class D airspace. There are several IFR approaches available to the inbound helicopter depending on the type of ship. These approaches can be found in one of the following publications: NAVAIR 00-80T-122, CV NATOPS, LPH/LHA NATOPS and in most aircraft pocket NATOPS (See Figures 4-4 to 4-8). To ensure a smooth transition to the shipboard environment some ships are equipped with a Stabilized Glideslope Indicator (SGSI)

giving the pilot constant glideslope information on final. Another way to stay on the constant three degree glideslope is to fly the Visual Approach (Figure 4-8).

## 2. Procedures

Prior to arriving in the control zone the inbound helicopter shall check in with the ship's radar controllers or the tower.

- a. The pilot shall provide the following information:
  - i. Identification and type helicopter.
  - ii. Position.
  - iii. Altitude.
  - iv. Fuel state in time to “splash” (NATOPS minimums).
  - v. Souls on board.
  - vi. Other information that may effect the recovery.
- b. The controller shall provide:
  - i. Type of approach anticipated (Visual Flight Rules (VFR) or Instrument Flight Rules (IFR)).
  - ii. Estimated recovery time.
  - iii. Altimeter setting, wind, and weather.
  - iv. Base recovery course.
  - v. Marshal instructions, if required. Marshal is defined as a bearing, distance and altitude fix designated by Air Operations Control Center/Helicopter Direction Control (AOCC/HDC) from which pilots will orient holding and the initial approach will commence.
  - vi. Steering as required.
  - vii. Estimated recovery time.

## 3. Common Errors and Safety Notes

- a. Remember the 6 Ts.

- b. The shipboard approaches happen faster than normal approaches because of the relatively short distance between IAF and MAP. Use a shallow rate of descent (200 to 300 FPM) and stay ahead of the aircraft.
- c. The RAD ALT shall be the primary reference for altitude indications below 500 feet AGL over water.
- d. Crew Resource Management is imperative because of the inherent dangers associated with low-level flight over water.

#### 405. PRIMARY MARSHAL APPROACH (TACAN EQUIPPED SHIPS)

##### 1. Application

[FTI Chapter 9(ADF/VOR/TACAN Approach), AIM Chapter 5 Section 4 (Arrival Procedures)] see Figure 4-2. A Primary Marshal approach is a TACAN navigation procedure used to affect a safe letdown to an air-capable ship in IMC.

##### 2. Procedures (TACAN) (Figure 4-4)

- a. Hold at primary marshal as directed by radar control.
- b. When cleared, the pilot shall proceed to the IAF using radar vectors, TACAN information, or from holding as depicted.
- c. The pilot shall report “*commencing approach*” and complete the Landing Checklist. Remember your 6 Ts.
- d. Proceed to the final approach fix (FAF) and report “*Landing Checklist complete right/left seat landing.*”
- e. Primary Flight Control (PRIFLY) shall reply “*cleared to land*” and the pilot shall begin a descent to arrive at the missed approach point (MAP) at the minimum descent altitude (MDA).
- f. With a SGSI installed, the pilot shall report visual acquisition of SGSI to the ship and complete the approach based on SGSI and LSE signals.

##### 3. Procedures (Non-Directional Beacon) (Figure 4-5)

- a. When cleared, depart marshal and report “*commencing approach.*”
- b. Proceed outbound on a heading 30° to the right of the final approach bearing (relative to the ships BRC) and complete the Landing Checklist.

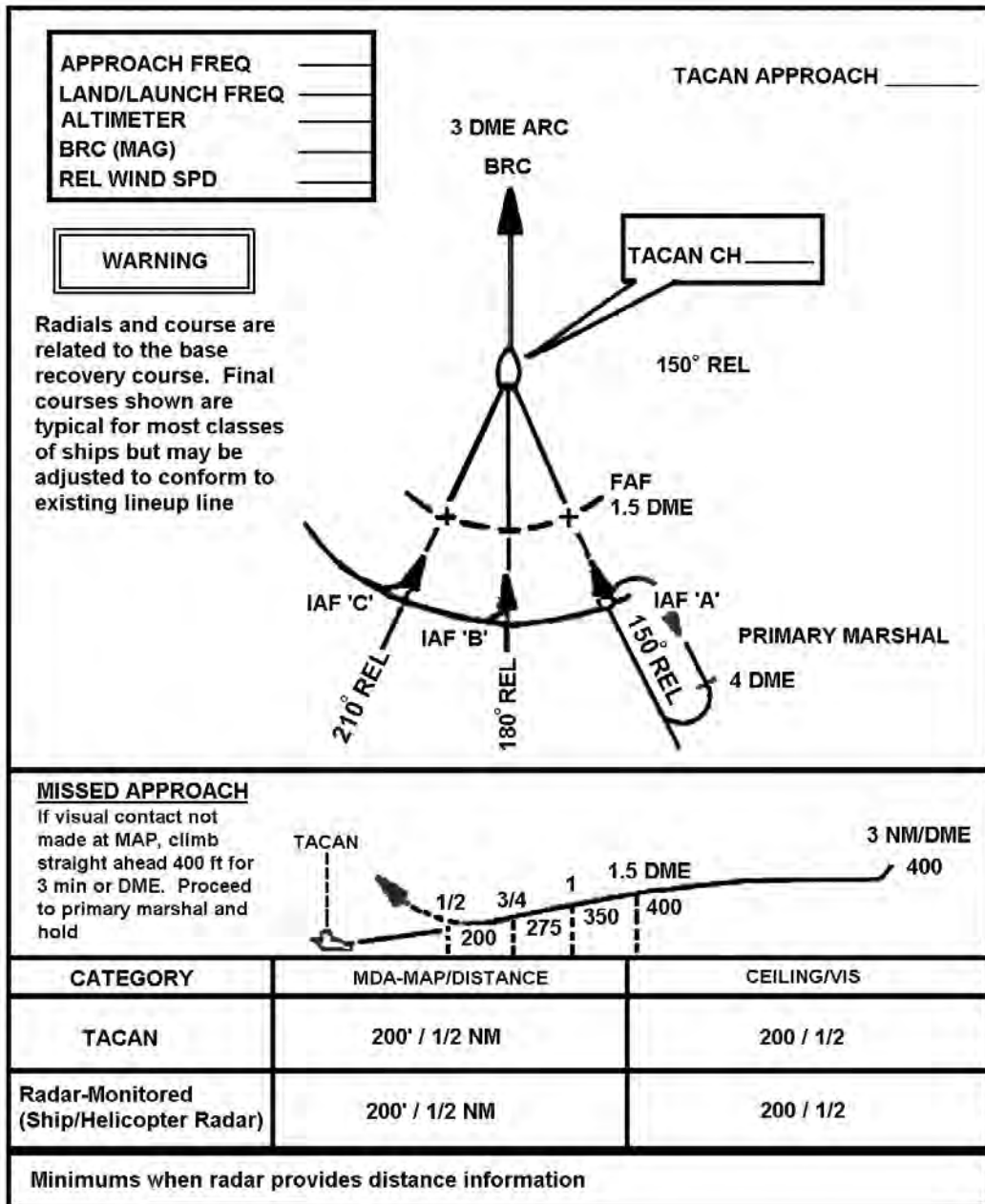

Figure 4-4 Approach Chart Air Capable Ships TACAN

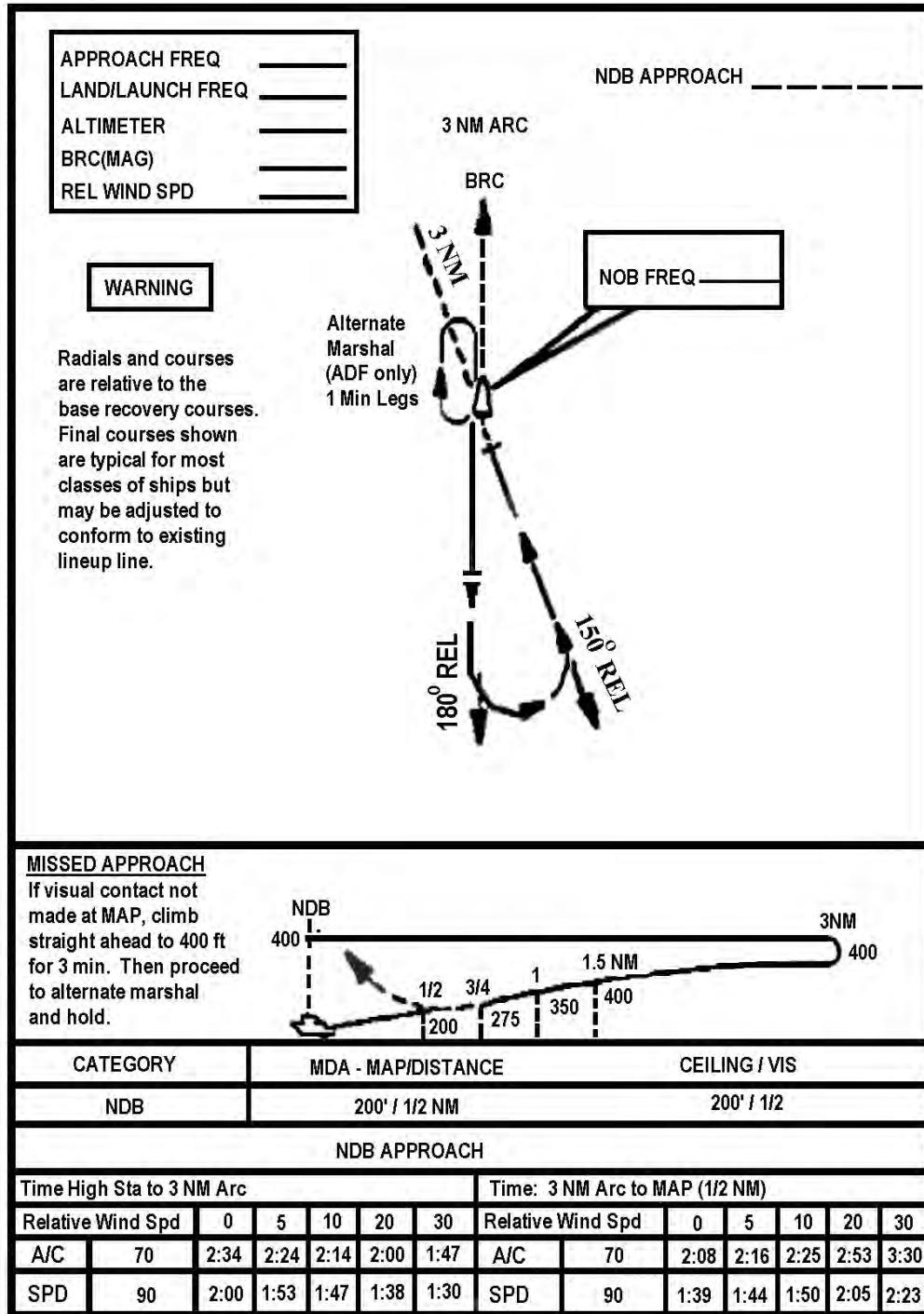

Figure 4-5 Approach Chart Air Capable Ships NDB (Helicopter)

- c. Time outbound and commence a shallow left turn of approximately ten degrees to intercept the final inbound bearing.
- d. Once established on final, proceed to the FAF and report “*Landing Checklist complete, right/left seat landing*”.
- e. PRIFLY shall reply “*cleared to land*” and the pilot begins a descent to arrive at the MAP at the MDA.
- f. With SGSI installed, the pilot shall report visual acquisition to the ship and complete the approach based on the SGSI and LSE signals.

#### 4. LPH/LHA Approaches (Figure 4-6)

- a. LPH/LHAs are normally equipped with TACAN, NDB, ASR/PAR, and SGSI to conduct approved IFR approaches. A LPH/LHA control zone for approved IFR approaches has the same dimensions as an air-capable ship control zone. Helicopter recoveries are classed according to weather conditions and may be Case I, II, or III.
- b. Case I is when it is anticipated flights will not encounter IMC conditions on any portion of an approach. Weather minimums of 1000 feet and three miles of visibility are required in the control zone. Flights shall check in with AOCC/HDC upon entering the control zone in the same manner as with an air-capable ship. Pilots shall report a “*see you*” when visual contact is established. AOCC/HDC shall switch flight, to tower frequency at five nautical miles.
- c. Case II is used during daylight when IMC conditions are encountered by flights during descent, but Visual Meteorological Conditions (VMC) of at least 500 feet ceiling and one mile visibility exists at the ship. Positive control shall be utilized until the pilot reports “*see you.*”
- d. Case III is used whenever weather conditions at the ship are below Case II minima. Case III recoveries shall apply to single aircraft only (except during emergencies) and precision radar shall be used whenever available. The approach charts depicted are used in Case III recovery conditions (Figure 4-6).
- e. Prior to commencing Case III recoveries, marshal patterns are assigned according to operational restrictions. Patterns will be clear of clouds if possible. All bearings depicted are relative to BRC. All legs are two NM long and all turns are standard rate. The patterns are oriented as follows:
  - i. TACAN Marshal One - 180° bearing at seven miles, altitude assigned.
  - ii. TACAN Marshal Two - 270° bearing at seven miles, altitude assigned.
  - iii. TACAN Marshal Three - 090° bearing at seven miles, altitude assigned.

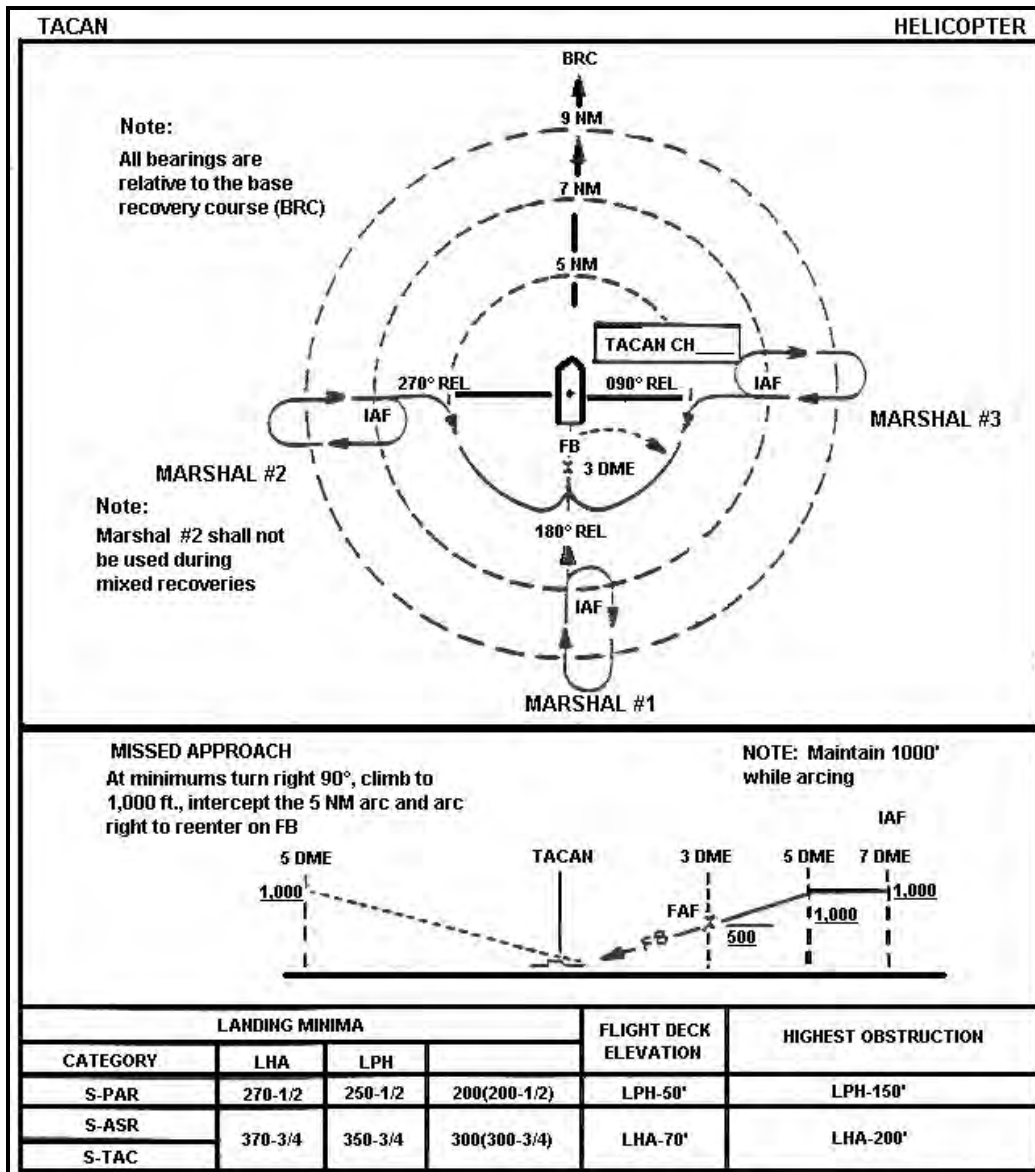

Figure 4-6 Approach Chart LPH/LHA TACAN (Helicopter)

5. NDB/TACAN Overhead Marshal (Figure 4-7).

- a. Prior to the approach AOCC/HDC shall provide the following information:
  - i. New expected approach time (EAT).
  - ii. Final control frequency.
  - iii. Type of approach and outbound bearing (overhead only).
  - iv. Frequency and IFF/SIF changes.

- b. When cleared, adjust pattern to depart marshal at EAT.
- c. Descend from marshal at 90 KIAS and 500 FPM to the FAF and report “*Landing Checklist complete.*”
- d. Precision radar shall be used to the maximum extent possible. Heading and glideslope information shall be provided on final.
- e. When glideslope information is not available, aircraft on final will be provided with recommended altitudes and sufficient information to maintain an accurate azimuth and safe altitudes by the final controller.

6. **Emergency Low Visibility Approach** (Figures 4-8 and 4-9).

An Emergency Low Visibility Approach (ELVA) is conducted to an air-capable ship that has weather below approach minimums (200 feet ceiling and one half mile visibility). The approach is considered an emergency procedure. An actual ELVA shall not be attempted unless the helicopter does not have adequate fuel to bingo to a GCA/CCA equipped airfield or aviation ship.

Primary factors which affect the quality of an ELVA are the skills of the controller, accuracy of the information displayed to the controller, and the pilot's flight proficiency. Practice ELVAs in VMC shall be conducted routinely to enhance controller and pilot proficiency.

The ship's gunfire control systems (GFCS) provides the most accurate real time tracking system available on most air-capable ships. For this reason, its use during an ELVA is recommended. The NC-2 ASW plotter, with a final approach pattern overlay, may also be used in conjunction with either the GFCS or the surface search radar.

Required radio transmissions from the controller are based on the helicopter's range from the ship and must be made at the appropriate time.

The initial approach pattern must be executed so that the aircraft reaches the four-mile gate position at an altitude of 400 feet and at 70 KIAS. All required radio transmissions (1-6) are completed as depicted on Figures 4-8 and 4-9.

Final approach will commence at an altitude of 400 feet and 70 KIAS. The final controller must have the approach plotted and actually have radar control of the aircraft prior to reaching the four-mile gate.

For standard approaches, final approach course will be the ship's BRC minus the flight deck approach angle. For port approaches, the opposite is true. The final course will be the BRC plus the flight deck approach angle.



Heading corrections on final should not be more than five degrees, if possible, using half-standard rate turns. Remember, the aircraft will be changing speeds during the final approach; therefore the ship and aircraft's relative motion will change.

For missed approach, the aircraft will make a 30° turn to the left (right for port approach) and climb 400 feet. The aircraft should then be vectored back into the ELVA pattern.

If equipment malfunctions, or limitations preclude ELVA procedures, an emergency approach or ditching may be considered.

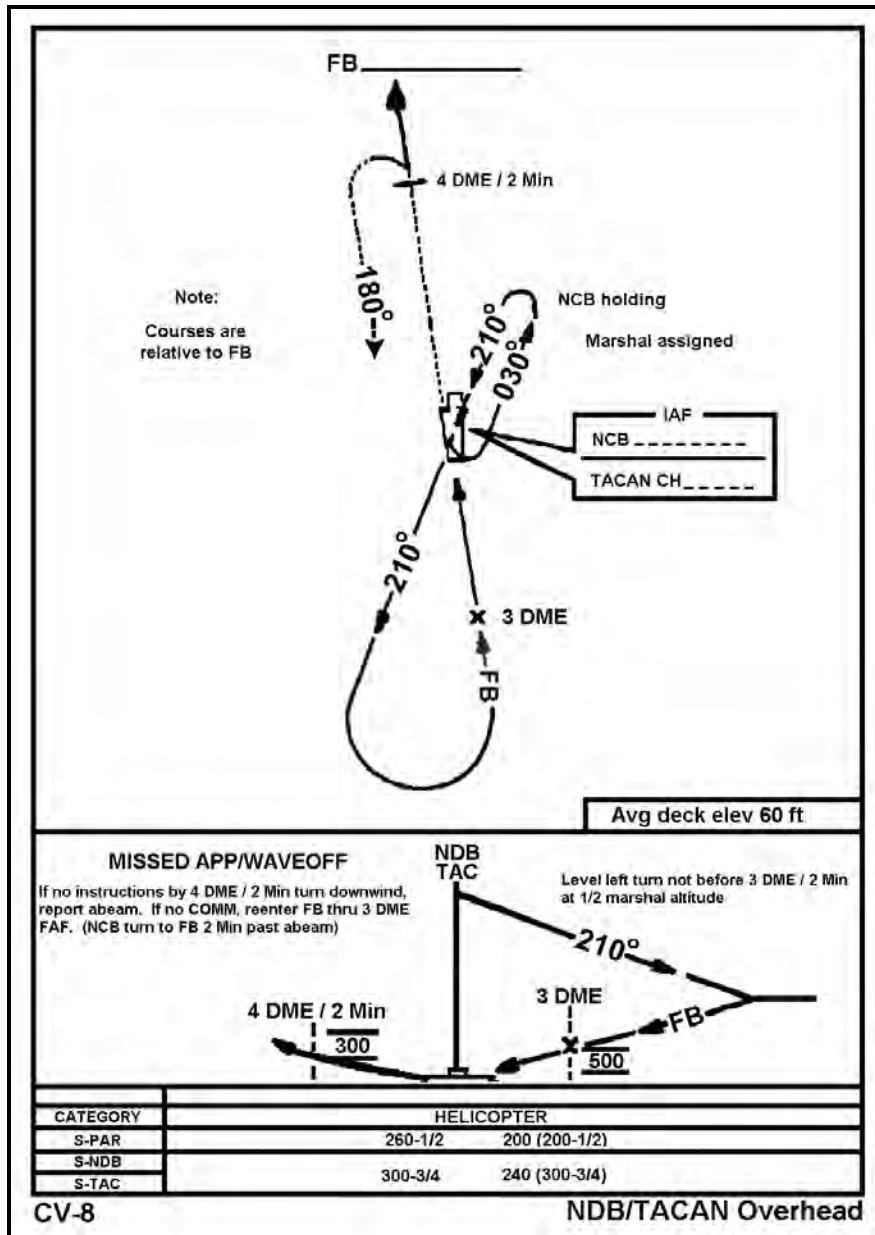

Figure 4-7 NDB/TACAN Overhead

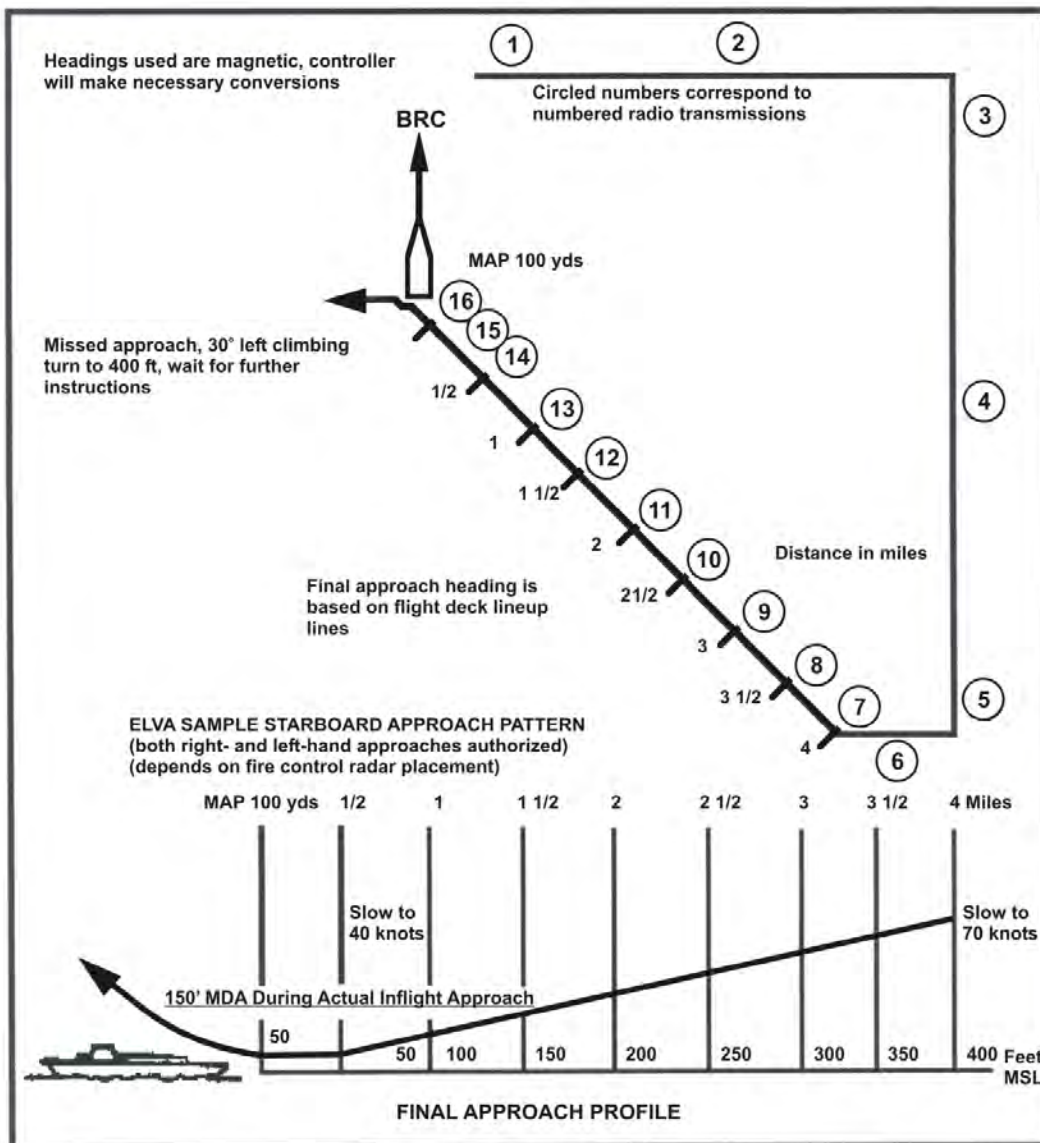

Figure 4-8 ELVA Pattern

<b>EMERGENCY LOW VISIBILITY APPROACH (ELVA) PATTERN - RADIO CALLS</b>	
1.	(Initial Check-in). This will be a radar-assisted approach. Hold your radar contact on the _____ radial, _____ miles from the ship. Altimeter setting is _____. Weather is ceiling _____, visibility _____. Final approach heading will be _____. Winds are _____ degrees port/starboard at _____ knots. Maximum pitch and roll are _____. Read back altimeter setting.
2.	Descend/climb and/or maintain 400 ft. Assigned heading is _____.
3.	Lost communications procedures follow: If no transmissions are received for 1 minute in the pattern or 15 seconds in final, climb to and maintain 400 ft. Attempt contact on (Secondary). If unable to make contact, squawk Mode III Code 7600. Alternate approach will be TACAN channel _____ commencing at 3 miles and 400 ft on the _____ radial. Acknowledge.
4.	Missed approach procedures follow: If ship or wake not in sight at missed approach point, immediately turn left 30 degrees (right for port approach); climb to 400 ft and increase airspeed to 90 knots. Report level and on speed and stand by for further instructions.
5.	Perform landing checks. Report gear down and locked.
6.	Turn right/left to the final bearing _____; maintain 400 ft and slow to 70 knots.
7.	Do not acknowledge further transmissions. On final, 4 miles. Commence gradual rate of descent to arrive at ½ mile at 50 ft. Maintain 70 knots. Assigned heading is _____. Report ship in sight.
8.	(Call sign) 3½ miles, left/right/on approaching centerline. Turn left/right (Corrective heading) or assigned heading is _____. Altitude should be 350 ft.
9.	(Call sign) 3 miles, left/right/on approaching centerline. Turn left/right (Corrective heading) or assigned heading is _____. Altitude should be 300 ft.
10.	(Call sign) 2½ miles, left/right/on approaching centerline. Turn left/right (Corrective heading) or assigned heading is _____. Altitude should be 250 ft.
11.	(Call sign) 2 miles, left/right/on approaching centerline. Turn left/right (Corrective heading) or assigned heading is _____. Altitude should be 200 ft.
12.	(Call sign) 1½ miles, left/right/on approaching centerline. Turn left/right (Corrective heading) or assigned heading is _____. Altitude should be 150 ft.
13.	(Call sign) 1 mile, left/right/on approaching centerline. Turn left/right (Corrective heading) or assigned heading is _____. Altitude should be 100 ft. Slow to 40 knots.
14.	(Call sign) ½ mile. Assigned heading is _____. Maintain 50 ft and 40 knots.
15.	(Call sign) 800/600/400/200 yards. Left/right/on approaching centerline.
16.	(Call sign) at missed approach point if ship or wake not in sight, execute missed approach.

**Figure 4-9 ELVA Radio Calls**

**THIS PAGE INTENTIONALLY LEFT BLANK**

## CHAPTER FIVE COMMUNICATIONS

### 500. INTRODUCTION

This chapter introduces the student to the basic fundamentals of communications. The procedures contained herein are intended to provide a foundation for communication which will meet most mission requirements.

### 501. COMMUNICATIONS

#### 1. Application

In any combat situation command and control is critical. Good communications are essential to winning on the modern battlefield. The enemy will employ various methods to disrupt communications in order to swing the tide of the battle to their favor. To the aviator, this means effective use of his radios. Even under circumstances when the enemy is not using jamming or intrusion, they might be monitoring aviation nets for intelligence. Improper radio discipline could cost lives. Tactical situations dictate prudent use of all available communications.

Standardized radio procedures will significantly reduce unneeded radio transmissions thus denying the enemy valuable information. Jamming by the enemy may drastically reduce your ability to use the aircraft's radios. Detailed planning, alternate means of communication, and thorough briefing will help defeat the threat.

Detailed planning is essential. The less left to chance, the less need to use the radios. During the planning phase, do not overemphasize reliance on electronic communications. Anticipate the need for visual signals, brevity codes, and emission control (EMCON) procedures. Plan the mission from beginning to end in detail emphasizing simplicity.

Thorough briefing is necessary. If little or no verbal communications are to be used, each aircrewmember must be thoroughly familiar with the mission and its execution. This familiarity must be such that if the lead aircraft is incapacitated, any member of the flight may complete the mission. The flight leader must ensure each member knows and uses the standard visual signals and brevity code.

**Great care should be taken in the brief presentation.** Too many times flight leaders burden their aircrews with administrative matters vice spending the bulk of the brief time on the mission and execution. There is no need to spend two minutes on the weather when it has no effect on the mission.

Whenever possible, the briefer should present the flight members with copies of all pertinent information. This will cut down drastically on time spent and mistakes made in hand copying information; thus, the aircrew can pay full attention to the briefer.

Ask questions at the end of the brief. Ensure each individual fully understands the mission and their part in it.

## 2. Procedures

All pilots should know and practice sound radio discipline. This means listening and responding to only those transmissions affecting them. EMCON does not mean complete radio silence, but does mean transmitting only when absolutely necessary. One way to decrease radio transmission is to use standardized procedures. The following standard communication procedures will be utilized during the tactics phase of training.

### a. Radio check-in procedures.

The section leader/lead may want to check the flight in at the beginning of the flight or following a frequency change to ensure everyone in the flight is up on the desired frequency. This is accomplished by calling for a “*check-in*” utilizing the flight call sign.

#### Example:

Lead- “ \_\_\_\_\_ *flight check in UHF.* ”

Flight- “ \_\_\_\_\_ *Two*”, “ \_\_\_\_\_ *Three*”, “ \_\_\_\_\_ *Four.* ”

### b. There are two basic ways to accomplish a frequency change. These are:

- i. **Positive Switch.** Under this method the flight is directed to make a frequency change. This direction comes in the form of a radio call. This direction may come from the Section Leader/Lead or an agency external to the flight (e.g., Clearance Delivery, Ground, Tower, or Approach Control).

#### Example:

Lead - “ \_\_\_\_\_ *flight switch Ground.* ”

Flight - “ \_\_\_\_\_ *Two*”, “ \_\_\_\_\_ *Three*”, “ \_\_\_\_\_ *Four.* ”

(all aircraft now switch to ground).

Lead - “*South Ground, (aircraft call sign), taxi...*”

- ii. **Automatic Switch.** Under this type of frequency change, the flight will change frequencies as specified in the brief. This could be a specific time or over a pre-designated visual check point. This method depends on each aircrewmember taking detailed notes in the brief and paying very close attention during the flight. These frequency changes may or may not be accompanied by a check-in.

**Example:**

Lead - *“Ground, (aircraft call sign) and flight, taxi...”*

Ground - *“Roger, (aircraft call sign) and flight, you’re cleared to taxi...”*

Lead - *“(Aircraft call sign) and flight, Roger.”*

(The flight taxis as instructed and all aircraft switch to tower frequency at a pre-briefed time/location.)

Lead - *“Tower, (aircraft call sign) and flight takeoff...”*

- c. Utilization of the positive control method ensures all aircrews hear and comply. However, this type of communication is easy to jam and may tell the enemy your intentions and reveal the number of aircraft in your flight. It also interferes with other units using the same frequency. When flying with inexperienced aircrews, positive control might be necessary.
- d. The automatic switch requires more detailed planning. The switch from one frequency to the next may be accomplished in many different ways (e.g., by time, location or after prebriefed radio calls). This denies the enemy information and makes jamming difficult. The disadvantage is that the flight leader never knows if all aircrews are up his frequency, and therefore his flight may become confused and execute improper responses.

### 3. Brevity Code

In any Electronic Countermeasures environment where an aviator may encounter jamming, intrusion, or enemy direction finding, the situation may still necessitate the use of radios. At these times short, explicit transmissions understood by all are mandatory. The use of a standard brevity code will prove useful to reduce the length of these transmissions.

Each individual is required to memorize the brevity code. The more familiar each crewmember is with the code, the more quickly the transmissions can be understood and responded to. Individuals are discouraged from using brevity codes of their own, as it will tend to confuse matters in critical situations.

Standard brevity codes used on formation flights are:

CODE	MEANING	CODE	MEANING
BR	Breakup and rendezvous	OR	Overrun
CO	Crossover	HS	High speed approach
CT	Cruise turns	PTR	Proceed to route
CD	Climbs and descents	RTB	Return to base
LD	Lead change	CC	Combat cruise
TL	Takeoffs and landings	PF	Parade formation

## 502. LOOKOUT COMMUNICATIONS

In the modern battlefield, survival is intrinsically linked with finding and recognizing the enemy first. The helicopter's primary defensive weapon is avoidance of the threat. It is imperative each crewmember has an assigned lookout sector and each aircraft in a flight has a primary area of responsibility.

Pilots shall assign each crewmember a sector of lookout responsibility. Within the limitations of aircraft configuration, the combination of all such sectors shall provide 360° of lookout around the aircraft. Lookout sectors shall be designated by clock coding with 12 o'clock oriented on the nose of the aircraft. Vertical sectors shall be designated with reference to the horizon, HIGH to a position above the horizon, and LOW to a position below the horizon. Sectors should overlap when possible. Figure 5-1 depicts one possible method for assigning lookout responsibilities.

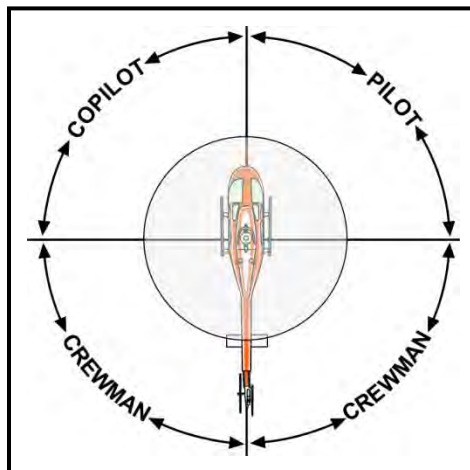

Figure 5-1 Lookout Responsibilities



Individual lookout sectors and responsibilities shall not be modified or relaxed when a helicopter is operating as a flight. Safety of the flight depends on the concept of several sets of eyes scanning the same or overlapping sectors to provide a better chance for timely attack warning than would be the case if each aircraft or aircrew were assigned a separate lookout sector. Clock code references for a flight shall be referenced from lead's 12 o'clock position.

Any crewmember that observes another aircraft, must immediately inform the pilot of the location and type. The position of a fixed-wing aircraft shall be expressed as the relative bearing in clock code and altitude in relation to the horizon.

1. FIXED-WING, FIVE O'CLOCK, HIGH.
2. FIXED-WING, TEN O'CLOCK, LEVEL.

The following terminology applies:

- a. Aircraft in sight - refers to sight of the target from your aircraft.
- b. Negative contact - target not in sight.

**THIS PAGE INTENTIONALLY LEFT BLANK**

## **CHAPTER SIX FORMATION FLIGHT**

### **600. INTRODUCTION**

This chapter introduces the student to the basic fundamentals of formation flying. The procedures and positions contained herein are intended to provide a foundation for formation flying which will meet most mission requirements.

### **601. FORMATION FLIGHT**

#### **1. Application**

It is essential the basic fundamentals of formation flying be practiced in preparation for combat readiness.

The number of formation aircraft required to accomplish a mission varies. A section will consist of two aircraft and a division will consist of three or four aircraft (two sections). Two or more divisions constitute a flight. Within any formation flight, there are certain terms used to designate aircraft within the flight as well as leadership designations or “chain of command” within the flight. The aircraft commander designated as the section leader is ultimately responsible for flight mission accomplishment and provides guidance for the conduct of the flight via a thorough mission brief and in-flight instructions. Other aircraft within the flight (dash-two, dash-three, etc.) are considered wingmen who are responsible for maintaining flight integrity and complying with the section leader's directions. These designations are made prior to the mission, identified on the flight schedule, and adhered to rigidly unless the section leader becomes incapacitated or otherwise unable to carry out his leadership responsibilities. Lead is a term used to indicate the first aircraft in a formation flight and the term Wing applies to all other aircraft in a formation flight. The section leader does not necessarily have to be Lead. For example, the section leader can be flying in the Wing position in the flight. Regardless of position in the flight, the section leader is ultimately responsible for the overall success or failure of the mission. All discussions in this manual assume a flight of two unless otherwise noted.

Two of the basic types of formations are parade and cruise. Parade is used primarily when there is a requirement for aircraft to fly a fixed bearing position in close proximity to each other and maximum maneuverability is not essential. It is most frequently employed during arrival at or departure from ships or airfields, or during flight demonstrations. Power is varied to maintain position. Cruise is used when maneuverability is a prime consideration for formations engaged in combat tactics. Lead must be able to use his formation as an integral unit and still be free to turn, climb, or dive the formation with few restrictions. The cruise formations outlined herein afford this flexibility. Radius of turn is varied rather than power to maintain position.

#### **2. Relative Motion**

Essentially, formation flying is nothing more than controlling the relative motion between aircraft. To maintain a fixed position, the relative motion must be stopped. To maneuver safely

in relation to another aircraft, the direction and rate of motion are controlled. Lead is considered “fixed” and any movement between aircraft is considered as movement of Wing in relation to Lead. In formation flying, Lead becomes the primary reference.

Relative motion can be resolved into movement about any one or a combination of all three axes. Primarily, fore-and-aft movement is controlled by airspeed and step-up is controlled with the collective. Because of the interrelation of controls, it is not possible to correct for undesired movement with any single control. All controls must be coordinated to fly formation properly.

### 3. Crew Resource Management

- a. Lead PAC makes all applicable external radio calls for the section. (Communication)
- b. Wingman PAC initiates all maneuvers with appropriate brevity code. (Communication)
- c. Lead PAC “*rogers*” all maneuvers. (Communication)
- d. Lead PNAC ensures safe navigation for the flight. (Situational Awareness)
- e. Wing PAC ensures proper separation from Lead. (Situational Awareness)

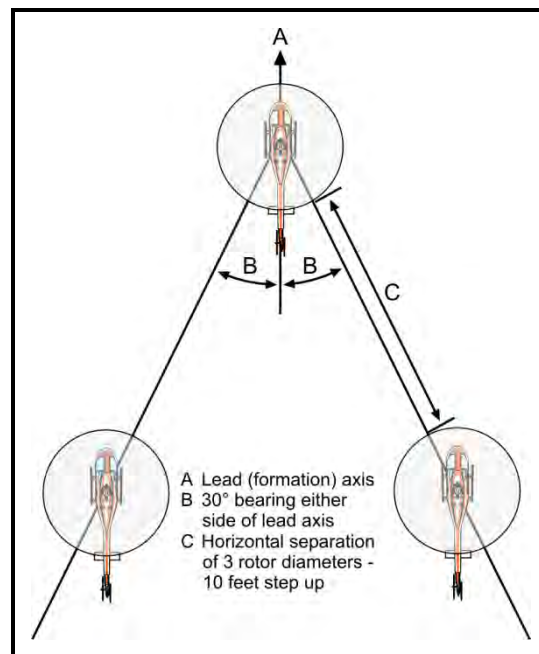

Figure 6-1 Formation

#### 4. Formation Positions

##### a. The Cruise Position

###### Description

- i. Cruise is primarily used en-route when maneuverability and navigation by all aircraft are the primary considerations. Wing maintains position through radius of turn with minimal power adjustments when Lead turns. Using radius of turn vice large power adjustments to maintain position allows Wing to approximately match Lead's fuel consumption, enabling both aircraft to arrive at the operating area with enough fuel on board to complete the assigned mission. If the radius of turn concept is not employed by Wing, the wing aircraft may have insufficient fuel to complete the mission. Cruise formation may be flown at any airspeed, but for training purposes it shall be flown at 80 KIAS when practicing maneuvers and at 100 KIAS while transiting to and from the designated operating area.
- ii. The cruise position, as flown by Wing, is on the 30° bearing, with ten feet of step-up, and three rotor diameters of longitudinal separation measured from blade tip to blade tip (See Figure 6-1). Wing is free to slide to either side of Lead. Wing should stay out of the trail position.
- iii. The 30° bearing is measured from Lead's tail, which is defined as the zero-degree bearing or Lead formation axis.
- iv. Visualization of the 30° bearing is attained by lining up the near skid heel with the far skid toe on Lead or the horizontal stabilizer positioned in the “elbow” (point at which the fuselage and tailboom come together) of the Lead. Ten feet of step-up can be maintained by placing Lead's rotor hub just below the horizon. Three rotor diameters separation in the TH-57 is approximately 100 feet of longitudinal or horizontal separation between tip path planes of both aircraft. Three rotor diameters is approximated when Wing can just read Lead's bureau number and cannot see “TH-57” on the lower section of Lead's vertical fin. Only through practice and concentration can this position be maintained with any proficiency.
- v. Cruise position responsibilities are as follows:
  - (a) Lead must present a stable platform in terms of attitude. It is imperative Lead's power setting remain as near constant as possible during all maneuvers.
  - (b) Lead shall ensure the flight is clear at all times.
  - (c) Wing must remain in position and respond quickly to avoid large power applications to return to proper position.

**b. Common Errors and Safety Notes**

- i. When flying in cruise formation, remember that all aircraft are a team. Wing is responsible for maintaining position relative to Lead.
- ii. Utilize small, smooth control inputs. The purpose of cruise is to provide tactical control of several aircraft while reducing fuel consumption and pilot fatigue.
- iii. Lead must be especially alert. Keep your “eyes out of the cockpit” and be aware of the formation's reduced maneuverability.
- iv. Good basic air work is essential by Lead.
- v. The most common error in formation operations is the Lead pilot's inability to manage more than one aircraft. All crews must think about all aircraft.
- vi. Wing's PAC shall keep scan focused on lead. Wing's PNAC must perform copilot duties to include an overlapping outside scan due to the primary scan focus of the PAC on Lead.
- vii. Maintain balanced flight while in formation (except for takeoff and landing) and avoid the tendency to point the nose of the helicopter at Lead with the pedals.

**c. Parade Formation (Demo Only)****Description**

- i. Parade formations are employed when there is a requirement for aircraft to fly a fixed bearing off Lead in close proximity and maximum maneuverability is not essential. It is most frequently used during arrival at or departure from ships and airfields during flight demonstrations. Parade formation shall only be demonstrated by the instructor.
- ii. Parade is flown utilizing a fixed bearing, fixed lateral distance, and fixed step-up. The parade position is the 45° bearing, ten feet of step-up, and one rotor diameter lateral separation.
- iii. The 45° bearing sight picture is achieved by visually aligning Lead's far skid toe with the near skid aft cross tube. For step-up, place Lead's rotor hub slightly below the horizon.
- iv. Wing shall rotate about Lead's axis for turns into Wing. Wing shall rotate about his own axis in turns away from Wing.
- v. Crossovers and overruns are done the same as in cruise, but with reduced lateral separation.

## 5. Formation Maneuvers

### a. Section Takeoff

#### i. Application

Section takeoffs are frequently used during normal missions and should be practiced to maintain proficiency. Power available, wind direction and velocity, and terrain features should be considered in determining aircraft positioning for takeoff.

#### ii. Procedures

- (a). Lead should make all radio transmissions to ground, and tower for taxi and takeoff instructions. Lead should ensure radio checks are performed on VHF and UHF primary frequencies prior to calling for taxi. If ATIS is available, report the information designator when calling for taxi. An example of Lead's call for clearance and taxi with one Wing should be as follows:

*“South Whiting Ground, (section leader call sign), flight of two, wingman's side number \_\_\_\_\_, request clearance VFR to Eastern/Western Form area, (time) \_\_\_\_\_, \_\_\_\_\_ souls each aircraft from spots \_\_\_\_\_ and \_\_\_\_\_ with information \_\_\_\_\_.”*

- (b). Both Lead and Wing must know each other's position on the parking ramp prior to taxi. If necessary, plan to meet at a specific point prior to switching to tower frequency for takeoff clearance. More than one Lead aircraft has taken off single aircraft while his Wing is still taxiing from the parking area.
- (c). Once the section is formed, continue taxiing in trail for takeoff. Wing should stay at a comfortable position behind Lead and remain out of Lead's rotor wash. Excessive power may be required due to the disturbed air caused by Lead's main rotor.
- (d). Lead obtains clearance for takeoff from the tower, notes the winds on the windsock or as reported by the tower, and positions his aircraft on the downwind side of the runway. Wing follows Lead onto the runway and assumes the cruise position on the upwind side of the section (Figure 6-2). Each aircraft will take the center of their side of the runway.

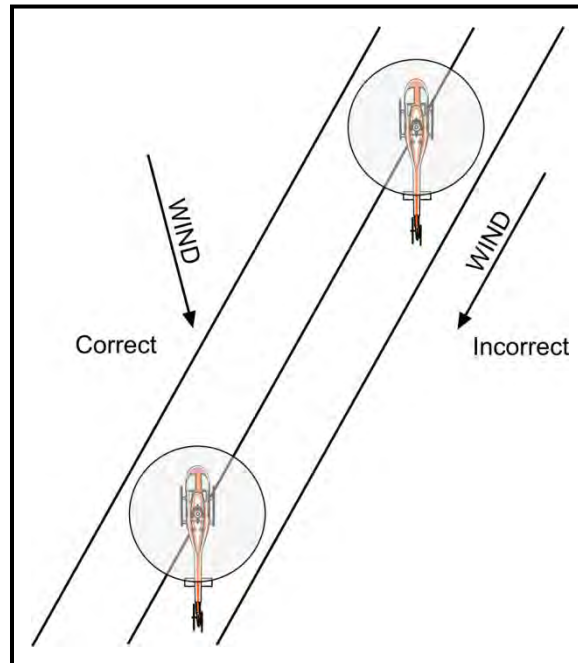

**Figure 6-2 Wing's Cruise Position**

- (e). When both aircraft are in position, a clearing turn shall be performed. The clearing turn is accomplished by both aircraft turning 45° towards each other. The pilot on the inboard side in each aircraft shall inspect the integrity of the other aircraft and clear the section on their respective sides, behind and above, while the other pilot in each aircraft checks the instruments and caution lights. When the section has completed these steps and the section is clear, the ready signal is given. Both aircraft will turn back to the takeoff heading. The ready signal is a thumbs up and searchlight on.
- (f). When the ready signal is given, Lead commences a normal transition to forward flight. Lead should avoid gaining excessive altitude at low airspeed. Focus on normal take-off parameters allowing Wing to gain position without utilizing a high power setting. Wing should maintain the cruise position throughout the takeoff. Wing shall be in the cruise position prior to executing cruise-type maneuvers.

**b. Crew Resource Management**

- i. Lead PAC makes all radio calls for formation. (Communication)
- ii. Lead PNAC/Wingman PNAC signal when ready for takeoff by turning search light(s) on, then off and/or giving a “thumbs up.” (Communication)



c. **Common Errors and Safety Notes**

- i. As Wing, avoid the common tendency to be late applying power and getting in Lead's rotor wash.
- ii. As Lead, avoid rapid power changes and/or continuous operation at maximum power. BE CONSIDERATE of your Wing.
- iii. Upon the completion of a lead change at an outlying field, Wing may now be on the downwind side of Lead. To preclude a potential overtorque situation during a downwind takeoff, wing shall pedal turn 90 degrees and taxi to the opposite side of lead, maintaining safe lateral separation from lead. Once in cruise position on the upwind side of Lead, both aircraft will execute a clearing turn prior to takeoff.
- iv. As Wing, avoid the tendency to close laterally with Lead due to a narrow scan, which focuses solely on Lead. Use of an active scan to maintain your position and takeoff lane relative to Lead will assist in holding a more solid cruise position during takeoff.

6. **Crossover (Straight and Level Flight)**

a. **Application**

A crossover is a maneuver used for training purposes to teach Wing control of relative motion while safely maneuvering about Lead. Crossovers are flown as a precision maneuver with four distinctive positions. In a fleet tactical scenario, Wing crosses at will. For training purposes, Wing shall announce his initial crossover to Lead. Crossovers shall be practiced at 80 KIAS.

b. **Procedures**

- i. For practice purposes, Wing shall initiate the maneuver by announcing "*Charlie Oscar.*" Lead shall roger "*Charlie Oscar*" prior to Wing commencing the maneuver.
- ii. Lead clears the flight and maintains constant heading, altitude, and airspeed.
- iii. Wing shall increase step-up to 20 feet while maintaining the cruise position. The 30° bearing with 20 feet of step-up is visualized when Lead's far skid toe just touches the bottom of the fuselage.
- iv. With 20 feet of step-up, start a slide to cross Lead's tail. This is accomplished by turning towards Lead only long enough to gain an angular difference from Lead's heading, and then going back to a wings level attitude. A slight increase

in power and some forward cyclic will be required to maintain longitudinal separation as Wing now has a diagonal movement in relation to Lead's flight path.

- v. Keep Lead in sight at all times. Stabilize.
  - vi. A visual picture of 20 feet of step-up while crossing Lead's tail is the upper anti-collision light passing through the main transmission well.
  - vii. Once positioned on the new 30° bearing, Wing should reduce power, realign heading with Lead, and momentarily stabilize on the new bearing with 20 feet of step-up. Wing will then reduce power to drop down into the normal necessary until a new maneuver is initiated.
- c. **Common Errors and Safety Notes**
- i. Lead must present a stable platform.
  - ii. Excessive step-up by Wing may result in losing sight of Lead and possible midair collision.
  - iii. Poor power and cyclic control by Wing will result in excessive aft drift while crossing over, thus requiring excessive power to regain position.
  - iv. Arcing around to the new bearing rather than flying straight across.

## 7. **Cruise Turns**

### a. **Application**

A cruise turn is a radius of turn maneuver enabling the pilot to practice maintaining cruise position while in a turn without adjusting power.

### b. **Procedures**

- i. For Wing to remain in position while the formation is performing a level turn, Lead must maintain a constant altitude, power setting, and angle of bank (AOB). Cruise turns should be commenced at an airspeed of approximately 80 KIAS and a recommended altitude of 1000 feet AGL. AOB should be 20°. For the purpose, of training, 20° will be used for the completion of this maneuver.
- ii. Wing initiates the maneuver by announcing, "*Charlie Tango*" on the UHF radio. Lead shall roger this transmission prior to commencing.
- iii. Lead clears the flight and smoothly rolls to the desired AOB in either direction maintaining altitude and a constant power setting. The initial airspeed of 80

KIAS may dissipate during the turn to a minimum of 60 KIAS, at which point power may be added to remain above 60 KIAS. Lead continues for a series of turns and reversals in the opposite direction.

- iv. Lead will turn using 20° AOB until the Wing calls for “*reversal*”. The Lead will then reverse the turn in the opposite direction and use 20° AOB. The Lead will maintain the turn until Wing calls for the next maneuver.
  - v. Wing should attempt to stay in the cruise position, relying on radius of turn and relatively constant power. When Lead initiates a turn, Wing shall maintain longitudinal clearance on Lead, by moving either to the inside or outside 30° bearing as necessary. For Wing to increase the distance from Lead using radius of turn, Wing must decrease the AOB; to decrease the distance, increase AOB. The 30° bearing is still visualized by lining up the near heel with the far skid toe or the horizontal stabilizer touching the “elbow” while in a turn. Step-up should be maintained on Lead's rotor hub by adjusting cyclic, not power.
  - vi. When on the inside of Lead's turn, adjust the AOB as necessary to maintain the 30° bearing until approaching three rotors, then reduce the AOB to cross to the outside of Lead's turn. As wing crosses Lead's six o'clock, feed in AOB to match Lead's AOB. As the distance between Wing and Lead increases, Wing should increase AOB as necessary in order to return to the 30° bearing on the inside of Lead. Ideal distance on outside of the turn is five to seven rotor diameters.
  - vii. This is a smooth maneuver with a constant power setting. There is no reason for radical or excessive cyclic inputs. The purpose of the maneuver is to control longitudinal distance between Wing and Lead utilizing radius of turn.
- c. **Common Errors and Safety Notes**
- i. Lead must present a stable platform. Altitude and power setting should remain constant. When setting constant power think “*Check Torque*” as a verbal reminder.
  - ii. Lead must constantly clear the flight during the turns.
  - iii. Lead should ensure turns are initiated smoothly and balanced flight is maintained. Altitude should be maintained precisely using cyclic and not collective.
  - iv. Wing must maintain proper step-up throughout the maneuver. Excessive step-up can easily result in loss of visual contact with Lead.
  - v. Wing ensures radius of turn, not power, is used to increase or decrease longitudinal distance from Lead.

- vi. Wing must keep the ball centered in order to get the most benefit from radius of turn.
- vii. Wing must use both inside and outside 30° bearing to ensure proper separation.

## 8. Cruise Climbs and Descents

### a. Application

Cruise climbs and descents enable the formation flight to climb and descend together in flight.

### b. Procedures

- i. It may become necessary to climb and descend a formation flight while enroute. To conserve fuel and to aid positioning in the flight, climb or descend at a power setting which yields 500 FPM and 80 KIAS.
- ii. For practice purposes, Wing shall initiate the maneuver by announcing “*Charlie Delta*.” Lead shall roger the “*Charlie Delta*” prior to commencing.
- iii. Lead clears the flight for either a climb or descent, then smoothly adjusts power for a climb/descent rate of 500 FPM and airspeed of 80 KIAS and rolls into a shallow turn (10 - 15 degrees AOB). Lead should reverse the direction of the turn at least once during the climb and at least once during descent. The climb or descent shall be for at least 500 feet of altitude change, after which Lead will stabilize momentarily then transition to a climb or descent in order to level off at the starting altitude.
- iv. Wing remains in the cruise position during the climb and descent. Wing has a lower power required when climbing on the inside of Lead. Therefore, Wing should attempt to climb on the inside and descend on the outside of Lead to reduce the possibility of an overtorque.

### c. Common Errors and Safety Notes

- i. Lead must present a stable attitude and clear the formation continuously.
- ii. Wing must anticipate power changes and a transition to a climb and descent. Delay in recognizing the relative motion change will result in an out of position condition for Wing requiring excessive power applications to regain the proper position.
- iii. Wing has lower power requirements when climbing on the inside of Lead. Wing should attempt to climb on the inside and descend on the outside of Lead to reduce the possibility of an overtorque.

- iv. Lead and/or Wing not recognizing position within the designated operating area prior to commencing the maneuver, also easily remembered by “*Check DME*”.

## 9. Breakup and Rendezvous

### a. Application

The rendezvous enables the formation flight to join aircraft after takeoff. The two basic types are a running rendezvous, using prebriefed airspeed differential and radius of turn to join the formation, and the second is the carrier type rendezvous. Only the carrier type rendezvous shall be introduced for training purposes.

### b. Procedures

- i. When practicing the carrier type rendezvous, breakups will be executed from the cruise formation on a cardinal heading. Wing shall initiate the maneuver by announcing “*Bravo Romeo*” over the UHF frequency. Lead shall acknowledge the transmission prior to commencing the maneuver.
- ii. After clearing the formation and receiving the proper signal (wing in position and search light on), Lead shall break away from Wing utilizing 30° AOB. The 30° AOB, altitude, and airspeed will be maintained for 180° of turn. Wing breaks in the same direction of turn after Lead passes through a 45° bearing oriented from Wing's nose.
- iii. Once all aircraft have completed the level 180° turn, the formation will be in an extended trail position of approximately 800 to 1000 feet of nose-to-tail separation. Wing shall keep Lead on the horizon. This position is necessary for Wing to begin the rendezvous.
- iv. When established in the extended trail position and ready to commence the rendezvous, Wing shall signal Lead by stating the flight's call sign and keying the UHF twice. This is the only accepted meaning of two clicks during tactical training and any other use of this signal is discouraged.
- v. Lead's turn to initiate the rendezvous may be made in either direction. Attempt to keep Wing from joining up into the sun. Lead may turn either direction flashing to 20° AOB momentarily, then stabilizing at ten degrees AOB for 180° of turn while maintaining altitude and 80 KIAS.
- vii. Wing turns inside Lead's radius of turn to effect the join-up. Wing becomes established on Lead's 45° bearing utilizing AOB to maintain bearing and relatively constant power to maintain at least 80 KIAS. Airspeed may be adjusted as necessary to effect timely closure. Wing shall keep Lead on the horizon. Approaching three-rotor diameters, Wing should slide back to the 30° bearing and establish the cruise position inside the turn.

c. **Common Errors and Safety Notes**

- i. Both aircraft should roll into and out of the initial break smoothly yet smartly and maintain altitude.
- ii. Both aircraft should maintain 30° AOB through the initial break for 180° of turn.
- iii. As Wing approaches three rotor diameters, power should be adjusted to establish the aircraft on the 30° bearing while maintaining ten feet of step-up.
- iv. Ensure proper step-up is maintained on join-up to allow for a safe overrun. Proper step-up is visualized by keeping Lead's rotor hub at or slightly below the horizon during rendezvous.
- v. If closure rate becomes excessive or uncomfortable, do not hesitate to execute an overrun.

10. **Overrun**

a. **Application**

The overrun maneuver enables the formation flight to maneuver to a safe position when a dangerous closure rate is recognized during turns or join-up. It allows Wing to clear Lead, avoiding potential midair collisions.

b. **Procedures**

- i. Wing increases step-up to 20 feet and levels the wings. This increase in step-up should be accomplished through an increase in power and not application of aft cyclic. Leveling the wings enables Wing to slide to the outside of the Lead's turn.
- ii. Wing may regain the cruise position on the outside after safe separation from Lead is attained. Keep Lead in sight at all times.
- iii. After Wing has completed the maneuver, Wing shall announce "*Oscar Romeo*" on UHF.

c. **Common Errors and Safety Notes**

- i. As soon as closure rate becomes uncomfortable, DO NOT HESITATE to initiate an overrun.
- ii. NEVER underrun Lead or pass directly below Lead.
- iii. Do not lose sight of Lead. Losing sight will increase the possibility of a midair collision.

- iv. Do not apply aft cyclic to gain step-up. This increases the possibility of losing sight of Lead. Utilize power to increase step-up and closely monitor torque.

## 11. Lead Change

### a. Application

The lead change enables the formation flight to exchange Lead.

### b. Procedures

- i. All lead changes shall be accomplished with positive two-way radio communications. In the event of lost communication, prebriefed visual signals shall be utilized.
- ii. All lead changes shall be acknowledged to ensure all members of the formation understand. In flight, lead changes shall be executed from level flight in cruise position. For training purposes, lead changes shall be flown at 80 KIAS and in a straight and level flight. Visual contact must be established and maintained between the original Lead and new Lead before a lead change is effected. **THE PILOTS ON THE INBOARD SIDE OF THE SECTION SHALL BE AT THE CONTROLS DURING THE LEAD CHANGE.**
- iii. For practice purposes, Wing shall initiate the maneuver by announcing on UHF "*Lima Delta.*" Lead must roger the "*Lima Delta*" prior to commencing. Lead shall maintain constant airspeed and altitude.
- iv. At this point, Wing shall increase lateral separation, move abeam the original Lead and transmit "*(Aircraft call sign) in position for lead change.*" When both pilots have visual contact, the original Lead transmits "*(Aircraft call sign) you have the lead.*" The original Wing replies, "*Roger (Aircraft call sign) has the lead.*"
- v. From this point the original Lead becomes Wing and shall effect a slow drift aft to the 30° bearing while maintaining lateral separation. The original Wing is now Lead and must maintain a constant heading, altitude, and airspeed while the formation completes the lead change.
- vi. The lead change on deck is executed as follows: Wing calls "*Lima Delta,*" Wing takes safe lateral separation and taxis abeam Lead. **THE PILOTS ON THE INBOARD SIDE MUST HAVE THE CONTROLS.** Wing will call "*(Aircraft call sign), in position for lead change.*" Lead will respond with "*(Aircraft call sign), you have the lead.*" New Lead will respond with "*Roger (Aircraft call sign) has the lead.*" At this point "new" Lead will taxi far enough ahead to place new Wing on the 30° bearing. If it is necessary for new wing to move to the upwind side, based on wind direction, each aircraft will make a 90 degree pedal turn and taxi

(with safe lateral separation) to the appropriate side of the lane. Both aircraft face inboard (45° turn) and give the ready signal for takeoff.

**NOTE**

Wing shall be on the upwind side of Lead prior to takeoff.

**c. Crew Resource Management**

- i. Wing PAC can initiate formation lead change by radio call. (Communication)
- ii. Wing PNAC can initiate lost communications lead change by visual signal. (Communication)
- iii. Lead PNAC can initiate lost communications lead change by visual signal. (Communication)

**d. Common Errors and Safety Notes**

- i. Do not lose sight of the other aircraft during the lead change.
- ii. Do not rush the maneuver. Avoid rapid closure rates.
- iii. New Wing must anticipate the 30° cruise bearing in order to avoid drifting too far aft.
- iv. New Lead should advance slowly on old Lead, ensuring at least a three-rotor diameter separation is maintained while moving abeam.
- v. Relative motion should not stop during the maneuver.
- vi. Wing calls in position prior to moving fully to the abeam position.

**12. Parade Break (Demo Only)**

**a. Description**

**b. Application**

The Parade break is a procedure to transition the section from the parade position to a normal approach landing in trail.

**c. Procedures**

- i. The section shall be in the parade position, 500 feet AGL and 100 KIAS prior to crossing the approach end of the duty runway. Lead shall ensure Wing is joined



in a position opposite the direction of the break. The break shall commence away from tower.

- ii. When cleared by tower “for the break”, Lead will break away from Wing over the intended point of landing, executing a level turn to arrive at the downwind position of 500 feet AGL and 70 KIAS. Wing breaks in the same direction of Lead when Lead passes through the 45° bearing. Once the aircraft have completed the level 180° decelerating turn, the formation will be in an extended trail position.
- iii. At the abeam position, each aircraft will execute a normal approach to the intended point of landing in trail position.

### 13. Section Landings

#### a. Application

The section landing enables the formation flight to land in formation.

#### b. Procedures

- i. Section landings shall be flown at a pattern altitude and airspeed of 500 feet AGL and 70 KIAS with Wing in the cruise position. All approaches may terminate in a hover followed by a vertical landing or a no-hover landing.
- ii. Lead shall utilize normal approach procedures and allow sufficient straightaway and shallow enough glideslope on final so that Wing need not make rapid or abrupt power and nose attitude changes.
- iii. As Wing, make expeditious power and attitude adjustments to maintain a solid cruise position until reaching short final.
- iv. During the descending, decelerating turn from downwind to final, Wing will use procedures learned during Climbs and Descents and Cruise Turns to maintain position. Wing shall plan to land on the upwind side of Lead.
- v. At approximately 100 feet AGL on short final, Wing should divide his scan evenly between Lead and a landing lane, which enables a three-rotor separation to be maintained relative to Lead. If an obstacle in this landing lane precludes a safe landing, execute a waveoff.
- vi. Lead must control the closure rate to the LZ with smooth power applications early enough to prevent Wing from overshooting Lead.

- vii. In order to provide a waveoff capability on final approach, Wing should maintain step-up until short final and in a position to intercept a glideslope to a safe landing. Avoid Lead's rotor wash.
- viii. Wing shall always plan the approach to land on the upwind side of Lead.
- c. **Crew Resource Management**
  - i. Any aircrew initiates formation waveoff by radio call. (Communication)
  - ii. Any wing aircrew initiates Wing waveoff by radio call. (Communication)
- d. **Common Errors and Safety Notes**
  - i. Lead must avoid large attitude changes on final or large power changes in the hover transition, which may result in Wing overshooting Lead.
  - ii. As Wing, do not overtake Lead on landing. Keep Lead in sight at all times. Waveoff if it appears you are overtaking Lead or if visual reference is lost.

#### 14. Section High-Speed Approach

##### a. Application

The section high-speed approach enables the formation flight to execute a high-speed approach in formation.

##### b. Procedures

- i. This maneuver is practiced from a pattern altitude and airspeed of 500 feet AGL and 80 KIAS. Wing remains in cruise position throughout the maneuver. In the downwind, maintain 500 AGL and accelerate to 80 KIAS.
- ii. From the abeam position at the downwind field boundary, begin a descending turn to arrive on final with 80 KIAS and level at 50 feet AGL.
- iii. The section shall decelerate to 15 to 20 KIAS while maintaining 50 feet AGL. Wing's scan is divided between Lead and the intended landing lane. Lead intercepts a steep approach glideslope to the intended point of landing and should terminate in a no-hover landing.

##### c. Common Errors and Safety Notes

- i. Wing drifts out of position during the turn.
- ii. Lead levels off at 50 feet AGL incorrectly by using aft cyclic vice correctly adding power.

- iii. Wing tends to drift towards Lead while decelerating vice maintaining separation.
- iv. Wing can easily overshoot Lead, particularly if Lead makes a large, rapid power reduction.
- v. Lead should avoid the tendency to settle while decelerating. If 50 feet AGL is not maintained, the section will have a rapid closure rate with the ground, resulting in a need for a large power input.
- vi. Wing must be cognizant of torque during the transition to a hover, particularly if there is a rapid closure with the LZ because Lead “mushed” through the glideslope or if settling into Lead's rotor wash.

## 15. Section Inadvertent IMC

### a. Application

The Section Inadvertent IMC maneuver is executed to quickly separate two aircraft after one or both have entered IMC conditions and can no longer maintain safe visual separation from the other.

### b. Procedures

- i. Once called, the wing aircraft will immediately turn away from the lead aircraft calling side and direction of turn.
- ii. Upon hearing this call the PAC of the lead aircraft will call out the base heading and base altitude.
- iii. Once the wing aircraft is passing through the 90° of turn, relative to the base heading, the PAC of the wing aircraft will call out “*passing through the 90*”.
- iv. Upon hearing this call the lead aircraft will then turn in the opposite direction and both aircraft will continue their turns for a total of 170° relative to the base heading as called by lead.
- v. At the completion of the turns, a check-in will take place and the Section Leader will direct the actions of the flight. For VMC join-up, wing shall maintain 200 feet above base altitude until visual contact with lead is established. Once join-up is initiated, wing will descend to base altitude.

### c. Crew Resource Management

Any crewmember may initiate the section inadvertent IMC procedure.  
(Communication)

d. **Common Errors and Safety Notes**

- i. Lead not immediately responding to the initial call with a base heading and base altitude call.
- ii. Wing not making call as they pass through 90° relative to the base heading.

16. **Section Waveoff**

a. **Application**

The Section Waveoff allows either aircraft individually or both aircraft collectively to discontinue an approach and transition to a normal climb. The Section Waveoff is a transition from a low power, descending flight condition to a power on climb for one or both aircraft.

There are three conditions under which a Waveoff may be necessary.

- i. Scenario 1. When someone external to the section makes the waveoff call, Lead will make the internal and external calls. Both aircraft will wave off.
- ii. Scenario 2. Someone internal to the section may call for a section wave off by calling "*Mud flight wave off.*" Both aircraft will wave off and Lead will make the external call.
- iii. Scenario 3. If Wing waves off, Wing will make one call using his own side number. EXAMPLE: "*Eightball/Factoryhand 110 waving off, left/right side.*"

b. **Procedures**

- i. Ensure the twist grip is full open.
- ii. Increase the collective to establish a rate of climb. Maintain balanced flight.
- iii. If a waveoff is called for the section, maintain cruise position relative to lead and execute climbout from field. If a waveoff is being executed as a single ship maintain safe lateral separation from the other aircraft and execute climbout.

c. **Crew Resource Management**

- i. PAC or PNAC initiates the waveoff using appropriate procedures if uncomfortable with the maneuver. (Decision Making)
- ii. PNAC calls waveoff if glideslope becomes excessive and/or rate of descent exceeds 800 FPM at airspeeds less than 40 KIAS. (Assertiveness)

- iii. PAC performs waveoff when a crewmember calls “*waveoff*”. (Adaptability/Flexibility)
  - iv. PAC and PNAC ensure twist grip is full open. (Situational Awareness)
  - v. PAC/PNAC monitor rotor RPM, TOT, and torque. (Situational Awareness)
  - vi. PAC makes appropriate radio calls as required. (Communication)
- d. **Common Errors and Safety Notes**
- i. Using excessive power exceeding torque limitations of aircraft.
  - ii. Making improper call causing section to wave off when intent is for a single ship waveoff.

## 602. HELICOPTER FORMATION BRIEF

### 1. Application

The following mission brief shall be conducted prior to all formation flights in the Training Command. It is designed to introduce fundamental briefing procedures for formation operations. For training standardization, this particular brief is modeled on the SMEAC format commonly used in the Marine Corps. However, SMAs can expect briefing formats in the fleet to vary by community and specific mission requirements.

This brief is divided into six distinct sections. The first is **Orientation** which consists of: introductions, time hack, section responsibilities, callsigns, aircraft assignments, pen and ink changes, maps required, and weather brief. The remainder of the brief follows the **SMEAC** format: Situation, Mission, Execution, Administration and Logistics, and Command and Signal. Each of these sections is organized into multiple subsets to cover all aspects of the planned event.

Information encapsulated by arrows (< >) is amplifying information and not required to be stated in the brief. The brief shall be conducted in the prescribed format, but specific wording is at the discretion of the student. The only topics which should be recited verbatim are emergency type procedures such as: IIMC, Lost Contact, Aborts, Waveoffs and Lost Communication as these are emergency procedures.

SMAs shall divide the brief into two sections. The first briefer shall cover Orientation through IIMC, the second Lost Contact through Command and Signal. It is extremely important students work together and become proficient with both portions of the brief, as they will alternate every flight.

For each flight, a Smart Pack shall be provided by the student to each member of the flight. The Smart Pack shall include, at a minimum, a Smart Card, Route Card (F4101 only) Terminal Area

Diagram, grade sheet, and weight and balance. Pages shall be numbered, individual crewmember names highlighted, and all edges aligned. Pen and ink changes are utilized to amend existing information on the Smart Card or to add new information entirely. If information is received well before the scheduled brief time, these changes may be made by the briefer(s) on each Card and noted during the brief to ensure continuity. Otherwise the briefer may instruct flight members to make appropriate changes during the brief. Listing critical mission information such as frequencies, fuel calculations, etc. Follow the example provided in this briefing guide for proper format. Pen and ink changes are utilized to amend existing information on the Smart Card or to add new information entirely. If information is received well before the scheduled brief time, these changes may be made by the briefer(s) on each Card and noted during the brief to ensure continuity. Otherwise the briefer may instruct flight members to make appropriate changes during the brief.

## 2. Procedures

### Orientation

#### a. Introduction

*“Attention to brief. I am \_\_\_\_\_ and will conduct the first portion of the brief, \_\_\_\_\_ will conduct the second portion. Please hold all questions until the end.”*

#### b. Time Hack <Shall be conducted during every brief>

*“At my hack the time will be \_\_\_\_\_. 45 seconds...30 seconds...15 seconds...10 seconds...5, 4, 3, 2, 1, HACK, 1, 2, 3...at my hack the time was \_\_\_\_\_.”*

<Obtain accurate time from Naval Observatory Master Clock: DSN 762-1401. Allow at least 30 seconds before hack.>

#### c. Aircraft Assignments

*“\_\_\_\_\_ and \_\_\_\_\_ will be in the lead aircraft \_\_\_\_\_ on spot \_\_\_\_\_. \_\_\_\_\_ and \_\_\_\_\_ will be in the wing aircraft \_\_\_\_\_ on spot \_\_\_\_\_.”*

#### d. Section Leader & Callsigns

i. *“The section leader for today’s flight is \_\_\_\_\_.”*

ii. *“The external call sign is Eightball/Factoryhand/Lucky \_\_\_\_\_.”*  
<Section Leader’s side number>

iii. *“The internal call sign is \_\_\_\_\_ flight.”*

## e. Smart Card

*“The following Pen and Ink changes have been/should be made to the smartcard: \_\_\_\_\_”* <Cover all changes to or information written into smartcard made after it was printed.>

## f. Maps Required

*“The maps and pubs required for this flight will be per the SOP.”* <Include low-level navigation charts for F4101.>

## g. Weather

*“The current weather is \_\_\_\_\_. The forecasted weather is \_\_\_\_\_. The required weather for the flight is \_\_\_\_\_.”* <Provide a brief summary of current and forecasted weather, with focus on expected conditions during the planned flight time and possible impact on the mission.>

**3. Situation**

This section is not applicable.

**4. Mission**

*“The mission is the safe completion of \_\_\_\_\_.”* i.e., F4001

**5. Execution****6. Concept of Operations****a. Operating Area.**

Big picture - Brief the area using the 1:250,000 JOGAIR, Eastern Formation Area Map and low-level navigation charts as applicable. Example: *“We will depart South Whiting Field to conduct training in the Eastern Formation Area, proceed to OLF Harold for pattern work, and return to South Whiting upon completion.”* Describe area boundaries using visual checkpoints and available NAVAIDs. If necessary, the briefer should use a pointer to reference visual aids.

**b. Obstacles to Flight and Control Measures**

Identify location of specific obstacles and control measures utilizing ABCTRP: Aircraft; Birds; Class C Airspace; Towers; Restricted Areas; Power lines. Mention the obstacle to flight, and de-confliction method, and applicable mitigation controls.

## 7. Scheme Of Maneuver

For training purposes, “T times” are utilized to allow flexibility for takeoff time, or “T.” In the fleet a specific time may be designated for takeoff, overhead, etc. All other times will be calculated by working backward from that time. Example: For a 1200 takeoff, conduct preflight at 1130, turn-up 1145, check-in at 1150, taxi at 1155.

a. **Preflight**

*“Preflight will be conducted at T-30.”*

b. **Turn-up**

*“Turn-up will be conducted at T-15.”*

c. **Check-in**

*“Check-in will be at T-10 on VHF 121.95 and UHF BTN 5/6/7”. After outbound call to base/skeds we will conduct a positive switch to BTN 3 via one turn in ATIS (BTN 1).*

d. **Taxi**

*“Taxi for take-off at T-5.”*

e. **Take-off**

*“We will execute an automatic switch to BTN 4 when lead is 200’ prior to the hold short, then at takeoff time we will depart appropriate spot in Cruise Formation.”*

f. **Enroute**

Brief execution of flight from South Whiting to Formation Area or Low-Level route as applicable. For F4101, include detailed route brief forward, procedures for Lead Change, then overview of reverse route. At each change point (i.e. Deaton Bridge, PT Racetrack, etc.) brief the following: Airspeed; Altitude; Frequency UHF/VHF (check in/no check in); Squawk; Formation. Course rules arrivals/departures do not require point to point briefing. Example: “We will depart South Whiting via course rules to PT Able, 900 ft, 100 KIAS, squawking 0400, on BTN 4 UHF/121.95 VHF in Cruise Formation.”

g. **Sequence of Events (F4001-4003)**

*“Sequence of Events will be CO, CT, CD, BR, OR as required and LD. Repeat sequence minus LD.”*



h. **Landings**

Brief route/course rules to OLF (A/S, Alt, Freq, Sqwk, Form). Conduct an OLF brief including OLF procedures and Landing Site Evaluation IAW NATOPS Ch. 17. Description shall include types of landings to be conducted (Normal and/or HS), LD on deck, repeat sequence.

i. **RTB**

Upon completion of the landing sequence, Wing will call for RTB. The flight will re-split as necessary and depart the OLF at the appropriate departure corner. Lead will report departing to the RDO, fly appropriate course rules IAW RWOP, and conduct a positive switch to base with a check-in. Lead will then call inbound to base for next students or with status of the aircraft. Lead will conduct a positive switch to Tower Button 4 via one turn in ATIS. At appropriate entry point, Lead will report the flight's position to Tower and request the homefield Break (F4001) or negative break.

j. **Coordinating Instructions**

i. Emergencies

*“Aircraft emergencies will be handled internally, notifying the other aircraft when safe to do so. Emergencies will be considered actual unless prefaced with the word “simulated.” The Section Leader will determine the conduct of the remainder of the flight.”*

ii. IIMC

“If the flight encounters IIMC and Wing has sight of Lead, Wing will maintain position. If Wing loses sight of Lead, Wing will call “[Internal Callsign] Flight Lost Sight” and immediately turn away from Lead calling side and direction of turn. Lead will stabilize and call base heading and altitude. Wing will continue turn and commence a climb to 200 feet above base altitude. Wing will call passing through 90° of turn, then Lead will execute a turn in the opposite direction. Both aircraft will turn for 170° or until established VMC. When Lead rolls out, the PAC will commence a check-in with their status and fuel state <i.e. VMC (in sight/not in sight) or IMC, 1+15 remaining.> At this point one of three cases will exist:

- (a). **Case 1. Both aircraft VMC:** *“Aircraft will join up as specified by the Section Leader. Wing shall maintain 200 feet above base altitude until visual contact with Lead is established. Once join up is initiated Wing may descend as appropriate. Section Leader will direct conduct of the remainder of the flight.”*

- (b). **Case 2. One aircraft VMC/One aircraft IMC:** *“The Section Leader will call for a positive switch to Approach with a check-in. The PAC of the IMC aircraft will contact approach, informing them of the situation and obtaining a discrete squawk. Once the IMC aircraft is under positive control, the Section Leader will dissolve the flight and each aircraft will proceed as necessary, returning to base if possible.”*
- (c). **Case 3. Both aircraft IMC:** *“The Section Leader will call for a positive switch to Approach with a check-in. The Section Leader will inform Approach of the situation and obtain two discrete squawks. Once both aircraft are under positive control, the Section Leader will dissolve the flight and each aircraft will proceed as necessary, returning to base if possible.”*

iii. Lost Contact

*“If Wing loses sight of Lead, Wing will maneuver as necessary to gain safe separation and call ‘ \_\_\_\_ flight, lost contact.’ Lead will remain predictable, calling base heading and altitude or communicate intentions as appropriate. Join up will be per “Case 1” under inadvertent IMC. If loss of visual contact occurs in the pattern, it is a mandatory waveoff for Wing. Lead will continue to landing.”*

iv. Disorientation Procedures

*“If either aircraft becomes disoriented, the PAC will call “[Internal Callsign] Magellan.” The PAC of the other aircraft will communicate heading and distance to the next checkpoint. If Lead passes a checkpoint without calling the point or steers off the route more than 1 NM, Wing will communicate “[Internal Callsign] Flight Magellan” with heading and distance. If both aircraft are disoriented, the flight will orbit present position and altitude using standard rate right hand turns and utilize all assets in the aircraft to become reoriented. Once reoriented, the flight will continue.”*

v. Downed Aircraft

*“If an aircraft within the section goes down, the remaining aircraft commander will assume the duties of On-Scene Commander and execute the On-Scene Commander Checklist. If the flight should encounter a downed pilot and/or aircraft, the Section Leader will assume the duties of On-Scene Commander and execute the On-Scene Commander Checklist. The other aircraft will remain clear until tasked by the On-Scene Commander.”*

vi. Aborts

*“If an aircraft aborts prior to takeoff, the PAC will notify the other aircrew as*

*soon as possible. On takeoff, if Lead aborts, Wing will abort with Lead if it is safe to do so. If not, Wing will continue to take off, enter a downwind and land clear of Lead. If Wing aborts, Lead will continue to takeoff, enter a downwind and land clear of Wing.”*

vii. Waveoffs

<State the three waveoff scenarios and who makes the internal and external calls.>

*“All waveoffs are mandatory regardless of who makes the call. All calls for a section waveoff shall be repeated verbatim by each PAC. The three scenarios are:”*

- (a). Scenario 1: When someone external to the section makes the waveoff call, Lead will make the internal and external calls. Both aircraft will waveoff.
- (b). Scenario 2: Someone internal to the section may call for a section waveoff by calling “\_\_\_\_\_flight waveoff.” Both aircraft will waveoff and Lead will make the external call.
- (c). Scenario 3: If Wing waves off, Wing will make an external call using his own side number. Lead will continue to a landing. <Example:  
“Eightball/Factoryhand/Lucky 110 waving off, left/right side.”>

<When executing a waveoff, controls should be transferred to the pilot with the best situational awareness (SA). This is especially critical if Wing must execute a waveoff.>

8. Administration and Logistics

a. FLIGHT DURATION

*“We will call outbound for \_\_\_\_\_.”* <Typically 2+30.>

b. FUEL

- i. *“Mission Fuel is \_\_\_\_\_ gal.”* <Typically 75 gallons.>
- ii. *“Go/No Go Fuel is \_\_\_\_\_ gal.”* <Fuel required to complete the flight and return to South Whiting via Course Rules with ten gallons deck.>
- iii. *“Bingo from the farthest point in the area is \_\_\_\_\_ gallons. Bingo from OLF is \_\_\_\_\_.”* <Calculated using max range airspeed given current ambient conditions to be on deck at closest fuel source with ten gallons.>

9. **Command and Signal**

## a. CHAIN OF RESPONSIBILITY

**Section Leader**

<As previously briefed.>

## b. CALLSIGN

**Internal/External**

<As previously briefed.>

## c. COMMUNICATIONS

*“Lead will make all external calls using the Section Leader's side number. Wing will initiate all maneuvers using the appropriate brevity codes. Anyone can make a safety of flight call.”*

i. **Frequencies/Nav aids**

*“Frequencies and NAV AIDs will be as per Smart Card.”*

ii. **Frequency changes**

*“All changes will be positive switches unless over an automatic change point.”*  
<i.e., 200 feet prior to holdshort, PT Fish, etc.>

iii. **Lost Communications****NOTE**

When an aircraft in the flight goes Lost Comm, the roles in the section have changed from Lead/Wing to Good Comm/Lost Comm aircraft. Once the Lost Comm lead change is complete, the standard roles are resumed.>

*“For the purposes of demonstration, palms down signifies normal lighting configuration and palms up signifies lost comm lighting configuration.”*

- (a). **LEAD LOST COMM:** *“If Lead experiences a total radio failure, Lead will switch to the lost comm lighting configuration and slow to 65 KIAS to gain Wing's attention. The good comm aircraft will gain safe lateral separation and move abeam the lost comm aircraft, then switch to the lost comm lighting configuration to signify, ‘I understand you are lost comm, I am in position for a lead change.’ The lost comm aircraft will return to the normal lighting configuration to signify, ‘You have the lead.’ The*

*good comm aircraft will then return to the normal lighting configuration to signify, 'I have the lead.'*"

*The lost comm aircraft will then slide back to the 45° bearing. The flight will proceed as necessary, returning to base if possible."*

- (b). *WING LOST COMM: "If Wing experiences a total radio failure, Wing will switch to the lost comm lighting configuration, gain safe lateral separation and move abeam Lead to signify, 'I am lost comm.' The good comm aircraft will then switch to the lost comm lighting configuration to signify, 'I understand you are lost comm, I will retain the lead.' The lost comm aircraft will then return to the normal lighting configuration to signify, 'You have the lead.' The good comm aircraft will return to the normal lighting configuration to signify, 'I have the lead.' The lost comm aircraft will slide back to the 45° bearing. The flight will proceed as necessary, returning to base if possible."*

iv. **Terminology**

(a). **Terminate**

"Terminate can be called by any aircrew to discontinue a maneuver by stating '[Internal Callsign] Flight Terminate.' The flight will abort the maneuver, reset, communicate as necessary, and continue with remaining maneuvers."

(b). **Knock-It-Off**

"Knock-it-off can be called by any aircrew following a safety of flight occurrence that distracts or prevents the continuation of training. By calling '[Internal Callsign] Flight Knock-it-Off,' the flight will be discontinued, and the respective IPs will ferry the aircraft back as a section. Debrief of the occurrence shall occur once on deck."

(c). **Hard Deck**

"The Tactical Hard Deck for today's flight is \_\_\_\_."

v. **ID and Recognition**

*"The Section Leader will squawk the appropriate code in the ALT mode. The other aircraft will squawk the appropriate code in standby. If the flight is dissolved or separated for any reason, each aircraft will squawk the appropriate code in the ALT mode."*

vi. **Visual Signals**

*“Visual Signals will be as per Smart Card. Are there any questions?”*

**603. NATOPS BY-EXCEPTION BRIEF**

Immediately following the mission brief, continue with the NATOPS by exception brief to cover any remaining NATOPS items not addressed in the mission brief.

In the fleet, flight crews may break up and conduct individual NATOPS briefs to address NATOPS/SOP items specific to their crew/airframe. This is particularly useful when conducting mixed section operations.

Smart Card

<To be used as a template only.>

F 4XXX

LEAD \_\_\_\_ SPOT \_\_\_\_

PIC \_\_\_\_\_

C/P \_\_\_\_\_

EXT CALL SIGN \_\_\_\_\_

(\*\* DENOTES SECTION LDR)

WING \_\_\_\_ SPOT \_\_\_\_

PIC \_\_\_\_\_

C/P \_\_\_\_\_

INT CALL SIGN \_\_\_\_\_

FUEL

MISSION \_\_\_\_\_

GO-NO-GO \_\_\_\_\_

BINGO \_\_\_\_\_

MAX RNG A/S \_\_\_\_\_

NAVAIDS

NORTH WHITING 112.3/70X

CRESTVIEW 115.9/106X

GATESWOOD 60X

UHF PRESET FREQUENCIES    VHF FREQUENCIES

1 ATIS 273.57

3 GROUND 346.8

4 TOWER 348.67

5 HT-8 BASE 303.6

6 HT-18 SKEDS 255.1

7 HT-28 SKEDS 365.7

11 SANTA ROSA 361.1

12 HAROLD 237.9

13 SITE 8 251.3

15 ORANGE RTE 262.7

16 PURPLE RTE 377.1

17 FORM COMMON 380.4

18 EAST BAY CMN 277.0

INSTRUCTOR COMMON 121.95

WHITING TOWER 121.4

EGLIN APPROACH 124.05

PENSACOLA APP 124.85

PENSACOLA APP E 119.0

CRESTVIEW CTAF 122.95

CRESTVIEW ASOS 119.275

FLORALA CTAF 123.0

FLORALA CTAF 124.17

VISUAL SIGNALS

1. READY – SEARCHLIGHT ON/THUMBS UP

2. NORMAL LTG – ANTI-COLL LTS: ON

19 WEST FORM CMN 311.4  
 20 EASTERN COMM 389.1

3. LOST COMM LTG – ANTI-COLL LTS: OFF  
 POSN LTS: FLASH/BRT

SEQUENCE OF MANEUVERS

CO / CT / CD / BR / OR / LD

ATIS: \_\_\_\_\_ WIND: \_\_\_\_\_ ALT: \_\_\_\_\_ RWY: \_\_\_\_\_  
 ATIS: \_\_\_\_\_ WIND: \_\_\_\_\_ ALT: \_\_\_\_\_ RWY: \_\_\_\_\_  
 T/O: \_\_\_\_\_ LAND: \_\_\_\_\_

HT Formation Briefing Guide

ORIENTATION

- INTRODUCTION
- TIME HACK
- AIRCRAFT ASSIGNMENTS

LEAD \_\_\_\_\_ & \_\_\_\_\_ SPOT \_\_\_\_\_

WING \_\_\_\_\_ & \_\_\_\_\_ SPOT \_\_\_\_\_

- SECTION RESPONSIBILITIES & CALLSIGNS

SECTION LDR \_\_\_\_\_ EXT CALLSIGN \_\_\_\_\_ INT CALLSIGN \_\_\_\_\_

- SMARTPACK INVENTORY/PEN&INK CHANGES
- MAPS REQUIRED \_\_\_\_\_
- WEATHER

CURRENT \_\_\_\_\_

FORECAST \_\_\_\_\_

REQUIRED \_\_\_\_\_

SITUATION

MISSION

EXECUTION

- CONCEPT OF OPERATIONS

OPERATING AREA BOUNDARIES

OBSTACLES BRIEF (ABCTRP)

- SCHEME OF MANEUVER
  - o PREFLIGHT @ T-30
  - o TURN-UP @ T-15
  - o CHECK-IN @ T-10 ON VHF 121.95 UHF \_\_\_\_\_

POS SWITCH GROUND VIA ONE TURN OF ATIS

- o TAXI @ T-5, AUTO SWITCH TOWER PRIOR TO HOLD SHORT
- o TAKE-OFF: CRUISE FORM, SQWK \_\_\_\_\_
- o ROUTE: \_\_\_\_\_, AT \_\_\_\_\_ AUTO SWITCH \_\_\_\_\_, SQWK \_\_\_\_\_
- o SEQUENCE OF EVENTS: \_\_\_\_\_
- o TL: PROCEED TO \_\_\_\_\_ POS SWTCH \_\_\_\_\_, SQWK \_\_\_\_\_
- o LANDING SITE: \_\_\_\_\_ ROUTE: \_\_\_\_\_

## LANDING SITE EVALUATION (CH 17 NATOPS)

- o SEQUENCE OF APPROACHES: NORM, HS, LD, REPEAT (-LD)
- o RTB: POS SWTCH \_\_\_\_\_ TYPE LANDING \_\_\_\_\_
- o COORDINATING INSTRUCTIONS
  - EMERGENCIES
  - IIMC (CASE 1, CASE 2, CASE 3)
  - LOST CONTACT
  - DISORIENTATION PROCEDURES / MAGELLAN
  - DOWNED AIRCRAFT
  - ABORTS
  - WAVEOFFS (SCENARIO 1, SCENARIO 2, SCENARIO 3)

## ADMINISTRATION AND LOGISTICS

- FLIGHT DURATION: \_\_\_\_\_
- FUEL: MISSION \_\_\_\_\_, GO-NO-GO \_\_\_\_\_, BINGO \_\_\_\_\_ FROM \_\_\_\_ / \_\_\_\_ FROM

## OLF

## COMMAND AND SIGNAL

- CHAIN OF RESPONSIBILITY
- CALLSIGN
- COMMUNICATIONS
- TERMINOLOGY(TERMINATE/KNOCK-IT-OFF/HARD DECK)
- FREQUENCIES / NAVAIDS
- FREQUENCY CHANGES
- LOST COMMS
- ID AND RECOGNITION
- VISUAL SIGNALS



## CHAPTER SEVEN LOW-LEVEL FORMATION

### 700. INTRODUCTION

This chapter introduces the student to the fundamentals of low-level formation flying. The procedures and positions contained herein are intended to provide a foundation for low-level formation flying which will meet most mission requirements.

### 701. SECTION LOW-LEVEL FORMATION FLIGHT

#### 1. Tactical Formations

There are two basic tactical formations designed to increase Section Leader flexibility in controlling a flight - combat cruise and combat spread. Cruise principles utilizing radius of turn and altitude to maintain or regain position apply to these formations. Separation between aircraft is dependent on the threat. **In the training command we will utilize only the combat cruise position and separation will be approximately five rotors.**

#### 2. Combat Cruise

##### a. Description

- i. Combat cruise is designed to allow maximum flexibility, maneuverability, and time on station while retaining control and flight discipline. Fuel conservation is accomplished through use of radius of turn vice power adjustments to maintain position.
- ii. Combat cruise allows Wing to fly anywhere on an arc from ten degrees forward of abeam on the left to ten degrees forward of abeam on the right. The optimum position is on the 45° bearing with four to five rotor diameters of lateral separation and level with Lead (See Figure 7-1).
- iii. During turns, Wing will maintain longitudinal clearance on Lead utilizing radius of turn. Upon rollout, wing will maintain optimum position to support lead.
- iv. Prolonged flight in the area within 30° of the tail (blind spot) should be avoided.

##### b. Common Errors and Safety Notes

- i. Both aircraft must navigate and provide mutual support.
- ii. Be particularly alert for the maneuvering of Lead during tactical navigation with emphasis on turns by Lead towards Wing. It is the navigator's (PNAC) responsibility to keep Wing's PAC apprised of sharp route turning points which might cause conflict between aircraft. Good CRM will enhance proper

anticipation, and use of radius of turn by Wing to maintain proper position. Wing should avoid flying forward of the 45° bearing as the flight approaches an impending turn.

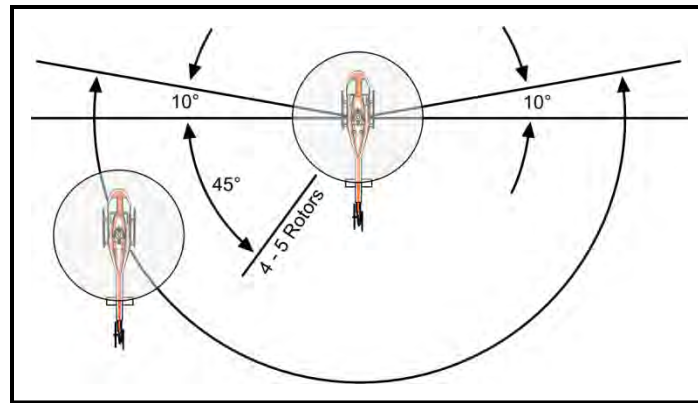

**Figure 7-1 Combat Cruise**

### 3. Formation Maneuvering

The combat cruise formation increases the flight leader's flexibility in controlling the flight and promotes security by providing overlapping fields of view. Section Low-Level Formation Flight is an extremely dynamic environment, which requires a thorough understanding of the radius of turn/cruise turn principles introduced earlier in this instruction.

### 4. Section Low-Level Navigation

The skills required for successful Section Low-Level Navigation are outlined within P-458, Flight Training Instruction, Instrument and Navigation Helicopter Advanced Phase, TH-57.

### 5. Wingman's Responsibilities

During Section Low-Level Navigation, the wing aircraft is not only responsible to remain in position and support lead, but also to provide a backup for route navigation and aid in clearing the flight of any potential threats or hazards.

### 6. Procedures

PAC of the wing aircraft is responsible to maneuver the aircraft in such a manner as to best support lead. This is done by applying the radius of turn and cruise turn principles learned earlier in training.

PNAC of the wing aircraft is responsible for secondary navigation for the section. Additionally, the PNAC should provide the flying pilot with those items of critical information necessary for mission success. In the training arena, this would include information which would allow the

## 7-2 LOW-LEVEL FORMATION

flying pilot to successfully maneuver about Lead's axis, always remaining in a supporting position. This information may include:

- a. Checkpoint identification.
- b. Direction and severity of the next turn allowing the flying pilot to anticipate the actions necessary to remain in a good supporting position.
- c. Rollout information provided as a clock code allowing the flying pilot to maintain an external scan during high AOB turns.

**THIS PAGE INTENTIONALLY LEFT BLANK**

## CHAPTER EIGHT NIGHT VISION DEVICES & NIGHT TACTICS

### 800. INTRODUCTION

#### 1. The Night Environment

Welcome to the Night Vision Goggles (NVG) environment. NVG systems operate in the optical radiation portion of the electromagnetic spectrum. Other portions of the electromagnetic spectrum react differently to the environment than visible light does. The lack of understanding of the night environment and its impact on NVG performance can potentially result in an unsuccessful mission or an NVG related mishap. In the past, several NVG related mishaps have demonstrated a lack of aircrew knowledge regarding the fundamental capabilities and limitations of NVGs. This chapter will address how the night environment influences NVG performance.

In order to understand the impact of the night environment on NVG performance, aircrew must understand the energy available in the night sky and its relationship to the eye and electro-optical systems. Just as a radio must be tuned to receive specific frequencies, NVGs and the human eye possess selective sensitivity to different wavelength or frequency ranges on the Electro Magnetic (EM) spectrum. These wavelength or frequency bands are inherently similar in nature and can best be related or described by their position on the EM spectrum. The optical band covered by visible light is a relatively small portion of the entire EM spectrum.

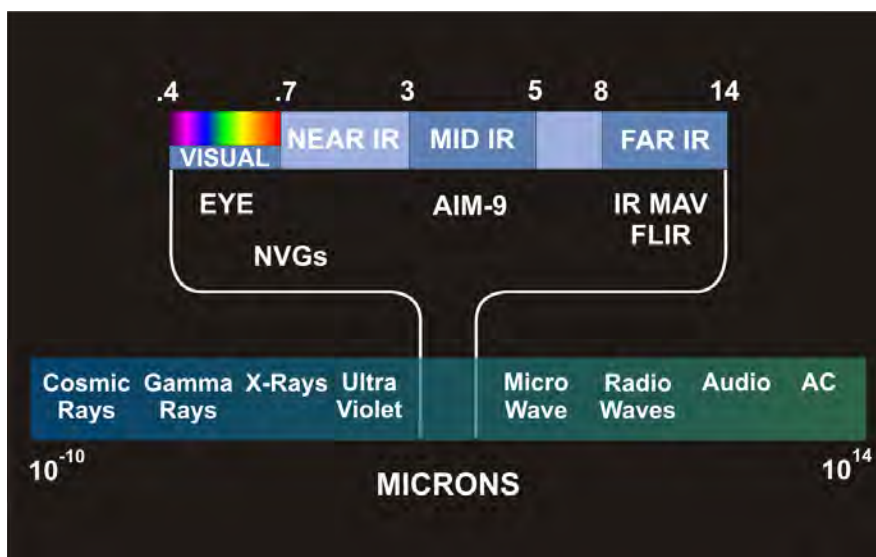

Figure 8-1 EM Spectrum

#### 2. Reflected vs. Radiant Energy

Energy is constantly being radiated or reflected by all of the objects in view of aircrew. Below three microns, the background is dominated by reflected and scattered solar or lunar radiation. NVGs operate in this portion of the spectrum, both in the visible and near infrared (IR). Since reflection dominates the portion of the spectrum that NVGs occupy, they are dependent entirely

on some sort of external illumination to view the scene. This illumination can come from the moon, stars, cultural (city) lighting, and, in some cases, even the sun. For example, when a scene is illuminated by an external source such as the moon, the scene is observed primarily by reflected energy. Reflected light (luminance) is normally expressed in terms of foot-lamberts (ft-L), while the amount of light generated from a source (illuminance) is expressed in terms of the unit lux or lumens per square meter ( $\text{lm}/\text{m}^2$ ).

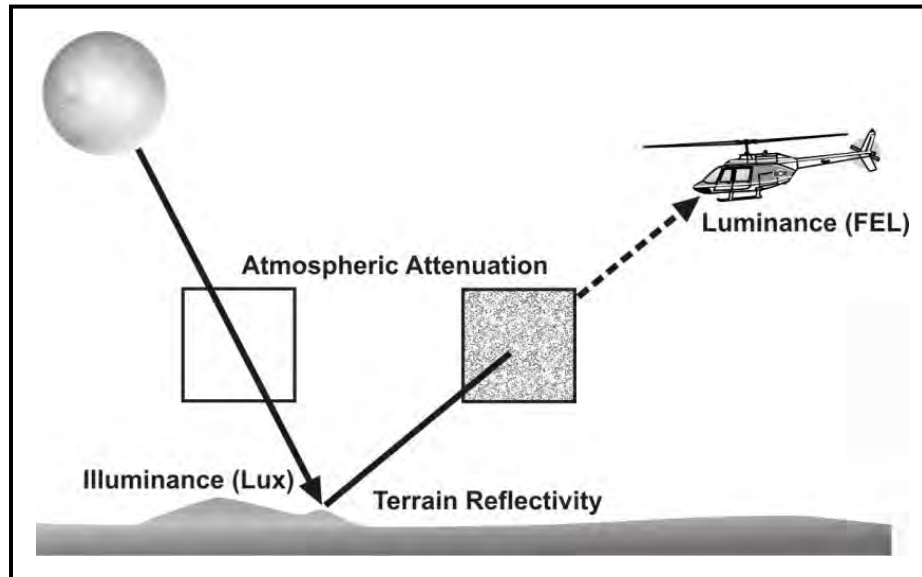

Figure 8-2 Illuminance and Luminance

### 3. NVG Performance Factors

*The three primary factors that influence NVG performance are illumination, terrain contrast, and atmospheric conditions.* Understanding how these factors impact NVG performance will improve mission planning and execution.

#### **Illumination**

Illumination is a critical factor for NVG operations. Illumination for night operations can come from both natural and artificial sources and is typically expressed using lux or lumen/meter<sup>2</sup> units.

- a. Lunar Illumination. The moon is usually the primary source of natural illumination for NVG operations. The moon reflects about seven percent of the sunlight that strikes it. The amount of light the moon provides is highly variable and influenced by the following four factors.
  - i. Moon phase (lunar cycle). The primary lunar illumination factor is lunar cycle or phase (e.g., new, full, quarter, etc.). Each moon phase provides different levels of illumination. A lunar month is approximately 29.5 days. Moon phases are influenced by the time of year and global position (latitude and longitude).

- ii. Moon angle. Moon angle, elevation, or altitude in relation to the horizon is the second most significant factor affecting lunar illumination. The moon is at its brightest when it is directly overhead and provides less illumination as it rises or sets. Many people will look at a low angle full moon and assume high illumination, however, a quarter moon high overhead can actually be brighter. Moon altitude is also important because of the phenomenon known as terrain shadowing which will be discussed later.
  - iii. Lunar albedo. A difference in the albedo (reflectance) of the illuminated portions of the moon surface during the lunar cycle is the third factor. For example, the moon is about 20% brighter during the first quarter (waxing) than the third quarter (waning) due to differences in the lunar surface.
  - iv. Earth-Moon distance. The final and least significant factor is the variation in the earth-moon distance due to the elliptical nature of the lunar orbit around the earth. The changes in illumination resulting from this 26% change in distance are deemed insignificant for NVG purposes.
- b. Night Sky Illumination. Moonless nights also have significant usable light for NVG operations. This is due to the large near-IR composition of night sky illumination. This night sky near-IR energy matches the peak sensitivity of the AN/AVS-9 NVG. On a moonless night, about 40% of the light is provided by emissions from atoms and molecules in the upper atmosphere known as air glow. Starlight is the other significant light source and provides about 0.00022 lux (about one tenth the level of a quarter moon).
- c. Solar Influence. Depending upon the azimuth and relationship to the flight path, the sun can provide adequate light (sky glow) for NVG operations until after nautical twilight (7-12 degrees below the horizon). Civil twilight (0-6 degrees below) is too bright, and astronomical twilight (13-18 degrees below) is too dark for NVG operations (considering only the contribution of the sun). Although the sun may provide helpful illumination if aircrew are flying away from it, a sun that is well below the horizon can continue to be a significant nuisance if flying toward it, especially in mountainous terrain. This is because of potential activation of the NVG's automatic gain circuitry (Bright Source Protection (BSP)). For NVG aided operations, aircrew should plan for NVGs to be most effective following the end of evening nautical twilight or when the sun has set more than 12 degrees below the horizon (roughly 45 to 60 minutes after sunset, depending on latitude).

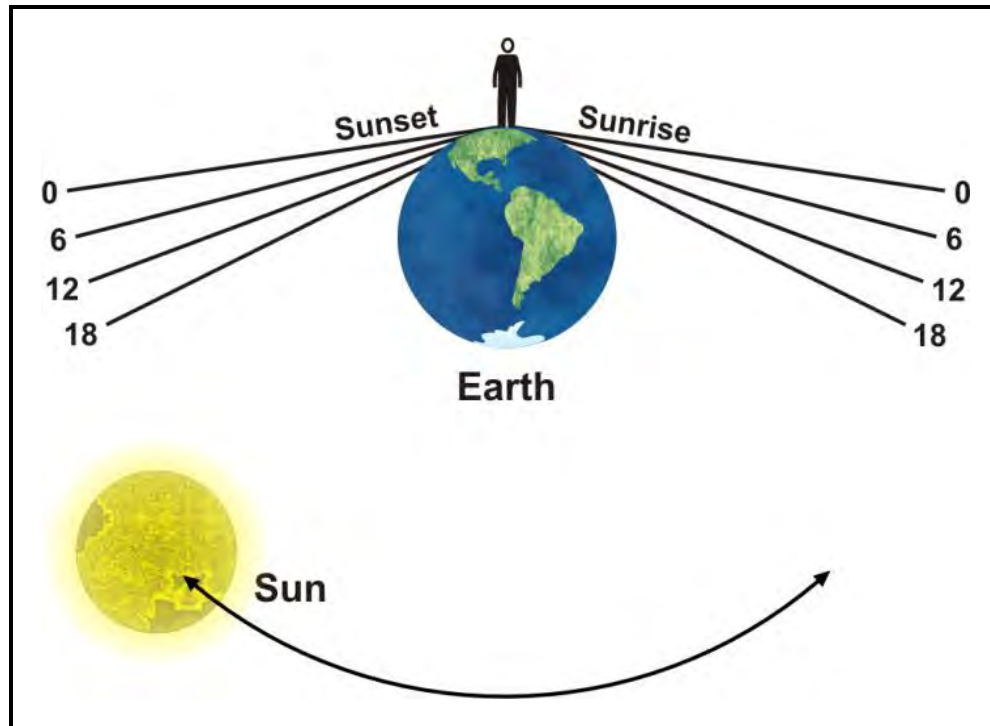

**Figure 8-3 Twilight Levels**

d. Artificial Illumination.

Artificial illumination sources (e.g., cultural lighting, vehicles, weapons, flares, etc.) can provide illumination for NVG operations. As with the sun, these artificial illumination sources can be helpful or hazardous depending upon the relative placement in or out of the NVG field of view (FOV). As with a low moon angle or the setting/rising sun, a potential exists for the NVG automatic gain control system (BSP) to be activated, causing the NVGs to bloom or shutdown.

### **NVG Terrain Considerations**

Terrain considerations must be understood when discussing NVG performance. There are three primary terrain factors that need to be examined for proper NVG mission planning:

- a. Terrain albedo (reflectivity) will greatly influence the overall scene luminance available for NVG operations. Surfaces such as snow will reflect more light than surfaces like asphalt or dark rock and therefore will appear lighter in the NVG image. The ability to see terrain features with NVGs is solely a function of the amount of light reflected by the terrain.
- b. Terrain contrast is a measure of the difference between the albedos of two or more surfaces. The greater the difference in contrast, the easier it is to see terrain or objects.



- c. Terrain shadows form at night just as they do during the day. Anything blocking moonlight will create a shadow. This can include terrain, cultural objects and even aircraft. One big difference between day and night shadows is the amount of energy present inside the shadow. During the day, the human eye can see into shadows due to the large amount of energy still inside the shadow while at night there is much less energy available. However, shadows may also provide benefits such as helping to discern terrain features while flying over low contrast terrain like sand dunes.

### **Atmospheric Conditions**

The atmosphere is the most important environmental factor controlling the performance of NVGs. The atmosphere can attenuate light energy, reducing the level of energy reaching the NVGs.

- a. Atmospheric water vapor (humidity) is the most influential absorbing gas, and certainly the most variable. Local humidity conditions can easily double the water vapor content in a matter of hours such as seen with a changing weather front. Humidity effects on NVG performance vary with particle size and density. Because of the properties of near IR light, the NVGs have the ability to “see through” light fog and thin clouds where unaided vision cannot. However, the quality of the NVG image, just like in unaided vision, becomes worse as humidity levels increase.
- b. Scattering is a phenomenon that occurs when light strikes a particle and changes its path. This scattering energy causes attenuation of the signal. The effects of scattering can be significant in an environment full of dust or smoke causing an appreciable loss in NVG performance.

#### **4. Solar/Lunar Almanac Prediction (SLAP) Program**

The Solar / Lunar Almanac Predictions (SLAP) application produces monthly or daily summaries of ephemeral data for the sun, moon, and evening sky. These summaries include times for sunrise/sunset, moonrise/moonset, beginning/ending of civil/nautical twilights, total daylight; daily illuminance; phase of the moon; time and altitude of sun/moon meridian passage; and 24 hour solar/lunar positions (altitude and azimuth). The SLAP application is available online at:

NIPRNET: <https://oceanography.navy.mil/gfmpl/>

SIPERNET: <https://oceanography.navy.smil.mil/gfmpl/gfmpl.jsp>

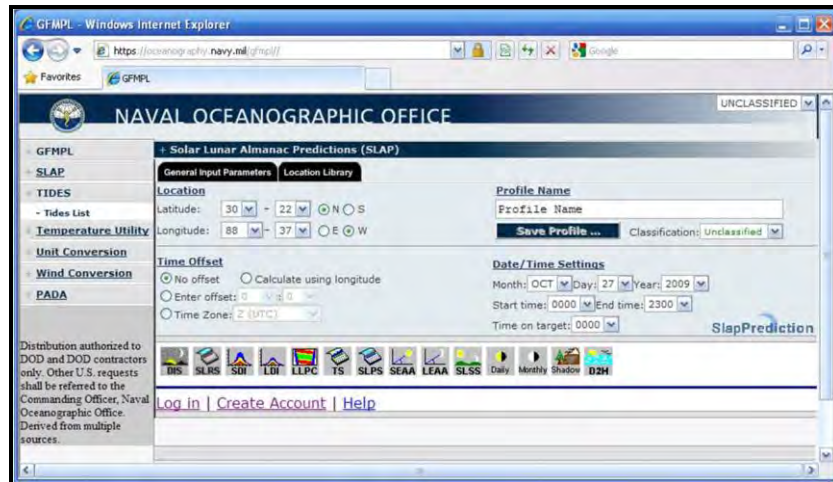

**Figure 8-4 Online Interface for the SLAP Application (Version 1.5)**

Figure 8-4 shows the SLAP application online interface. The primary products and tools can be accessed by simply selecting the desired option via the icon based menu. Prior to using the tools or generating SLAP products, users need to enter the location of interest, time offset, and date/time settings. Keep in mind the boundary between High Light Level (HLL) and Low Light Level (LLL) is 0.0022 lux. The two products utilized in the Advanced Helicopter Training Syllabus are the LDI and LEAA charts, described below:

- a. Lunar Daily Illumination Graph (LDI). The Lunar Daily Illumination Graph displays lunar illuminance (lux) vs. time for a 24-hour period, Figure 8-5. After the start time and date are selected, the LDI icon is selected. Moon phase, peak illuminance, and four values of illuminance are displayed: (a) Clear to scattered clouds (100% illuminance), (b) Partly Cloudy (50% illuminance), (c) Mostly Cloudy (33% illuminance), and (d) Dark Overcast (10% illuminance). As the cursor is moved in the graph area, the lux and time values are displayed in the status bar.

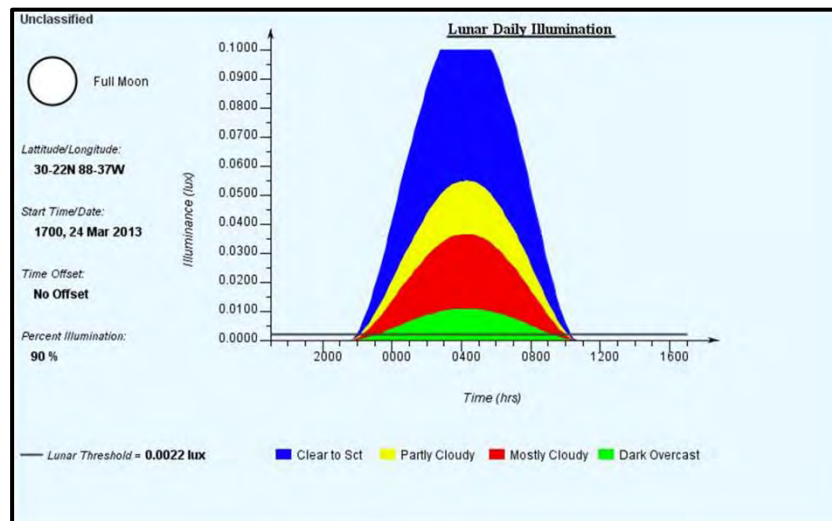

**Figure 8-5 Lunar Daily Illuminance Graph**

- b. Lunar Elevation/Azimuth Angles (LEAA). The LEAA graph displays the lunar angles for the period of time specified in the Date/Time Dialog, Figure 8-6. The values written adjacent to each arrow represent the time, angle, and illumination level for the given location (i.e., 2300/33.6°/ 0.021 Lux means at 2300 the moon will be 33.6° above the horizon with a 0.021 Lux illumination level). If the arrows are displayed close together, the text may become cluttered. If this is the case, use the mouse to drag the text to a new location. Another way to limit the clutter of the text in this slide is to limit the start time and end time values in the Date/Time dialog box. Limiting this to a six hour period will result in only six values displayed in the LEAA chart, which greatly improves readability.

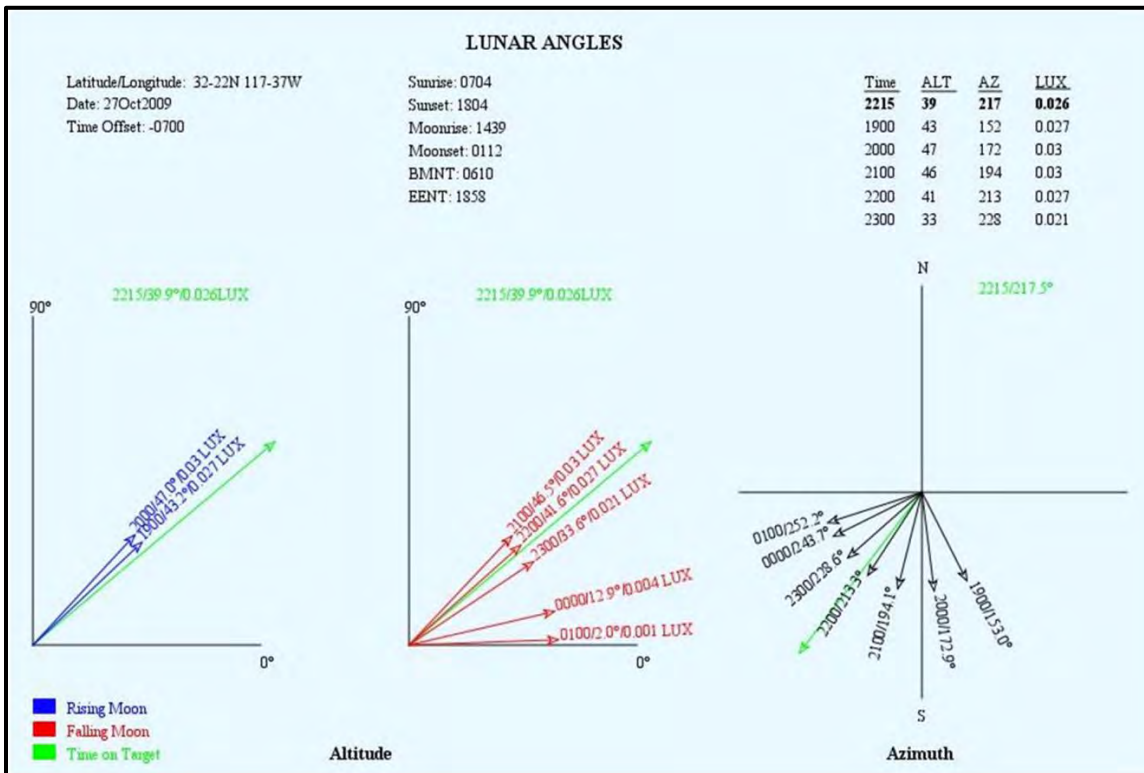

Figure 8-6 SLAP Application Lunar Elevation/Azimuth Chart Output Display

801. NIGHT VISION GOGGLES

NVGs are passive sensors that utilize image intensifier tube technology. An image intensifier tube is an electronic device amplifying available atmospheric illumination or light (e.g., moon, stars, sun, cultural lighting, etc.). NVGs rely upon the illumination reflected off the terrain or a target to form an image presented to the aircrew as a green monochromatic representation of the world. NVGs operate using the same principles as the human eye (reflected energy), with the following two exceptions:

NVGs are exponentially more sensitive to illumination than the human eye.

NVGs are sensitive to a different portion of the electromagnetic spectrum than the human eye.

This systems-oriented section will provide a brief overview of the components of the AN/AVS9R NVG.

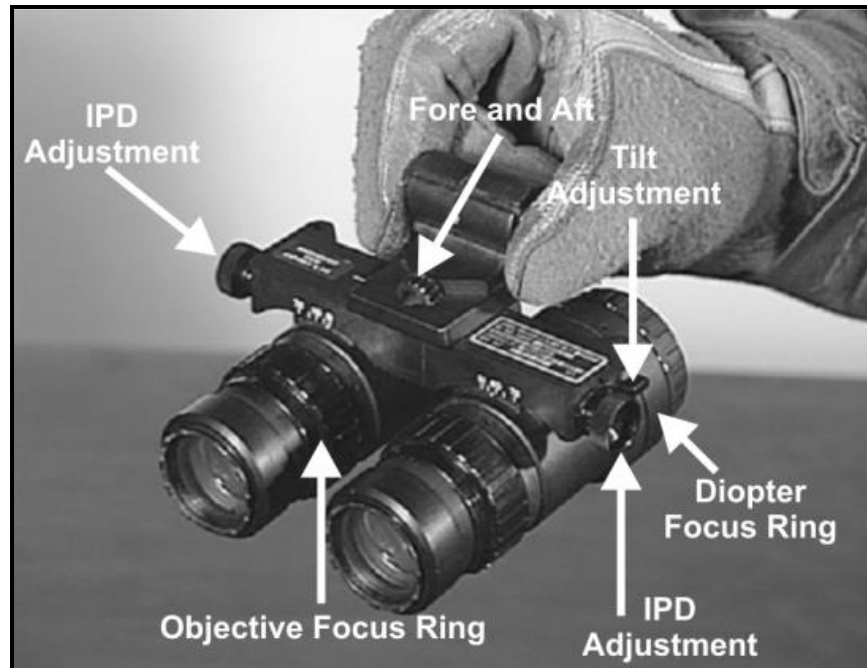
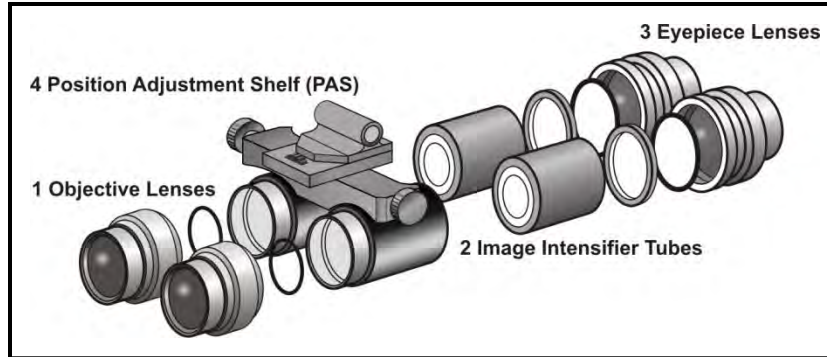

**Figure 8-7 AN/AVS-9R NVG**

## 1. AN/AVS-9 Binocular Assembly

### a. Objective Lens

The first optical component of the NVG is the objective lens. The lens is actually a combination of optical elements that function to focus the incoming rays of light onto the Image Intensifier ( $I^2$ ) tube. The AN/AVS-9R objective lens possesses variable focus with a focal range spanning from 41 cm to beyond optical infinity (150 feet). These shorter focal distances allow for NVG use in weapons systems trainers or simulators. Although the objective lens possesses a large range of focus, the depth of field dramatically decreases at short distances. Therefore, as aircrew optimize the NVGs for flight (optical infinity) and glance inside the aircraft looking through the NVG or view objects a short distance away, the objects will appear out of focus. NVG “minus blue” objective lens filtering facilitates aircraft cockpit and display compatibility by restricting wavelengths of energy entering the intensification process. This allows the use of cockpit lighting that will not adversely affect NVG gain and ultimately NVG image quality. This objective lens characteristic can be readily observed by looking at the AN/AVS-9R objective lenses. The objective lenses appear blue. This results from the lens filtering that “rejects” energy with a wavelength less than 665 nm. This “rejected” energy appears blue to the unaided eye.



**Figure 8-8 Binocular Assembly**

**b. Image Intensifier ( $I^2$ ) Tube Components**

GEN 3  $I^2$  tubes possess three primary internal components:

- i. **Photocathode.** The photocathode is responsible for converting the incoming visible and near IR energy into electrical energy in the form of electrons. Since the sensitivity of the photocathode extends into the near IR, it is able to detect energy in that region which is invisible to the human eye. The Gallium Arsenide (GaAs) photocathode in the third generation tubes has a peak sensitivity from approximately 600-900nm (0.6-0.9 micron range). This is significant since the night sky spectral irradiance is 5 to 7 times greater in the region of 800-900nm than in the visible region near 500nm. As a result the third generation tube is far more sensitive in the region where near infrared light from the night sky is plentiful.
- ii. **Microchannel Plate (MCP).** Electrons exiting the photocathode are channeled next through the MCP (Figure 8-9). The MCP is a very thin (1 mm) wafer comprised of millions of tiny glass tubes or channels, and is located between the photocathode and the phosphor screen. The inside passages of the MCP tubes are coated with a material that causes secondary electron emissions when a passing electron strikes them. The tiny glass tubes are tilted, at an approximate five degree bias angle, to ensure a first electron impact near the channel entrance. As each electron strikes a wall, more electrons are emitted from the wall, each of which will in turn strike the wall again, creating a cascading electron multiplier effect. Because of this process, for each electron that enters the MCP, 1000 or more will exit. The MCP is coated with an aluminum oxide film, this film is transparent to electrons but not ions. End of service life for a photocathode is primarily caused by positive ion contamination. The only repercussion is a voltage increase between the photocathode and the MCP. This in turn requires increased spacing between the two components to prevent arcing. This spacing causes an increased halo when viewing bright light sources.

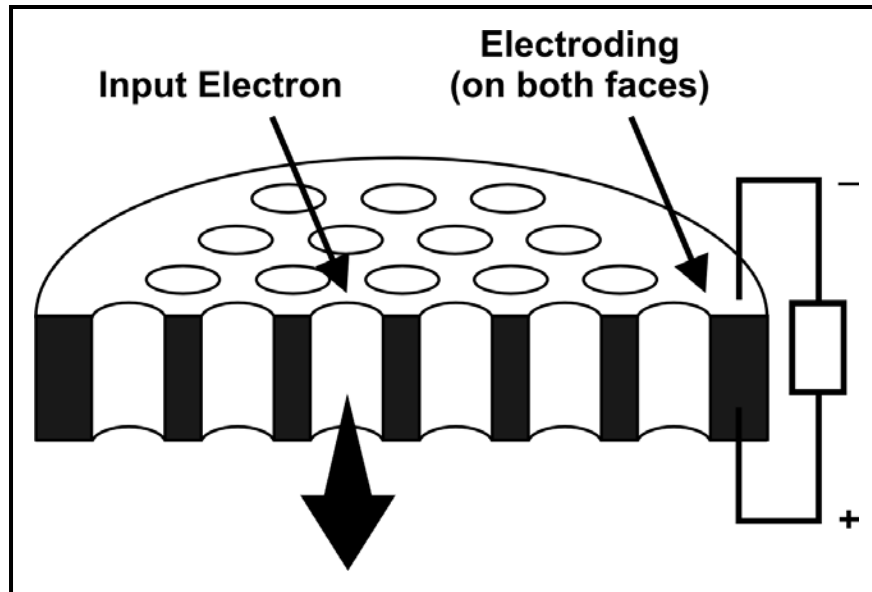

Figure 8-9 MCP

- iii. Phosphor Screen. Electrons exiting the MCP are in turn accelerated forward, maintaining their relative spatial position, until they strike and excite the phosphor screen (Figure 8-10). The phosphor screen is comprised of a very thin layer of phosphor deposited on the inside of the rear window (fiber optic). The basic function of the phosphor screen is to convert the electron beam energy to light. The screen is charged with a positive potential of several thousand volts with respect to the MCP to accelerate and attract the negatively charged electrons exiting the MCP. Phosphors emit light when electrons strike them and the output light wavelength is a function of the type of phosphor used. The AN/AVS-9R uses P43 phosphor with a spectral output that closely matches the peak sensitivity of the human eye.

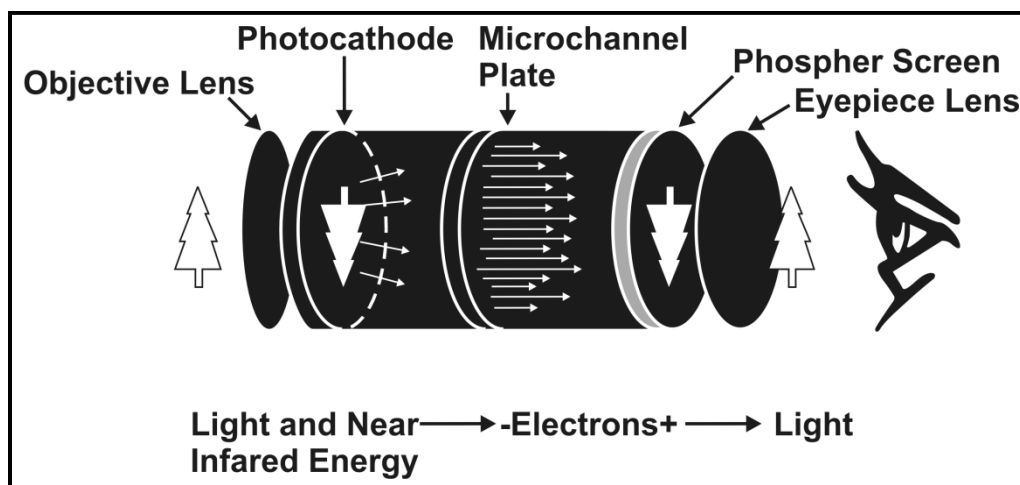

Figure 8-10 Phosphor Screen

**WARNING**

Take caution when handling NVGs. The phosphor screen material is very toxic. If there is serious damage to the NVG housing frame, it may allow toxic phosphor screen material to escape. Do not inhale or touch this material.

- iv. **Fiber Optic Inverter.** Image inversion is accomplished by attaching the phosphor screen to a fiber optic inverter. This inverter is actually a bundle of millions of microscopic light-transmitting fibers that are heated and given a 180° twist providing the needed inversion to produce an upright image without requiring a second lens assembly. The fiber optic inverter also collimates the image, making the image at the eyepiece lens appear to be at the appropriate distance from the viewer.
- c. **AN/AVS-9 Eyepiece/Diopter Assembly**

**Eyepiece Lens.** The eyepiece lens is the final optical component of the AN/AVS-9R NVG. As with the objective lens, the eyepiece lens is a series of optical components. The function of the eyepiece lens is to focus the light from the phosphor screen and fiber optic inverter onto the eye. The diopter adjustment for this lens allows wearers to move the focus point to the appropriate location at the back of the retina. The diopter lens will allow for mild vision corrections, however all students who require vision correction for flight shall wear corrective lenses during aided flight.

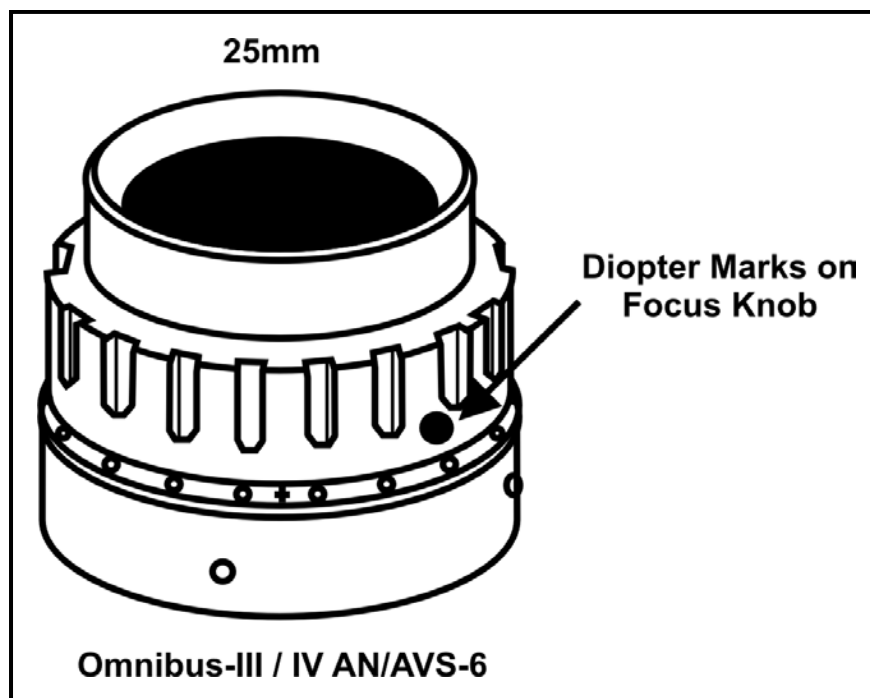

**Figure 8-11 Diopter Adjustment**

d. **Image Intensifier Tube Automatic Gain Control System**

The primary function of NVGs is to amplify the photons of light entering into the system. The amount that the input photons are amplified is called gain. Essentially, gain will govern the NVG image brightness for low light level (LLL) inputs. Constant exposure of the image intensifier tube to bright light sources may result in damage to the photocathode or the MCP. ***Therefore, NVGs should never be exposed to bright light.*** To prevent damage to the I<sup>2</sup> tubes, the power supply has been designed with two automatic protection features designed to control the gain of the I<sup>2</sup> tube, extend NVG service life, and have a direct effect on the performance and resolution of the NVGs.

- i. Automatic Brightness Control (ABC) Circuit. The ABC circuitry automatically adjusts MCP voltage to maintain NVG image brightness at a preset output for a wide range of illumination levels by controlling the number of electrons that exit the MCP. This function causes the NVG to “gain up” or “gain down” according to the light level. Therefore, the benefit derived from high gain intensifier tubes is realized only at low illumination levels since above a certain illumination level, the ABC holds image brightness constant. Tube gain increases from full moon down to star light illumination. As light levels pass below star light, further decreases in illumination do not result in an increase in I<sup>2</sup> tube gain. Therefore, the NVG image starts to decrease in brightness and contrast while NVG image scintillation becomes visible. The ABC circuit also provides a protective function to aircrew by limiting the effect of sudden bright flashes (e.g., forward firing munitions, etc.).
- ii. Bright Source Protection (BSP). Image intensifier tube exposure to bright light sources, left unchecked, could result in damage to the photocathode, the MCP and the eye. The BSP circuit limits the number of electrons leaving the Photocathode by reducing the voltage between the photocathode and the input side of the MCP. The BSP circuit actually starts to take effect at fairly low light levels and has an increasing effect until the voltage drops to the point needed to ensure that electrons can penetrate the MCP ion barrier film. Aircrew will notice activation of the BSP when an incompatible light source enters the NVG field of view and the I<sup>2</sup> tube significantly “degains” leading to reduced NVG image contrast and detail.



## 2. Accessories

### a. Quick Don Lock Mount

The mount possesses the vertical adjustment control, the lock release button, and the low battery indicator. The low battery LED indicator located on the bottom of the mount will illuminate when battery voltage drops below 2.2 volts, signaling the user that remaining battery life is low. In addition the Quick Don Mount allows the binocular assembly to break away from the helmet during a crash at loads of 10-15G's.

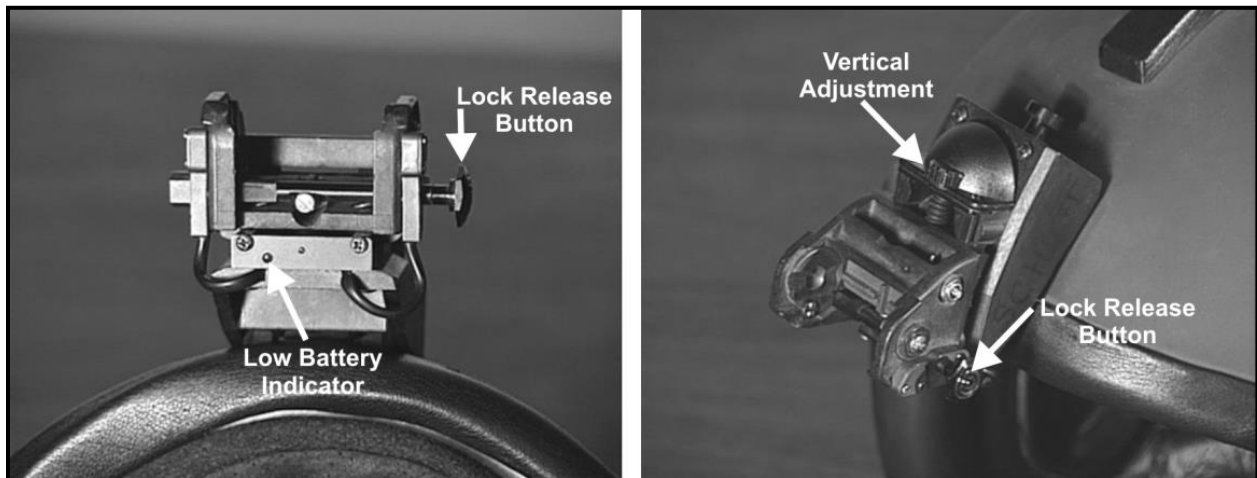

Figure 8-12 NVG Mount

Controls and Indicators	Function
<b>Power Switch</b> (ON/OFF/ON)	<b>ON:</b> binocular on – power drawn from battery compartment to which switch points <b>OFF:</b> binocular off
<b>Objective Focus Rings</b> (28 cm to Optical Infinity)	Focuses the objective lenses. Adjust sharpest view of scene. Travel for the objective lens focus ring is 1/3 turn.
<b>Eyepiece Diopter Adjustment Rings</b> (+2 to -6 Diopters)	Adjusts the intensified image from the I <sup>2</sup> tube back to the retina and can compensate for refractive errors but not for astigmatism. <b>Movement of the fore-and aft adjustment requires readjustment of the eyepiece lens focus ring.</b>
<b>Eye-span (IPD) Adjustment Knob</b> (51 to 72 mm)	Adjusts for operator eye span or interpupillary distance (IPD). <b>Dual IPD PAS:</b> Independent control of each monocular.
<b>Fore-and-Aft Adjustment Knob (Eye Relief)</b> (25 mm)	Adjustment for optimum field of view. Turn the knob to obtain a full view of the intensified image. Adjust fore-and-aft to maximize the field of view, yet maintain your peripheral view and “look under” capability.
<b>Vertical Adjustment Knob</b> (16 mm Total Travel)	Moves the binocular up or down. Center the eyepieces in front of the eyes.
<b>Tilt Lever</b> (8 to 10° Total Travel)	Allows the binocular to be tilted up or down. Moves the lever to obtain the optimum line-of-sight viewing. Should be parallel to the PAS if possible.
<b>Lock-Release Button</b>	Press the lock-release button to rotate the binocular from the stowed position to down and ready for flight position.
<b>Low-Battery Indicator</b> (Steady or Flashes)	When illuminated, it indicates a low battery condition with approximately 2.2 volts of power remaining.

Figure 8-13 NVG Control Functions

### 3. NVG Power Sources

There are currently two types of power sources used with the AN/AVS-9R: the Low Profile Battery Pack (LPBP) and the Clip On Power Supply. The LPBP contains a primary and redundant power source and a three-position switch. It will only accept AA alkaline batteries, and comes with a hard mounting bracket. The Clip On Power Supply is designed for hand held use of the NVGs.



**Figure 8-14 NVG Battery Packs**

### 4. Battery Considerations

The AN/AVS-9R is powered by two 1.5-volt AA alkaline batteries. The service life of each battery will be affected by environmental temperature.

Alkaline AA battery performance demonstrated no drop-off in image brightness and quality for several hours (five - ten hours) following activation of the low battery indicator (2.2 volts). It is recommended aircrew fly the AN/AVS-9R with one set of new alkaline batteries installed on the backup side of the battery pack (alternate) with an older set of batteries (non-expired, greater than 2.2 volts batteries) placed on the power-on side of the battery pack (primary).

### 5. NVG Helmet

- a. **Helmet Fitting Procedures.** A proper fit is critical for comfort, reduced neck fatigue and keeping the NVG image in the correct position during maneuvering. If helmet fit is not optimal or loose after mounting NVGs see the paraloft for adjustments to liners and nape strap/chin strap. Counterweights are also available that attach directly to the LPBP and balance the forward weight of the NVGs.

- b. **Helmet Mount.** The goggles are attached to the helmet on the helmet plate (bracket). The bracket is hand tooled during manufacture to ensure a proper connection with the NVGs. The NVG release lever on the mount assembly disengages a spring-loaded locking bar thereby enabling the goggles to be removed from the helmet with one hand.

### **WARNING**

Removal of the lanyard from the NVGs or twisting the lanyard around the upper part of the helmet is not authorized. The only authorized modification to the lanyard is the addition of velcro to the cord and helmet by gear issue per the NAVAIR instruction.

## **802. NVG CREW COORDINATION**

Survival in a threat environment as well as a training environment depends largely on how well a particular aircrew understands its portion of the mission and how they perform their specific crew functions. Crew coordination is more critical while operating on NVGs than in any other flight environment. Due to the limited peripheral vision, degraded depth perception, and the 40° FOV associated with NVGs, aircrew lookout doctrine must be briefed for all phases of the flight and strictly adhered to. Each member of the aircrew must understand and comply with the briefed goggle/de-goggle procedures and the NVG related emergency procedures. It is imperative the aircraft commander be advised any time a crewmember's night vision capability has been degraded. NVG specific crew responsibilities are as follows:

### **1. Pilot at the Controls**

The PAC is primarily responsible for avoiding obstacles and maintaining control of the aircraft. He should assist the non-flying pilot in navigation by calling recognizable terrain and man-made features. During the landing phase, he should keep all crewmembers apprised of references in the LZ and comply with briefed inadvertent IMC procedures during landing should those references be lost. The PAC primary emphasis and attention must be devoted outside the aircraft during NVG operations. The PAC should avoid distractions inside the aircraft and allow the PNAC to manipulate cockpit switchology and frequency changes.

### **2. Pilot Not at the Controls**

The PNAC is responsible for navigation, avoiding obstacles, and directing the pilot flying as required to keep the aircraft on course. He will also back up the pilot flying on altitude and airspeed along the route of flight. During the landing phase, he will assist by monitoring rate of closure and descent, altitude, and aircraft drift over the intended point of landing. He will make altitude calls from the RADALT to a prebriefed altitude. Should the aircraft encounter IMC or waveoff criteria during the landing transition, the PNAC will provide information regarding rate of climb, aircraft attitude, airspeed, altitude, and engine performance during the waveoff or until VMC. He should be prepared to assume control of the aircraft at any time. The non-flying

pilot's responsibilities also include all switchology not related to flight control input such as radios, lights, radar altimeter and navigation equipment.

### 803. SAFETY CONSIDERATIONS

During NVG flight, one's ability to effectively respond to an emergency may be delayed due to the reduced visual cues and accompanying physiological and psychological stressors. To overcome these limitations, the aircrew must be proficient in handling aircraft emergencies and systems failures in a darkened cockpit environment. When briefing, safety considerations may be divided into aircraft emergencies, NVG failures, inadvertent IMC, loss of SA, and aircrew coordination. In all cases, appropriate procedures should be tailored for the mission, ambient conditions, weather factors, terrain, and aircrew experience. Conducting a blindfold cockpit check prior to aided flight can greatly increase cockpit familiarization and, thus, decrease response time in an emergency.

#### Emergency and Safety Considerations

##### 1. Aircraft Emergencies

It is recommended that the PAC remain goggled and initiate required immediate action procedures. Terrain permitting, primary consideration should be given to landing the aircraft followed by the execution of remaining procedures on the deck. Where terrain prohibits this course of action and emergency procedures permit, it is advisable to "climb to cope" to gain reaction time, improve landing site selection, and increase overall SA. The PNAC should remain goggled to retain outside visual cues while simultaneously assisting the pilot at the controls as briefed or required.

##### 2. NVG Failures

NVGs are susceptible to malfunction. Battery failure, broken intensifier tubes, broken frames, or broken wires may occur at any time. The majority of NVG failures should be caught during proper preflight of the helmet and NVGs. The following steps shall be taken for NVG malfunctions:

- a. Communicate the failure to the crew. If the malfunction affects the PAC, immediately shift to an instrument scan and conduct a positive transfer of controls to the PNAC stating, *"I have a goggle failure, you have the controls.."*
  - i. If the PAC has a goggle failure on takeoff, he shall state, *"I have a goggle failure, you have the controls (simultaneously shifting to an instrument scan and executing an ITO profile)."*
  - ii. If the PAC has a goggle failure on final, he shall state, *"I have a goggle failure, you have the controls (simultaneously shifting to an instrument scan and initiating a wave-off)."*

- iii. If the PAC has a goggle failure en route/at altitude, he shall state, "I have a goggle failure, you have the controls." If the NVD malfunction cannot be corrected, the syllabus event shall be terminated and the aircraft shall return to South Whiting unaided. Flights shall not be conducted with one pilot aided and the other pilot unaided."
- b. If a battery failure has occurred, conduct a positive change of controls and attempt to regain the use of the NVG as follows:
  - i. Switch to backup battery or replace with spares.
  - ii. If NVGs are still not operational, replace them with spare NVGs.

#### NOTE

A minimum of one extra set of goggles should be carried on the aircraft as a replacement set for any that become inoperable. Sufficient extra batteries should also be carried by each individual crewmember. Due to limited assets and mission precedence, extra sets of NVGs are not carried during flights in the HT's.

### 3. Inadvertent IMC

The chances of entering inadvertent IMC are increased due to the goggle's ability to see through some atmospheric obscurants as well as its inability to detect others until it's too late. Therefore, the aircrew must be alert and recognize the following indicators to IMC:

- a. Increased "halo effect" around light sources. The halo size will increase as weather restrictions develop.
- b. Degraded NVG image. Gradual reduction in light levels, visual acuity, depth perception, or terrain contrast.
- c. Obscuration of the moon and stars. The less visible they are, the heavier the cloud cover. Additionally, shadows obscuring the moon's illumination are an indication that clouds are present. Shadows may be detected by observing the varying levels of ambient light along the route.
- d. Increased graininess or video noise. Video noise is similar to "snow" seen on televisions with poor reception. Should this occur, verify the condition with other crewmembers to distinguish weather restrictions from NVG malfunctions.
- e. Loss of ground lights. As visibility decreases and prior to entry into IMC, the PAC/flight leader should alter the course and/or altitude to maintain VMC. Landing

the aircraft/flight may be necessary until visibility improves. If inadvertent IMC cannot be avoided, execute the pre-briefed inadvertent IMC procedures. If IMC is encountered, the PAC must immediately advise the crew he has lost visual references to the ground and/or horizon, and immediately transition to an instrument scan. He should maintain his instrument scan until advised by the crew that VMC has been regained. The PNAC will back up the PAC by monitoring the instruments, ensuring pre-briefed procedures are followed, and scanning outside to regain VMC.

- f. Reflection of exterior aircraft lights off moisture in the air.

#### 4. Loss of Situational Awareness

To function in an NVG environment and deal with the constantly changing conditions, the crew must be able to keep up with what is going on around them. This process begins with preflight planning, continues with the briefing evolution, and is constantly updated in flight by all available means. Maintaining the proper level of SA to safely achieve mission success is largely dependent upon the crew's ability to coordinate and communicate as a team. The biggest threat to loss of SA by a crew is when the entire crew has their attention focused on one aspect of the flight. A faulty switch or an unidentified set of aircraft position lights can quickly preoccupy all crewmembers and distract them from their prebriefed responsibilities. Crews should be alert to this possibility and ensure a division of duties is maintained during all responses to unforeseen circumstances that may develop during the mission with priority given to aviating the aircraft.

### 804. NVG HUMAN FACTORS

NVG aided operations possess significant aeromedical concerns that must be considered during mission planning and mission execution. The first consideration is that NVGs do not allow you to assume a day VFR posture. Unlike looking through a pair of binoculars, NVGs do not provide direct viewing of an object. Even though vastly superior to night unaided vision, the NVG image is just an artificial TV screen representation of the real world and it does not provide a daylight quality image. NVGs should be treated as a very reliable, very accurate instrument, but, as with all other instruments, they must be continually crosschecked with other aircraft systems and crewmembers to get an accurate assessment of the real world.

#### 1. Visual Performance

##### a. NVG Spatial Orientation

Visual sensory cues provide the strongest input to overall spatial orientation and SA. Daytime visual performance is the standard by which we compare NVG performance. By virtue of NVG design limitations (e.g., FOV, lack of color discrimination, visual acuity, etc.), operationally significant misperceptions and visual illusions can occur during NVG-aided operations. Maintaining spatial orientation at night requires complex and conscious processing of data from various instruments and displays. In fact, the most common contributing factors in spatial disorientation mishaps include degraded visual environment, high task loading/saturation, fatigue, and a breakdown

in scan. Constant vigilance and a good scan pattern, both inside and outside the cockpit, must be maintained to help prevent spatial disorientation and loss of SA.

b. **Field of View**

One of the most obvious limitations of all NVGs is the limited FOV. Compared to the human eye's normal FOV of approximately 180 degrees, the FOV reduction with NVG's to 40 degrees, which is a dramatic change and necessitates some compensation on the part of the aircrew. An active, aggressive scan is essential to overcome the reduced NVG FOV. Exclusive fixed forward viewing will increase the potential for loss of SA and reduces the ability to judge height and distance. Limitations on excessive flight maneuvering should also be considered during night operations using NVGs. NVG FOV can be less than the designed optimum if the

NVG eyepiece lenses are too far away from the eyes. Conversely, the eyes will be unnecessarily fatigued and look-under ability will be greatly reduced if the NVGs are brought in too close. This will translate into less ability to look around or under NVGs at maps, gauges or outside the cockpit.

c. **NVG Visual Acuity and Resolution**

Unlike normal vision, NVGs do not provide direct viewing of the scene. Instead, the electro-optical process within the NVG provides what amounts to a TV image. This monochromatic green electro-optical image is not without its visual limitations. In flight, the physical limitations of the NVG and the reduction in ability to recognize and detect objects, terrain, and targets must always be considered.

- i. Contrast. With NVGs, a reduction in contrast occurs as the eye is presented a monochromatic green image and color contrast cues are lost. NVG contrast is further reduced as ambient light levels decrease beyond the capability of the I<sup>2</sup> tube's ABC. Contrast will also be reduced when a bright light source, such as the moon or city lights enters the NVG FOV and the NVG begins to degain (BSP activation). Reduced contrast manifests itself primarily as reduced visual acuity since low contrast objects are more difficult to see than those that have high contrast. Additionally, individual differences in contrast sensitivity may exist between aircrew. This may translate into differences amongst crewmembers of the same flight in regard to what and when they can see it.
- ii. AN/AVS-9R misadjustments. Cockpit workload dictates that NVGs should be properly adjusted on the ground. Even for experienced aircrew, the most common adjustment errors involve interpupillary distance (IPD), eyepiece or diopter lens focus and objective lens focus adjustments.
- iii. Manufacturing defects. Minor discrepancies in tube alignment and tube images on a set of NVGs may cause headaches or double vision since the eye and nervous system are constantly attempting to fuse the two images into one.



There is a wide range of tolerance to misalignment and image differences. Disparities that go unnoticed by one individual may be intolerable to another.

**d. Additional Visual Cues**

- i. Depth perception. One common erroneous statement made by aircrews is how poor depth perception is with NVGs. In fact, depth perception is easily acquired using NVGs. However, the depth perception task is commonly confused with the more challenging distance estimation task. Whereas depth perception primarily determines the relationship of objects to each other, distance estimation relates to determining distance to an object.
- ii. Distance estimation. Distance estimation is significantly altered with NVGs and objects will appear farther away than they actually are. Care must be taken to maintain adequate separation from other aircraft or obstacles. Both depth perception and distance estimation are visual processes that usually are automatic and subconsciously processed by the visual system. The loss or degradation of these cues will not be recognized unless they are demonstrated or a conscious effort is made to remain aware of these limitations.
- iii. Optical flow. Optical flow is the angular rate and direction of movement of objects because of aircraft velocity measured relative to the aviator's eye. This provides the visual perception system the information necessary to interpret speed and direction of motion. If there is no relative motion, there is no optical flow. Since visual acuity is degraded with NVGs, the optical flow cues will be degraded when compared to daytime cues.
- iv. Peripheral vision. Peripheral vision motion, also known as motion parallax, is a subconscious method of detecting optical flow. It is dependent on a wide FOV and is the primary airspeed and altitude sensory input. With the significant reduction in FOV of NVGs, this cue is severely degraded and central vision tracking becomes the primary detection means. This leads to one of the most insidious dangers when flying low altitude profiles. Just as in the day, visual acuity will improve as the aircraft gets closer to the ground. However, because of the reduction in peripheral vision motion, the ensuing “speed rush” that would indicate close proximity to the ground is not available and controlled flight into terrain (CFIT) becomes a real possibility. The use of an aggressive scan will help “fill in the blanks”. During high cockpit workloads or periods of fatigue, scanning is one of the first tasks to be impacted. A dedicated effort must be made to avoid fixation and to maintain the scan necessary to provide this essential cue.

**e. Dark Adaptation**

The use of NVGs does not require complete dark adaptation, because the brightness of the NVG image will partially disable night vision. However, standard night flight

preparations (i.e., bright light avoidance, proper nutrition, rest, etc.) are still recommended in order to aid peripheral vision and vision while looking underneath the goggles. After removal of NVGs, approximately ten minutes is required to adapt to the unaided night environment.

f. **Unaided Peripheral Cueing**

It is well known that the sense of balance and perspective is largely due to peripheral cueing, while central cueing is responsible for fine detail and interpretation. The NVG and helmet system is designed so that there is considerable unaided peripheral viewing capability. What can be seen in the periphery depends on many variables: illumination level, terrain type, and artificial light sources.

g. **Post-Flight Visual Problems**

Some temporary visual changes can occur after NVG use. To date, there is no evidence of any permanent changes to vision, and experience indicates there are none. The reductions in contrast, resolution and FOV all contribute to visual fatigue. Improper adjustment of IPD will also contribute to eye fatigue and headaches.

## 2. **Fatigue**

Fatigue has always been a factor in night operations. There are three types of fatigue: (1) acute fatigue, (2) cumulative fatigue, and (3) circadian fatigue.

- a. Acute fatigue is short-term, characterized by a feeling of being “worn out,” and will usually be relieved by a single night’s rest.
- b. Cumulative fatigue is less intense than acute fatigue and is characterized as an accumulation of fatigue over time, usually days or even weeks. This can be the result of extended work weeks with little time off or failing to obtain adequate sleep. Cumulative fatigue is associated with a feeling of being “burned out.” It takes the body longer than one night’s rest to recover normal energy levels.
- c. Circadian fatigue. The human body and its physiological functions are strongly controlled by a biological clock. This biological clock, or circadian rhythm, describes the approximate 24-hour cycle or rhythm that drives many physiological body functions that are highly correlated with numerous human performance parameters.

## 3. **Effects of Fatigue**

One’s normal squadron routine combined with the workload of NVG missions creates acute fatigue on a daily basis. Shifting into a night training period causes circadian disruption. Add to this the layering effect of cumulative fatigue over time and it is clear that aircrew must understand how to deal with fatigue. Fatigue is difficult to recognize and fosters an

unwillingness to do anything about it. It subtly erodes performance by inducing complacency and poor decision making. It hinders one's ability to accomplish tasks in the cockpit, causes communication breakdowns and irritability. These qualities are detrimental to good crew coordination.

#### 4. Recommendations for Coping with Fatigue

There are means to reduce the impact of fatigue and thereby improve performance and increase safety. The following recommendations have been shown to reduce the effects of fatigue.

##### a. Aircrew Responsibilities

Whatever scheduling requirements the squadron utilizes, aircrews still have the ultimate responsibility of managing their off-duty time to prepare for each night training period. When night training periods extend over a weekend or day off, the aircrew should not abandon their night schedule entirely. In this way, the aircrew will maintain some type of circadian adaptation on days off.

##### b. Sleep Environment

Most families are oriented to a daytime schedule, therefore switching back and forth from a day to a night schedule can pose a strain. The family must understand the hazards associated with fatigue and help provide an atmosphere that lends itself to quality sleep.

##### c. Physical Conditioning

Good physical conditioning is important to ensure adequate sleep, but due to possible acute fatigue and dehydration, aircrew should not conduct a strenuous workout on the day of an NVG flight.

##### d. Caffeine/Alcohol

Aircrew should limit their caffeine intake to reduce its effects on the nervous system in flight and help improve the quality of sleep at home. Caffeine also has a dehydrating effect that can affect aircrew performance. Alcohol also dehydrates and influences the quality of sleep in addition to affecting the vestibular system.

##### e. Cancellation

If feeling tired or "burned out" prior to a flight, it is highly probable that the individual is fatigued and will experience degraded performance during the mission. This brings up one of the more important yet most difficult recommendations to implement – cancellation. For whatever reason, if an aviator honestly feels too fatigued to successfully accomplish the mission, he should not be a part of the flight.

## 5. Complacency/Overconfidence

*NVGs DO NOT TURN NIGHT INTO DAY.* However, after initial NVG flying experience and some flights in low illumination conditions, there is a natural tendency to be overly comfortable when flying in high illumination conditions.

Do not be lulled into a false sense of security that the NVGs will allow you to fly day VFR profiles without significant experience, increased performance demands, and good mission planning. There is an inherent tendency for the newcomer to anticipate too much from NVGs. Treat the NVG visual display with healthy disrespect and cross-check with other instruments to enhance SA through validation of the “true” attitude, altitude, and airspeed.

### 805. NVG PREFLIGHT

As with any system, the key to achieving the full operational capability of the NVG system is through proper preflight and follow-on postflight care. Ensuring the NVG is properly mounted and adjusted prior to each flight is essential to successful NVG-aided operations. Improper adjustment of goggles can result in not only degraded system performance, but also converging or diverging vision and neuromuscular (accommodative) eye fatigue. This section is dedicated to those procedures critical for NVG sensor optimization.

#### 1. NVG Adjustment and Assessment Procedures

##### Inspection and Initial Adjustment Procedures

- Step 1. Inspect Helmet. Inspection of the helmet should be the same as for unaided flight. However, particular attention should be paid to helmet fit due to the extra weight and forward center of gravity caused by the NVG and V-1B helmet mount. In addition, inspect the helmet NVG mounting bracket and ensure that it is free and clear of debris.
- Step 2. Inspect V-1B Quick Don Block Mount. Ensure the mount is not cracked and that all contacts are clear and clean, and check wiring for integrity. Test all controls for smooth operation.
- Step 3. Load Battery Pack and Mount to Helmet. Prior to inserting the batteries, make certain the power pack is turned off. Ensure the batteries are correctly inserted. Attach battery pack to helmet. Connect battery pack cable to helmet wiring harness tail by matching red dots located on each connector and applying finger tip pressure.
- Step 4. Inspect Binocular Assembly. Ensure there is no obvious damage to either monocular housing. The monocular housings are attached to the position adjustment shelf (PAS), which is constructed of a lightweight plastic material. Consequently, each monocular may move independently of the other, but the movement should not be excessive. Rotate the objective and eyepiece or diopter

focus controls to ensure freedom of movement. The diopter controls are naturally “sticky” in their travel due to a plastic-on-plastic design. However, if the controls are very difficult to turn, notify maintenance. In some instances, maintenance can simply release some of the nitrogen pressure and the controls will loosen. Test all other adjustment controls for free movement and smooth operation. In addition, ensure all adjustment knobs and levers are free from dust, dirt, and grime.

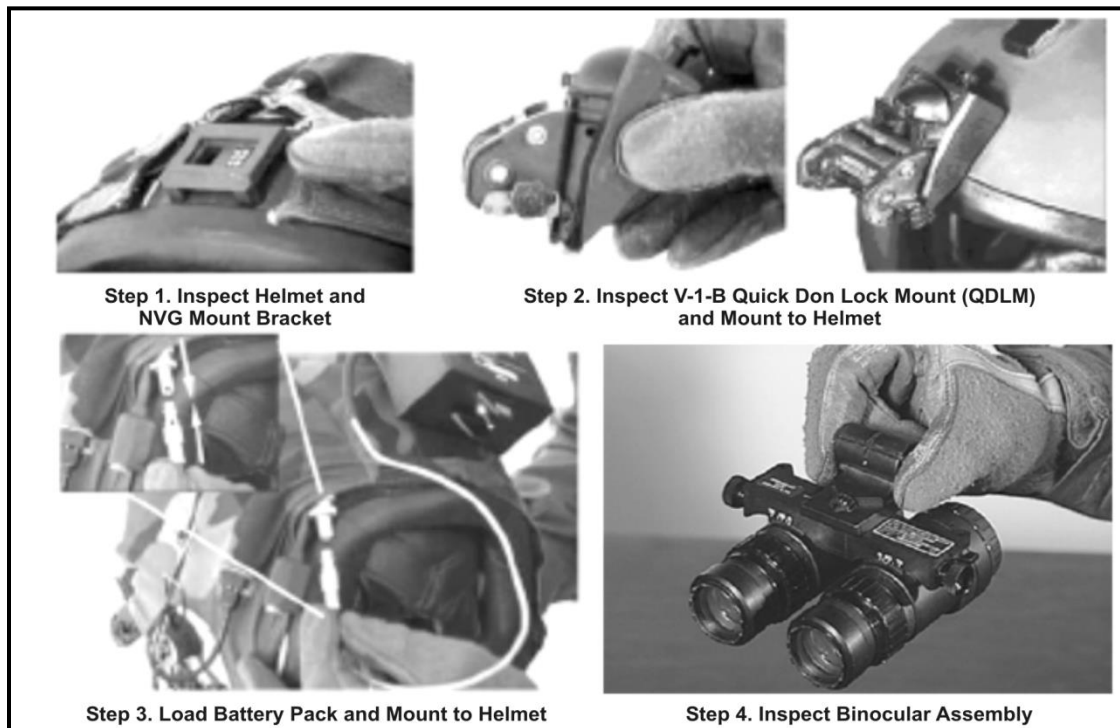

**Figure 8-15 NVG Inspection and Adjustment Procedures (Steps 1 through 4)**

- Step 5. Inspect Lenses. Inspect the objective and eyepiece lenses for smudges, debris, scratches, or other damage. Lenses shall only be cleaned by maintenance personnel. ***Do not clean lenses with flight suit, t-shirt, or other materials.*** USAF data has demonstrated that a single thumbprint on one of the lenses may degrade visual acuity by as much as 30 percent. If the lenses become smudged following preflight the lenses may be cleaned ***only*** using approved lens paper (provided in the NVG case).
- Step 6. Preset Eyepiece or Diopter Adjustment Ring. All aircrew requiring corrective lenses shall wear either contacts or glasses while using NVGs. While the convenience of contacts may be preferred by many, some aviators prefer glasses due to drying of the eyes caused by an increase in airflow when flying with NVGs without a visor. Initially, aircrew should set the diopter on each monocular to zero. This will help ensure the resolution chart will be initially viewable when beginning the focusing procedures.

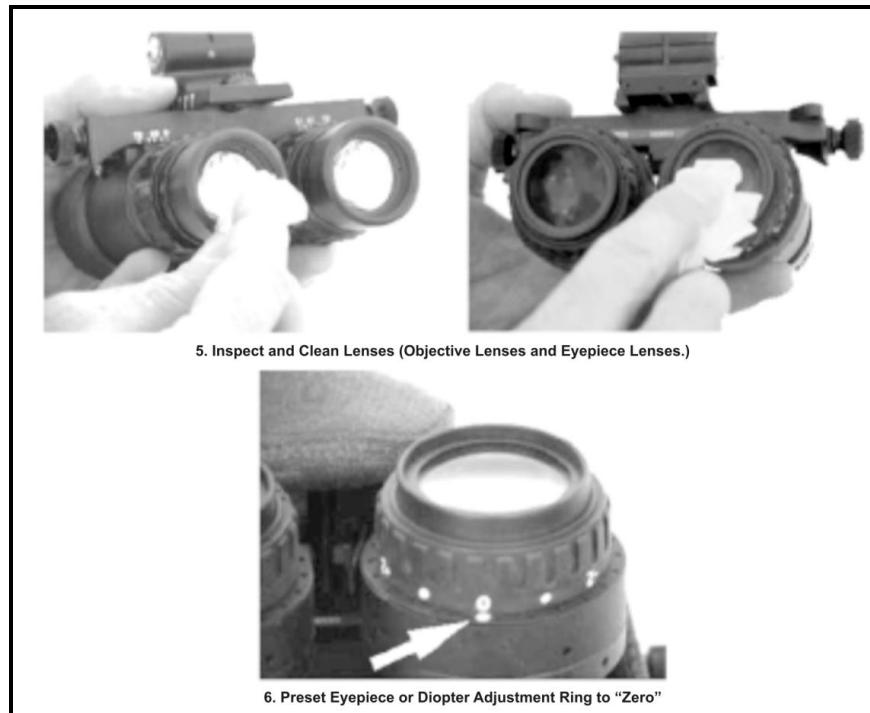

**Figure 8-16 NVG Inspection and Adjustment Procedures (Steps 5 and 6)**

- Step 7. Preset Fore-and-Aft or Eye Relief Adjustment. Eye relief is the distance between the NVG eyepiece lens and the eye. Eye relief adjustment is made with the fore-and-aft adjustment knob on the AN/AVS-9R. Initially, position the binocular assembly as far forward (away from the helmet mount) as possible. This will avoid damage to spectacles (as applicable) and placement of oil on the lens from eyebrows or eyelashes when the NVGs are initially attached to the mount and rotated into the down/locked (donned) operating position.

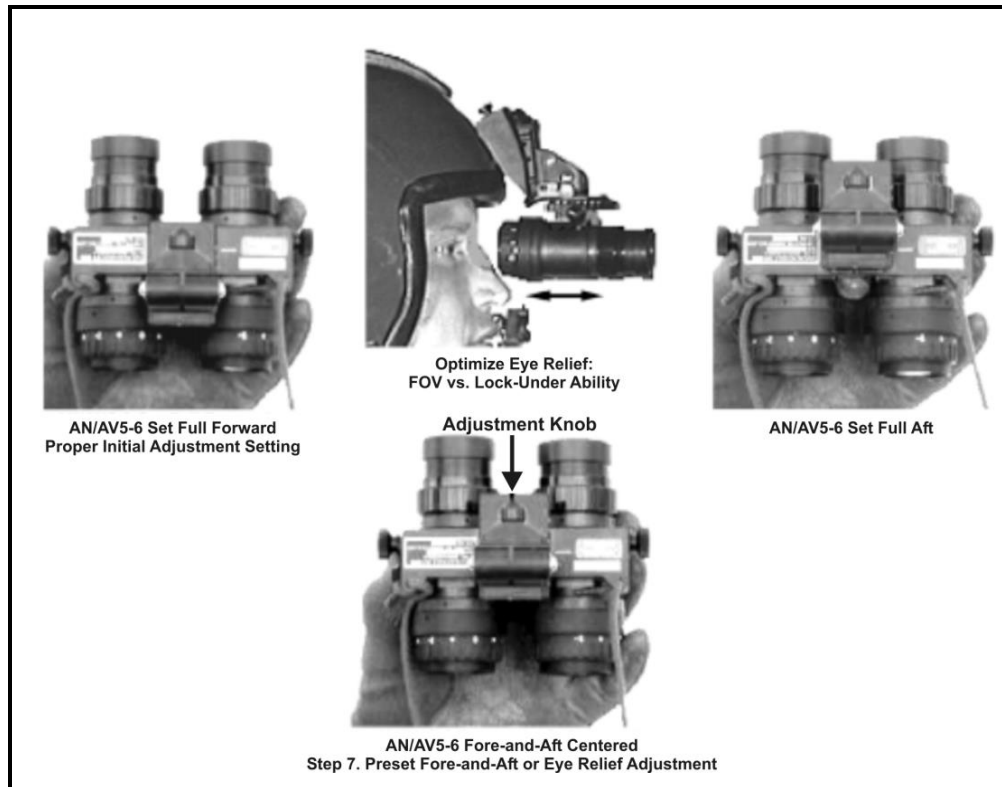

**Figure 8-17 NVG Inspection and Adjustment Procedures (Step 7)**

Step 8. Center Tilt. Initially set the tilt adjustment to the centered position (determined by aligning the tilt lever with bottom portion of the bridge). Ensure the IPD adjustments do not move when manipulating the tilt lever.

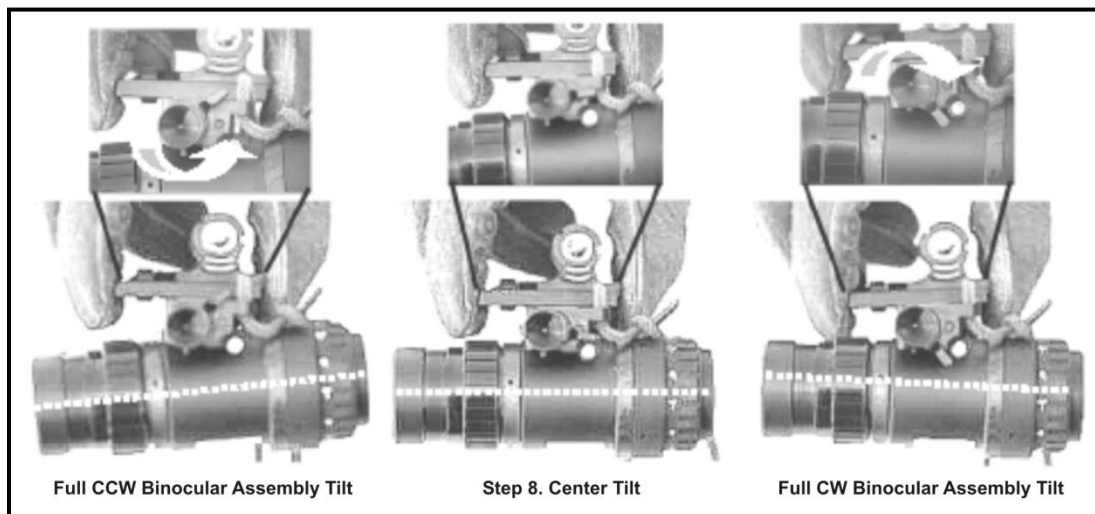

**Figure 8-18 NVG Inspection and Adjustment Procedures (Step 8)**

Step 9. Set IPD. Rotate the IPD thumb wheels to ensure the mechanisms move freely and the tilt lever does not move as the monoculars track along the bridge. Initially, center the IPD for each monocular.

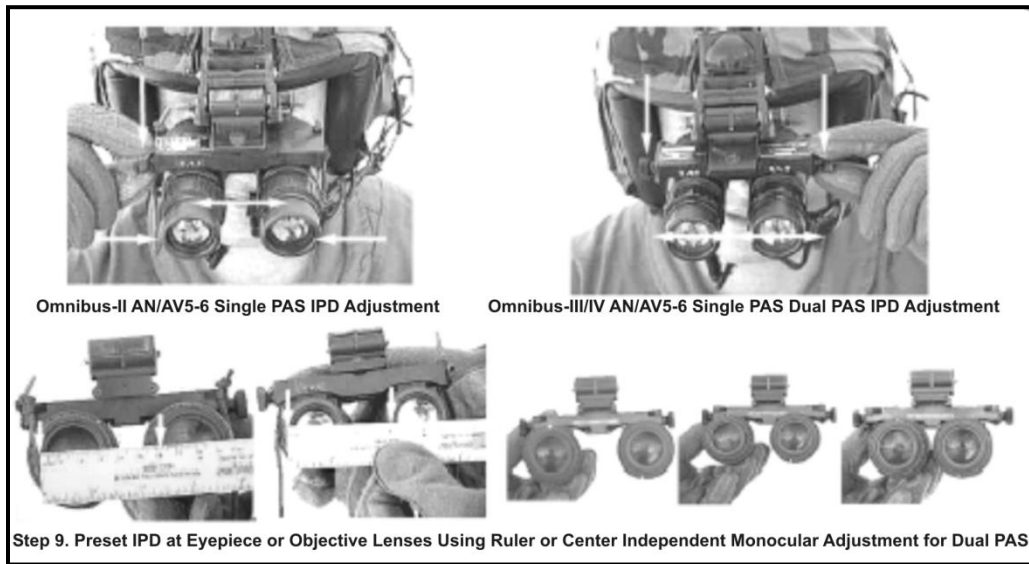

**Figure 8-19 NVG Inspection and Adjustment Procedures (Step 9)**

Step 10. Adjust Vertical. Ensure the adjustment mechanism located on the V-1B NVG mount tracks smoothly to the upper and lower limits of movement, and the thumb wheel moves freely. Set the adjustment to the centered position.

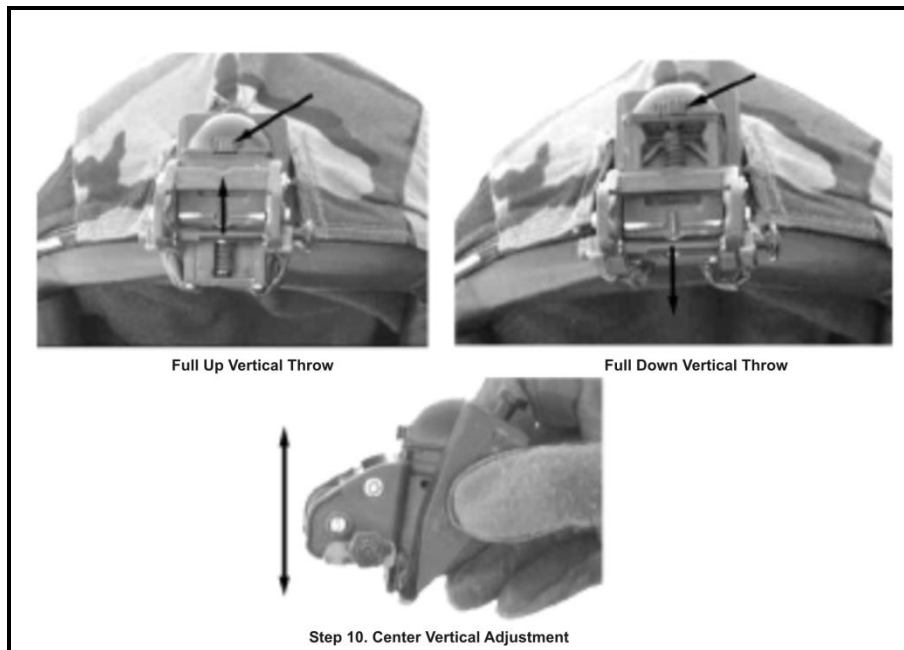

**Figure 8-20 NVG Inspection and Adjustment Procedures (Step 10)**



- Step 11. Don Helmet. The helmet should be donned in order to check for comfort and to prepare for attaching the NVG. Fasten and adjust the integrated chin/nape strap. This is to ensure no additional adjustments will be required in the cockpit due to a shift in helmet position when the mask is attached.
- Step 12. Attach and Remove Binocular Assembly. Attach the binocular assembly to the helmet mount assembly by holding the AN/AVS-9R in a vertical position (90° or perpendicular to mount), as shown in Figure 8-21. Align the spring loaded bearings of the binocular assembly with the channels on the V-1B Quick Don Lock Mount assembly shelf and push gently until the binocular assembly snaps into place. Do not exert excessive force. If too much force is required, it is an indication that the bearings are not properly aligned and the binocular assembly may fail to seat properly or become jammed in the mount.

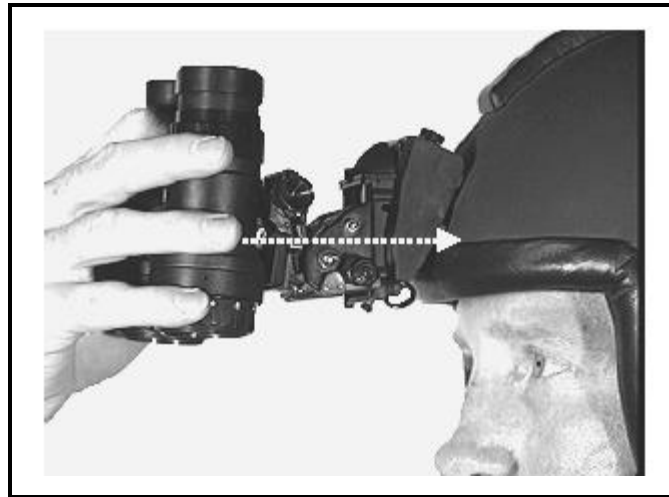

**Figure 8-21 NVG Binocular Assembly Mounting**

- a. Ensure the battery switch is in the OFF position before continuing the inspection.
- b. Do not release the binocular assembly until confirming it will lock securely in the up/stowed position. This action confirms two important points:
  - i. The binocular assembly is properly seated in the mount.
  - ii. The binocular assembly has not been mounted backwards.
- c. Once the binocular assembly has been properly seated, press the lock release button and rotate the assembly into the down/locked (ready for flight) operating position. The eyepiece lens (diopter adjustment) should now be closest to the eyes.

- d. Begin removing the binocular assembly by pressing the lock release button and turning the binocular assembly to the intermediate vertical position. Once out of the locked position, the lock release button can be released. Pull the binocular assembly straight out of the mount, preferably using both hands. Pulling one side slightly out of the detent (slight rocking) and then pulling forward on the assembly may help to remove the NVG easily.
- e. Practice donning and doffing the AN/AVS-9R binocular assembly until comfortable with the technique.

## 2. Alignment Procedures

In a binocular helmet mounted system such as the AN/AVS-9R, there are two images, one for each eye. The two images may differ due to horizontal and vertical alignment error or due to differences in the intensified images. Proper alignment is important because best visual performance is possible only when the optical axis of the NVG is perfectly aligned with the visual axis of the eye, as seen in Figure 8-22. Therefore, optimum focus cannot be attained until proper alignment has been accomplished. Ideally, the ANV-20/20 or NVG eye lane should be used for these procedures. Alignment errors may result because the two optical axes are not parallel. Some imperfection can be present without appreciable adverse effects; however, aircrew should strive for attaining a 100% overlapped circular image sight picture through proper alignment of the NVG axis with the visual axis of the eye. Aircrew should perform the AN/AVS-9R NVG alignment procedures in the following order:

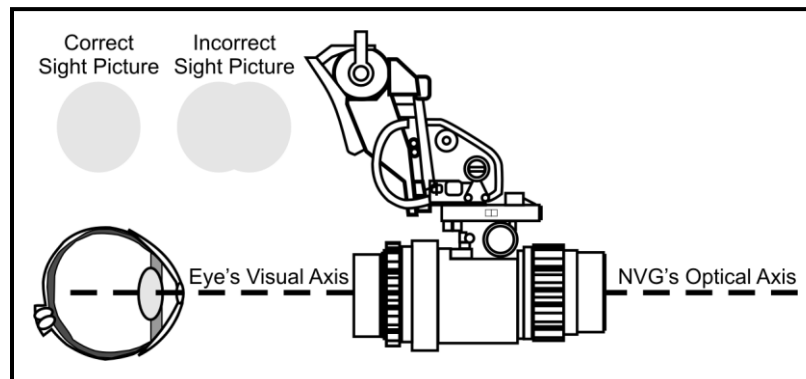

**Figure 8-22 NVG Alignment and Sight Picture**

- a. **Vertical Adjustment.** Vertical adjustment and tilt are important factors for proper NVG monocular alignment with the eye. If not properly aligned with the eye, the upper or lower portion of the FOV will be reduced and the viewer will see the inside walls of the tube. Poor alignment can also result from a defective NVG, poor helmet, or helmet liner fit. Adjust the vertical position of the binocular assembly using the vertical adjustment control located on the Quick Don Lock Mount. The binocular assembly should be set directly in front of the eyes.

- b. **Tilt Adjustment.** Adjust the tilt so the optical axis of the binocular assembly is perfectly aligned with the visual axis of the eyes. If the upper or lower edges of the image areas are blurred, adjust both the vertical adjustment knob and the tilt lever until the blurred edge is removed and an optimal view out to all edges is achieved. Changes in tilt usually require a correction in the vertical adjustment, and vice versa.
- c. **Fore-and-Aft or Eye Relief Adjustment.** The recommended eye relief for the AN/AVS9 is 25mm. This value may not be achievable due to helmet or helmet liner configurations and some anthropometric facial features, such as deep-set eyes or protruding foreheads. If the NVGs are brought in too close to the eyes, one's look-under ability or the ability to look under the NVGs to read instruments or maps is impaired and an unnecessary strain may be placed upon the eyes that may accelerate fatigue. However, if the NVGs are too far away, a significant loss of FOV can occur. To adjust, move the binocular assembly closer to the eyes (Figure 8-23). As the binocular assembly is brought aft, aircrew should see an increase in FOV. Particular attention should be focused on the periphery of the intensified image. The stopping point for adjustment is when one no longer sees an increase in FOV with movement of the binocular assembly aft. As discussed earlier, eye relief should be positioned to maximize the FOV without unnecessarily reducing the ability to see around the NVG to view cockpit displays or perform other tasks. It is especially important that the goggle never be positioned so close to the face that the eyepiece lenses contact spectacles or eyelashes.

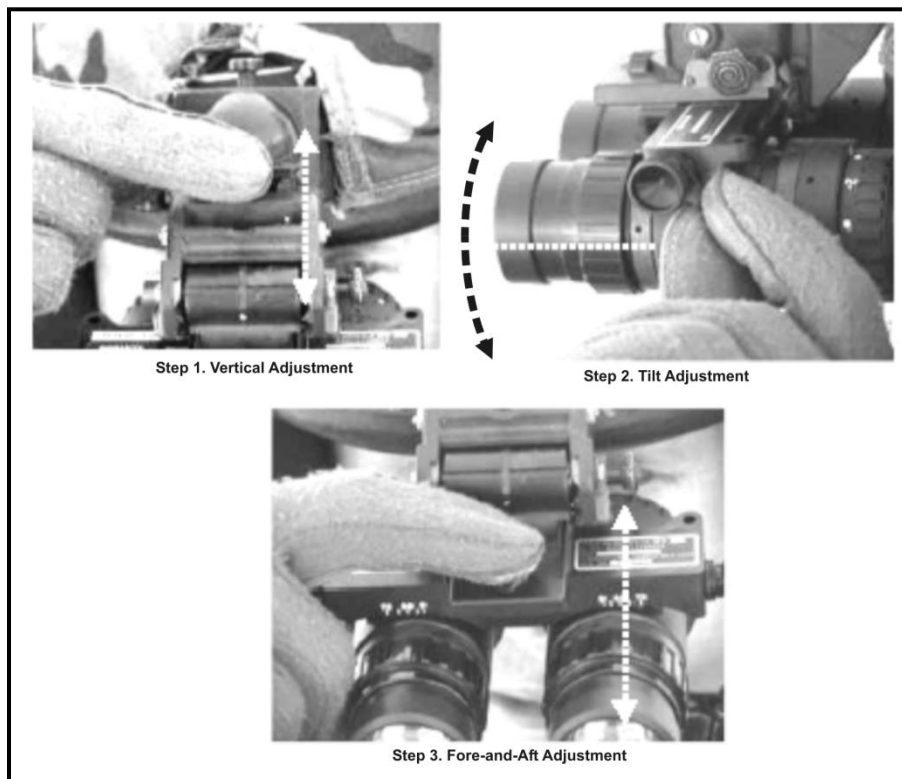

**Figure 8-23 AN/AVS-9R Alignment Procedures (Steps 1 through 3)**

- d. **IPD Adjustment.** IPD is the distance between the pupils of the eyes. It is also referred to as eye span. The center of the intensifier tubes should be aligned with the pupil of the eyes. The distance between the centers of the tubes should be equal with the user's IPD. If the tubes are not aligned, the eyes tend to drift towards the center of the tubes where the optics provides the best visual acuity. This leads to focusing problems, visual fatigue, and headaches. It has also been attributed as the cause of short-term post-flight reduction of near depth perception. IPD is adjusted with the IPD adjustment knob on the AN/AVS-9R, which ranges from 51-72 mm. During the alignment procedures, you should adjust each IPD to independently center the monoculars in front of each eye. Close or cover one eye and center the image in front of the other eye. Carefully evaluate each monocular image for clarity of the edges bordering the circular intensified image. Repeat for the opposite eye. With both eyes open, evaluate the two monocular images. Observe closely the clarity of the combined edges of the overlapped NVG intensified image. If the outside edges are blurred, the monoculars are too close together. If the inside edges are blurred, the monoculars are too far apart. When properly adjusted, the edges of the images in both monoculars will be clear and the resultant NVG intensified image will appear as a single 100% overlapped circle.

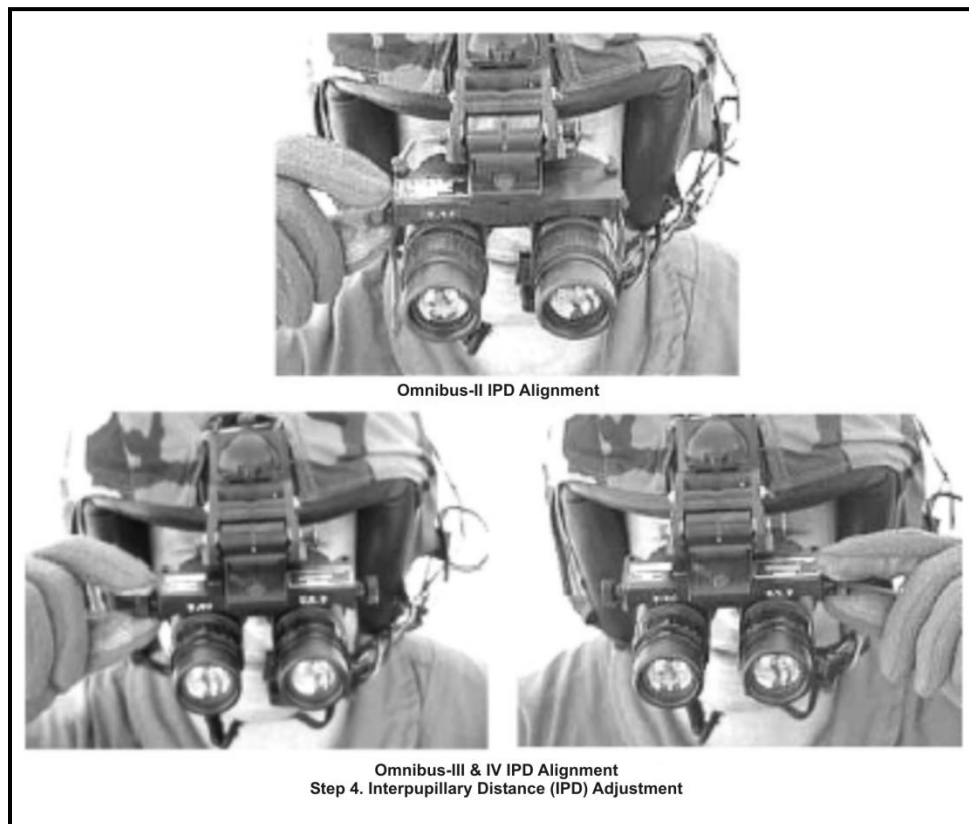

**Figure 8-24 NVG Alignment Procedures (Step 4)**

- e. Evaluate the NVG image. When the goggles are correctly aligned, there should be no shading of any part of the image. If shading is present, attempt to eliminate it by making adjustments in the direction of the shading. If there is insufficient travel in the goggle adjustments, move the entire helmet in the direction of shading. If you must move the helmet in order to achieve proper alignment, it is an indication the mount assembly is not properly positioned on the helmet. Notify flight equipment so the problem can be corrected.

### 3. Focus Procedures

Common methods used to focus and adjust NVGs, such as focusing on a small light source or lettering on a nearby aircraft on the flight line, are not sufficient to ensure the NVGs are properly adjusted for flight. The ANV-20/20 provides a simple method to accurately adjust and focus NVGs. The system is inexpensive and provides a standard to assess NVG tube performance and the ability to properly adjust and focus the NVGs. To perform a preflight quality assurance check of the NVGs, each tube must be checked individually and then the two tubes checked together. When viewing the NVG visual acuity targets (e.g., ANV-20/20, NVG eye lane, etc.), the objective is to be able to discern the orientation of the grid lines as being either vertical or horizontal. Not every line in the grid may be perfectly clear, but the direction of the lines should be readily apparent. Start by using the coarser grids (larger lines); try not to initially focus on the finer grids until the eyepiece or diopter lens adjustment has been made. Aircrews should use the following sequential procedures while adjusting the NVG focus:

- a. Objective Focus. Ensure the diopter lens (inner ring) is preset to either zero or your known diopter setting. With one eye closed or one tube covered, turn the objective lens (outer ring) of the monocular housing while viewing one of the coarser grids of the NVG visual acuity chart. Attempt to bring the coarse lines into focus. Do not spend a great amount of time with this initial objective lens focus, as the purpose is to obtain an image that is adequate to facilitate a suitable diopter adjustment.
- b. Eyepiece or Diopter Lens
  - i. Turn the diopter focus adjustment (inner ring) counterclockwise (toward “+” diopter) until the image is blurred. Pause for one to two seconds to allow the accommodative eye muscles to relax, then turn the diopter adjustment clockwise until the image just comes into sharp focus - **STOP**. If one continues clockwise rotation of the diopter focus ring past the initial point of sharp focus, a range will be seen where the image still maintains clarity. Rotating the diopter adjustment beyond this point, forces the eye muscles to actively work to keep the image focused. During the course of an NVG mission, these eye muscles will become fatigued and unable to maintain this accommodative focus. Do not leave the diopter adjustment beyond the point at which the image initially becomes sharply focused, even though the image remains clear. This will result in an insidious and gradual loss of NVG resolution and depth perception that may not be perceivable to the aircrew. In addition, this maladjustment may also

induce severe eyestrain and/or headache. Performed correctly, this procedure focuses the image on the retina of the eye without accommodative muscular effort.

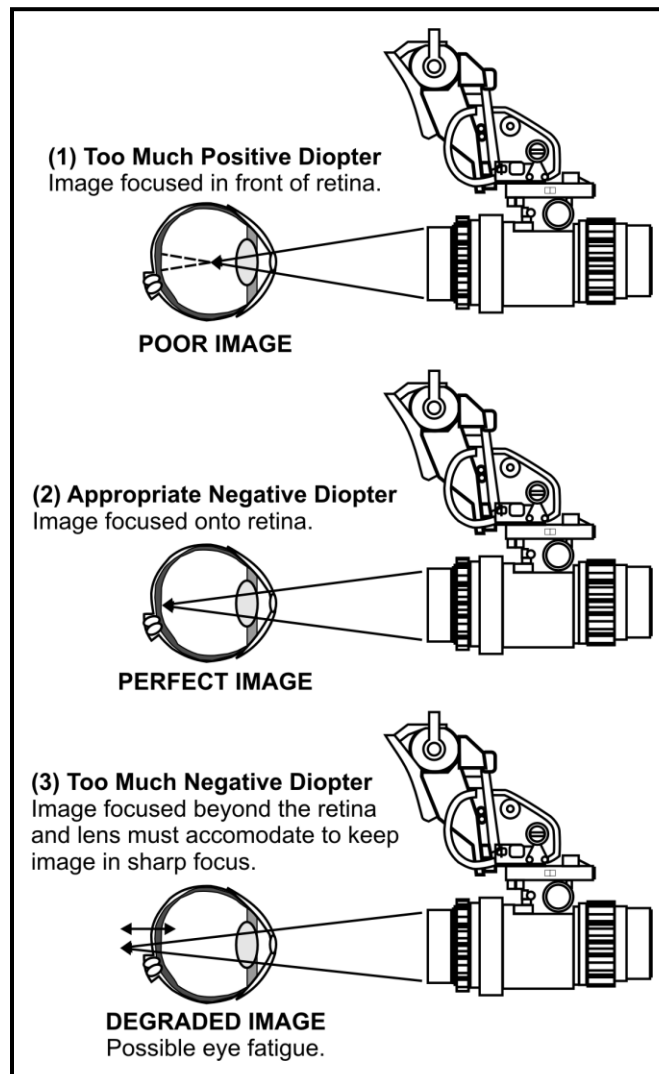

**Figure 8-25 Optimal Eyepiece or Diopter Adjustment**

- ii. To summarize, the diopter adjustment is the most critical adjustment of the NVG. Unfortunately, it is also misadjusted the most often. Follow these procedures to ensure a proper diopter adjustment.
  - (a) Rotate counterclockwise beyond the point of focus. The eye cannot accommodate in this direction, which allows the eye muscles to relax.
  - (b) Rotate clockwise, dialing in negative diopter until the best image is achieved. Assume that you will “overshoot” the optimal diopter setting.

- (c) Rotate counterclockwise until the quality of the image just begins to degrade. Then nudge the image back clockwise slightly to achieve the optimal diopter setting.
- iii. Readjustment of Objective Focus. Once the diopter has been adjusted, fine-tune the focus by readjusting with the objective adjustment to bring into focus as many of the grids as possible. This accomplishes two things. First, it assures aircrews the diopter adjustment has been satisfactorily performed. Second, it allows for an accurate assessment of NVG performance. At first, it may take several attempts going back and forth between the diopter and objective adjustments to obtain the best focus. However, once comfortable with the procedure, focusing can be accomplished accurately and consistently with ease.
- iv. Focus of Opposite Monocular. After focus of the first monocular is accomplished, use the same procedures to focus and evaluate the remaining monocular. Do not be concerned if one monocular image is slightly sharper. A slight difference in the performance of individual I<sup>2</sup> tubes is common.

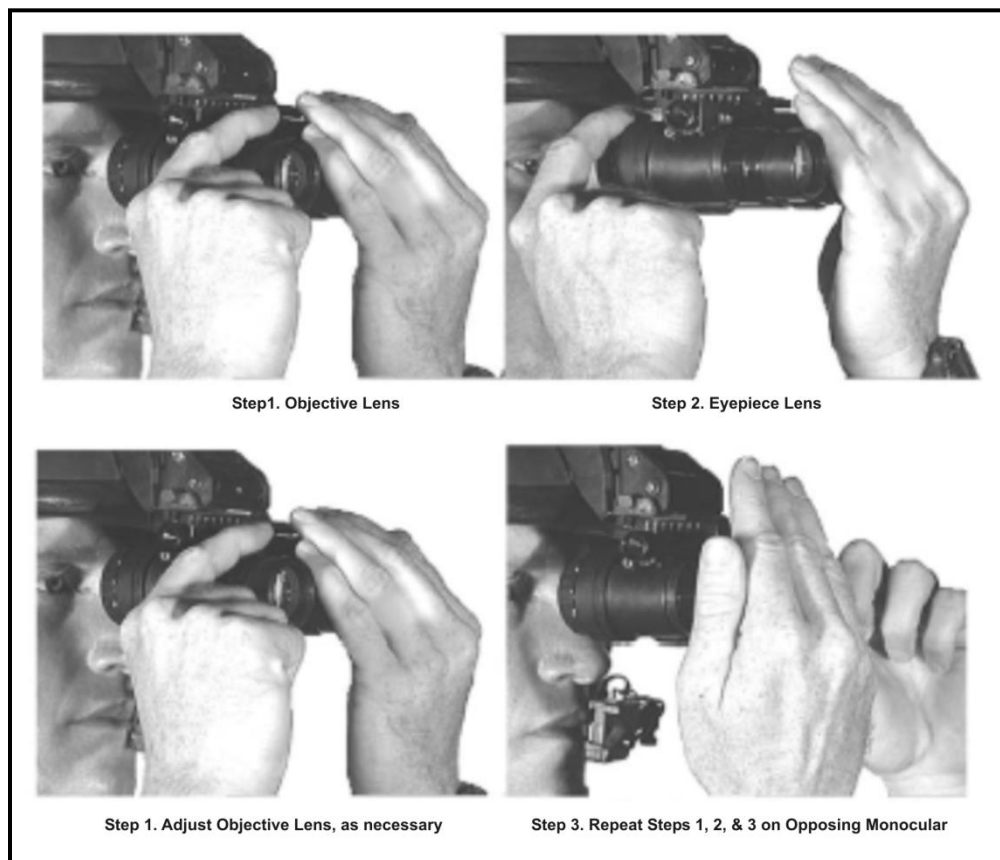
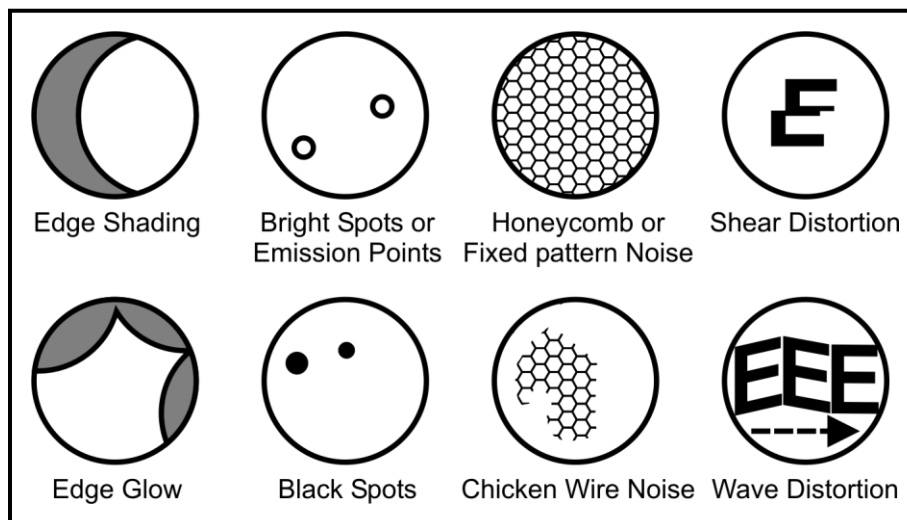

**Figure 8-26 NVG Focus Procedures**

#### 4. NVG Image Assessment Procedures.

Assessment of the NVG image serves as the quality assurance step for preflight of the AN/AVS-9R. With experience, these procedures can easily be integrated into alignment and focusing phases of the NVG preflight.

- a. Evaluate NVG Visual Acuity. NVG visual acuity obtained with both eyes should be at least as good as that obtained through either monocular. If this is not the case, the NVG should be returned and another pair obtained. The minimum NAVAIRSYSCOM acceptable NVG visual acuity for the AN/AVS-9R is 64 lp/mm, which corresponds to the Snellen Visual acuity of 20/25 while viewing a high contrast target under high illumination conditions. Although military specifications require a visual acuity of 20/25, it is important to remember that it is obtained under laboratory conditions. One's obtainable resolution may differ slightly, particularly when combined with a dirty or scratched canopy, incompatible light sources, and fatigue issues.
- b. Evaluate Image Quality. NVGs have historically been very reliable. However, the manufacturing process, especially with regard to intensifier tube development, is tedious and susceptible to errors. The following describes potential NVG image anomalies or peculiarities. In some instances, these intensified image peculiarities are normal NVG image nuances, while others are defects. It is important to know the difference to correctly diagnose the image peculiarity and to better write the NVG Maintenance Action Form, if warranted. The most common image peculiarities are listed below and depicted in figure 8-27.



**Figure 8-27 Image Defects**



- i. **Shading.** Each monocular should present a perfect intensified image circle. If shading is present, you will not see a full circular image. It appears as a dark area along the edge of the image. Initially, try readjusting the controls (e.g., Tilt, IPD, and Vertical Adjustment) by moving the individual monocular toward the area of shading. If the shading persists, try moving the NVG and/or helmet toward the shaded edge. Uncorrectable shading is indicative of a dying photocathode caused by a defective vacuum seal on the image intensifier tube. Shading is very dark and one cannot see an image through the shaded region of the intensifier tube. Shading will always begin on the edge and will eventually move inward across the entire image area. The shaded region will also present a high contrast and distinct line of demarcation. Do not confuse shading with variations in output brightness. If uncorrectable shading is present, turn the NVG in to maintenance.
- ii. **Edge Glow.** Edge glow appears as a bright area along the outer edge of the image. It is usually the result of an incompatible light source within or just outside the NVG FOV, although, it can also be the result of an I<sup>2</sup> tube's microchannel plate shift induced by mishandling. If detected, simply cup your hand over the objective lens to block out all light. If the image still displays edge glow, the bright area will still show up. If the edge glow does not disappear, turn the AN/AVS-9R in for maintenance.
- iii. **Bright Spots.** Bright spots can be defects in the image area caused by a flaw in the film on the I<sup>2</sup> tube's microchannel plate. A bright spot is a small, non-uniform, bright area that may appear either as a flicker or as a constant output. Not all bright spots are downing gripes for the AN/AVS-9R. Bright spots usually go away when light is blocked from the objective lens and are considered cosmetic defects that are signal induced. To determine the significance of the bright spots, cup your hand over the objective lens to block out all light. If the bright spot(s) remain, turn the NVG in for maintenance. Bright spots can be acceptable if they do not interfere with the aircrew's ability to view the NVG Image. NVG specifications limit the size, location, and number of bright spots within the NVG I<sup>2</sup> tube. If the spots are distracting or interfere with the operator's ability to perform the mission, return the goggles for maintenance.
- iv. **Black Spots.** Black spots can be either cosmetic blemishes in the I<sup>2</sup> tube or dirt/debris between the lenses. Black spots are acceptable as long as they do not interfere with viewing the NVG image. As with bright spots, the NVG specification has guidelines that limit the size, location and number of black spots within the NVG intensified image field. If the spots are distracting or interfere with the operator's ability to perform the mission, return the AN/AVS-9R for maintenance.

- v. Emission Points. Emission points are steady or flickering pinpoint of bright light in the NVG image area that do not go away when all light is blocked from the NVG's objective lens. The position of the emission points within the image will not move. Emission points are not necessarily a downing gripe. Emission points become unacceptable if they are brighter than the background scintillation of the I<sup>2</sup> tube under LLL illumination conditions.
- vi. Honeycomb Pattern (Fixed-Pattern Noise). The honeycomb pattern is usually a cosmetic blemish characterized by a hexagonal (honeycomb) pattern visible across the entire intensified FOV. The honeycomb pattern most often occurs under high light level or when a bright light source is introduced into the NVG's FOV. This pattern is a result of the manufacturing process in which the fiber optics is assembled within the tube. Normally it is faint in appearance and does not affect NVG performance. Should it appear as a bold outline or during low-light level NVG conditions, turn the NVG in for maintenance.
- vii. Chicken Wire. This is an irregular pattern of dark thin lines in the FOV, either throughout the entire intensified image field or simply in selected parts of the NVG image area. Under the worst-case condition, the lines will form hexagonal or square wave-shaped lines. These lines are caused by defective fibers that do not transmit light at the boundaries of the fiber bundles in the output optic of the I<sup>2</sup> tube. If the chicken wire interferes or distracts the aircrew, return the goggle for maintenance.
- viii. Distortion. Distortion is introduced into an I<sup>2</sup> tube during the manufacturing of the fiber optic twist. This small amount of distortion is not perceivable to the human eye. The two most common types of distortion are wave (or bending) distortion and shear distortion. Wave distortion is when vertical linear objects, such as trees or poles appear to wave or bend when one moves their head. Shear distortion is when static linear objects appear as a misaligned image.
- ix. Image Flickering. Flashing, flickering, or intermittent operation of the NVG may reflect an impending failure of the tube, dirty electrical contacts, faulty wiring, or battery. This can occur in either one or both monoculars. If there is more than one flicker, check for dirty contacts, loose wires, loose battery cap, or weak batteries. If corrective action does not alleviate the condition, turn the NVG in for maintenance. If airborne, switch to the alternate battery and assess NVG operation.
- x. Veiling Glare. Veiling glare occurs when light outside the FOV strikes the objective lens of the AN/AVS-9R and scatters instead of passing through the lens. Veiling glare produces a decrease in NVG image contrast and appears as a light haze across the entire image. It can be caused by excessively scratched, pitted, or chipped objective lenses. In addition, dust, smudges, or fingerprints may also contribute to this condition.

- xi. Scintillation. Scintillation or image graininess is a normal nuance of the NVG image that occurs as light level decreases. Scintillation appears as a “sparkling” effect over the NVG image and results from electronic noise created at the high gain levels achieved under low illumination conditions. In flight, it can be an indication of decreasing illumination caused by such things as worsening weather conditions or flight into shadowed areas.
- xii. Brightness (Luminous) Difference. During or after making the adjustments for IPD and binocular focusing, one image may appear less bright (dimmer) than the other image. If the difference in brightness is judged great enough to interfere with the mission performance, the NVG should not be utilized.
- xiii. Contrast Difference. During or after making the adjustments for IPD and binocular focusing, the two images may differ in contrast. In a contrast comparison, the user is looking for noticeable differences in the range between the darkest and lightest portions of an image. For example, if a highly reflective tree is extremely bright in one tube, and relatively dim in the other, contrast differences may be deemed unacceptable for that set of NVG. This may indicate a defective tube. The user may elect whether or not to utilize the NVG for a given mission after considering ambient light levels, terrain, user experience, and degree of tube differences.
- xiv. Visual Acuity or Image Disparity. This condition exists when there is a difference in performance between the two image intensifier tubes within the same binocular. This is usually noted by one monocular attaining a better acuity than the opposing monocular. If the acuity or image disparity is judged to be great enough to interfere with mission performance, the NVG should not be utilized.

## 5. Preflight Focus Adjustment

NVG performance is optimized through proper preflight focus and adjustment. Using a standardized preflight method, rather than a field expedient method, allows you to quantify the performance of the NVG to a known standard. In addition, during low-light level nights, aircrew will not be able to achieve an NVG image that would be suitable to conduct focus adjustments in the field. By using the ANV-20/20, a NVG resolution chart is placed at a known or calibrated distance and illuminated by a high-light level source to present an optimal target for initial NVG preflight alignment and focusing.

## 6. ANV-20/20 NVG Infinity Focus Device

The ANV-20/20 NVG Infinity Focus Device is a compact portable system designed to provide aircrew an accurate means of performing a quantitative preflight NVG alignment and infinity focus adjustment capability.

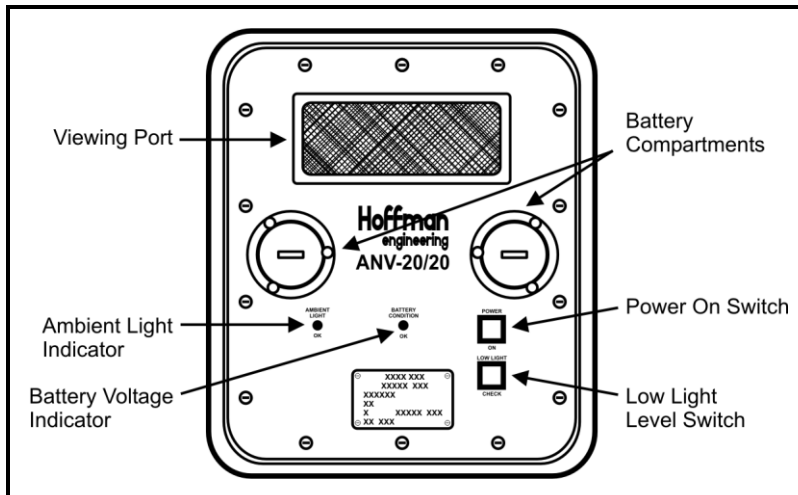

**Figure 8-28 ANV-20/20 NVG Infinity Focus Device Front Control Panel**

- a. ANV-20/20 NVG Infinity Focus Device Operation. Two push buttons and two LED indicators located on the front panel control operation of the ANV-20/20. Depressing the power-on pushbutton activates the unit for a three-minute operation cycle. By holding the power-on pushbutton, the status indicators activate to evaluate both battery condition and ambient room lighting. The green Battery Condition OK indicator will light when battery voltage exceeds 4.2 volts (1,500/3-minute operational cycles). If the indicator fails to light, the batteries should be replaced. To optimize ANV-20/20 operation, ambient room lighting should be minimized. The green Ambient Light OK indicator will not light when ambient light entering the viewing port exceeds 0.1 foot-candle, thereby alerting the operator to reduce ambient lighting prior to operation.
- b. ANV-20/20 NVG Infinity Focus Device Operational Modes. The ANV-20/20 can operate in two modes: Normal and Low Light. The Normal Mode, or high light test level is equivalent to viewing a medium contrast target under quarter moon illumination and should be used for the critical NVG preflight focus and adjustment. By looking through the viewing port, aircrew can observe the ANV-20/20 Snellen Visual Acuity (SVA) test pattern that has been set at optical infinity. The test pattern contains nine test targets (grids) that range from 20/20 SVA to 20/70 SVA. Each test target has two sets of vertical and horizontal test pattern grids. If one can resolve both the horizontal and vertical test patterns associated with that test target grid, the individual has achieved that level of SVA. For example, test grid “35” is equivalent to a SVA of 20/35, etc. The test grid fills approximately ten degrees of the NVG FOV. After the operator has achieved the best focus possible using the Normal Mode, the Low Light Mode can be used to gain perspective on anticipated LLL (starlight) NVG performance. Depressing and holding the Low Light pushbutton activates the Low Light Mode. No focus adjustments should be attempted while viewing the SVA test pattern in the Low Light mode.

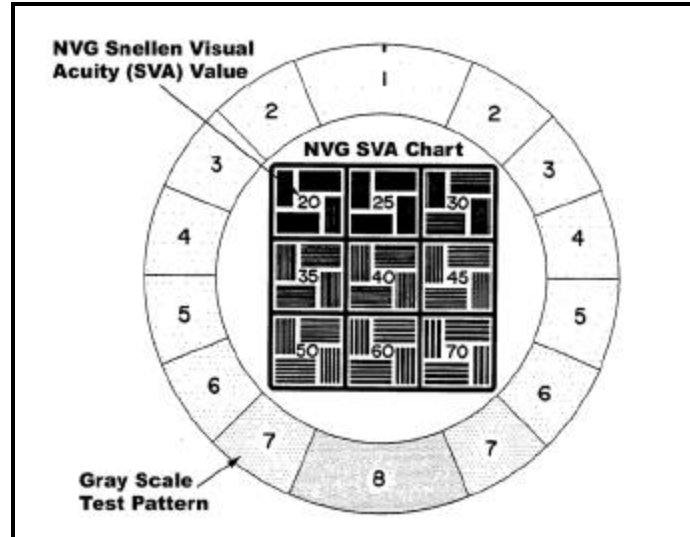

**Figure 8-29 ANV-20/20 NVG Infinity Focus Test Pattern**

In addition to the SVA test pattern, the ANV-20/20 incorporates a circular eight step gray scale used for evaluating the dynamic gain range of the NVG. The eight successive steps between the brightest pattern #1 (clear) located at the 12 o'clock position and the darkest pattern #8 (black) located at the 6 o'clock position represents the dynamic range of the scale. Each progressive step from #1 to #8 (clockwise or counterclockwise) represents a half decrease in brightness (e.g., quarter moon to eighth moon, etc.).

## 7. Aircraft Ground Adjustment Procedures

Perform the following procedures prior to takeoff:

### a. Confirm IPD and Diopter Settings

Before donning the NVG in the aircraft, confirm that the diopter settings are the same as determined in the NVG eye lane. If the diopter adjustment has been inadvertently moved, it is unlikely, due to play in the adjustment mechanisms, the setting obtained in the NVG eye lane can be correctly achieved by placing the diopter adjustments in the previously noted position. Therefore, if this occurs, it is best for aircrew to repeat the preflight objective and eyepiece diopter lens adjustment procedures using a distant target (e.g., non-illuminated object with vertical or horizontal linear features).

### b. Set Aircraft Lighting and Display Intensity

Set cockpit lighting and display intensity so that information can be easily interpreted when looking around or below the NVG. When the NVG is initially turned on, unaided night vision will be adversely affected, and lighting and display intensity may need to be increased. As the eye adapts to the brightness of the image, the intensity may be able to be decreased. The important point for aircrews is to understand the ability to read and interpret all instruments and displays at all times.

## 8. Aircraft Airborne Adjustment Procedures

Make the following minor adjustments during flight as required:

### a. Vertical Adjustment

As the helmet settles and/or rotates during flight, it may be necessary to make minor vertical adjustments as needed to keep the image in the proper position in front of the eyes. If you find yourself frequently readjusting the NVG or if you reach the end of the range for vertical adjustment, take your helmet to flight equipment for a refitting.

### b. Tilt Adjustment

Any vertical adjustment will likely require readjustment of the tilt adjustment. Fore-and-aft shifting of the helmet will require some tilt adjustment.

### c. IPD

Make small adjustments to IPD as required and with caution. Remember, improper IPD adjustments can cause headaches, blurred, or double vision.

### d. Fore-and-Aft or Eye Relief Adjustment

Eye relief may need readjusting to allow better viewing of cockpit instruments or displays, or in some cases, to maintain the full FOV. If significant eye relief adjustments are made in flight, the diopter lens focus will have to be readjusted.

## 806. NVG GOGGLE/DEGOGGLE PROCEDURES

### Goggle/Degoggle Considerations

#### 1. Ambient Illumination

Ambient illumination at the time of initial takeoff may not be compatible with NVGs. Therefore, goggling may be required at some point during the mission once favorable conditions exist. Under these conditions, the NVGs should be fully preflighted and adjusted prior to takeoff, and then stored in the NVG case until it is needed.

#### 2. NVG Goggling/Degoggling Procedures

There are three times during a flight when goggling or degoggling can take place. These times are chock-to-chock, airborne, or at an outlying field or LZ. The aircraft commander is responsible for determining when and where goggling or degoggling will take place. TW-5 aircrews will utilize the chock-to-chock procedure.

- a. **Chock-to-Chock**
  - i. Goggle. Prior to taxi, all aircrew will have their goggles donned and activated for use. All exterior and interior lighting will be set as briefed.
  - ii. Degoggle. The final landing will be accomplished with the NVGs on. Degoggling will take place after the aircraft has taxied to a designated spot in the line environment.

## 807. AIRCRAFT NVG COMPATIBILITY

### Aircraft Lighting Considerations

The AN/AVS-9R is spectrally filtered for sensitivity in the red region of the visible spectrum and into the near IR spectrum (645 NM to 900 NM). Therefore, to make aircraft interior lighting compatible with the most current NVGs, we must ensure that NVG “compatible” interior lighting is designed so that it does not fall within the spectral sensitivity range of the NVGs. Therefore, the NVG does not “see” the output from lights, however the light output is sufficient for viewing around the NVG monoculars with the unaided eye.

- a. **Interior Lighting**

NVG cockpit compatible lighting provides the capability to view interior aircraft instruments (e.g., aircraft flight and engine instruments, maps, circuit breakers, etc.) and to complete other aircraft tasks with the unaided eye, while not negatively impacting or degrading the NVG image. Due to the increased gain of the NVGs, even the smallest escape of unfiltered light in the cockpit will have a negative effect on the goggles either directly or through windscreen glare.

- b. **Exterior Lighting**

The exterior lights on the TH-57 are designed to be visible to the unaided eye and will generally have adverse effects when viewed through the NVGs. The searchlight/landing light will be used primarily while conducting low work. The area illuminated by the beam of the searchlight will be much brighter and the area outside of the beam will appear darker on the NVGs. When flying in well lit areas (e.g., runway/airfield environment, etc.) with increased cultural lighting, consider using the searchlight and/or landing light to offset the NVG “washout”. Another consideration is the effect that the searchlight has in a dusty LZ where the light is being reflected off the dust particles. The increased gain of the goggles increases the effects of brownout. The position lights, the port (red) in particular, will have an effect similar to the landing light. Position lights should be set at the highest intensity consistent with NVG compatibility. The setting may be adjusted by the aircraft commander if the lighting configuration interferes with safe flight operations. The anti-collision light can have adverse effects when close to the ground or on hazy

nights. Due to the characteristics of NVGs, detection ranges of other aircraft are significantly greater than with the unaided eye.

When flying in built-up or highly illuminated areas (e.g., runway/airfield environment) with increased cultural lighting, consider using the searchlight to offset NVG degain. Utilizing the searchlight or landing light to “burn through” the excessive illumination created by the cultural lighting, will allow aircrew a better representation of the surrounding terrain.

## **808. NVG SCENE INTERPRETATION**

### **1. Terrain Assessment**

It is important the night systems crews thoroughly study anticipated terrain characteristics to help predict visual performance with NVGs. This assessment can be divided into three basic areas:

#### **a. Density**

Density is the relative measure of “how many things on the ground can be seen”. An object must have sufficient size and contrast to be distinctly perceived by either central or peripheral vision. Examples of areas with poor density are open areas, completely snow-covered terrain, most deserts, and calm water. Because of the reduction in resolution, contrast, and FOV inherent with NVGs, the terrain density will be perceived to be less than with the photopic eye. The reduction in density increases the potential for spatial disorientation; therefore altitude and airspeed cues derived from terrain density must be crosschecked and verified with cockpit instruments, in particular the RADALT.

#### **b. Terrain Profile**

Merely reading the numbers off a RADALT will not ensure terrain clearance. Although the RADALT may read 100 feet AGL, the pilot will take drastically different courses of action depending on the type of terrain out in front of them. Terrain profile is the terrain assessment that measures two characteristics of the terrain: terrain gradient and terrain slope.

- i. Terrain gradient is the contour of the terrain and can be divided into three broad categories: flat, rolling, and rough. Flat terrain will require the least amount of effort devoted to monitoring the flight path. Rolling terrain will require more effort to be directed toward flight path monitoring due the possible presence of the possibility of hidden hills. Rough terrain will require almost exclusive effort be devoted to flight path monitoring because of the rapid changes in terrain features. The possibility of not seeing hills or other terrain features increases with NVGs because of their contrast limitations and their poor performance in very low illumination conditions, such as terrain shadowing.



- ii. Terrain slope is the measure of the tilt of the overall terrain. An up-slope will require more effort be devoted to flight path monitoring compared to even or down-sloping terrain. In areas of low-density terrain, detecting gentle up-sloping terrain is very difficult. Turns in these situations are hazardous due to the reduced time available for detecting the up-slope while turning into it. The RADALT is your best means to detect changes in slope. Unfortunately, the RADALT only tells you what was below the aircraft and does not provide rate information. The RADALT also has a roll and pitch limitations making it an unreliable source of information in certain maneuvers. Good mission planning and SA will help reduce the possibility of a mishap.

c. **Unacquired Vertical Obstructions**

The last flight terrain assessment category is unacquired vertical obstructions. This category includes anything that sticks up into the aircraft's flight path, such as trees, power lines, antennas, poles, or hidden hills. The reduced contrast, resolution, and FOV provided by NVGs combine to create the potentially hazardous situation of not detecting these obstructions until it is too late. Presently, the best way to cope with this hazard is to maintain up-to-date hazard maps, SA, and extra vigilance when searching.

2. **Common NVG Scene Descriptions**

a. **Shadows**

Knowing the moon angle and azimuth, combined with a thorough map study, will enhance the capability of the aircrew to use or avoid shadows as necessary. NVG performance is influenced by shadows. NVG shadows are formed by illumination sources (usually the moon) being blocked by terrain or cultural objects. Shadows created by clouds can create visual illusions leading to disorientation. For example, while flying underneath a broken layer on a high light level night, the pilot will be constantly in and out of shadows causing the NVG gain to fluctuate, thereby making it more difficult to pick out terrain features. The changes in illumination will also affect depth perception. A scattered layer will not be as distracting but can mask or hide important navigation or targeting information. In the brighter areas between the scattered cloud layers, the NVG gain will be driven down making it more difficult to see objects lying within the shadows. Once inside the shadowed area, the gain will readjust, perhaps making it easier to see the previously hidden objects. Some shadows can be predicted, such as those cast by towers, smoke stacks, and mountains.

b. **Roads**

The ability to detect roads with NVGs depends primarily on the albedo difference between the road and the surrounding terrain. Sometimes the road itself will not be seen initially. A swath or cut through a forested area that was cleared for a road might alert aircrew to a road's presence. A concrete road (quite reflective) should be

easily seen in farming country where the surrounding terrain may be less reflective. However, a concrete road may be less discernible in a desert environment where the road and terrain may have similar reflective values. On the other hand, an asphalt road may be more discernible in desert conditions where the albedo difference will likely be much greater. The bottom line is that roads may or may not be easily seen and preflight planning will help reduce surprises.

c. **Water**

There is very little contrast between a land mass and a body of water during low light conditions. When viewed through the NVGs, lakes or rivers appear dark. As the light level increases and the moon angle decreases, the water begins to change color, land-water contrast increases, and reflected moonlight is easily detected. When overflying large open areas of calm water, reflections from clouds, stars, or the moon can be disorienting. NVGs may be able to display a horizon but, due to the lack of surface texture, height above water may be impossible to perceive. Due to the lack of terrain density, aircrew must rely heavily on flight instruments while flying over open water; however, when a surface wind or swells exist, the resulting whitecaps can provide contrast to assist in altitude and speed estimation.

d. **Open Fields**

Contrast is very poor in large fields covered with similar vegetation. Leaves containing chlorophyll may appear almost white. A freshly plowed field will likely have little vegetation and the roughened terrain will probably absorb, more than reflect, light energy. This combination will create a darker area. Overflying a series of smaller fields with differing vegetation can help overall situational awareness. Fields with vegetation will usually have high terrain density that aids in orientation.

e. **Desert**

Most of the time, open desert presents a washed out image through NVGs due to poor contrast and poor terrain density. Gradually rising terrain and ridgelines can be particularly difficult to discern and may first be noted by a change in the RADALT. On a particularly bright night with the moon high overhead, the NVGs can begin to degain or wash out considerably, making it even more difficult to pick out what little contrast or density is available. Additionally, fixed pattern noise (honeycomb) may be seen under these conditions creating “focus trapping” (staring at the pattern rather than the terrain) and making it even more difficult to discern small contrast differences. In general, flying above this type of terrain is similar to flying over water (without the reflection) and is best accomplished at a higher altitude or using instrument flight techniques.

f. **Forests**

Heavily forested areas may not reflect light efficiently and solid canopied forests can appear extremely dark unless the trees have leaves with high levels of chlorophyll (usually in the spring). Excellent contrast and texture differences do exist between deciduous (leafy) and coniferous (pines, firs, etc.) trees.

g. **Snow**

Fresh, wet snow reflects about 85% of the energy incident upon it thereby providing good natural reflectivity. However, high light levels can provide excessive luminance, which, like the desert, can lower gain and degrade resolution (NVG image washout).

h. **Artificial Light Sources**

Highly populated areas can generate very significant levels of ambient light. Many of the discrete artificial sources exhibit overlapping halos in the NVG image. This substantially reduces contrast and detail between sources. Although lighted areas can be seen from great distances, specific buildings or objects within the lights cannot always be distinguished. When associated with overcast, city lights can supply increased illumination to less illuminated areas by reflecting light from the bottom of the cloud layer. A baseball field lit up at night can look like a small town. Automobile lights can provide excellent cues to the presence of a road, but direct light from an automobile, especially halogen types, can be very disconcerting at low altitude. The red lights on top of radio and microwave towers are visible from 10-30 miles, depending on the atmospheric conditions, but their range and relative distances can be hard to judge. Aircraft anti-collision lights can be seen at even greater distances. If you must look into the bright light source it may be necessary to revert to instrument flight for brief periods, realizing that maneuverability is adversely impacted during this time.

3. **Atmospheric Impact on NVG Performance**

a. **Clouds**

There is a great variety of particle size within individual, as well as multiple, cloud formations; therefore, it is difficult to predict how much they will attenuate NVG performance. Water vapor exists at all temperatures. Because the amount of water vapor a cloud formation can hold increases with temperature, summer clouds generally have higher liquid water content than winter clouds. Thick, dense clouds can be easily seen with NVGs, especially when silhouetted against the night sky. This also means thick clouds can reduce the amount of illumination that strikes the ground, thereby reducing the available luminance to the NVGs. Thin and wispy clouds have greater space between particles; therefore, a greater amount of the near IR radiation will be passed without scattering. For this reason, it is possible for thin,

wispy clouds to be seen by the naked eye (visible light or shorter wavelengths), but remain invisible when viewed through NVGs.

The presence of thin clouds that progress into thicker ones can result in hiding terrain features. This can obviously create a severe hazard for NVG operations. Low clouds lying upon and between hills present a particularly dangerous situation due to the inability of the aircrew to distinguish between the clouds and the terrain. The cloud may get progressively thicker, allowing the pilot to progress through the cloud without initially perceiving a “cloud wall”. If a cloud is detected, the perception may be that it is off at a distance. The aircrew must be alert for a gradual reduction in light level and notice the obstruction of the moon and the stars. The lesser the visibility of the moon and stars, the heavier the cloud coverage. If the NVG image becomes grainy and begins to scintillate (sparkle), this is an indication that weather may be causing a low ambient light condition. Although clouds can decrease illumination and resulting luminance from the moon and stars, they can, especially if low and broken to overcast, reflect enough cultural lighting to help offset the loss of lunar illumination. Obviously, this will only occur in and around areas with significant cultural lighting and is only helpful if it is clear beneath the overcast.

b. **Fog**

The effects of fog are similar to those of clouds. Generally, fog is distinguishable from clouds only in regard to distance from the ground. One way to note an increase in the moisture content of the air while utilizing NVGs is to observe a decrease in the intensity of ground lights. The halo effect noted around lights when viewed directly with NVGs may be perceived as larger and more diffused in an area of increased moisture.

c. **Rain**

Like clouds, the performance of NVGs in rain is difficult to predict as droplet size and density are variable. All previous discussions on water vapor, clouds, fog, absorption, and scattering are applicable here.

d. **Falling/Blowing Snow**

Snow occurs in a wide range of particle sizes and geometric shapes. As with other forms of moisture, the density of the flakes will determine how much illumination and luminance is blocked and therefore how much degradation occurs to the NVG image. Snow can enhance luminance as it reflects available light when on the ground.

e. **Sand and Dust**

Sand or dust particle size and density will determine the overall effect on NVG performance. The effect of blowing sand or dust is similar to that created by snow.

Consideration should be given to utilizing instrument takeoff procedures and landing via a no-hover or sliding landing to minimize the effects of brownout.

f. **Lightning**

Looking directly at lightning will cause NVGs to significantly degain momentarily. However, lightning will temporarily increase illumination, enhancing the NVG image, when not directly in the FOV. The brief duration and enhanced image clarity can create the impression that objects are much closer than they really are.

### 809. LLL CONSIDERATIONS

The low light level (LLL) environment flight regime is the most demanding environment to operate in. It requires detailed briefing, excellent crew coordination, and a vigilant scan. NVG performance in conditions of low ambient illumination is characterized by decreased resolution, visual acuity, contrast, and hazard detection range. Low ambient illumination also creates an increase in the blooming effect from artificial illumination sources (e.g., aircraft lighting, muzzle flashes, rocket motors, flares, and cultural lighting). This is due to a small amount of light (photons) available to strike the photocathode. Since the photocathode receives much less light, the image has “video noise” commonly referred to as “graininess” or “scintillation.” This situation is similar to television reception with a weak signal. The picture quality will remain poor until the signal (illumination) becomes stronger.

LLL is currently defined by Marine Aviation Weapons and Tactics Squadron One (MAWTS-1) as 0.0022 lux. Lux is a measurement of illuminance, or light generated from a source. The moon, in the case of NVG operations, is considered a source of light. A 20 % moon disk positioned 30° above the horizon equates to 0.0022 lux. On an overcast, moonless night the sky still provides 0.0001 lux of illumination. Lux levels can be obtained from the SLAP program. While the light levels provided by SLAP are based purely off moon phase and position, the moon is not your only source of light. As covered, light levels will be increased with the addition of starlight or cultural lighting.

NVG brightness remains constant from full moon down to approximately quarter moon illumination through activation of the NVGs’ ABC. As light level decreases below quarter moon, NVG image brightness will decrease until the ABC is at maximum gain.

When a bright light source enters the NVG FOV, BSP will be activated to reduce gain, therefore making it difficult to see anything but the light source. Visibility is further degraded by the “blooming effect” around the light source. Blooming occurs because electrons from the photocathode “bleed over” into neighboring channels of the MCP and appear as coming outside of the halo circle. These effects become much more significant in LLL conditions. One should take this into consideration when conducting mission planning.

## 810. NVG MANEUVERS

Introductory NVG flight is conducted to familiarize the student with techniques and procedures of helicopter NVG operations. Students will be introduced to navigation, low work, and normal and steep approaches utilizing NVGs. The maneuver profiles are very similar to those in the Contact stage. The most significant difference is the use of the NVG scan.

### NVG SCAN PATTERN

*At altitude, scan will depend on ambient conditions, similar to unaided flight. On a clear, moonlit night, spend the majority of time looking out towards the horizon and down to the terrain. It is essential to have an active scan because your peripheral vision is not as effective on NVGs. Avoid the tendency to fixate by scanning slowly across your full visual limits (field of regard). Rapid head movements may cause disorientation. On hazy and LLL nights, the need for a more vigilant instrument backup cannot be overemphasized. The instrument backup scan is done by looking underneath the goggles onto the instruments. Instruments are not to be read through the goggles because the NVGs will be focused to infinity.*

During instrument flight, the pilot's scan moves between rate and position instruments. Similarly, the NVG scan must move between various locations and objects to provide sufficient information to the PAC. In the TH-57 the primary locations of the NVG scan can be described as:

1. Forward through the windscreen.
2. Laterally. This scan is extremely important in determining closure rates when taxiing or on final approach once the airspeed indicator becomes unreliable:
  - a. 45 degree position (left or right), roughly equivalent to looking between the egress handle and the glare shield on either side of the cockpit.
  - b. Abeam the helicopter, through the window in the left or right cockpit doors (this may be referred to as scanning "over the shoulder").

A correctly performed NVG scan coupled with an effective basic instrument scan is the foundation of NVG flight.

### LIGHT DEMONSTRATION

A demonstration of the effects of various aircraft lighting on NVGs should be conducted on a student's first NVG flight. The purpose of this demonstration is to display the positive and negative effects of all internal/external lighting configurations and intensities. The student should also be introduced to the effects of compatible and incompatible light sources from other aircraft, the airfield and the surrounding area.

**NOTE**

Do not assume personnel operating without NVGs in and around taxiing helicopters are capable of detecting hazards with the same level of SA as can be attained with NVGs.

**VERTICAL TAKEOFF****Maneuver Description**

A vertical takeoff enables the pilot to transition from the ground to a hover.

**Application**

Vertical takeoff procedures are the same as those done in day or night unaided flight with the addition of the NVG scan.

**Procedures**

The same as day contact but utilizing a vigilant NVG scan to maintain position of the aircraft over the ground.

**Amplification and Technique**

1. The NVG scan should be forward on the horizon moving to the 45 degree position on the flying pilot's side in order to prevent fore/aft and sideward drift.
2. Scan forward to the horizon, then along the 45 degree position and back along the 45 degree position to maintain position.
3. If searchlight or landing light is being used, an unaided scan down through the chin bubble can be utilized in addition to the NVG scan. However, the use of the searchlight or landing light will negatively affect the performance of the goggles.

**Crew Resource Management**

PAC scans outside the aircraft as PNAC scans instruments while backing up PAC for drift and altitude corrections. Example: PNAC voices "*Drifting Left*", PAC responds "*Roger Correcting*" while making appropriate control inputs.

**Common Errors and Safety Notes**

1. Failure to move the NVG scan in a proper or vigilant manner.
2. NVG scan fixation too close to the helicopter.

3. Failure to neutralize the cyclic prior to ascending causing forward, aft or lateral drift resulting in an erratic ascent.
4. Rushing initial takeoff.
5. Failure to maintain constant heading.

## **HOVERING**

### **Maneuver Description**

Hovering is a maneuver in which the helicopter is maintained in nearly motionless flight over a reference point with constant heading and altitude.

### **Application**

Hovering allows the crew to evaluate performance of the aircraft and readiness for further flight. Also, it enables the loading or unloading of cargo/passengers where landing cannot be made (fast roping, mountainous/uneven terrain, vertical replenishment or helicasting).

### **Procedures**

1. Use same control inputs for hovering on NVGs as those used during unaided day or night hovering.
2. Utilize smooth corrections/control inputs and a more vigilant scan.

### **Amplification and Techniques**

1. The PAC must scan between several reference points to detect drift.
2. Reference points should be stationary objects such as bushes, trees, rocks and should include both objects close to the aircraft and out to the treeline and horizon.
3. To detect fore/aft drift, scan to a reference point abeam or 45 degree position.
4. To detect lateral drift, scan to a reference point forward.
5. To determine hover altitude, the horizon should bisect the NVG image when scanning to the front of the aircraft. The PNAC may assist by reporting altitudes over the ICS from the radar altimeter.
6. Control hovering altitude and attitude with small, smooth, and slow corrections.
7. The PNAC should check gauges, caution lights and fuel prior to and during the initial hover.



8. Select easily identifiable reference points available at the training site.
9. At 5 feet hover height, the needle on the radar altimeter will partially obscure the zero on the display.

### **Crew Resource Management**

PAC scans outside the aircraft while PNAC scans instruments, backing up PAC for drift and altitude corrections. Example: PNAC voices “*Drifting Left*”, PAC responds “*Roger Correcting*” while making appropriate control inputs.

It is important that the PNAC maintains a partial NVG scan in order to detect aircraft drift or motion not recognized by the PAC.

### **Common Errors and Safety Notes**

1. Improper NVG scanning techniques (e.g., slow scan, fixation and scanning too far from the hover environment).
2. Failure to recognize spatial disorientation that may be caused by the 40° FOV.
3. Failure to maintain a constant hover altitude.
4. Erratic heading changes caused by over-controlling the rudder pedals.
5. Failure to recognize drift and to take corrective action.

### **WARNING**

Hovering/landing in open areas of grass, sand, or snow may be disorienting due to blowing grass, sand or snow, and the lack of a stationary reference point.

### **TURN ON SPOT/CLEARING TURN**

#### **Maneuver Description**

A turn on the spot is a maneuver in which the helicopter is rotated about its vertical axis while maintaining a position over a reference point.

#### **Application**

Turns on the spot and clearing turns enable the pilot to clear the area prior to each takeoff, to change the direction of taxi, and to improve his/her control coordination.

**Procedures**

Use the same control inputs for turns on the spot on NVGs as those used during day or night unaided while utilizing an NVG scan along the 45 degree position in the direction of turn. For example, when conducting a clearing turn to the left emphasize the scan to the aircraft's 10 o'clock position.

**Amplification and Techniques**

1. Tail rotor equipped helicopters tend to climb in a left turn on the spot and descend in a right turn. Anticipate these tendencies with collective to maintain a constant altitude.
2. Anticipate wind effects.
3. Utilize cues from aircrew, as necessary, for altitude and drift information.
4. To scan on the 45 degree position, look with the NVGs in an area on the windscreen between the egress handle and instrument glareshield on that side.

**Crew Resource Management**

PNAC aids the PAC as described for hovering and aids the PAC in clearing the aircraft and avoiding any obstacles.

**Common Errors and Safety Notes**

1. Improper NVG scanning techniques.
2. Excessive or erratic rate of turn, caused by over-controlling the rudder pedals.
3. Failure to maintain a constant altitude.
4. Failure to maintain position over the reference point.
5. Tendency to drift aft and up during clearing turns due to failure to scan in the direction of turn.

**WARNING**

Due to the limited NVG FOV and the increased effort required to scan the field of regard, the crew must make a vigilant effort to scan for obstacles while operating close to the ground to maintain proper clearance.

## NVG TRANSITION TO FORWARD FLIGHT

### Maneuver Description

The transition to forward flight enables the pilot to gain airspeed and altitude from a hover.

### Application

This maneuver enables the pilot to perform a safe transition from a hover to forward flight while minimizing time spent in the caution area of the height velocity diagram. Refer to the TH-57 NATOPS Part I, Chapter 4, Height Velocity Diagram.

### Procedures

1. From a stable hover, begin forward motion by displacing the cyclic.
2. Simultaneously, increase collective pitch with a smooth, positive pressure, maintain heading with tail rotor pedals and apply sufficient forward cyclic to enter translational lift.
3. As translational lift is reached, adjust flight controls to maintain the proper climb attitude.

### Crew Resource Management

1. PNAC reports “*Caution panel clear, gauges green, torque is \_\_\_%, clear \_\_\_*” on ICS prior to forward flight.
2. PNAC reports “*Three positive rates of climb, airspeed off the peg*” when appropriate.
3. PNAC reports “*200 feet clear left/right*” and then either “*smacks*” for operations at the OLF or “*landing light/searchlight off*” for takeoff from lighted airfields.

### Amplification and Techniques

1. Note MSL altitude of landing zone (LZ) / intended point of landing (IPL) and up-wind (run-in) heading to provide a reference for appropriate pattern checkpoints.
2. Maintain runway alignment until reaching 65 KIAS by using a visible reference point on the horizon directly in front of the helicopter.
3. An altitude over airspeed takeoff (similar to an ITO profile) is recommended to ensure that a positive rate of climb is established as the helicopter begins to accelerate.
4. **The primary scan for the PAC should be outside.**
5. The PNAC should scan outside and inside to provide the PAC with performance instrument readings, including VSI and nose attitude.

**Common Errors & Safety Notes**

1. Failure to establish aircraft in a 5 foot hover prior to transition.
2. Excessive forward cyclic resulting in a nose low attitude (> than 7 degrees nose down) and excessive power requirements.
3. Failure to anticipate “blowback” and trim nose attitude, causing the nose to pitch up.
4. Reducing power as the aircraft accelerates through translational lift, thus slowing the rate of climb.
5. Failure to select a reference point on the horizon to maintain ground track.
6. Failure to note zone altitude and reciprocal headings for pattern establishment.

**NVG NO HOVER TAKEOFF****Maneuver Description.**

The no hover takeoff enables the pilot to safely transition from the ground to forward flight while avoiding the dangers of white out/brown out conditions caused by loose snow or soil/sand.

**Application**

The no hover takeoff is an alternative to the vertical takeoff and normal transition to forward flight. It is employed during operations when takeoff visibility would be reduced due to blowing snow, soil/sand, or other particulate matter stirred up by the rotor wash generated by hover flight.

**Procedures**

1. In a hover, perform a clearing turn and land.
2. Trim the controls in the neutral position. Establish an NVG hover scan and smoothly raise the collective in a continuous pull until reaching 85% torque.
3. As the helicopter leaves the ground, apply forward cyclic to begin forward motion.
4. Maintain heading with pedals.
5. Maintain an outside NVG scan and continue to accelerate, gaining airspeed to reach translational lift as soon as possible while maintaining a safe ground clearance.

### Crew Resource Management

1. PNAC reports *"Caution panel clear, gauges green, torque is \_\_\_%, clear \_\_\_"* on ICS on the deck prior to takeoff.
2. PAC may request torque calls in 5% increments from PNAC.
3. PNAC reports *"Three positive rates of climb, airspeed off the peg"* when appropriate.
4. PNAC reports *"200 feet clear left/right"* and then either *"smacks on"* for operations at the OLF or *"landing light/searchlight off"* for takeoff from lighted airfields.

### Amplification and Technique

1. Neutralize the controls and check collective full down. Ensure twist grip is full open,  $N_r$  at 100%, and then establish a NVG scan.
2. Apply smooth, upward pressure on the collective. Do not hesitate or stop once collective pull has started until reaching maximum power "available" as rotor wash will quickly begin lifting debris into the air.
3. As collective is pulled, apply simultaneous forward cyclic and left pedal to transition into translational lift. This ensures whiteout/brownout conditions remain behind the aircraft. Maintain heading with pedals. The rate of forward cyclic application must be slow to prevent an excessive nose low attitude and aircraft settling when in close proximity to the ground.
4. Maintain 85% torque until 200 feet AGL.

### Common Errors and Safety Notes

1. Failure to neutralize controls prior to takeoff.
2. Failure to maintain heading.
3. Failure to maintain a positive and constant collective pull until reaching 85% torque allowing the helicopter to drift close to the ground increasing the likelihood of brownout/whiteout or dynamic rollover.
4. Failure to apply sufficient forward cyclic to stay ahead of the rotor wash.

### NVG APPROACHES

#### Maneuver Description

NVG approaches whether normal or steep enable a pilot to transition to hover or no hover landing over a specific point. The approach is designed around landing under low light level

(LLL) conditions with no visible horizon (ie: shipboard landings or expeditionary landing zones). Because of the limited visual cueing provided during an NVG approach, this can be one of the more difficult procedures to execute in a helicopter. It is therefore paramount to establish good CRM and employ solid procedural knowledge during NVG landings.

## **NVG NORMAL APPROACH**

### **Application**

The normal approach is a transition maneuver which allows the helicopter to arrive simultaneously at zero groundspeed and hover altitude over a preselected spot with a maximum margin of safety. It is designed to minimize the amount of time spent in a flight envelope where the probability of a safe autorotation is questionable.

### **Procedures**

1. On downwind, utilize a VFR scan backed up with a basic instrument scan, maintain 500 feet AGL, 70 KIAS on downwind.
2. At the 180° position, lower the collective and begin a descending, decelerating turn towards the 90 degree position. Maintain balanced flight.
3. Arrive at the 90° position with 300 feet AGL and 60 KIAS and begin to transition to primarily an NVG scan from the basic instrument scan.
4. Intercept the courseline by 150-200 feet AGL with 45-55 KIAS and sufficient straightaway (600 to 800 feet) to intercept the glideslope. Establish crosswind corrections, as necessary.
5. At 150 feet AGL, set the appropriate decel attitude and adjust the collective to maintain a constant glideslope between 10 and 20 degrees and scan abeam or 45 degree position with the NVGs to gauge closure rate several times on final.
6. Arrive over the spot at either; hover altitude, hover power and zero groundspeed simultaneously or continue to a no hover landing, or a no hover landing.

### **Crew Resource Management**

1. PAC may request PNAC to call the abeam position.
2. PNAC backs up PAC by calling out altitudes and airspeeds from the 90 degree position onward, emphasizing the altitudes and airspeeds on short final.
3. PNAC reference VSI to ensure descent rates are not excessive call for a wave-off if VSI indicates greater than 800 fpm.

4. PNAC secures anticollision light at 200 feet AGL when operating at an OLF or confirms landing light, searchlight and position lights are on per the RWOP.
5. PNAC should be prepared to assume controls in the event of goggle failure or vertigo/disorientation.

### **Amplification and Technique**

1. During an NVG approach, the basic instrument scan augments your VFR scan on the downwind until reaching the 90 degree position.
2. The “*pause*” portion of “*power, pedal, pause*” is used to ensure a 500 fpm rate of descent is established.
3. The PAC will have to shift the focus between an NVG scan towards the spot and a basic instrument scan to maintain a coordinated turn to arrive on final in the appropriate position through the 90 degree position.
4. Once on final, PAC utilizes an NVG scan to the abeam or 45 degree position and forward of the aircraft to determine closure rate and maintain line up with the intended point of landing. The PNAC can remind the PAC to scan abeam for closure rate once airspeed is below 40 KIAS.
5. As the aircraft closes with the spot, the PAC may want to shift the scan from the abeam and forward to the 45 degree position and forward as more scene detail becomes available closer to the intended point of landing.
6. At approximately 75 feet AGL, the glareshield may start to cover the bottom of the landing spot and will eventually cover all of the intended point of landing. PAC should utilize a forward and 45 degree NVG scan utilizing other visual references to close with the spot.
7. At approximately 50 feet AGL, pendulum effect occurs as power is increased to arrest rate of descent. Expect to push nose forward to maintain skid level attitude.

### **Common Errors and Safety Notes**

1. Improper entry altitude and airspeed, especially at the 180° position.
2. Not establishing a 500 fpm rate of descent at the 180° position.
3. Failure to establish proper runway/LZ alignment, angling towards the spot or failing to account for winds.
4. Failure to properly establish a decelerating nose attitude resulting in either excessive airspeed on final or HOGE conditions.

5. Failure to scan to the abeam or 45 degree position resulting in excessive closure rate after intercepting the course line.
6. Improper NVG scan resulting in a shallow approach.
7. Failure to maintain a constant approach angle. Excessive nose up attitude below 50 feet AGL, not accounting for pendulum effect or the limited FOV of the NVGs.
8. NVG scan fixating to one side of the aircraft resulting in landing to the left/right side of the intended landing spot.
9. Landing short of the spot due to keeping the spot in the same position relative to the windscreen throughout the approach (aka "spotting the deck").
10. Arrival at the intended point of landing either above or below the 5 feet hover height.

## **NVG STEEP APPROACH**

### **Application**

The steep approach is a power-controlled, precision approach used when obstacles surround the intended point of landing preventing a normal approach glideslope or when a less dynamic, more closely controlled approach is required. The steep approach provides a secondary means of gauging closure rate by utilizing the shudder of the aircraft at translational lift. This is especially useful under low light conditions or landings with low terrain contrast or similar albedo.

### **Procedures**

1. Utilizing a basic instrument scan, maintain 500 feet 70 KIAS in the downwind.
2. Slightly beyond the 180° position lower the collective and begin a descending, decelerating turn towards the 90° position.
3. Arrive at the 90° position at 300 feet AGL and 60 KIAS and begin to transition to primarily an NVG scan from the instrument scan.
4. Stop the descent at 300 feet AGL and intercept the courseline (with 800-1000 feet of straight away) prior to the glideslope with 300 feet AGL and 45 KIAS. Establish crosswind corrections, as necessary.
5. Upon intercepting a 25 to 45 degree glideslope, smoothly lower the collective to initiate a positive rate of descent. Maintain glideslope, as the aircraft enters translational lift and begins to shudder. Coordinate cyclic and collective to ride the "burbles" down. Scan abeam or 45 degree position with the NVGs to gauge closure rate several times on final.
6. Terminate the approach in a hover or no hover landing.



**Crew Resource Management**

1. PAC may request PNAC to call the abeam position and 50 feet prior to reaching 300 feet AGL.
2. PNAC backs up PAC by calling out altitudes and airspeeds from the 90 degree position onward, emphasizing the altitudes and airspeeds on short final.
3. PNAC reference VSI to ensure descent rates are not excessive, call for a wave-off if VSI indicates greater than 800 fpm.
4. PNAC secures anticollision light at 200 feet AGL when operating at an OLF or confirms landing light and searchlight are on per the RWOP.
5. PNAC should be prepared to assume controls in the event of goggle failure or vertigo/disorientation.

**Amplification and Technique**

1. The amount of deceleration required to establish the helicopter on the glideslope will vary from day to day depending primarily on prevailing winds.
2. Appropriate glideslope can be determined as the point where the spot approaches the glareshield on final. Smoothly beginning the descent prior to the obscuration of the spot by the glareshield can aid in maintaining glideslope and orientation on final.
3. Coordination between the cyclic and the collective will keep the helicopter on the glideslope. The groundspeed is controlled with nose attitude and the rate of descent is controlled with the collective pitch control. Maintain a rate of closure such that excessive control inputs to stay on the glideslope can be avoided. Large control inputs close to the ground are undesirable, unnecessary and can be dangerous.
4. Translational lift can be achieved early on the approach and provide additional cueing for closure rate. Maintain translational lift on final with a smooth steady application of power and coordinated changes in nose attitude.
5. The glareshield will start to cover the landing spot. PAC should utilize a forward and 45 degree NVG scan utilizing other visual references to close with the spot.

**Common Errors and Safety Notes**

1. Improper entry altitude and airspeed, especially at the 180° position.
2. Not establishing a 500 fpm descent at the 180.

3. Failure to establish proper runway/LZ alignment, angling into the spot or failing to account for winds.
4. Failure to properly establish a decelerating nose attitude resulting in either excessive airspeed on final or HOGÉ conditions.
5. Failure to scan abeam or 45 degree position resulting in excessive closure rate after intercepting the course line.
6. Stairstepping the approach through uncoordinated application of power and cyclic.
7. Waiting too long for glideslope entry and approaching vertically on final.
8. Excessive descent rates resulting in inaccurate assessments of closure rate and aggressive collective application.
9. Failure to maintain a constant approach angle. Excessive nose up attitude below 50 feet AGL, not accounting for pendulum effect or the limited FOV of the NVGs.
10. NVG scan fixating to one side of the aircraft resulting in landing to the left/right side of the intended landing spot.
11. Landing short of the spot due to keeping the spot in the same position relative to the windscreen throughout the approach (aka “spotting the deck”).
12. Arrival at the intended point of landing either above or below the 5 feet hover height.

### **WAVE-OFF – POWER ON**

#### **Maneuver Description**

The wave-off procedure remains the same as described in the Contact FTI. However there are crew resource management considerations for waving off an approach on NVGs.

#### **Crew Resource Management**

1. PAC or PNAC initiates wave-off, using appropriate procedures, if uncomfortable with the maneuver or condition of landing zone is in doubt.
2. PAC initiates or PNAC calls for a wave-off, if glideslope becomes excessive and/or rate of descent exceeds 800 fpm at airspeed less than 40 KIAS.
3. PAC performs wave-off when a crewmember calls “*Wave-off.*”
4. PAC and PNAC ensure twist grip is positioned to Full Open.

5. PAC/PNAC monitors rotor rpm, TOT and Torque. (Situational Awareness)
6. PAC makes appropriate radio call, as required, upon establishing positive rate of climb and balanced flight.
7. **PNAC ensures ANTI-COLLISION light is turned back on if secured prior to wave-off while operating at OLF.**

## 811. NVG NAVIGATION

### 1. NVG Map Selection Considerations

Initial steps in planning preparation should include assembling maps and imagery. In the Advanced Helicopter Training syllabus, the Joint Operations Graphic (JOG) (AIR) will be the primary maps for NVG navigation. Below is a list of maps and other planning tools you may see here and in your future squadrons. Utilize the procedures covered in the FTI for Low Level Navigation.

#### a. **Joint Operation Graphic (JOG)**

The JOG (either 1501 JOG-ground or the 1501A JOG-air) is a 1:250,000-scale map that is normally the primary map for planning and flying the enroute portion of a mission. The JOG is configured with both latitude/longitude markings and UTM grid.

#### b. **Chart Updating Manual (CHUM)**

The Chart Updating Manual (CHUM) is a supplementary publication, with bulletins published quarterly, that can be consulted for the most current information on potential low level hazards; towers, power lines, etc. An electronic CHUM is available through PFPS and through the ECHUM website, currently located at the National Geospatial-Intelligence Agency (NGA) NIPRNet Website. The NGA NIPRNet site, in accordance with a number of DoD directives, is Public Key Enabled (PKE); meaning that the site is encrypted using the DoD Public Key Infrastructure (PKI). Directions for registering for access and for accessing the NIPRNet site are available at:

<https://www1.nga.mil/ProductsServices/Aeronautical/echum/Pages/default.aspx>

NGA NIPRNet Website URL:

<https://aero.geointel.nga.mil/products/webchum/index.cfm>.

### 2. NVG Mission Planning

#### a. **Route Selection**

To help offset difficulties encountered in navigating on NVGs, routes should be planned to be as simple as tactically allowable, preferably in straight lines between

checkpoints. The following proven specifics are provided as guidelines for NVG route selection.

- i. Cultural Area Considerations
  - (a). Avoid large areas of cultural lighting due to increased halo effect and goggles degaining with the end result of loss of scene detail.
  - (b). Anticipate wires, including parallel sets, near roads, towers, and buildings isolated in open fields. Look for associated posts, poles, and stanchions. Flight directly over the poles will aid in obstacle clearance. Unexplained linear cuts in vegetation are also useful in locating wires.
  - (c). Towers may be used for orientation purposes. Avoid towers and do not use them as checkpoints. Towers may be lit with bright lights or LED lights, and may degrade the NVG's capabilities or may not be seen, respectively
- ii. Solar and Lunar Considerations
  - (a). Plan to transit large valleys on the illuminated side with respect to the moon's position. This will avoid shadows cast off terrain by the moon that silhouette terrain features for navigation.
  - (b). Avoid a route that heads directly into a low rising or setting moon/sun. If the timing of the launch forces this condition, plan to proceed in a zigzag advance across the route of flight using an approximate 30° offset to either side. This technique should help to counter the degrading influence of either the moon or sun on the NVGs.

**b. Checkpoint Selection**

After a general route has been determined, checkpoints to control movement along the route must be selected. In selecting checkpoints, the following areas should be considered:

- i. Checkpoints should be easily identifiable from the air.
- ii. Checkpoints should contrast with surrounding terrain by shape, size, color, or elevation.
- iii. If possible, checkpoints should not be selected near metropolitan areas, since they invariably grow and may alter the checkpoint or make its detection difficult.

- iv. When possible, a checkpoint should be easy to confirm by association with adjacent prominent features to alert the pilots to its location, i.e., limiting and funneling features.
  - v. Moon percentage, elevation, and azimuth throughout the course of the flight must be considered. Checkpoints should not fall within the shadow cast by a terrain feature.
  - vi. Select prominent limiting features near checkpoints, particularly where a turn is planned. The limiting feature is used to alert the pilot he has overflowed a checkpoint. It is often better to discard a prominent (e.g., easily identifiable) checkpoint with no limiting feature in favor of a less prominent checkpoint with a solid limiting feature.
  - vii. Make note of the MSL altitude of each checkpoint during planning to aid in checkpoint confirmation when flying in mountainous or hilly terrain.
  - viii. Select intermediate reference points between checkpoints to ensure course confirmation and route timing. The lower the ambient light level, the more intermediate the reference points should be used.
  - ix. The first and last checkpoints of a route are the most important. An easily identifiable feature must be utilized for both of these, even if a route must be altered slightly.
- c. **Mission Brief**

Utilize the briefing card from the low level navigation syllabus. There are minor additions and changes to what needs to be covered due to using NVGs. These items are outlined below.

Orientation: All SLAP data information will be briefed with the weather brief.

Situation: No change.

Mission: No change.

Execution: Utilize the “N” in FALCON to cover NVG considerations for each checkpoint and leg of the route. Possible NVG considerations include:

- i. Effects of moon position on course and checkpoints
- ii. Describe cultural lighting and its effects.
- iii. Any impact shadows have on navigation or safety of flight

- iv. Terrain contrast/albedo along route legs or at checkpoints
- v. Effects of weather on NVG performance
- vi. Use a Landing Zone (LZ) Diagram to brief landing zone operations along with NVG considerations.

#### NOTE

See Appendix D for a sample LZ Diagram.

Coordinating Instructions: When briefing the IIMC plan list the five characteristics of the presence instrument meteorological conditions when using NVGs.

#### Common Errors

- i. Failure to follow chart preparation instructions.
- ii. Lack of preparation and failure to rehearse the brief or conduct a proper map study.
- iii. Failure to properly setup the briefing space or “preflight” briefing equipment.
- iv. Lack of eye contact with the audience or excessive movement in front of the audience.
- v. Setting up an incorrect timeline for the flight, two identical take-off times, or incorrect take-off times.
- vi. Failure to mention NVG considerations (including SLAP and NVG terminology) along the route of flight.
- vii. No mention of radio frequency or squawk changes along route.
- viii. Failure to brief operations at the LZ or OLF, along with appropriate NVG considerations.
- ix. Incorrect Bingo calculations or calculated to a closed fuel source or calculated incorrectly.

#### d. **Mission Execution**

Advanced Helicopter Training NVG syllabus flights are flown at relatively higher altitudes and should be planned at 100 knots. NVG navigation is executed with the same basic rules as during the day. Due to a limited FOV and difficulties in determining altitude and airspeed, all aspects of NVG flight require more time and a more deliberate thought process. A common tendency among aviators is to overfly

the capabilities of the goggles. Excessive airspeed does not allow adequate time to mentally process the visual cues provided by the NVGs. Consideration should be given to planning low level NVG flights at slower airspeeds.

Pilots also tend to fly lower due to the decreased visual acuity. Often times, pilots will descend along a route without realizing because of the inability to make out details of ground features. For instance, one may subconsciously say, *“I normally have to be at 400 feet to see that tree clearly so I must be at 500 feet since I can’t make it out.”* This causes the pilot to descend lower in order to gain visual acuity when the aircraft may have actually been at 400 feet to see that tree clearly so I must be at 500 feet since *“I can’t make it out.”* This causes the pilot to descend lower in order to gain visual acuity when the aircraft may have actually been at 400 feet initially. This illusion is harder to avoid in environments with fewer terrain features or in a LLL environment. In either case, it is important to set and scan your RADALT.

### **Crew Resource Management**

- i. PAC utilizes primarily an outside scan.
- ii. PNAC is primarily responsible for navigation and backing up the PAC.
- iii. PNAC is responsible for all radio & squawk switchology to include radio calls.
- iv. Either pilot can call for power in an unsafe situation.
- v. PNAC should be directive then descriptive when providing navigational inputs to the PAC.

### **Amplification and Technique**

- i. PNAC gives a clock code position for a turn and then calls for a rollout once on correct heading.
- ii. PNAC can provide PAC with an aim point in the distance or on the horizon to aid with aircraft heading.
- iii. Utilize the 6Ts or modified 6Ts at each checkpoint as a memory aid for timing checks, radio calls, etc.
- iv. PNAC aids PAC by describing the checkpoint and/or important features along the route that PAC should be looking for or aware of.
- v. Placing frequency or squawk changes on the chart near the appropriate checkpoints can serve as a memory aid when reaching that area.

**Common Errors**

- i. PNAC not calling out clock codes, rollout headings or providing direction to the PAC.
- ii. Failing to initiate CTAF calls or switch to the appropriate frequency.
- iii. Not having the appropriate charts for navigation.
- iv. Failure to utilize good limiting and/or funneling features to identify checkpoints.
- v. Failure to utilize NVG considerations for checkpoint identification.
- vi. Improper or lack of planning that results in a route violating the RWOP, FAR AIM, FTI or read and initial guidance.
- vii. Failure to account for winds during the navigation phase, including its effects on groundspeed, overall timing and crab angle to maintain ground track.
- viii. Lack of or insufficient fuel and gauges checks along route specifically as it relates to Bingo fuel.
- ix. Failure to account for field closure.
- x. Utilizing only a lip light and failing to bring an NVG compatible light for reading the map or checklist.



**APPENDIX A  
GLOSSARY**

**A100. NOT APPLICABLE**

**THIS PAGE INTENTIONALLY LEFT BLANK**

**APPENDIX B  
FDLP/SHIP QUAL CARD**

<b><u>FDLP / SHIP QUAL CARD</u></b>		
EVENT S4101/4201		DATE _____
IP _____	STUDENT _____	
	STUDENT _____	
	STUDENT _____	
	STUDENT _____	
AIRCRAFT _____		
SPOT _____		
FDLP STUDENT	T/O TIME	LDG TIME
_____ 1 2 3 4 5 6	_____	_____
_____ 1 2 3 4 5 6	_____	_____
_____ 1 2 3 4 5 6	_____	_____
_____ 1 2 3 4 5 6	_____	_____
SHIP QUAL STUDENT	T/O TIME	LDG TIME
_____ 1 2 3 4 5 6	_____	_____
_____ 1 2 3 4 5 6	_____	_____
_____ 1 2 3 4 5 6	_____	_____
_____ 1 2 3 4 5 6	_____	_____
FREQS	NAVAIDS TAC VOR/LOC NDB	
APPROACH 119.0 / 286.0	NDZ 70x / 112.3 /	
APPROACH 124.85 / 385.4	PNS / 111.1 /	326
PNS TOWER 119.9 / 257.8	NUN / 108.8 /	
NPA TOWER 120.7 / 340.2	NPA 119x /	/
BAYLANDER / 280.35	IX-514 62x /	/
SANTA ROSA (Ch 11) / 361.1	CEW 106x / 115.9 /	
SPENCER (Ch 10) / 358.8	NGS 63x /	/
CHOCTAW TWR / 380.8		
EASTBAY (Ch 18) / 277.0		
BAYLANDER, EIGHTBALL / FACTORY HAND / LUCKY _____ SINGLE TH-57 (OR FLIGHT OF TWO) INBOUND _____ X+XX, _____ SOULS (EACH A/C) SWEET/SOUR LOCK, WILL REPORT "SEE YOU"		
<b>GEAR:</b> FULL LPU, MINIMUM OF EXTRA GEAR		
<b>LDG REQUIREMENTS:</b> (5) FDLPs, (5) SHIP QUALS + (1) W/O		
<b>LOG:</b> USN / USMC 1D3 / 1D4		<b>BINGO:</b>
USCG 1H3 / 1H4		
INT'L 1I3 / 1I4		
IP 1B3 / 1B4		

**THIS PAGE INTENTIONALLY LEFT BLANK**

## **APPENDIX C EMERGENCY PROCEDURES**

### **Lost Aircraft Communications**

1. In the event of lost communications, aircraft returns to home station or nearest shore facility as appropriate.
2. If landing aboard the ship is deemed essential, the appropriate lost communications procedures found in NAVAIR 00-80T-122 shall be utilized.
3. In the event of lost communications, ship's procedures include:
  - a. Attempt to gain voice communications on last assigned frequencies.
  - b. Attempt to communicate on appropriate emergency frequencies.
  - c. Request assistance of other surface or airborne units, if available.
  - d. Provide green deck for landing.

### **NOTE**

In IFR conditions, aircraft sounds heard by lookouts may be the only indication the aircraft is making an approach to the ship.

- e. Specific EMCON/lost comm visual signals from ship to aircraft and aircraft to ship in NAVAIR 00-80T-122 and aircraft NATOPS manual. They are posted and immediately available to those personnel assigned aircraft control responsibilities.
- f. Use any aid which could help the lost aircraft (vertical searchlights, starshells, black smoke, etc.).
4. In the event of lost communications, the ship expects the helicopter pilot to:
  - a. Attempt communications on assigned or emergency 243.0 (UHF frequency).
  - b. Squawk MODE 111 7600 or 7700 as appropriate.
  - c. Conserve fuel.
  - d. Return to home base or nearest shore facility as appropriate.
  - e. Climb to a higher altitude in VMC.

**THIS PAGE INTENTIONALLY LEFT BLANK**

**APPENDIX D  
SAMPLE LZ DIAGRAM**

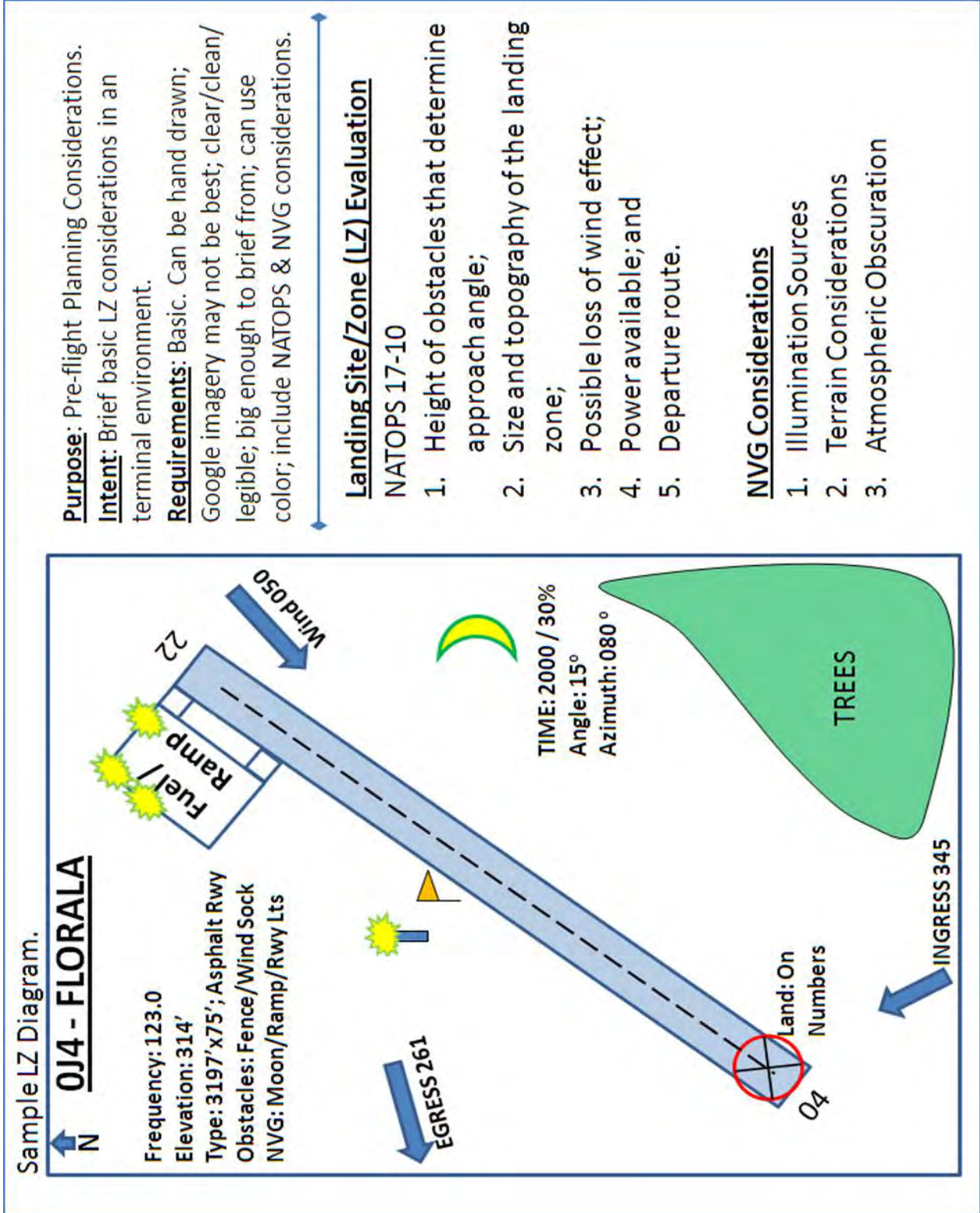

**THIS PAGE INTENTIONALLY LEFT BLANK**