

JOINT FLEET MAINTENANCE MANUAL**FOREWORD****LIST OF EFFECTIVE PAGES**

Page Numbers	Change in Effect	Page Numbers	Change in Effect
i	Change 5	FWD-B-7	Change 4
ii thru vi	REV C	FWD-B-8 thru FWD-B-14	Change 2
vii thru viii	Change 3	FWD-B-15	Change 4
ix	Change 1	FWD-B-16	Change 2
x	REV C	FWD-B-17	Change 3
FWD-1	Change 4	FWD-B-18 thru FWD-B-19	Change 2
FWD-2	Change 2	FWD-B-20	Change 3
FWD-3	Change 3	FWD-B-21 thru FWD-B-25	Change 2
FWD-4 thru FWD-6	Change 1	FWD-B-26	Change 5
FWD-7	Change 2	FWD-B-27	Change 2
FWD-8	REV C	FWD-B-28	Change 3
FWD-A-1	Change 3	FWD-B-29 thru FWD-B-37	Change 2
FWD-A-2	Change 2	FWD-B-38	Change 3
FWD-A-3 thru FWD-A-5	Change 3	FWD-B-39 thru FWD-B-41	Change 2
FWD-A-6	Change 5	FWD-B-42 thru FWD-B-43	Change 5
FWD-A-7 thru FWD-A-8	Change 3	FWD-B-44 thru FWD-B-46	Change 2
FWD-A-9 thru FWD-A-10	Change 5		
FWD-A-11	Change 4		
FWD-A-12	Change 3		
FWD-A-13 thru FWD-A-14	Change 4		
FWD-A-15	Change 2		
FWD-A-16	Change 4		
FWD-B-1	REV C		
FWD-B-2 thru FWD-B-3	Change 2		
FWD-B-4	Change 4		
FWD-B-5 thru FWD-B-6	Change 2		

(This Page Intentionally Left Blank)

JOINT FLEET MAINTENANCE MANUAL
FOREWORD
RECORD OF CHANGES

CHANGE NO.	DATE	TITLE OR BRIEF DESCRIPTION	ENTERED BY (INITIALS)

(This Page Intentionally Left Blank)

URGENT JOINT FLEET MAINTENANCE MANUAL CHANGE PROCESS

Purpose: To promulgate the process to be followed in the event that a requirement of the JFMM must be modified, cancelled or implemented prior to the next regularly scheduled change.

Process: The following process will be used to promulgate urgent changes to the JFMM

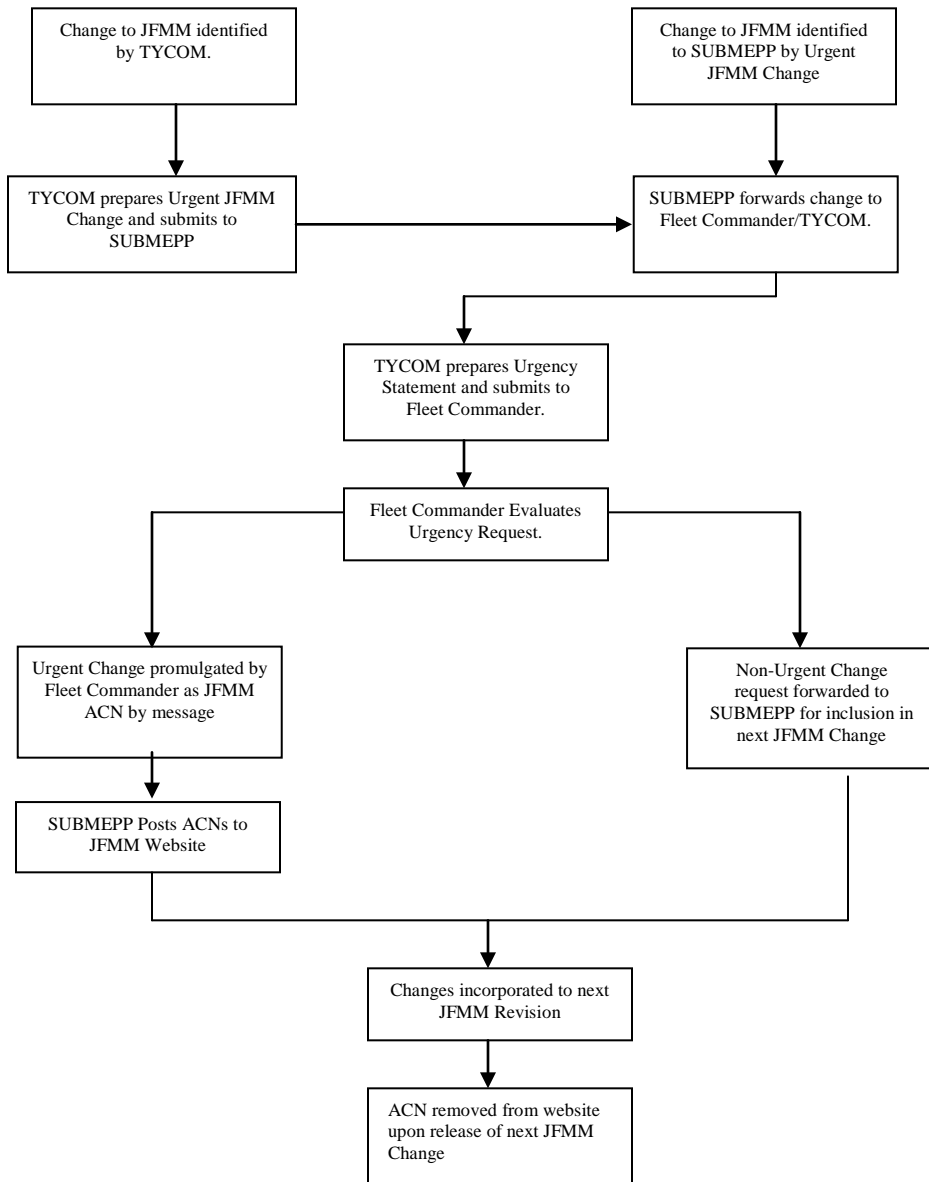

(This Page Intentionally Left Blank)

JOINT FLEET MAINTENANCE MANUAL CHANGE REQUEST FORM
<p>FROM: ACTIVITY/SHIP _____ E-MAIL ADDRESS _____ CODE/DEPT/SHOP _____ DATE _____ ORIGINATOR _____ TEL EXT () _____</p>
<p>VOL-PART-PARA NO. _____ FIGURE _____ TABLE _____ PROCESSING NORMAL _____ URGENT* _____ * (Justify in rationale below if urgent priority is marked and transmit via e-mail as "High Importance") PROBLEM DESCRIPTION:</p>
<p>RECOMMENDED CHANGE: (Include any proposed text addition/deletion)</p>
<p>RATIONALE:</p>

E-mail to PTNH.SUBMEPP.JFMMMGR@Navy.Mil

(If mailing, fold on dotted line on reverse side and mail to Submarine Maintenance Engineering, Planning and Procurement (SUBMEPP) Activity or send facsimile to (207) 438-6210.)

FOLD

Commanding Officer

OFFICIAL BUSINESS

Commanding Officer
Submarine Maintenance Engineering,
Planning and Procurement (SUBMEPP) Activity
Attn: Code 1832JM
P.O. Box 2500
Portsmouth Naval Shipyard
Portsmouth, NH 03804-2500

FOLD

JOINT FLEET MAINTENANCE MANUAL**FOREWORD****TABLE OF CONTENTS**

	Page No.
FOREWORD	
LIST OF EFFECTIVE PAGES	i
RECORD OF CHANGES	iii
URGENT JOINT FLEET MAINTENANCE MANUAL CHANGE PROCESS.....	v
JOINT FLEET MAINTENANCE MANUAL CHANGE REQUEST FORM.....	vii
1 Manual Development.....	FWD-1
2 Volume Topics.....	FWD-1
3 Purpose	FWD-1
4 Cancellation	FWD-1
5 Discussion.....	FWD-2
5.1 Platform Considerations	FWD-2
5.2 Maintenance Considerations.....	FWD-2
5.3 Terminology Considerations	FWD-2
5.4 Administrative Considerations	FWD-2
5.4.1 Master List of References.....	FWD-2
5.4.2 Table of Responsibilities	FWD-2
5.4.3 Acronyms	FWD-2
5.4.4 Appendices	FWD-2
5.4.5 Volume Structure	FWD-2
5.4.6 Digital Signatures	FWD-3
5.4.7 SKED 3.2 Electronic Signatures	FWD-3
6 Changes to the Manual	FWD-3
7 Life Cycle Maintenance Process for the Joint Fleet Maintenance Manual	FWD-3
7.1 Purpose	FWD-3
7.2 Background.....	FWD-3
7.3 Responsibilities and Requirements.....	FWD-3
7.3.1 Fleet Commanders	FWD-3
7.3.2 Type Commander.....	FWD-4
7.3.3 Naval Sea Systems Command.....	FWD-4
7.3.4 Joint Fleet Maintenance Manual Board of Directors	FWD-4
7.3.5 Submarine Maintenance Engineering, Planning and Procurement	FWD-5
7.3.6 Other Systems Commands	FWD-5
7.3.7 User Activities.....	FWD-5
7.4 Change Process.....	FWD-5
Appendices	
A Master List of References	FWD-A-1
B Responsibilities.....	FWD-B-1

(This Page Intentionally Left Blank)

JOINT FLEET MAINTENANCE MANUAL
FOREWORD

REFERENCES

- (a) SECNAVINST 5239.21 - Department of the Navy Electronic Signature Policy

LISTING OF APPENDICES.

- A Master List of References
B Responsibilities

1 MANUAL DEVELOPMENT. The development of the Joint Fleet Maintenance Manual has been a dedicated effort by all Naval Type Commanders to establish a single, unified source of maintenance requirements across all platforms.

2 VOLUME TOPICS. The Joint Fleet Maintenance Manual is made up of seven distinct volumes.

- | | | |
|------------|---|------------------------------|
| Volume I | - | New Construction |
| Volume II | - | Integrated Fleet Maintenance |
| Volume III | - | Deployed Maintenance |
| Volume IV | - | Tests and Inspections |
| Volume V | - | Quality Maintenance |
| Volume VI | - | Maintenance Programs |
| Volume VII | - | Contracted Ship Maintenance |

3 PURPOSE. This manual serves as:

- a. A standardized, basic set of minimum requirements to be used by all Type Commanders and subordinate commands.
- b. Clear, concise technical instructions to ensure maintenance is planned, executed, completed and documented within all Fleet commands.
- c. A vehicle for implementing Regional Maintenance policies across all platforms.
- d. A comprehensive set of process descriptions for use by schools such as Surface Warfare Officer School (SWOS), Senior Officer Ship Maintenance and Repair Course (SOSMRC), Engineering Duty (ED), Technical Training, etc.

4 CANCELLATION. The Joint Fleet Maintenance Manual supersedes all existing Type Commander Maintenance and Quality Assurance manuals and all associated correspondence and clarifications thereto. The following is a list of manuals that are cancelled as a result of this manual:

- a. COMNAVAIRLANTINST 4700.1/COMNAVAIRPACINST 4700.1 (Naval Air Force Ship Material Manual)
- b. COMNAVSURFLANTINST 9000.1 (Naval Surface Force, U.S. Atlantic Fleet, Maintenance Manual)
- c. COMNAVSURFPACINST 4700.1 (Naval Surface Force, U.S. Pacific Fleet, Maintenance Manual)
- d. COMSUBLANT/COMSUBPACINST 4790.4 (Submarine Force Maintenance Manual)
- e. COMNAVAIRLANTINST 9090.1/COMNAVAIRPACINST 9090.1 (Naval Air Force Quality Assurance Manual)
- f. COMSUBLANT/COMSUBPACINST 4855.2 (Submarine Force Quality Assurance Manual)
- g. COMNAVSURFLANT/COMNAVAIRLANTINST 4855.3/COMNAVSURFPAC/COMNAVAIRPACINST 4855.3 (Nuclear Surface Forces Afloat Quality Assurance Instruction)
- h. COMNAVSURFPACINST 4855.1 (Naval Surface Force, U.S. Pacific Fleet, Quality Assurance Manual)
- i. COMNAVSURFLANTINST 9090.1/COMNAVSURFPACINST 4855.22 (Naval Surface Force Quality Assurance Manual)
- j. COMNAVSURFLANTINST 9090.2 (IMA Quality Assurance Manual)

- k. CINCLANTFLT/CINCPACFLTINST 4355.1 (Quality Assurance Program)
- l. COMSUBPACINST 4855.3 (Deep Submergence Systems Quality Assurance Manual)

5 DISCUSSION.

5.1 Platform Considerations. Throughout this manual, certain requirements apply only to specific platforms. To point these out, the terms (Submarines only), (Aircraft Carriers only), (Surface Force ships only), and specific hull designators (e.g., DDG, SSN) are used in parentheses within the paragraph to which they apply. When no specific platform is mentioned, the requirements apply to all platforms. The term “ship” (alone) should be related to the context of the paragraph in which it is mentioned. The term “Submarine Force” applies to all ships under the responsibility of Submarine Forces, Atlantic and Pacific Fleets; the term “Aircraft Carriers” applies to all ships under the responsibility of Naval Air Forces, Atlantic and Pacific Fleets; and the term “Surface Force” applies to all ships under the responsibility of Naval Surface Forces, Atlantic and Pacific Fleets.

5.2 Maintenance Considerations. In the development of this manual, considerable effort was put forth to standardize work practices, incorporate accepted Regional Maintenance philosophies, and make allowances for future changes resulting from new Regional Maintenance policies. With respect to this, the term Intermediate Maintenance Activity (IMA) has been replaced by Fleet Maintenance Activity (FMA) operated by NAVSEA. Subsequently, the management of Regional Maintenance Centers and the Regional Maintenance Center function in the Naval shipyards has shifted to NAVSEA, but a Flag-level decision was made to maintain guidance for the Regional Maintenance Centers in this manual for continuity. Thus, Commander, Navy Regional Maintenance Center (CNRMC) and NAVSEA 04 representatives were invited to become members of the Joint Fleet Maintenance Manual Board of Directors (JFMMBOD) to address RMC and Naval Shipyard management/business issues associated with JFMM change requests.

5.3 Terminology Considerations. Use of the term “Type Commander/Immediate Superior in Command (TYCOM/ISIC)” throughout this manual is defined as follows:

- a. For Submarine and Surface Forces, the “TYCOM/ISIC” refers to the Squadron or Group.
- b. For Aircraft Carriers, the “TYCOM/ISIC” refers to the Type Commander for maintenance issues.
- c. For Submarine and Surface Forces, the term “ISIC”, used by itself, refers to the Squadron or Group. The term “ISIC” does not apply to Aircraft Carriers for maintenance issues, but refers to the Permanent Battle Group Commander for operational issues and non-maintenance certifications.

5.4 Administrative Considerations.

5.4.1 Master List of References. Appendix A of this foreword is a Master List of References used throughout the manual. This Master List should be reviewed to ensure that the necessary technical manuals, instructions, etc. are readily available prior to using the manual.

5.4.2 Table of Responsibilities. Appendix B provides a table of responsibilities associated with specific positions/functions located within the manual. Each position listed identifies the major responsibilities for that position and provides a link to the Chapter/paragraph where the responsibility is detailed.

5.4.3 Acronyms. Acronyms used in a particular volume are contained in the List of Acronyms at the front of each volume. Acronyms appearing four or more times in a chapter or those considered “common acronyms” (i.e., words that are known better by their acronym than by their spelled out word, for example, CD-ROM) will be spelled out the first time an acronym is used within a chapter, and the acronym listed in parentheses after the word. Terms not meeting these conditions will not be considered as acronyms within the text and the words will be spelled out.

5.4.4 Appendices. Numerous chapters throughout this manual contain Appendices for the purpose of providing further detail or examples of required reports/correspondence. In all cases the Appendices are intended as examples only and may not reflect the most current guidance or format. Higher authority source documents should be consulted. Sample correspondence provided as Naval messages may be communicated in letter format to facilitate timely transmission by electronic facsimile.

5.4.5 Volume Structure. Volumes II and V of this manual have been divided into specific parts. Volume II is made up of three parts. Part I contains requirements to implement and execute the management of an integrated maintenance process for all Navy ships. Part II defines a common validation, screening and brokering process, work package preparation process and work close out process for ship maintenance and modernization for all Navy ships

unless otherwise indicated. Part III provides procedures and guidance necessary to accurately allocate cost for work performed on or for Navy ships, ship classes or customer projects by Fleet Maintenance Activities (FMA). Volume V is made up of two parts. Part I contains requirements and procedures necessary to establish and maintain a Quality Maintenance Program. Part III contains requirements which apply to Scope of Certification for all ships and Deep Submergence Systems in the fleet.

5.4.6 Digital Signatures. Digital/Electronic signatures are authorized on all Forms and Quality Assurance Records. Electronic signatures will be in accordance with reference (a) and must be defined and approved for use by local instruction.

5.4.7 SKED 3.2 Electronic Signatures. Electronic disposition update or signature of a Maintenance Requirement Card (MRC) may be utilized by ships employing the latest version of SKED 3.2. When an individual updates the disposition of an MRC, which is the same as signing/dating an MRC completion on a 13-week Accountability Sheet, his/her name will be placed into the transaction log permanently recording the disposition update. Due to software engineering, once the updated MRC disposition is recorded (Completed, Not Applicable, etc.), the transaction record is not reversible (a permanent record). All Planned Maintenance System (PMS) assigned to a maintenance person is presented to that maintenance person immediately upon SKED 3.2 log-on. Therefore, when a ship is utilizing SKED 3.2 electronic disposition signatures, there is no need to print/sign the 13-week Accountability Form.

6 CHANGES TO THE MANUAL. A formal change process has been established for all seven volumes of the manual and is described in Figure 1. Users of this manual are encouraged to submit change requests. All change requests must be submitted using the Change Request Form contained in each volume. If changes are submitted in electronic format, facsimile or E-mail, each change request shall contain the information required on the Change Request Form. Your participation in this change process is both important and appreciated.

7 LIFE CYCLE MAINTENANCE PROCESS FOR THE JOINT FLEET MAINTENANCE MANUAL.

7.1 Purpose. To establish a management plan for life cycle maintenance of the Joint Fleet Maintenance Manual (JFMM). This plan describes the change process requirements and identifies the related responsibilities and requirements for maintaining all volumes of the JFMM.

7.2 Background. This manual was developed with the objective of providing a standard set of clear and concise maintenance requirements for the Fleet. The establishment of a formal life cycle maintenance process is necessary to ensure successful accomplishment of this objective. Utilizing a formal process will ensure effective coordination and management of the JFMM and will ensure:

- a. Standardized format for all change request responses.
- b. Timely evaluation and incorporation of change request.
- c. Automated tracking system for all review comments.
- d. Consistent distribution of all changes to the manual.
- e. A historical database containing all background information that led to changes and revisions to the JFMM.

7.3 Responsibilities and Requirements. This section defines the responsibilities and requirements of all activities involved in supporting the life cycle maintenance process of the JFMM.

7.3.1 Fleet Commanders. The Fleet Commanders are responsible for the following:

- a. Designating a single Commander, U.S. Fleet Forces Command (USFFC) and Commander, U.S. Pacific Fleet (PACFLT) point of contact to act as JFMM coordinators.
- b. Establishing a JFMMBOD. The JFMMBOD will be co-chaired by the Fleet coordinators and made up of TYCOM Quality Assurance and Maintenance representatives, the SUBMEPP JFMM Program Manager, NAVSEA 04 and CNRMC representatives.
- c. Providing final approval and promulgation letter for all JFMM changes and revisions issued to the Fleet.
- d. Providing funding for the life cycle maintenance of the JFMM.

- e. Approving all Advanced Change Notices (ACN), either by message or letter, for urgent changes to the JFMM. Develop and distribute all message ACNs. Forward all ACNs approved via letter to Submarine Maintenance Engineering, Planning and Procurement (SUBMEPP) for distribution.
- f. Convening periodic JFMMBOD review meetings. The purpose of these meetings is to review all proposed changes that may be incorporated into the manual in preparation of issuing an official change or revision to the manual.
- g. The Fleet, TYCOM or NAVSEA representatives may invite Subject Matter Experts (SME) to assist in answering proposed changes. The following rules apply for SMEs:
 - (1) All SMEs must have an advocate. The advocate will be one of the JFMMBOD members. For JFMMBOD members other than Fleet Commander representatives, a Fleet Commander member's concurrence for the SME to attend the JFMM Board of Directors Meeting is required. USFF and PACFLT will determine if other members shall be polled and notify SUBMEPP of the result. The advocate is responsible to ensure the SME complies with the established norms of the meeting.
 - (2) Access to the JFMM Electronic Change Website is generally limited to the Fleet Commanders, TYCOMs and NAVSEA representatives. **When necessary, other SMEs will be sent a proposed change for comment concurrent with member review, by email, outside of the electronic change website.** At the request of a member, an SME with a creditable need to know as determined by USFF and PACFLT may be granted limited access. Access is associated with individuals, not organizations or positions within organizations. Normally access will not be granted to individuals at commands subordinate to members.

7.3.2 Type Commander. The Type Commander (TYCOM) will:

- a. Review and evaluate all JFMM change requests within 21 calendar days of electronic posting for review, in order to provide users with timely responses.
- b. For changes which affect ship and personnel safety, notify Fleet Commanders and request a message ACN be distributed.
- c. For all other changes requiring ACNs, TYCOMs will review the ACN and forward to Fleet Commanders for approval.
- d. Review and endorse all change packages in preparation of issuing an official change/revision to the manual. Notify the Fleet Commanders of this endorsement via letter.
- e. Designate representatives to be members of the JFMMBOD.
- f. Identify changes to the JFMM distribution list.

7.3.3 Naval Sea Systems Command. NAVSEA will:

- a. Review and evaluate all JFMM change requests within 14 calendar days of electronic posting for review, in order to provide TYCOMs with timely input. If the complexity of the change will require more than 14 calendar days to complete the review, NAVSEA will notify the TYCOMs prior to 7 days of the due date for completing the review and include a new, expected completion date.
- b. For changes which affect ship and personnel safety, notify TYCOMs and request a message ACN be distributed.
- c. For all other changes requiring ACNs, NAVSEA will review the ACN and forward to TYCOMs.
- d. Designate one representative, each, from NAVSEA 04 and CNRMC to be members of the JFMMBOD to address Naval Shipyard and RMC management/business issues associated with JFMM change requests.

7.3.4 Joint Fleet Maintenance Manual Board of Directors. The JFMMBOD will:

- a. Adjudicate all JFMM change requests not unanimously resolved by TYCOMs.

- b. Continue collaboration to standardize maintenance requirements across platforms.
- c. Determine the frequency of official changes/revisions to the JFMM. The frequency of these changes/revisions may be dictated by the number of JFMM change requests submitted and approved.

7.3.5 Submarine Maintenance Engineering, Planning and Procurement. SUBMEPP will:

- a. Issue a letter of acknowledgment to the submitting activity when the change request is entered into the system.
- b. Perform a preliminary review of all JFMM change requests including an assessment of the impact on other volumes and provide background information and additional recommendations, when necessary, to applicable TYCOMs and NAVSEA within seven calendar days of receiving change request.
- c. Manage an automated tracking system for all JFMM change requests and provide a periodic status report of changes to the TYCOMs and Fleet Commanders.
- d. Incorporate approved changes into the JFMM and forward all change packages to the JFMMBOD for review in preparation of issuing an official change/revision to the manual.
- e. Develop all ACNs not requiring a message and forward to TYCOM for review. Distribute all ACNs approved by Fleet Commanders via letter.
- f. Forward any unresolved change requests to the JFMMBOD for adjudication.
- g. Maintain the JFMM distribution list.
- h. Support the TYCOM in the performance of customer surveys and audits, as requested.
- i. Adjudicate all editorial change requests (as defined in paragraph 7.4.b. of this foreword) with the Fleet Commander representatives on behalf of the JFMMBOD.
- j. Identify yearly budget requirements for life cycle maintenance of the JFMM to the Fleet Commanders.
- k. Attend all JFMMBOD Review Meetings.

7.3.6 Other Systems Commands. Other Systems Commands (SYSCOM) will:

- a. Provide technical evaluation for change requests when requested.
- b. Review JFMM revisions when requested.

7.3.7 User Activities.

- a. User Activities will submit change requests to SUBMEPP, using the required change request form contained in the manual and provide the following information on the change request form:
 - (1) A clear description of the problem including Volume number, Part Number, Chapter and applicable paragraph(s).
 - (2) The recommended change containing the specific text, table or figure to be added, deleted or modified.
 - (3) Rationale for the recommended change.
- b. When changes are promulgated to this manual, conduct a detailed review of all changes using the change synopsis. Training shall be conducted for all personnel whose work assignments may require them to be familiar with the requirements of this manual.

7.4 Change Process. This section defines the change process for the JFMM. The change process is an integral part of JFMM life cycle maintenance. The process is described in detail below and relates to the flow chart shown in Figure 1.

- a. All User Activities (e.g., FMAs, Squadrons, Ships Force, etc.), will submit JFMM change requests using the change request form located in the front of each volume of the manual.

- b. Upon receipt of this change request, SUBMEPP will send a letter to the original submitter notifying them that the change request has been received. SUBMEPP will log the change request into a database and conduct a preliminary review, assess the impact of the change on other volumes of the JFMM, gather all appropriate background information and provide additional recommendations when necessary. SUBMEPP will adjudicate all editorial change requests where an editorial change is generally limited to spelling, grammar or punctuation or, for example, where published office codes, Activity names/acronyms or website URLs have changed. For non-editorial change requests, SUBMEPP will determine the applicable TYCOM(s), and post them electronically for their review and approval. Change requests pertaining to Naval Shipyards and RMCs will also be posted electronically for NAVSEA 04 and CNRMC, respectively, to review before/concurrent with TYCOM review. Technical change requests will be posted for NAVSEA 05 and 05U7T (for Submarines) for technical review before/concurrent with TYCOM review. All change requests sent to TYCOMs after SUBMEPP review will include the following:
 - (1) Change Request Response Form.
 - (2) Appropriate reference material (e.g., previous change requests, applicable instructions, etc.).
 - (3) Applicable marked up pages showing the requested change incorporated.
 - (4) SUBMEPP's preliminary evaluation and recommendation, when applicable.
- c. TYCOMs will review the change request and provide a resolution to SUBMEPP electronically. NAVSEA 04 and CNRMC will review the change request for Naval Shipyard and RMC management/business process impact and provide input to SUBMEPP and TYCOMs electronically. NAVSEA 05 and 05U7T will provide technical evaluation for all technical change requests. Other SYSCOMs will provide technical assistance when requested. If the TYCOM should approve a change request and desire the use of an ACN, they will indicate this on the Change Response Form and provide any additional information for the ACN. For changes which affect ship and personnel safety, TYCOMs will notify Fleet Commanders when a message ACN is required. Fleet Commanders will develop and distribute all message ACNs. For all other ACNs, SUBMEPP will develop the ACN and submit the ACN to the TYCOMs for review. TYCOMs will forward the ACN to the Fleet Commanders for approval. Upon approval, SUBMEPP will distribute the ACN.
- d. SUBMEPP will forward all unresolved change requests to the JFMMBOD. An unresolved change request is a change request that does not receive unanimous approval or disapproval from all applicable TYCOMs.
- e. The JFMMBOD will adjudicate all unresolved change requests and will forward the resolution to SUBMEPP.
- f. SUBMEPP will provide a formal response to the original submitter based upon the TYCOM(s) or JFMMBOD final resolution.
- g. SUBMEPP will incorporate the approved change into a JFMM change package. This change package will contain both approved changes and ACNs incorporated into the applicable pages of the manual and will be sent to the JFMMBOD, for review in preparation of an official change/revision to the manual.
- h. The JFMMBOD will review this change package and make a recommendation to the Fleet Commanders regarding approval and promulgation.
- i. Fleet Commanders will provide final approval and promulgation letter for all JFMM changes and revisions. Fleet Commanders will forward promulgation letter to SUBMEPP.
- j. SUBMEPP will provide distribution of the approved JFMM change or revision according to the approved distribution list.

JOINT FLEET MAINTENANCE MANUAL CHANGE PROCESS

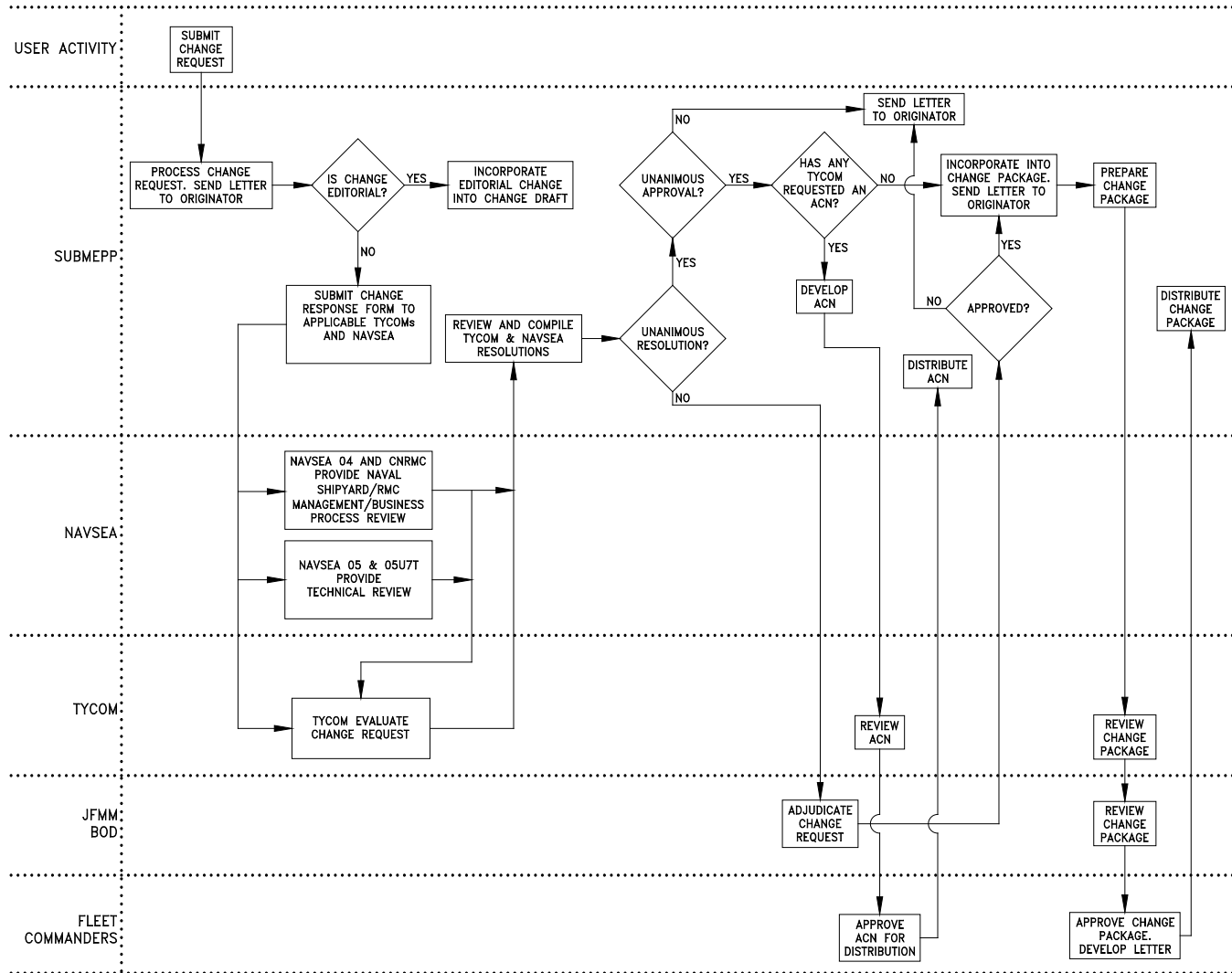

FWD-7

COMUSFLTFORCOMINST 4790.3 REV C CH-2

FIGURE 1

(This Page Intentionally Left Blank)

APPENDIX A
MASTER LIST OF REFERENCES

2M Marine Corps TM 5895-45/1B - Standard Maintenance Practices 2M Electronic Assembly Repair

5 CFR 2635 - Standards of Ethical Conduct for Employees of the Executive Branch

10 USC 1724 - Defense Acquisition Workforce Improvement Act (DAWIA)
10 USC 2306 - Kinds of Contracts
10 USC 7311 - Repair or Maintenance of Naval Vessels: Handling of Hazardous Waste

29 CFR 1910 - Occupational Safety and Health Standards

31 USC 1301(a) - Application
31 USC 1341 - Limitations on Expending and Obligating Amounts
31 USC 1342 - Limitation on Voluntary Services
31 USC 1349 - Adverse Personnel Actions
31 USC 1517 - Prohibited Obligations and Expenditures
31 USC 1518 - Adverse Personnel Actions
31 USC 1535 - Agency Agreements

41 USC 23 - Orders or Contracts for Material Placed with Government-owned Establishments Deemed Obligations
41 USC 254 - Contract Requirements

ABS Guide for Building and Classing High Speed Naval Craft (2007)

CNAFINST 3500.71 - Flight Deck Certification

CNAP/CNALINST 9210.4 - Nuclear Propulsion Note 9200-2

CNRMCIINST 4700.3 - Unplanned Events, Critiques and Trouble Reports
CNRMCIINST 4700.7 - Total Ship Readiness Assessment (TSRA)
CNRMCIINST 4700.9 - Availability Quality Management Plan (QMP) Standard Operating Procedure (SOP)
CNRMCIINST 4790.2 - Submarine Regional Maintenance Center (RMC) Fleet Technical Support (FTS) Roles and Responsibilities

CNSFINST 4020.1 - Motor Gasoline (MOGAS) Certification Program for L-Class Ships

COMFLTFORCOM 181810Z Mar 03 - Establishment of Regional Maintenance Centers

COMLANTFLTINST 3500.18 - Certification and Readiness of Aviation Facilities in Naval Ships Operating Aircraft
COMLANTFLTINST 4100.3 - Navy Energy Usage Reporting System (NEURS)
COMLANTFLTINST 4700.1 - Navy Afloat Maintenance Training Strategy (NAMTS) Job Qualification Requirements (JQR) Management
COMLANTFLTINST 5400.2 - U.S. Atlantic Fleet Regulations

COMLANTFLT OPORD 2000

COMNAVAIRFORINST 4700.23 - Aircraft Carrier Maintenance Support Centers (MSC) Policy and Procedures
COMNAVAIRFORINST 4790.1 - Commander Naval Air Forces Surface Maintenance and Material Management (3-M) System Manual
COMNAVAIRFORINST 4790.2 - Naval Aviation Maintenance Program
COMNAVAIRFORINST 9640.1 - Control of Habitability Improvements in Aircraft Carriers

COMNAVAIRLANTINST 3400.4 - Air Department Standard Operating Procedures
COMNAVAIRLANTINST 3500.20 - Aircraft Carrier Training and Readiness Manual
COMNAVAIRLANTINST 4790.34 - Electrostatic Discharge (ESD) Control Program
COMNAVAIRLANTINST 4790.40 - Aircraft Launch and Recovery Equipment Maintenance Program (ALREMP)
Management Teams
COMNAVAIRLANTINST 4790.42 - CV/CVN Intermediate Maintenance Activity (IMA) Module Test and Repair
Facility (MTRF)

COMNAVAIRLANTINST 9080.2 - Conduct of Trials and Inspections Incident to Construction, Overhauls or
Availabilities of Nuclear Powered Aircraft Carriers (CVN)
COMNAVAIRLANTINST 9090.2 - Conduct of Shipyard Trials and Inspections Incident to Service Life Extension
Program (SLEP), Overhauls or Availabilities of Conventionally Powered Aircraft Carriers

COMNAVAIRLANTINST 13650.1 - Individual Material Readiness List (IMRL) Program

COMNAVAIRPACINST 3400.4 - Air Department Standard Operating Procedures
COMNAVAIRPACINST 3500.20 - Aircraft Carrier Training and Readiness Manual
COMNAVAIRPACINST 4790.39 - Aircraft Launch and Recovery Equipment Maintenance Program (ALREMP)
Management Teams
COMNAVAIRPACINST 4790.54 - CV/CVN Intermediate Maintenance Activity (IMA) Module Test and Repair
Facility (MTRF)

COMNAVSEASYS COM WASHINGTON DC 03004Z FEB 09 - SISCAL Policy Guidance - Level 2 Calibrations
COMNAVSEASYS COM WASHINGTON DC 031440Z MAR 03 - Submarine Industrial EMC and EMI Control
Interim Guidance

COMNAVSUBFORINST C3500.2 - Continuous Training Manual
COMNAVSUBFORINST 5400.25 - Standard Submarine Supply Department Organization and Regulations Manual
COMNAVSUBFORINST 5400.29 - Standard Submarine Navigation/Operations Department Organization and
Regulations Manual
COMNAVSUBFORINST 5400.39 - Standard Submarine Organization and Regulations Manual (SORM)
COMNAVSUBFORINST 5400.40 - Standard Submarine Combat Systems Department Organization and
Regulations Manual (SSN)
COMNAVSUBFORINST 5400.41 - Standard Submarine SSBN 726 Class Weapons Department Organization and
Regulations Manual
COMNAVSUBFORINST 5400.47 - Standard Submarine Combat Systems Department Organization and
Regulations Manual (SSGN)

COMNAVSUBFOR OPORD 2000

COMNAVSURFLANTINST 3502.2 - Surface Force Training Manual
COMNAVSURFLANTINST 3540.18 - Engineering Department Organization and Regulation Manual (EDORM)
COMNAVSURFLANTINST 4400.1 - Surface Force Supply Procedures
COMNAVSURFLANTINST 4700.1 - Total Ship Readiness Assessment (TSRA)
COMNAVSURFLANTINST 4700.4 - Fleet Introduction Handbook

COMNAVSURFORINST 3120.1 - Zone Inspections
COMNAVSURFORINST 3540.1 - Engineering Operations Assessment, Training and Certification for
Conventionally Powered Surface Ships
COMNAVSURFORINST 3540.2 - Surface Force Engineering Readiness Process

COMNAVSURFPACINST 3501.4 - Aviation Readiness Evaluation (ARE) and Certification of Aviation Facilities
Onboard COMNAVSURFPAC Ships

COMNAVSURFPACINST 3502.2 - Surface Force Training Manual
COMNAVSURFPACINST 3540.13 - Engineering Department Organization and Regulation Manual (EDORM)
COMNAVSURFPACINST 4400.1 - Surface Force Supply Procedures
COMNAVSURFPACINST 4700.1 - Total Ship Readiness Assessment (TSRA)

COMPACFLTINST 4100.3 - Navy Energy Usage Reporting System (NEURS)
COMPACFLTINST 4700.5 - Navy Afloat Maintenance Training Strategy (NAMTS) Job Qualification Requirements (JQR) Management
COMPACFLTINST 4710.6 - Policy for Accomplishment of Ship Repair Work in WESTPAC
COMPACFLTINST 5400.3 - U.S. Pacific Fleet Regulations
COMPACFLTINST 9830.1 - Certification of Aviation Facilities in Naval Ships Operating Aircraft

COMPACFLTINST 4700.5/COMLANTFLTINST 4700.1 - Navy Afloat Maintenance Training Strategy (NAMTS) Job Qualification Requirements (JQR) Management

COMPACFLT OPORD 201

COMSEVENTHFLT OPORD 201

COMSUBFORINST 3500.22 - SSGN Operational Cycle, Training and Certification Management
COMSUBFORINST 4720.15 - Submarine C5ISR Modernization Policy
COMSUBFORINST C5400.30 - Engineering Department Organization Manual
COMSUBFORINST C5400.38 - Standard Submarine Organization and Regulations Manual (SSBN)
COMSUBFORINST C5400.39 - Standard Submarine Organization and Regulations Manual (SSN)
COMSUBFORINST C5400.48 - Standard Submarine Organization and Regulations Manual (SSGN)
COMSUBFORINST C9460.3 - Coordinated Submarine Radiated Noise Analysis

COMSUBLANTINST 3540.10 - Periodic Monitoring of Submarines and Support Facilities
COMSUBLANTINST 4406.1 - Submarine Supply Procedures Manual
COMSUBLANTINST 4419.1 - Module Screening and Repair Activity (MSRA) Repairables Management Procedure
COMSUBLANTINST 5400.4 - Submarine Force, U.S. Atlantic Fleet Regulations
COMSUBLANT/COMSUBPAC C3500.21 (Ser) - SSN Fleet Response Training Plan (FRTP) Management
COMSUBLANT/COMSUBPACINST 3502.1 - Submarine Force Internal Monitoring and Critiques
COMSUBLANT/COMSUBPACINST 6470.5 - Submarine Radiation Health Manual
COMSUBPACINST 3540.10 - Periodic Monitoring of Submarines and Support Facilities
COMSUBPACINST 4406.1 - Submarine Supply Procedures Manual
COMSUBPACINST 5400.7 - Submarine Force, U.S. Pacific Fleet Regulations
COMSUBPACINST C5400.30 - Engineering Department Organization Manual
COMSUBPACINST 9460.4 - Submarine Towed Array Operations

COMSUBLANTNOTE C3120 - Submarine Operating Restrictions and Depths Authorizations
COMSUBPACNOTE C3120 - Submarine Operating Restrictions and Depth Authorizations
COMSUBPACNOTE 9086 - COMSUBPAC Engineering Notes and Technical Notes

COMUSFLTFORCOM/COMPACFLTINST 3501.3 - Fleet Training Continuum
COMUSFLTFORCOMINST/COMPACFLTINST 4720.3 - Commander United States Fleet Forces Command (COMUSFLTFORCOM)/Commander Pacific Fleet (COMPACFLT) C5ISR Modernization Policy

CSL/CSPINST 9010.5 - Total Ship Readiness Assessment (TSRA)

DCAAM 7640.1, July 2004 Edition - DCAA Contract Audit Manual (CAM) Chapter 9-1004.2

DD Form 1638 - Report of Disposition of Contractor Inventory

DFARS 201.4 - Deviations From the FAR
DFARS 206.302-2 - Unusual and Compelling Urgency
DFARS 211 - Describing Agency Needs
DFARS 217.71 - Master Agreement for Repair and Alteration of Vessels
DFARS 217-7104 - Clauses
DFARS 219 - Small Business Programs
DFARS 222 - Application of Labor Laws to Government Acquisitions
DFARS 222.101 - Labor Relations
DFARS 245.301 - Definitions
DFARS 245.302 - Providing Facilities
DFARS 245.505 - Records and Reports of Government Property
DFARS 245.6 - Reporting, Redistribution and Disposal of Contractor Inventory
DFARS 245.608-70 - Contractor Inventory Redistribution System (CIRS)
DFARS 245.7001 - Selection, Appointment and Termination
DFARS 245.7002 - Duties and Responsibilities of Plant Clearance Officers
DFARS 252 - Solicitation Provisions and Contract Clauses
DFARS 252.217-7012 - Master Ship Repair Agreement (MSRA) Liability and Insurance
DFARS 252.217-7015 - Compliance With OSHA Regulations

DFARS Part 217 - Special Contracting Methods
DFARS Part 245 - Government Property

DoD Financial Management Policies and Procedures Regulation 7000.14-R – Volume 1, Chapter 9
DoD Financial Management Regulation 7000.14-R - Volume 4, Chapter 20
DoD Financial Management Regulation 7000.14-R - Volume 4, Chapter 21
DoD Financial Management Regulation 7000.14-R - Volume 12, Chapter 9
DoD 7000.14-R - Volume 14 - Administrative Control of Funds and Anti-Deficiency Act Violations
DoD Automation Resources Manual 7950.1-M
DoD Directive 5000.1 - The Defense Acquisition System
DoD Directive 5500.7 - Standards of Conduct
DoD Directive 7200.1 - Administrative Control of Appropriations
DoD Directive 7220.1 - Regulations Governing the Use of Project Orders
DoD Financial Management Policy Manual
DoD Manual 4161.2 - Manual for Performance of Government Property Administration
DoDINST 5000.2 - Operation of the Defense Acquisition System
DoD-STD-2003 - Military, Standard, Electric Plant Installation Standard Methods for Surface Ships and Submarines

FAR 4.802 - Contract Files
FAR 6.302-2 - Unusual and Compelling Urgency
FAR 9.1 - Responsible Prospective Contractors

FAR 11.104 - Use of Brand Name or Equal Purchase Descriptions
FAR 14.201-1 - Uniform Contract Format
FAR 14.204-1 - Records of Invitations for Bids and Records of Bids

FAR 42.2 - Contract Administration Services
FAR 42.201 - Contract Administration Responsibilities
FAR 42.3 - Contract Administration Office Functions
FAR 42.302 - Contract Administration Functions

FAR 45.102 - Policy
FAR 45.301 - Definitions
FAR 45.302 - Providing Facilities
FAR 45.303 - Providing Material
FAR 45.306 - Providing Special Tooling

FAR 45.307 - Providing Special Test Equipment
FAR 45.310 - Providing Agency Peculiar Property
FAR 45.4 - Contractor Use and Rental of Government Property
FAR 45.5 - Management of Government Property in Possession of the Contractor
FAR 45.6 - Scope of Subpart

FAR 52.232-16 - Progress Payments Clause
FAR 52.245-2 - Government Property (Fixed Price Contracts)
FAR 52.245-4 - Government-Furnished Property (Short Form)

FAR 203

FAR Part 1.3 - Agency Acquisition Regulations
FAR Part 1.4 - Deviations
FAR Part 1.6 - Career Development, Contracting Authority and Responsibilities
FAR Part 2.1 - Definitions
FAR Part 9 - Contractor Qualifications

FAR Part 14 - Sealed Bidding
FAR Part 15 - Contracting by Negotiation
FAR Part 16 - Types of Contracts

FAR Part 31 - Contract Cost Principles and Procedures

FAR Part 42 - Contract Administration and Audit Services
FAR Part 43 - Contract Modifications
FAR Part 44 - Subcontracting Policies and Procedures
FAR Part 45 - Government Property
FAR Part 46 - Quality Assurance
FAR Part 49 - Termination of Contracts

FAR Part 52 - Solicitation Provisions and Contract Clauses

Federal Acquisition Regulation (FAR)

Fleet Modernization Program (FMP) Management and Operations Manual - Revision 2
Fly-By-Wire Ship Control System Certification Boundary Book (ship specific)

FMP Manual Section 4-11 - Procedures for Ships Selected Records

INSURVINST 4730.1 - Material Inspections (MI) of Surface Ships
INSURVINST 4730.2 - Trials and Material Inspections of Submarines
INSURVINST 4730.3 - Trials of Surface Ships
INSURVINST 4730.8 - Reports of Trials, Material Inspections and Survey Conducted by INSURV
INSURVINST 4730.11 - Preparation of Deficiency Forms

Integrated Project Teams for Aircraft Carrier Maintenance Handbook

LPD 17 MOGAS System Technical Manual

Maintenance Index Page 4721/081 - Passive Countermeasure System (PCMS)

Maintenance Plan 4100-02-01 - Command and Control System (CCS) Electromagnetic Interference (EMI) Testing

MIL-HDBK-263 - Electrostatic Discharge Control Handbook for Protection of Electrical and Electronic Parts, Assemblies and Equipment

MIL-HDBK-773 - Electrostatic Discharge Protective Packaging

MIL-S-24340 - Polyurethane (Polyether Base) Deck Sealing Compound

MIL-STD-130 - Identification Marking of U.S. Military Property

MIL-STD-413 - Visual Inspection Guide for Elastomeric O-rings

MIL-STD-438 - Schedule of Piping, Valves, Fittings, and Associated Piping Components for Submarine Service

MIL-STD-767 - Cleaning Requirements for Special Purpose Equipment, Including Piping Systems

MIL-STD-777 - Schedule of Piping, Valves, Fittings, and Associated Piping Components for Naval Surface Ships

MIL-STD-792 - Identification Marking Requirements for Special Purpose Components

MIL-STD-1330 - Standard Practice for Precision Cleaning and Testing of Shipboard Oxygen, Helium, Helium-Oxygen, Nitrogen and Hydrogen Systems

MIL-STD-1388 - Logistic Support Analysis

MIL-STD-1625 - Safety Certification Program for Drydocking Facilities and Shipbuilding Ways for U.S. Navy Ships

MIL-STD-1627 - Bending of Pipe or Tube for Ship Piping Systems

MIL-STD-1680 - Installation Criteria for Shipboard Secure Electrical Information Processing Systems

MIL-STD 1686 - Electrostatic Discharge Control Program for Protection of Electrical and Electronic Parts, Assemblies and Equipment

MIL-STD-1689 - Fabrication, Welding and Inspection of Ship's Structures

MIL-STD-3034 - Reliability-Centered Maintenance (RCM) Process

MIL-STD-2039 - Field Changes and Field Change Kit Preparation

MIL-STD-2041 - Control of Detrimental Materials

MIL-STD-2132 - Nondestructive Examination Requirements for Special Applications

MS 6310-081-015 - Submarine Preservation

N6-NTSP-S-70-8003 - Navy Training System Plan (NTSP) for Electromagnetic Interference (EMI) Control

NASM 7838 - Bolts, Internal Wrenching

National Archives and Records Administration General Records Schedules, General Records Schedule 8 - Stores, Plant and Cost Accounting Records

National Fire Protection Association Codes and Standards 306 - Standards for the Control of Gas Hazards on Vessels

NAVAIR 00-25-100 - Naval Air System Command Technical Manual Program

NAVAIR 01-1A-23 - Electronic Assembly Repair Standard Maintenance Practice

NAVAIR 13-1-6.1 - Aviation Crew Systems, Chapter 7 (LRU 13/A)

NAVAIR 17-15-99 - Operations and Maintenance O and I Level

NAVAIR 17-1-127 - Periodic Proofload Testing of Weapons Support Equipment W/IPB

NAVAIR 17-35MTL-1 - Metrology Requirements List

NAVAIR 17-35NCA-1 - Navy Calibration Activity (NCA) List

NAVAIR 17-35QAL-15 - Naval Aircraft Carrier and Amphibious Assault Ships Metrology and Calibration (METCAL) Program Manual

NAVAIR 17-600-193-6-1 - Pre-operational Check List

NAVAIR 17-600-193-6-2 - Periodic Maintenance Requirements Manual

NAVAIR AD-700A1-MDB-000 - Recovery Assistance Traversing (RAST) System
NAVAIR A6-332AO-GYD-000 - Laboratory and Aviators Breathing Oxygen Field Guide

NAVAIRINST 3120.1 - Lead Systems Command Procedures and Responsibilities for Certification of Aviation Facilities and Equipment in Naval Ships Operating Aircraft
NAVAIRINST 13640.1 - NAVAL Aviation Metrology and Calibration (METCAL) Program
NAVAIRINST 13800.11 - Procedures and Responsibilities for Certification and Verification of the Precision Approach and Landing System

NAVCOMPT Form 2168/1 - Expense Operation Budget
NAVCOMPT Form 2275 - Orders for Work and Services
NAVCOMPT Manual - Paragraph 035400-035452
NAVCOMPT Manual - Volume 2
NAVCOMPT Manual - Volume 3, Appropriation, Cost, and Property Accounting (Field)

NAVCOMPTINST 7000.38 - Productivity Enhancing Incentive Fund (PEIF)/The Productivity Enhancement Capital Investment Fast Payback Program

NAVEDTRA 10500 - Catalog of Navy Training Courses
NAVEDTRA 43241 - Personnel Qualification Standard for Ship's Maintenance and Material Management (3-M) System
NAVEDTRA 43523 - Personnel Qualification Standard for Quality Maintenance Program

NAVFAC Manual MO-322 - Inspection Guides, Structural, Mechanical and Electrical
NAVFAC P-307 - Management of Weight Handling Equipment
NAVFAC Technical Publication DM-29 - Drydocking Facilities

NAVICPINST 4355.5 - Receipt, Inspection, Storage and Issue of Level I/SUBSAFE Material
NAVICPINST 4441.170 - COSAL Use and Maintenance Manual

NAVORD OP 4 - Ammunition Afloat

NAVPERs 18068 - Manual of Navy Enlisted Manpower and Personnel Classifications and Occupational Standards

NAVSEA ACD 05T1-05 - PCMS Access, Material Control and Disposal Manual
NAVSEA ACD/J 05T1-05 - PCMS Access, Material Control and Disposal Manual (Japan)
NAVSEA CERT 05P1 - Passive Countermeasure System (PCMS) Regional Maintenance Center Certification Plan

NAVSEA Contracts Handbook (NCH) - Master Agreement for Repair and Alteration of Vessels
NAVSEA Contracts Handbook (NCH), Part 45 - Government Property

NAVSEA ltr - Ser 05T1/009 of 06 April 04, Passive Countermeasure System (PCMS) Waterfront Support Requirements for Regional Maintenance Centers
NAVSEA ltr - Ser 396A23/0641 of 25 June 93 - Trident Preservation Maintenance
NAVSEA ltr - Ser 92T124/006 of 14 Mar 02 - Preservation QA Requirements for In-Service Submarines

NAVSEA MS 6310-081-015 - Submarine Preservation
NAVSEA MS 7650-081-091 - Submarine Hull Inspection

NAVSEA OD 45845 - Metrology Requirements List (METRL)

NAVSEA OP-4 - Ammunition Afloat
NAVSEA OP 3347 - Ordnance Safety Precautions, U.S. Navy
NAVSEA OP 4098 - Handling Ammunition, Explosives and Hazardous Material with Industrial Materials Handling

Equipment

NAVSEA RIM 05T1-99 - PCMS Repair and Installation Methods

NAVSEA S-30-9412 - Passive Countermeasure System (PCMS) Naval Training System Plan

NAVSEA S9074-AQ-GIB-010/248 - Welding and Brazing Procedures and Performance Qualification

NAVSEA S9074-AR-GIB-010/278 - Requirements for Fabrication Welding and Inspection, and Casting Inspection and Repair for Machinery, Piping and Pressure Vessels

NAVSEA S9086-CH-STM-010 - NSTM Chapter 074 V1 (Welding and Allied Processes)

NAVSEA S9086-CH-STM-020 - NSTM Chapter 074 V2 (Nondestructive Testing of Metals, Qualification and Certification Requirements for Naval Personnel (Non-nuclear))

NAVSEA S9086-CH-STM-030 - NSTM Chapter 074 V3 (Gas Free Engineering)

NAVSEA S9086-CJ-STM-010 - NSTM Chapter 075 (Threaded Fasteners)

NAVSEA S9086-CM-STM-010 - NSTM Chapter 078 (Gaskets, Packing and Seals)

NAVSEA S9086-CN-STM-040 - NSTM Chapter 079 V4 (Damage Control; Compartment Testing and Inspection)

NAVSEA S9086-CQ-STM-010 - NSTM Chapter 081 R4 (Waterborne Underwater Hull Cleaning of Navy Ships)

NAVSEA S9086-CV-STM-010 - NSTM Chapter 086 (Command Technical Manual Management)

NAVSEA S9086-C4-STM-000 - NSTM Chapter 094 (Trials)

NAVSEA S9086-C6-STM-010 - NSTM Chapter 096 (Weights and Stability)

NAVSEA S9086-DA-STM-000 - NSTM Chapter 100 (Hull Structures)

NAVSEA S9086-GX-STM-020 - NSTM Chapter 220, V2 (Water Treatment)

NAVSEA S9086-GY-STM-010 - NSTM Chapter 221 (Boilers)

NAVSEA S9086-G1-STM-010 - NSTM Chapter 223, V1 (Submarine Storage Batteries - Lead Acid Batteries)

NAVSEA S9086-G3-STM-010 - NSTM Chapter 225 (Steam Machinery Controls Systems)

NAVSEA S9086-G9-STM-000 - NSTM Chapter 231 (Propulsion and SSTG Steam Turbines)

NAVSEA S9086-HB-STM-010 - NSTM Chapter 233 (Diesel Engines)

NAVSEA S9086-HC-STM-000 - NSTM Chapter 234 (Marine Gas Turbines)

NAVSEA S9086-HK-STM-010 - NSTM Chapter 241 (Propulsion Reduction Gears, Couplings, Clutches and Associated Components)

NAVSEA S9086-HN-STM-010 - NSTM Chapter 244 (Propulsion Bearings and Seals)

NAVSEA S9086-H7-STM-010 - NSTM Chapter 262 (Lubricating Oil)

NAVSEA S9086-KC-STM-010 - NSTM Chapter 300 (Electric Plant - General)

NAVSEA S9086-QN-STM-010 - NSTM Chapter 475 (Magnetic Silencing)

NAVSEA S9086-RJ-STM-010 - NSTM Chapter 504 (Pressure, Temperature and other Mechanical and Electromechanical Measuring Instruments)

NAVSEA S9086-RK-STM-010 - NSTM Chapter 505 (Piping Systems)

NAVSEA S9086-RQ-STM-010 - NSTM Chapter 510 (Heating, Ventilation, and Air Conditioning Systems for Surface Ships)

NAVSEA S9086-SP-STM-010 - NSTM Chapter 542 (Gasoline and JP-5 Fuel Systems)

NAVSEA S9086-SX-STM-010 - NSTM Chapter 550 (Industrial Gases; Generating, Handling, and Storage)

NAVSEA S9086-TA-STM-010 - NSTM Chapter 562 (Surface Ship Steering)

NAVSEA S9086-TD-STM-010 - NSTM Chapter 565 (Surface Ship Stabilizing Systems)

NAVSEA S9086-TK-STM-010 - NSTM Chapter 571 (Underway Replenishment)

NAVSEA S9086-TL-STM-000 - NSTM Chapter 572 (Shipboard Stores and Provision Handling)

NAVSEA S9086-TM-STM-000 - NSTM Chapter 573 (Booms)

NAVSEA S9086-TV-STM-010 - NSTM Chapter 581 (Anchoring)

NAVSEA S9086-TX-STM-010 - NSTM Chapter 583 (Boats and Small Craft)

NAVSEA S9086-T3-STM-010 - NSTM Chapter 588 (Aircraft Elevators)

NAVSEA S9086-T4-STM-010 - NSTM Chapter 589 (Cranes)

NAVSEA S9086-T8-STM-010 - NSTM Chapter 593 (Pollution Control)

NAVSEA S9086-UF-STM-010 - NSTM Chapter 600 (Structural Closures)

NAVSEA S9086-UU-STM-010 - NSTM Chapter 613 (Wire and Fiber Rope and Rigging)

NAVSEA S9086-VD-STM-010 - NSTM Chapter 631 (Preservation of Ships In-Service - General)

NAVSEA S9086-VF-STM-010 - NSTM Chapter 633 (Cathodic Protection)

NAVSEA S9086-VG-STM-010 - NSTM Chapter 634 (Deck Coverings)

NAVSEA S9086-VH-STM-010 - NSTM Chapter 635 (Thermal, Fire and Acoustic Insulation)

NAVSEA S9086-WK-STM-010 - NSTM Chapter 670 (Stowage, Handling and Disposal of Hazardous General Use Consumables)

NAVSEA S9086-XG-STM-010 - NSTM Chapter 700 (Shipboard Ammunition Handling and Stowage)

NAVSEA S9086-ZN-STM-000 - NSTM Chapter 772 (Cargo and Weapons Elevators)

NAVSEA S9086-7G-STM-000 - NSTM Chapter 997 (Drydocking of Naval Vessels)

NAVSEA S9086-7G-STM-010 - NSTM Chapter 997 (Docking Instructions and Routine Work in Dry Dock)

NAVSEA 0348-LP-159-1000 - Freeze Sealing Manual (Nuclear)

NAVSEA 0387-LP-046-8000 - System Hydrostatic Test Requirements

NAVSEA 0900-LP-001-7000 - Fabrication and Inspection of Brazed Piping Systems

NAVSEA 0900-LP-016-7008 - Submarine Antenna Technical Documentation

NAVSEA 0900-LP-083-0010 - Naval Shipyard Quality Program Manual

NAVSEA 0900-LP-095-4010 - Ship Test and Evaluation Planning Guide

NAVSEA 0902-018-2010 - General Overhaul Specifications for Deep Diving SSBN/SSN Submarines (DDGOS)

NAVSEA 0924-062-0010 - Submarine Safety (SUBSAFE) Requirements Manual

NAVSEA 0948-LP-045-7010 - Material Control Standard

NAVSEA 0989-028-5000 - Manual for Control of Testing and Plant Conditions (Nuclear)

NAVSEA 0989-031-4000 - Reactor Plant Instrumentation and Control Equipment Maintenance

NAVSEA 0989-064-3000 - Cleanliness Requirements for Nuclear Propulsion Plant Maintenance and Construction

NAVSEA 0989-150-0000 - Standard Naval Nuclear Valves and Auxiliary Equipment

NAVSEA 0989-LP-026-1000 - A4W/A1G Reactor Plant Manual

NAVSEA 0989-LP-030-7000 - Lifting Standard

NAVSEA 0989-LP-037-2000 - Commissioned Submarine General Reactor Plant Overhaul and Repair Specifications

NAVSEA 0989-LP-040-6000 - Air Flask Inspection and Maintenance Requirements (Nuclear)

NAVSEA 0989-LP-043-0000 - Commissioned Surface Ship General Reactor Plant Overhaul and Repair Specification

NAVSEA 0989-LP-058-0000 - AS/AD Tender Nuclear Support Facilities Preventive Maintenance Index

NAVSEA 0989-LP-058-1000 - Destroyer Tender and Submarine Tender Nuclear Support Facilities Overhaul and Repair Specification

NAVSEA 0989-LP-062-4000 - Naval Nuclear Quality Control Manual for Shipyards

NAVSEA 250-1500-1 - Welding Standard

NAVSEA 389-0153 - Radiological Controls

NAVSEA 389-0288 - Radiological Controls

NAVSEA 389-0317 - Procedures for Maintenance and Repair of Naval Reactor Plants (Nuclear)

NAVSEA 392-0755 - Seal Welding Manual (Nuclear)

NAVSEA 4350.2 - Contract Work Onboard Nuclear-Powered Ships

NAVSEA 6310-081-015 - Technical Handbook for Special Hull Treatment Maintenance and Repair for Submarines

NAVSEA S0005-AG-GYD-010 - Technical Manual Users Quick Reference Guide

NAVSEA S0005-AA-PRO-010/TMMP - NAVSEA Technical Manual Management Program Operations and Life Cycle Support Procedures

NAVSEA S0300-B2-MAN-010 - Supervisor of Shipbuilding, Conversion and Repair Operations Manual
NAVSEA S0400-AD-URM-010/TUM - Tag-Out Users Manual
NAVSEA S0570-AC-CCM-010/8010 - Industrial Ship Safety Manual for Fire Prevention and Response
NAVSEA S0600-AA-PRO-010 - Underwater Ship Husbandry Manual
NAVSEA S0600-AA-PRO-230 - Underwater Ship Husbandry Manual, Chapter 23: Submarine Predeployment Noise Inspections
NAVSEA S0600-AA-PRO-280 - Underwater Ship Husbandry Manual, Chapter 28: Pollution Prevention
NAVSEA S5475-AL-PRO-010 - Principles and Procedures for Magnetic Treatment of Ships
NAVSEA S6152-B1-CAT-010 - Laundry and Dry Cleaning Equipment Catalog
NAVSEA S6161-Q5-CAT-010 - Naval Shipboard Food Service Equipment Catalog
NAVSEA S6470-AA-SAF-010 - Gas Free Engineering Manual
NAVSEA S8800-00-GIP-000 NAVSEA Guidance Handbook for Intermediate Maintenance Activity Technical Library Personnel

NAVSEA S9002-AK-CCM-010/6010 - Industrial Ship Safety Manual for Submarines
NAVSEA S9008-AA-PRO-010 - Lifeboat, Inflatable, MK6, MK7, and MK8 Inspection, Test and Repair Procedures
NAVSEA S9040-AA-GTP-010 - Shipboard Systems Certification Requirements for Surface Ship Industrial Periods (Non-Nuclear)
NAVSEA S9040-AC-IDX-010 - Ships 3-M Reference Information CD
NAVSEA S9073-A4-SNC-010 - USS LOS ANGELES (SSN 688) Class Acoustic Stealth Manual
NAVSEA S9073-AF-SNC-010(C) - Ship Noise Control
NAVSEA S9073-AW-SNC-010 - Ship Acoustical Surveys for Submarines
NAVSEA S9081-AB-GIB-010 - Reliability Centered Maintenance Handbook
NAVSEA S9092-AC-ADM-010 - Industrial Test Program Administration Manual
NAVSEA S9095-AD-TRQ-010/TSTP - Total Ship Test Program Manual
NAVSEA S9165-AC-HBK-010 - Submarine Sonar Dome Handbook
NAVSEA S9213-33-MMA-000 - Radiological Controls for Ships
NAVSEA S9213-45-MAN-000 - Naval Nuclear Material Management
NAVSEA S9221-C1-GTP-010 - Main Boiler Repair and Overhaul (VOL I)
NAVSEA S9221-C1-GTP-020 - Main Boiler Repair and Overhaul (VOL II)
NAVSEA S9221-D2-MMA-010 - Steam Generating Plant Inspection (Non-Nuclear)

NAVSEA S9223-AF-MMO-010 - Submarine Main Storage Battery Technical Manual
NAVSEA S9233-CJ-HBK-010 - U.S. Navy Diesel Engine Inspectors Handbook, Part 1 (Inspection Procedures)
NAVSEA S9233-CJ-HBK-020 - U.S. Navy Diesel Engine Inspectors Handbook, Part 2 (Technical Information)
NAVSEA S9425-AW-PRO-010 - Submarine Pressure Test, Evacuation/Charge and Dew Point Test Procedures
NAVSEA S9425-CF-STD-010 - Submarine Antenna/Periscope and Mast Materials
NAVSEA S9425-CG-STD-010 - Installation Standards for Submarines
NAVSEA S9475-AC-PRO-010 - Degaussing Forms, Records and Reporting Procedures

NAVSEA S9505-AF-MMA-010 - Submarine Non-Nuclear Piping Systems Test Manual
NAVSEA S9505-AM-GYD-010 - Submarine Fastening Criteria (Non-Nuclear), Description, Design and Maintenance
NAVSEA S9510-AB-ATM-010 - Nuclear Powered Submarine Atmosphere Control Manual, Volume 1
NAVSEA S9510-AB-ATM-020 - Nuclear Powered Submarine Atmosphere Control Manual, Volume 2

NAVSEA S9515-A1-MMO-010/020/030 - Automated Electrolytic Oxygen Generator (AEOG) Treadwell Corporation Preliminary Technical Manual, Volumes 1, 2 and 3
NAVSEA S9515-A4-MMA-010/020 - Low Pressure Electrolyzer (LPE) Oxygen Generator Technical Manual Volumes 1 and 2
NAVSEA S9515-AA-MMO-010 - Electrolytic Oxygen Generator 6L16; Vol 1
NAVSEA S9515-AA-MMO-021 - Electrolytic Oxygen Generator 6L16; Vol 2, Chapter 5, Part I
NAVSEA S9515-AA-MMO-022 - Electrolytic Oxygen Generator 6L16; Vol 2, Chapter 5, Part II
NAVSEA S9515-AA-MMO-030 - Electrolytic Oxygen Generator 6L16; Vol 3
NAVSEA S9515-AA-MMO-040 - Twelve-Pulse Hexagon Power Supply for Electrolytic Oxygen Generator, 6L16; Installation, Operation & Maintenance

NAVSEA S9515-AL-MMA-010/020 - Integrated Low Pressure Electrolyzer (ILPE) Preliminary Technical Manual, Volumes 1 and 2

NAVSEA S9520-AA-MMA-010 - Repair of Submarine Seawater Ball Valves (Non-Nuclear)

NAVSEA S9522-AA-HBK-010 - Description, Operation and Maintenance Handbook for Magazine Sprinkler Systems

NAVSEA S9534-AD-MMA-010 - Steam Reboiler Maintenance

NAVSEA S9560-CH-SCB-010 - VIRGINIA Class Submarine Fly-By-Wire Ship Control System Certification Boundary Book

NAVSEA S9560-CK-SCB-010 - SEAWOLF Class Submarine Fly-By-Wire Ship Control System Certification Boundary Book

NAVSEA S9587-AT-MMA-010 - Electronic Controls Charging System Tech Manual

NAVSEA S9587-B1-MMA-010 - Catapult Steam Support Systems for CV/CVN Class Ships; Description, Operation and Maintenance

NAVSEA S9592-B3-MAN-010 - Dry Deck Shelter Systems Scope of Certification Notebook, Volume I

NAVSEA S9600-AD-GTP-010 - U.S. Navy Shipboard Furniture Catalog

NAVSEA S9810-AA-GTP-010 - Intermediate Maintenance Activity Work Center Requirements Manual

NAVSEA S9AA0-AB-GOS-010 - General Specifications for Overhaul of Surface Ships (GSO) 2004 Edition

NAVSEA S9AA0-AB-GOS-030 - General Specifications for Overhaul of Surface Ships (GSO) AEGIS Supplement

NAVSEA S9SSN-W4-SSM-PA0/C688CLV7 - SSN688 Class Ship Systems Manual, Vol 7

NAVSEA SE004-AK-TRS-010 - Standard Maintenance Practices 2M Electronic Assembly Repair

NAVSEA SE300-AZ-MMA-010 - Description, Operation and Maintenance SSN 21 Class Sonar Bow Dome

NAVSEA SE300-MA-MMA-011 - Glass Reinforced Plastic (GRP) Bow Sonar Dome

NAVSEA SE400-DA-MMO-010 - Passive Countermeasure System (PCMS) Technical Manual

NAVSEA SG420-AP-MMA-010 - Periodic Testing Arrangements for Ordnance Handling Equipment

NAVSEA SI 0009-60 - Schedule and Associated Reports for Availabilities over 9 Weeks in Duration

NAVSEA SI 009-01 - General Criteria; Accomplish

NAVSEA SI 009-04 - Quality Management System

NAVSEA SI 009-07 - Procedures and Equipment Required for the Prevention of Fire

NAVSEA SI 009-08 - Fire Fighting and Fire Prevention

NAVSEA SI 009-99 - Ship Departure Report

NAVSEA SL720-AA-MAN-030 - Navy Modernization Process Management and Operation Manual (NMP MOM)

NAVSEA SS521-AA-MAN-010 - U.S. Navy Diving and Manned Hyperbaric Systems Safety Certification Manual

NAVSEA SS521-AG-PRO-010 - U.S. Navy Diving Manual

NAVSEA SS750-AA-MMA-010 - Submarine Rescue Chamber (SRC), Modernized 850 Ft

NAVSEA SS800-AG-MAN-010/P-9290 - System Certification Procedures and Criteria Manual for Deep Submergence Systems

NAVSEA ST000-A-IDX-010 - Test, Measurement and Diagnostic Equipment Index (TMDEI)

NAVSEA ST700-AA-LST-010 - Navy Calibration Activity (NCA) List

NAVSEA ST700-AM-GYD-010 - Metrology and Calibration (METCAL) Laboratory Requirements and Certification Guide

NAVSEA Standard Work Item 077-01 - Hazardous Waste Produced on Naval Vessels; control

NAVSEA T0300-AA-MMI-010 - Commercial Industrial Services (CIS) Manual

NAVSEA T9044-AD-MAN-010 - Requirements Manual for Submarine Fly-By-Wire Ship Control Systems

NAVSEA T9074-AS-GIB-010/271 - Requirements for Nondestructive Testing Methods
NAVSEA T9074-AD-GIB-010/1688 - Requirements for Fabrication, Welding and Inspection of Submarine Structure
NAVSEA T9512-AC-TRQ-010 - SS/SSN/SSBN Submarine Snorkel Systems

NAVSEA TE000-AA-MAN-010/2M - Certification Manual for Miniature/Microminiature (2M)/Module Test and Repair (MTR) Program

NAVSEA TL710-AB-MAN-010 - Depot Modernization Period (DMP) Procedures Manual

NAVSEA TW024-AA-ORD-010 - Unserviceable, Suspended, and Limited Use Ammunition

NAVSEA Technical Publication T-9630-AB-MMD-010/ALL USN HULLS - Corrosion Control Assessment and Maintenance Manual for Corrosion Control Information Management System (CCAMM for CCIMS)

NAVSEA Technical Specification 9090-100 - Planning Yard (PY) Representatives
NAVSEA Technical Specification 9090-100A - Liaison Action Record
NAVSEA Technical Specification 9090-310 - Ship Alteration Accomplishment by Installation Teams

NAVSEA STD DWG 213-4362626 - Lagging and Insulation Schedule for Reactor Plant Systems
NAVSEA STD DWG 407-5287556 - Electronics Material Officer's Guide to Shipboard Electromagnetic Interference Control
NAVSEA STD DWG 514-8316912 - CVN 68 Reboiler Strength and Integrity Inspection
NAVSEA STD DWG 709-5549373 - Weapons Handling Equipment SSN 688 Class Test Loads/ Methods and Inspection Procedures
NAVSEA STD DWG 709-5549374 - Weapons Handling Equipment SSBN 726 Class Test Loads/Methods and Inspection Procedures
NAVSEA STD DWG 709-6633924 - Vertical Launch System Weapons Handling Equipment SSN 688 Class Test Loads/Methods and Inspection Procedures
NAVSEA STD DWG 709-6726350 - Weapons Handling Equipment SSN 21 Class Test Loads/Methods and Inspection Procedures

NAVSEA STD DWG 803-5000902 - Safety Net, Deck Edge, Steel Frame and Nets
NAVSEA STD DWG 803-5184097 - Safety Net, Deck Edge, Aluminum Frame and Nylon Nets
NAVSEA STD DWG 803-5959209 - Aircraft Deck Tiedown Fittings
NAVSEA STD DWG 804-1213717 - Vehicle Tiedown Deck Fittings
NAVSEA STD DWG 804-5184163 - Trunk Safety Nets
NAVSEA STD DWG 805-1639000 - Deck Screw Reversible Eyebolts
NAVSEA STD DWG 805-1645271 - Portable Davits
NAVSEA STD DWG 805-1916300 - Aircraft Securing and Engine Run-up Fittings
NAVSEA STD DWG 805-2276338 - Cleats
NAVSEA STD DWG 805-921806 - Installation of Planking on Deck Plating
NAVSEAINST 3960.4 - Implementation of Total Ship Test Program for Ship Production
NAVSEAINST 3960.5 - Policy on Ship Testing

NAVSEAINST 4130.9 - Configuration Control Procedures For Preparation of Ordnance Alterations (ORDALTS) to Expendable and Non-Expendable Items
NAVSEAINST 4160.3 - Technical Manual Management Program
NAVSEAINST 4200.17 - Contracting Officer's Representative
NAVSEAINST 4280.2 - Master Agreement for Repair and Alteration of Vessels, Master Ship Repair Agreement (MSRA) and Agreement for Boat Repair (ABR)
NAVSEAINST 4355.7 - Nondestructive Test (NDT) Examiner Qualification and Requalification
NAVSEAINST 4441.2 - Changes to Coordinated Shipboard Allowance List (COSAL); Procedures for

NAVSEAINST 4700.6 - Guarantee Engineer and Industrial Availability Quality Assessment
NAVSEAINST 4700.17 - Preparation and Review of Trouble Reports

NAVSEAINST 4710.6 - Submarine Advanced Equipment Repair Program (AERP); Assignment of Responsibilities for and Administration of

NAVSEAINST 4710.8 - Cost and Performance Reporting for CNO Scheduled Ship Maintenance Availabilities

NAVSEAINST 4710.9 - Requirements for Turnover of Planning Products and Specification Package

NAVSEAINST 4720.14 - Temporary Alterations to Active Fleet Submarines; Control of

NAVSEAINST 4720.15 - Machinery Alterations on HM&E Equipment and Systems

NAVSEAINST 4720.23 - Deep Submergence Systems Temporary Modifications

NAVSEAINST 4730.1 - Shipyard Inspection and Required Conditions of Propulsion Plant Systems (Non-Nuclear) on Nuclear Powered Submarines

NAVSEAINST 4730.2 - Shipyard Inspection and Required Conditions of Propulsion Plant Systems (Non-Nuclear) for Nuclear Powered Surface Ships

NAVSEAINST 4734.1 - NAVSEA Test, Measurement, and Diagnostic Equipment (TMDE) and Calibration Programs

NAVSEAINST 4790.8 - Ship's Maintenance and Material Management (3-M) Manual

NAVSEAINST 4790.14 - Ship Departure and Alteration Completion Reports

NAVSEAINST 4790.17 - Fleet Test and Repair of Shipboard Electronic Equipment

NAVSEAINST 4790.23 - Baseline Project Management Plan (BPMP)

NAVSEAINST 5370.1 - Standards of Conduct and Statements of Affiliations and Financial Interests

NAVSEAINST 5400.95 - Waterfront Engineering and Technical Authority Policy

NAVSEAINST 5450.142 - Mission and Functions of the Surface Maintenance Engineering Planning Program Activity

NAVSEAINST 5730.1 - Legislative and Congressional Matters

NAVSEAINST 7500.1 - Audits of NAVSEA by External Audit Organizations

NAVSEAINST 9070.1 - Standard Specification for Ship Repair and Alteration Committee

NAVSEAINST C9073.2 - Acoustical Survey of Submarines

NAVSEAINST C9094.2 - Submarine Valve Operation Requirements for Builders and Post-Overhaul Sea Trial Test Dives

NAVSEAINST C9096.2 - Weight and Stability Requirements for Active Submarines

NAVSEAINST C9210.4 - Changes, Repairs and Maintenance to Nuclear Powered Ships

NAVSEAINST 9210.14 - Changes to Submarine Tenders and Destroyer Tenders with Nuclear Support Facilities, Requirements Concerning

NAVSEAINST 9210.23 - Requirements for Naval Nuclear Work at Naval Activities and Private Shipyards -

Certification of Work Accomplishment and Data Retention of Associated Records and Retention of Design Records

NAVSEAINST 9210.29 - Nuclear Powered Ships and Prototypes - Responsibilities of Holders of Reactor Plant and Related Manuals

NAVSEAINST 9210.30 - Procedures for Administration of Nuclear Reactor Plant Preventive Maintenance and Tender Nuclear Support Facilities Preventive Maintenance on Ships

NAVSEAINST 9210.31 - Government Procurement Quality Assurance Source Inspection Actions for Shipyard Procured Material Under the Cognizance of NAVSEA 08

NAVSEAINST C9210.34 - All Nuclear Projects - Material Identification and Control Requirements for Naval Nuclear Reactor Plant Piping Systems

NAVSEAINST 9210.39 - Submarine Nuclear Propulsion Plant Operator Welders: Procedures for Maintenance of Qualification

NAVSEAINST 9210.4 - Changes, Repairs and Maintenance to Nuclear Powered Ships

NAVSEAINST 9210.41 - All Naval Nuclear Propulsion Plants - Use of Standard Lubricants and Penetrating Fluid; Requirements for

NAVSEAINST 9254-1 - Eddy Current Inspection of Condensers and Reboilers on Nuclear Vessels

NAVSEAINST 9304.1 - Shipboard Electrical Cable and Cableway Inspection and Reporting Procedures

NAVSEAINST 9593.1 - Certification Program for Sewage Marine Sanitation Devices in U.S. Navy Surface Ships and Craft

NAVSEALOGCENINST 4355.14 - Receipt Inspection Requirements for Deep Submergence Systems Scope of Certification (DSS-SOC) Stock Program Material

NAVSEANOTE 5000 - Activities Authorized to Perform SUBSAFE, FBW-SCS and DSS-SOC Work

NAVSHIPS 0900-070-6010 - Material Control Standard

NAVSHIPS 0948-045-7010 - Material Identification and Control (MIC) for Piping Systems

NAVSO P-1000 - Navy Comptroller Manual

NAVSO P-3006 - Financial Management of Resources Operations and Maintenance, (Shore Activities)

NAVSO P-3635 - Federal Acquisition Regulation, Section 13, Chapter 312

NAVSUP 484 - Supply Afloat Fleet and Field Packaging Procedures

NAVSUP 5009 (DLAM 4215.1) - Management of Defense-Owned Industrial Plant Equipment

NAVSUP Publication 485 - Afloat Supply Procedures

NAVSUP P2003 - Navy Stock List of Forms and Publications

NAVSUPPUB 437 - Material Required Delivery Date Processing

NAVSUPWSSINST 4355.5 - Level I/Subsafe (LI/SS) Deep Submergence Systems Scope of Certification (DSS-SOC) and Fly-By-Wire (FBW) Stock Program Material Procedures

NMCARS 5201 - Federal Acquisition Regulations System

NMCARS 5219.7 - The Small Business Subcontracting Program

NMCARS 5233 - Protests, Disputes and Appeals

NMCARS 5233.9000 - Documentation of Significant Contract Events

NMCARS 5242 - Contract Administration and Audit Services

NMCARS 5245.302 - Providing Facilities

NMCARS 5245.505 - Records and Reports of Government Property

NMCARS Part 5245 - Government Property

NSTR-99 - Qualification Examination Requirements for Nondestructive Test Personnel

NSWC Philadelphia ltr 9320, Ser 934/010 dated 19 Mar 2001, titled Shipboard Circuit Breaker Maintenance and Overhaul Policy

NSWCCD-71-TR-2001/020 - February 2001 USS SEAWOLF (SSN 21) Class Acoustic Stealth Manual

NSWCCD-SSES 9332-GGTB 11 - General Gas Turbine Bulletin Number 11 (Gas Turbine Fleet Representatives)

NSWCCD-SSES 9352-GGTB 0 - General Gas Turbine Bulletin Number 0 (Technical Directive Zero Index)

NUSC 551 - Handbook for Submarine Antenna Systems

NWP 1-03.1 - Naval Warfare Publication Operational Report

Occupational Safety and Health Act of 1970

ONRINST 5400.1 - Obtaining Waivers Under Office of Naval Research Designation as a Reinvention Laboratory

OPNAV 43P6 - MEASURE Users Manual

OPNAVINST 3000.12 - Operational Availability of Equipments and Weapons Systems
 OPNAVINST 3000.15 - Fleet Response Plan
 OPNAVINST C3000.5 - Operation of Naval Nuclear Powered Ships
 OPNAVINST 3120.28 - Certification of the Aviation Capability of Naval Ships Operating Aircraft
 OPNAVINST 3120.32 - Standard Organization and Regulations of the U.S. Navy
 OPNAVINST 3120.33 - Submarine Extended Operating Cycle (SEOC) Program
 OPNAVINST 3150.27 - Navy Diving Program
 OPNAVINST 3540.3 - Naval Nuclear Propulsion Examining Boards
 OPNAVINST 3540.4 - Propulsion Examining Boards for Conventionally Powered Ships
 OPNAVINST 3960.16 - Navy Test, Measurement, and Diagnostic Equipment (TMDE) Automatic Test Systems (ATS), and Metrology and Calibration (METCAL)

OPNAVINST 4000.57 - Logistic Support of the TRIDENT and POSEIDON Fleet Ballistic Missile (FBM) Systems
 OPNAVINST 4100.11 - Navy Energy Usage Reporting System (NEURS)
 OPNAVINST 4440.19F - Policies and Priority Rules for Cannibalization of Operational Equipment and Diversion of Material at Contractor Plants to Meet Urgent Operational Requirements
 OPNAVINST 4614.1 - Uniform Material Movement and Issue Priority System
 OPNAVINST 4700.7 - Maintenance Policy for U.S. Naval Ships
 OPNAVINST 4700.8 - Trials, Acceptance, Commissioning, Fitting Out, Shakedown and Post Shakedown Availability of U.S. Naval Ships Undergoing Construction or Conversion
 OPNAVINST 4700.38 - Berthing and Messing During CNO Scheduled Maintenance Availabilities
 OPNAVINST 4730.5 - Trials and Material Inspections (MI) of Ships Conducted by the Board of Inspection and Survey
 OPNAVINST 4770.5 - General Policy for the Inactivation, Retirement and Disposition of United States Naval Vessels
 OPNAVINST 4730.7 - Material Inspection of Submarines Conducted by the Board of Inspection and Survey
 OPNAVINST 4780.6 - Policy for Administering Service Craft and Boats in the U.S. Navy
 OPNAVINST 4790.4 - Ships' Maintenance and Material Management (3-M) Manual
 OPNAVINST 4790.15 - Aircraft Launch and Recovery Equipment Maintenance Program (ALREMP)

OPNAVINST 5090.1 - Environmental and Natural Resources Program Manual
 OPNAVINST 5100.19 - Navy Occupational Safety and Health (NAVOSH) Program Manual for Forces Afloat
 OPNAVINST 5100.20 - Shipboard Heat Stress Control and Personnel Protection
 OPNAVINST 5100.23 - Navy Occupational Safety and Health (NAVOSH) Program Manual
 OPNAVINST C5510.93 - Navy Implementation of National Policy on Control of Compromising Emanations

OPNAVINST C8950.2 - Magnetic Silencing

OPNAVINST 9070.2 - Signature Control Policy for Ships and Craft of the U.S. Navy
 OPNAVINST 9080.3 - Procedures for Tests and Trials of Navy Nuclear Powered Ships Under Construction, Modernization, Conversion, Refueling and Overhaul
 OPNAVINST 9110.1 - Policy Concerning Submarine Test and Operating Depths
 OPNAVINST C9210.2 - Engineering Department Manual for Naval Nuclear Propulsion Plants
 OPNAVINST N9210.3 - Safeguarding Naval Nuclear Propulsion Information
 OPNAVINST 9220.2 - U.S. Navy Boiler Water and Feedwater Test and Treatment Program (Nuclear Excluded)
 OPNAVINST 9220.3 - Propulsion and Auxiliary Plant Inspection and Inspector Certification Program
 OPNAVINST 9640.1 - Shipboard Habitability Program

OPNAVINST 11010.20 - Facilities Project Instruction Manual

OPNAVNOTE 4700 - Representative Intervals, Durations, Maintenance Cycles, and Repair Mandays for Depot Level Maintenance Availabilities of U.S. Navy Ships
 OPNAVNOTE 4710 - Fleet Depot Maintenance Schedule
 OPNAVNOTE 4780 - Service Craft and Boats Accounting Report (SABAR)
 OPNAVNOTE 5400 - DNS-33/10U229822 of Sep 10

OSHA 29 CFR 1915 - Confined and Enclosed Spaces and Other Dangerous Atmospheres in Shipyard Employment

Public Law 97-114 - DoD Appropriations Act

Public Law 109-61 - Emergency Preparedness and Response

SECNAV M-5210.1 - Records Management Manual

SECNAVINST 4855.3 - Product Data Reporting and Evaluation Program (PDREP)

SECNAVINST 5239.21 - Department of the Navy Electronic Signature Policy

SECNAVINST 5400.15 - Department of the Navy Research, Development and Acquisition, and Associated Life Cycle Management Responsibilities

SECNAVINST 5430.92 - Assignment of Responsibilities to Counteract Fraud, Waste and Related Improprieties within the Department of the Navy

SECNAVINST 5510.30 - Department of the Navy Personnel Security Program

SECNAVINST 5510.36 - Department of the Navy Information Security Program Regulation

SOBT Video SVT-GT-9336 - Submarine Preservation

SPCCINST 4440.376 - Supply Policies and Procedures for Naval Reactor Plant Parts and Material

SPCCINST 4441.170 - COSAL Use and Maintenance Manual

SSN 21-081-PMS350L-035 - Rotatable Pool Management Plan for the SEAWOLF Class SSN

SSPINST 4720.1 - Policies and Procedures for Alteration of Strategic Weapon System Equipment

SSPINST 5600.11 - Preventive Maintenance Management Program for Strategic Weapon Systems Equipment and Associated Material

SSPINST 8950.2 - Procedure for Fleet Ballistic Missile (FBM)/Strategic Weapons System (SWS) Components During Flash-Deperm Treatment of an SSBN

STARS Users Manual (FMSO P-104)

SUBMEPP Test Procedure 441-5-7001 - SSN 688 Class Submarine, Systems EMI Measurements, Dockside

SUBMEPP 9086-008-814 - TRIPER Information Notebook

SWT 077-01 - Hazardous Waste Produced on Naval Vessels; control

SWT 857-01 - Temporary Galley and Messing Facilities; provide

SWT 857-011 - Temporary Off Ship Berthing Equivalent to BOQ/BEQ; provide

The North American Industry Classification System (NAICS)

Title 10 U.S. Code - Armed Forces

TL130-A1-HBK-010 - MSC Procedures Manual - Maintenance Support Center Library Procedures Manual

TMIN SL700-AB-GYD-010 - Pictorial Guide for Painting Ship's Interiors

URO-MRC 003

U.S. Navy Regulations Article 1115

APPENDIX B
RESPONSIBILITIES
Fleet Commander

Section	Area of Responsibility	Responsibility
FWD-7.3.1	Life Cycle Maintenance Process for JFMM	<ul style="list-style-type: none"> • Establish a JFMM Board of Directors (BOD) • Provide final approval and promulgation letter • Provide funding for life cycle maintenance • Approve all Advanced Change Notices (ACN) • Convene periodic JFMM BOD review meetings • Designate Atlantic and Pacific Fleet JFMM Coordinators
II-I-3.3.7.1	Maintenance Policies and Procedures	<ul style="list-style-type: none"> • Maintain availability intervals and cycles • Inform of changes affecting ship manning requirements • Coordinate as applicable to accomplish availability planning • Implement Docking Officer Qualifications and Certifications • Plan and monitor availability execution • Plan and provide berthing, messing, etc., if necessary
II-I-3.6.1.1	Availability Execution	<ul style="list-style-type: none"> • Monitor to achieve balance of cost and schedule • Ensure testing of applicable systems is conducted prior to availability completion • Provide berthing, messing, etc., if necessary
IV-3.3.3	Boiler Inspections	<ul style="list-style-type: none"> • Identify and designate inspection responsibilities • Ensure inspection report is recorded and updated in BIRMIS • Schedule and coordinate inspections to avoid unnecessary opening of boilers • Ensure availability of “school ships” • Suspension of SGPIs who fail to comply with requirements of certification • Administer and control TYCOM pre-test program • Host semi-annual SGPI seminars • Provide qualified SGPI when requested
IV-23.2.2.3	Gas Turbine Engine Inspection	<ul style="list-style-type: none"> • Identify and designate fleet activities having inspection responsibilities • Maintain a base of MGTIs • Ensure availability of “school ships” to support MGTI training • Host semi-annual MGTI seminars

Section	Area of Responsibility	Responsibility
V-I-1.2.1	Organizational Responsibilities	<ul style="list-style-type: none"> • Promulgate QA Program through guidelines of Volume V of JFMM • Promote use of Volume V of JFMM by TYCOMs • Ensure the scope of training through fleet schools provides the necessary skills • Jointly authorize changes to Volume V of JFMM • Review TYCOM QA program by annual conference • Assessments of FMAs and RMCs occur in accordance with Volume IV, Chapter 2, paragraph 2.1.1
VI-6.4.1	Industrial Plant Equipment	<ul style="list-style-type: none"> • Review all PEPs • Prioritize and assign project number to PEPs • Forward information regarding PEPs to submitting activities
VI-8.2.1	Miniature/Micro-miniature Electronic Repair Program	<ul style="list-style-type: none"> • Operationally administer 2M and module test repair programs • Inspect and certify 2M repair facilities and technicians • Ensure all 2M maintenance actions are documented
VI-9.2.1	Metrology and Calibration Program	<ul style="list-style-type: none"> • Operationally administer METCAL program • Ensure calibration performed at lowest level practical • Monitor effectiveness of programs • Chair working groups and committees • (Surface) Establish SISCAL program • Provide funding for calibration and testing of TAMS (exceptions)

Section	Area of Responsibility	Responsibility
VI-35-3.1	RMC I-Level Maintenance Capabilities	<ul style="list-style-type: none"> • Approve changes, additions and deletions to the I-Level Capabilities Matrix • Approve recommended changes to the NAMTS NEC At-Sea Requirements Matrix • Approve and forward, with endorsement, NAMTS NEC modifications as developed and recommended by CNRMC • Review, approve and submit Billet Change Requests developed by CNRMC to support sea/shore rotation requirements • Request additions and deletions to the I-Level capabilities and/or corresponding capacities at each RMC based on utilization metrics and written Business Case Analysis to the cognizant Fleet Commander • Ensure full utilization of the full range of organic RMC I-Level capability • Establish and communicate work priorities to CNRMC and cognizant RMCs. Resolve work priority conflicts as necessary • Regularly assess NAMTS maintenance skills required on respective afloat units • Approve CNRMC recommended, or recommend additional changes to specific NAMTS maintenance skills and required training for billets on respective afloat units • In collaboration with CNRMC, review and recommend NAMTS NEC At-Sea Requirements Matrix revisions to the cognizant Fleet Commander(s) • Review and approve establishment and disestablishment of MATs, as recommended by CNRMC. Optimize utilization of MATs capacity within existing total I-Level workload in each cognizant RMC
VI-42.6.1	Material Assessment	<ul style="list-style-type: none"> • Maintain a common material assessment process and policy • Be the Fleet's advocate and single point of contact for all material assessment issues • Provide and support a standard material assessment tool set • Review the personnel and monetary resources required • Establish minimum standards of continuous program improvements

Type Commander (TYCOM)

Section	Area of Responsibility	Responsibility
FWD-7.3.2	Life Cycle Maintenance Process for JFMM	<ul style="list-style-type: none"> • Review and evaluate JFMM changes (21 days) • Notify Fleet Commanders of changes which affect ship and personnel safety • Review ACNs and forward to Fleet Commanders • Review and endorse all change packages • Designate representatives of JFMM BOD • Identify changes to JFMM distribution list
II-I-3.2.2	Early Start Concurrence	<ul style="list-style-type: none"> • Provide concurrence to execute an “early start” period
II-I-3.3.7.2	Maintenance Policies and Procedures	<ul style="list-style-type: none"> • Coordinate scheduling of availabilities with Fleet Commander • Initiate required budgetary actions • Coordinate work assignments between FMA and industrial activity • Seek resolution of technical problems and coordinate requirements for modernization and repair • Authorize AWP prepared by SUBMEPP • (Submarines) Coordinate interface 3-M system with PMR scheduling and feedback • Designate representative for WDC/PRC and pre-arrival conference • Recommend to CNO any high priority fleet modernization • (Submarines) Send a Sea Trials Support Services message, if required • (Submarines) For minor maintenance availabilities, send a Waiver of Escort Requirements message when requested by the ISIC • Conduct QA audit of Ship’s Force and FMA CWPs • (Submarines) For major availabilities send message for Fast Cruise, Sea Trials and Unrestricted Operations • (Submarines) For availabilities less than six months issue required message for Sea Trials • (Submarines) Verify that all SFCC-certified On Board Repair Parts are loaded out by Fast Cruise following any major or minor CNO availability
II-I-3.3.7.3a (All Ships)	Maintenance Policies and Procedures	<ul style="list-style-type: none"> • Assist TYCOM and SUBMEPP in preparation of AWP • Monitor corrective maintenance action taken • Schedule and conduct inspections of Forces Afloat • Monitor progress of CNO maintenance availabilities • Ensure that a MOA is executed prior to availability start

Section	Area of Responsibility	Responsibility
II-I-3.3.7.3b (Submarines Only)	Maintenance Policies and Procedures	<ul style="list-style-type: none"> • Ensure timely accomplishment and reporting of PMR maintenance actions on assigned ships • Ensure industrial activities and ships maintain current copies of Maintenance Standards, PMR schedules and PMR inventories • Review Ship's Force submitted deferrals for industrial activity assistance • Ensure industrial activities provide the 3-M and Maintenance Standards feedback • Request assistance from SUBMEPP as necessary in resolving problems with PMR scheduling and software • Report to SUBMEPP the inability to perform PMRs • Designate an Availability Coordinator • Provide updated Sea Trials status • For minor CNO availabilities, issue the required messages for Sea Trials escort requirements/waiver of escort requirements
II-I-3.3.7.3c (Surface Force Ships Only)	Maintenance Policies and Procedures	<ul style="list-style-type: none"> • In coordination with the RMC Chief Engineer, submit Change Deferral Requests and Change Notifications to SURFMEPP • Coordinate with SURFMEPP to update the AWP • Coordinate meetings as required at key milestones and as required to support resolution of major issues
II-I-3.6.8.3.11d	Availability Completion Prerequisites	<ul style="list-style-type: none"> • Issue message to the ship certifying the FBW SCS and authorizing FBW SCS unrestricted use
II-I-3.6.8.4.1c	Responsibilities for trials and inspections	<ul style="list-style-type: none"> • Schedule Fleet Commander PORSE • Provide Fast Cruise, Sea Trial and completion prerequisites to the ship • Assign material representatives to embark for trials • Inform CNO and Fleet Commander of trials • Provide escorts as required • Conduct ship salvage inspection • Approve Sea Trial Agenda • Report crew readiness and request authorization for critical ops • Report status of SUBSAFE boundary conditions and authorization of Sea Trials • Report status of SUBSAFE certification and authorize URO to test depth • Authorize underway operation of the FBW SCS • Issue a message to the ship authorizing FBW SCS unrestricted use in support of submarine unrestricted operations

Section	Area of Responsibility	Responsibility
II-II-2.5	Milestones	<ul style="list-style-type: none"> Obtain technical adjudication for any Baseline AWP items prior to the removal of any Baseline AWP item from the work package.
IV-2.4.1	FMA Assessment	<ul style="list-style-type: none"> Promulgate assessment schedule Forward precepts letter or message to FMA's Commanding Officer Conduct in-brief and out-brief with designated personnel Issue assessment report
IV-5.3.1	Marine Sanitation Devices	<ul style="list-style-type: none"> Ensure surface ships participate in pollution abatement program Ensure MSD systems are properly installed, operated and maintained
IV-16.2.3	Aircraft Launch and Recovery Systems	<ul style="list-style-type: none"> Provide ALRE Maintenance Management Teams to conduct assist visits and annual audits of all units
IV-17.3.3	Steam Catapult Inspection	<ul style="list-style-type: none"> Provide or arrange for certified SGPIs to perform inspections Coordinate inspections of all catapult accumulators and support systems Assist COs in arranging for corrective action of deficient items Review the SCIRMIS
IV-26.2.1	Board of Inspection and Survey Material Inspections Policy	<ul style="list-style-type: none"> Act as cognizant authority for conduct of INSURV inspections Nominate active ships for MIs by the INSURV board Schedule inspections/assessments within 60 days of MI Review Safety Survey results and corrective action status report Track and work to resolve historical issues identified by INSURV Coordinate with the ISIC to disseminate the best practices and lessons learned
IV-27.3.3	Steam Reboiler Inspection	<ul style="list-style-type: none"> Arrange for certified SGPIs to perform inspections Schedule inspections of all Steam Reboilers and support systems. Coordinate the inspections. Assist Commanding Officers in arranging corrective action of deficient items beyond the capability of Ship's Force to perform. Monitor follow-up action to correct deficiencies. Review the RIRMIS to ensure deferred inspection deficiencies are entered into the CSMP

Section	Area of Responsibility	Responsibility
V-I-1.3.1	Organizational Responsibilities	<ul style="list-style-type: none"> • (Submarines) Obtain NAVSEA approval for exception to REC requirements • Administer a departure from specification system • Perform assessment of nuclear FMAs annually • (Submarines) Perform assessment of ISICs annually • Perform assessment of FMA's non-nuclear programs annually • Perform random, unannounced assessments and monitor visits • Review and evaluate FMA and ISIC reports of corrective actions • (Submarines) Maintain system to provide SUBSAFE certification • Provide annual self evaluation of QA program • Evaluate and analyze proposed changes to this volume • (Submarines) Perform annual SUBSAFE/Scope of Certification awareness training • (Submarines) Develop and implement necessary instructions and procedures to meet requirements of reference (a) • (Submarines) Maintain FBW SCS certification • Approve at-sea testing developed by the ISEA following Upgrades/Alterations or Major Repair Work • Issue a message to the ship certifying the FBW SCS and authorize FBW SCS unrestricted use in support of Submarine unrestricted operations • (Submarines) For assigned activities, provide NAVSEA 07Q informational copies of critiques, trouble reports and incident reports for SUBSAFE/FBW SCS/DSS/SOC issues that result in a problem severity level of Level 1 (critical).
V-I-9.3.4	Assessments	<ul style="list-style-type: none"> • Conduct annual assessments of ISICs and FMAs
V-III-1.2.1	Organizational Responsibilities	<ul style="list-style-type: none"> • Obtain SCA approval for REC requirements in SOC systems • Administer DFS system • Perform assessment of ISICs responsible for DSSs annually • Perform random, unannounced Sustaining Activity Quality Assurance assessments • Perform an annual self evaluation of the QA program • Evaluate and analyze proposed changes to JFMM Volume V • Recommend to SCA suspension and reinstatement of DSS certification • Perform annual SOC awareness training

Section	Area of Responsibility	Responsibility
VI-4.8a	Shipboard Electromagnetic Compatibility	<ul style="list-style-type: none"> • Coordinate to identify, solve and correct operational EMI deficiencies • Arrange for SEMCIP services when required • Review and authorize documents prepared by technical agencies • Evaluate comments and recommendations regarding EMI reduction • Ensure FMA and RMC have technicians to support EMI surveys
VI-5.2.4	Deficiency Documentation and Reporting	<ul style="list-style-type: none"> • Validate, screen and broker all 4790/2Ks • Broker all 4790/2Ks associated with any outstanding C3/C4 CASREP during the next scheduled maintenance availability • Approve any planned delay of action on a CASREP • Enforce compliance with the policy of updating a CASREP
VI-6.4.2	Industrial Plant Equipment	<ul style="list-style-type: none"> • Review PEPs for technical accuracy and completeness • Review PEPs for conflicts with other maintenance actions • Prioritize PEPs and evaluate each project to ensure compatibility with capability requirements and site configuration • Forward approved requests and return unapproved requests • Schedule annual assessment and coordinate repairs
VI-8.2.2	Miniature/Micro-miniature Electronic Repair Program	<ul style="list-style-type: none"> • Coordinate and manage 2M program • Monitor effectiveness of 2M program • Implement progressive repair procedures • Coordinate logistic support, outfitting requirements and deployment priorities • Monitor 2M certification status • Schedule 2M certifications in conjunction with C5RA/TSRA • (Aircraft Carriers) Conduct MTRF in accordance with reference (e)

Section	Area of Responsibility	Responsibility
VI-9.2.2	Metrology and Calibration Program	<ul style="list-style-type: none"> • Assign a METCAL program single point of contact • Submit TAMS allowance change requests to TAMS allowance manager • Redistribute excess TAMS • Provide properly trained personnel to authorized calibration activities • Periodically perform Quality Assurance reviews of laboratories • Manage calibration overflow program • Ensure Regional Loan Pools are established • Evaluate FMA/Regional Calibration Laboratories • Coordinate for SCAT assignments and SPETERL revisions • Assign Fleet Commander representatives
VI-11.5.1	Maintenance, Repair and Overhaul of Service Craft, Landing Craft and Small Boats	<ul style="list-style-type: none"> • Coordinate all aspects of advanced planning • Authorize all new industrial work items • Authorize growth in existing industrial work item • Provide funding for authorized work • Monitor and approve changes in established milestones • Direct action when quality or completeness of industrial activity work is in question
VI-12.3.2.1	Degaussing (ships with installed degaussing systems)	<ul style="list-style-type: none"> • Monitor degaussing readiness of assigned ships • Ensure ships “check range” as required • Issue waivers to check ranging and deperming requirements if necessary
VI-12.4.1.1	Degaussing (submarines without installed degaussing systems)	<ul style="list-style-type: none"> • Ensure that ships check range as required • Issue waivers to check ranging and deperming requirements if necessary • Schedule ships with unsatisfactory magnetic signatures for flash deperming
VI-13.4.3d	Coating System Inspections	<ul style="list-style-type: none"> • Employ NACE Certified Coating Inspectors to train and assist Ship’s Force with coating system inspections
VI-16.2.2.1.3	Habitability Improvement/ Self Help Responsibilities	<ul style="list-style-type: none"> • Develop Long Range Plan, establish priorities for attainment of standards • Plan, schedule, coordinate and monitor projects • Authorize, budget and fund habitability program

Section	Area of Responsibility	Responsibility
VI-19.2.1.1	Ship Maintenance and Material Management	<ul style="list-style-type: none"> • Afloat Maintenance Data System • Ashore Maintenance Data System • Alteration Management System • (Submarines) TFBR Screening • Maintain Assessment Data File • PMS Scheduling System • CSMP • Provide Program Enhancement Requirements • Master Job Catalog
VI-24.7.1	Periodic Maintenance Requirement Program	<ul style="list-style-type: none"> • Provide overall scheduling system for accomplishment of PMRs • Perform periodic audits of ISICs and FMAs • Provide guidance to ISICs obtaining NAVSEA concurrence
VI-25.3.1	Unrestricted Operations	<ul style="list-style-type: none"> • Perform periodic audits of ISICs and FMAs • Provide guidance to ISICs when deviating from schedules due to DFS requests
VI-27.3.1	Scheduled Preservation Upkeep Coordinated Effort	<ul style="list-style-type: none"> • Administer the SPRUCE program • Maintain and distribute file of SPRUCE lessons learned
VI-31.3.4	Surface Ship Maintenance Placement and Oversight Business Rules	<ul style="list-style-type: none"> • Establish force maintenance policies and directives • Provide list of Fleet Alteration requirements for execution year as input to RMC business plan • Issue spending controls to RMC and update on quarterly basis • Has authority to recapture spending controls previously issued, as a last resort • If not funding an availability, must approve removal of funds before RMC initiates this action • Evaluate Maintenance and Modernization Business Plan adjustment requests • Evaluate RMCs end of month financial status report

Section	Area of Responsibility	Responsibility
VI-33.2.3	MMBP Responsibilities (Surface Force Ships only)	<ul style="list-style-type: none"> Align Surface Warfare Enterprise processes with established waterfront support organizations and establish the readiness and cost control processes Support the ISIC with warships ready for tasking Assess current readiness, analyze metrics across ships of a class, examine class trends, determine root causes, establish lessons learned and provide recommendations and solutions Provide the NSA with Target Controls in March of each year Establish Force maintenance policies, directives and authorize the NSA to execute those policies and directives Ensure the established modernization plan is accurate and issue Fleet Alteration Letters of Authorization Validate MMBPs and promulgate approved CNO availability and Continuous Maintenance funding controls Provide the RMCs with Target Controls in March of each year
VI-33.2.4	MMBP Responsibilities (Aircraft Carriers and Submarines)	<ul style="list-style-type: none"> Establish Force maintenance policies and directives and authorize the NSA to execute them Ensure that established modernization plan is accurate and issue Fleet Alteration Letters of Authorization Final approval of all MMBPs
VI-33.4.2	Initial Budget Guidance (March)	<ul style="list-style-type: none"> Establish an initial estimate of the expected funding controls for the next Fiscal Year Develop a common maintenance funding strategy Establish initial TYCOM Target Controls for each ship's CNO Availability and each ship's CM budget Ensure Letters of Authorization accurately reflect the modernization plan
VI-33.4.4	Execution Strategy Adjustments (May)	<ul style="list-style-type: none"> Determine if adjustments to the TYCOM Target Controls are required
VI-33.4.6	Approve MMBPs (July)	<ul style="list-style-type: none"> Approve MMBPs and promulgate final approved CNO availability and CM controls Provide final CNO budget controls and CM controls to the Maintenance Teams
VI-33.4.7	Submit Phasing Plans (August)	<ul style="list-style-type: none"> Submit Phasing Plans to the Fleet Commander

Section	Area of Responsibility	Responsibility
VI-37.5c	Regional Maintenance Center Passive Countermeasure System Support Requirements	<ul style="list-style-type: none"> • Coordinate in identifying, solving and correcting PCMS deficiencies • Refer all PCMS related Departures from Specifications to NAVSEA for adjudication • Fund PCMS RIPs to provide for the additional RMC labor and materials • Ensure that proper corrosion control procedures are employed • Review and authorize documents that contain procedures relative to PCMS • Evaluate comments and recommendations regarding Fleet PCMS program
VI-38.3.1	DSS Hull Integrity Procedures	<ul style="list-style-type: none"> • Perform periodic audits of ISICs and FMAs • Provide guidance to ISICs for DFS request and resolution
VI-40.5.1	(SUBS) Messages	<ul style="list-style-type: none"> • Review (SUBS) message traffic • Assist and support the ISIC • Track (SUBS) messages initiated by the TYCOM department generating the message • Track (SUBS) messages generated by submarines under its cognizance
VI-41.2.3d	Maintenance Team	<ul style="list-style-type: none"> • Enter CNO availabilities, assessments, associated routine tasks and authorized Fleet and Programmed Alterations into the appropriate Maintenance Automated Information System
VI-41.4	Planning Process Support	<ul style="list-style-type: none"> • Provides planning process support in the planning and execution of engineered maintenance
VI-41.5	Planning Board for Maintenance	<ul style="list-style-type: none"> • Attend regularly scheduled meetings to discuss ship-wide maintenance issues
VI-42.6.2	Material Assessment	<ul style="list-style-type: none"> • Schedule and authorize material assessments • Define the scope of material assessment • Provide funding for execution and support • Conduct periodic reviews of the material assessment process • Establish standards of effectiveness to ensure program improvement • Evaluate unit's ability to self assess and report training deficiencies

Immediate Superior in Command (ISIC)

Section	Area of Responsibility	Responsibility
I-2.5.1	Pre-Commissioning	<ul style="list-style-type: none"> ● Provide crew support prior to initial man-up ● Conduct an inspection of the crew at the building yard ● Conduct periodic monitoring of ships ● Ensure personnel arrive in support of initial crew man-up ● Conduct a Habitability Inspection ● Make recommendations to the TYCOM for placing the ship "In Service" ● Contact TYCOM Metrology and Calibration Point of Contact to verify if establishment of Field Calibration Activity Request has been submitted ● Ensure that assigned New Construction Units operate and maintain installed diesel engines ● (Nuclear Powered Ships only) Conduct a Pre-RSE of the Engineering/Reactor Department ● (Nuclear Powered Ships only) Review Pre-RSE findings, the CO's training plan and progress evaluations ● (Submarines only) Prior to Fast Cruise, report ship's preparations to assume responsibility for Re-entry Control ● (Submarines only) Schedule salvage inspections ● (Submarines only) Designate the salvage inspection team ● For CVNs, conduct crew certification ● For all other hulls, conduct Phase I crew certification ● Conduct Phase II crew certification ● Conduct a material inspection of the ship ● Report satisfactory completion of the inspections to the TYCOM ● Message reporting requirements

Section	Area of Responsibility	Responsibility
I-2.5.2	Post Shakedown Availability	<ul style="list-style-type: none"> ● Conduct periodic monitoring ● (Nuclear Powered Ships only) Conduct a Pre-critical inspection of the Engineering/Reactor Department ● Witness and certify to the TYCOM that the state of crew training is satisfactory for at-sea operations ● (Aircraft Carriers only) Receive from the CO/Supervising Authority the scope, schedule and agenda of the tests for Sea Trials for review and approval ● Arrange for the embarkation of technical personnel to observe tests or trials ● Arrange for the assignment of operating areas and communications frequencies ● (Submarines only) Schedule a salvage inspection ● (Submarines only) Prior to Fast Cruise, audit Ship's Force Re-Entry Control and Departure from Specification records ● (Submarines only) Conduct a material inspection consisting of a vertical audit of Ship's Force and FMA SUBSAFE work and URO completion status ● Advise the TYCOM if deficiencies exist and/or extension of time is required to correct training/material deficiencies
I-3.3.1d	Arrival Assist	<ul style="list-style-type: none"> ● Inform the TYCOM in the event that progress in preparations is evaluated as unsatisfactory
I-3.3.2b	Periodic Monitoring/ Inspections/Visits	<ul style="list-style-type: none"> ● Determine the extent, type and frequency of periodic monitoring inspections and visits
I-3.3.2d	Periodic Monitoring/ Inspections/Visits	<ul style="list-style-type: none"> ● Advise the TYCOM of situations where the completion of Key Events is in jeopardy
I-3.3.3c	Pre-RSE Safeguard Examination	<ul style="list-style-type: none"> ● (Nuclear Powered Ships only) Schedule the Pre-RSE approximately six to eight weeks prior to criticality
I-3.3.3d(3)	Pre-RSE Safeguard Examination	<ul style="list-style-type: none"> ● Initiate arrangements for the participation of TYCOM Staff members at least one month prior to the inspection date
I-3.3.11	Habitability Inspection	<ul style="list-style-type: none"> ● Conduct Habitability Inspection
I-3.3.14a	Light-Off Assessment	<ul style="list-style-type: none"> ● Determine if ship's training procedures and status support safe plant operations
II-I-3.3.7.3a (All Ships)	Maintenance Policies and Procedures	<ul style="list-style-type: none"> ● Assist TYCOM and SUBMEPP in preparation of AWP ● Monitor corrective maintenance action taken ● Schedule and conduct inspections of Forces Afloat ● Monitor progress of CNO maintenance availabilities ● Ensure that a MOA is executed prior to availability start

Section	Area of Responsibility	Responsibility
II-I-3.3.7.3b (Submarines Only)	Maintenance Policies and Procedures	<ul style="list-style-type: none"> • Ensure timely accomplishment and reporting of PMR Maintenance • Ensure industrial activities and ships maintain current copies of Maintenance Standards, PMR schedules and inventories • Review Ship's Force submitted deferrals for industrial activity assistance • Ensure industrial activities provide 3-M and MS feedback for analysis by SUBMEPP • Request SUBMEPP assistance as necessary for assistance with PMR scheduling and software • Report to SUBMEPP inability to perform PMRs • Designate Availability Coordinator • Provide updated Sea Trials status to COMSUBDEVRON FIVE • For minor CNO maintenance availabilities issue required messages as applicable • Report that all SFCC-certified On Board Repair Parts are loaded out by Fast Cruise following any major or minor CNO availability
II-I-3.3.7.3c (Surface Force Ships Only)	Maintenance Policies and Procedures	<ul style="list-style-type: none"> • In coordination with the RMC Chief Engineer, submit Change Deferral Requests and Change Notifications to SURFMEPP • Coordinate with SURFMEPP to update the AWP • Coordinate meetings as required at key milestones and as required to support resolution of major issues

Section	Area of Responsibility	Responsibility
II-I-3.6.1.2	Availability Execution	<ul style="list-style-type: none"> ● Authorize new items and growth industrial work items ● Monitor and approve all changes in established milestones ● Issue direction when the quality or completeness of industrial work is in question ● Monitor off-ship crew messing and berthing arrangements ● Notify the TYCOM when essential Ship's Force work cannot be completed on the scheduled contract date ● (Surface Force Ships only) Assess and monitor shipboard conditions ● (Submarines only) Assess and monitor shipboard conditions ● Monitor Ship's Force preparations for LOA ● (Nuclear Powered Ships only) Conduct a Pre-Critical Inspection of the Engineering Department ● (Submarines only) Schedule a salvage inspection by the Forces Afloat ● Conduct a formal Phase I crew certification inspection(s) of the Ship's Force ● (Submarines only) Prior to Fast Cruise, conduct a formal audit of Ship's Force, Re-Entry Control, Departure from Specification Records and CSMP ● Conduct Phase II crew certification ● Conduct a material inspection of the ship ● Report satisfactory completion of inspections to the TYCOM ● Receive schedule and agenda of tests for Sea Trials for review and approval ● (Submarines only) Prior to Sea Trials, report material certification of the ship by message ● Monitor the progress of the availability ● If required, initiate Operating Cycle Extension Assessment
II-I-3.6.8.3b(5)(d) (Submarines Only)	Trials, Inspections and Certification Minor Availabilities	<ul style="list-style-type: none"> ● Perform 100% audit of FBW SCS Upgrades/Alterations or Major Repair Work
II-I-3.6.8.3b(6)(c)	Trials, Inspections and Certification Minor Availabilities	<ul style="list-style-type: none"> ● Perform 100% audit of FBW SCS Upgrades/Alterations or Major Repair Work
II-I-3.6.8.3.9	Sea Trials	<ul style="list-style-type: none"> ● Authorize the ship to get underway for Sea Trials. Notify TYCOM of satisfactory completion of Fast Cruise
II-I-3.6.8.3.11c	Availability Completion Prerequisites	<ul style="list-style-type: none"> ● Certify to TYCOM material condition of parts of ship installed, repaired and/or tested by the ISEA activity

Section	Area of Responsibility	Responsibility
II-I-3.6.8.4.1d	Trials and Inspections	<ul style="list-style-type: none"> • Conduct periodic monitoring of ships • Conduct a Pre-Critical Inspection of the Engineering Department • Schedule a salvage inspection • Conduct a formal Phase I certification inspection of the ship's company • Prior to Fast Cruise, conduct a formal audit of Ship's Force REC and DFS records and CSMP • Witness and certify to the TYCOM that the state of crew training is satisfactory for at-sea operations • Conduct a material inspection of the ship • Report satisfactory completion of inspections to the TYCOM • Review the scope, schedule and agenda of tests for Sea Trials • Prior to Sea Trials, report the material certification of the ship to the TYCOM • Advise the TYCOM of escort requirements • Arrange for SRDRS to be on "modified alert" during Sea Trials • Provide updated Sea Trials status to COMSUBRON ELEVEN if "mod-alert" support services are in use • Provide an operation order • Arrange for the embarkation of technical personnel • Arrange for assignment of operating areas and communications frequencies • Assign a submarine qualified officer to act as TYCOM representative embarked during Sea Trials • When authorized by the TYCOM, grant permission for the Ship's CO to commence Sea Trials • Upon completion of Sea Trials, report to the TYCOM the status of Forces Afloat work performed within the SUBSAFE boundary
II-I-3.6.8.4.4b(3)	Pre-Critical Inspection	<ul style="list-style-type: none"> • Conduct a Pre-Critical Inspection within six weeks of intended criticality
II-I-3.6.8.4.7b(5)	Sea Trials	<ul style="list-style-type: none"> • Designate a minimum of one officer qualified in submarines and ensure a sufficient number of officers qualified in submarines will be embarked during the escort duty

Section	Area of Responsibility	Responsibility
II-I-4.4.1.1	Common Elements	<ul style="list-style-type: none"> • Coordinate scheduling of availabilities at LMAs • Monitor corrective maintenance action • Schedule and conduct inspections • Monitor progress • Initiate budgetary actions for funding availabilities • Alterations identified by priority based on material availability • Identify routine packages • Review results of monitoring inspections and testing • Identify special evolutions • Issue availability planning message • (Submarines) Ensure PMR and URO MRC actions are identified • (Submarines) Send Sea Trials Support Services message • (Submarines) Provide updated Sea Trials Status • (Submarines) Identify key events for each CMAV • (Submarines) Monitor Ship and Executing Activity preparations to transition to a CMAV period
II-I-4.5.4	Ship Certification Prior to Underway	<ul style="list-style-type: none"> • Perform 100% audit of FBW SCS Upgrades/Alterations or Major Repair Work
II-I-4.9.1	Interim Drydocking/Pre-Inactivation Restricted Availabilities (Submarines)	<ul style="list-style-type: none"> • Authorize new items and growth industrial work items • Monitor and approve changes in established milestones • Issue direction when Industrial Activity work is in question • Notify TYCOM when Ship's Force work can not be completed • Periodically monitor and assess shipboard conditions • ISIC QA officer will conduct audit of Ship's Force Re-entry Control and Departure from Specification Records • Conduct material inspection prior to Fast Cruise
IV-3.3.6	Boiler Inspections	<ul style="list-style-type: none"> • Maintain overall cognizance of SGPI Program • Schedule routine inspections • Arrange for availability of SGPI during CAI • Monitor follow-up action • Assist COs in arranging for corrective action when requested

Section	Area of Responsibility	Responsibility
IV-14.2.3	Magazine Sprinkler Inspection Requirements	<ul style="list-style-type: none"> • Ensure scheduling of Shipboard Explosive Safety Inspection • Follow-up on all discrepancies posted by verification activity • Act as sole grantor of all magazine sprinkler systems re-certification
IV-18.3.1	Submarine Salvage Inspection	<ul style="list-style-type: none"> • Submarine Salvage Inspection
IV-21.2.1	Submarine Oxygen Generating Plants	<ul style="list-style-type: none"> • Ensure assigned units are in compliance with paragraph 21.1.1 • Conduct periodic inspections and audits • Ensure PMT inspectors perform material inspections of the ship's EOGs
IV-23.2.2.6	Gas Turbine Engine Inspection	<ul style="list-style-type: none"> • Monitor the follow-up action to correct noted discrepancies by randomly sampling ship's files and reports • Assist Commanding Officers in arranging for corrective action items beyond the capability of Ship's Force
IV-26.2.2	Board of Inspection and Survey Material Inspections Policy	<ul style="list-style-type: none"> • (Surface Force Ships only) The ISIC, if deployed, will request assistance with inspection preparations • Monitor ship's preparation for MI • Surface Ships ISIC conduct an inspection readiness assessment prior to submitting reports • Ensure post inspection reporting procedures followed • Attend post-INSURV inspection critiques • Ensure subordinate commands are prepared for scheduled INSURV • Ensure ship is prepared to discuss deficiencies not corrected and items removed from CSMP • Ensure preparation for the sequence of accomplishing inspection underway demonstrations is conducted in advance of inspection • Monitor reporting and correction of MI deficiencies

Section	Area of Responsibility	Responsibility
V-I-1.4.1	Organizational Responsibilities	<ul style="list-style-type: none"> • Organize and implement a QA program • (Submarines) Organize and implement program to verify performance of required maintenance • Organize and implement a work request screening process • (Submarines) Review Ship's Force Controlled Work Packages • (Submarines) Ensure ship's certification continuity report is received before ship is underway • Review and sign MOA • (Submarines) Administer a DFS system • Monitor QA program and procedures • Schedule and conduct QA program assessment • Review and endorse TYCOM audit report • Conduct periodic monitoring of Ship's Force work and QA program • (Submarines) Perform annual SUBSAFE/SOC/FBW SCS awareness training • (Submarines) Conduct oral interview with Ship's Force relieving QAO • Ensure fact-finding critiques are held to establish causes of errors during maintenance • Provide sufficient time for crew training during Upgrades/Alterations or Major Repair Work on the FBW SCS • Conduct FBW SCS certification audits • Report by message, crew readiness and verification from the ISEA/activity performing work that work necessary for at-sea testing is complete • Certify to the TYCOM the FBW SCS material condition of parts installed, repaired and/or tested by the ISEA is satisfactory • Transmit a Submarine Material Transfer Message to the gaining ISIC for deploying/ deployed submarines when the unit out chops
V-I-2D-1	Formal Work Package Approval	<ul style="list-style-type: none"> • Review Ship's Force and RMC/FMA prepared CWP's • (Submarines) At the end of every FMA upkeep, verify all SUBSAFE deficiencies in the ship's CSMP have been corrected or have an appropriate DFS • (Submarines) Prior to submerged underway operations when submarines are in a port with an ISIC, the ISIC QAO shall complete a QA Pre-Underway Checklist
V-I-5.9.4c	Objective Quality Evidence to Support Controlled FBW SCS Work	<ul style="list-style-type: none"> • Perform 100% audit of FBW SCS Upgrades/Alterations or Major Repair Work

Section	Area of Responsibility	Responsibility
V-I-8.3.1g and V-I-8.3.7e(2)	Departure from Specification Procedures	<ul style="list-style-type: none"> • Provide the Job Control Number and Departure serial number for Departures initiated by a depot level activity
V-I-9.3.3	Assessments, Audits and Surveillance	<ul style="list-style-type: none"> • Schedule and conduct a QA Program assessment of all assigned ships • Conduct additional periodic audits and surveillance • Conduct 100% audit of CWPs for SUBSAFE work accomplished by Forces Afloat • Conduct audit of UROs assigned to Forces Afloat • Conduct review of all outstanding Forces Afloat DFSs • Vertical audits of all Forces Afloat CWPs • Perform 100% audit of FBW SCS Upgrades/Alterations or Major Repair Work
V-III-1.2.2	Organizational Responsibilities	<ul style="list-style-type: none"> • Organize and implement a QA program • Organize and implement a program to verify performance of required maintenance • (Submarines only) Organize and implement a work request screening process • Ensure DSS certification continuity report is received and reviewed before DSS manned use • Review and approve User/Sustaining Activity requests prior to conducting manned operations • Review and sign the Memorandum of Agreement • Administer a DFS system • (Submarines only) Monitor the QA program and procedures of assigned FMA and monitor corrective actions • (Submarines only) Schedule and conduct a QA program assessment • (Submarines only) Review and endorse TYCOM audit report of assigned FMA(s) • Conduct periodic monitoring of Ship's Force work and QA program • Properly maintain certification on assigned DSS • Review and evaluate User/Sustaining Activity reports of corrective action • Ensure Sustaining Activities perform internal surveys • Ensure Sustaining Activities process requests for sustaining certification • Perform QA assessments associated with the DSS and host submarines • Route appropriate DSS SOC DFSs for approval • Conduct vertical audit of assigned DSS unit's OQE • Perform annual SOC awareness training • Ensure fact-finding critiques are held

Section	Area of Responsibility	Responsibility
VI-3.2.1	Submarine Fleet Modernization Program	<ul style="list-style-type: none"> • Inform FMA of upcoming availabilities • Monitor FMA modernization and availability planning • Establish installation priorities • Ensure no action is taken to accomplish alterations which are not authorized for accomplishment • Maintain a file of alteration briefs • Assist units in preparation of alteration requests • Identify deficiencies and changes to hull applicability of alterations • Ensure only TYCOM authorized or partially completed alterations appear on CSMP • Ensure MJC contains all alterations authorized for accomplishment • Ensure all OPNAV4790/CKS are collected 3 days prior to end of availability • Ensure RPCCRs are distributed to ship's CO • Ensure situational alterations are accomplished • Inform ships of alterations planned during an availability • Verify reports of alteration completions during CNO availabilities • Ensure Forces Afloat alterations are completed to maximum extent prior to CNO availability • For deploying units, provide to FMA a list of alterations to be completed during deployment upkeep • Allocate portion of FMA ROV for procuring alteration material for installation by Forces Afloat • Before installation begins, ensure MOA is in place for any alteration accomplished by industrial activity • Ensure installation of TEMPALTs/OPALTs is in accordance with reference (f) • Ensure alteration by AIT in accordance with reference (g) • Ensure FMA obtains TYKITs RFI • Ensure category "A" A&I's completed within 12 months of the date of authorization • Ensure that category "B" A&I's are completed within 24 months of the date of authorization • Prepare and forward TAMs • Ensure FBW SCS alterations in accordance with reference (h)
VI-5.2.2	Deficiency Documentation and Reporting	<ul style="list-style-type: none"> • Screen and technically review all submitted 4790/2Ks • Technically review all submitted CASREPs

Section	Area of Responsibility	Responsibility
VI-8.2.2	Miniature/Micro-miniature Electronic Repair Program	<ul style="list-style-type: none"> • Coordinate and manage 2M program • Monitor effectiveness of 2M program • Implement progressive repair procedures • Coordinate logistic support, outfitting requirements and deployment priorities • Monitor 2M certification status • Schedule 2M certifications in conjunction with C5RA/TSRA • (Aircraft Carriers) Conduct MTRF in accordance with reference (e)
VI-9.2.4	Metrology and Calibration Program	<ul style="list-style-type: none"> • Monitor calibration readiness status within their respective organizations • Monitor effectiveness of electronic and SGCP FCAs • Ensure that ships with FCAs extend their service to other ships in company • Ensure each ship has necessary standards, documentation and trained personnel to maintain certification • Coordinate resolution of calibration problems • (Submarines) Ensure each activity supports the TYCOM Calibration Program of Record • (Submarines) Support and participate in the TYCOM's CTRA process
VI-11.5.2	Maintenance, Repair and Overhaul of Service Craft, Landing Craft and Small Boats	<ul style="list-style-type: none"> • Review overhaul progress reports • Review Ship's Force and FMA concurrent work • Ensure directives are followed concerning safety • Attend Sea Trial and overhaul completion review conferences • Assist in all aspects of planning and monitoring of industrial availabilities
VI-12.3.2.1	Degaussing (ships with installed degaussing systems)	<ul style="list-style-type: none"> • Monitor degaussing readiness of assigned ships • Ensure ships "check range" as required • Issue waivers to check ranging and deperming requirements if necessary
VI-12.4.1.1	Submarines Without Installed Degaussing Systems	<ul style="list-style-type: none"> • Ensure ships "check range" as required • Schedule ships with unsat magnetic signatures for flash deperming • Issue waivers to check ranging and deperming requirements if necessary
VI-19.2.1.3	Ship Maintenance and Material Management	<ul style="list-style-type: none"> • Designate 3M Officer
VI-22.2.2.3b.	Unplanned TRIPER Change Out	<ul style="list-style-type: none"> • Assign the job to an FMA

Section	Area of Responsibility	Responsibility
VI-23.3.1	Submarine Noise Reduction	<ul style="list-style-type: none"> • Assign a Staff Noise Reduction Officer • Oversee and supervise Noise Reduction Program within Squadron • Submit requests for Beartrap Acoustic Radiated Trials • Schedule acoustic surveys during operating cycles of submarines • Recommend and/or authorize corrective actions • Review records, results, procedures and equipment during material readiness inspections • Schedule divers for underwater hull and propeller surveys • Report propeller replacements • Ensure support personnel trained in noise reduction
VI-24.7.3	Periodic Maintenance Requirement Program	<ul style="list-style-type: none"> • Schedule and ensure completion of PMR work within planned periodicity in the CMP • Calldown all PMRs planned for accomplishment into the CSMP by availability dates • Maintain auditable records of PMR accomplishment for each submarine • Maintain automated database of Logistic Data System, Planned/Refit Maintenance Management System • Notify SUBMEPP Code 1814 of non-receipt of quarterly PMR Inventories and schedules • Keep local scheduling system correct and accurate • Make every attempt to accomplish PMRs on or before the next scheduled due date. Ensure PMRs not completed by SUBMEPP due date are rescheduled • Ensure all I-Level PMRs are scheduled for accomplishment by FMA prior to end of availability • Review completed AWRs prior to closeout • Transfer PMRs to other FMAs as necessary • Non-scheduled repairs of PMR components • Provide assigned ship's training in TYCOM PMR scheduling system

Section	Area of Responsibility	Responsibility
VI-25.3.3	Unrestricted Operations	<ul style="list-style-type: none"> • Maintain auditable records of URO MRC accomplishment • Perform periodic audits of assigned FMAs • Maintain a file of current URO MRC inventories and schedules as provided by SUBMEPP • Coordinate accomplishment of URO MRCs in accordance with SUBMEPP provided PMR inventories and schedules. Monitor the URO MRC/DSS HIP Status Web Site periodically • Control input of SUBMEPP scheduling file • Ensure all URO MRC requirements are in the CSMP • Request approval from TYCOM for deviations from required periodicities • Establish procedures to affect routing of completed AWRs • Ensure accomplishing activity immediately reports conditions that would result in reduced inspection periodicity • Monitor timely submission of URO MRC data reports and reports of accomplishment • Review ship's certification continuity report prior to underway period • Parent ISIC of deploying ships: ensure URO MRC due for accomplishment during deployment is in CSMP transfer file, provide message to applicable deployed FMA • Deployed squadrons will review URO MRC status of deployed submarines at in-chop • Prior to start of CNO availability: assign JCNs as necessary, reassign URO MRCs not completed • During availability, URO MRCs not accomplished during depot period will be placed on guarantee list or reassigned • Prior to CNO availability completion, audit URO MRCs assigned to Forces Afloat by the AWP • Following availability completion ensure all MRCs were reported and subsequently updated by SUBMEPP
VI-27.3.2	Scheduled Preservation Upkeep Coordinated Effort	<ul style="list-style-type: none"> • Schedule and coordinate SPRUCE upkeeps • Coordinate submarine crew training • Monitor effectiveness of program • Chair a debrief with Ship's Force and FMA to review effectiveness of SPRUCE
VI-28.6.1	Cableway Assessment	<ul style="list-style-type: none"> • Ensure assigned ships are scheduled to receive cableway assessments and training
VI-33.4.3	Provide Controls to Maintenance Team (April)	<ul style="list-style-type: none"> • Provide ship operational schedule information to the Maintenance Team

Section	Area of Responsibility	Responsibility
VI-37.5d	Regional Maintenance Center Passive Countermeasure System Support Requirements	<ul style="list-style-type: none"> • Submit requests to schedule PCMS core activities for each unit • Review and take the appropriate action to correct PCMS discrepancies for subordinate units
VI-38.3.3	DSS Hull Integrity Procedures	<ul style="list-style-type: none"> • Maintain auditable records of DSS HIP accomplishments • Conduct periodic audits of assigned FMAs • Maintain a file of DSS HIP inventories and schedules • Assist in preparation and approve DSS HIP performance schedule • Ensure review and implementation of DSS HIP procedural inventories and schedules • Ensure all DSS HIP requirements are in the CSMP • Request approval from TYCOM for deviations from DSS HIP requirements and periodicities • Establish procedures for routing of completed DSS HIP AWRs • Monitor the timely submission of DSS HIP data report forms and report of accomplishment • Review vehicle's certification continuity report prior to underway period • Ensure DSS HIPs due for accomplishment during deployment are in CSMP transfer file • Provide message to deployed FMA/Squadron identifying DSS HIPs to be accomplished and materials required for period of deployment • Audit DSS HIPs assigned to Forces Afloat by the AWP
VI-40.5.2	(SUBS) Messages	<ul style="list-style-type: none"> • Review and take for action all (SUBS) messages • Track (SUBS) messages sent or initiated by submarines under its cognizance • Track (SUBS) messages initiated by the ISIC
VI-41.5	Planning Board for Maintenance	<ul style="list-style-type: none"> • Attend regularly scheduled Planning Board for Maintenance meetings between the ship's Maintenance Team members and stakeholders
VI-42.6.2	Material Assessment	<ul style="list-style-type: none"> • Schedule and authorize material assessments • Define the scope of material assessment • Provide funding for execution and support • Conduct periodic reviews of the material assessment process • Establish standards of effectiveness to ensure program improvement • Evaluate unit's ability to self assess and report training deficiencies

Regional Maintenance Center Commander

Section	Area of Responsibility	Responsibility
II-II-1.2.1	Surface Ship Maintenance	<ul style="list-style-type: none"> Overall responsibility for efficient planning, brokering and execution of all ship maintenance and modernization for assigned ships
IV-3.3.5	Boiler Inspections	<ul style="list-style-type: none"> Coordinate inspections in cognizant maintenance areas Maintain an up-to-date status of required steam generating plant inspections
IV-17.3.4	Steam Catapult Inspection	<ul style="list-style-type: none"> Provide a certified SGPI when requested by the ship, ISIC or TYCOM to conduct accumulator inspections
IV-23.2.2.5	Gas Turbine Engine Inspection	<ul style="list-style-type: none"> Coordinate inspections in cognizant maintenance areas Maintain an up-to-date status of required marine gas turbine system inspections
IV-27.3.4	Steam Boiler Inspection	<ul style="list-style-type: none"> Provide certified SGPIs to perform inspections
V-I-1.6.1	Quality Assurance for Maintenance, Repair and Alteration	<ul style="list-style-type: none"> Designate the RMC/FMA QAO (Submarines only) Provide a written report of certification Certify the qualifications of QA personnel Ensure the RMC/FMA has an effective audit and surveillance program Initiate a semi-annual evaluation of the RMC/FMA QA Program (Submarines) Implement all aspects of the SUBSAFE and FBW-SCS programs
V-I-1.6.3m	RMC/FMA Responsibilities	<ul style="list-style-type: none"> Ensure fact-finding critiques are held Contact the ISIC for issues that will result in a SUBSAFE critique

Section	Area of Responsibility	Responsibility
VI-2.6.2	Technical Assistance	<ul style="list-style-type: none"> • Ensure sufficient capability exists to provide timely response to all requests for technical assistance • Ensure RMC mission funds are used to fund all FTA efforts • Ensure technical support is provided to Fleet units. • Ensure the initial response to every FTA request is via Distance Support • Ensure personnel responding to a request for technical assistance are thorough in their review of the specific technical problem • Ensure acknowledgment and response to all FTA requests • Ensure personnel providing on-site technical assistance keep the cognizant ship's department head or designated representative informed • Ensure FTA data is required to be entered into the Common Submarine Problem/ Maintenance Reporting System • Ensure a TAVR is submitted at the completion of an on-site FTA • Ensure an E-mail TAVR is required at the completion of an on-site FTA on Surface Force Ships/Carriers • Task other Source of Support provider who responds to an on-site FTA submit a TAVR or task them to provide the technical information for the cognizant RMC to generate a TAVR. • Ensure submission of a message report if an on-site assist visit is terminated • Track all requests for FTA using approved FTA software • Ensure technicians providing FTA to submarines are eligible for access to Sensitive Compartmented Information
VI-8.2.5	2M/MTR Fleet Coordinators	<ul style="list-style-type: none"> • Maintain qualified 2M/MTR Fleet Coordinators

Section	Area of Responsibility	Responsibility
VI-31.3.3	Business Responsibilities	<ul style="list-style-type: none"> • Execute surface ship maintenance • Develop a consolidated spending plan for the execution year • Issue quarterly spending controls to all of the Maintenance Teams • Evaluate Maintenance and Modernization Business Plan adjustment requests • Redistribute controls across the surface ship Maintenance Teams • Provide an impact statement to the TYCOM regarding the effect on the execution of maintenance • Provide a recommendation to minimize the impact on Force readiness • Evaluate the financial status of each of the Maintenance Teams on a monthly basis • Submit end of quarter financial summary reports to the respective surface TYCOM • Use Emergency Maintenance funds to execute CNO availability or CM maintenance • Determine when Emergency Maintenance funds should be used for the correction of C2 CASREPs or other non-CASREP related, but nonetheless urgent maintenance • Approve any planned delay of action on a CASREP • Generate monthly reports for all assigned ships planning, in or having completed Hot Wash following completion of a CNO availability
VI-35.3.2	RMC I-Level Maintenance Capabilities	<ul style="list-style-type: none"> • Provide the capabilities identified in Appendix A in accordance with all applicable policy, regulations and technical requirements. Ensure detailed capability manuals are issued by each RMC • Coordinate with the TYCOMs to ensure full utilization of the funded capacity • Provide cost estimates and implementation plans to the Fleet Commanders for proposed additions and deletions to capabilities as well as increases or decreases to capacity at any/all RMCs • Establish policy, requirements and direction for NAMTS program management and execution at RMCs • As MAT Program Manager, establish requirements and guidance for the execution of MATs at the RMCs including reporting requirements • Coordinate with the cognizant TYCOM on the establishment, disestablishment and utilization of MATs

Section	Area of Responsibility	Responsibility
VI-37.5e	Countermeasure System Support Requirements	<ul style="list-style-type: none"> • Maintain qualified PCMS personnel and ensure assets are available to perform PCMS core activities • Provide technical assistance via distance support/on site visit as appropriate • Conduct PCMS core activities • Ensure all personnel assigned to PCMS responsibilities meet the requirements • Ensure that RMC PCMS SMEs are involved in planning of all PCMS equipped ship topside maintenance where PCMS is affected • Ensure that RMC QA personnel, certified by the PCMS ISEA, are actively involved in the QA of all I and D-Level PCMS related repairs and installations • Ensure that contracted or I-Level jobs activities, facilities and personnel are certified • Include in contracted I and D-Level jobs the provision of PCMS tiles for planned PCMS repairs and interference areas
VI-41.6	Workforce Development Program	<ul style="list-style-type: none"> • Serves as the Work Force Development Program sponsor • Serves as the Curriculum Control Authority for all WFD training courses and curricula
VII-6.6.2	Maintenance Center Funding	<ul style="list-style-type: none"> • Develop a consolidated spending plan for the execution year • Determine when Emergency Maintenance funds should be used for the correction of C2 CASREPs or other non-CASREP related, but nonetheless urgent maintenance

Ship's Commanding Officer

Section	Area of Responsibility	Responsibility
II-I-3.3.7.6	Maintenance Policies and Procedures	<ul style="list-style-type: none"> • Review AWP's and provide comments to TYCOM, ISIC and SUBMEPP • Assign a Ship's Selected Records Coordinator • Publish policies concerning the ship status and crew before availability starts • Ensure non-conformances submitted during the availability are approved prior to Sea Trials and not later than the completion of the availability <p>(Submarines Only)</p> <ul style="list-style-type: none"> • Review status of PMR maintenance schedules and CSMP reports with ISIC prior to CNO availability • Maintain a current SUBMEPP PMR inventory
II-I-3.6.8.3.11b	Availability Completion Prerequisites	<ul style="list-style-type: none"> • Verify satisfactory completion of all Sea Trial evolutions
II-I-3.6.8.4.1e	Responsibilities for trials and inspections	<ul style="list-style-type: none"> • Carry out responsibilities per reference (e) • Develop and execute training plans and documents • Supervise operation of nuclear propulsion plant • Prepare ship's engineering personnel; and propulsion plant spaces for inspection • Maintain PMS, SUBSAFE re-entry control, RPPMS, in accordance with applicable references • Participate in at-sea periods prior to the first Sea Trials • Review Sea Trial agenda and concur • Undergo salvage inspection • Conduct one day Ship's Force dock trials • Demonstrate state of training of the crew • Ensure all alongside tests, inspections, and trials are conducted • Certify to designated ISIC/TYCOM representative that all salvage inspections discrepancies have been corrected • Concur with Supervising Authority message • Report by message to TYCOM that ship and crew are ready for Sea Trials • When authorized conduct a Fast Cruise • Concur with Supervising Authority message • Report completion of Fast Cruise to TYCOM • When requirements of this instruction are complete and permission is received proceed to sea

Section	Area of Responsibility	Responsibility
IV-3.3.7	Boiler Inspections	<ul style="list-style-type: none"> • Request inspections and recommend desired dates to ISIC • Prepare for scheduled inspections • Review inspection results and initiate corrective actions • Assess impact of corrective actions on operating schedules • Submit reports per paragraph 3.7.2 • Conduct boiler inspections by appropriate PMS item
IV-5.3.2	Marine Sanitation Devices	<ul style="list-style-type: none"> • Oversee correction of discrepancies on MSD system installations • Prevent food stuffs from being stored in areas below sanitation valves, flanges, or take-down joints • Log each unavoidable discharge of prohibited sewage in restricted waters
IV-14.2.1	Magazine Sprinkler Inspection Requirements	<ul style="list-style-type: none"> • Sprinkler systems tested in accordance with PMS • Magazine temperatures checked and recorded daily • Magazines are properly maintained • Cognizant industrial activities provide written verification that system is operational • System inspection requirements in accordance with reference (a) and PMS • System verification inspection prior to weapons on-load • Take action to correct discrepancies noted during inspection • Ensure design discrepancies reported to TYCOM and entered in CSMP
IV-16.4.1.1	Aircraft Launch and Recovery Systems for Aviation Ships	<ul style="list-style-type: none"> • Request CAFSU technical assistance when required • Provide berthing and messing for CAFSU representatives • Pass to TYCOM any comments concerning performance of CAFSU representatives • Upon completion of CAFSU ensure timely departure from ship
IV-17.3.5	Steam Catapult Inspections	<ul style="list-style-type: none"> • Request inspections and recommend dates for accomplishment • Prepare for scheduled inspections • Conduct Ship's Force responsible inspections • Review inspection results and initiate corrective actions • Assess impact of corrective action on ship's operating schedule • Submit reports • Schedule inspections as required by appropriate PMS/Class Maintenance Plan items

Section	Area of Responsibility	Responsibility
IV-18.3.2	Submarine Salvage Inspection	<ul style="list-style-type: none"> • Request ISIC to conduct salvage inspection • Coordinate support requirements as needed by inspection team • Complete and forward a pre-inspection information letter • Assemble all ship's data indicated in applicable appendix • Take action to correct discrepancies found and report corrections to ISIC • Submit CASREP if applicable
IV-20.2.9	Diver Life Support Systems, Submarine Rescue Chamber and Dry Deck Shelter Maintenance and Certification	<ul style="list-style-type: none"> • Maintain certification of DLSS • Ensure deficiencies identified during recertification inspection are corrected in an expeditious manner • Readiness of DLSS to meet operational requirements • Maintain QA program and re-entry procedures
IV-21.2.3	Submarine Oxygen Generating Plants	<ul style="list-style-type: none"> • Report reduced status in accordance with established procedures • Maintain EOG personnel qualifications • Prohibit operation of EOGs if necessary • Maintain EOG material maintenance log • Ensure EOG material maintenance log is periodically reviewed • Safety related deficiencies promptly entered into ESL • Prior to availability, ensure PMT conducts material inspection of EOGs • Ensure PMT conducts post-availability material inspection • Ensure PMT conducts operational inspection • Ensure electrolysis is secured and EOG is in safe condition prior to drills involving loss of power
IV-23.2.2.7	Gas Turbine Engine Inspection	<ul style="list-style-type: none"> • Request gas turbine inspections • Prepare for scheduled inspections • Review inspection results and initiate corrective action for those items within Ship's Force capability • Assess the impact of corrective action on operating schedules. Decide the optimum timing of repair actions • Submit reports • Schedule gas turbine inspections as required by PMS/Class Maintenance Plan item

Section	Area of Responsibility	Responsibility
IV-26.2.3	Board of Inspection and Survey Material Inspections Policy	<ul style="list-style-type: none"> • Ensure ship is prepared for MI • Promulgate a ship wide Plan of Action and Milestone in preparation for INSURV • Be prepared to discuss items from previous INSURV which is still on CSMP • Designate INSURV coordinator • Assign senior coordinator for each INSURV departmental category • (Surface Force Ships only) Submit a letter of concern to INSURV/TYCOM/ISIC
IV-27.3.5	Steam Reboiler Inspection	<ul style="list-style-type: none"> • Request inspections via Naval message to the TYCOM • Prepare for the scheduled inspections • Conduct Ship's Force responsible (Annual) inspections • Review inspection results and initiate corrective action for deficiencies within Ship's Force capability. Initiate requests for actions beyond Ship's Force capability and for deferred items. Submit a CASREP for discrepancies that will impact operational schedule. • Assess the impact of corrective action on the ship's operating schedules. Advise the TYCOM and operational commanders of adverse effects. • Submit reports
V-I-1.5.1	Organizational Responsibilities	<ul style="list-style-type: none"> • Designate QAO in writing • Approve TWD as required • (Submarines) Provide ISIC written report of ship's certification continuity prior to underway • (Submarines) Maintain material condition necessary to support URO to authorized operating depth • (Submarines) Organize and implement a program to ensure performance of required maintenance to support FBW unrestricted operations • (Submarines) Organize and implement a program to ensure performance of required maintenance to support DSS-SOC • (Submarines) Approve and sign recertification RPWAR • Certify QA personnel qualifications • Review and sign MOA prior to start of SUBSAFE, nuclear, FBW SCS, Level I work • Approve DFSs

Section	Area of Responsibility	Responsibility
VI-2.6.1	Fleet Technical Assistance	<ul style="list-style-type: none"> • Ensure FTA requests are accurate, complete and timely • Ensure FTA requests reference a JCN and contain a detailed problem description • Ensure associated CASREP and/or 2-Kilo address whether or not on-site assistance will be required if Distance Support is unable to resolve the issue for FTA requests associated with systems that are not required to meet current/projected mission tasking • Ensure TYCOM/ISIC are informed of technical issues • Ensure distance support alternatives are exhausted before requesting on-site technical assistance • Ensure qualified Ship's Force technicians are available for support • Upon completion of technical assistance visit, release FTA personnel • Establish secure, central e-mail account to all RMC techs who visit ship • Issue arrival/departure message
VI-4.8.d	Shipboard Electromagnetic Compatibility	<ul style="list-style-type: none"> • Ensure EMS PMS is conducted • Request EMI survey within six months of deployment or when any new indications of EMI occur • Transmit EMC departure message to cognizant activities • Maintain up-to-date file of EMI/EMC information
VI-8.2.3	Miniature/Micro-miniature Electronic Repair Program	<ul style="list-style-type: none"> • Establish 2M program under cognizance of Electronics Material Officer and Combat Systems Officer • Maintain certified 2M stations and technicians • Screen and repair all CCAs/Ems • (Aircraft Carriers) establish MTRF with an overall coordinator • (Aircraft Carriers) maintain an active MTRF
VI-9.2.5 (All Forces)	Metrology and Calibration Program	<ul style="list-style-type: none"> • Maintain high degree of TAMS calibration readiness • Appoint a calibration coordinator • Maintain TMDE allowances in the SPETERL • (Submarines) Prior to completion of a CTRA, deliver excess, rejected and obsolete (PRI 95) test equipment to the designated CTRA center. • Use only standard test equipment listed in reference (h) • Ensure TMDE is submitted for calibration prior to the calibration due date • Submit pre-deployment calibration requirements to the RMC METCAL Coordinator at least 60 days before deployment • Maintain calibration readiness goal

Section	Area of Responsibility	Responsibility
VI-9.2.6 (Surface Force)	Metrology and Calibration Program	<ul style="list-style-type: none"> • Ensure the SGCP FCA is currently certified and properly staffed • Ensure calibration of all instrumentation by Ship's Force is within their SGCP FCA capability • Ensure the CRL is used as a technical authority guidance to determine calibration requirements for all installed instruments • Use a TYCOM approved formal recall system • Ensure FCA equipped ships offer support to other ships • Request calibration services, beyond the capability of the onboard FCA, from the RMC METCAL Coordinator • Maintain liaison with the RMC METCAL Coordinator for off-ship calibration • Use the RLP for maintenance requirements while the ship's test equipment is being calibrated • Ensure all TMDE has a current calibration sticker • Ensure all calibration is conducted at the lowest level of calibration feasible • Ensure all ship's instrumentation appears in a formal calibration accounting and recall system
VI-9.2.7 (Naval Air Force)	Metrology and Calibration Program	<ul style="list-style-type: none"> • Follow the detailed procedures outlined in reference (j) for TMDE management and operation of the consolidated FCA
VI-11.5.3	Maintenance, Repair and Overhaul of Service Craft, Landing Craft and Small Boats	<ul style="list-style-type: none"> • Coordinate planning aspects of craft and/or boat overhauls with TYCOM/ISIC • Prepare and submit overhaul progress reports • Ensure enough trained personnel are assigned to on-site monitoring of crafts and boats • Fulfill responsibilities for safety of craft and personnel
VI-12.3.2.2	Degaussing	<ul style="list-style-type: none"> • Maintain ship's installed degaussing system • Maintain ship's degaussing folder • Submit a minor Departure From Specification if range checking requirements are not met
VI-12.4.1.2	Degaussing (Submarines without degaussing systems)	<ul style="list-style-type: none"> • Ensure magnetic signature minimized by periodic check ranging • Inform ISIC of unsat ranging • Maintain ship's degaussing folder • Undergo flash deperming as directed • Before flash deperming prepare ship's equipment and off-load sensitive material • Submit a minor Departure From Specification if range checking requirements are not met

Section	Area of Responsibility	Responsibility
VI-16.2.2.1.6	Habitability Improvement	<ul style="list-style-type: none"> • Assign project manager and petty officer supervision • Assign labor force for removal, space preparation and installation • Conduct training programs • Accept delivery, store and account for materials • Coordinate all required tag-out/in paperwork and Work Authorization Forms • Dispose of all retrograde material generated by the project • Report changes to Naval Inventory Control Point • Report completion to TYCOM • Ensure ship's selected records are updated
VI-18.6.1	Inflatable Life Rafts	<ul style="list-style-type: none"> • Submit OPNAV 4790/2K for any life raft requiring replacement or recertification • Maintain log or database of all life rafts onboard • Send report to NSWCCD/TYCOM if life raft is lost or transferred to another ship • Ensure life raft fiberglass containers are handled with care • Upon decommissioning contact designated Life Raft Contingency Pool • Requisition replacement life rafts when necessary
VI-23.3.3	Submarine Noise Reduction	<ul style="list-style-type: none"> • Establish and maintain Ship's Noise Reduction program • Appoint Senior Department Head as Noise Reduction Officer
VI-24.7.5	Periodic Maintenance Requirement Program	<ul style="list-style-type: none"> • Responsible for execution of PMR work on ship • Document discovered maintenance deficiencies • Maintenance deficiencies will reflect block 46 of OPNAV 4790/2K • Review Depot Availability Work Packages • Review status of PMR maintenance in SUBMEPP quarterly PMR schedules • Deficiencies in equipment covered by PMR should be documented • Ensure quarterly PMR schedules and inventories are carried onboard • Ensure MRCs, MSs and TRSs are referenced and used during equipment maintenance • Report repairs to PMR covered components to ISIC • Ensure completed AWRs and PMRs are signed as completed by Ship's Force • At the conclusion of an availability, provide to the ISIC the reason that any PMRs could not be accomplished

Section	Area of Responsibility	Responsibility
VI-25.3.4	Unrestricted Operations	<ul style="list-style-type: none"> • Ensure URO MRCs are accomplished within required periodicity • For visual inspections between URO MRC 003 inspections use Volume V, Part I, paragraph 5.4.3.d • Maintain auditable records of accomplishment of URO MRCs
VI-27.3.4	Scheduled Preservation Upkeep Coordinated Effort	<ul style="list-style-type: none"> • Ensure preservation is performed using procedures in references (c) and (e) • Ensure Ship's Force are relieved of all requirements except those necessary to maintain safety and security of ship • Designate SPRUCE manager • Ensure ship is divided into preservation zones • Submit completion letter to TYCOM
VI-28.6.5	Cableway Assessment	<ul style="list-style-type: none"> • Assign Ship's Force personnel for FMA cableway assessment repair training • Correct outstanding discrepancies • Within 30 days of completion enter all unrepaired category I discrepancies in CSMP
VI-37.5f	Regional Maintenance Center Passive Countermeasure System Support Requirements	<ul style="list-style-type: none"> • (Surface) Scheduling of PCMS activities within periodicity • Obtaining RMC SME assistance in reviewing work packages • Establishment and maintaining the following shipboard organization: PCMS Department Head; Command PCMS coordinator
VI-38.3.4	DSS Hull Integrity Procedures	<ul style="list-style-type: none"> • Ensure DSS HIPs are accomplished within required periodicity • Maintain auditable records of accomplishment of DSS HIPs
VI-40.5.3	(SUBS) Messages	<ul style="list-style-type: none"> • Track (SUBS) messages initiated by the ship • Respond to technical assistance (SUBS) messages • Use guidance of Chapter VI-2 to request technical assistance • Issue TEMPALT and SHIPALT (SUBS) messages

Section	Area of Responsibility	Responsibility
VI-41.2.4.2a.	Specific Duties of Maintenance Team Members	<ul style="list-style-type: none"> • Reports progress weekly to the TYCOM • Works with the Ashore Ship's Maintenance Manager to develop the final work package submission for the ship • Directs efforts to identify all shipboard maintenance requirements. • Initiates requests for technical assistance • Determines the affect of material deficiencies on mission capability and releases Casualty Reports • Integrates maintenance planning in the Ship's Operational Schedule • Ensures the ship is prepared for and ready to conduct: propulsion plant PCD/LOA, combat systems PCD, combat systems light off events • Chairs the Planning Board for Maintenance meeting
VI-41.2.4.2b.	Specific Duties of Maintenance Team Members	<ul style="list-style-type: none"> • Verifies technical assistance final resolution satisfies ship's maintenance issue • Ensures Ship's Force assists with the management and oversight of work execution by maintenance activities and AITs • Executes shipboard DFS process • Ensures ship properly supports 25%/50%/75% reviews • Consolidates software delivery • Ensures Integrated Logistics Support is provided • Assists in scheduling and execution of mid-deployment shipcheck • Collaborates in the authorization of growth/new work • Supports the Integrated Test Plan execution and work certification • Assists in achieving maintenance phase exit criteria. Ensures proper space turnover, Ship's Force AWP collection and management of OQE, and availability technical closeout

Section	Area of Responsibility	Responsibility
VI-42.6.4	Material Assessment	<ul style="list-style-type: none"> • Prepare for assessments events • Designate the unit's assessment event coordinator • Send a readiness to commence assessment message • Provide support for assessment team • Prepare systems/equipment, tag outs, Work Authorization Form, request support services, generate Quality Assurance packages • Ensure there are no conflicting evolutions, training, drills, etc. • Defer scheduling of preventive maintenance requirements • Host assessment event briefings • Ensure the 3-M Coordinator, Functional Area Supervisors, and the Supply Officer are available as needed • Ensure divisional personnel are assigned to work closely with the Assessment Team Subject Matter Experts • Remove key maintenance personnel from the watch bill • Correct material discrepancies as time permits • Send a Quicklook completion message

Quality Assurance Officer

Section	Area of Responsibility	Responsibility
V-I-FWD-App B	Loss of Traceability	<ul style="list-style-type: none"> • Initiate action to restore traceability or use alternate traceable material
V-I-1.5.12	Ship Responsibilities	<ul style="list-style-type: none"> • Administer ship's QA program • Review TWDs • Review FWPs • Verify the FWP specifies the correct OQE • Verify the testing requirements for controlled work are correct • Verify completed test results • Review and close out TWDs as required • Maintain record files as required • Determine suitability for use of material from another ship • Provide disposition instructions for rejected material • Obtain documentation for certified material • Provide technical services to Supply Officer • Authorize downgrading of material • Review requests for DFS • Maintain auditable file of outstanding DFS; audit active DFSs prior to underway • Maintain DFS files • Verify ship's mapping plans, selected records and drawings are updated as required • Submit DFS clearance reports • Manage ship's internal QA surveillance program • Ensure that QA training is conducted as required • Assess QA training • Implement formal qualification program • Conduct oral qualification interviews • Maintain master qualification list as required • (Submarines only) Verify reactor plant hull integrity area maintenance • (Submarines only) Verify REC is initiated for SUBSAFE boundary work as required • (Submarines only) Maintain SUBSAFE REC records including log • (Submarines only) Coordinate with ISIC and FMA to ensure URO MRC program is in accordance with requirements • (Submarines only) Retain QA form 34 as required • Review as many non-nuclear weld records as possible • Verify an active Job Control Number exists for all active temporary DFSs

Section	Area of Responsibility	Responsibility
V-I-1.5.12	Ship Responsibilities	<ul style="list-style-type: none"> • (Submarines) At the end of a scheduled FMA upkeep, verify all SUBSAFE deficiencies in the ship's CSMP have been corrected or have an appropriate DFS
V-I-1.6.11	RMC/FMA Responsibilities	<ul style="list-style-type: none"> • Organize and implement QA program within the RMC/FMA as required • Provide guidance and evaluate efforts to produce work of acceptable standards • Prepare QA procedures as required • Assist in QA audits as required • Provide QA training as required • Approve downgrading of controlled material • Determine suitability for use of controlled material as required • Provide disposition instructions for rejected material • Institute a formal qualification program for QA personnel • Train and qualify work center CMPOs/CMHs • Review RMC/FMA generated DFSs as required • Obtain documentation for certified material • Establish and coordinate procedures for material control • Review, open and close out TWDs as required • Review FWP • (Submarines only) Review and sign RPWAR • Develop QA training program • Maintain current master list of qualifications as required • Establish and administer RMC/FMA QA audit and surveillance program • Maintain QA records and files • Ensure all testing required for completion of TWD is complete and reviewed as required • Perform opening and closing reviews of CWP as required • Supervise QASs, QAIs, Cleanliness Inspectors/Certifiers, CMPOs/CMHs • Conduct QA audits • Maintain QA records and files
V-I-2.3.4g	FWP Approval	<ul style="list-style-type: none"> • Review all FWPs for components or systems assembled as a controlled assembly and performed as a REC/MCR exception
V-I-2.3.7.3	CWP Revisions	<ul style="list-style-type: none"> • Concur with addition of material
V-I-2.3.7.8	CWP Closeout	<ul style="list-style-type: none"> • Review CWP for correctness and completeness • Retain closed CWP
V-I-3.5.1	Maintenance Personnel Training	<ul style="list-style-type: none"> • Provide a list of training topics to ship's departments
V-I-3.5.2	Quality Assurance Training	<ul style="list-style-type: none"> • Establish a separate advanced training program for personnel as required

Section	Area of Responsibility	Responsibility
V-I-5.4.5.1c	Reactor Plant Cleanliness	<ul style="list-style-type: none"> • Upon loss of cleanliness, approve recovery procedures
V-I-5.4.5.2c	Nuclear Steam Plant Cleanliness	<ul style="list-style-type: none"> • Upon loss of cleanliness, approve recovery procedure
V-I-5.6.4b(13)	Re-Entry Control	<ul style="list-style-type: none"> • Establish and maintain CWP/REC log
V-I-8.3.1c	Departure From Specification	<ul style="list-style-type: none"> • Ensure repair for DFS is entered in ship's CSMP
V-I-10.5.4	Qualification Records	<ul style="list-style-type: none"> • Maintain a master list of various qualified supervisors, planners, inspectors and instructors
V-I-10.7	FMA QA Record Retention	<ul style="list-style-type: none"> • Retain material certification and CWP log for life of ship • Maintain records not associated with CWPs as required • Maintain records of assessments, audits, surveillance and evaluations as required • Retain a copy of the last end of fleet maintenance availability certification report to tended submarines • Maintain a master list of qualified CMPOs, Controlled Material Handlers, Cleanliness Inspectors, QAIs, QASs, Oxygen Clean Workers and Oxygen Clean Instructors
V-III-6.3.4c and d	Receipt of SOC Material	<ul style="list-style-type: none"> • Certify MCD-A and MCD-B materials
V-III-6.5.4	Material Re-certification Following Transfer to Outside Agency	<ul style="list-style-type: none"> • Review vendor data, COC and test data
V-III-8.2.4a	Departure From Specification	<ul style="list-style-type: none"> • Ensure repair for DFS is entered in ship's CSMP
VI-18.7	Unserviceable/Rejected Life Rafts	<ul style="list-style-type: none"> • Verify the condition of the rejected life raft
VII-11.5.6.1c	Corrective Action Request	<ul style="list-style-type: none"> • Issue Method C letter when required

Quality Assurance Supervisor

Section	Area of Responsibility	Responsibility
V-I-1.6.13	Organizational Responsibilities	<ul style="list-style-type: none"> • Ensure all testing required for completion of CWP is complete and reviewed • Perform opening reviews of CWP • Perform closing reviews of CWP • Train and supervise QAIs, Cleanliness Inspectors/Certifiers, CMPOs/CMHs and other personnel • Conduct QA audits, surveillance and coordinate corrective actions • Maintain QA records and files including completed CWPs • Review DFS for accuracy and technical merit and forward to QAO
V-I-2.3.7.1	Formal Work Package Changes	<ul style="list-style-type: none"> • Make pen and ink changes to the QA forms in a CWP
V-I-2.3.7.3	Formal Work Package Revisions	<ul style="list-style-type: none"> • For FWPs executed as a part of the CWP, the QAO/QAS will concur with the addition of material
V-I-2.3.7.9	Emergent Controlled Work	<ul style="list-style-type: none"> • Continuously monitor the task and record all actions taken, if a FMA is involved
V-I-5.6.7	Re-Entry Control	<ul style="list-style-type: none"> • Inspect controlled assemblies
V-I-6.3.5.1b	Material Control	<ul style="list-style-type: none"> • File QA form 1 with all applicable documents
V-III-6.3.4c	Material Control	<ul style="list-style-type: none"> • File QA form 1 with all applicable documents

Controlled Material Petty Officer

Section	Area of Responsibility	Responsibility
III-3.4.1.h.(2)(h)	Voyage Repair Policy - Surface Ship	<ul style="list-style-type: none"> • Provide face to face turnover of MIC Level I material to SRU Surveyor
III-3.4.1.i.(2)(f)	Voyage Repair Policy - Surface Ship	<ul style="list-style-type: none"> • Perform joint inspection of MIC Level I material with Ship's Force QAI prior to turnover to contractor
V-I-1.5.16	Ship Responsibilities	<ul style="list-style-type: none"> • Ensure all material under their cognizance is stored and controlled as required • Receipt inspect all LI stock program material, SFCC and NRP received • Request disposition instructions for rejected material • Control previously rejected and now accepted controlled material as required • Maintain custody of controlled material in segregated stowage in accordance as required • Inspect controlled material storage areas as required • Ensure controlled material is properly stowed and handled • Ensure nuclear material received without Ready for Issue tags is certified to the required "Level of Essentiality" • Reject unsatisfactory material • Send any material certification documents for material which has been provided by the ship to the RMC/FMA QA office as required • Perform receipt inspection of package alteration kits that contain controlled material when ready for use • Ensure controlled material markings are on all pieces when cutting a smaller piece from a larger one • Ensure controlled material markings are moved to an unaffected area, if the controlled material item will lose the markings due to a fabrication process (e.g., welding, machining) prior to the fabrication process • Ensure all controlled material is identified, color coded, marked and tagged as required

Section	Area of Responsibility	Responsibility
V-I-1.6.14	RMC/FMA Responsibilities	<ul style="list-style-type: none"> • Receipt inspect all controlled material received • Ensure all material under their cognizance is stored and controlled as required • Inspect controlled material storage areas as required • Ensure controlled material is properly stowed and handled • Reject unsatisfactory material • Send any material certification documents for material which has been provided by a ship along with the QA form 1 to the QA office • Receipt inspect package alteration kits that contain controlled material when ready for use • Control previously rejected and now accepted controlled material as required • Retain custody of controlled material when it is not in the custody of a craftsman or in a controlled material storage area • Ensure controlled material markings are on all pieces when cutting a smaller piece from a large one • Ensure controlled material markings are moved to an unaffected area, if the controlled material item will lose the markings due to a fabrication process (e.g., welding, machining) prior to the fabrication process
V-I-6.3.4	Receipt Inspection of Controlled Material	<ul style="list-style-type: none"> • Receipt inspect controlled materials as required
V-I-6.3.5	Receipt Inspection of Open Purchase or Locally Manufactured Material or Upgrading Supply System Material to Level I	<ul style="list-style-type: none"> • Receipt inspect materials as required
V-I-6.3.8	Level I Stock Program Material Downgrading	<ul style="list-style-type: none"> • Remove markings as required
V-I-6.3.9	Storage, Issue, and Handling of Level I/Submarine Flight Critical Component Stock Program Material	<ul style="list-style-type: none"> • Inspect controlled material storage areas as required • Maintain custody of controlled material as required • Verify transfer of MIC markings as required
V-III-6.3.1	Control of SOC Material	<ul style="list-style-type: none"> • Maintain custody of SOC material as required
V-III-6.3.4	Receipt of SOC Material	<ul style="list-style-type: none"> • Receipt inspect SOC material as required

JOINT FLEET MAINTENANCE MANUAL
VOLUME I
NEW CONSTRUCTION
LIST OF EFFECTIVE PAGES

Page Numbers	Change in Effect	Page Numbers	Change in Effect
i thru vi	Change 5	I-2B-5 thru I-2B-10	Change 1
vii thru viii	Change 3	I-2B-11	Change 3
ix thru xiv	Change 5	I-2B-12	REV C
I-1-1 thru I-1-2	REV C	I-2C-1 thru I-2C-2	Change 1
I-1A-1 thru I-1A-8	REV C	I-2C-3	REV C
I-1B-1 thru I-1B-4	REV C	I-2C-4	Change 1
I-1C-1	Change 5	I-2C-5 thru I-2C-8	REV C
I-1C-2 thru I-1C-3	Change 3	I-2D-1 thru I-2D-4	Change 1
I-1C-4	Change 2	I-2E-1 thru I-2E-2	Change 1
I-1D-1	Change 1	I-2E-3 thru I-2E-4	REV C
I-1D-2	Change 2	I-2F-1	Change 1
I-1D-3	Change 3	I-2F-2	REV C
I-1D-4 through I-1D-6	Change 4	I-2G-1	Change 1
I-2-1 thru I-2-10	Change 2	I-2G-2	REV C
I-2-11	Change 5	I-2H-1 thru I-2H-2	REV C
I-2-12 thru I-2-14	Change 2	I-2I-1 thru I-2I-2	REV C
I-2-15 thru I-2-16	Change 5	I-2J-1 thru I-2J-2	REV C
I-2-17 thru I-2-22	Change 2	I-2K-1	Change 1
I-2A-1	Change 5	I-2K-2	REV C
I-2A-2 thru I-2A-10	Change 1	I-2L-1	Change 1
I-2A-11	Change 2	I-2L-2	REV C
I-2A-12	REV C	I-2M-1	Change 1
I-2B-1	Change 1	I-2M-2	REV C
I-2B-2	Change 4	I-2N-1	Change 1
I-2B-3	Change 1	I-2N-2	REV C
I-2B-4	REV C	I-2O-1	Change 1

Page Numbers	Change in Effect	Page Numbers	Change in Effect
I-2O-2	REV C	I-3E-8 thru I-3E-12	REV C
I-2P-1	Change 1	I-4-1	Change 2
I-2P-2	REV C	I-4-2	Change 1
I-2Q-1	Change 1	I-4-3	Change 2
I-2Q-2	REV C	I-4-4	REV C
I-2R-1	REV C	I-4-5 thru I-4-7	Change 1
I-2R-2	Change 1	I-4-8	REV C
I-2R-3	REV C	I-4A-1 thru I-4A-7	Change 2
I-2R-4	Change 1	I-4A-8	REV C
I-2S-1	Change 1	I-4B-1 thru I-4B-3	Change 2
I-2S-2	REV C	I-4B-4	REV C
I-2T-1 thru I-2T-2	REV C	I-4C-1 thru I-4C-4	REV C
I-2U-1 thru I-2U-2	REV C	I-4D-1	Change 2
I-3-1 thru I-3-2	Change 2	I-4D-2	Change 4
I-3-3 thru I-3-4	Change 3	I-4D-3 thru I-4D-4	REV C
I-3-5	Change 5	I-4E-1 thru I-4E-2	REV C
I-3-6 thru I-3-13	Change 2	I-4F-1	Change 2
I-3-14	REV C	I-4F-2 thru I-4F-4	REV C
I-3A-1	Change 2	I-4F-5	Change 1
I-3A-2	REV C	I-4F-6	REV C
I-3B-1 thru I-3B-2	REV C	I-4G-1 thru I-4G-2	REV C
I-3C-1 thru I-3C-20	REV C	I-5-1 thru I-5-2	Change 1
I-3D-1	Change 1	I-5-3 thru I-5-4	Change 2
I-3D-2	REV C	I-5-5	Change 1
I-3E-1	Change 5	I-5-6	REV C
I-3E-2	REV C	I-5A-1 thru I-5A-2	REV C
I-3E-3	Change 5	I-5B-1 thru I-5B-3	Change 1
I-3E-4 thru I-3E-6	REV C	I-5B-4	REV C
I-3E-7	Change 5	I-5C-1	Change 1

Page Numbers	Change in Effect	Page Numbers	Change in Effect
I-5C-2	REV C		
I-6-1 thru I-6-2	Change 1		
I-6A-1 thru I-6A-2	REV C		
I-6B-1 thru I-6B-3	Change 1		
I-6B-4	REV C		
I-6C-1	Change 1		
I-6C-2	REV C		

(This Page Intentionally Left Blank)

JOINT FLEET MAINTENANCE MANUAL
VOLUME I
NEW CONSTRUCTION
RECORD OF CHANGES

CHANGE NO.	DATE	TITLE OR BRIEF DESCRIPTION	ENTERED BY (INITIALS)

(This Page Intentionally Left Blank)

JOINT FLEET MAINTENANCE MANUAL CHANGE REQUEST FORM
<p>FROM: ACTIVITY/SHIP _____ E-MAIL ADDRESS _____ CODE/DEPT/SHOP _____ DATE _____ ORIGINATOR _____ TEL EXT () _____</p>
<p>VOL-PART-PARA NO. _____ FIGURE _____ TABLE _____ PROCESSING NORMAL _____ URGENT* _____ * (Justify in rationale below if urgent is marked and transmit via e-mail as "High Importance") PROBLEM DESCRIPTION:</p>
<p>RECOMMENDED CHANGE: (Include any proposed text addition/deletion)</p>
<p>RATIONALE:</p>

E-mail to PTNH.SUBMEPP.JFMMMGR@Navy.Mil

(If mailing, fold on dotted line on reverse side and mail to Submarine Maintenance Engineering, Planning and Procurement (SUBMEPP) Activity or send facsimile to (207) 438-6210.)

FOLD

Commanding Officer

OFFICIAL BUSINESS

Commanding Officer
Submarine Maintenance Engineering,
Planning and Procurement (SUBMEPP) Activity
Attn: Code 1832JM
P.O. Box 2500
Portsmouth Naval Shipyard
Portsmouth, NH 03804-2500

FOLD

JOINT FLEET MAINTENANCE MANUAL**VOLUME I****NEW CONSTRUCTION****TABLE OF CONTENTS**

LIST OF EFFECTIVE PAGES	i
RECORD OF CHANGES	v
JOINT FLEET MAINTENANCE MANUAL CHANGE REQUEST FORM.....	vii

CHAPTER 1 - INTRODUCTION

1.1 Purpose	I-1-1
1.2 Scope	I-1-1
1.3 Changes and Corrections	I-1-1
1.4 Request for Copies of the Manual	I-1-2

Appendices

A ₁ Summary of Typical New Construction Major Milestones and Message Reporting Requirements for Submarines.....	I-1A-1
A ₂ Summary of Typical New Construction Major Milestones and Message Reporting Requirements for Aircraft Carriers	I-1A-3
A ₃ Summary of Typical New Construction and Post Shakedown Availability Planning Events, Major Milestones and Message Reporting Requirements for Surface Forces	I-1A-5
B ₁ CVN General Time Line of Key Events	I-1B-1
B ₂ USS VIRGINIA (SSN 774) General Time Line of Key Events	I-1B-2
B ₃ Delivery Messages Scenario.....	I-1B-3
C List of Acronyms	I-1C-1
D Glossary of Terms.....	I-1D-1

CHAPTER 2 - POLICIES AND RESPONSIBILITIES

2.1 Navy Shipbuilding Program Managers.....	I-2-2
2.1.1 Pre-Commissioning	I-2-2
2.1.2 Post Shakedown Availability (Submarines only)	I-2-3
2.2 Naval Sea Systems Command Nuclear Propulsion Directorate (Nuclear Powered Ships only).....	I-2-3
2.2.1 Pre-Commissioning	I-2-3
2.2.2 Reactor Safeguard Examination	I-2-3
2.2.3 Criticality/Power Range Testing.....	I-2-3
2.2.4 Post Shakedown Availability.....	I-2-3
2.3 Type Commander	I-2-3
2.3.1 Pre-Commissioning	I-2-3
2.3.2 Combined Trials/Acceptance Trials/Final Contract Trials/Guarantee Material Inspection.....	I-2-5
2.3.3 Post Shakedown Availability.....	I-2-5
2.4 Supervising Authority.....	I-2-5
2.4.1 Pre-Commissioning	I-2-5
2.4.2 Acceptance Trials/Combined Trials	I-2-8
2.4.3 Post Shakedown Availability.....	I-2-8
2.4.4 Deficiencies	I-2-8
2.5 Immediate Superior in Command.....	I-2-8
2.5.1 Pre-Commissioning	I-2-8

2.5.2	Post Shakedown Availability.....	I-2-10
2.6	Building Yard	I-2-11
2.7	Design Yard/Planning Yard.....	I-2-11
2.8	Commanding Officer, Prospective Commanding Officer, Officer In Charge	I-2-11
2.8.1	General.....	I-2-11
2.8.2	Pre-Commissioning	I-2-11
2.8.3	Trials and Inspections	I-2-14
2.8.4	Post Shakedown Availability.....	I-2-14
2.9	Pre-Commissioning Unit	I-2-15
2.9.1	Initial Man-up	I-2-15
2.9.2	Training	I-2-15
2.9.2.1	Shipboard Training	I-2-15
2.9.2.2	Industrial Activity Training	I-2-16
2.9.2.3	Training Support Center	I-2-16
2.9.3	Ship's Qualification Program	I-2-17
2.9.4	Deficiency Identification and Correction.....	I-2-17
2.9.5	Establishment of Engineering/Reactor Department.....	I-2-17
2.9.5.1	Requirements	I-2-17
2.9.5.2	Shipboard Inspections.....	I-2-17
2.9.5.3	Personnel Qualification Standards.....	I-2-17
2.9.5.4	Outfitting Support (as applicable).....	I-2-17
2.9.5.5	Operational Sequencing System (Surface Force Ships/Aircraft Carriers only)	I-2-18
2.9.5.6	Engineering/Reactor Department Organization and Regulations Manual	I-2-18
2.10	Support Activities	I-2-18
2.10.1	Technical Support.....	I-2-18
2.10.1.1	Naval Sea Logistics Center (Detachment Norfolk/San Diego).....	I-2-18
2.10.2	Submarine Maintenance Engineering, Planning and Procurement Activity	I-2-19
2.10.3	Carrier Planning Activity, PMS312C (Aircraft Carriers only)	I-2-19
2.10.4	Surface Maintenance Engineering Planning Program (Surface Force Ships Only).....	I-2-19
2.10.5	Space and Naval Warfare Systems Centers	I-2-20
2.10.6	Fleet Introduction Team (Surface Forces only)	I-2-20
2.10.7	Afloat Training Group (Surface Force Ships only).....	I-2-20
2.10.8	Surface Nuclear Propulsion Mobile Training Team (Aircraft Carriers only)	I-2-20
2.10.9	Fitting Out Supply Assistance Team (Surface Ships only).....	I-2-20
2.11	Naval Sea Systems Command (Submarines only).....	I-2-21
2.11.1	Pre-Commissioning	I-2-21
2.12	Integration of Class Maintenance Plan and Baseline Availability Work Package (Surface Force Ships Only).....	I-2-21
2.12.1	Life Cycle Planning Conference.....	I-2-21
2.12.2	BAWP Pre-Pushed to Maintenance Team	I-2-21
2.12.3	BAWP Upload.....	I-2-22
2.12.4	Other BAWP to AWP Process Milestones	I-2-22
Appendices		
A	Message Scenario and Sample Messages/Letters for Habitability Inspections and In-Service	I-2A-1
A ₁	Sample Supervising Authority Letter to Navy Shipbuilding Program Manager Recommending Habitability Inspection and In-Service	I-2A-2
A ₂	Sample Navy Shipbuilding Program Manager Letter Requesting TYCOM to Authorize ISIC to Conduct Habitability Inspection.....	I-2A-3
A ₃	Sample TYCOM Message Directing ISIC to Conduct Habitability Inspection.....	I-2A-4

A₄ Sample ISIC Message Reporting Completion of Habitability Inspection and Recommending Ship Be Placed "In-Service" I-2A-5

A₅ Sample Navy Shipbuilding Program Manager to CNO Message Recommending Ship Be Placed In-Service I-2A-6

A₆ Sample TYCOM Message Recommending Ship Be Placed "In-Service Active" I-2A-7

A₇ Sample CNO to Navy Shipbuilding Program Manager Message Directing the Ship Be Placed In-Service I-2A-8

A₈ Sample Supervising Authority to Navy Shipbuilding Program Manager Message Recommending Ship Be Placed In-Service I-2A-9

A₉ Sample Navy Shipbuilding Program Manager to Ship Message Directing Ship Be Placed In-Service I-2A-10

A₁₀ Sample CO Pre-Commissioning Unit Message Reporting "In-Service Active" I-2A-11

B Message Scenario and Sample Messages for Fast Cruise and Alpha Sea Trial (Nuclear Powered Ships) I-2B-1

B SUBS (Submarines Only) Message Scenario and Sample Messages for Fast Cruise and Alpha Sea Trial (Nuclear Powered Ships) I-2B-2

B₁ Sample ISIC Certification of New Construction Readiness for Fast Cruise and Sea Trials Message (Submarines) I-2B-3

B₂ Sample Pre-Commissioning Unit Message to TYCOM Concerning Crew Certification (CVN) .. I-2B-4

B₃ Sample TYCOM Certification of Crew Readiness for Underway Trials Message (Submarines) .. I-2B-5

B₄ Sample Supervising Authority to Navy Shipbuilding Program Manager Message Concerning Fast Cruise/Alpha Sea Trial Readiness (Submarines) I-2B-6

B₅ Sample Supervising Authority Message to Navy Shipbuilding Program Manager Concerning Fast Cruise/Sea Trial Readiness (CVN) I-2B-7

B₆ Sample Supervising Authority to Navy Shipbuilding Program Manager 24 Hour Message Concerning Fast Cruise Readiness (Submarines) I-2B-8

B₇ Sample Supervising Authority to Navy Shipbuilding Program Manager and TYCOM Message Concerning Fast Cruise Completion (Submarines) I-2B-9

B₈ Sample NAVSEA to TYCOM Message Concerning Material Condition and Authorized Depth for Alpha Sea Trial (Submarines) I-2B-10

B₉ Sample TYCOM to Pre-Commissioning Unit Message Concerning Alpha Sea Trial Authorized Test and Operating Depth (Submarines) I-2B-11

C Message Scenario and Sample Messages for Bravo, Charlie, and Combined Trials (Submarines) I-2C-1

C₁ Sample Supervising Authority to Navy Shipbuilding Program Manager Message Concerning Design Test Depth Dive Readiness I-2C-2

C₂ Sample NAVSEA to TYCOM Message Concerning Design Test Depth Dive Authorization I-2C-4

C₃ Sample TYCOM to Pre-Commissioning Unit Message Concerning Design Test Depth Dive Authorization I-2C-5

Cspc Supervising Authority Installation of Shore Power Covers for Bravo and Subsequent Sea Trials Sample Message I-2C-7

D Message Scenario and Sample Messages for URO Certification (Submarines) I-2D-1

D₁ Sample Supervising Authority to Navy Shipbuilding Program Manager Message Concerning UROI-2D-2

D₂ Sample NAVSEA to TYCOM Message Concerning URO I-2D-3

D₃ Sample TYCOM to Pre-Commissioning Unit Message Concerning URO I-2D-4

E Pre-RSE/RSE/Criticality/Power Range Testing Logic Table (All Nuclear Powered Ships) I-2E-1

E₁ Sample Supervising Authority to NAVSEA Message Requesting Authorization for Criticality .. I-2E-2

E₂ Sample Supervising Authority to NAVSEA Request for Initial Criticality I-2E-3

E₃ Sample NAVSEA to Supervising Authority Message Authorizing Criticality I-2E-4

F Sample TYCOM Message Concerning Sea Trial Agenda (Submarines) I-2F-1

G Sample TYCOM SRDRS Support Services Message (Submarines) I-2G-1

H Sample TYCOM Message to PCU Concerning Use of the FBW SCS in Support of Alpha Sea Trials (Submarines) I-2H-1

I Sample TYCOM Message to PCU Concerning FBW SCS Material Condition Initial Certification (Submarines) I-2I-1

J Sample TYCOM Message to the Ship Concerning FBW SCS Certification (Submarines) I-2J-1

K	Sample Supervising Authority Message to NAVSEA Concerning PCU FBW SCS Material Condition Readiness for Fast Cruise and Alpha Trials (Submarines)	I-2K-1
L	Sample Supervising Authority Message to TYCOM and NAVSEA Concerning PCU Fast Cruise Completion and Readiness of FBW SCS Material Condition for Alpha Sea Trials (Submarines)	I-2L-1
M	Sample Supervising Authority Message to NAVSEA Concerning PCU FBW SCS Material Condition Readiness Upon Completion of Alpha Sea Trials and Readiness of the FBW SCS for Use During Bravo and Subsequent Sea Trials (Submarines)	I-2M-1
N	Sample Supervising Authority Message to NAVSEA Concerning PCU FBW SCS Material Condition Initial Certification (Submarines)	I-2N-1
O	Pre Man-Up Checklist for TYCOM/ISIC	I-2O-1
P	Basic Requirements for Initial Man-Up Personnel of the PCU (Detachment Concept) (Aircraft Carriers and Surface Force Ships)	I-2P-1
Q	Basic Requirements for Initial Man-Up Personnel of the PCU	I-2Q-1
R	Generic Base Line of Fleet Introduction Team Functions and Responsibilities	I-2R-1
S	Sample NAVSEA Message to TYCOM Concerning PCU FBW SCS Material Condition Readiness for Alpha Sea Trials (Submarines)	I-2S-1
T	Sample NAVSEA Message to TYCOM Concerning PCU FBW SCS Material Condition Initial Certification (Submarines)	I-2T-1
U	Sample NAVSEA Message to TYCOM Concerning PCU Recommendation for Fly-By-Wire Ship Control System Certification	I-2U-1

CHAPTER 3 - PRE DELIVERY

3.1	Purpose	I-3-2
3.2	Shipbuilder's Test Program	I-3-2
3.3	Inspections/Certifications/Assists	I-3-2
3.3.1	Arrival Assist	I-3-2
3.3.2	Periodic Monitoring/Inspections/Visits	I-3-2
3.3.3	Pre-Reactor Safeguard Examination (Nuclear Powered Ships only)	I-3-3
3.3.4	Crew Certification	I-3-4
3.3.5	Sonar Certification (Applicable Surface Force Ships and Submarines)	I-3-4
3.3.6	Aviation Facility Certification (Air Capable Ships only)	I-3-4
3.3.7	Salvage Inspection (Submarines only)	I-3-5
3.3.8	NAVSEA Calibration Activity/Aircraft Intermediate Maintenance Department Calibration Laboratory Initial Certification (Submarines, Aircraft Carriers and Surface Forces, as appropriate)	I-3-5
3.3.9	National Policy on the Control of Compromising Emanations Inspection	I-3-5
3.3.10	Diesel Inspection	I-3-6
3.3.11	Habitability Inspection	I-3-6
3.3.12	Requirements for In-Service	I-3-6
3.3.13	Degaussing/Deperming	I-3-7
3.3.14	Light-Off Assessment (Surface Force Ships only)	I-3-7
3.3.15	Shipboard Crane Certification Program (Surface Force Ships and Aircraft Carriers, as appropriate)	I-3-8
3.3.16	Marine Gas Turbine Inspection	I-3-8
3.4	Maintenance and Material Management Program	I-3-8
3.4.1	Planned Maintenance System	I-3-8
3.4.2	Technical Feedback Reports	I-3-9
3.4.3	Establishment of Current Ship's Maintenance Project	I-3-9
3.4.4	Naval Tactical Command Support System	I-3-10
3.5	Equipment Load Out	I-3-10
3.5.1	Test Equipment	I-3-10
3.5.2	Hand Tools and Weight Handling Equipment	I-3-10
3.6	Logistic Support	I-3-10

3.6.1 Technical Manuals and Drawings.....I-3-10
 3.6.2 Unrestricted Operations Maintenance Requirement Cards (Submarines only)I-3-12
 3.7 Operational Control Transfer.....I-3-12
 3.7.1 Sound Silencing Programs Unique to New Construction (MHC/SSN only).....I-3-13

Appendices

A Areas to Be Evaluated During Arrival Assists.....I-3A-1
 B Areas to Be Evaluated During Monitoring InspectionsI-3B-1
 C Sample Pre-Reactor Safeguard Examination NoticeI-3C-1
 D In-Service Compartment Surveillance Guide (Aircraft Carriers and Submarines Only).....I-3D-1
 E Sample Pre-Commissioning Habitability Inspection Checklist for New Construction Ships.....I-3E-1

CHAPTER 4 - TRIALS

4.1 PurposeI-4-1
 4.2 Dock TrialsI-4-1
 4.2.1 PurposeI-4-1
 4.2.2 Conduct.....I-4-1
 4.2.3 SchedulingI-4-2
 4.2.4 Specific Test AreasI-4-2
 4.3 Fast CruiseI-4-2
 4.3.1 PurposeI-4-2
 4.3.2 Conduct.....I-4-2
 4.3.3 SchedulingI-4-2
 4.3.4 Specific Test AreasI-4-2
 4.3.5 Reports (Nuclear Powered Ships only).....I-4-2
 4.4 Sea TrialsI-4-3
 4.4.1 General.....I-4-3
 4.4.2 Builder's Trials.....I-4-4
 4.4.3 Alpha Sea Trial (Submarines only).....I-4-4
 4.4.4 Bravo Sea Trial (Submarines only).....I-4-6
 4.4.5 Charlie Sea Trial (Submarines only).....I-4-7
 4.4.6 Acoustic Trials (Platform and Radiated) (Submarines only)I-4-7
 4.4.7 Shock Trials.....I-4-7
 4.4.8 Acceptance Trials/Combined Trials/Final Contract Trials/Guarantee Material InspectionI-4-7

Appendices

A Specific Dock Trial Test Areas.....I-4A-1
 B Minimum Fast Cruise RequirementsI-4B-1
 C Listing of Tests to Be Performed During Aircraft Carrier Builder's Trials.....I-4C-1
 D Listing of Tests to Be Performed During Initial Tightness Dive (Submarines Only).....I-4D-1
 E Escort Ship Capabilities for Submarine Sea TrialsI-4E-1
 F Listing of Tests to Be Performed Prior to, During and Following First Dive to Test DepthI-4F-1
 G Submarine Sea Trial Situation Report (SITREP)I-4G-1

CHAPTER 5 - POST DELIVERY DEFICIENCIES

5.1 PurposeI-5-1
 5.2 Deficiency Correction.....I-5-1
 5.2.1 Government Responsible ItemsI-5-1
 5.2.2 Shipbuilder Responsible ItemsI-5-1
 5.2.3 Recommended Changes in Characteristics, Design Specifications, or PlansI-5-2
 5.3 Required ReportsI-5-2
 5.4 Combined Trials/Acceptance TrialsI-5-4

5.5 Guarantee Material Inspection/Final Contract Trials..... I-5-4
5.6 Post Delivery Deficiency Items I-5-4

Appendices

A Sample Page of 4760-1 Report with Representative Data I-5A-1
B Legend and Explanation of Symbols Used in Report 4760-1 I-5B-1
C Preparation for Guarantee Material Inspection/Final Contract Trials I-5C-1

CHAPTER 6 - POST SHAKEDOWN AVAILABILITY

6.1 Purpose I-6-1
6.2 Planning and Execution I-6-1
6.3 Trials, Inspections and Crew Certification I-6-1
6.4 Sea Trials I-6-1
6.4.1 General..... I-6-1
6.5 Deficiency Correction Period I-6-2
6.6 Period Following Post Shakedown Availability I-6-2

Appendices

A Major Funding Milestones During Construction/Conversion..... I-6A-1
B Post Shakedown Availability Planning Events Milestone Schedule..... I-6B-1
C Summary of Major Milestones for Post Shakedown Availability I-6C-1

VOLUME I
CHAPTER 1
INTRODUCTION

REFERENCES.

- (a) NAVSEA S9086-C4-STM-000 - NSTM Chapter 094 (Trials)
- (b) OPNAVINST 9080.3 - Procedures for Tests and Trials of Navy Nuclear Powered Ships Under Construction, Modernization, Conversion, Refueling and Overhaul
- (c) OPNAVINST 4700.8 - Trials, Acceptance, Commissioning, Fitting-Out, Shakedown, and Post Shakedown Availability of U.S. Naval Ships Undergoing Construction or Conversion
- (d) NAVSEAINST 4790.8/OPNAVINST 4790.4 - Ships' Maintenance and Material Management (3-M) Manual

LISTING OF APPENDICES.

- A Summary of Typical New Construction Major Milestones and Message Reporting Requirements
- B General Time Lines of Key Events
- C List of Acronyms
- D Glossary of Terms

1.1 PURPOSE. Volume I of this manual summarizes maintenance related information for all units of the Fleet during Ship construction and through the completion of Post Shakedown Availability (PSA). The time span is from initial crew man-up to departure from the PSA facility.

1.2 SCOPE.

- a. New Construction ships require a succession of inspections and tests followed by a series of underway trials. The philosophy and sequencing of these inspections, tests, and trials are set forth in references (a), (b) and (c) and are graphically represented in Appendices A and B of this chapter. This Volume provides information, guidance, policies and procedures for maintenance related topics during the Ship's construction period. Reference (d) shall be used in conjunction with the Joint Fleet Maintenance Manual (JFMM) to establish an effective maintenance program. The requirements of this manual do not supersede or take precedence over directives issued by higher authority. Where conflicts exist with previously issued Type Commander (TYCOM) letters and transmittals, this manual takes precedence. Conflicts should be reported to the applicable TYCOM.
- b. The development of this and subsequent volumes to the JFMM has required the study of numerous reference documents, many of which are referenced as source or governing documents in specific chapters. The Foreword of this Manual contains a Master Listing of all the references called out in the JFMM. These references are arranged in an alpha/numeric sequence to facilitate the ordering of documentation to support the use of the JFMM. References used in specific chapters are called out at the beginning of that chapter.
- c. Appendices C and D of this chapter contain a list of acronyms and a glossary of terms used throughout Volume I of the JFMM.
- d. Equipment under the cognizance of the Strategic Systems Programs and Naval Sea Systems Command (NAVSEA) Nuclear Propulsion Directorate (08) are maintained in accordance with Strategic Systems Programs and NAVSEA 08 directives, respectively.

1.3 CHANGES AND CORRECTIONS. Changes and corrections will be issued as required. Comments and suggestions for improving or changing this volume are invited. Address comments, recommendations, and requested changes to Submarine Maintenance Engineering, Planning and Procurement (SUBMEPP) Activity utilizing the change request form located in the front of this manual. If changes are submitted in electronic format, facsimile or E-mail, each change request shall contain the information required on the change request form.

1.4 REQUEST FOR COPIES OF THE MANUAL. Activities on distribution for the JFMM that require additional copies or activities wanting to be added to distribution should submit a letter to their applicable TYCOM, identifying CD-ROM requirements along with justification for the request. To the maximum extent possible, technical publications libraries at each activity will receive all copies of the manual for that activity and coordinate local distribution and updates.

APPENDIX A₁
**SUMMARY OF TYPICAL NEW CONSTRUCTION MAJOR
MILESTONES AND MESSAGE REPORTING REQUIREMENTS
FOR SUBMARINES**

Event	Cognizance	Approximate Schedule (see Note)
A. Arrival Assist	Immediate Superior in Command (ISIC)	Crew Arrival +2 months
B. Periodic Monitoring Inspections	ISIC	Start to completion
C. Pre-Reactor Safeguard Examination (RSE)	ISIC (TYCOM Assist)	Criticality -6 to -8 weeks
D. RSE per OPNAVINST 3540.3	Naval Sea Systems Command (NAVSEA) Nuclear Propulsion Directorate (08)	Criticality -4 to -6 weeks
E. Criticality	Prospective Commanding Officer (PCO)	
F. Escort Recommendation Message	ISIC/Supervising Authority	-60 days
G. Habitability Inspection for In-Service per OPNAVINST 9080.3	ISIC	-60 days
H. Phase I Crew Certification	ISIC	-35 days
I. Salvage Inspection	ISIC	-30 days
J. Approve Sea Trial Agendas * * Only Alpha Trial Agenda is approved 30 days before trial date	NAVSEA for Propulsion Trials; Director, Strategic Systems Programs for Ballistic Missile Trials; Board of Inspection and Survey (INSURV) for Acceptance Trial (AT); TYCOM for Operational Aspects all Trials	-30 days
K. In-Service per OPNAVINST 4700.8 and OPNAVINST 9080.3	Supervising Authority NAVSEA, ISIC and TYCOM	-28 days
L. Dock Trial	Officer in Charge (OIC)	-21 days
M. Phase II Crew Certification Message (Volume I, Chapter 2, Appendix B ₁)	ISIC	-10 days
N. Crew Certification Message (Volume I, Chapter 2, Appendix B ₃)	TYCOM	-9 days
O. Readiness for Fast Cruise/Sea Trial Message (Volume I, Chapter 2, Appendix B ₄)	Supervising Authority/OIC concurrence	-7 days
P. Certify Material Condition for Alpha Sea Trial Message (Volume I, Chapter 2, Appendix B ₈)	NAVSEA	-7 days
Q. Authorize Commencement of Sea Trial Message	TYCOM to ISIC to Ship	-7 days
R. Fast Cruise	OIC	-7 days (2 days on, 1 day off, 2 days on)
S. Report Completion of Fast Cruise and Readiness for Sea Trial Message (Volume I, Chapter 2, Appendix B ₇)	Supervising Authority (with OIC concurrence) to TYCOM	-2 days
T. Depth Authorization Message (Volume I, Chapter 2, Appendix B ₉)	TYCOM	-1 day

Event	Cognizance	Approximate Schedule (see Note)
U. Alpha Sea Trial	OIC	0
V. Readiness for Bravo Sea Trial Message (Volume I, Chapter 2, Appendix C ₁)	Supervising Authority	Bravo Sea Trial -1 day
W. Readiness for Bravo Sea Trial Message (Volume I, Chapter 2, Appendix C ₂)	NAVSEA	Bravo Sea Trial -1 day
X. Bravo Sea Trial Authorization Message (Volume I, Chapter 2, Appendix C ₃)	TYCOM	Bravo Sea Trial -1 day
Y. Bravo Sea Trial	OIC	+3 days
Z. Readiness for Charlie Sea Trial Message (Volume I, Chapter 2, Appendix C ₁)	Supervising Authority	Charlie Sea Trial -1 day
AA. Readiness for Charlie Sea Trial Message (Volume I, Chapter 2, Appendix C ₂)	NAVSEA	Charlie Sea Trial -1 day
AB. Charlie Sea Trial Authorization Message (Volume I, Chapter 2, Appendix C ₃)	TYCOM	Charlie Sea Trial -1 day
AC. Charlie Sea Trial	OIC	+45 days
AD. Readiness for INSURV Sea Trial Message (Volume I, Chapter 2, Appendix C ₁)	Supervising Authority	INSURV Sea Trial -1 day
AE. Readiness for INSURV Sea Trial Message (Volume I, Chapter 2, Appendix C ₂)	NAVSEA	INSURV Sea Trial -1 day
AF. INSURV Sea Trial Authorization Message (Volume I, Chapter 2, Appendix C ₃)	TYCOM	INSURV Sea Trial -1 day
AG. INSURV	Supervising Authority and OIC	+60 days
AH. Recommendation for Unrestricted Operations Certification Message (Volume I, Chapter 2, Appendix D ₁)	Supervising Authority	
AI. Unrestricted Operations Certification Message (Volume I, Chapter 2, Appendix D ₂)	NAVSEA	
AJ. Unrestricted Operation Authorization Message (Volume I, Chapter 2, Appendix D ₃)	TYCOM	

Note: Unless otherwise indicated, scheduled dates are referenced to the Alpha Sea Trial underway date.

APPENDIX A₂
**SUMMARY OF TYPICAL NEW CONSTRUCTION MAJOR
MILESTONES AND MESSAGE REPORTING REQUIREMENTS
FOR AIRCRAFT CARRIERS**

Event	Cognizance	Approximate Schedule (see Note)
A. Periodic Monitoring Inspections	TYCOM	Start to Completion
B. Pre-RSE	TYCOM	
C. Habitability Inspection for In-Service per OPNAVINST 9080.3	TYCOM	-180 days
D. Phase I Crew Certification	ISIC	-120 days
E. RSE per OPNAVINST 3540.3	NAVSEA 08	
F. Criticality	PCO	-90 and -60 days
G. Approve Sea Trial Agenda	NAVSEA (for Builder's Trials (BT)) INSURV (for AT)	-70 days
H. In-Service per OPNAVINST 4700.8 and OPNAVINST 9080.3	Supervising Authority, NAVSEA, TYCOM	-65 days
I. Dock Trial	PCO	-60 days
J. Phase II Crew Certification Message	ISIC	-55 days
K. Crew Certification Message	ISIC	-50 days
L. Readiness for Fast Cruise/Sea Trial Message	Supervising Authority, w/PCO concurrence	-50 days
M. Authorize Commencement of Sea Trial Message	TYCOM	-46 days
N. Fast Cruise	PCO	-45 days
O. Report Completion of Fast Cruise and Ready for Sea Trial Message	Supervising Authority, w/PCO concurrence	-40 days
P. Builder's Trials	PCO	-30 days
Q. Acceptance Trials	PCO	-21 days
R. Readiness for Final Contract Trials (FCT) Message	NAVSEA	+59 days
S. Final Contract Trials	CO	+60 days
T. Operational Reactor Safeguard Examination (ORSE)	NAVSEA 08	

Note: Unless otherwise indicated, scheduled dates are referenced to the Delivery date.

(This Page Intentionally Left Blank)

APPENDIX A₃

**SUMMARY OF TYPICAL NEW CONSTRUCTION AND POST SHAKEDOWN AVAILABILITY
PLANNING EVENTS, MAJOR
MILESTONES AND MESSAGE REPORTING REQUIREMENTS
FOR SURFACE FORCES**

Event	Cognizance	Approximate Schedule (see Note)				
		AOE	DDG	LHD	LPD/LSD	MHC
A. Arrival Inspection	ISIC/TYCOM	Crew Arrival				
B. Periodic Monitoring Inspections	ISIC/TYCOM	Start To Completion				
C. AEGIS Light-Off (If applicable)	NAVSEA/Supervising Authority		-300 days			
D. Main Engine Light-Off	NAVSEA/Supervising Authority		-210 days			
E. Builder's Dock Trial	Supervising Authority	-141 days	-210 days		-180 days	-180 days
F. Builder's Trial (Alpha)	Supervising Authority	-120 days	-120 days	-130 days	-150 days	-90 days
G. Review and update Out of Commission List	Ship's Force	-90 days	-90 days	-90 days	-90 days	-90 days
H. Builder's Trial (Bravo) "Combat Systems"	Supervising Authority		-60 days			
I. Builder's Trial (Charlie) "Acceptance"	Supervising Authority	-60 days	-30 days	-60 days	-90 days	-30 days
J. Prepare OPNAV 4790/2Ks for all deficiencies to be presented to the INSURV at the AT/Combined Trial (CT)	Supervising Authority	-21 days	-21 days	-21 days	-21 days	-21 days
K. Conduct AT/CT	INSURV Board	-21 days	-21 days	-21 days	-21 days	-21 days
L. Identify and resolve controversies over responsibility and timing for correction of deficiencies	Ship Program Manager/Supervising Authority/Shipbuilder/Ship's Force	-21 days	-21 days	-21 days	-21 days	-21 days
M. Provide the ship with one copy of each documented INSURV item for input at delivery into the Current Ship's Maintenance Project (CSMP)	Supervising Authority	-21 days	-21 days	-21 days	-21 days	-21 days
N. Habitability Inspection for In-Service per OPNAVINST 9080.3	ISIC	-14 days	-14 days	-3 days	-14 days	-14 days
O. Phase I Crew Certification	ISIC	+14 days			-120 days	+10 days
P. Phase II Crew Certification	ISIC	+60 days	+60 days	+80 days	+8 days	+65 days
Q. Light-Off Assessment (LOA)	ISIC/TYCOM	+70 days	-15 days	+70 days	+45 days	+60 days
R. In-Service per OPNAVINST 4700.8 "Delivery"	NAVSEA/Supervising Authority/TYCOM	0	0	0	0	0
S. Issue Section B of Consolidated Report	Ship Program Manager	0	0	0	0	0
T. Submit OPNAV 4790/2Ks for all INSURV items and for all other material deficiencies that quality for CSMP	Ship's Force	0	0	0	0	0
U. Issue Delivery Letter	Shipbuilder	+10 days	+10 days	+10 days	+10 days	+10 days

Event	Cognizance	Approximate Schedule (see Note)				
		AOE	DDG	LHD	LPD/LSD	MHC
V. Submit Comments on Delivery Letter	Supervising Authority	+20 days	+20 days	+20 days	+20 days	+20 days
W. Dock Trial	PCO					
X. Establish PSA work package from input to date and identify required advance planning actions via PSA Planning Conference	Ship Program Manager/Supervising Authority/TYCOM/Ship's Force/Shipbuilder	+27 days	+27 days	+27 days	+27 days	+27 days
Y. Submit Priority list of AT/CT deficiencies	Ship's Force	+30 days	+30 days	+30 days	+30 days	+30 days
Z. Make comments on ship's priority list	TYCOM	+35 days	+35 days	+35 days	+35 days	+35 days
AA. Issue a list of Shipbuilding and Conversion, Navy (SCN) funded items authorized for accomplishment during PSA	Ship Program Manager	+40 days	+40 days	+40 days	+40 days	+40 days
AB. Assign availability	TYCOM	+42 days	+42 days	+42 days	+42 days	+42 days
AC. Issue initial PSA work package	Supervising Authority	+45 days	+45 days	+45 days	+45 days	+45 days
AD. Prepare for FCT/Guarantee Material Inspection (GMI)	Ship's Force	+50 days	+50 days	+50 days	+50 days	+50 days
AE. Place ship in "INSURV Window" and call down ship's Pre-INSURV package	TYCOM	+50 days	+50 days	+50 days	+50 days	+50 days
AF. FCT/GMI	INSURV Board	+54 days	+54 days	+54 days	+54 days	+54 days
AG. Conference following FCT/GMI critique to assign responsibility for correction of deficiencies and to assign priorities	Ship Program Manager/Supervising Authority/Shipbuilder/TYCOM/Ship's Force	+54 days	+54 days	+54 days	+54 days	+54 days
AH. Issue Section "B" of Consolidated Report	Ship Program Manager	+54 days	+54 days	+54 days	+54 days	+54 days
AI. Fast Cruise	PCO	+85 days	+30 days		+50 days	
AJ. Commissioning	CO	+120 days	+14 days	+90 days	+60 days	+70 days
AK. Issue final list of SCN funded items authorized for accomplishment during PSA	Ship Program Manager	+90 days	+90 days	+90 days	+90 days	+90 days
AL. Sailaway	CO	+90 days		+95 days	+90 days	+80 days
AM. Issue final PSA work package	Supervising Authority	+100 days	+100 days	+100 days	+100 days	+100 days
AN. Pre-Arrival Conference	Supervising Authority/Ship Program Manager/Shipbuilder/TYCOM/ISIC/Ship's Force	+149 days	+149 days	+149 days	+149 days	+149 days
AO. Commence PSA/Arrival Conference	Supervising Authority/Shipbuilder/Ship's Force (TYCOM and Ship Program Manager not required unless specifically requested)	+154 days	+154 days	+154 days	+154 days	+154 days
AP. Final Contract Trials	Supervising Authority	+330 days	+120 days	+270 days	+210 days	+90 days
AQ. Operational Propulsion Plant Examination (OPPE)	ISIC/TYCOM	+345 days	+180 days	+345 days	+225 days	+105 days
AR. End PSA and Submit final status report of all deficiencies (Completion Date Varies with platform)	Ship's Force	+214 to +274 days	+214 to +274 days	+214 to +274 days	+214 to +274 days	+214 to +274 days

Event	Cognizance	Approximate Schedule (see Note)				
		AOE	DDG	LHD	LPD/LSD	MHC
AS. Comment on final status report from ship and submit recommendations for Ship Program Manager Action	TYCOM	*	*	*	*	*
AT. Issue follow-up letter requesting Ship Program Manager final resolution and action on government responsible uncorrected deficiencies	TYCOM	**	**	**	**	**

Note: Unless otherwise indicated, scheduled dates are referenced to the Delivery date and are approximate. Significant adjustment may be required for PSAs that commence at other times after delivery.

* 30 days after completion of PSA

** 45 days after completion of PSA

(This Page Intentionally Left Blank)

APPENDIX B₁

CVN
GENERAL TIME LINE OF KEY EVENTS

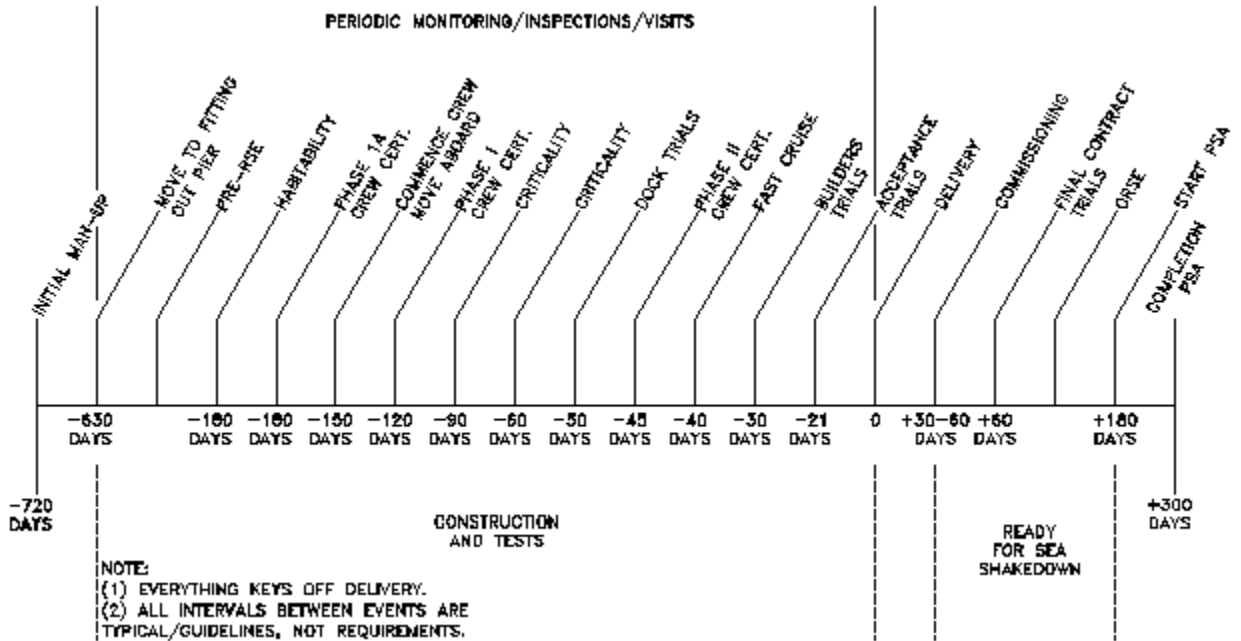

APPENDIX B₂

USS VIRGINIA (SSN 774)
GENERAL TIME LINE OF KEY EVENTS

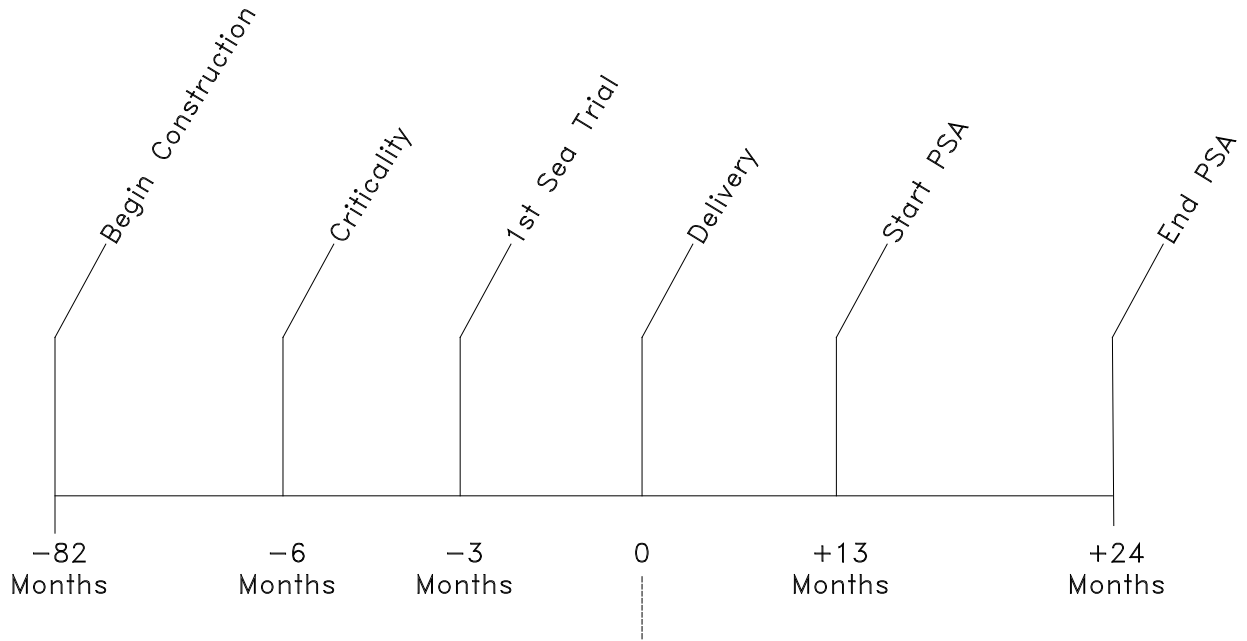

NOTE:

- (1) Everything keys off Delivery.
- (2) All intervals between events are typical/guidelines, not requirements.

APPENDIX B₃

DELIVERY MESSAGES SCENARIO

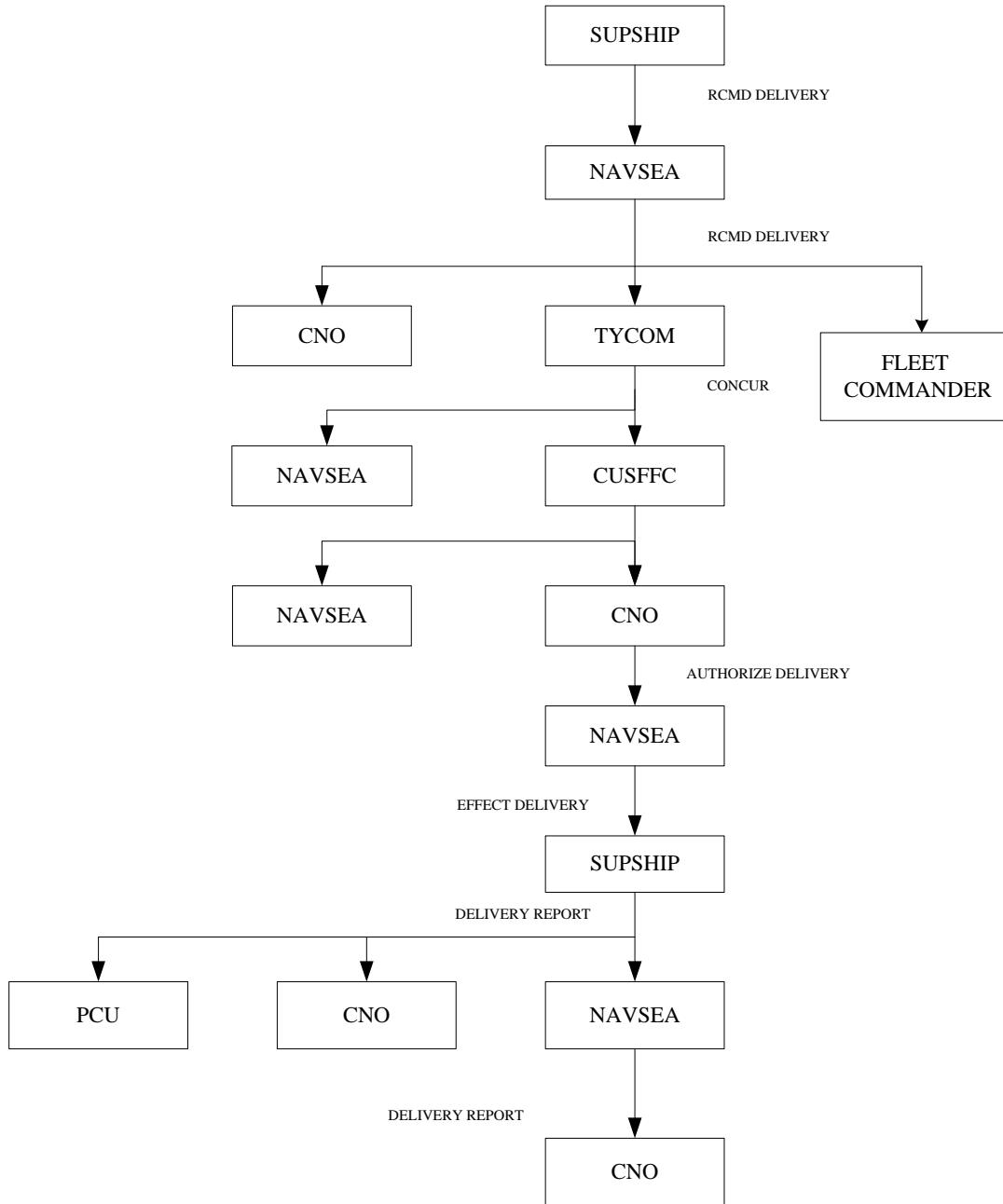

(This Page Intentionally Left Blank)

APPENDIX C
LIST OF ACRONYMS

2M	Miniature/Microminiature
3-M	Maintenance and Material Management
A&I	Alteration and Improvement
ACN	Advanced Change Notice
AEL	Allowance Equipage List
AOE	Fast Combat Support Ship
APL	Allowance Parts List
AT	Acceptance Trial
ATG	Afloat Training Group
AWP	Availability Work Package
BAWP	Baseline Availability Work Package
BDT	Builder's Dock Trial
BST	Builder's Sea Trial
BT	Builder's Trial
BUPERS	Bureau of Personnel
CAGE	Commercial and Government Entity
CASREP	Casualty Report
CD-ROM	Compact Disc Read Only Memory
CFE	Contractor Furnished Equipment
CHT	Collection, Holding and Transfer
CNO	Chief of Naval Operations
CO	Commanding Officer
COMFLTFORCOM	Commander, Fleet Forces Command
COMLANFLT	Commander, Atlantic Fleet
COMNAVSEASYSKOM	Commander, Naval Sea Systems Command
COMNAVSURFLANT	Commander Naval Surface Force Atlantic
COMPACFLT	Commander, Pacific Fleet
COMSUBDEVRON	Commander Submarine Development Squadron
COMSUBRON	Commander, Submarine Squadron
COMUSFLTFORCOM	Commander, United States Fleet Forces Command
COSAL	Coordinated Shipboard Allowance List
CPA	Carrier Planning Activity
CS/CCS	Command and Control Systems
CSCT	Combat Systems Certification Trial
CSMP	Current Ship's Maintenance Project
CT	Combined Trial
CVN	Nuclear-Powered Aircraft Carrier
CW	Continuous Wave
DDG	Guided Missile Destroyer
DIRSSP	Director, Strategic Systems Programs
DPMA	Docking Phased Maintenance Availability
DRA	Dead Reckoning Analyzer
DRAI	Dead Reckoning Analyzer Indicator
DRT	Dead Reckoning Tracer
EAB	Emergency Air Breathing
EDORM	Engineering Department Organization and Regulations Manual
EEBD	Emergency Escape Breathing Device

EGL	Equipment Guide List
EMBT	Emergency Main Ballast Tank
EOSS	Engineering Operational Sequencing System
EPM	Emergency Propulsion Motor
ESM	Electronic Warfare Support Measures
FBW SCS	Fly-By-Wire Ship Control System
FCT	Final Contract Trial
FDRMC	Forward Deployed Regional Maintenance Center
FIT	Fleet Introduction Team
FMA	Fleet Maintenance Activity
FMR	Field Modification Request
FOSAT	Fitting Out Supply Assistance Team
FRP	Fleet Readiness Plan
GFE	Government Furnished Equipment
GFI	Government Furnished Information
GMI	Guarantee Material Inspection
GPETE	General Purpose Electronic Test Equipment
HF	High Frequency
HMR	Headquarters Modification Request
IEM	Inactive Equipment Maintenance
IFF	Identification Friend or Foe
IMP	Incremental Maintenance Plan
INSURV	Inspection and Survey
ISE	Independent Ship Exercise
ISEA	In-Service Engineering Activity
ISIC	Immediate Superior in Command
JFMM	Joint Fleet Maintenance Manual
JFMMBOD	Joint Fleet Maintenance Manual Board of Directors
JSN	Job Sequence Number
LCPC	Life Cycle Planning Conference
LHD	Amphibious Assault Ship
LOA	Light-Off Assessment
LOEP	List of Effective Pages
LSD	Dock Landing Ship
MACHALT	Machinery Alteration
MARMC	Mid-Atlantic Regional Maintenance Center
MBT	Main Ballast Tank
METCAL	Metrology and Calibration
MHC	Coastal Minehunter
MIP	Maintenance Index Page
MRC	Maintenance Requirement Card
MRMS	Maintenance Resources Management System
MSW	Main Seawater
MT	Magnetic Particle Testing
MT	Maintenance Team
MTR	Metrology and Calibration Technical Representative
NAVAIR	Naval Air Systems Command

NAVSEA	Naval Sea Systems Command
NAVSEA 08	Naval Sea Systems Command Nuclear Propulsion Directorate
NAVSEALOGCEN	Naval Sea Logistics Center
NAVSUP	Naval Supply Systems Command
NAWC	Naval Air Warfare Center
NJP	Non-judicial Punishment
NRMC	Navy Regional Maintenance Center
NSTM	Naval Ships' Technical Manual
NSWC	Naval Surface Warfare Center
NSWCCD	Naval Surface Warfare Center Carderock Division
NTP	Naval Telecommunication Procedures
O&MN	Operations and Maintenance, Navy
OCT	Operational Control Transfer
OIC	Officer In Charge
OPNAV	Office of Chief of Naval Operations
OPPE	Operational Propulsion Plant Examination
ORDALT	Ordnance Alteration
ORSE	Operational Reactor Safeguard Examination
OSI	Operating Space Item
OSS	Operational Sequencing System
PCO	Prospective Commanding Officer
PCU	Pre-Commissioning Unit
PDDI	Post Delivery Deficiency Item
PLAD	Plain Language Address Directory
PMS	Planned Maintenance System
POAM	Plan of Action and Milestones
PQS	Personnel Qualification Standard
PSA	Post Shakedown Availability
PSO	Prospective Supply Officer
QA	Quality Assurance
RDORM	Reactor Department Organization and Regulations Manual
RMC	Regional Maintenance Center
RSE	Reactor Safeguard Examination
RT	Radiographic Testing
SCN	Shipbuilding and Conversion, Navy
SDI	Ship Drawing Index
SDOSS	Sewage Disposal Operational Sequencing System
SHIPALT	Ship Alteration
SIB	Ship Information Book
SITREP	Situation Report
SME	Subject Matter Expert
SMMSO	Submarine Systems Monitoring Maintenance and Support Office
SNAP	Shipboard Nontactical Automated Data Processing Program
SOE	Submerged Operating Envelope
SORM	Ship Organization and Regulation Manual
SOSMRC	Senior Officer Ship Maintenance and Repair Course
SPALT	Strategic System Programs Alteration
SRD	Selected Record Drawing
SSBN	Nuclear-Powered Ballistic Missile Submarine
SSC	Space and Naval Warfare Systems Center

SSGN	Nuclear-Powered Guided Missile Submarine
SSM	Ship Systems Manual
SSN	Nuclear-Powered Attack Submarine
SRDRS	Submarine Rescue Diving Recompression System
SUBMEPP	Submarine Maintenance Engineering, Planning and Procurement Activity
SUBSAFE	Submarine Safety
SUPSHIP NN	Supervisor of Shipbuilding Newport News
SURFMEPP	Surface Maintenance Engineering Planning Program
SYSCOM	Systems Command
SWOS	Surface Warfare Officer School
TD	Test Depth
TDU	Trash Disposal Unit
TEMPEST	National Policy on the Control of Compromising Emanations (unclassified code name)
TFBR	Technical Feedback Report
TSC	Training Support Center
TSRA	Total Ship's Readiness Assessment
TVD	Technical Variance Documentation
TYCOM	Type Commander
UHF	Ultrahigh Frequency
UNSEARESCOM	Undersea Rescue Command
URO	Unrestricted Operations
USFF	United States Fleet Forces
USFFC	United States Fleet Forces Command
VLS	Vertical Launch System
VTI	Visual TEMPEST Inspection

APPENDIX D
GLOSSARY OF TERMS

<u>TERM</u>	<u>DEFINITION</u>
Alpha Trial	Builder's Propulsion Trial; Acceptance Trial for SSN Propulsion Plant; Initial Tightness Dive (SSN); Dive to Maximum Authorized Depth (Selected SSN platforms).
Acceptance Trials (AT)	Trials and material inspections conducted underway by the INSURV Board for ships constructed in a private industrial activity to determine suitability for acceptance of a ship by the Navy.
Accepting Authority	The officer designated by the Chief of Naval Operations (CNO) to accept a vessel for the Navy, normally NAVSEA.
Bravo Trial	Normally the initial Dive to Test Depth; Noise Trial (SSN); Weapons testing (Surface Combatants).
Builder's Trials (BT)	Evaluation trials and inspections conducted underway by the builder to assure the builder and the Navy that the ship is, or will be, ready for Acceptance Trials. These trials should be a comprehensive test of all ship's equipment and be similar in scope to Acceptance Trials. For Aircraft Carriers, this is the Acceptance Trial for the Nuclear Propulsion plant.
Charlie Trial	Combat Systems and retesting (SSN); Acceptance Trials (Surface Forces as applicable).
Combined Trials (CT)	Combined Trials are a combination of an Acceptance Trial with a Final Contract Trial. The INSURV Board normally conducts Combined Trials for nuclear powered submarines.
Common Assessment Procedures	Common assessment procedures are assessments that, to the maximum extent possible, are common across platforms and serve all users for assessments, inspections and certifications. Common assessment procedures are RCM applicable and effective maintenance procedures that can be properly and consistently executed. They deliver accurate assessment and measurement of, determine and document discrepancies to, and specify repairs required to restore satisfactory material condition. Common assessment procedures satisfy the needs of work definition, inspections and certifications in a common document used both across ship classes and by all activities. The two types of commonality invoked are common across functional use and common across platforms with similar systems and equipment.
Deep Dive	The first dive to maximum operating depth. This depth will not necessarily coincide with the design test depth of the hull. See definition of Maximum Operating Depth.
Delivery	The date the Navy accepts the ship from the shipbuilder. This requires a recommendation from the INSURV Board to accept/deliver the ship. Delivery of the ship is based on Acceptance Trials and satisfactory correction or resolution of deficiencies.
Dock Trial	Dock Trials are those ship trials conducted at the Industrial Activity to determine the ability of the ship, from a material standpoint, to conduct Sea Trials safely.

Executive Agent	A term used in Department of Defense and Service regulations to indicate a delegation of authority by a superior to a subordinate to act on behalf of the superior. An agreement between equals does not create an executive agent.
Fast Cruise	A period immediately prior to underway trials during which Ship's Force operates the ship for dockside training. Fast Cruise shall, as far as is practical, simulate at-sea operating conditions.
Final Contract Trials (FCT)	Trials that are conducted prior to the end of the guarantee period to determine if there are any defects, failures, or deterioration other than that due to normal wear and tear.
Fleet Introduction Team (FIT)	A team of personnel assembled to support a pre-commissioning crew by monitoring progress of construction and coordinating training and facilities. They provide administrative support in all facets of new construction.
Fleet Week	Top Management Attention (TMA) O-6 level panel meeting to discuss the Technical Ticklers, review action items, close issues where action is complete and refer issues to Top Management Issues that require Flag level action. Fleet Week is held twice a year, generally in October and April.
Guarantee Material Inspection (GMI)	A material inspection, conducted inport prior to Post Shakedown Availability (PSA) by a Trial Board prior to the end of the guarantee period when CNO has authorized a Combined Trial to determine if contractor responsible equipment has operated satisfactorily during the guarantee period. It shall include the opening and inspection of equipment designated by the Board together with the operation and visual inspection of equipment and the review of material maintenance records.
Guarantee Period (New Construction)	The period of time immediately following preliminary acceptance (delivery), normally eight or nine months (six months for nuclear powered ships), for which the industrial activity is responsible for the correction of deficiencies.
Guarantee Period (PSA)	The guarantee period following PSA varies with the type of contract. Historically, a "cost plus" type contract has had a guarantee period of six months and a "fixed price" type contract a period of 90 days. The Supervising Authority will advise at the time of PSA the guarantee that applies.
In-Service	Nuclear powered ships are assigned an active status of In-Service approximately two to four weeks (two to four months for aircraft carriers) prior to the commencement of Sea Trials and maintain this status until commissioning.
Industrial Activity	The activity responsible for accomplishing construction or repair of ships whether private or public. This includes Naval shipyards, private shipyards, shipbuilders, vendors, Naval Aviation Depots, Naval Ship Repair Facilities, and other Naval Repair/Technical Activities (i.e., Naval Underwater Weapons Center, Naval Ships Weapons Center, etc.).
Initial Dive	For purposes of seawater valve and system testing, as defined in NAVSEAINST C9094.2, the first dive to a depth not previously reached during the trials.
Initial Tightness Dive	First submergence (a submarine's Alpha Trial).

INSURV	Prior to the acceptance and delivery of a new ship, whether built by a private or a naval industrial activity, all machinery, electronics and weapons systems installed shall be subjected to acceptance trials to determine that the installations are capable of meeting performance specifications. Depending upon your platform these trials are referred to as either Acceptance Trials, Combined Trials or INSURV. This independent verification of the ship's readiness for acceptance and recommendation for fleet introduction is the responsibility of the President, Board of Inspection and Survey.
Lead Maintenance Activity	The single activity responsible for integrating all maintenance and modernization on U.S. Naval ships during any type of availability.
Maximum Operating Depth (Also Maximum Authorized Operating Depth)	The depth to the keel for a particular submarine which is authorized by Commander Submarine Forces Atlantic/Commander Submarine Forces Pacific upon the recommendation of NAVSEA, as the depth not to be exceeded in operations. This depth is normally the Test Depth but may be reduced in specific cases. The depth authorized may be less than, but in no case exceed, the depth recommended by NAVSEA.
Mid-Cycle	Intermediate meeting held between Fleet Weeks to discuss a limited number of Technical Ticklers and pending action items.
Moderate Speed	The range of speed that allows the submarine optimum recovery (as shown on applicable submerged operating envelope curves) if loss of stern plane control and/or flooding occurs. Normally 8-15 knots.
Naval Supervisory Authority/Supervisory Authority	The officer designated to represent the Navy Department at an industrial activity; normally a Supervisor of Shipbuilding (new construction), Regional Maintenance Center (Conversion and Repair), or the Commander of a Naval Shipyard.
Post Shakedown Availability (PSA)	An industrial activity availability following Final Contract Trials/Guarantee Material Inspection assigned to correct deficiencies found during the shakedown period or to accomplish other authorized improvements.
Reliability Centered Maintenance	A methodology to develop or revise a maintenance approach with the objective of maintaining the inherent reliability of the system or equipment, recognizing that changes in inherent reliability may be achieved only through design changes.
Technical Data	Recorded information (regardless of the form or method of recording) of a scientific or technical nature (including computer databases and computer software documentation). This term does not include computer software or financial, administrative, cost or pricing, or management data or other information incidental to contract administration. The term includes recorded information of a scientific or technical nature that is included in computer databases. For these purposes, technical data includes the characteristic of a particular science, trade or profession.
Technical Tickler	A "living document" submitted by the Commander, United States Fleet Forces Command Maintenance Officer to present the Fleet's top material readiness issues to COMNAVSEASYSCOM and Office of the Chief of Naval Operations Resource Sponsors and used subsequently to record and track their planned corrective action.

Test Depth (TD)	For the purpose of the proper method of measuring and specifying Test Depth, the following applies: Test Depth shall be measured to the bottom of the keel for all types of submarine operations. Builders trials and trials following major industrial activity availabilities greater than six months, shall be at a tolerance of plus zero (0), minus twenty (20) feet of Test Depth when specified. All other trials can be conducted at 95% to 100% of Test Depth to satisfy all the requirements specified for 100% Test Depth.
Top Management Issues (TMI)	Top Management Issues, flag level panel meeting to discuss those issues requiring identification or realignment of resources (funding or manpower), or flag level participation to resolve.
Valve Repair/Restoration/Overhaul	<ul style="list-style-type: none">a. Repair. Any work done to improve the material condition or operation of the valve correcting deficient conditions such that the component may be returned to service, but which, in total does not meet the full intent of the applicable restoration/overhaul technical standard, is considered a repair.b. Restoration/Overhaul. All valve parts replaced or restored to the requirements of the applicable technical standard (e.g., the full intent of the restoration/overhaul technical standard is invoked).
Waterline	The term “waterline” in this manual refers to where the hull of a ship meets the surface of water when afloat.
Work	<ul style="list-style-type: none">a. Any action that actually or potentially changes (including disassembly for the purposes of inspection or repair) the approved configuration of any part, component or ship’s system.b. Any action that removes or affects the ship’s ability to operate ship’s systems or components in accordance with ship’s systems/operating manuals or reactor plant manuals.c. Any testing or inspections required to establish, maintain or reestablish certification.d. Any design, engineering, planning or configuration management functions that involve the final review and/or approval of technical information. <p>Examples of work include the following:</p> <ul style="list-style-type: none">1. Action which disassembles or removes any part, component or ship’s system.2. Action specified in a Technical Work Document.3. Any action that removes or affects the ship’s ability to operate ship’s systems or components in accordance with ship’s systems manuals, operating manuals or reactor plant manuals, excluding tagout in accordance with the Tagout Users Manual, including but not limited to:<ul style="list-style-type: none">(a) Component or system tests.(b) Intrusive inspections (such as breaking the plane of electrical panels requiring electrical safety).

- (c) Valve line ups that alter the normal system line up not governed by operating procedures.
- (d) Removing valve hand wheels, disconnecting of reach rods.

(This Page Intentionally Left Blank)

VOLUME I**CHAPTER 2****POLICIES AND RESPONSIBILITIES**REFERENCES.

- (a) OPNAVINST 4700.8 - Trials, Acceptance, Commissioning, Fitting Out, Shakedown, and Post Shakedown Availability of U.S. Naval Ships Undergoing Construction or Conversion
- (b) OPNAVINST 9080.3 - Procedures for Tests and Trials of Navy Nuclear Powered Ships Under Construction, Modernization, Conversion, Refueling and Overhaul
- (c) NAVSEA T9044-AD-MAN-010 - Requirements Manual for Submarine Fly-By-Wire Ship Control Systems
- (d) INSURVINST 4730.1 - Material Inspections (MI) of Surface Ships
- (e) INSURVINST 4730.2 - Trials and Material Inspections of Submarines
- (f) NAVSEA S0300-B2-MAN-010 - Supervisor of Shipbuilding, Conversion and Repair Operations Manual
- (g) NAVSEAINST 4790.8/OPNAVINST 4790.4 - Ships' Maintenance and Material Management (3-M) Manual
- (h) NAVSEAINST 4734.1 - NAVSEA Test, Measurement, and Diagnostic Equipment (TMDE) and Calibration Programs
- (i) NAVAIRINST 13640.1 - NAVAL Aviation Metrology and Calibration (METCAL) Program
- (j) COMNAVAIRLANT/COMNAVAIRPACINST 3500.20 - Aircraft Carrier Training and Readiness Manual
- (k) NAVSEAINST C9210.30 - Procedures for Administration of Nuclear Reactor Plant Preventive Maintenance and Tender Nuclear Support Facilities Preventive Maintenance on Ships
- (l) OPNAVINST C3000.5 - Operation of Naval Nuclear Powered Ships
- (m) COMNAVSUBFOR OPOD 2000
- (n) SSPINST 5600.11 - Preventive Maintenance Management Program for Strategic Weapon Systems Equipments and Associated Material
- (o) COMNAVSUBFORINST 5400.25 - Standard Submarine Supply Department Organization and Regulations Manual
- (p) COMNAVSUBFORINST 5400.29 - Standard Submarine Navigation/Operations Department Organization and Regulations Manual
- (q) COMNAVSUBFORINST 5400.40 - Standard Submarine Combat Systems Department Organization and Regulations Manual (SSN)
- (r) COMNAVSUBFORINST 5400.41 - Standard Submarine SSBN 726 Class Weapons Department Organization and Regulations Manual
- (s) COMNAVSUBFORINST 5400.47 - Standard Submarine Combat Systems Department Organization and Regulations Manual (SSGN)
- (t) COMNAVSURFLANT/COMNAVSURFPACINST 3502.2 - Surface Force Training Manual
- (u) OPNAVINST C9210.2 - Engineering Department Manual for Naval Nuclear Propulsion Plants
- (v) OPNAVINST 4790.15 - Aircraft Launch and Recovery Equipment Maintenance Program (ALREMP)
- (w) COMNAVSURFLANTINST 3540.18/COMNAVSURFPACINST 3540.13 - Engineering Department Organization and Regulations Manual (EDORM)
- (x) COMSUBFOR/COMSUBPACINST C5400.30 - Engineering Department Organization Manual
- (y) NAVSEAINST 5450.142 - Mission and Functions of the Surface Maintenance Engineering Planning Program Activity
- (z) COMNAVSURFLANTINST 4700.4 - Fleet Introduction Handbook

LISTING OF APPENDICES.

- A Message Scenario and Sample Messages/Letters for Habitability Inspections and In-Service
- B Message Scenario and Sample Messages for Fast Cruise and Alpha Sea Trial (Nuclear Powered Ships)
- C Message Scenario and Sample Messages for Bravo, Charlie and Combined Trials (Submarines)

- D Message Scenario and Sample Messages for URO Certification (Submarines)
- E Pre-RSE/RSE/Criticality/Power Range Testing Logic Table (All Nuclear Powered Ships)
- F Sample TYCOM Message Concerning Sea Trial Agenda (Submarines)
- G Sample TYCOM SRDRS Support Services Message (Submarines)
- H Sample TYCOM Message to PCU Concerning Use of the FBW SCS In Support of Alpha Sea Trials (Submarines)
- I Sample TYCOM Message to PCU Concerning FBW SCS Material Condition Initial Certification (Submarines)
- J Sample TYCOM Message to the Ship Concerning FBW SCS Certification (Submarines)
- K Sample Supervising Authority Message to NAVSEA Concerning PCU FBW SCS Material Condition Readiness for Fast Cruise and Alpha Sea Trials (Submarines)
- L Sample Supervising Authority Message to TYCOM and NAVSEA Concerning PCU Fast Cruise Completion and Readiness of FBW SCS Material Condition for Alpha Sea Trials (Submarines)
- M Sample Supervising Authority Message to NAVSEA Concerning PCU FBW SCS Material Condition Readiness Upon Completion of Alpha Sea Trials and Readiness of the FBW SCS for Use During Bravo and Subsequent Sea Trials (Submarines)
- N Sample Supervising Authority Message to NAVSEA Concerning PCU FBW SCS Material Condition Initial Certification (Submarines)
- O Pre Man-Up Checklist for TYCOM/ISIC
- P Basic Requirements for Initial Man-up Personnel of the PCU (Detachment Concept) (Aircraft Carriers and Surface Force Ships)
- Q Basic Requirements for Initial Man-up Personnel of the PCU
- R Generic Base Line of Fleet Introduction Team (FIT) Functions and Responsibilities
- S Sample NAVSEA Message to TYCOM Concerning PCU FBW SCS Material Condition Readiness for Alpha Sea Trials (Submarines)
- T Sample NAVSEA Message to TYCOM Concerning PCU FBW SCS Material Condition Initial Certification (Submarines)
- U Sample NAVSEA Message to TYCOM Concerning PCU Recommendation for Fly-By-Wire Ship Control System Certification

2.1 NAVY SHIPBUILDING PROGRAM MANAGERS. The various Naval Sea Systems Command (NAVSEA)/Program Executive Office for Carriers, Littoral Warfare and Auxiliary codes designated as Navy Shipbuilding Program Managers provide the specifications for the building and testing of all ships. These codes are initially established to get the shipbuilding program and development of logistic support programs up and running.

2.1.1 Pre-Commissioning. Navy Shipbuilding Program Manager responsibilities during the Pre-Commissioning phase of New Construction are delineated in references (a) and (b). The following is a summation of those responsibilities and is intended to be used as a guide, not to be considered all inclusive. Questions concerning a Navy Shipbuilding Program Manager's specific functions should be directed to the applicable NAVSEA code.

- a. Provide supervision and direction concerning all non-nuclear aspects of ship construction.
- b. Provide written instructions to the Supervising Authority regarding the conduct and scheduling of all non-nuclear ship testing.
- c. Generate the correspondence (message or letter traffic) as indicated in Appendix A of this chapter recommending the Habitability Inspection and In-Service dates.
- d. The assignment of deficiency responsibility and ensuring the correction of those deficiencies identified during Combined Trials (CT), Acceptance Trials (AT), Final Contract Trials (FCT) and Guarantee Material Inspections (GMI).
- e. Report to the Type Commander (TYCOM), with information copies to Chief of Naval Operations (CNO) and Fleet Commander, that the material condition of the ship is certified satisfactory for Alpha Sea Trials and recommend authorization to dive the ship be granted under deliberate and controlled conditions to a specified depth for accomplishment of the approved Sea Trials agenda. Appendix B of this chapter provides a sample message flowchart for surface force ships and aircraft carriers. Appendix B-SUBS of this chapter provides a sample message flowchart for submarines.

- f. (Submarines only) Report to the TYCOM that the material condition of the ship is certified satisfactory for Bravo, Charlie, and CTs. Appendix C of this chapter provides a sample message.
- g. (Submarines only) After completion of all Sea Trials, report to the TYCOM that the material condition of the ship is certified for Unrestricted Operations (URO). Appendix D of this chapter provides a sample message.

2.1.2 Post Shakedown Availability (Submarines only). Navy Shipbuilding Program Manager responsibilities during Post Shakedown Availability (PSA) are defined in Volume II, Part I, Chapter 3 of this manual.

2.2 NAVAL SEA SYSTEMS COMMAND NUCLEAR PROPULSION DIRECTORATE (NUCLEAR POWERED SHIPS ONLY).

2.2.1 Pre-Commissioning. NAVSEA Nuclear Propulsion Directorate (08) responsibilities for the Pre-Commissioning period are as follows:

- a. Provide specifications for the building and testing of the nuclear propulsion plant.
- b. Provide supervision and direction of nuclear propulsion plant testing and trials.
- c. Approve the sequencing and scheduling of nuclear propulsion plant tests and trials.
- d. Arrange for technical assistance from the U.S. Department of Energy, including the Pre-Critical Examination by the Director, Division of Naval Reactors.
- e. Provide written instructions to the Supervising Authority regarding the conduct and scheduling of all dockside tests and underway trials involving operation of the nuclear propulsion plant.
- f. Authorize critical operation of the reactor.
- g. Authorize commencement of Fast Cruise after receiving notification from the Supervising Authority that the ship has demonstrated a satisfactory state of training.

2.2.2 Reactor Safeguard Examination. A Pre-critical Reactor Safeguard Examination (RSE) will be conducted by NAVSEA 08 prior to initial reactor criticality. NAVSEA 08 will approve operation of the Nuclear Propulsion Plant during dockside testing and underway trials. Volume I, Chapter 3, Appendix C of this manual provides information on Pre-RSE preparations.

2.2.3 Criticality/Power Range Testing. Upon receiving the request for initial criticality from the Supervising Authority, NAVSEA 08 will authorize critical operation of the reactor, with subsequent power range testing. Appendix E of this chapter provides a listing of the events leading up to the authorization for critical operation of Naval Nuclear Propulsion plants, with sample request messages and/or letters.

2.2.4 Post Shakedown Availability. NAVSEA 08 responsibilities for the PSA period are as follows:

- a. Provide approved test procedures for the verification of reactor plant repairs and alterations accomplished in the availability.
- b. Arrange for technical assistance by the U.S. Department of Energy as required.

2.3 TYPE COMMANDER. Reference (a) states the TYCOM is responsible for monitoring the construction and acceptance process to ensure “customer” input is provided. Reference (c) describes the TYCOM’s responsibilities during new construction for Submarine Fly-By-Wire Ship Control Systems (FBW SCS). The following summarizes major TYCOM responsibilities during the Pre-Commissioning, FCT/GMI and PSA periods.

2.3.1 Pre-Commissioning. During the construction phase, major TYCOM responsibilities include but are not limited to:

- a. Designating an Immediate Superior in Command (ISIC) for all units being built within the TYCOM’s geographical area of responsibility.
- b. Ensuring that the Pre-Commissioning Unit (PCU) is placed on distribution for all message traffic applicable to the platform and platform’s operational environment.
- c. Reviewing all incoming correspondence for PCU applicability and forwarding platform related documentation as required.

- d. Conducting the Habitability Inspection when requested by the Accepting Authority (may be delegated to the ISIC). Sample messages relating to Habitability and In-Service are contained in Appendix A of this chapter.
- e. Recommending to the CNO that the ship be placed “In-Service Active” upon receiving satisfactory results of the Habitability Inspection. Appendix A of this chapter provides sample messages.
- f. (Nuclear Powered Ships only) Conducting or assisting the ISIC with the Pre-RSE.
- g. (Surface Force Ships only) Establishing Light-Off Assessment (LOA) dates via liaison with the ISIC, the Ship and the Afloat Training Group (ATG).
- h. Conducting or directing the conduct of the arrival assist and periodic monitoring inspections as defined in Volume I, Chapter 3, paragraph 3.3.1 and 3.3.2 of this manual.
- i. (Nuclear Powered Ships only) Conducting an inspection to certify crew training per the requirements of reference (b).
- j. (Nuclear Powered Ships only) Exercising operational control during underway trials either directly or through the designated ISIC.
- k. (Submarines only) Reviewing the schedule and sequence of Sea Trial Agendas and concurring by message to the Supervising Authority concerning the operational aspects of the specific trial. Appendix F of this chapter provides a sample message.
- l. (Submarines only) Providing escorts as may be required. Send Sea Trial support services message to specify Submarine Rescue Diving Recompression System “modified alert” requirements. Appendix G of this chapter provides a sample message.
- m. (Submarines only) Assigning an unrestricted Line Officer (a former Commanding Officer (CO) senior to the Officer In Charge (OIC)) as the TYCOM Embarked Representative who has authority to act for the TYCOM, making on-the-spot changes to approved Sea Trial Agendas.
- n. (Submarines only) If desired, assigning an officer to act as the TYCOM material representative on selected trials. The material representative’s duties include:
 - (1) Serving as a technical advisor to the TYCOM Embarked Representative on matters pertaining to Sea Trial Agenda modifications, compliance with this instruction and disposition of emergent material problems.
 - (2) Acting for the TYCOM in making on-the-spot changes to approved Sea Trial Agendas in the absence of the TYCOM Embarked Representative.
- o. (Submarines only) Reporting to the CNO and the Navy Shipbuilding Program Manager that the crew is ready for underway trials, prior to Fast Cruise and upon receipt of the ISIC message certifying the operational readiness of the submarine crew. Appendix B of this chapter reflects the message scenario and contains sample messages for Fast Cruise/Alpha Trials.
- p. (Submarines only) Promulgating of the Alpha Sea Trial Depth Authorization upon receipt of the Supervising Authority message reporting completion of Fast Cruise and the Navy Shipbuilding Program Manager message promulgating the authorized depth for the Alpha Trial. Appendix B of this chapter provides sample messages.

NOTE: SUBSEQUENT TO THE NAVY SHIPBUILDING PROGRAM MANAGER AND SUPERVISING AUTHORITY MESSAGES PROMULGATING DEPTH AUTHORIZATION AND REPORTING THE SHIP’S MATERIAL READINESS TO COMMENCE FAST CRUISE AND SEA TRIALS, ANY DEFICIENCY DISCOVERED AND CORRECTIVE ACTION TAKEN WHICH AFFECTS THE WATERTIGHT INTEGRITY, THE RECOVERABILITY OF THE SHIP, THE OPERATIONS OF THE SHIP’S CONTROL SURFACES OR THE SHIP’S SALVAGE CAPABILITY SHALL BE REPORTED TO THE NAVY SHIPBUILDING PROGRAM MANAGER, THE TYCOM AND FLEET COMMANDER BY THE SUPERVISING AUTHORITY/ISIC/TYCOM REPRESENTATIVE AND PCU BY MESSAGE. PREVIOUS CERTIFICATION MESSAGES SHALL BE SUSPENDED. WHEN THE NAVY

SHIPBUILDING PROGRAM MANAGER'S REVIEW OF THE MESSAGE IS COMPLETED, THE NAVY SHIPBUILDING PROGRAM MANAGER WILL CERTIFY TO THE TYCOM THAT THE MATERIAL CONDITION OF THE SHIP IS SATISFACTORY FOR SEA TRIALS TO A SPECIFIED DEPTH.

- q. (Submarines only) Promulgating by message the Bravo, Charlie and Combined Trials Depth Authorization after receipt of the Supervising Authority message confirming readiness for the test depth dive and the Navy Shipbuilding Program Manager message promulgating Sea Trial Depth Authorization. Appendix C of this chapter provides sample messages.
- r. (Submarines only) Promulgating by message to the PCU the final URO Material Certification upon receipt of the Supervising Authority message concerning material condition for URO and the Navy Shipbuilding Program Manager message recommending URO. Appendix D of this chapter provides sample messages.
- s. (Applicable Submarines only) Prior to Alpha Sea Trials and following NAVSEA certification that the submarine FBW SCS is satisfactory for sea trials and Supervising Authority report that the FBW SCS is satisfactory for commencement of Alpha Sea Trials, report by message to ship authorizing conduct of sea trials in accordance with the approved Sea Trial Agenda and specifically identify any operating restrictions of the ship and/or system. Repeat the routine for each subsequent sea trial. Appendix H of this chapter provides a sample message.
- t. (Applicable Submarines only) After all builder's sea trials, and following NAVSEA certification that the submarine FBW SCS is satisfactory for unrestricted use, report by message to ship authorizing FBW SCS unrestricted use in support of submarine unrestricted operations or specifically identify any operating restrictions of the ship and/or system. Appendix I of this chapter provides a sample message.

2.3.2 Combined Trials/Acceptance Trials/Final Contract Trials/Guarantee Material Inspection. The TYCOM's responsibilities for these trials are documented in references (a), (d), and (e). The most significant action from the ship's perspective is the TYCOM's presenting of the ship for GMI or FCT.

2.3.3 Post Shakedown Availability. The TYCOM's responsibilities as related to PSA are as follows:

- a. (Surface Force Ships only) Assist with LOA as shown in Volume I, Chapter 6, Appendix C.
- b. (Nuclear Powered Ships only) Conduct or assist the ISIC in conducting the Pre-Critical Inspection (only required when reactor has been shut down greater than 16 weeks). Schedule the Fleet Commander Post-Overhaul RSE as recommended by the Industrial Activity in the Key Events Schedule and confirmed by the parent ISIC/TYCOM representative (required if the availability is scheduled for more than six months) upon completion of the ISIC's Pre-Critical Inspection.
- c. (Submarines only) TYCOM responsibilities are defined in Volume II, Part I, Chapter 3 of this manual.
- d. (Applicable Submarines only) For the first ship of a class or when directed by NAVSEA, ship control trials are planned and conducted under the direction of NAVSEA 05 to support verification that the FBW SCS automatic control algorithms performance is in accordance with Section 4 of reference (c). Upon successful completion of these trials, the Navy Shipbuilding Program Manager issues to TYCOM, the ship's final FBW SCS certification message with NAVSEA 07 concurrence and in support of the submarine class FBW SCS design. TYCOM issues to the ship a final FBW SCS certification message. When required, by message or letter, the NAVSEA Navy Shipbuilding Program Manager via separate correspondence shall identify impact to the FBW SCS Certification of other ships in the submarine class. Appendix J of this chapter provides a sample message

2.4 SUPERVISING AUTHORITY. References (a), (b), (c) and (f) describe the Supervising Authority's responsibilities during new construction. The following is a synopsis of those functions with additional amplification. Platform unique functions are identified by indicating the applicable class (if any) or group covered (i.e., Nuclear Powered Ships).

2.4.1 Pre-Commissioning. The Supervising Authority's responsibilities as related to Pre-Commissioning are as follows:

- a. Provide crew support as directed by the Navy Shipbuilding Program Manager. This support may include facility support requirements such as berthing, administration, officer and crew training spaces, vehicles for transportation, computers for development of training programs and ship's directives.
- b. Ensure PCU office spaces have been certified to the appropriate classification for storage of classified documentation.
- c. Provide the required safety training and gear to the crew for working in an industrial area.
- d. Provide initial briefing to Prospective Commanding Officer (PCO)/crew to provide an overview of the Supervisor's role during construction.
- e. Provide to the PCO/crew the planning documents necessary for establishing goals during New Construction, such as a Master Construction Schedule, an Operational Control Transfer (OCT) schedule, Testing schedules, and all other schedules that would require crew support and coordination.
- f. Act as liaison for the ship in resolving conflicts in construction schedules.
- g. Ensure that at least ten copies of reference (g) are available to support Phase 1 and Phase 2 of the Planned Maintenance System (PMS) installation.
- h. Provide the PCU with at least one set of all the technical manuals required to support the equipment installed on the particular platform.
- i. Provide the PCU with, or access to a complete set of ship's drawings and contract specifications.
- j. Monitor the ship's familiarization training conducted by the Industrial Activity or Fleet Introduction Team (FIT) for fulfillment of the contract. For familiarization training conducted using computer-aided instruction, the Supervising Authority is responsible only for ensuring sufficient resources are available to the PCU to utilize the training. Provide feedback to the Navy Shipbuilding Program Manager and the Industrial Activity concerning content and value of this training.
- k. Recommend to the Navy Shipbuilding Program Manager the commencement date for the Habitability Inspection. Appendix A of this chapter provides sample documentation.
- l. Recommend to the Navy Shipbuilding Program Manager the date for placing the ship "In-Service". In-Service for submarines should occur approximately two to four weeks prior to underway trials and for aircraft carriers two to four months prior to underway trials. Appendix A of this chapter provides sample documentation.
- m. Recommend to the Accepting Authority the date for placing the ship "In Commission". The In Commission date is normally on or about the date of delivery.
- n. Request necessary services for each trial from the Fleet Commander in accordance with reference (a), with an information copy to the TYCOM.
- o. (Nuclear Powered Ships only) Accept custody of special nuclear material upon delivery from the U.S. Department of Energy.
- p. (Nuclear Powered Ships only) Transfer custody of, and responsibility for, special nuclear material to the OIC when the ship is placed "In-Service".
- q. (Nuclear Powered Ships only) Coordinate the schedule for dockside and underway tests and trials in accordance with the requirements of the Navy Shipbuilding Program Manager and the Builder.
- r. (Nuclear Powered Ships only) Provide sufficient time for crew training and Fast Cruise during the building period to permit Ship's Force to attain a state of training adequate to ensure proper operation and safety of the ship and its personnel during Sea Trials. Provide sufficient time for the correction of deficiencies after the completion of the final Dock Trials and before the start of the operational training period.
- s. (Nuclear Powered Ships only) Submit for approval the schedule and sequence of any dockside tests or Sea Trials involving operation of the nuclear propulsion plant to NAVSEA 08, except where such tests and trials have been approved in the written instructions provided by NAVSEA 08.

- t. (Submarines only) Coordinate with ISIC for support personnel to perform salvage inspection.
- u. (Nuclear Powered Ships only) Submit the schedule and sequence of all Sea Trials to the ISIC for approval and to the TYCOM for concurrence with the operational aspects of the trial.
- v. (Nuclear Powered Ships only) Report to the Navy Shipbuilding Program Manager when the ship is ready for Fast Cruise and Alpha Sea Trial (Builder's Trials for aircraft carriers). Appendix B of this chapter provides a sample message.
- w. (Nuclear Powered Ships only) Report the successful completion of Fast Cruise and readiness for Alpha Sea Trial (Builder's Trials for aircraft carriers), with the concurrence of the OIC, to the TYCOM, with an information copy to the Navy Shipbuilding Program Manager, the Fleet Commander and the ISIC. Appendix B of this chapter provides a sample message for submarines.
- x. (Nuclear Powered Ships only) Report to the Navy Shipbuilding Program Manager the satisfactory completion of Alpha Sea Trials (Builder's Trials for aircraft carriers). For submarines, the material status of the ship is certified to support operations to test depth. Appendix C of this chapter provides a sample message.
- y. (Submarines only) Certify to the Navy Shipbuilding Program Manager the completion of all Sea Trials, reporting the status of all Sea Trial deficiencies and all CAT 1A Audit Items. Certify the material condition of the ship is satisfactory for URO to test depth. Appendix D of this chapter provides a sample message.
- z. Retain responsibility for the material condition of the ship until it reports for duty in the fleet.
- aa. Maintain "Lessons Learned Logs" from the CO of previously built ship for delivery to the next PCO/OIC.
- ab. (Applicable Submarines only) Report by message to NAVSEA Navy Shipbuilding Program Manager, in advance of the scheduled start of Fast Cruise, that all FBW SCS work necessary for Alpha Sea Trials, including resolution of NAVSEA FBW SCS Certification Audit Category I recommendations, has been completed, provide the status of all incomplete NAVSEA FBW SCS Certification Audit Category IA recommendations, and that the FBW SCS is ready for commencement of Fast Cruise. The message shall also state that there are no conditional FBW SCS Deviations or Waivers which have not been satisfied or cite those that exist, identify any operating restrictions of the ship and/or system, and that, subject to satisfactory completion of Fast Cruise and resolution of mandatory FBW SCS deficiencies, the submarine FBW SCS is satisfactory for commencement of sea trials. Make a similar report prior to each subsequent sea trial. Appendix K of this chapter provides a sample message.
- ac. (Applicable Submarines only) Report by message to the NAVSEA Navy Shipbuilding Program Manager and TYCOM, with the concurrence of the ship's Commanding Officer, successful completion of Fast Cruise as a prerequisite for the start of sea trials. Appendix L of this chapter provides a sample message.
- ad. (Applicable Submarines only) Report by message to the NAVSEA Navy Shipbuilding Program Manager the satisfactory completion of Alpha Sea Trials and report the status of all incomplete NAVSEA FBW SCS Certification Audit Category IA recommendations. Appendix M of this chapter provides a sample message.
- ae. (Applicable Submarines only) Report by message to the NAVSEA Navy Shipbuilding Program Manager the satisfactory completion of all shipbuilder's sea trials, correction of all mandatory sea trial deficiencies, and resolution of all NAVSEA FBW SCS Certification Audit Category IA recommendations. Report that the submarine FBW SCS is satisfactory for unrestricted use in support of submarine unrestricted operations. Identify all deferred FBW SCS work and/or conditionally approved deviations and waivers to date which have not had the condition satisfied and specifically identify any operating restrictions of the ship and/or system. Appendix N of this chapter provides a sample message.
- af. Prior to Ship's Force assuming operational control, ensure that assigned New Construction units operate and maintain installed diesel engines in accordance with established procedures. Specifically, the Supervisor shall:

- (1) Schedule a routine diesel inspection prior to initial start-up by Ship's Force.
 - (2) Observe diesel engine operations during shipboard visits in accordance with Volume IV, Chapter 4 of this manual.
 - (3) Ensure that the Automated Diesel Engine Trend Analysis Program addressed by reference (g) and TYCOM directive is in place.
- ag. Prior to Ship's Force assuming operational control, ensure that assigned New Construction units operate and maintain an installed gas turbine in accordance with established procedures. The Supervisor shall schedule a gas turbine inspection prior to start up by Ship's Force.

2.4.2 Acceptance Trials/Combined Trials. The Supervising Authority is responsible for presenting the ship for AT/CTs. References (d), (e), and (f) delineate the Supervising Authority's responsibilities concerning these trials. Several of the more significant issues are:

- a. Submit for approval the schedule and sequence of AT/CT to the President, Board of Inspection and Survey (INSURV).
- b. Request necessary services for each trial from the Fleet Commander in accordance with reference (a), with an information copy to the TYCOM.
- c. Provide riders to assist and provide system/historical expertise.

2.4.3 Post Shakedown Availability. During PSA the Supervising Authority is responsible for the following:

- a. Determining, in conjunction with the CO, the type and extent of post-repair dockside and at-sea tests/trials, in addition to those described in Volume I, Chapter 6, section 6.4 of this manual. Submit the following for approval:
 - (1) The schedule and sequence of post-repair nuclear propulsion plant trials to NAVSEA for concurrence and the ISIC/TYCOM Representative for approval.
 - (2) The schedule and sequence of post-repair trials subsequent to the nuclear propulsion plant trials to the ISIC for approval. Include the TYCOM as a Copy To addressee.
- b. Providing sufficient time for crew training to support Fast Cruise and to ensure the proper operation and safety of the ship.
- c. Coordinating the schedule for Fast Cruise and post repair trials with the ISIC/TYCOM representative. Submit the Sea Trials Agenda to the Navy Shipbuilding Program Manager for approval.
- d. (Submarines only) Additional Supervising Authority responsibilities are defined in Volume II, Part I, Chapter 3 of this manual.
- e. Reporting to the TYCOM the completion of Fast Cruise and the correction of all mandatory deficiencies. Recommend commencement of Sea Trials with the CO's concurrence in accordance with Volume II, Part I Chapter 3 of this manual.
- f. Reporting to the Navy Shipbuilding Program Manager or the TYCOM (PSA less than six months) that Sea Trials have been completed, and for submarines, that the material condition of those parts of the ship installed, prepared and/or tested by the Industrial Activity is satisfactory for URO to design test depth, concurrence in accordance with Volume II, Part I Chapter 3 of this manual.

2.4.4 Deficiencies. The Supervising Authority's primary functions involve the building of ships and the correction/resolution of deficiencies discovered during the building and trials portion of construction. Reference (f) and locally generated Supervising Authority Instructions provide specific and detailed information pertaining to deficiencies, their identification, tracking and resolution. Contact the Supervising Authority for more information. Volume I, Chapter 5 of this manual also provides additional guidance.

2.5 IMMEDIATE SUPERIOR IN COMMAND. The ISIC is the TYCOM's delegate.

2.5.1 Pre-Commissioning. During the Pre-Commissioning period, the ISIC is responsible for the following:

- a. Providing crew support prior to initial man-up. Personnel arriving prior to initial manning will be tasked with coordinating with the Supervising Authority to start the necessary preparations for initial man-up. Appendix O of this chapter provides a checklist of areas that need to be addressed several months before personnel start arriving.
- b. Conducting an inspection approximately two months following the arrival of the first increment of the crew at the building yard, using Volume I, Chapter 3, paragraph 3.3.1 of this manual as a guide.
- c. Conducting periodic monitoring of ships per Volume I, Chapter 3, paragraph 3.3.2 of this manual to include:
 - (1) Technical and/or administrative/training assistance visits (Tech Assists) directed toward improvements in the management and conduct of maintenance and training tasks.
 - (2) Evaluation visits (Work-ups) to determine the state of administration and training.
 - (3) Spot checks (Monitor Visits) to monitor the progress and effectiveness in specific material, training and administrative areas.
- d. Coordinating with the Bureau of Personnel (BUPERS) to ensure personnel arrive in support of initial crew man-up.
- e. Conducting a Habitability Inspection when directed by the TYCOM. Volume I, Chapter 3, Appendix D of this manual provides information concerning the Habitability Inspection and a sample Compartment Surveillance Guide. Volume I, Chapter 3, Appendix E of this manual provides a sample check list.
- f. Making recommendations to the TYCOM for placing the ship "In-Service". Appendix A of this chapter provides a sample message.
- g. Contact TYCOM Metrology and Calibration Point of Contact to verify if Establishment of Field Calibration Activity Request has been submitted in accordance with references (h) and (i).
- h. When Ship's Force has assumed operational control, ensuring that assigned New Construction units operate and maintain installed diesel engines in accordance with established procedures. Specifically, the ISICs shall conduct follow-up action to ensure that any unsatisfactory conditions found are corrected at an early date.
- i. (Nuclear Powered Ships only) Conducting a Pre-RSE of the Engineering/Reactor Department to determine the ship's readiness for the Naval Reactors Pre-Critical RSE. The TYCOM will assist in this examination. Volume I, Chapter 3, Appendix C of this manual provides administrative guidelines for the conduct of the Pre-RSE.
- j. (Nuclear Powered Ships only) Reviewing Pre-RSE findings, the CO's training plan, and progress evaluations, and direct follow-up reviews and/or inspections necessary to verify the ship's readiness for the RSE.
- k. (Submarines only) Prior to Fast Cruise, reporting ship's preparations to assume responsibility for Re-entry Control in the Crew/Material Certification message. Appendix B of this chapter provides a sample message.
- l. (Submarines only) Scheduling salvage inspections per Volume IV, Chapter 18 of this manual.
- m. (Submarines only) Designating the salvage inspection team using the guidance provided in Volume IV, Chapter 18 of this manual.
- n. For CVNs, conduct crew certification in accordance with reference (j).
- o. For all other hulls, conduct formal Phase I crew certification inspection(s) of the Ship's Force in accordance with the TYCOM Training Manual (when required). The purpose of this inspection shall be to audit the readiness and training of the Ship's Force, particularly in the areas of watchstander qualifications, damage control readiness, status of operational and emergency bills, presence on board of essential technical manuals and general operational knowledge. This inspection shall be scheduled about one month prior to Fast Cruise and should include written examinations and personal interviews

with officers and key enlisted personnel to determine their readiness and status of training as outlined for Phase I. A comparison of personnel allowance (including Navy Enlisted Classification requirements) versus onboard count shall be made to ensure that the ship is adequately manned.

- p. Conduct Phase II crew certification. Witness and certify to the TYCOM that the state of crew training is satisfactory for at-sea operations in accordance with the TYCOM Training Manual. This will be done during a two day period subsequent to Dock Trials and Phase II crew certification, and prior to Fast Cruise. This two day period shall be scheduled so that there is normally a 48 hour period between the end of this event and the beginning of Fast Cruise. This two day Phase II crew certification period is divided into a 40 hour crew work-up and rest period and an eight hour modified dockside Operational Readiness Inspection. The entire period should be scheduled to minimize interference with industrial activity work. However, since the certification must be conducted carefully to be meaningful, the officer scheduling the certification should coordinate industrial activity interference during the eight hour modified Operational Readiness Inspection. This certification should be thorough and meticulous. Pressure from the industrial activity or any other source to compromise ship safety must not be permitted to influence the judgment of the certifying officers. The desired overall sequence of these events is shown in Appendix B of this chapter.
- q. Conduct a material inspection of the ship.
- r. Satisfactory completion of the inspections of paragraphs 2.5.1.n. through 2.5.1.p. of this chapter should be reported to the TYCOM in one "PRIORITY" crew certification message in accordance with sample message format of Appendix B of this chapter paralleled by a telephone call to the TYCOM Watch Officer reporting the date-time group of the message. If significant deficiencies exist or it appears that an extension of time is required to correct training/material deficiencies, the TYCOM shall be immediately advised by telephone and by message. The Supervising Authority will be included as an information addressee.
- s. A summary of typical New Construction major milestones and message reporting requirements as they apply to the ISIC is listed in Volume I, Chapter 1, Appendix A of this manual.

2.5.2 Post Shakedown Availability. During PSA, the ISIC is responsible for the following:

- a. Conducting periodic monitoring similar to that described in paragraph 2.5.1.c of this chapter, placing the emphasis on the management and conduct of PSA.
- b. (Nuclear Powered Ships only) Conducting a Pre-Critical Inspection of the Engineering/Reactor Department per Volume I, Chapter 6, paragraph 6.3 of this manual. Review inspection findings, the CO's training plan and progress evaluations, and direct follow-up reviews and/or inspections as necessary to verify ship's readiness for criticality.
- c. Witnessing and certifying to the TYCOM that the state of crew training is satisfactory for at-sea operations per the Force Training Manual.
- d. (Aircraft Carriers only) Receiving from the CO/Supervising Authority the scope, schedule and agenda of the tests for Sea Trials for review and approval. When approved, forward copies of the agenda to the TYCOM.
- e. Arranging for the embarkation of technical personnel who may be assigned by the Navy Shipbuilding Program Manager to observe tests or trials.
- f. Arranging for the assignment of operating areas and communications frequencies.
- g. (Submarines only) Scheduling a salvage inspection in time to have discrepancies corrected prior to Fast Cruise.
- h. (Submarines only) Prior to Fast Cruise, auditing Ship's Force Re-entry Control and Departure from Specification Records. Using the Submarine Maintenance Engineering, Planning and Procurement (SUBMEPP) Activity URO Maintenance Requirement Card (MRC) scheduling reports and current Industrial Activity/Ship's Force updates to the latest report, ensure URO MRC accomplishment is current.

- i. (Submarines only) Conducting a material inspection consisting of a vertical audit of Ship's Force and Fleet Maintenance Activity Submarine Safety (SUBSAFE), **Deep Submergence Systems Scope of Certification and FBW** work and URO completion status per Volume V, Part I, Chapter 9 of this manual.
- j. (Submarines only) Additional ISIC responsibilities are defined in Volume II, Part I, Chapter 3 of this manual.
- k. If deficiencies exist and/or it appears that extension of time is required to correct training/material deficiencies, the TYCOM shall be immediately advised by telephone and message. The Supervising Authority will be included as an information addressee. The TYCOM retains the prerogative to authorize corrective action by the Industrial Activity in the case of material deficiencies.
- l. When authorized by the TYCOM, direct the ship to get underway for Sea Trials.

2.6 **BUILDING YARD.** The Building yard is an industrial activity responsible for construction of the ship, correction of shipbuilder responsible deficiencies and additional logistic support products as delineated in the contract. The following is a sample listing of the shipbuilder's products and responsibilities.

- a. Technical Manuals for Contractor Furnished Equipment (CFE).
- b. Ship Information Book (SIB)/Ship Systems Manual (SSM).
- c. PMS for new systems when tasked by Navy Shipbuilding Program Managers or cognizant NAVSEA code.
- d. Selected Familiarization Training.
- e. Ship Drawings.
- f. Advising the Accepting Authority and the TYCOM of the date of initial criticality.
- g. Builder's Trials (non-nuclear) to include:
 - (1) Taking the ship to sea.
 - (2) The testing of all equipment and systems with the exception of weapons.

2.7 **DESIGN YARD/PLANNING YARD.** The Design Yard/Planning Yard, which may also be the Building Yard, is an industrial activity responsible for maintaining the Ship's Drawing Index current with configuration. The Planning Yard is responsible for updating ship's drawings to reflect PSA changes.

2.8 **COMMANDING OFFICER, PROSPECTIVE COMMANDING OFFICER, OFFICER IN CHARGE.**

2.8.1 **General.**

- a. The responsibilities of a PCO for a new construction ship are set forth in U.S. Navy Regulations. In the case of a nuclear powered ship under construction, the PCO has additional responsibilities associated with the operation of the nuclear propulsion plant as specified in references (a) and (b). In order to provide him with authority commensurate with this responsibility the PCO will be designated in his orders as CO of the PCU, a separate and detached command, with responsibilities as specified in references (a) and (b) and U.S. Navy Regulations.
- b. Following completion of the required training and material readiness certification, the CO/PCO/OIC must keep the ISIC fully informed of any changes in personnel, training and/or material status which could affect the validity of certification. Prompt notification is required to permit revision of Operational Orders and services required.

2.8.2 **Pre-Commissioning.** Specific responsibilities of the PCO during the primary construction phase are as follows:

- a. The preparation and execution of training plans, operational and emergency bills, procedures and organization manuals in support of his responsibilities.
- b. The demonstration of his crew's operational and administrative readiness in accordance with the inspections required by Volume I, Chapter 3, paragraph 3.3.4 of this manual.

- c. Verifying that all required Navy Enlisted Classification Codes or other skill requirements are met by BUPERS or by the ship's training programs.
- d. The presentation of the crew for the platform applicable inspections described within this volume.
- e. The designation of a Miniature/Microminiature (2M) Repair or Module Test and Repair Manager.
- f. The designation in writing of a Calibration Coordinator.
- g. Ensuring that at least two NAVSEA/Naval Air Systems Command certified Field Calibration Activity/Aircraft Intermediate Maintenance Department technicians are available to support certification.
- h. Verifying that all pertinent alongside tests, inspections and trials are completed.
- i. The establishment of "Lessons Learned Files". These files are to be turned over to the incoming PCO of the next ship of the class to be built. DDG 51 Class Destroyers should pass their files to the PMS 400 tasked contractor. MHC Class ships can provide this data to the FIT while all others should pass Lessons Learned to the Supervising Authority if the next PCO has not yet arrived.
- j. The establishment of PMS in accordance with reference (g) and Volume I, Chapter 3, paragraph 3.4.1 of this manual.
- k. Concurring with the Navy Shipbuilding Program Manager's request to the TYCOM for the conduct of a Habitability Inspection.
- l. The designation of system/space experts to assist the ISIC with the Habitability Inspection.
- m. The establishment of early liaison with the ATG team OIC to define training needs and the agenda for assist visits in preparation for LOA and Initial Light-Off.
- n. (Nuclear Powered Ships only) The development and execution of training plans and documents in support of his responsibilities for inspection and operation of the nuclear propulsion plant. These plans and documents shall be in conformance with the instructions and procedures approved by NAVSEA.
- o. (Nuclear Powered Ships only) The preparation of ship's engineering/reactor personnel for examination by the Nuclear Propulsion Directorate (NAVSEA 08).
- p. (Nuclear Powered Ships only) Review the findings of the ISIC's Pre-RSE Inspection Team and make necessary adjustments to the ship's training program to ensure the crew's readiness for the RSE. Keep the ISIC advised of the ship's training plan and provide an assessment of the crew's progress.
- q. (Nuclear Powered Ships only) Maintain the Reactor Plant in accordance with reference (k). Ensure records are ready for the ISIC's audit prior to Fast Cruise.
- r. (Nuclear Powered Ships only) Review test and trial schedules and agendas and signify concurrence to the TYCOM and the designated ISIC. Copies of detailed schedules and agendas for underway trials will be forwarded to the designated ISIC, the escort ship (Submarines) and the TYCOM Embarked Representative.
- s. (Nuclear Powered Ships only) Assume duty as the OIC and accept custody and responsibility for special nuclear material, after the ship is placed "In-Service". Report to the Fleet Commander In-Service status. Appendix A of this chapter provides a sample message.
- t. (Nuclear Powered Ships only) The preparation of Ship's Force Dock Trial Agenda.
- u. (Nuclear Powered Ships only) In accordance with the specifications and information in this volume, the conduct of dockside and underway trials. Critical operation of the reactor will be conducted in accordance with reference (l).
- v. (Aircraft Carriers only) Prior to Fast Cruise, report to the TYCOM the successful completion of Crew Certification and recommend commencement of Fast Cruise and Builder's Trials via message. Appendix B of this chapter provides a sample message.

- w. (Nuclear Powered Ships only) When authorized by the Navy Shipbuilding Program Manager, conduct Fast Cruise in accordance with Volume I, Chapter 4, section 4.3 of this manual.
- x. (Nuclear Powered Ships only) During Sea Trials, assume the duties of Officer In Tactical Command unless otherwise designated by the ISIC. For submarines, ISICs must comply with direction found in Annex C of reference (m).
- y. (Nuclear Powered Ships only) Provision for adequate crew rest time during Sea Trials. Six uninterrupted hours in each twenty-four hour period is a minimum for each crew member.
- z. (Nuclear Powered Ships only) In the absence of a TYCOM and ISIC representative, act for the TYCOM in approving on-the-spot changes to approved Sea Trial Agendas.
- aa. (Nuclear Powered Ships only) When all platform applicable requirements of this instruction are completed to the OIC's satisfaction and when permission has been received from the ISIC, proceed to sea in accordance with the operations order and carry out the approved Sea Trial Agenda.
- ab. (Submarines only) If possible, participate in two at sea periods prior to initial Sea Trials as follows:
 - (1) Accompany the preceding ship of the class on the first Sea Trial to learn how the propulsion trial is run (except first ship of class).
 - (2) Participate in an underway period of at least five days duration approximately six months prior to the final phase of Crew Certification. The purpose of this ride is to refamiliarize the PCO with those functions unique to being underway so as to ensure the safe conduct of his own initial Sea Trials and shakedown. This underway period also allows him to validate his crew's training program. This underway period should be on a ship, preferably of the same class, which is concentrating on basic ship/submarine operations, such as Selected Refresher Training or Independent Ship Exercise (ISE), so he can witness such evolutions as: coming to periscope depth, snorkeling, ventilating, casualty training, etc. If the new construction schedule has 10-12 weeks between Power Range testing and the final phase of Crew Certification, the PCO should go to sea approximately two months before initial criticality. The intent is for the PCO to go to sea after having been in the Industrial Activity for a fair amount of time (normally one year or more), but with sufficient time remaining to improve his own training program if necessary. During these underway periods, the PCO should spend time on the bridge and also observe piloting and navigation.

NOTE: IF NOT POSSIBLE TO PARTICIPATE IN TWO AT-SEA PERIODS AS DESCRIBED ABOVE, THE ISIC AND TYCOM WILL COORDINATE REQUIRED TRAINING.

- ac. (Submarines only) Request that the ISIC conduct a salvage inspection in accordance with the policies set forth in Volume IV, Chapter 18 of this manual.
 - (1) Coordinate salvage inspection support requirements as may be needed by the inspecting team to fulfill the requirements of Volume IV, Chapter 18, Appendix D of this manual.
 - (2) Ensure Volume IV, Chapter 18, Appendix D of this manual is completed and furnished to the Senior Inspecting Officer prior to the commencement of the Salvage Inspection.
 - (3) Ensure all ship's data called out in Volume IV, Chapter 18, Appendix D of this manual is assembled and staged prior to the inspection for ease of reference by the inspecting team.
 - (4) Take corrective action on all discrepancies found during the Salvage Inspection. Inform the ISIC of corrective action prior to commencement of Fast Cruise.
- ad. (Submarines only) Ensure a copy of the salvage plan has been provided to the escort ship designated for Sea Trials. Coordinate communications and operational procedures with the escort ship to ensure the escort is fully informed of the submarine's condition and intentions.
- ae. (Submarines only) Concur with the Supervising Authority message that the material condition of the ship is satisfactory to commence Fast Cruise.

- af. (Submarines only) Upon successfully completing Fast Cruise and after having exercised his crew thoroughly and operated all machinery, equipment and systems to his satisfaction, concur in the Supervising Authority's message recommending commencement of Alpha Trials. Appendix B of this chapter provides an example of this message.
- ag. (Submarines only) Maintain Planned Maintenance Management Plan in accordance with reference (n). Ensure records are ready for the ISIC's audit conducted prior to Fast Cruise.

2.8.3 Trials and Inspections. PCO responsibilities are delineated in references (d) and (e).

2.8.4 Post Shakedown Availability. Specific responsibilities of the PCO during PSA are as follows:

- a. Determine, in conjunction with the Supervising Authority, the nature and extent of PSA Sea Trials. Prepare, in conjunction with the Supervising Authority, the Sea Trial Agenda, including the sequence and duration of each test. The Supervising Authority will submit it to the Navy Shipbuilding Program Manager and the ISIC/TYCOM representative for approval as described herein. Provide copies of the approved detailed schedule and agenda for underway trials to the local ISIC and, if appropriate, the escort ship and the TYCOM Embarked Representative. This schedule and agenda shall include:
 - (1) The minimum requirements shown in Volume I, Chapter 6, section 6.4 (Volume II, Part I, Chapter 3 for submarines) of this manual.
 - (2) A firm time scheduled for conducting all tests and trials showing their sequence and duration.
 - (3) General prerequisites for conducting each test. Detailed prerequisites should be itemized as part of individual test requirements.
 - (4) Responsibility for conducting each test (Industrial Activity or Ship's Force).
 - (5) Ship's Force support required for conducting each test.
 - (6) Provision for adequate crew rest time during Sea Trials. Six uninterrupted hours in each twenty-four hour period is a minimum for each crew member.
 - (7) (Submarines only) Provision for a minimum of six hours of uninterrupted ISE for crew training following the initial tightness dive and prior to the deep dive.
 - (8) Underway tests may be run during ISE and rest periods on a not-to-interfere basis. Specifically, tests which can be conducted underway under normal operating conditions without manning special watch stations that require extra military personnel may be scheduled during rest periods. Tests which will not interfere with Ship's Force drills and training exercises may be conducted during ISE periods.
- b. Prepare Dock Trial Agenda.
- c. Conduct one day Ship's Force Dock Trials in accordance with Volume II, Part I, Chapter 3 of this manual.
- d. Demonstrate the crew's state of training.
- e. Ensure that all pertinent alongside tests, inspections, and trials are conducted.
- f. (Nuclear Powered Ships only) Supervise operation of the nuclear propulsion plant. Conduct critical operations as set forth in reference (l).
- g. (Nuclear Powered Ships only) When authorized by the TYCOM, conduct Fast Cruise in accordance with Volume II, Part I, Chapter 3 of this manual.
- h. (Nuclear Powered Ships only) Review the findings of the Pre-Critical Inspection (if performed) and adjust the training plan to ensure the crew's readiness for criticality. Advise the ISIC of training plan adjustments and provide an assessment of the crew's progress.
- i. (Nuclear Powered Ships only) Maintain Reactor Plant Maintenance in accordance with reference (k). Ensure records are ready for an ISIC audit conducted prior to Fast Cruise.

- j. (Submarines only) Undergo a salvage inspection in accordance with Volume IV, Chapter 18 of this manual.
- k. (Submarines only) Maintain Planned Maintenance Management Plan in accordance with reference (n) and **Scope of Certification/FBW Controlled Work Packages/SUBSAFE Re-entry Control** in accordance with Volume V, Part I, Chapter 5 of this manual. Ensure records are ready for an ISIC audit prior to Fast Cruise.
- l. (Submarines only) Additional PCO/CO responsibilities are defined in Volume II, Part I, Chapter 3 of this manual.

2.9 **PRE-COMMISSIONING UNIT.** The PCO and crew will monitor the ship's construction, prepare ship's directives, regulations and administrative programs, and observe and/or demonstrate the operation of installed systems to ensure the ship is safe and habitable prior to commissioning. The shipyard period is an opportunity for the crew to familiarize themselves with the ship. The ship will be required to complete various certifications leading up to introduction into the fleet. This section provides some insight into the administrative requirements and personnel related issues associated with the initial man-up.

2.9.1 **Initial Man-up.** New construction ships are manned based on a Crew Scheduling and Phasing Plan. Dependent upon the platform type, crew manning is accomplished in two, three, four or as many as eight increments. The quantitative and qualitative requirements of these increments are based on the platform type, test and construction schedule. The objectives of the Crew Scheduling and Phasing Plan are to:

- a. Ensure adequacy of schooling for personnel assigned.
- b. Ensure appropriate course convening dates.
- c. Ensure there are no conflicts/redundancies between Navy and contractor courses.
- d. Ensure sufficient training for anticipated maintenance and operating skill requirements.
- e. Ensure the optimization of training opportunities for personnel in the pipeline en route to the ship. A senior crew member from the first increment shall be assigned with the responsibility of tracking and reviewing manning issues. For some ships, the Navy Shipbuilding Program Manager has provided support contractors to assist either partially or entirely in the management of the Crew Scheduling and Phasing Plan. Regardless of the class or type of ship, the initial increment of personnel must quickly organize. If a detachment concept is used, Appendix P of this chapter provides a basic listing of requirements that the first increment of personnel should be pursuing. Appendix Q of this chapter provides similar information for the non-detachment approach.

2.9.2 **Training.**

2.9.2.1 **Shipboard Training.** The Industrial Activity presents a unique environment with special circumstances not routinely encountered by operating forces. The incremental assignment of personnel to PCUs and the pace of new construction demands a comprehensive training strategy. A well established training program is the key to the ship being ready for introduction into the Fleet. Consistent with the objectives of a shipboard training program, the TYCOM training manuals and references (j) and (o) through (t), a new construction training program will ensure that:

- a. (Nuclear Powered Ships only) The qualification of all Engineering/Reactor Department personnel in strict accordance with reference (u). Included is the CO's responsibility to personally conduct an RSE of each key propulsion plant watchstander.
- b. Personnel are trained in any special Quality Assurance (QA) procedures that may be used during the construction period.
- c. Personnel assigned are knowledgeable of the platform, system and equipment installations and operation of installed equipment.
- d. Watchstander qualifications support a watch section of fully or provisionally qualified personnel for all scheduled events.
- e. Training designated for assigned personnel supports the platform/equipment configuration.

- f. Intensified special training is provided to support:
 - (1) Cold Operations.
 - (2) Hot Operations.
 - (3) RSE.
 - (4) LOA.
 - (5) Criticality/Power Range Testing.
 - (6) Combat Systems Installation Certification.
 - (7) Crew Certification.
 - (8) Fast Cruise and Sea Trials.
 - (9) Piloting Party/Navigation Detail.
 - (10) Damage Control Team.
 - (11) Fire Fighting Team.
 - (12) Tactical Team.
 - (13) Special details.
- g. All billets requiring specific Navy Enlisted Classifications are filled.
- h. Established Naval Schools and Trainers are used to the maximum extent possible.
- i. Factory training on systems/equipment for which Naval Schools are not established is provided.
- j. Special training in accordance with TYCOM directives is provided for provisional certification to load, handle, stow and maintain a weapons load-out specific to the class of ship.
- k. Weapons/Combat Systems training is sufficient to enable the Weapons/Combat Systems Department to operate its systems while complying with existing safety rules, technical directives and governing operating procedures promulgated by the CNO, the Defense Nuclear Agency, NAVSEA, Space and Naval Warfare Systems Command, the TYCOM or other commands as applicable.
- l. Industrial Activity/contractor familiarization training courses are monitored for content and value. Provide supplemental instruction where necessary and inform the Supervising Authority and Navy Shipbuilding Program Manager of significant problems or shortfalls.
- m. The enlisted training program is started as soon as the Leading Petty Officers for the major divisions arrive. The Officers and senior enlisted personnel will develop the content and scope of the training programs for implementation with the arrival of the first large increment of enlisted personnel.
- n. Aircraft Launch and Recovery Equipment Maintenance Program training shall be conducted in accordance with reference (v).

2.9.2.2 Industrial Activity Training. The Industrial Activity/FIT will provide familiarization training in accordance with the shipbuilding contract on ship's characteristics and systems. This training generally is not sufficient for "System Expert" qualification, but will provide an excellent opportunity for School of the Boat/Ship, and at the same time provide an opportunity for Divisional Training Petty Officers to develop a more detailed and in depth training program. In most cases the Industrial Activity will allow the ship to control the scheduling of topics.

2.9.2.3 Training Support Center. Surface ships utilizing the Pre-Commissioning Detachment Concept at a Training Support Center (TSC), either in Norfolk, VA or San Diego, CA, are provided with an outstanding opportunity to ensure pipeline training is obtained. This concept also provides for the easy access to many of the basic courses such as firefighting, damage control, Repair Parts Petty Officer training, Drug and Alcohol Program Advisors, Component Change Control, etc., which are needed to ensure assigned personnel can effectively function as a ship's crew upon delivery. For ships not utilizing the TSC Detachment Concept, such as submarines, an individual should be assigned to monitor and track training and manning issues as they develop.

2.9.3 Ship's Qualification Program. The implementation and operation of the Ship's Qualification/Personnel Qualification Standard (PQS) should ensure a logical process for training Ship's Force for watchstanding and ship's qualification. TYCOM instructions that cover Ship's Qualification/PQS requirements are found in references (j) and (o) through (t). The department organization manual should establish prerequisites for watchstander qualification. Qualification goals should be established and the program should support completion of goals within each division. Fleet wide training and qualification goals are:

- a. Underway Watchbills; 3 Section Enlisted, 4 Section Officer/Chief Petty Officer.
- b. Inport Watchbills; 4 Section Enlisted, 5 Section Officer/Chief Petty Officer (6 Section for all personnel on Aircraft Carriers).

2.9.4 Deficiency Identification and Correction. The establishment of procedures by which Ship's Force reports and tracks the correction of deficiencies cannot be overstressed. The Supervising Authority relies heavily upon PCU involvement to augment their efforts. Inspections of systems, equipment and spaces by PCU personnel are extremely important in the identification of unsatisfactory work and/or material deficiencies. Each shipbuilder and associated Supervising Authority have their own established system for tracking shipbuilder responsible deficiencies. Those deficiencies which are not corrected during the construction cycle will be submitted to the INSURV Board just prior to FCT, AT or CT (the type of trial dependent on platform). These deficiencies, depending on their seriousness, may impact a ship's delivery to the Navy. Deficiencies cited must either be resolved/corrected or waived by the Navy Shipbuilding Program Manager.

2.9.5 Establishment of Engineering/Reactor Department. This paragraph addresses the Engineering/Reactor Department establishment and tasks which are to be accomplished during the pre-commissioning phase of new construction. The tasks defined in this section incorporate experience gained and lessons learned from previously completed ships. The objective is to provide guidance which will assist in the ship's readiness, from an Engineering/Reactor Department standpoint, to successfully complete contract milestones and to prepare for fleet introduction.

2.9.5.1 Requirements. The PCU should monitor and report on the ship's construction progress to the PCO, and dependent upon platform, conduct and/or witness and participate in the ship's dockside and at-sea testing, attend periodic documentation reviews, assessments, and validations, and provide recommendations regarding manpower, training, watchstanding and related shipboard engineering requirements. Tasks and responsibilities include items discussed in the following paragraphs.

2.9.5.2 Shipboard Inspections. Shipboard inspections by the ship's Engineering/Reactor Department and cognizant Supervising Authority personnel are necessary during the ship construction phase. There is no precise pattern or timetable for these inspections, but they should be thorough and conducted frequently. Ship's Force personnel need to become familiar with the contract specifications and system drawings. This will ensure the prompt identification, and documenting, of discrepancies discovered when comparing "as built" conditions to the actual specification.

2.9.5.3 Personnel Qualification Standards. Theoretical portions of PQS should be implemented during the training pipeline at the specific Training Centers and at the TSCs using available technical manuals and training material. Ship-wide PQS should be implemented prior to the arrival of the final crew increment at the shipbuilder's yard. The ship's Engineer Officer should establish interim watch qualifications to set the training goals for Engineering/Reactor Department personnel as they arrive at the Industrial Activity. Additionally, PQS sign-off authority should be specified in writing by the ship's Engineer Officer, in order to ensure that the provisional qualifications and sign-off procedures function smoothly.

2.9.5.4 Outfitting Support (as applicable). The PCU must ensure that engineering spaces are completely outfitted. Routine progress inspections must be made in this area, and the PCU will participate in completing Compartment Completion Inspection Reports. It is important that personnel involved with Compartment Completion Inspection Reports are fully aware of all implemented Engineering Change Proposals and Engineering Change Notices to ascertain that outfitting materials and Operating Space Items (OSI) support the ship as revised by Engineering Change Proposals and Engineering Change Notices. Configuration Change Requests must be drafted with full recognition of the guidance contained in both the General Specifications for Building Naval Vessels and the specific Class Building Specifications.

2.9.5.5 Operational Sequencing System (Surface Force Ships/Aircraft Carriers only). The Operational Sequencing Systems (OSS) (Engineering Operational Sequencing System (EOSS), Sewage Disposal Operational Sequencing System, etc.) establish the operational procedures for various shipboard equipment, including applicable Casualty Control procedures. Validation of Engineering Department OSS manuals is the responsibility of the ship's Engineering Department personnel, with assistance provided by the Navy Shipbuilding Program Manager and contractor support personnel (if available). This validation will ensure that procedural requirements are current, well-defined and correct. OSS validation is a Key Event that must be accomplished by the PCU prior to arrival of the final crew increment. EOSS installation (under the cognizance of Naval Surface Warfare Center Carderock Division (NSWCCD)) involves the following sequence of events, which may be modified for other OSS installations:

- a. Develop the preliminary EOSS package.
- b. Submit the preliminary EOSS to the PCU, the Supervising Authority and the Navy Shipbuilding Program Manager.
- c. The PCU, the Supervising Authority and the Navy Shipbuilding Program Manager review the preliminary EOSS.
- d. Conduct cold plant check to validate equipment for correct system operation.
- e. Revise EOSS to pre-hot check package and submit EOSS to the PCU, the Supervising Authority and the Navy Shipbuilding Program Manager.
- f. Conduct pre-hot check.
- g. Conduct hot system ship check.
- h. Submit final EOSS to the PCU, the Supervising Authority and the Navy Shipbuilding Program Manager for review/comment.
- i. Deliver electronic copy of EOSS to Navy Shipbuilding Program Manager.
- j. Print, laminate, assemble EOSS.
- k. Install final EOSS.

2.9.5.6 Engineering/Reactor Department Organization and Regulations Manual. The Engineering/Reactor Department Organization and Regulations Manual (EDORM/RDORM) is the responsibility of the ship's Engineer/Reactor Officer, however, basic EDORM/RDORMs have been established as guidelines. Reference (w) provides EDORM development guidance for Surface Forces, reference (x) provides guidance for submarines, and reference (u) provides EDORM/RDORM development guidance for aircraft carriers.

2.10 SUPPORT ACTIVITIES.

2.10.1 Technical Support. The Regional Maintenance Centers (RMC) have numerous functions and responsibilities, some of which will further be discussed in Volume I, Chapter 3 of this manual, but for the purpose of this section only those functions and responsibilities related to new construction will be discussed.

2.10.1.1 Naval Sea Logistics Center (Detachment Norfolk/San Diego).

- a. TYCOMs are responsible for ensuring the proper installation and operation of PMS within the ships under their command. The importance of the PMS installation cannot be overemphasized.
- b. Prior to the PMS installation, equipment configuration information will be verified by the Configuration Data Manager. The PMS Maintenance Index Page/MRC documentation will be certified by the Naval Sea Logistics Center Detachment Norfolk/San Diego (NAVSEALOGCEN Detachment Norfolk/San Diego), as appropriate. Following the validation, the applicable NAVSEALOGCEN Detachment Norfolk/San Diego will assemble the PMS documentation, equipment listings, schedules and forms required for the installation package. Each PMS installation package is ship tailored.
- c. NAVSEALOGCEN Detachment Norfolk/San Diego has the responsibility for installing PMS aboard ship. The installation of PMS is done in two phases; preliminary and final.
- d. Supporting information can be found in reference (g).

2.10.2 Submarine Maintenance Engineering, Planning and Procurement Activity. The SUBMEPP Activity is located in Portsmouth, NH. SUBMEPP functions are related to submarines and selected submarine support activities. As was the case with the RMCs, SUBMEPP's functions are numerous and deal with a submarine's maintenance at all levels of accomplishment (Organizational, Intermediate, Depot) from construction to inactivation. For the purpose of this section SUBMEPP's responsibilities and functions include:

- a. Tracking the configuration of ships under construction.
- b. Assisting local RMC with the PMS installation on all new construction submarines.
- c. Assisting the Supervisor of Shipbuilding, Groton with the resolution of INSURV deficiencies concerning PMS related issues.
- d. Providing Ship's Force with a Master Equipment Guide List (EGL) for all non-nuclear/non-missile related equipment (component to MRC).
- e. Providing Ship's Force with their URO and Maintenance Standard documentation at PMS installation.
- f. Providing Maintenance and Material Management Coordinator Training at SUBMEPP concerning VIRGINIA and SEAWOLF Maintenance philosophy.
- g. Processing all shipbuilder developed Submarine PMS to the In-Service Engineering Activity for review and approval.

2.10.3 Carrier Planning Activity, PMS312C (Aircraft Carriers only). The Carrier Planning Activity (CPA) provides centralized Aircraft Carrier life-cycle management, maintenance and modernization planning, closely aligned to Fleet and Program Executive Officer Aircraft Carriers needs and priorities. Operationally, CPA reports to the Navy Shipbuilding Program Manager, In-Service Aircraft Carriers (PMS 312). In accordance with NAVSEAINST 5400.130, CPA responsibilities are as follows:

- a. Development, maintenance and monitoring of the Carrier Incremental Maintenance Plan (IMP), including tracking the backlog of IMP and modernization work.
- b. Developing Carrier Baseline Availability Work Packages (BAWP) including integration of the IMP sequencing plan and the Modernization Plan for presentation to the TYCOMs.
- c. Capturing and analyzing maintenance data history for use in updating the IMP Sequencing Plan and supporting the TYCOMs in assessing the value of ongoing material assessments.
- d. Supporting the TYCOMs and Executing Activities in the development of continuous maintenance requirements including life cycle input from the IMP to the continuous maintenance process.

2.10.4 Surface Maintenance Engineering Planning Program (Surface Force Ships only). Surface Maintenance Engineering Planning Program (SURFMEPP) shall provide centralized surface ship lifecycle maintenance engineering, class maintenance planning and management closely aligned to the Surface TYCOM and NAVSEA needs and priorities in accordance with reference (y). For the purpose of this section, SURFMEPP's responsibilities and functions include:

- a. Serve as the authorized engineering agent for Surface Ship Lifecycle maintenance engineering, planning and management.
- b. Act as the surface ship Class Maintenance Program development and management activity.
- c. Capture and analyze maintenance data history, to include cost, for use in updating the Class Maintenance Plan.
- d. Review the material assessments in order to modify the technical content of the Class Maintenance Plan.
- c. Develop and issue BAWPs for CNO availabilities after PSA.

2.10.5 Space and Naval Warfare Systems Centers.

- a. Space and Naval Warfare Systems Center Atlantic (SSC Atlantic) designs, develops, implements and provides life cycle support for standard fleet non-tactical automated information systems, afloat and ashore. SSC Atlantic is the software development and support activity for applications automated under the Naval Tactical Command Support System and remaining legacy systems. The Naval Tactical Command Support System automates supply, inventory, ship/submarine/aviation maintenance and configuration management; food services, retail operations, personnel administration and watch, quarter, and station bills, for fleet and fleet-like activities. In all, SSC Atlantic's customers number over 1200 separate activities, many of which operate with multiple functional systems.
- b. SSC Atlantic Tidewater facilities, located on Naval Station Norfolk, VA, manage all software development. Naval Station Norfolk is also home to SSC Atlantic's In-Service Engineering Activity for hardware and software support, along with Atlantic Fleet implementations. Space and Naval Warfare Systems Center Pacific (SSC Pacific), San Diego, CA is responsible for Pacific Fleet implementations and support. SSC Pacific maintains a detachment in Yokosuka, Japan to provide on-site assistance for commands and units deployed to their Area of Responsibility.

2.10.6 Fleet Introduction Team (Surface Forces only). Reference (z) states that for newly commissioned Commander Naval Surface Force Atlantic (COMNAVSURFLANT) ships, COMNAVSURFLANT assumes the responsibility of instituting and managing a fleet introduction program. FITs provide support to pre-commissioning crews by monitoring the progress of construction, coordinating training, providing continuity in the management and administration of facilities at the building site and providing administrative support. The Navy Shipbuilding Program Manager provides this support in the form of support contractors. The specific responsibilities of individual FITs will vary dependent upon the platform and the requirements peculiar to that platform. Appendix R of this chapter provides a generic base line of services available if a FIT is established.

2.10.7 Afloat Training Group (Surface Force Ships only). The ATG is chartered by reference (w) to assist ships in tailoring a training program for the conduct of pre-light-off cold checks and evaluations, program management and fire fighting. This assistance is rendered through formal visits, scheduled at the request of the ship's ISIC via the quarterly scheduling process. ATG teams will conduct tailored training, defined in consonance with the CO, the ISIC and the team OIC which best meets the needs of the ship.

2.10.8 Surface Nuclear Propulsion Mobile Training Team (Aircraft Carriers only). The Surface Nuclear Propulsion Mobile Training Team will conduct training and assessment of Reactor Departments (to include Engineering department on CVN 65) for ships undergoing extended availabilities and for PCUs. These assessments shall include Reactor Department administration, qualifications, operations, cleanliness, preservation, material condition, radiological controls, chemistry controls and damage control. The Maintenance Training Group will conduct preavailability training with Reactor Department personnel, conduct in process quality assurance assessments and training visits, and train the crew in life cycle management.

2.10.9 Fitting Out Supply Assistance Team (Surface Ships only).

- a. Fitting Out Supply Assistance Team (FOSAT), a function under Naval Supply Weapons Systems Support-Mechanicsburg, will assist Prospective Supply Officers (PSO) in attaining maximum administrative and material readiness of the Supply Department prior to delivery of a ship to the Navy. The team is involved in monitoring the provisioning process, material availability, inventory validity, Supply Department administrative readiness and establishment of Supply Department spaces. Additionally, the team provides pre-commissioning training and assistance in all areas of Supply Department organization. The primary focus of the FOSAT team is to provide assistance and evaluation. Assistance is rendered to the PSO through training and as a result of each of the PSO's divisions communicating their areas requiring assistance. Evaluation is accomplished by reviewing each division's operating procedures. Evaluation is also accomplished through regular communication to ascertain each division's progress based upon the most current Supply Management Certification checklist. In addition, assistance and evaluation are accomplished by performing visits to the PCUs.
- b. Services provided by FOSAT includes:
 - (1) Storeroom Bin Validation.

- (2) Review of General Use Consumable List.
- (3) RSUPPLY Implementation and Validation.
- (4) Culinary Specialist Assistance.
- (5) Ship's Serviceman Assistance.
- (6) Disbursing Assistance.
- (7) Postal Assistance.
- (8) Critical Path Visits.

2.11 NAVAL SEA SYSTEMS COMMAND (SUBMARINES ONLY). Reference (c) describes NAVSEA's responsibilities during new construction for Submarine FBW SCS. The following is a synopsis of those functions with additional amplification:

2.11.1 Pre-Commissioning. NAVSEA's responsibilities for the Pre-Commissioning period are as follows:

- a. (Applicable Submarines only) Supervising Authority sends message to NAVSEA in advance of the scheduled start of Fast Cruise stating the status of all incomplete NAVSEA FBW SCS Certification Audit Category IA recommendations, that all FBW SCS work necessary for sea trials, including resolution of all NAVSEA FBW SCS Certification Audit Category I recommendations, has been completed and that the FBW SCS is ready for commencement of Fast Cruise. The message shall also state that there are no conditional FBW SCS Deviations or Waivers which have not been satisfied or cite those that exist, identify any operating restrictions of the ship and/or system, and that, subject to satisfactory completion of Fast Cruise and resolution of mandatory deficiencies, the FBW SCS is satisfactory for commencement of Alpha Sea Trials. Appendix S of this chapter provides a sample message.
- b. (Applicable Submarines only) NAVSEA Navy Shipbuilding Program Manager message to TYCOM certifying that the submarine FBW SCS is satisfactory for sea trials in accordance with the approved Sea Trial Agenda. The message shall also state that there are no conditional FBW SCS Deviations or Waivers which have not been satisfied or cite those that exist, identify any operating restrictions of the ship and/or system, and that, subject to satisfactory completion of Fast Cruise and resolution of mandatory deficiencies, the FBW SCS is satisfactory for commencement of Alpha Sea Trials. Appendix T of this chapter provides a sample message.
- c. (Applicable Submarines only) NAVSEA Navy Shipbuilding Program Manager shall provide a report documenting the resolution of sea trial deficiencies to NAVSEA 07TC for review in support of NAVSEA 07 concurrence on final system certification. Appendix U of this chapter provides a sample message.

2.12 INTEGRATION OF CLASS MAINTENANCE PLAN AND BASELINE AVAILABILITY WORK PACKAGE (SURFACE FORCE SHIPS ONLY).

- a. SURFMEPP has lead responsibility for BAWP development for new construction ships entering the Fleet Readiness Plan (FRP) cycle.
- b. Initial BAWP generation for new construction ships is dependent on PSA completion and Class Maintenance Plan development. Once the BAWP is issued, see Volume II, Part II, Chapter 2, Appendix D of this manual for the remaining BAWP to Availability Work Package (AWP) process.

2.12.1 Life Cycle Planning Conference. SURFMEPP will coordinate the date, location and agenda for the Life Cycle Planning Conference (LCPC). SURFMEPP will be responsible for planning and conducting the conference, attendees should include: TYCOM, RMC Assessment Directors, Program Manager Representatives, representatives from NAVSEA 05, NAVSEA 21 Modernization, Planning Activity and the ship's MT.

2.12.2 BAWP Pre-Pushed to Maintenance Team. SURFMEPP will send a list of the FRP Maintenance Cycle Class Maintenance Plan requirements to the ship's Port Engineer for review and correction. This list is a preview of the initial BAWP and will be discussed in detail at the LCPC. Upon request, SURFMEPP will provide a list of Class Maintenance Plan-required assessments to TYCOM, Navy Regional Maintenance Center (NRMC) and RMC.

2.12.3 BAWP Upload.

- a. SURFMEPP will upload a data file (MM0001 file) with all mandatory requirements and expected CNO Availability services into the appropriate IT system in support of ship-specific MT screening and brokering requirements.
- b. SURFMEPP will issue formal correspondence detailing the planning schedule and outstanding action items from the LCPC.

2.12.4 Other BAWP to AWP Process Milestones. All other BAWP to AWP process milestones are germane (refer to Volume II of this manual) for in-service non-Forward Deployed Naval Forces ships.

APPENDIX A

Message Scenario and Sample Messages/Letters
For Habitability Inspections and In-Service

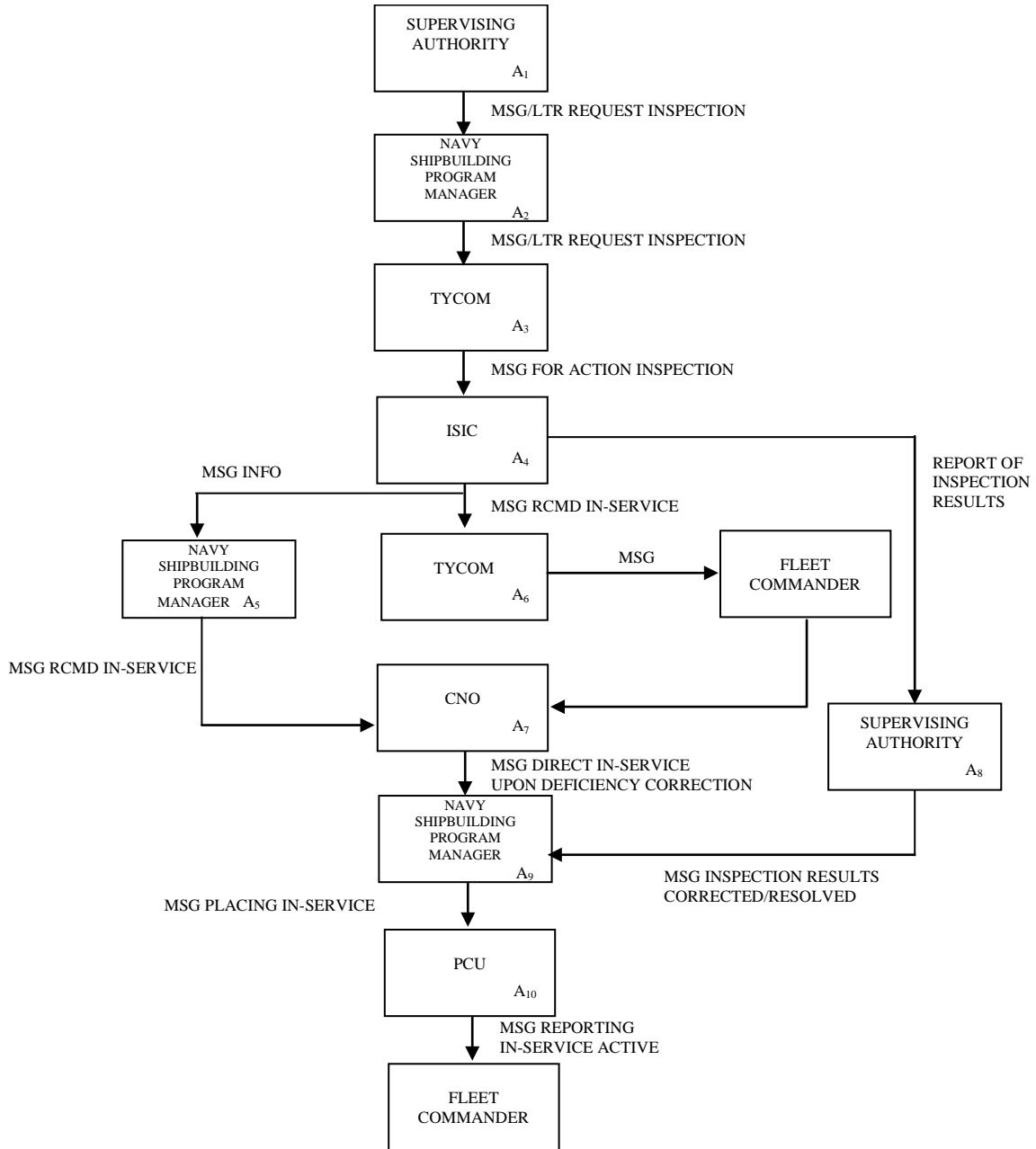

APPENDIX A₁

**SAMPLE SUPERVISING AUTHORITY LETTER TO NAVY SHIPBUILDING PROGRAM MANAGER
RECOMMENDING HABITABILITY INSPECTION AND IN-SERVICE**

From: Supervisor of Shipbuilding, Conversion and Repair, USN, (Applicable Supervising Authority)

To: Commander, Naval Sea Systems Command (Attn: Navy Shipbuilding Program Manager)

Subj: PLACING (SHIP NAME) (HULL NUMBER) IN-SERVICE

Ref: (a) OPNAVINST 9080.3
(b) OPNAVINST 4700.8

1. In accordance with references (a) and (b), recommend Habitability Inspection of (Ship Name) (Hull Number) commence on (Date) with active status of In-Service on or about (Date).

Program Department Head

Copy to: (As Applicable)
CNO Washington (N77)
DIRSSP Washington (SP201)
TYCOM
ISIC
Parent ISIC
PRECOMUNIT (Ship Name)
NRRO (Location)

APPENDIX A₂

**SAMPLE NAVY SHIPBUILDING PROGRAM MANAGER LETTER REQUESTING TYCOM TO
AUTHORIZE ISIC TO CONDUCT HABITABILITY INSPECTION**

From: Commander, Naval Sea Systems Command

To: Commander, (Applicable TYCOM N43)

Subj: PLACING (SHIP NAME) (HULL NUMBER) IN-SERVICE

Ref: (a) OPNAVINST 9080.3
(b) OPNAVINST 4700.8
(c) Supervising Authority ltr recommending In-Service of specified unit

1. In accordance with references (a) and (b), (Applicable TYCOM) (N4) is requested to authorize a Habitability Inspection of (Ship Name) (Hull Number) commencing on (Date) as recommended by reference (c).

Navy Shipbuilding Program Manager

Copy to: (As Applicable)
CNO Washington DC (N77)
DIRSSP Washington DC (SP201)
ISIC
Parent ISIC
PRECOMUNIT (Ship Name)
Supervising Authority
NRRO (Location)

APPENDIX A₃

**SAMPLE TYCOM MESSAGE DIRECTING ISIC TO CONDUCT
HABITABILITY INSPECTION**

FM (TYCOM)//
TO (ISIC)//
INFO CNO WASHINGTON DC//
(FLEET COMMANDER)//
COMNAVSEASYSKOM WASHINGTON DC//(NAVY SHIPBUILDING PROGRAM MANAGER)/(NUCLEAR POWERED
SHIPS ONLY)//
PRECOMUNIT (SHIP NAME)//
(SUPERVISING AUTHORITY)/(APPROPRIATE CODE)//
(PARENT GROUP)//
(PARENT SQUADRON)//
BT
UNCLAS //N04700//
MSGID/GENADMIN/(TYCOM)//
SUBJ/PLACING (SHIP NAME AND HULL NO.) IN-SERVICE//
REF/A/LTR/(ORIGINATING ACTIVITY) (SERIAL NUMBER)/(DATE)//
AMPN/REF A IS NAVY SHIPBUILDING PROGRAM MANAGER REQUEST FOR HABITABILITY
INSPECTION//
RMKS/1. TAKE REF A FORAC. CONDUCT HABITABILITY INSPECTION OF (SHIP NAME AND HULL NO.) ON
OR ABOUT (DATE).
2. REPORT RESULTS BY MSG UPON COMPLETION.//
BT

**NOTE: ENSURE MESSAGES ARE IN ACCORDANCE WITH CURRENT MESSAGE FORMAT AND
CURRENT PLAIN LANGUAGE ADDRESS DIRECTORY (PLAD) IS UTILIZED.**

APPENDIX A₄SAMPLE ISIC MESSAGE REPORTING COMPLETION OF HABITABILITY
INSPECTION AND RECOMMENDING SHIP BE PLACED "IN-SERVICE"

FM (ISIC)//
 TO (TYCOM)//
 INFO CNO WASHINGTON DC//
 COMNAVSEASYS COM WASHINGTON DC// (NAVY SHIPBUILDING PROGRAM MANAGER)/ (NUCLEAR POWERED
 SHIPS ONLY)//
 (FLEET COMMANDER)//
 (PARENT GROUP)//
 (PARENT SQUADRON)//
 PRECOMUNIT (SHIP NAME)//
 (SUPERVISING AUTHORITY)// (APPROPRIATE CODE)//
 (TYCOM) REP (SUPERVISING AUTHORITY)//
 BT
 UNCLAS //N05441//
 MSGID/GENADMIN/(ISIC)//
 SUBJ/ PLACING (SHIP NAME AND HULL NO.) IN-SERVICE//
 REF/A/LTR/(ORIGINATING ACTIVITY) (SERIAL NUMBER)/(DATE)//
 AMPN/REF A IS NAVY SHIPBUILDING PROGRAM MANAGER REQUEST FOR HABITABILITY
 INSPECTION//
 REF/B/MSG/(ORIGINATOR)/(DTG)//
 AMPN/REF B IS TYCOM AUTHORIZATION TO CONDUCT HABITABILITY INSPECTION//
 REF/C/DOC/OPNAVINST 3120.32//
 AMPN/REF C IS US NAVY REGULATIONS//
 REF/D/DOC/OPNAVINST 4700.8//
 AMPN/REF D IS TRIALS, ACCEPTANCE, COMMISSIONING, FITTING OUT, SHAKEDOWN, AND POST-
 SHAKEDOWN AVAILABILITY OF U.S. NAVAL SHIPS UNDERGOING CONSTRUCTION OR
 CONVERSION//
 REF/E/DOC/OPNAVINST 9080.3//
 AMPN/REF E IS PROCEDURES FOR TESTS AND TRIALS OF NAVAL NUCLEAR POWERED SHIPS
 UNDER CONSTRUCTION, MODERNIZATION, CONVERSION, REFUELING, AND OVERHAUL//
 REF/F/DOC/(SUPERVISING AUTHORITY)INST 5441.1/-/NOTAL//
 AMPN/REF F IS SUPERVISING AUTHORITY INSTRUCTION CONCERNING HABITABILITY AND IN-
 SERVICE//
 RMKS/1. IAW REFS A AND B (ISIC) COMPLETED HABITABILITY INSPECTION OF (SHIP NAME AND HULL
 NO.) ON (DATE).
 2. INSPECTION CONDUCTED IAW REFS C, D, AND E, USING REF F FOR GUIDANCE. LIST OF
 DEFICIENCIES PROVIDED TO (SUPERVISING AUTHORITY) AND PRECOMUNIT (SHIP NAME).
 3. RECOMMEND (SHIP NAME) BE PLACED "IN-SERVICE" UPON CORRECTION OR RESOLUTION OF
 HIGHLIGHTED MINOR DEFICIENCIES. NO MAJOR DEFICIENCIES EXIST.
 4. THE FOLLOWING SYSTEMS ARE NOT UNDER OPERATIONAL CONTROL OF SHIP'S FORCE:
 SYSTEM EDD
 5. THE FOLLOWING SPACES HAVE SIGNIFICANT WORK IN PROGRESS AND ARE NOT TURNED OVER
 TO SHIP'S FORCE:
 SPACE
 A.
 B.
 C.//
 BT

**NOTE: ENSURE MESSAGES ARE IN ACCORDANCE WITH CURRENT MESSAGE FORMAT AND
CURRENT PLAD IS UTILIZED.**

APPENDIX A₅

**SAMPLE NAVY SHIPBUILDING PROGRAM MANAGER TO CNO MESSAGE RECOMMENDINGSHIP
BE PLACED IN-SERVICE**

FM COMNAVSEASYS COM WASHINGTON DC// (NAVY SHIPBUILDING PROGRAM MANAGER)//
TO CNO WASHINGTON DC//
INFO (FLEET COMMANDER)//
(TYCOM)//
(ISIC)//
(PARENT GROUP)//
(PARENT SQUADRON)//
PRECOMUNIT (SHIP NAME)//
(SUPERVISING AUTHORITY)// (APPROPRIATE CODE)//
BT
UNCLAS //N05441//
MSGID/GENADMIN// (NAVY SHIPBUILDING PROGRAM MANAGER)//
SUBJ/ PLACING (SHIP NAME AND HULL NO.) IN-SERVICE//
REF/A/MSG// (ISIC)// (DTG)//
AMPN/REF A IS SHIP'S MESSAGE TO TYCOM CONCERNING MATERIAL CERTIFICATION//
REF/B/DOC/OPNAVINST 9080.3//
AMPN/REF B IS PROCEDURES FOR TESTS AND TRIALS OF NAVAL NUCLEAR POWERED SHIPS
UNDER CONSTRUCTION, MODERNIZATION, CONVERSION, REFUELING AND OVERHAUL//
REF/C/DOC/OPNAVINST 4700.8//
AMPN/REF C IS TRIALS, ACCEPTANCE, COMMISSIONING, FITTING OUT, SHAKEDOWN, AND POST
SHAKEDOWN AVAILABILITY OF U.S. NAVAL SHIPS UNDERGOING CONSTRUCTION OR
CONVERSION//
RMKS/1. REF A PROVIDED RESULTS OF HABITABILITY INSPECTION OF (SHIP NAME AND HULL NO.).
2. IAW REFS B AND C, (THE NAVY SHIPBUILDING PROGRAM MANAGER) RECOMMENDS PLACING (SHIP NAME
AND HULL NO.) IN-SERVICE UPON CORRECTION OR RESOLUTION OF MANDATORY DEFICIENCIES
IDENTIFIED BY THE ISIC HABITABILITY INSPECTION REPORT. CORRECTION OR RESOLUTION OF
THESE DEFICIENCIES IS EXPECTED TO COMPLETE ON OR ABOUT (DATE).//
BT

**NOTE: ENSURE MESSAGES ARE IN ACCORDANCE WITH CURRENT MESSAGE FORMAT AND
CURRENT PLAD IS UTILIZED.**

APPENDIX A₆

**SAMPLE TYCOM MESSAGE RECOMMENDING SHIP BE PLACED
"IN-SERVICE ACTIVE"**

FM (TYCOM)//
TO CNO WASHINGTON DC//
INFO (FLEET COMMANDER)//
COMNAVSEASYS COM WASHINGTON DC// (NAVY SHIPBUILDING PROGRAM MANAGER)/ (NUCLEAR POWERED
SHIPS ONLY)//
(PARENT GROUP)//
(PARENT SQUADRON)//
(SUPERVISING AUTHORITY)// (APPROPRIATE CODE)//
(ISIC)//
PRECOMUNIT (SHIP NAME)//
BT
UNCLAS //N05441//
MSGID/GENADMIN/(TYCOM)//
SUBJ/ (SHIP NAME AND HULL NO.) IN-SERVICE ACTIVE//
REF/A/MSG/(ORIGINATING ACTIVITY)/(DTG)//
AMPN/REF A IS ISIC REPORT OF HABITABILITY INSPECTION COMPLETION//
REF/B/TEL/(TYCOM)/(DATE)//
AMPN/REF B IS TELCON BETWEEN (TYCOM)/(NAME) AND (FLEET COMMANDER)/(NAME)//
RMKS/1. CONCUR WITH REF A RECOMMENDATION TO PLACE (SHIP NAME) IN-SERVICE ACTIVE
UPON CORRECTION/RESOLUTION OF DEFICIENCIES.
2. (FLEET COMMANDER) CONCURRENCE OBTAINED REF B.//
BT

**NOTE: ENSURE MESSAGES ARE IN ACCORDANCE WITH CURRENT MESSAGE FORMAT AND
CURRENT PLAD IS UTILIZED.**

APPENDIX A₇

**SAMPLE CNO TO NAVY SHIPBUILDING PROGRAM MANAGER MESSAGE
DIRECTING THE SHIP BE PLACED IN-SERVICE**

FM CNO WASHINGTON DC//
TO COMNAVSEASYS COM WASHINGTON DC//(NAVY SHIPBUILDING PROGRAM MANAGER)//
INFO (FLEET COMMANDER)//
(TYCOM)//
(PARENT GROUP)//
(PARENT SQUADRON)//
PRECOMUNIT (SHIP NAME)//
BT
UNCLAS //N05441//
MSGID/GENADMIN/CNO//
SUBJ/ PLACING (SHIP NAME AND HULL NO.) IN SERVICE//
REF/A/MSG/(ORIGINATING ACTIVITY)/(DTG)//
AMPN/REF A IS (ISIC) RECOMMENDATION TO PLACE (SHIP NAME) IN SERVICE//
REF/B/MSG/(ORIGINATING ACTIVITY)/(DTG)//
AMPN/REF B IS (TYCOM) RECOMMENDATION TO PLACE (SHIP NAME) IN SERVICE//
REF/C/MSG/(ORIGINATING ACTIVITY)/(DTG)//
AMPN/REF C IS (NAVSEA) RECOMMENDATION TO PLACE (SHIP NAME) IN SERVICE//
REF/D/DOC/OPNAVINST 4700.8//
AMPN/REF D IS TRIALS, ACCEPTANCE, COMMISSIONING, FITTING OUT, SHAKEDOWN, AND POST
SHAKEDOWN AVAILABILITY OF U.S. NAVAL SHIPS UNDERGOING CONSTRUCTION OR
CONVERSION//
RMKS/1. AS RECOMMENDED BY (ISIC)/(TYCOM)/(FLEET COMMANDER) PER REFS A AND B AND BY
NAVSEA PER REF C, UPON CORRECTION OR SATISFACTORY RESOLUTION OF DEFICIENCIES
DISCUSSED IN REF A, NAVSEA IS DIRECTED TO PLACE (SHIP NAME) IN SERVICE IAW REF D ON OR
ABOUT (DATE).//
BT

**NOTE: ENSURE MESSAGES ARE IN ACCORDANCE WITH CURRENT MESSAGE FORMAT
AND CURRENT PLAD IS UTILIZED.**

APPENDIX A₈

**SAMPLE SUPERVISING AUTHORITY TO NAVY SHIPBUILDING PROGRAM MANAGER MESSAGE
RECOMMENDING SHIP BE PLACED IN-SERVICE**

FM (SUPERVISING AUTHORITY)//
TO COMNAVSEASYS COM WASHINGTON DC//(NAVY SHIPBUILDING PROGRAM MANAGER)//
INFO CNO WASHINGTON DC//
(TYCOM)//
(ISIC)//
(PARENT GROUP)//
(PARENT SQUADRON)//
PRECOMUNIT (SHIP NAME)//
BT
UNCLAS //NO5441//
MSGID/GENADMIN/(SUPERVISING AUTHORITY)//
SUBJ/ (SHIP NAME AND HULL NO.) PLACING IN-SERVICE ACTIVE
REF/A/MSG/(ORIGINATING ACTIVITY)/(DTG)//
AMPN/REF A IS ISIC REPORT OF HABITABILITY INSPECTION COMPLETION//
REF/B/DOC/OPNAVINST 4700.8//
AMPN/REF B IS TRIALS, ACCEPTANCE, COMMISSIONING, FITTING OUT, SHAKEDOWN, AND
POST-SHAKEDOWN AVAILABILITY OF U.S. NAVAL SHIPS UNDERGOING CONSTRUCTION OR
CONVERSION//
REF/C/DOC/OPNAVINST 9080.3//
AMPN/REF C IS PROCEDURES FOR TESTS AND TRIALS OF NAVAL NUCLEAR POWERED SHIPS
UNDER CONSTRUCTION, MODERNIZATION, CONVERSION, REFUELING, AND OVERHAUL//
RMKS/1. ALL MANDATORY DISCREPANCIES IDENTIFIED DURING THE HABITABILITY INSPECTION
OF (SHIP NAME AND HULL NO.) AS REPORTED BY REF A HAVE BEEN CORRECTED OR RESOLVED
TO THE SATISFACTION OF THE PCO (SHIP NAME) AND THE (SUPERVISING AUTHORITY).
2. IAW REFS B AND C IT IS RECOMMENDED THAT (SHIP NAME AND HULL NO.) BE PLACED IN-
SERVICE ACTIVE ON (DATE).//
BT

**NOTE: ENSURE MESSAGES ARE IN ACCORDANCE WITH CURRENT MESSAGE FORMAT AND
CURRENT PLAD IS UTILIZED.**

APPENDIX A₉

**SAMPLE NAVY SHIPBUILDING PROGRAM MANAGER TO SHIP MESSAGE
DIRECTING SHIP BE PLACED IN-SERVICE**

FM COMNAVSEASYS COM WASHINGTON DC// (NAVY SHIPBUILDING PROGRAM MANAGER)//
TO PRECOMUNIT (SHIP NAME)//
INFO CNO WASHINGTON DC//
(FLEET COMMANDER)//
(TYCOM)//
(ISIC)//
(PARENT GROUP)//
(PARENT SQUADRON)//
(SUPERVISING AUTHORITY)// (APPROPRIATE CODE)//
BT
UNCLAS //N05441//
MSGID/GENADMIN// (NAVY SHIPBUILDING PROGRAM MANAGER)//
SUBJ/PLACING (SHIP NAME AND HULL NO.) IN-SERVICE ACTIVE//
REF/A/MSG// (ORIGINATING ACTIVITY)// (DTG)// NOTAL//
AMPN/REF A IS SUPERVISING AUTHORITY RECOMMENDATION TO PLACE SHIP IN-SERVICE//
REF/B/MSG/CNO// (DTG)// NOTAL//
AMPN/REF B IS CNO MESSAGE DIRECTING (NAVY SHIPBUILDING PROGRAM MANAGER) TO PLACE SHIP IN-SERVICE//
RMKS/1. REF A REPORTED ALL MANDATORY DEFICIENCIES IDENTIFIED DURING HABITABILITY INSPECTION OF (SHIP NAME AND HULL NO.) HAVE BEEN CORRECTED OR RESOLVED TO THE SATISFACTION OF THE PCO (SHIP NAME AND HULL NO.) AND THE (SUPERVISING AUTHORITY).
2. AS DIRECTED IN REF B, PLACE (SHIP NAME AND HULL NO.) IN-SERVICE, ACTIVE ON (DATE). MAKE ALL REQUIRED REPORTS. REPORT TO (FLEET COMMANDER) FOR OPCON.//
BT

NOTE: ENSURE MESSAGES ARE IN ACCORDANCE WITH CURRENT MESSAGE FORMAT AND CURRENT PLAD IS UTILIZED.

APPENDIX A₁₀

SAMPLE CO PRE-COMMISSIONING UNIT MESSAGE REPORTING "IN-SERVICE ACTIVE"

FM PRECOMUNIT (SHIP NAME)//
 TO (FLEET COMMANDER)//
 INFO COMNAVSEASYS COM WASHINGTON DC//(NAVY SHIPBUILDING PROGRAM MANAGER)/ (NUCLEAR
 POWERED SHIPS ONLY)//
 (TYCOM)//
 (ISIC)//
 (PARENT GROUP)//
 (PARENT SQUADRON)//
 (SUPERVISING AUTHORITY)//(APPROPRIATE CODE)//
 NVR NORFOLK VA (NAVAL VESSEL REGISTER)//
 BT
 UNCLAS //N05441//
 MSGID/GENADMIN/(SHIP NAME)//
 SUBJ/ (SHIP NAME AND HULL NO.) IN-SERVICE//
 REF/A/MSG/(ORIGINATING ACTIVITY)/(DTG)//
 AMPN/REF A IS NAVY SHIPBUILDING PROGRAM MANAGER DIRECTION TO PLACE SHIP IN-
 SERVICE//
 REF/B/DOC/COMNAVSUBFOR OPORD 2000/(DATE)//(SUBMARINES ONLY)
 AMPN/APPROPRIATE SECTION OF REF B IS APP 7 TO ANNEX C//
 RMKS/1. IAW REF A (SHIP NAME) IN-SERVICE ACTIVE (DTG).
 2. IAW REF B (SHIP NAME) REPORTING TO FLEET COMMANDER FOR OPCON.//(SUBMARINES ONLY)
 BT

NOTE: ENSURE MESSAGES ARE IN ACCORDANCE WITH CURRENT MESSAGE FORMAT AND CURRENT PLAD IS UTILIZED.

(This Page Intentionally Left Blank)

APPENDIX B

**Message Scenario and Sample Messages
For Fast Cruise and Alpha Sea Trial (Nuclear Powered Ships)
(For Submarines See Appendix B - SUBS)**

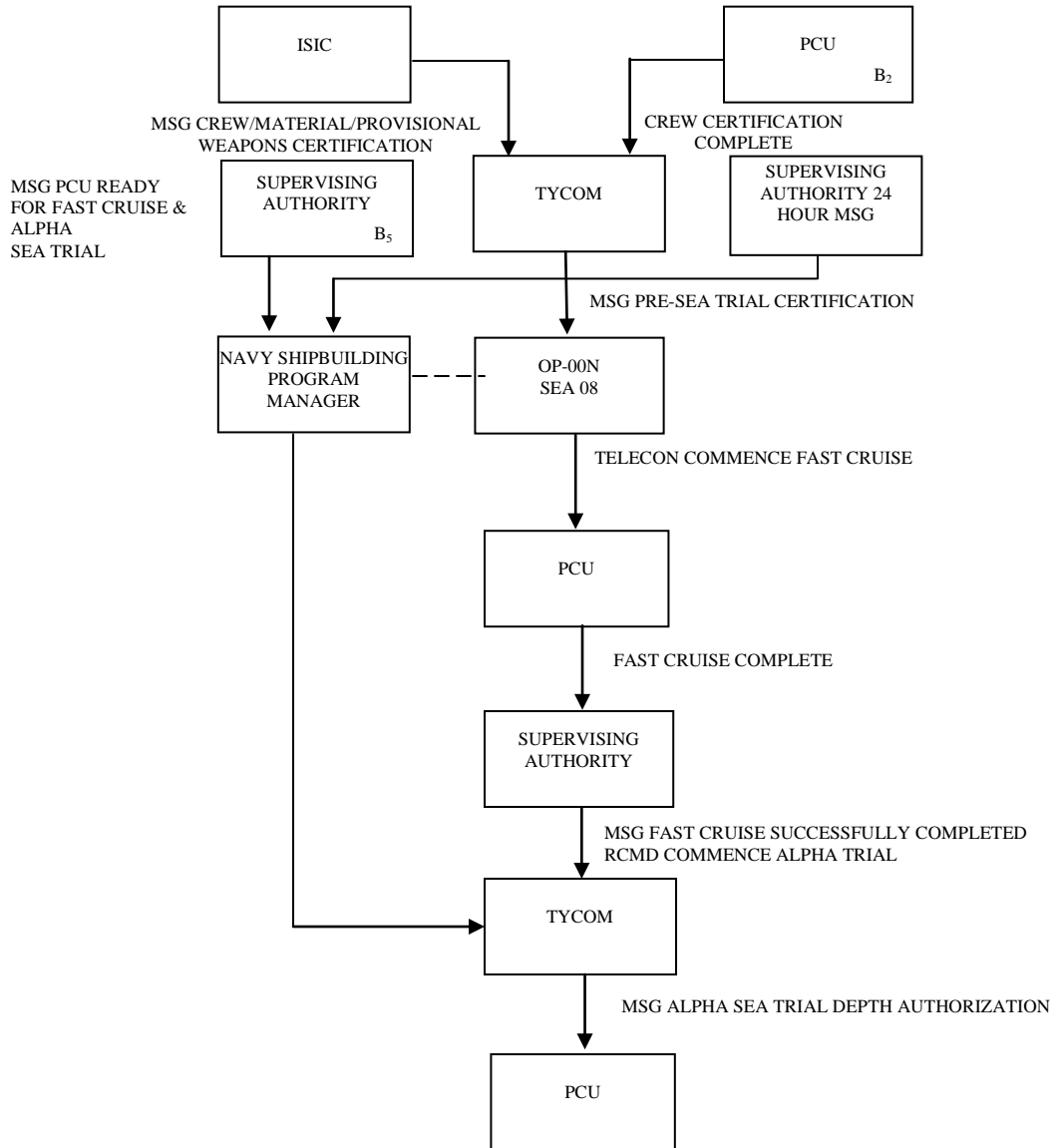

APPENDIX B - SUBS

Submarines Only

Message Scenario and Sample Messages

For Fast Cruise and Alpha Sea Trial (Nuclear Powered Ships)

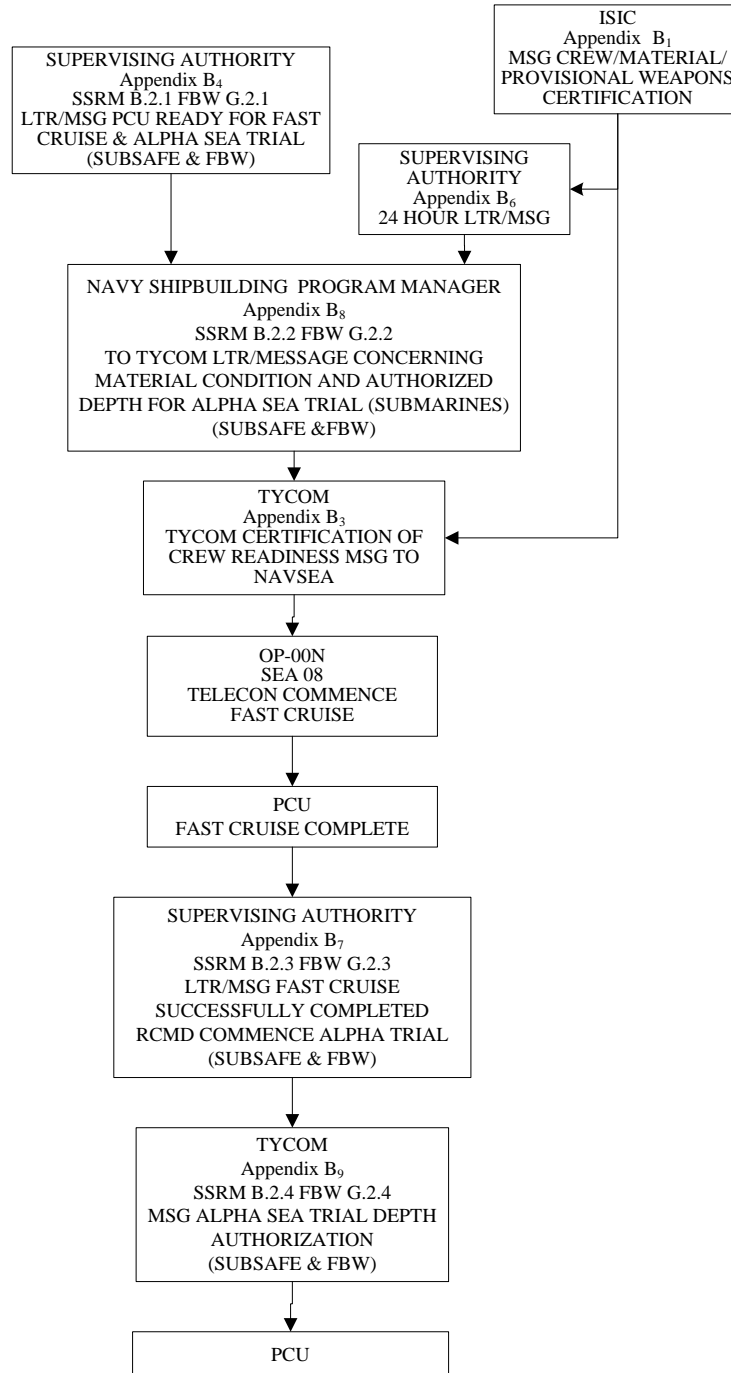

APPENDIX B₁

**SAMPLE ISIC CERTIFICATION OF NEW CONSTRUCTION
 READINESS FOR FAST CRUISE AND SEA TRIALS MESSAGE (SUBMARINES)**

FM (ISIC)//
 TO (TYCOM)//
 INFO CNO WASHINGTON DC//
 COMNAVSEASYS COM WASHINGTON DC//(NAVY SHIPBUILDING PROGRAM MANAGER)/
 PEO SUB WASHINGTON DC//
 COMUSFLTFORCOM NORFOLK VA//
 (PARENT GROUP)//
 (PARENT SQUADRON)//
 PRES INSURV NORFOLK VA
 SUPSHIP GROTON CT
 SUPSHIP NEWPORT NEWS VA
 COMSUBGRU TWO SHIPYARD REP GROTON CT
 COMSUBGRU SHIPYARD REP NEWPORT NEWS VA
 COMSUBRON ELEVEN//
 SSV CAROLYN CHOUEST
 (SUPERVISING AUTHORITY)/(APPROPRIATE CODE)//
 (SHIP NAME AND HULL NUMBER)//
 CCGDONE BOSTON MA//
 COMLANTAREA COGARD PORTSMOUTH VA//
 COMCOGARD SECTOR LONG ISLAND SOUND NEW HAVEN CT
 BT
 UNCLAS //N09094//
 MSGID/GENADMIN/(ISIC)//
 SUBJ/(SUBS) PRECOMUNIT (SHIP NAME AND HULL NO.) CREW AND SALVAGE CERTIFICATION//
 REF/A/DOC/COMUSFLTFORCOMINST 4790.3//(date)
 REF/B/DOC/COMNAVSEASYS COM/S9560-CH-SCB-010/(date)/(If required)
 REF/C/DOC/COMNAVSUBFOR 8500.2/(DATE) (If required)
 NARR/REF A IS JOINT FLEET MAINTENANCE MANUAL//REF B (if required) IS VIRGINIA
 CLASS SUBMARINE FLY-BY-WIRE SHIP CONTROL SYSTEM CERTIFICATION BOUNDARY
 BOOK, REF C IS TACTICAL WEAPONS CERTIFICATION, PROFICIENCY AND
 MODERNIZATION//
 RMKS/1. CREW CERTIFICATION CONDUCTED AND SATISFACTORILY COMPLETED IAW REF A.
 2. SALVAGE CONDITION CERTIFIED SATISFACTORY.
 3. MATERIAL CONDITION CERTIFIED SATISFACTORY UPON COMPLETION OR RESOLUTION
 OF THE FOLLOWING:
 4. PCU (Ship Name and Hull Number) IS PREPARED TO ASSUME RESPONSIBILITY FOR RE-ENTRY
 CONTROL. PCU (Ship Name and Hull Number) IS PREPARED TO ASSUME RESPONSIBILITY FOR
 SUBMARINE FLY-BY-WIRE AND FLIGHT CRITICAL COMPONENT CONTROLS IAW REF B.
 5. (ISIC) REPORTS THE READINESS OF (Ship Name and Hull Number) FOR COMMENCEMENT OF
 FAST CRUISE. COMMANDING OFFICER, PCU (Ship Name and Hull Number) CONCURS.
 6. SUBJECT TO SATISFACTORY COMPLETION OF FAST CRUISE AND RESOLUTION OF
 MANDATORY DEFICIENCIES, (ISIC) CONSIDERS PCU (Ship Name and Hull Number) MATERIAL
 CONDITION READINESS SATISFACTORY FOR COMMENCEMENT OF SEA TRIALS.
 7. PCU (Ship Name and Hull Number) IS PROVISIONALLY CERTIFIED TO LOAD, HANDLE, STOW, AND
 MAINTAIN SHAPES IAW REF C.//
 BT

**NOTE: ENSURE MESSAGES ARE IN ACCORDANCE WITH CURRENT MESSAGE FORMAT AND
 CURRENT PLAD IS UTILIZED.**

APPENDIX B₂

**SAMPLE PRE-COMMISSIONING UNIT MESSAGE
TO TYCOM CONCERNING CREW CERTIFICATION (CVN)**

FM PRECOMUNIT (SHIP NAME)//
TO TYCOM//
INFO COMNAVSEASYSKOM WASHINGTON DC//
(FLEET COMMANDER)//
(PARENT GROUP)//
(SUPERVISING AUTHORITY)//
BT
UNCLAS //N09094//
MSGID/GENADMIN/(ORIGINATING ACTIVITY)//
SUBJ: CREW CERTIFICATION PHASE II//
REF/A/DOC/OPNAVINST/-/9080.3//
AMPN/REF A IS PROCEDURES FOR TESTS AND TRIALS OF NAVAL NUCLEAR POWERED SHIPS
UNDER CONSTRUCTION, MODERNIZATION, CONVERSION, REFUELING AND OVERHAUL//
REF/B/DOC/OPNAVINST/-/9080.2//
AMPN/REF B IS CREW CERTIFICATION REQUIREMENTS FOR NEW CONSTRUCTION CVNS//
REF/C/DOC/CNALINST 3500.20//
AMPN/REF C IS CVN TRAINING AND READINESS MANUAL//
RMKS/1. (PARENT GROUP) CERTIFIES (SHIP NAME) SATISFACTORILY COMPLETED CREW
CERTIFICATION PHASE II AS REQUIRED BY REF A AND IAW REFS B AND C. RECOMMEND (SHIP
NAME) COMMENCE BUILDER'S SEA TRIALS AS SCHEDULED.
2. RELEASED BY COMMANDER (PARENT GROUP)//
BT

**NOTE: ENSURE MESSAGES ARE IN ACCORDANCE WITH CURRENT MESSAGE FORMAT AND
CURRENT PLAD IS UTILIZED.**

APPENDIX B₃

**SAMPLE TYCOM CERTIFICATION OF CREW READINESS
FOR UNDERWAY TRIALS MESSAGE (SUBMARINES)**

FM (TYCOM)//
TO CNO WASHINGTON DC//
COMNAVSEASYSYSCOM WASHINGTON DC//(NAVY SHIPBUILDING PROGRAM MANAGER)/
INFO (FLEET COMMANDER)//
(ISIC)//
(PARENT GROUP)//
(PARENT SQUADRON)//
PRECOMUNIT (SHIP NAME)//
(SUPERVISING AUTHORITY)//(APPROPRIATE CODE)//
UNSEARESCOM SAN DIEGO CA//
COMSUBRON ELEVEN//
BT
UNCLAS //N09094//
MSGID/GENADMIN/(TYCOM)//
SUBJ/(SUBS) PRE-SEA TRIAL CERTIFICATION OF PRECOMUNIT (SHIP NAME AND HULL NO.)//
REF/A/MSG/(ORIGINATING ACTIVITY)/(DTG)//
AMPN/REF A IS ISIC CERTIFICATION OF READINESS FOR FAST CRUISE AND SEA TRIALS//
REF/B/DOC/OPNAVINST 9080.3//
AMPN/REF B IS PROCEDURES FOR TESTS AND TRIALS OF NAVAL NUCLEAR POWERED SHIPS
UNDER CONSTRUCTION, MODERNIZATION, CONVERSION, REFUELING, AND OVERHAUL//
RMKS/1. PRE-SEA TRIAL INSPECTION OF PRECOMUNIT (SHIP NAME) COMPLETED SAT PER REF A.
IAW REF B, CREW IS CERTIFIED READY FOR UNDERWAY TRIALS, SUBJECT TO CORRECTION OF
SALVAGE INSP DEFS OF PARA 2, REF A, AND REPORT THAT FAST CRUISE SUCCESSFULLY
COMPLETED.//
BT

**NOTE: ENSURE MESSAGES ARE IN ACCORDANCE WITH CURRENT MESSAGE FORMAT AND
CURRENT PLAD IS UTILIZED.**

APPENDIX B₄

**SAMPLE SUPERVISING AUTHORITY TO NAVY SHIPBUILDING PROGRAM MANAGER MESSAGE
CONCERNING FAST CRUISE/ALPHA SEA TRIAL READINESS (SUBMARINES)**

FM (SUPERVISING AUTHORITY)//
TO COMNAVSEASYS COM WASHINGTON DC//
INFO CNO WASHINGTON DC//
FLEET COMMANDER (LANT/PAC)//
DIRSSP WASHINGTON DC FOR SSBN
COMSUB<LANT/PAC><NORFOLK VA/PEARL HARBOR HI//
COMSUBGRU//
PRECOMUNIT (SHIP NAME)//
BT
UNCLAS //N09094//
MSGID/GENADMIN/(SUPERVISING AUTHORITY)//
SUBJ/(SUBS) READINESS FOR FAST CRUISE AND ALPHA SEA TRIAL OF (SHIP NAME AND HULL NO.)//
REF/A/DOC/NAVSEA 0924-062-0010//
NARR/REF A IS THE SUBSAFE REQUIREMENTS MANUAL//
REF/B/LTR/(ORIGINATING ACTIVITY) (SERIAL NUMBER)/(DATE)//
AMPN/REF B IS NAVSEA SUBSAFE CERTIFICATION AUDIT REPORT FOR (SHIP NAME AND HULL NO.)//
RMKS/1. IAW REF A, (SUPERVISING AUTHORITY) REPORTS THE COMPLETION OF ALL SUBSAFE WORK AND TESTING <If shore power is to remain connected during Fast Cruise add the following statement: , WITH THE EXCEPTION OF THE INSTALLATION OF SHORE POWER COVERS,> REQUIRED FOR COMMENCEMENT OF ALPHA SEA TRIAL.
2. IAW REF A, (SUPERVISING AUTHORITY) REPORTS THAT ALL CAT I AUDIT RECOMMENDATIONS OF REF B AND/OR C HAVE BEEN SATISFACTORILY RESOLVED. THERE ARE NO SUBSAFE DEVIATIONS AND WAIVERS WITH CONDITIONS WHICH HAVE NOT BEEN SATISFIED.(OR LIST CONDITIONAL DEVIATIONS AND WAIVERS Including Deviation Number, Short Title And Expected Clearance Date/Key Event (NOTE-1))//
3. IAW REF A, THE STATUS OF ALL INCOMPLETE CAT 1A AUDIT RECOMMENDATIONS OF REF B IS AS FOLLOWS:
 A.
 B.
4. (SUPERVISING AUTHORITY) REPORTS READINESS OF (SHIP NAME AND HULL NO.) FOR COMMENCEMENT OF FAST CRUISE. OIC (SHIP NAME AND HULL NO.) CONCURS.
5. SUBJECT TO SATISFACTORY COMPLETION OF FAST CRUISE <If shore power is to remain connected during Fast Cruise add the following statement: , INSTALLATION OF THE SHORE POWER COVERS,> AND RESOLUTION OF MANDATORY DEFICIENCIES, (SUPERVISING AUTHORITY) CONSIDERS (SHIP NAME/HULL NO.) SUBSAFE MATERIAL CONDITION READINESS SATISFACTORY FOR COMMENCEMENT OF ALPHA SEA TRIAL.//
BT

NOTE-1: SUBJECT TO NAVY SHIPBUILDING PROGRAM MANAGER APPROVAL, CUMULATIVE LISTS OF CONDITIONAL DEVIATIONS AND WAIVERS WHICH ARE DEEMED TOO LENGTHY FOR MESSAGES MAY BE COMMUNICATED IN A LETTER FORMAT, WITH THE LETTER REFERENCED BY THE APPLICABLE MESSAGE.

NOTE-2: ENSURE MESSAGES ARE IN ACCORDANCE WITH CURRENT MESSAGE FORMAT AND CURRENT PLAD IS UTILIZED.

APPENDIX B₅

**SAMPLE SUPERVISING AUTHORITY MESSAGE TO NAVY SHIPBUILDING PROGRAM MANAGER
CONCERNING FAST CRUISE/SEA TRIAL READINESS (CVN)**

FM (SUPERVISING AUTHORITY)//
 TO COMNAVSEASYS COM WASHINGTON DC//(NAVY SHIPBUILDING PROGRAM MANAGER)/
 INFO CNO WASHINGTON DC//
 (FLEET COMMANDER)//
 PRESINSURV NORFOLK VA//
 (TYCOM ATLANTIC)//
 (TYCOM PACIFIC)//
 (PARENT GROUP)//
 PRECOMUNIT (SHIP NAME)//
 BT
 UNCLAS //N09094//
 MSGID/GENADMIN/(SUPERVISING AUTHORITY)//
 SUBJ: (SHIP NAME (CVN)) READINESS FOR FAST CRUISE AND SEA TRIALS
 REF/A/DOC/OPNAVINST/-/9080.3//
 AMPN/REF A IS PROCEDURES FOR TESTS AND TRIALS OF NAVAL NUCLEAR POWERED SHIPS
 UNDER CONSTRUCTION, MODERNIZATION, CONVERSION, REFUELING AND OVERHAUL//
 REF/B/MSG/PCU (SHIP NAME)/(MESSAGE DTG)//
 AMPN/REF B IS REPORT OF COMPLETION OF CREW CERTIFICATION//
 REF/C/LTR/(ORIGINATING ACTIVITY) (LETTER SERIAL NUMBER)/(DATE)//
 AMPN/REF C IS BUILDER REQUEST FOR REACTOR PLANT STARTUP TO PERFORM RETESTS WITH
 REACTOR STEAM//
 RMKS/1. IAW REF A, (SUPERVISING AUTHORITY) CERTIFIES THE MATERIEL CONDITION OF (SHIP
 NAME/HULL NO.) FOR FAST CRUISE AND SEA TRIALS.
 2. PHASE II CREW CERTIFICATION SUCCESSFULLY COMPLETED AS REPORTED BY REF B.
 3. ALL Q-COSAL ITEMS ARE ABOARD. ALL OSI AND SRI CRITICAL SHORTAGE ITEMS HAVE BEEN
 RESOLVED.
 4. CURRENTLY HAVE NO SIGNIFICANT ITEMS AFFECTING COMMENCEMENT OF FAST CRUISE/SEA
 TRIALS.
 5. UPON SATISFACTORY COMPLETION OF PROPULSION PLANT STARTUP RETESTS (REF C), ALL
 SYSTEMS/EQUIPMENT ESSENTIAL FOR SEA TRIALS WILL BE OPERATIONAL.
 6. REMAINING FAST CRUISE PREREQUISITE WORK WILL BE COMPLETE TO SUPPORT FAST CRUISE
 AT (TIME AND DATE).
 7. OIC (SHIP NAME) CONCURS//
 BT

**NOTE: ENSURE MESSAGES ARE IN ACCORDANCE WITH CURRENT MESSAGE FORMAT AND
CURRENT PLAD IS UTILIZED.**

APPENDIX B₆

**SAMPLE SUPERVISING AUTHORITY TO NAVY SHIPBUILDING PROGRAM MANAGER
24 HOUR MESSAGE CONCERNING FAST CRUISE READINESS (SUBMARINES)**

FM (SUPERVISING AUTHORITY)//
TO COMNAVSEASYS COM WASHINGTON DC//(NAVY SHIPBUILDING PROGRAM MANAGER)/
INFO PRECOMUNIT (SHIP NAME)//
BT
UNCLAS //N09080//
MSGID/GENADMIN/(SUPERVISING AUTHORITY)//
SUBJ/(SUBS) (SHIP NAME AND HULL NO.) READINESS FOR FAST CRUISE//
REF/A/DOC/OPNAVINST 9080.3//
AMPN/REF A IS PROCEDURES FOR TESTS AND TRIALS OF NAVAL NUCLEAR POWERED SHIPS
UNDER CONSTRUCTION, MODERNIZATION, CONVERSION, REFUELING AND OVERHAUL//
REF/B/MSG/(ORIGINATING ACTIVITY)/(DTG)//
AMPN/REF B IS (ISIC) MESSAGE CONCERNING CREW CERTIFICATION//
RMKS/1. PER REQUIREMENTS OF REF A, (SUPERVISING AUTHORITY) CONSIDERS THAT THE
MATERIAL CONDITION OF (SHIP NAME) WILL BE READY TO COMMENCE FAST CRUISE AT (TIME
AND DATE).
2. ALL SUBSAFE CAT I CARDS HAVE BEEN SATISFACTORILY RESOLVED.
3. MATERIAL/SALVAGE CONDITION CERTIFIED READY FOR SEA IN REF B.
4. SIGNIFICANT PRODUCTION WORK IS AS FOLLOWS:
 A.
 B.
5. ESTABLISHED TIME TO COMPLETE ALL ITEMS IS (TIME AND DATE).//
BT

**NOTE: ENSURE MESSAGES ARE IN ACCORDANCE WITH CURRENT MESSAGE FORMAT AND
CURRENT PLAD IS UTILIZED.**

APPENDIX B₇SAMPLE SUPERVISING AUTHORITY TO NAVY SHIPBUILDING PROGRAM MANAGER AND
TYCOM MESSAGE CONCERNING FAST CRUISE COMPLETION (SUBMARINES)

FM (SUPERVISING AUTHORITY)//
 TO COMSUB (LANT/PAC) (NORFOLK VA/PEARL HARBOR HI)//
 COMNAVSEASYS COM WASHINGTON DC//
 INFO CNO WASHINGTON DC//
 CINC<LANT/PAC>FLT<NORFOLK VA/PEARL HARBOR HI>
 <DIRSSP WASHINGTON DC FOR SSBN>
 COMSUBGRU (NO) //
 PRECOMUNIT (SHIP NAME)//
 BT
 UNCLAS //N09094//
 MSGID/GENADMIN/(SUPERVISING AUTHORITY)//
 SUBJ/(SUBS) PRECOM UNIT (SHIP NAME/HULL NUMBER) FAST CRUISE COMPLETION AND
 READINESS FOR ALPHA SEA TRIAL//
 REF/A/DOC/OPNAVINST 9083.3//
 REF/B/MSG/<SUPERVISING AUTHORITY>/<DTG>// {B.2.1}
 NARR/REF A CONTAINS PROCEDURES FOR TESTS AND TRIALS OF NAVAL NUCLEAR POWERED
 SHIPS. REF B IS SUPERVISING AUTHORITY TO NAVY SHIPBUILDING PROGRAM MANAGER
 MESSAGE CONCERNING FAST CRUISE/ALPHA SEA TRIAL READINESS//
 RMKS/1. IAW REF A, <SUPERVISING AUTHORITY> REPORTS <SHIP NAME/HULL NUMBER.> FAST
 CRUISE SUCCESSFULLY COMPLETED AT <TIME, DATE>.
 2. NO MANDATORY DEFICIENCIES FOR SEA TRIALS HAVE BEEN IDENTIFIED. *<If shore power
 remained connected during Fast Cruise add the following statement: AS REQUIRED BY REF B, <SUPERVISING
 AUTHORITY> REPORTS THE SATISFACTORY INSTALLATION OF SHORE POWER COVERS.> THERE
 HAVE BEEN NO RECS OPENED AND NO SUBSAFE DEVIATIONS AND WAIVERS PROCESSED SINCE
 THE START OF FAST CRUISE. <or, report any mandatory deficiencies discovered with corrective action, and if
 RECs and/or Deviations and Waivers were processed since the start of Fast Cruise, report ALL RECS OPENED
 SINCE THE START OF FAST CRUISE ARE CLOSED AND/OR ALL SUBSAFE DEVIATIONS AND
 WAIVERS RESOLVED.>*
 3. THERE ARE NO SUBSAFE DEVIATIONS AND WAIVERS WITH CONDITIONS WHICH HAVE NOT
 BEEN SATISFIED. *<or list conditional Deviations and Waivers including Deviation Number, Short Title and
 Expected Clearance Date/Key Event. (NOTE-1)>.*
 4. RECOMMEND COMMENCEMENT OF ALPHA TRIAL AS SCHEDULED. OIC (SHIP NAME)
 CONCURS.//
 BT

**NOTE-1: SUBJECT TO NAVY SHIPBUILDING PROGRAM MANAGER APPROVAL, CUMULATIVE
 LISTS OF CONDITIONAL DEVIATIONS AND WAIVERS WHICH ARE DEEMD TOO
 LENGTHY FOR MESSAGES MAY BE COMMUNICATED IN A LETTER FORMAT, WITH
 THE LETTER REFERENCED BY THE APPLICABLE MESSAGE.**

**NOTE-2: LIST ALL RE-ENTRIES TO MATERIAL CERTIFICATION BOUNDARY AND ALL WORK
 ON SYSTEMS AFFECTING RECOVERABILITY, SALVAGE, WATERTIGHT INTEGRITY,
 OR OPERATION OF SHIP'S CONTROL SURFACES WITH CORRECTIVE ACTION SINCE
 RELEASE OF FAST CRUISE MESSAGE.**

**NOTE-3: ENSURE MESSAGES ARE IN ACCORDANCE WITH CURRENT MESSAGE FORMAT
 AND CURRENT PLAD IS UTILIZED.**

APPENDIX B₈

SAMPLE NAVSEA TO TYCOM MESSAGE CONCERNING
MATERIAL CONDITION AND AUTHORIZED DEPTH FOR
ALPHA SEA TRIAL (SUBMARINES)

FM COMNAVSEASYS COM WASHINGTON DC//
TO ((COMSUB<LANT/PAC) (NORFOLK VA/PEARL HARBOR HI))//
INFO CNO WASHINGTON DC//
(LANT/PAC>FLT<NORFOLK VA/PEARL HARBOR HI)
(DIRSSP WASHINGTON DC FOR SSBN)
COMSUBGRU (NO)//
COMSUBRON (NO)//
PRECOMUNIT <SHIP NAME>
(SUPERVISING AUTHORITY)/(APPROPRIATE CODE)//
PRECOMUNIT (SHIP NAME)//
BT
UNCLAS //N09094//
MSGID/GENADMIN/COMNAVSEASYS COM//
SUBJ/(SUBS)-MATERIAL CONDITION READINESS AND DEPTH RECOMMENDATION FOR ALPHA SEA
TRIALS OF PRECOMMUNIT (SHIP NAME AND HULL NO.)//
REF/A/DOC/NAVSEA 0924-062-0010//
REF/B/DOC/OPNAVINST 9080.3//
REF/C/MSG/(SUPERVISING ACTIVITY)/(DTG)//
REF/D/MSG/(SUPERVISING ACTIVITY)/(DTG)//
REF/E/LTR/ (TYCOM)/(SERIAL NUMBER)/(DATE)//
REF/F/LTR/(NAVY SHIPBUILDING PROGRAM MANAGER)/(SERIAL NUMBER)/(DATE)//
NARR/REF A IS THE SUBSAFE REQUIREMENTS MANUAL. REF B CONTAINS PROCEDURES FOR
TESTS AND TRIALS OF NAVAL NUCLEAR POWERED SHIPS. REF C IS <SUPERVISING AUTHORITY>
MSG REPORTING SUBSAFE MATERIAL CONDITION READINESS OF <SHIP NAME/HULL NO.> FOR
FAST CRUISE AND ALPHA SEA TRIALS. REF D REPORTED THE MATERIAL READINESS OF THE SHIP
TO COMMENCE FAST CRUISE AND SEA TRIALS. REF E CONCURRED WITH THE ALPHA SEA TRIALS
AGENDA FOR <SHIP NAME/HULL NO.>. REF F APPROVED THE ALPHA SEA TRIALS AGENDA FOR
<SHIP NAME/HULL NO.>.///
RMKS/1. IAW REFS A AND B, AND AS REPORTED BY REFS C AND D, THE MATERIAL CONDITION OF
THE (SHIP NAME AND HULL NO.) IS CERTIFIED SATISFACTORY FOR SEA TRIALS TO (SPECIFIED) PERCENT
TEST DEPTH. <If shore power is to remain connected during Fast Cruise, add the following statement:;
FOLLOWING SUPERVISING AUTHORITY'S REPORT OF THE SATISFACTORY INSTALLATION OF
SHORE POWER COVERS,> RECOMMEND AUTHORIZED DIVING UNDER DELIBERATE AND
CONTROLLED CONDITIONS TO (SPECIFIED) PERCENT TEST DEPTH IAW THE SEA TRIAL AGENDA
CONCURRED IN BY REF E AND APPROVED BY REF F.
2. REQUEST NAVSEA PMS BE INFO ADDEE ON ALL SEA TRIALS SITREPS.//
BT

**NOTE: ENSURE MESSAGES ARE IN ACCORDANCE WITH CURRENT MESSAGE FORMAT AND
CURRENT PLAD IS UTILIZED.**

APPENDIX B₉SAMPLE TYCOM TO PRE-COMMISSIONING UNIT MESSAGE CONCERNING
ALPHA SEA TRIAL AUTHORIZED TEST AND OPERATING DEPTH (SUBMARINES)

FM COMSUB<LANT/PAC><NORFOLK VA/PEARL HARBOR HI>//
 TO PRECOMUNIT (SHIP NAME)//
 INFO CNO WASHINGTON DC//
 COMNAVSEASYS COM WASHINGTON DC//
 <LANT/PAC>FLT<NORFOLK VA/PEARL HARBOR HI>
 DIRSSP WASHINGTON DC FOR SSBN>
 COMSUBGRU <NO.>//
 COMSUBRON <NO.>//
 (SUPERVISING AUTHORITY)//
 BT
 UNCLAS //N09094//
 MSGID/GENADMIN/COMSUB(LANT/PAC)//
 SUBJ/(SUBS) PRECOMUNIT (SHIP NAME AND HULL NO.) ALPHA SEA TRIAL DEPTH AUTHORIZATION//
 REF/A/MSG/(ORIGINATING ACTIVITY)/(DTG)//
 REF/B/MSG/(ORIGINATING ACTIVITY)/(DTG)//
 REF/C/DOC/(TYCOM)<SER NO./DATE>//
 REF/D/DOC/(NAVSEA) (letter approving Sea Trials)
 NARR/REF A IS NAVSEA MATERIAL CONDITION READINESS REPORT AND ALPHA SEA TRIALS
 DEPTH RECOMMENDATION FOR <SHIP NAME/HULL NO.>. REF B IS <SUPERVISING AUTHORITY>
 REPORT OF FAST CRUISE COMPLETION AND READINESS FOR ALPHA SEA TRIALS <If shore power
 remained connected until start of Alpha Sea Trial, add the following statement: AND <SUPERVISING
 AUTHORITY> REPORT OF SATISFACTORY INSTALLATION OF SHORE POWER COVERS>. REF C
 CONCURRED WITH THE SEA TRIALS AGENDA. REF D APPROVED THE SEAL TRIALS AGENDA.//
 RMKS/1. REF A CERTIFIES MATERIAL CONDITION OF (SHIP NAME AND HULL NO.) FOR SEA TRIALS TO
 (SPECIFIED) PERCENT DESIGN TEST DEPTH. <If shore power remained connected until start of Alpha Sea
 Trial, add the following statement:., SUBJECT TO <SUPERVISING AUTHORITY> REPORT OF
 SATISFACTORY INSTALLATION OF SHORE POWER COVERS>. REF B IS <SUPERVISING
 AUTHORITY> REPORT OF SATISFACTORY INSTALLATION OF SHORE POWER COVERS>.
 2. REF B REPORTED FAST CRUISE COMPLETED SATISFACTORILY AND SHIP IS READY TO PROCEED
 ON ALPHA SEA TRIALS.
 3. (SHIP NAME AND HULL NO.) IS AUTHORIZED TO DIVE UNDER DELIBERATE AND CONTROLLED
 CONDITIONS TO (SPECIFIED) PERCENT TEST DEPTH IAW THE ALPHA SEA TRIALS AGENDA
 CONCURRED IN BY REF C AND APPROVED BY REF D.
 4. FOR OIC (SHIP NAME): RECOGNIZING LIMITED UNDERWAY OPERATIONAL EXPERIENCE LEVEL,
 EXERCISE EXTREME CAUTION WHILE CONDUCTING ALL OPERATIONS AT MAX AUTH DEPTH.
 ENSURE YOUR SHIP CONTROL PARTIES ARE WELL VERSED IN ALL ASPECTS OF SHIP'S
 COMPENSATION AND EFFECTS OF SPEED AND TRIM ADJUSTMENTS, AS WELL AS PROCEDURES TO
 PREVENT EXCEEDING MAX AUTH DEPTH.//
 5. EXCEPT AS LISTED IN 6. BELOW, THIS DEPTH AUTHORIZATION IS AUTOMATICALLY
 SUSPENDED UPON RE-ENTRY TO THE SUBSAFE CERTIFICATION BOUNDARY OR CASUALTY
 AFFECTING RECOVERABILITY, SALVAGE, WATERTIGHT INTEGRITY, OR OPERATION OF SHIP'S
 CONTROL SURFACES. THE SHIP SHALL NOT OPERATE AT A DEPTH GREATER THAN 200 FEET
 UNTIL RE-ENTRY IS CERTIFIED TO TYCOM AND TYCOM GRANTS APPROVAL TO OPERATE TO
 PREVIOUSLY AUTHORIZED DEPTH.//
 6. RE-ENTRY CONTROL TO ADJUST FLOOD CONTROL HYDRAULIC VALVE TIMING WILL BE
 CERTIFIED BY THE COMMANDING OFFICER, TYCOM CERTIFICATION IS NOT REQUIRED, AND A
 SITREP WILL BE TRANSMITTED PRIOR TO RESUMPTION OF OPERATION BELOW 200 FEET.//
 BT

**NOTE: ENSURE MESSAGES ARE IN ACCORDANCE WITH CURRENT MESSAGE FORMAT AND
 CURRENT PLAD IS UTILIZED.**

(This Page Intentionally Left Blank)

APPENDIX C

**Message Scenario and Sample Messages
For BRAVO, CHARLIE and Combined Trials (Submarines)**

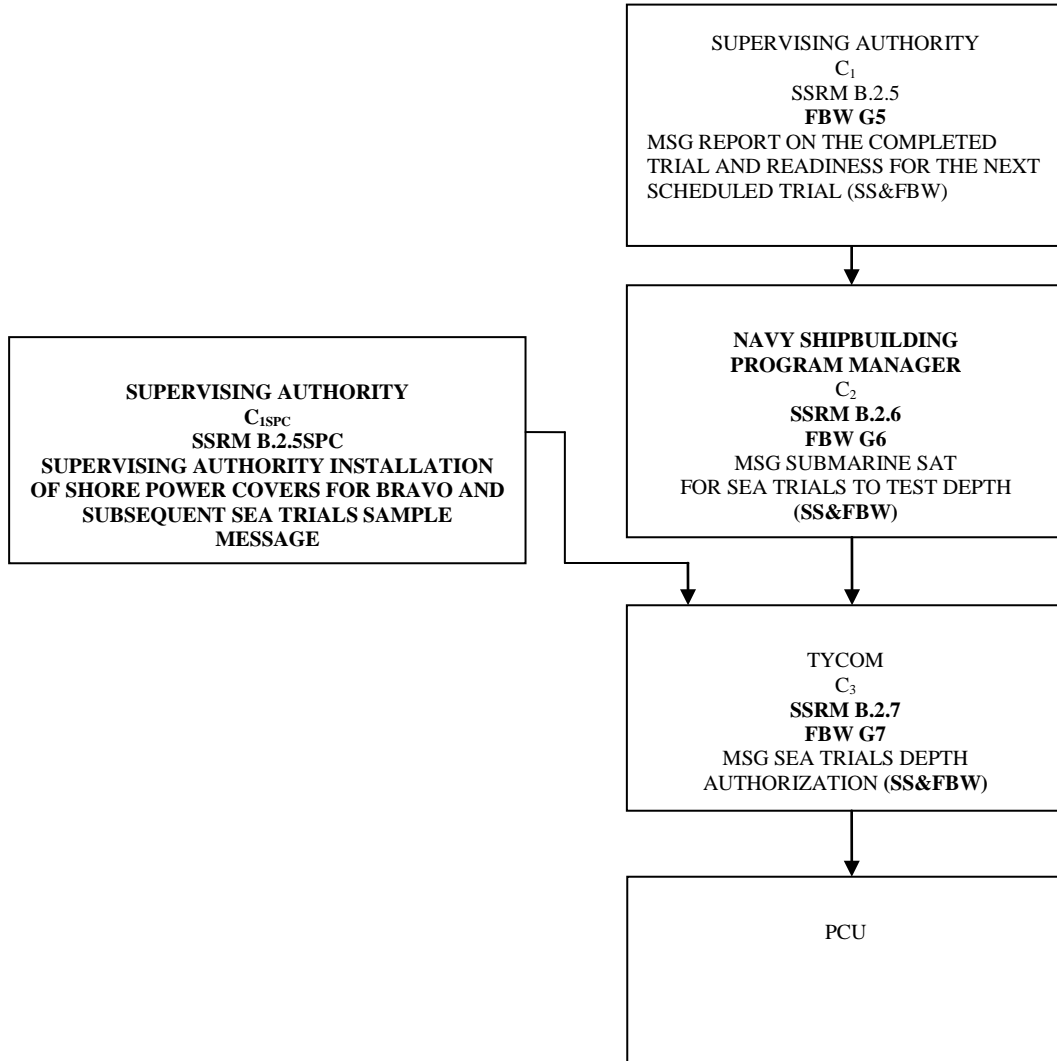

APPENDIX C₁

SAMPLE SUPERVISING AUTHORITY TO NAVY SHIPBUILDING PROGRAM MANAGER
MESSAGE CONCERNING DESIGN TEST DEPTH DIVE READINESS

FM (SUPERVISING AUTHORITY)//
TO COMNAVSEASYS COM WASHINGTON DC//
INFO CNO WASHINGTON DC//
<LANT/PAC>FLT<NORFOLK VA/PEARL HARBOR HI>//
<DIRSSP WASHINGTON DC FOR SSBN>//
COMSUB<LANT/PAC><NORFOLK VA/PEARL HARBOR>//
COMSUBGRU <NO.>//
COMSUBRON <NO.>//
PRECOMUNIT <SHIP NAME>//
BT
UNCLAS //N09094//
MSGID/GENADMIN/<SUPERVISING AUTHORITY>//
SUBJ/(SUBS) COMPLETION OF <ALPHA⁽²⁾>SEA TRIALS OF PRECOMUNIT<SHIP NAME/HULL
NO.>AND READINESS FOR <BRAVO⁽¹⁾>SEA TRIALS//
REF/A/MSG/<SUPERVISING AUTHORITY>/<DTG>/{JFMM B4, SSRM B.2.1}
REF/B/LTR/NAVSEA/< SER NO./DATE>
REF B IS SUBSAFE CERTIFICATION AUDIT REPORT.//
REF/C/DOC/NAVSEA 0924-062-0010//
NARR/REF A IS <SUPERVISING AUTHORITY'S> MESSAGE TO NAVY SHIPBUILDING PROGRAM
MANAGER CONCERNING REPORT OF READINESS OF <SHIPNAME/HULL NO.> FOR FAST CRUISE
AND ALPHA SEA TRIALS.REF B IS SUBSAFE CERTIFICATION AUDIT REPORT.
REF C IS SUBSAFE REQUIREMENTS MANUAL.//
RMKS/1. <SHIP NAME/HULL NO.> HAS SUCCESSFULLY COMPLETED <ALPHA⁽²⁾>SEA TRIALS.
2. BY REF A, <SUPERVISING AUTHORITY> REPORTED ALL CAT I AUDIT RECOMMENDATIONS OF
REF B SATISFACTORILY RESOLVED. THERE HAVE BEEN NO RECS OPENED AND NO SUBSAFE
DEVIATIONS AND WAIVERS PROCESSED SINCE <ALPHA⁽²⁾> SEA TRIALS. *<or, if RECs or Deviations and
Waivers were processed since the start of <ALPHA⁽²⁾> Sea Trials, report ALL RECS OPENED SINCE THE START
OF <ALPHA⁽²⁾> SEA TRIALS ARE CLOSED AND/OR ALL SUBSAFE DEVIATIONS AND WAIVERS
PROCESSED SINCE <ALPHA⁽²⁾> SEA TRIALS ARE RESOLVED.> <if shore power is to remain connected until
the start of Bravo or Subsequent Sea Trial add the following statement: .WITH THE EXCEPTION OF
INSTALLATION OF SHORE POWER COVERS >.*
3. THERE ARE NO SUBSAFE DEVIATIONS AND WAIVERS WITH CONDITIONS WHICH HAVE NOT
BEEN SATISFIED. *<or list conditional Deviations and Waivers including Deviation number, Short Title and
Expected Clearance Date/Key Event⁽³⁾>.*
4. THE STATUS OF REF B INCOMPLETE CAT 1A AUDIT RECOMMENDATIONS IS <SAME AS
REPORTED BY REF A OR AS FOLLOWS:>.
5. IAW REF C, <SUPERVISING AUTHORITY> REPORTS THAT THE SUBSAFE MATERIAL CONDITION OF
<SHIP NAME/HULL NO.> IS SATISFACTORY FOR <BRAVO⁽¹⁾> SEA TRIALS TO TEST DEPTH. OIC <SHIP
NAME/HULL NO.> CONCURS.//
BT

**(1) UPCOMING TRIALS WHICH IS SUBJECT OF THIS CERTIFICATION (E.G., BRAVO SEA TRIALS,
CHARLIE SEA TRIALS, INSURV TRIALS, ETC.).**

(2) PREVIOUS TRIALS.

**(3) Subject to Navy Shipbuilding Program Manager approval, cumulative lists of conditional Deviations and
Waivers which are deemed too lengthy for messages may be communicated in a letter format, with the
letter referenced by the applicable message.**

NOTE 1: LIST ALL RE-ENTRIES TO MATERIAL CERTIFICATION BOUNDARY AND ALL WORK ON SYSTEMS AFFECTING RECOVERABILITY, SALVAGE, WATERTIGHT INTEGRITY, OR OPERATION OF SHIP'S CONTROL SURFACES WITH CORRECTIVE ACTION SINCE RELEASE OF FAST CRUISE MESSAGE.

NOTE 2: ENSURE MESSAGES ARE IN ACCORDANCE WITH CURRENT MESSAGE FORMAT AND CURRENT PLAD IS UTILIZED.

APPENDIX C₂

**SAMPLE NAVSEA TO TYCOM MESSAGE CONCERNING
DESIGN TEST DEPTH DIVE AUTHORIZATION**

FM COMNAVSEASYS COM WASHINGTON DC//
TO COMSUB<FOR/PAC><NORFOLK VA/PEARL HARBOR>
INFO CNO WASHINGTON DC//CINC<LANT/PAC>FLT<NORFOLK VA/PEARL HARBOR HI>
<DIRSSP WASHINGTON DC FOR SSBN>
COMSUBGRU <NO.>
COMSUBRON <NO.>
PRECOMUNIT <SHIP NAME>//
<SUPERVISING AUTHORITY>
BT
UNCLAS //N09094//
MSGID/GENADMIN/COMNAVSEASYS COM//
SUBJ/(SUBS) SUBSAFE MATERIAL CONDITION READINESS AND DEPTH RECOMMENDATION FOR
<BRAVO^(NOTE 2)> SEA TRIALS OF <SHIP NAME>//
REF/A/DOC/NAVSEA 0924-062-0010//
REF/B/MSG/(SUPERVISING AUTHORITY)/(DTG)//
REF/C/LTR/COMSUB<FOR/PAC>/<SER NO./DATE>//
REF/D/LTR/NAVSEA/<SER NO./ DATE>//
NARR/REF A IS THE SUBSAFE REQUIREMENTS MANUAL. REF B IS <SUPERVISING AUTHORITY>
REPORT OF <SHIP NAME/HULL NO.>COMPLETION OF <ALPHA^(NOTE 1)> SEA TRIALS AND READINESS
FOR <BRAVO^(NOTE 2)> SEA TRIALS. REF C CONCURRED WITH THE <BRAVO^(NOTE 2)> SEA TRIALS
AGENDA FOR <SHIP NAME/HULL NO.>. REF D APPROVED THE <BRAVO^(NOTE 2)> SEA TRIALS AGENDA
FOR <SHIP NAME/HULL NO.>./.
RMKS/1. IAW REF A AND AS REPORTED BY REF B, THE SUBSAFE MATERIAL CONDITION OF (SHIP
NAME AND HULL NO.) IS CERTIFIED SATISFACTORY FOR SEA TRIALS TO TEST DEPTH. <if shore power is
to remain connected until start of Bravo or subsequent Sea Trial add the following statement: FOLLOWING
SUPERVISING AUTHORITY'S REPORT OF SATISFACTORY INSTALLATION OF SHORE POWER
COVERS>.
2. RECOMMEND AUTHORIZED DIVING UNDER DELIBERATE AND CONTROLLED CONDITIONS IAW
THE <BRAVO^(NOTE 2)> SEA TRIALS AGENDA CONCURRED IN BY REF C AND APPROVED BY REF D.
3. REQUEST NAVSEA PMS<> BE INFO ADDEE FOR ALL SEA TRIAL SITREPS.//

NOTE 1: PREVIOUS TRIALS.

**NOTE 2 UPCOMING TRIALS WHICH ARE SUBJECT OF THIS CERTIFICATION (E.G., BRAVO
SEA TRIALS, CHARLIE SEA TRIALS, INSURV TRIALS, ETC.).**

BT

**NOTE: ENSURE MESSAGES ARE IN ACCORDANCE WITH CURRENT MESSAGE FORMAT AND
CURRENT PLAD IS UTILIZED.**

APPENDIX C₃SAMPLE TYCOM TO PRE-COMMISSIONING UNIT MESSAGE CONCERNING
DESIGN TEST DEPTH DIVE AUTHORIZATION

FM COMSUB<LANT/PAC><NORFOLK VA/PEARL HARBOR HI>//
 TO PRECOMUNIT <SHIP NAME>//
 INFO CNO WASHINGTON DC//
 COMNAVSEASYS COM WASHINGTON DC//
 CINC<LANT/PAC>FLT<NORFOLK VA/PEARL HARBOR HI>//
 <DIRSSP WASHINGTON DC FOR SSBN>//
 COMSUBGRU <NO.>//
 COMSUBRON <NO.>//
 <SUPERVISING AUTHORITY>//
 BT
 UNCLAS //N09094//
 MSGID/GENADMIN/COMSUB<LANT/PAC>//
 SUBJ/(SUBS) PRECOMUNIT <SHIP NAME/HULL NO.> <BRAVO⁽¹⁾> SEA TRIALS DEPTH AUTHORIZATION//
 REF/A/MSG/COMNAVSEASYS COM/<DTG>// {JFMM C2, SSRM B.2.6}
 <if shore power remained connected until start of Bravo or Subsequent Sea Trial add the following reference:
 REF/B/MSG/<SUPERVISING AUTHORITY>/<DTG>/{B.2.5spc}.>
 REF/B<or C>/DOC/COMSUB<LANT/PAC>NOTE C3120//
 REF/C<or D>/LTR/COMSUB<LANT/PAC><SER NO./DATE>//
 REF/D<or E>/LTR/NAVSEA/<SER NO./DATE>//
 NARR/REF A IS NAVSEA REPORT OF <SHIP NAME/HULL NO.> SUBSAFE MATERIAL CONDITION
 READINESS AND DEPTH RECOMMENDATION FOR <BRAVO^(NOTE 1)> SEA TRIALS. <if shore power
 remained connected until the start of Bravo or Subsequent Sea Trial add the following statement: REF B IS
 <SUPERVISING AUTHORITY> REPORT OF SATISFACTORY INSTALLATION OF SHORE POWER
 COVERS.> REF B<or C> CONTAINS COMSUB<LANT/PAC> AUTHORIZED SUBMARINE OPERATING
 AND TEST DEPTHS. REF C<or D> CONCURRED IN THE <BRAVO^(NOTE 1)> SEA TRIALS AGENDA FOR
 <SHIP NAME/HULL NO.>. REF D<or E> APPROVED THE <BRAVO^(NOTE 1)> SEA TRIALS AGENDA FOR
 <SHIP NAME/HULL NO.>.///
 RMKS/1. REF A CERTIFIED THAT THE SUBSAFE MATERIAL CONDITION OF <SHIP NAME/HULL NO.> IS
 SATISFACTORY FOR <BRAVO^(NOTE 1)> SEA TRIALS TO TEST DEPTH<if shore power remained connected
 until start of Bravo or Subsequent Sea Trial add the following statement: „SUBJECT TO<SUPERVISING
 AUTHORITY>REPORT OF SATISFACTORY INSTALLATION OF SHORE POWER COVERS. REF B IS
 <SUPERVISING AUTHORITY>REPORT OF SATISFACTORY INSTALLATION OF SHORE POWER
 COVERS>.///
 2. SUBJECT TO THE RESTRICTIONS OF REFS A AND B<or C>, <SHIP NAME/HULL NO.> IS AUTHORIZED
 TO DIVE UNDER DELIBERATE AND CONTROLLED CONDITIONS TO TEST DEPTH IAW THE <BRAVO^(NOTE 1)>
 <NOTE 1> SEA TRIALS AGENDA CONCURRED IN BY REF C,<or D> AND APPROVED BY REF D<or E>.///
 3. EXCEPT AS LISTED IN 4. BELOW, THIS DEPTH AUTHORIZATION IS AUTOMATICALLY
 SUSPENDED UPON RE- ENTRY TO THE SUBSAFE CERTIFICATION BOUNDARY OR CASUALTY
 AFFECTING RECOVERABILITY, SALVAGE, WATERTIGHT INTEGRITY, OR OPERATION OF SHIP'S
 CONTROL SURFACES. THE SHIP SHALL NOT OPERATE AT A DEPTH GREATER THAN 200 FEET
 UNTIL RE- ENTRY IS CERTIFIED TO TYCOM AND TYCOM GRANTS APPROVAL TO OPERATE TO
 PREVIOUSLY AUTHORIZED DEPTH.///
 4. RE-ENTRY CONTROL TO ADJUST FLOOD CONTROL HYDRAULIC VALVE TIMING WILL BE
 CERTIFIED BY THE COMMANDING OFFICER, TYCOM CERTIFICATION IS NOT REQUIRED, AND A
 SITREP WILL BE TRANSMITTED PRIOR TO RESUMPTION OF OPERATION BELOW 200 FEET.///
 BT

Superscript:

NOTE 1: UPCOMING TRIALS WHICH IS SUBJECT OF THIS CERTIFICATION (E.G., BRAVO SEA TRIALS, CHARLIE SEA TRIALS, INSURV TRIALS, ETC.).

NOTE 2: ENSURE MESSAGES ARE IN ACCORDANCE WITH CURRENT MESSAGE FORMAT AND CURRENT PLAD IS UTILIZED.

APPENDIX C_{spc}SUPERVISING AUTHORITY INSTALLATION OF SHORE POWER COVERS FOR BRAVO AND
SUBSEQUENT SEA TRIALS SAMPLE MESSAGE

FM <SUPERVISING AUTHORITY>//
 TO COMSUB<LANT/PAC><NORFOLK VA/PEARL HARBOR>//
 COMNAVSEASYS COM WASHINGTON DC//
 INFO CNO WASHINGTON DC//
 <LANT/PAC>FLT<NORFOLK VA/PEARL HARBOR HI>//
 <DIRSSP WASHINGTON DC FOR SSBN>//
 COMSUBGRU <NO.>//
 COMSUBRON <NO.>//
 PRECOMUNIT <SHIP NAME>//
 BT
 UNCLAS //N09094//
 MSGID/GENADMIN/<SUPERVISING AUTHORITY>//
 SUBJ/(SUBS) COMPLETION OF <ALPHA⁽²⁾> SEA TRIALS OF PRECOMUNIT <SHIP NAME/HULL NO.> AND
 READINESS FOR <BRAVO⁽¹⁾> SEA TRIALS//
 REF/A/MSG/<SUPERVISING AUTHORITY>/<DTG>// {JFMM C1, SSRM B.2.5}
 NARR/REF A IS <SUPERVISING AUTHORITY'S> REPORT OF READINESS OF <SHIP NAME/HULL NO.>FOR
 <BRAVO⁽¹⁾> SEA TRIALS.//
 RMKS/1. REF A, <SUPERVISING AUTHORITY> REPORTED READINESS FOR <BRAVO⁽¹⁾> SEA TRIALS WITH
 THE EXCEPTION OF INSTALLATION OF SHORE POWER COVERS.
 2. <SUPERVISING AUTHORITY> REPORTS THAT SHORE POWER COVERS FOR <SHIP/NAME/HULL
 NO.> HAVE BEEN SATISFACTORILY INSTALLED.//
 BT

⁽¹⁾ UPCOMING TRIALS WHICH IS SUBJECT OF THIS CERTIFICATION (E.G., BRAVO SEA TRIALS, CHARLIE SEA TRIALS, INSURV TRIALS, ETC.).

⁽²⁾ PREVIOUS TRIALS.

NOTE: ENSURE MESSAGES ARE IN ACCORDANCE WITH CURRENT MESSAGE FORMAT AND CURRENT PLAD IS UTILIZED

This Page Intentionally Left Blank

APPENDIX D

**Message Scenario and Sample Messages
for URO Certification (Submarines)**

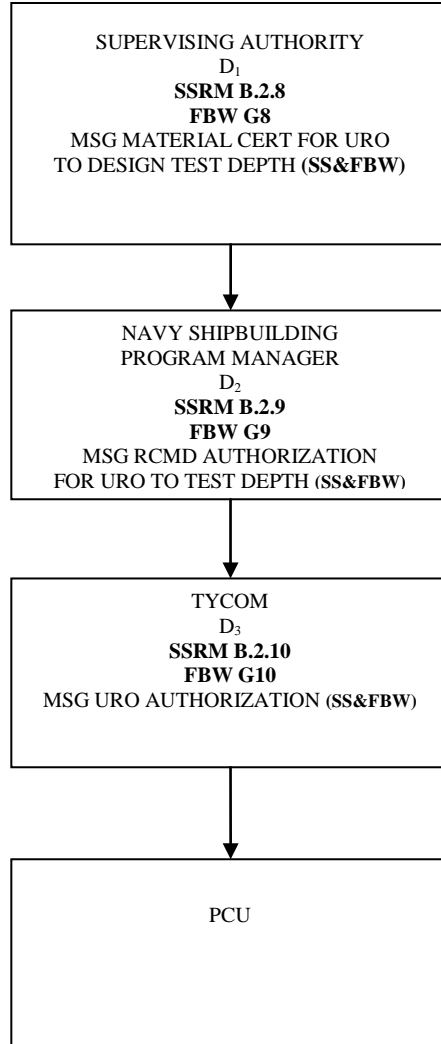

APPENDIX D₁

SAMPLE SUPERVISING AUTHORITY TO NAVY SHIPBUILDING
PROGRAM MANAGER MESSAGE CONCERNING URO

FM <SUPERVISING AUTHORITY>//
TO COMNAVSEASYS COM WASHINGTON DC//
INFO CNO WASHINGTON DC//
<LANT/PAC>FLT<NORFOLK VA/PEARL HARBOR HI>//
<DIRSSP WASHINGTON DC FOR SSBN>//
COMSUB<LANT/PAC><NORFOLK VA/PEARL HARBOR HI>//
COMSUBGRU <NO.>//
COMSUBRON <NO.>//
PRECOMUNIT <SHIP NAME>//
BT
UNCLAS //N09094//
MSGID/GENADMIN/<SUPERVISING AUTHORITY>//
SUBJ/(SUBS) UNRESTRICTED OPERATIONS FOR <SHIP NAME/HULL NO.>//
REF/A/DOC/NAVSEA 0924-062-0010//
REF/B/MSG/<SUPERVISING AUTHORITY>|<DTG>||{JFMM B4, SSRM B.2.1}||
REF/C/LTR/NAVSEA/<SER NO./DATE>||(REFERENCE ADDITIONAL AUDIT REPORTS AS REQUIRED)//
NARR/REF A IS THE SUBSAFE REQUIREMENTS MANUAL. REF B IS <SUPERVISING AUTHORITY>
REPORT OF <SHIP NAME/HULL NO.> READINESS FOR FAST CRUISE AND ALPHA SEA TRIALS. REF C
IS THE NAVSEA SUBSAFE CERTIFICATION AUDIT REPORT FOR <SHIP NAME/HULL NO.>./.
RMKS/1. IAW REF A, <SUPERVISING AUTHORITY> REPORTS THE SATISFACTORY COMPLETION OF
ALL SEA TRIALS, COMPLETION OF CONTROLLED DIVES AND THE RESOLUTION OF MANDATORY
SEA TRIAL DEFICIENCIES, <AND SATISFACTORY RESOLUTION OF ANY SHIP'S FORCE RECS.>./.
2. REF B REPORTED SATISFACTORY RESOLUTION OF ALL CAT I AUDIT RECOMMENDATIONS OF
REF C. IAW REF A, <SUPERVISING AUTHORITY> REPORTS THAT ALL CAT IA AUDIT RECOMMENDATIONS
OF REF C HAVE BEEN SATISFACTORYLY RESOLVED. THERE IS NO DEFERRED SUBSAFE WORK
AND THERE ARE NO SUBSAFE DEVIATIONS AND WAIVERS WITH CONDITIONS WHICH HAVE NOT
BEEN SATISFIED. <or list deferred SUBSAFE work and/or conditional SUBSAFE Deviations and Waivers
including Deviation Number, Short Title and Expected Clearance Date/Key Event⁽¹⁾>./.
3. THE STATUS OF INCOMPLETE CAT II AUDIT RECOMMENDATIONS OF REF C IS AS FOLLOWS:
A.
B.
4. IAW REF A, <SUPERVISING AUTHORITY> REPORTS THE SUBSAFE MATERIAL CONDITION OF <SHIP
NAME/HULL NO.> IS SATISFACTORY FOR UNRESTRICTED OPERATIONS TO TEST DEPTH./.
BT

⁽¹⁾ Subject to Navy Shipbuilding Program Manager approval, cumulative lists of conditional Deviations and Waivers which are deemed too lengthy for messages may be communicated in a letter format, with the letter referenced by the applicable message.

NOTE 1: LIST ALL RE-ENTRIES TO MATERIAL CERTIFICATION BOUNDARY AND ALL WORK ON SYSTEMS AFFECTING RECOVERABILITY, SALVAGE, WATERTIGHT INTEGRITY, OR OPERATION OF SHIP'S CONTROL SURFACES WITH CORRECTIVE ACTION SINCE RELEASE OF FAST CRUISE MESSAGE.

NOTE 2: ENSURE MESSAGES ARE IN ACCORDANCE WITH CURRENT MESSAGE FORMAT AND CURRENT PLAD IS UTILIZED.

APPENDIX D₂
SAMPLE NAVSEA TO TYCOM MESSAGE
CONCERNING URO

FM COMNAVSEASYS COM WASHINGTON DC//
 TO COMSUB<LANT/PAC><NORFOLK VA/PEARL HARBOR HI>//
 INFO CNO WASHINGTON DC//
 <LANT/PAC>FLT<NORFOLK VA/PEARL HARBOR HI>//
 <DIRSSP WASHINGTON DC FOR SSBN>//
 COMSUBGRU <NO.>//
 COMSUBRON <NO.>//
 PRECOMUNIT <SHIP NAME>//
 <SUPERVISING AUTHORITY>//
 BT
 UNCLAS //N09094//
 MSGID/GENADMIN/COMNAVSEASYS COM//
 SUBJ/(SUBS) RECOMMENDATION FOR UNRESTRICTED OPERATIONS FOR <SHIP NAME AND HULL NO.>//
 REF/A/DOC/NAVSEA 0924-062-0010//
 REF/B/MSG/<SUPERVISING AUTHORITY>/<DTG>// {JFMM D1, SSRM B.2.8}
 REF/C/DOC/OPNAVINST 9110.1//
 NARR/REF A IS THE SUBSAFE REQUIREMENTS MANUAL. REF B IS <SUPERVISING AUTHORITY>
 REPORT OF <SHIP NAME/HULL NO.> SUBSAFE MATERIAL CONDITION READINESS FOR URO. REF C
 CONTAINS POLICY FOR SUBMARINE TEST AND OPERATING DEPTHS.//
 RMKS/1. IAW REF A, REF B REPORTED THE SUBSAFE MATERIAL CONDITION READINESS OF <SHIP
 NAME AND HULL NO.> IS SATISFACTORY AND NO OUTSTANDING DEPTH LIMITING DISCREPANCIES
 EXIST.
 2. REF B ALSO REPORTED SATISFACTORY COMPLETION OF ALL SEA TRIALS, COMPLETION OF
 CONTROLLED DIVES AND RESOLUTION OF MANDATORY SEA TRIAL DEFICIENCIES.
 3. IAW REFS A AND C, NAVSEA CERTIFIES THAT THE SUBSAFE MATERIAL CONDITION OF <SHIP
 NAME/HULL NO.> IS SATISFACTORY AND RECOMMENDS THAT THE SHIP BE AUTHORIZED
 UNRESTRICTED OPERATIONS TO TEST DEPTH SUBJECT TO COMPLIANCE WITH REF A <WITH THE
 FOLLOWING RESTRICTIONS: list any restrictions which may be applicable>.
 4. URO MRC PERIODICITIES REQUIRED BY REF A, SHALL COMMENCE ON <DATE>.//
 BT

**NOTE: ENSURE MESSAGES ARE IN ACCORDANCE WITH CURRENT MESSAGE FORMAT AND
 CURRENT PLAD IS UTILIZED.**

APPENDIX D₃

**SAMPLE TYCOM TO PRE-COMMISSIONING UNIT MESSAGE
CONCERNING URO**

FM COMSUB<LANT/PAC><NORFOLK VA/PEARL HARBOR HI>//
TO PRECOMUNIT <SHIP NAME>//
INFO CNO WASHINGTON DC//
COMNAVSEASYS COM WASHINGTON DC//
CINC<LANT/PAC>FLT<NORFOLK VA/PEARL HARBOR HI>//
<DIRSSP WASHINGTON DC FOR SSBN>//
COMSUBGRU <NO.>//
COMSUBRON <NO.>//
<SUPERVISING AUTHORITY>//
BT
UNCLAS //N09094//
MSG/GENADMIN/COMSUB<LANT/PAC>//
SUBJ/(SUBS) UNRESTRICTED OPERATIONS OF PRECOMUNIT <SHIP NAME/HULL NO.>//
REF/A/MSG/NAVSEA/<DTG>// {JFMM D2, SSRM B.2.9}
REF/B/DOC/NAVSEA 0924-062-0010//
REF/C/DOC/COMSUB<LANT/PAC>NOTE C3120//
NARR/REF A IS NAVSEA URO MSG FOR <SHIP NAME/HULL NO.>. REF B IS THE SUBSAFE
REQUIREMENTS MANUAL. REF C CONTAINS COMSUB<LANT/PAC> AUTHORIZED SUBMARINE
OPERATING AND TEST DEPTHS.//
RMKS/1. REF A CERTIFIED THE SUBSAFE MATERIAL CONDITION OF <SHIP NAME/HULL NO.> IS
SATISFACTORY AND RECOMMENDED THAT <SHIP NAME/HULL NO.> BE AUTHORIZED TO CONDUCT
UNRESTRICTED OPERATIONS TO TEST DEPTH.
2. <SHIP NAME/HULL NO.> IS AUTHORIZED TO CONDUCT OPERATIONS TO TEST DEPTH SUBJECT TO
THE FOLLOWING RESTRICTIONS: <list restrictions if they exist or state "NONE">
3. CONTINUED CERTIFICATION FOR OPERATIONS TO TEST DEPTH IS SUBJECT TO COMPLIANCE
WITH REF B. URO MRC PERIODICITIES COMMENCE ON <DATE>.
4. THIS MSG REMAINS IN EFFECT UNTIL INCLUDED IN A FUTURE REVISION OF REF C.//
BT

**NOTE: ENSURE MESSAGES ARE IN ACCORDANCE WITH CURRENT MESSAGE FORMAT AND
CURRENT PLAD IS UTILIZED.**

APPENDIX E

**Pre-RSE/RSE/Criticality/Power Range
Testing Logic Table (All Nuclear Powered Ships)**

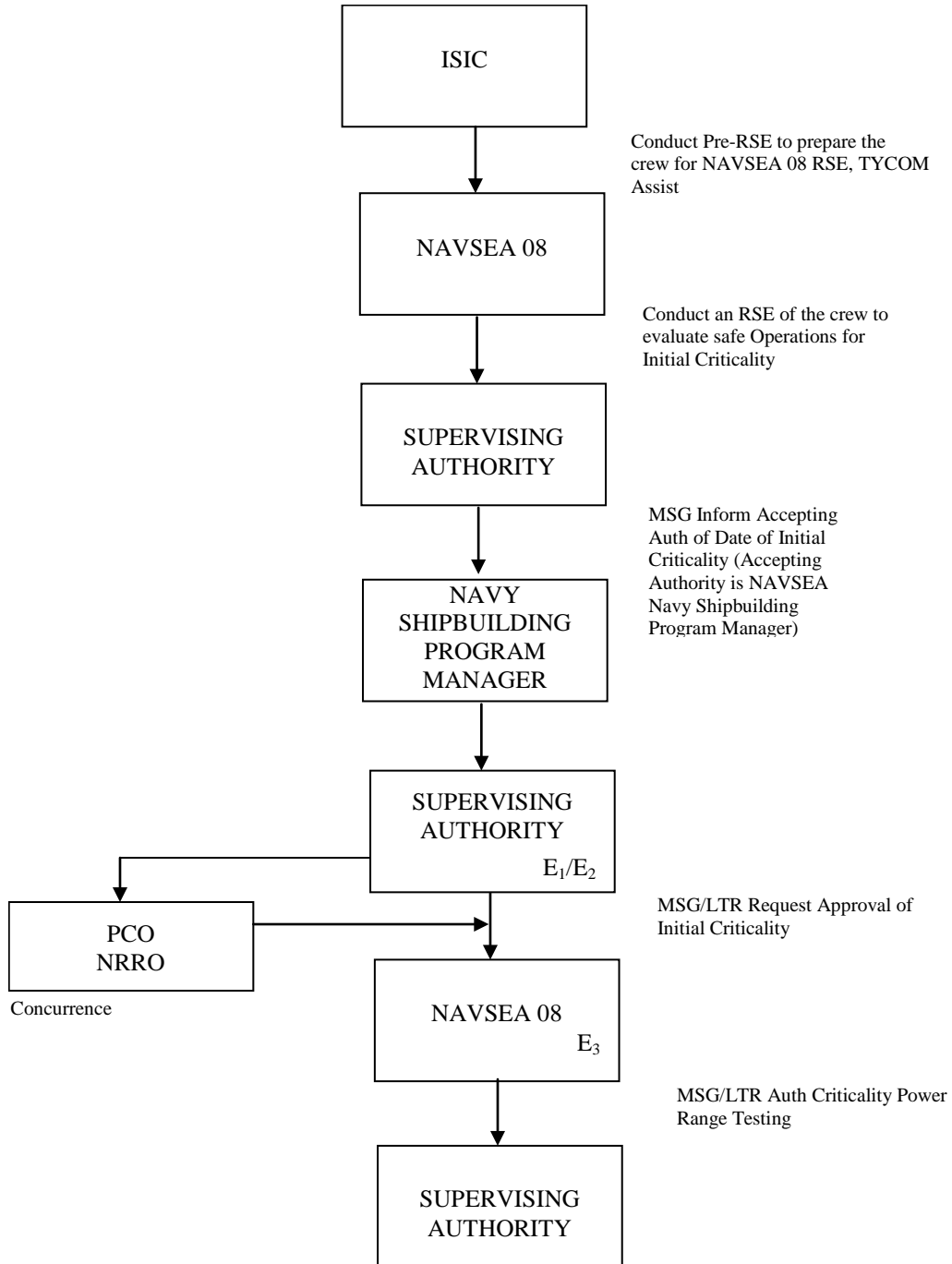

APPENDIX E₁

**SAMPLE SUPERVISING AUTHORITY TO NAVSEA MESSAGE
REQUESTING AUTHORIZATION FOR CRITICALITY**

FM (SUPERVISING AUTHORITY)//
TO COMNAVSEASYS COM WASHINGTON DC//
INFO CNO WASHINGTON DC//
(NAVY SHIPBUILDING PROGRAM MANAGER)//
(FLEET COMMANDER)//
(TYCOM)// (FOR CVN)//
(ISIC)//
(PARENT GROUP)//
(PARENT SQUADRON)//
PRECOMUNIT (SHIP NAME)//
BT
UNCLAS NOFORN//N09690//
MSGID/GENADMIN/(SUPERVISING AUTHORITY)//
SUBJ/(SHIP NAME AND HULL NO.) INITIAL CRITICALITY OF REACTOR PLANT NR TWO//
REF/A/DOC/NAVSEA 0989-028-5000//
AMPN/REF A IS MANUAL FOR THE CONTROL OF THE TESTING AND PLANT CONDITIONS//
REF B/DOC/OPNAVINST 9080.3//
AMPN/REF B IS PROCEDURES FOR TESTS AND TRIALS OF NAVAL NUCLEAR POWERED SHIPS
UNDER CONSTRUCTION, MODERNIZATION, CONVERSION, REFUELING, AND OVERHAUL//
REF/C/LTR/(ORIGINATING ACTIVITY) (SERIAL NUMBER)/(DATE)//
AMPN/REF C IS NAVSEA 08 LETTER IDENTIFYING CORE INSTALLED IN (SHIP NAME)//
REF/D/DOC/A4W/A1G PREREQ LIST NR SEVEN REV D DTD 6 MAY 86//
AMPN/REF D IS A4W/A1G PREREQUISITE LIST NUMBER SEVEN//
REF/E/LTR/(ORIGINATING ACTIVITY) (SERIAL NUMBER)/(DATE)//
AMPN/REF E IS NAVSEA NAVY SHIPBUILDING PROGRAM MANAGER LETTER CONCERNING
RESOLUTION TO OUTSTANDING WORK ITEMS//
REF/F/LTR/(ORIGINATING ACTIVITY) (SERIAL NUMBER)/(DATE)//
AMPN/REF F IS SUPERVISING AUTHORITY LETTER CONCERNING RESOLUTION TO OUTSTANDING
WORK ITEMS//
RMKS/1. IAW REFS A AND B, REQ AUTHORIZATION TO PERFORM TEST PROCEDURE
A4W/A1G 3-KA-9 REV D DTD 5-6-86 IN REACTOR PLANT NR TWO.
2. THE REACTOR CORE IS INSTALLED IN (SHIP NAME) REACTOR NR TWO AS SPECIFIED BY REF C.
3. (SHIPBUILDER) HAS CERTIFIED THAT ALL PREREQS FOR NR TWO PLANT INITIAL CRITICALITY
REQD BY REF D ARE MET.
4. THE PCO, (SHIP NAME) AND NRRO CONCUR THAT THE NUCLEAR PROPULSION PLANT NR TWO
IS READY FOR INITIAL CRITICALITY AND SUBSEQUENT POWER RANGE TESTING.
5. ALL OUTSTANDING WORK ITEMS HAVE BEEN RESOLVED BY REFS E AND F.
6. ESTIMATE (SPECIFIED) DAYS WILL BE REQUIRED TO PERFORM CRITICALITY AND POWER
RANGE TESTING OF NR TWO PLANT. REQ A MAX OF (SPECIFIED) EFPH BE AUTHORIZED.
7. THIS EVENT IS SKED FOR (TIME (LOCAL)) AND (DATE).//
BT

**NOTE: ENSURE MESSAGES ARE IN ACCORDANCE WITH CURRENT MESSAGEFORMAT AND
CURRENT PLAD IS UTILIZED.**

NOFORN when filled in

APPENDIX E₂
SAMPLE SUPERVISING AUTHORITY
TO NAVSEA REQUEST FOR
INITIAL CRITICALITY

From: (Supervising Authority), USN, (Location)

To: Commander, Naval Sea Systems Command (08)

Subj: AUTHORIZATION REQUEST FOR (Ship Name and Hull No.) INITIAL CRITICALITY

Ref: (a) (Plant Type) Initial Criticality Prerequisite List

(b) COMNAVSEASYSKOM letter Ser (Serial Number and Date)

1. Request authorization required by reference (a) to perform test procedure with TPI incorporated.
2. The reactor core installed in (Ship Name and Hull No.) as specified in reference (b).
3. Estimated time to perform all critical testing is __ days. All critical testing will require a maximum of __ effective full power hours. This estimate includes Critical Over-the-Side-Noise testing.
4. The shipyard has certified that all the prerequisites for Initial Criticality required by reference (a) are met and the ship is ready for Initial Criticality and subsequent Power Range Testing.
5. The following reactor plant work item(s) is (are) not completed and does (do) not involve safety of the reactor plant.
 - a.
 - b.
6. The Prospective Commanding Officer and Naval Reactors Representative concur.
7. The event is scheduled for (Date) at (Time).

(Signature)

Copy to:

PCO (Ship Name and Hull No.)

NRRO (Location)

TYCOM (N43)(N9 for CVN)

ISIC

APPENDIX E₃

**SAMPLE NAVSEA TO SUPERVISING AUTHORITY MESSAGE
AUTHORIZING CRITICALITY**

FM COMNAVSEASYS COM WASHINGTON DC//
TO (SUPERVISING AUTHORITY)//
INFO CNO WASHINGTON DC//
(FLEET COMMANDER)//
(TYCOM)//N43/N9 (FOR CVN)//
(ISIC)//
NRRO (LOCATION)//
(PARENT GROUP)//
(PARENT SQUADRON)//
PCO (SHIP NAME AND HULL NO.)//
BT
UNCLAS NOFORN//N09210//
MSGID/GENADMIN/COMNAVSEASYS COM//
SUBJ: INITIAL CRITICALITY OF REACTOR NO. 2 IN (SHIP NAME AND HULL NO.)//
REF/A/MSG/(ORIGINATING ACTIVITY)/(DTG)//
AMPN/REF A IS SUPERVISING AUTHORITY MESSAGE REQUESTING AUTHORIZATION FOR
CRITICALITY//
REF/B/DOC/(PLANT TYPE) TEST PROCEDURE (NUMBER SPECIFIED)//
AMPN/REF B IS TEST PROCEDURE FOR INITIAL APPROACH TO CRITICALITY//
RMKS/1. REF A CERTIFIES THAT ALL PREREQUISITES REQUIRED BY REF B FOR INITIAL
CRITICALITY OF REACTOR NO. 2 IN (SHIP NAME) HAVE BEEN MET. REF A REQUESTS NAVSEA
AUTHORIZATION REQUIRED BY REF B TO CONDUCT INITIAL CRITICAL OPERATIONS OF REACTOR
NO. 2 IN (SHIP NAME). REF A ESTIMATES (SPECIFIED) EFPH NECESSARY TO CONDUCT INITIAL
CRITICALITY AND SUBSEQUENT POWER RANGE TESTING.
2. BASED ON THE STATEMENTS CONTAINED IN REF A, YOU ARE AUTHORIZED TO PROCEED WITH
INITIAL CRITICALITY AND POWER RANGE TESTING OF REACTOR NO. 2 IN (SHIP NAME) IN
ACCORDANCE WITH APPROVED PROCEDURES, FOR A MAXIMUM OF (SPECIFIED) EFPH.//
BT

**NOTE: ENSURE MESSAGES ARE IN ACCORDANCE WITH CURRENT MESSAGE FORMAT AND
CURRENT PLAD IS UTILIZED.**

NOFORN when filled in

APPENDIX F

SAMPLE TYCOM MESSAGE CONCERNING SEA TRIAL AGENDA (SUBMARINES)

FM (TYCOM)//
TO (SUPERVISING AUTHORITY)//
PRECOMUNIT (SHIP NAME)//
INFO CNO WASHINGTON DC// /
(FLEET COMMANDER)//
COMNAVSEASYS COM WASHINGTON DC//(NAVY SHIPBUILDING PROGRAM MANAGER)/
UNSEARESCOM SAN DIEGO CA//
COMSUBRON ELEVEN//
(ISIC)//
(PARENT GROUP)//
(PARENT SQUADRON)//
BT
UNCLAS //N09094//
MSGID/GENADMIN/(TYCOM)//
SUBJ/(SUBS) (SHIP NAME AND HULL NO.) (TRIAL NAME) SEA TRIAL AGENDA//
REF/A/DOC/COMUSFLTFORCOMINST 4790.3//
AMPN/REF A IS JOINT FLEET MAINTENANCE MANUAL//
REF/B/LTR/(ORIGINATING ACTIVITY) (SERIAL NUMBER)/(DATE)/NOTAL//
AMPN/REF B IS (SUPERVISING AUTHORITY) FIRST ENDORSEMENT TO (SHIPBUILDER) LTR (SERIAL/DATE)//
SUBJ: (SHIPBUILDER) (SHIP NAME AND HULL NO.) (TRIAL) UNDERWAY SEA TRIAL AGENDA, REV (-)//
RMKS/1. IAW REF A, ORIG CONCURS WITH THE OPERATIONAL ASPECTS OF REF B SEA TRIAL
AGENDA.
2. FOR OIC (SHIP NAME AND HULL NO.): RECOGNIZING LIMITED UNDERWAY OPERATIONAL
EXPERIENCE LEVEL, EXERCISE EXTREME CAUTION WHILE CONDUCTING ALL OPERATIONS AT
TEST DEPTH. ENSURE YOUR SHIP CONTROL PARTIES ARE WELL VERSED IN ALL ASPECTS OF
SHIP'S COMPENSATION AND EFFECTS OF SPEED AND TRIM ADJUSTMENTS, AS WELL AS
PROCEDURES TO PREVENT EXCEEDING TEST DEPTH.//
BT
**NOTE: ENSURE MESSAGES ARE IN ACCORDANCE WITH CURRENT MESSAGE FORMAT AND
CURRENT PLAD IS UTILIZED.**

(This Page Intentionally Left Blank)

APPENDIX G

SAMPLE TYCOM SRDRS SUPPORT SERVICES MESSAGE (SUBMARINES)

FM (TYCOM)//
 TO COMSUBRON ELEVEN//
 (SUPERVISING AUTHORITY)//(IF SUBSIG II USED)
 (COMSUB SQD/GRP (ISIC))//
 USS (SHIP NAME)//(MOSUB)
 USS (SHIP NAME)//(ESCORT)(IF SUBSIG II NOT USED)
 INFO CNO WASHINGTON DC//
 COMNAVSEASYS COM WASHINGTON DC//(NAVY SHIPBUILDING PROGRAM MANAGER)/
 (FLEET COMMANDER)//
 COMSUBPAC PEARL HARBOR HI//
 COMSECONDFLT//
 COMNAVSURFLANT NORFOLK VA//
 COMNAVAIRLANT NORFOLK VA//
 (SUPERVISING AUTHORITY)//(RESPONSIBLE SHIPBUILDER)
 CTF TWO SIX//
 CTF TWO SIX PT ONE//
 NUWC DIV NEWPORT RI//
 NAVSEALOGCEN//
 UNSEARESCOM SAN DIEGO CA//
 NAVUNSEAWARCENDIV NEWPORT RI//
 NAVUNSEAWARCENDET WEST PALM BEACH FL//
 NAVUNSEAWARCENDET AUTC ANDROS ISLAND BAHAMAS//
 NAVSURFWARCEN CARDEROCKDIV BETHESDA MD//
 PEOSUBCBTWPNSYS WASHINGTON DC//
 COMSUBRON (SPECIFY)//(STRL UNIT)
 COMSUBRON (SPECIFY)//(MOSUB)
 (STRL UNIT)//
 BT
 UNCLAS //N03120//
 MSGID/GENADMIN/(TYCOM)//
 SUBJ/(SUBS) SUBMARINE SEA TRIAL SUPPORT SERVICES//
 REF/A/MSG/(ORIGINATING ACTIVITY)/(DTG)//
 AMPN/REF A IS SUPERVISING AUTHORITY/RESPONSIBLE SHIPBUILDER SEA TRIAL SUPPORT
 REQUEST//
 REF/B/LTR/(ORIGINATING ACTIVITY) (SERIAL NUMBER)/(DATE)//
 AMPN/REF B IS CNO LETTER CONCERNING SEA TRIALS//
 REF/C/DOC/COMUSFLTFORCOMINST 4790.3//
 AMPN/REF C IS JOINT FLEET MAINTENANCE MANUAL//
 REF/D/TEL/COMSUBLANT/(DD MM YY)//(CONFIRMING STRL SCHEDULE)
 AMPN/REF D IS TELCON BETWEEN (ORIGINATOR ACTIVITY)/(PERSON'S NAME) AND (CALLED
 ACTIVITY)/(PERSON'S NAME) OR (SUPERVISING AUTHORITY)(SUBSIG II)//
 RMKS/1. IRT REF A AND IAW REF B THROUGH D, THE FOLLOWING ASSIGNMENTS APPLY FOR (STRL
 UNIT NAME AND HULL NO.) SEA TRIALS OCCURRING PD: (DD-DDMMM) (ALPHA 70% TD) AND (DD-DDMMM)
 (BRAVO 100% TD).

- A. SRDRS SUPPORT SHIP - USS
- B. RESCUE PORT -
- C. RESCUE PORT REPRESENTATIVE -
- D. RESCUE AIRFIELD -
- E. MOORING SUPPORT SHIP -
- F. GOLD DOLPHIN OBSERVER -
- G. ESCORT VESSEL -
- H. TYCOM EMBARKED REP -

FOR COMSUBRON ELEVEN:

REQUEST SRDRS BE PLACED IN MOD-ALERT STATUS TO SUPPORT SEA TRIALS FOR USS (STRL UNIT NAME AND HULL NO.) ON (DD-DDMMM). IT IS ANTICIPATED THAT ESCORT SERVICES AND SRDRS MOD-ALERT STATUS WILL BE REQUIRED THROUGH (DD-DDMMM).

3. FOR (STRL UNIT),

A. INCLUDE THE FOLLOWING INFO ADDEES ON FINAL TEST DEPTH DEEP DIVE CHECK REPORT: COMSUBPAC PEARL HARBOR HI, COMSUBRON ELEVEN, AND UNSEARESCOM SAN DIEGO CA.

B. ONCE ESCORT, SRDRS SERVICES ARE NO LONGER REQUIRED, RELEASE IAW ISIC OPS DIRECTIVE.

4. DIRLAUTH ALCON FOR EVENT SCHEDULES AND SCHEDULE CHANGES.//

BT

NOTE: ENSURE MESSAGES ARE IN ACCORDANCE WITH CURRENT MESSAGEFORMAT AND CURRENT PLAD IS UTILIZED.

APPENDIX H

SAMPLE TYCOM MESSAGE TO PCU CONCERNING USE OF THE FBW SCS IN SUPPORT OF ALPHA SEA TRIALS (SUBMARINES)

FROM: COMSUB<LANT/PAC><NORFOLK VA/PEARL HARBOR HI>//
TO: PRECOMUNIT <SHIP NAME>//
INFO CNO WASHINGTON DC
COMNAVSEASYS COM WASHINGTON DC
COM<LANT/PAC>FLT<NORFOLK VA/PEARL HARBOR HI>
<DIRSSP WASHINGTON DC FOR SSBN/SSGN>
COMSUBGRU <NO.>
COMSUBRON <NO.>
<SUPERVISING AUTHORITY>
BT
UNCLAS // N09094 //
MSGID/GENADMIN/COMSUB<LANT/PAC>//
SUBJ/(SUBS) PRECOMUNIT <SHIP NAME/HULL NO.> AUTHORIZATION TO USE THE FLY-BY-WIRE SHIP CONTROL SYSTEM IN SUPPORT OF ALPHA SEA TRIALS//
REF/A/MSG/COMNAVSEASYS COM/<DTG>// {G.2.2}
REF/B/MSG/<SUPERVISING AUTHORITY>/<DTG>//{G.2.3}
REF/C/LTR/COMSUB<LANT/PAC>/<SER NO./DATE>//
REF/D/LTR/NAVSEA/<SER NO./DATE>//
REF /E/LTR NAVSEA SERNO./DATE
NARR/REF A IS NAVSEA FLY-BY-WIRE SHIP CONTROL SYSTEM MATERIAL CONDITION READINESS REPORT AND ALPHA SEA TRIALS RECOMMENDATION FOR <SHIP NAME/HULL NO.>. REF B IS <SUPERVISING AUTHORITY> REPORT OF FAST CRUISE COMPLETION AND READINESS OF FLY-BY-WIRE SHIP CONTROL SYSTEM FOR ALPHA SEA TRIALS. REF C CONCURRED WITH THE SEA TRIALS AGENDA. REF D APPROVED THE SEA TRIALS AGENDA.//
RMKS/1. REF A CERTIFIED THE FLY-BY-WIRE SHIP CONTROL SYSTEM MATERIAL CONDITION OF <SHIP NAME/HULL NO.> SATISFACTORY FOR ALPHA SEA TRIALS.
2. REF B REPORTED SUCCESSFUL COMPLETION OF FAST CRUISE AND READINESS OF FLY-BY-WIRE SHIP CONTROL SYSTEM FOR ALPHA SEA TRIALS.
3. <SHIP NAME/HULL NO.> FLY-BY-WIRE SHIP CONTROL SYSTEM USE IS AUTHORIZED IN SUPPORT OF ALPHA SEA TRIALS IAW THE ALPHA SEA TRIALS AGENDA CONCURRED IN BY REF C AND APPROVED BY REF D. THERE ARE NO FLY-BY-WIRE SHIP CONTROL SYSTEM or SHIP RELATED OPERATING RESTRICTIONS/LIMITS WHICH HAVE NOT BEEN SATISFIED. <or identify operating restrictions/limits>//
4. THIS CERTIFICATION IS VALID THROUGHOUT TRIALS UNLESS A DEFICIENCY HAS BEEN DISCOVERED. SHIP SPEED IS RESTRICTED TO LESS THAN 20 KNOTS WHEN A FBW SCS FAULT CONDITION RESULTS IN A MAJOR NON-CONFORMANCE AFFECTING CONTROL OF SHIPS PITCH, HEADING, DEPTH OR CONTROL SURFACES. THESE DEFICIENCIES MUST BE REPORTED TO NAVSEA AND THE APPROPRIATE FLEET AND TYPE COMMANDERS. PREVIOUS NAVSEA CERTIFICATION OF THE FBW SCS MATERIAL CONDITION SHALL BE SUSPENDED UNTIL NAVSEA REVIEWS THE REPORT AND CERTIFIES TO THE TYCOM THAT THE FBW SCS MATERIAL CONDITION IS SATISFACTORY FOR SEA TRIALS IN ACCORDANCE WITH THE SEA TRIAL AGENDA APPROVED BY REFERENCE D. THE SHIP'S SPEED IS RESTRICTED TO LESS THAN 20 KNOTS UNTIL SATISFACTORY RESOLUTION OF THE MAJOR NON-CONFORMANCE AND TYCOM APPROVAL TO OPERATE THE FBW SCS TO PREVIOUSLY AUTHORIZED CONDITIONS IS GRANTED, UNLESS SPECIFICALLY ADDRESSED IN THE SEA TRIAL AGENDA.
BT

NOTE: ENSURE MESSAGES ARE IN ACCORDANCE WITH CURRENT MESSAGE FORMAT AND CURRENT PLAD IS UTILIZED.

(This Page Intentionally Left Blank)

APPENDIX I

SAMPLE TYCOM MESSAGE TO PCU CONCERNING FBW SCS MATERIAL CONDITION INITIAL CERTIFICATION (SUBMARINES)

FROM: COMSUB<LANT/PAC><NORFOLK VA/PEARL HARBOR HI>//
 TO: PRECOMUNIT <SHIP NAME>//
 INFO CNO WASHINGTON DC
 COMNAVSEASYS COM WASHINGTON DC
 COM<LANT/PAC>FLT<NORFOLK VA/PEARL HARBOR HI>
 <DIRSSP WASHINGTON DC FOR SSBN/SSGN>
 COMSUBGRU <NO.>
 COMSUBRON <NO.>
 <SUPERVISING AUTHORITY>
 BT
 UNCLAS // N09094 //
 MSG/GENADMIN/COMSUB<LANT/PAC>//
 SUBJ/(SUBS) UNRESTRICTED USE OF PRECOMUNIT <SHIP NAME/HULL NO.> FLY-BY-WIRE SHIP CONTROL SYSTEM IN SUPPORT OF SUBMARINE UNRESTRICTED OPERATION//
 REF/A/DOC/NAVSEA T9044-AD-MAN-010//
 REF/B/MSG/NAVSEA/<DTG>// {G.2.7}
 NARR/REF A IS THE REQUIREMENTS MANUAL FOR SUBMARINE FLY-BY-WIRE SHIP CONTROL SYSTEMS. REF B IS THE NAVSEA MSG FOR UNRESTRICTED USE OF <SHIP NAME/HULL NO.> FLY-BY-WIRE SHIP CONTROL SYSTEM IN SUPPORT OF SUBMARINE UNRESTRICTED OPERATION.//
 RMKS/1. IAW REF A, REF B CERTIFIED THAT THE FLY-BY-WIRE SHIP CONTROL SYSTEM MATERIAL CONDITION OF <SHIP NAME/HULL NO.> IS SATISFACTORY AND RECOMMENDED UNRESTRICTED USE OF <SHIP NAME/HULL NO.> FLY-BY-WIRE SHIP CONTROL SYSTEM IN SUPPORT OF SUBMARINE UNRESTRICTED OPERATIONS.
 2. <SHIP NAME/HULL NO.> IS AUTHORIZED UNRESTRICTED USE OF THEIR FLY-BY-WIRE SHIP CONTROL SYSTEM IN SUPPORT OF SUBMARINE UNRESTRICTED OPERATION SUBJECT TO THE FOLLOWING RESTRICTIONS: <list restrictions if they exist or state "NONE">
 3. CONTINUED CERTIFICATION FOR UNRESTRICTED USE OF THE FLY-BY-WIRE SHIP CONTROL SYSTEM IN SUPPORT OF SUBMARINE UNRESTRICTED OPERATION IS SUBJECT TO COMPLIANCE WITH REF A.
 4. RECOMMENDATION FOR SHIP'S UNRESTRICTED OPERATION TO TEST DEPTH WILL BE ADDRESSED BY SEPARATE CORRESPONDENCE.
 BT
NOTE: ENSURE MESSAGES ARE IN ACCORDANCE WITH CURRENT MESSAGE FORMAT AND CURRENT PLAD IS UTILIZED.

(This Page Intentionally Left Blank)

APPENDIX J**SAMPLE TYCOM MESSAGE TO THE SHIP CONCERNING FBW SCS CERTIFICATION
(SUBMARINES)**

FROM: COMSUB<LANT/PAC><NORFOLK VA/PEARL HARBOR HI>//
 TO: UNIT <SHIP NAME>//
 INFO CNO WASHINGTON DC
 COMNAVSEASYS COM WASHINGTON DC
 COM<LANT/PAC>FLT<NORFOLK VA/PEARL HARBOR HI>
 <DIRSSP WASHINGTON DC FOR SSBN/SSGN>
 COMSUBGRU <No.>
 COMSUBRON <No.>
 <SUPERVISING AUTHORITY>
 BT
 UNCLAS // N09094 //
 MSG/GENADMIN/COMSUB<LANT/PAC>//
 SUBJ/(SUBS) UNRESTRICTED USE OF FLY-BY-WIRE SHIP CONTROL SYSTEM IN SUPPORT OF
 UNRESTRICTED OPERATIONS OF UNIT <SHIP NAME/HULL NO.>//
 REF/A/DOC/NAVSEA T9044-AD-MAN-010//
 REF /B/MSG NAVSEA/DTG // FBW SCS INITIAL CERTIFICATION (G.2.9)
 REF//C/ SSM VOLUME 7
 NARR/REF A IS THE REQUIREMENTS MANUAL FOR SUBMARINE FBW SCS. REF B IS NAVSEA FBW
 SCS CERTIFICATION MSG FOR <SHIP NAME/HULL NO.>. REF C CONTAINS COMSUB<LANT/PAC>
 AUTHORIZED SUBMARINE OPERATING AND TEST DEPTHS.//
 1. IN ACCORDANCE WITH REFERENCE (A), REFERENCE (B) PROVIDED <INTERIM FOR FIRST SHIP
 OF CLASS OR AFTER MAJOR SHIP MODIFICATION AFFECTING SHIP HYDRODYNAMIC
 CHARACTERISTICS> CERTIFICATION OF <SHIP NAME/HULL NO.> FLY-BY-WIRE SHIP CONTROL
 SYSTEM FOR UNRESTRICTED USE IN SUPPORT OF SUBMARINE UNRESTRICTED OPERATIONS <OR
 STATE LIMITS>.
 BT
**NOTE: ENSURE MESSAGES ARE IN ACCORDANCE WITH CURRENT MESSAGE FORMAT AND
 CURRENT PLAD IS UTILIZED.**

(This Page Intentionally Left Blank)

APPENDIX K

**SAMPLE SUPERVISING AUTHORITY MESSAGE TO NAVSEA CONCERNING PCU FBW SCS
MATERIAL CONDITION READINESS FOR FAST CRUISE AND ALPHA TRIALS (SUBMARINES)**

FROM: <SUPERVISING AUTHORITY>//-+
 TO: COMNAVSEASYS COM WASHINGTON DC//
 INFO CNO WASHINGTON DC
 COMSUB<LANT/PAC>FLT<NORFOLK VA/PEARL HARBOR HI>
 COM<LANT/PAC>FLT<NORFOLK VA/PEARL HARBOR HI>
 COMSUBGRU <NO.>
 COMSUBRON <NO.>
 PRECOMUNIT <SHIP NAME>
 BT
 UNCLAS // N09094 //
 MSGID/GENADMIN/<SUPERVISING AUTHORITY>//
 SUBJ/(SUBS) PRECOMUNIT <SHIP NAME/HULL NO > FLY-BY-WIRE SHIP CONTROL SYSTEM MATERIAL
 CONDITION READINESS FOR FAST CRUISE AND SEA TRIALS//
 REF/A/DOC/NAVSEA T9044-AD-MAN-010 //
 REF/B/LTR/NAVSEA/<SER NO./DATE>// (REFERENCE ADDITIONAL AUDIT REPORTS AS REQUIRED)
 NARR/REF A IS THE REQUIREMENTS MANUAL FOR SUBMARINE FLY-BY-WIRE SHIP CONTROL
 SYSTEMS. REF B IS THE NAVSEA FLY-BY-WIRE SHIP CONTROL SYSTEM CERTIFICATION AUDIT
 REPORT FOR <SHIP NAME/HULL NO.>.///
 RMKS/1. IAW REF A, <SUPERVISING AUTHORITY> REPORTS THE COMPLETION OF ALL FLY-BY-WIRE
 SHIP CONTROL SYSTEM WORK AND TESTING REQUIRED FOR COMMENCEMENT OF FAST CRUISE
 AND ALPHA SEA TRIALS.
 2. IAW REF A, <SUPERVISING AUTHORITY> REPORTS THAT ALL CAT I AUDIT RECOMMENDATIONS OF
 REF B HAVE BEEN SATISFACTORILY RESOLVED. THERE ARE NO FLY-BY-WIRE SHIP CONTROL
 SYSTEM DEVIATIONS AND WAIVERS WITH CONDITIONS NOR FLY-BY-WIRE SHIP CONTROL
 SYSTEM OR RELATED SHIP OPERATING RESTRICTIONS/LIMITS WHICH HAVE NOT BEEN
 SATISFIED. <or identify operating restrictions/limits and list conditional Deviations and Waivers including Deviation Number, Short Title,
 and Expected Clearance Date/Key Event⁽¹⁾>.
 3. IAW REF A, THE STATUS OF ALL INCOMPLETE CAT 1A AUDIT RECOMMENDATIONS OF REF B IS
 AS FOLLOWS:
 A.
 B.
 4. <SUPERVISING AUTHORITY> REPORTS READINESS OF <SHIP NAME/HULL NO.> FLY-BY-WIRE SHIP
 CONTROL SYSTEM FOR COMMENCEMENT OF FAST CRUISE. OIC<SHIP NAME/HULL NO.> CONCURS.//
 5. SUBJECT TO SATISFACTORY COMPLETION OF FAST CRUISE AND RESOLUTION OF MANDATORY
 DEFICIENCIES, <SUPERVISING AUTHORITY> CONSIDERS <SHIP NAME/HULL NO.> FLY-BY-WIRE SHIP
 CONTROL SYSTEM MATERIAL CONDITION READINESS SATISFACTORY FOR COMMENCEMENT OF
 SEA TRIALS.
⁽¹⁾ Subject to Navy Shipbuilding Program Manager approval, cumulative lists of conditional Deviations and Waivers which are deemed too lengthy
 for messages may be communicated in a letter format, with the letter referenced by the applicable message.
 BT

**NOTE: ENSURE MESSAGES ARE IN ACCORDANCE WITH CURRENT MESSAGE FORMAT AND
CURRENT PLAD IS UTILIZED.**

(This Page Intentionally Left Blank)

APPENDIX L

**SAMPLE SUPERVISING AUTHORITY MESSAGE TO TYCOM AND NAVSEA CONCERNING PCU
FAST CRUISE COMPLETION AND READINESS OF FBW SCS MATERIAL CONDITION FOR ALPHA
SEA TRIALS (SUBMARINES)**

FROM:<SUPERVISING AUTHORITY>//
 TO: COMSUB<LANT/PAC><NORFOLK VA/PEARL HARBOR HI>//
 COMNAVSEASYS COM WASHINGTON DC
 INFO CNO WASHINGTON DC
 COM<LANT/PAC>FLT<NORFOLK VA/PEARL HARBOR HI>
 <DIRSSP WASHINGTON DC FOR SSBN/SSGN>
 COMSUBGRU <NO.>
 COMSUBRON <NO.>
 PRECOMUNIT <SHIP NAME/NUMBER>
 BT
 UNCLAS // N09094 //
 MSGID/GENADMIN/<SUPERVISING AUTHORITY>//
 SUBJ/(SUBS) PRECOMUNIT <SHIP NAME/HULL NO.> FAST CRUISE COMPLETION AND READINESS OF
 FLY-BY-WIRE SHIP CONTROL SYSTEM MATERIAL CONDITION FOR ALPHA SEA TRIALS//
 REF/A/DOC/OPNAVINST 9080.3//
 NARR/REF A CONTAINS PROCEDURES FOR TESTS AND TRIALS OF NAVAL NUCLEAR POWERED
 SHIPS.//
 RMKS/1. IAW REF A, <SUPERVISING AUTHORITY> REPORTS <SHIP NAME/HULL NO.> FAST CRUISE
 SUCCESSFULLY COMPLETED AT <TIME, DATE>.
 2. NO MANDATORY FLY-BY-WIRE SHIP CONTROL SYSTEM DEFICIENCIES FOR SEA TRIALS HAVE
 BEEN IDENTIFIED. THERE HAVE BEEN NO FLY-BY-WIRE SHIP CONTROL SYSTEM CWPs/RIPOUTs
 OPENED AND NO FLY-BY-WIRE SHIP CONTROL SYSTEM DEVIATIONS AND WAIVERS PROCESSED
 SINCE THE START OF FAST CRUISE. <or, report any mandatory deficiencies discovered with corrective action, and if
 CWP/RIPOUT and/or Deviations and Waivers were processed since the start of Fast Cruise, report all Fly-By-Wire Ship Control System
 CWPs/RIPOUTs opened since the start of Fast Cruise are closed and/or all Fly-By-Wire Ship Control System deviations and waivers resolved.>
 3. THERE ARE NO FLY-BY-WIRE SHIP CONTROL SYSTEM DEVIATIONS AND WAIVERS WITH
 CONDITIONS WHICH HAVE NOT BEEN SATISFIED. <or list conditional Deviations and Waivers including
 Deviation Number, Short Title, and Expected Clearance Date/Key Event.⁽¹⁾>.
 4. FLY-BY-WIRE SHIP CONTROL SYSTEM MATERIAL CONDITION IS SATISFACTORY TO SUPPORT
 COMMENCEMENT OF ALPHA SEA TRIALS AS SCHEDULED. OIC <SHIP NAME/HULL NO.> CONCURS.\\
 5. RECOMMENDATION TO COMMENCE ALPHA SEA TRIALS WILL BE ADDRESSED BY SEPCOR.
⁽¹⁾Subject to Navy Shipbuilding Program Manager approval, cumulative lists of conditional Deviations and Waivers which are deemed too lengthy for
 messages may be communicated in a letter format, with the letter referenced by the applicable message.
 BT

**NOTE: ENSURE MESSAGES ARE IN ACCORDANCE WITH CURRENT MESSAGE FORMAT AND
CURRENT PLAD IS UTILIZED.**

(This Page Intentionally Left Blank)

APPENDIX M

**SAMPLE SUPERVISING AUTHORITY MESSAGE TO NAVSEA CONCERNING PCU FBW SCS
MATERIAL CONDITION READINESS UPON COMPLETION OF ALPHA SEA TRIALS AND
READINESS OF THE FBW SCS FOR USE DURING BRAVO AND SUBSEQUENT SEA TRIALS
(SUBMARINES)**

FROM:<SUPERVISING AUTHORITY>//
 TO: COMNAVSEASYS COM WASHINGTON DC//
 INFO CNO WASHINGTON DC
 COM<LANT/PAC>FLT<NORFOLK VA/PEARL HARBOR HI>
 <DIRSSP WASHINGTON DC FOR SSBN/SSGN>
 COMSUB<LANT/PAC><NORFOLK VA/PEARL HARBOR>
 COMSUBGRU <NO.>
 COMSUBRON <NO.>
 PRECOMUNIT <SHIP NAME>
 BT
 UNCLAS // N09094 //
 MSGID/GENADMIN/<SUPERVISING AUTHORITY>//
 SUBJ/(SUBS) COMPLETION OF <ALPHA(2)> SEA TRIALS OF PRECOMUNIT<SHIP NAME/HULL NO.> AND
 FLY-BY-WIRE SHIP CONTROL SYSTEM MATERIAL CONDITION READINESS FOR<BRAVO(1)> SEA
 TRIALS//
 REF/A/MSG/<SUPERVISING AUTHORITY>/<DTG>// {G.2.1}
 REF/B/LTR/NAVSEA/<SER NO./DATE>
 REF/C/DOC/NAVSEA 0924-062-0010//
 NARR/REF A IS <SUPERVISING AUTHORITY'S> REPORT OF FLY-BY-WIRE SHIP CONTROL SYSTEM
 MATERIAL CONDITION READINESS OF <SHIP NAME/HULL NO.> FOR FAST CRUISE AND ALPHA SEA
 TRIALS. REF B IS FLY-BY-WIRE SHIP CONTROL SYSTEM CERTIFICATION AUDIT REPORT.// REF C IS
 THE REQUIREMENTS MANUAL FOR SUBMARINE FLY-BY-WIRE SHIP CONTROL SYSTEMS.//
 RMKS/1. <SHIP NAME/HULL NO.> FLY-BY-WIRE SHIP CONTROL SYSTEM HAS SUCCESSFULLY
 COMPLETED <ALPHA(2)> SEA TRIALS.
 2. BY REF A, <SUPERVISING AUTHORITY> REPORTED ALL CAT I AUDIT RECOMMENDATIONS OF REF B
 SATISFACTORILY RESOLVED. THERE HAVE BEEN NO FLY-BY-WIRE SHIP CONTROL SYSTEM
 CWPS/RIPOUTS OPENED AND NO FLY-BY-WIRE SHIP CONTROL SYSTEM DEVIATIONS AND
 WAIVERS PROCESSED SINCE <ALPHA (2)> SEA TRIALS. <or, if FLY-BY-WIRE SHIP CONTROL SYSTEM
 CWPS/RIPOUTS or FLY-BY-WIRE SHIP CONTROL SYSTEM Deviations and Waivers were processed since the start of <ALPHA (2)> Sea
 Trials, report ALL FLY-BY-WIRE SHIP CONTROL SYSTEM CWPS/RIPOUTS OPENED SINCE THE START OF <ALPHA (2)> SEA
 TRIALS ARE CLOSED AND/OR ALL FLY-BY-WIRE SHIP CONTROL SYSTEM DEVIATIONS AND WAIVERS PROCESSED SINCE
 <ALPHA (2)> SEA TRIALS ARE RESOLVED.>.
 3. THERE ARE NO FLY-BY-WIRE SHIP CONTROL SYSTEM DEVIATIONS AND WAIVERS WITH
 CONDITIONS NOR FLY-BY-WIRE SHIP CONTROL SYSTEM or SHIP RELATED OPERATING
 RESTRICTIONS/LIMITS WHICH HAVE NOT BEEN SATISFIED. <or identify operating restrictions/limits and list
 conditional Deviations and Waivers including Deviation Number, Short Title, and Expected Clearance Date/Key Event.(3)>
 4. THE STATUS OF REF B INCOMPLETE CAT 1A AUDIT RECOMMENDATIONS IS <SAME AS
 REPORTED BY REF A OR AS FOLLOWS:>.
 5. IAW REF C, <SUPERVISING AUTHORITY> REPORTS THAT THE FLY-BY-WIRE SHIP CONTROL SYSTEM
 MATERIAL CONDITION OF <SHIP NAME/HULL NO.> IS SATISFACTORY FOR USE IN SUPPORT OF
 <BRAVO (1)> SEA TRIALS. OIC <SHIP NAME/HULL NO.> CONCURS.//
 (1)UPCOMING TRIALS WHICH IS SUBJECT OF THIS CERTIFICATION (E.G., BRAVO SEA TRIALS, CHARLIE SEA TRIALS, INSURV
 TRIALS, ETC.).
 (2)PREVIOUS TRIALS.
 (3)SUBJECT TO NAVY SHIPBUILDING PROGRAM MANAGER APPROVAL, CUMULATIVE LISTS OF CONDITIONAL DEVIATIONS
 AND WAIVERS WHICH ARE DEEMED TOO LENGTHY FOR MESSAGES MAY BE COMMUNICATED IN A LETTER FORMAT, WITH
 THE LETTER REFERENCED BY THE APPLICABLE MESSAGE.
 BT

**NOTE: ENSURE MESSAGES ARE IN ACCORDANCE WITH CURRENT MESSAGE FORMAT AND
CURRENT PLAD IS UTILIZED.**

(This Page Intentionally Left Blank)

APPENDIX N

SAMPLE SUPERVISING AUTHORITY MESSAGE TO NAVSEA CONCERNING PCU FBW SCS
MATERIAL CONDITION INITIAL CERTIFICATION (SUBMARINES)

FROM: <SUPERVISING AUTHORITY>//
TO: COMNAVSEASYS COM WASHINGTON DC//
INFO CNO WASHINGTON DC
COM<LANT/PAC>FLT<NORFOLK VA/PEARL HARBOR HI>
<DIRSSP WASHINGTON DC FOR SSBN/SSGN>
COMSUB<LANT/PAC><NORFOLK VA/PEARL HARBOR HI>
COMSUBGRU <NO.>
COMSUBRON <NO.>
PRECOMUNIT <SHIP NAME>
BT
UNCLAS // N09094 //
MSGID/GENADMIN/<SUPERVISING AUTHORITY>//
SUBJ/(SUBS) UNRESTRICTED USE OF <SHIP NAME/HULL NO.>FLY-BY-WIRE SHIP CONTROL SYSTEM IN
SUPPORT OF SUBMARINE UNRESTRICTED OPERATIONS//
REF/A/DOC/NAVSEA T9044-AD-MAN-010//
REF/B/MSG/<SUPERVISING AUTHORITY>/<DTG>/{G.2.1}
REF/C/LTR/NAVSEA/<SER NO./DATE>// (REFERENCE ADDITIONAL AUDIT REPORTS AS REQUIRED)
REF/D/ SHIP SYSTEM MANUAL VOL 7 SHIP CONTROL SYSTEMS
NARR/REF A IS THE REQUIREMENTS MANUAL FOR SUBMARINE FLY-BY-WIRE SHIP CONTROL
SYSTEMS. REF B IS <SUPERVISING AUTHORITY> REPORT OF <SHIP NAME/HULL NO.> READINESS OF FLY-
BY-WIRE SHIP CONTROL SYSTEM FOR FAST CRUISE AND ALPHA SEA TRIALS. REF C IS THE
NAVSEA FLY-BY-WIRE SHIP CONTROL SYSTEMS CERTIFICATION AUDIT REPORT FOR <SHIP
NAME/HULL NO.>. REF D IS THE SHIP SYSTEM MANUAL FOR FBW SCS.//
RMKS/1. IAW REF A, <SUPERVISING AUTHORITY> REPORTS THE SATISFACTORY COMPLETION OF ALL
FLY-BY-WIRE SHIP CONTROL SYSTEM SEA TRIAL TESTING, THE RESOLUTION OF MANDATORY
SEA TRIAL DEFICIENCIES<IF NOT RESOLVED THEN LIST ANY SEA TRIAL TEST EVENTS THAT NEED TO BE
DEFERRED>.
2. REF B REPORTED SATISFACTORY RESOLUTION OF ALL FBW SCS CAT I AUDIT
RECOMMENDATIONS OF REF C. IAW REF A, <SUPERVISING AUTHORITY> REPORTS THAT ALL CAT IA
AUDIT RECOMMENDATIONS OF REF C HAVE BEEN SATISFACTORILY RESOLVED. THERE IS NO
DEFERRED FBW SCS WORK AND THERE ARE NO FBW SCS DEVIATIONS AND WAIVERS WITH
CONDITIONS NOR ARE THERE ANY FBW SCS OR RELATED SHIP OPERATING RESTRICTIONS/LIMITS
WHICH HAVE NOT BEEN SATISFIED. <or identify operating restrictions/limits and list deferred work and/or conditional
Deviations and Waivers including Deviation Number, Short Title, and Expected Clearance Date/Key Event⁽¹⁾>.
3. THE STATUS OF INCOMPLETE CAT II AUDIT RECOMMENDATIONS OF REF C IS AS FOLLOWS:
A.
B.
4. IAW REF A, <SUPERVISING AUTHORITY> REPORTS THE MATERIAL CONDITION OF <SHIP NAME/HULL
NO.> FLY-BY-WIRE SHIP CONTROL SYSTEM IS SATISFACTORY FOR UNRESTRICTED USE IN
SUPPORT OF SUBMARINE UNRESTRICTED OPERATIONS IN ACCORDANCE WITH THE GUIDANCE IN
REF D EXCEPT AS NOTED:<identify any ship or system operating restrictions or limits>
5. RECOMMENDATION FOR SUBMARINE'S UNRESTRICTED OPERATION TO TEST DEPTH WILL BE
ADDRESSED BY SEPARATE CORRESPONDENCE.
⁽¹⁾Subject to Navy Shipbuilding Program Manager approval, cumulative lists of conditional Deviations and Waivers which are deemed too lengthy for
messages may be communicated in a letter format, with the letter referenced by the applicable message.

BT

**NOTE: ENSURE MESSAGES ARE IN ACCORDANCE WITH CURRENT MESSAGE FORMAT AND
CURRENT PLAD IS UTILIZED.**

(This Page Intentionally Left Blank)

APPENDIX O
PRE MAN-UP CHECKLIST FOR TYCOM/ISIC

The TYCOM/ISIC is responsible for the following:

1. Contacting the Supervising Authority and establishing the date of initial man-up.
2. Coordinating with the Supervising Authority to ensure that crew facilities will be available on man-up.
3. Coordinating with the Supervising Authority and BUPERS on manning issues involving slippage or delays in schedule.
4. Upon man-up, coordinating with the PCO the dates for arrival inspection and monitoring watches.
5. Providing the ship with the necessary Fleet/TYCOM directives, instructions, notices, training memorandums, etc.
6. Reporting personnel arriving early onboard.
7. Ensuring personnel arriving early get pay accounts established and entitlements started.
8. Ensuring personnel arriving early have been screened for New Construction and meet all the requirements. Personnel not meeting the New Construction requirements should be brought into compliance, if possible, or made available for further assignment in accordance with the Enlisted Transfer Manual.
9. Ensuring the reporting personnel satisfy the requirements as outlined in the manning directive (i.e., Crew Scheduling and Phasing plans, Manning Letter, Enlisted Distribution and Verification Report, etc.). Areas that are deficient should be identified to BUPERS to correct deficiencies. In the case of submarines, submit a Personnel Deficiency Report.
10. For submarines, ensuring personnel are medically screened for submarine duty.
11. If the Detachment Concept is used, establishing a Point of Contact with TSC and obtain phone numbers for PCU office spaces.
12. Inspecting the PCU's office spaces prior to the arrival of the initial manning detachment. Immediately upon the PCU's arrival, coordinating with the PCO to arrange for the certification of office spaces to receive classified material.
13. Providing the requirements for storage of classified material in office spaces.
14. Assisting the PCU in developing a management system for handling classified material.

(This Page Intentionally Left Blank)

APPENDIX P**BASIC REQUIREMENTS FOR INITIAL MAN-UP PERSONNEL OF THE PCU
(DETACHMENT CONCEPT) (AIRCRAFT CARRIERS AND SURFACE FORCE SHIPS)**

1. The following is a list of actions that should be undertaken by the Detachment within the first two months.
 - a. Establish Fiscal Account with TSC Logistics.
 - b. Provide accounting data for telephone service to Naval Station Public Works, Communications Department.
 - c. Establish Temporary Plain Language Address with the communications facility.
 - d. Obtain administrative supplies from SERVMART.
 - e. Make Basic Enlisted Quarters arrangements with Naval Station Billeting.
 - f. Establish Basic Enlisted Quarters Watch Bill.
 - g. Acquire Government Vehicle from Public Works.
 - h. Create Ship's Pre-Commissioning Indoctrination Manual.
 - i. Designate Drug and Alcohol Program Advisors and obtain school quota from TSC.
 - j. Designate Urinalysis Coordinator and establish program.
 - k. Designate Key Sub-Custodian.
 - l. Designate two Electrical Safety Petty Officers.
 - m. Designate Ombudsman.
 - n. Create/Start Pre-Commissioning Training schedule (Formal/School of the Ship/Afloat).
 - o. Establish program for monitoring security clearance requirements.
 - p. Write authorization letters for "By Direction," mail and paycheck pickup authority.
 - q. Acquire software programs from the ship's allowance for use on computers.
 - r. Set up office spaces and obtain the necessary instructions and publications necessary to function as an Administrative Office.
 - s. Establish a Personnel Office to assist/check-in newly reporting personnel.
 - t. Arrange a meeting with the local Personnel Support Detachment to formulate a memorandum of agreement to include Service Record maintenance, Pay Account maintenance, assignment of disbursing support personnel from the ship, liquidation of travel claims, authorization for travel advances and other personnel related matters.
 - u. Arrange for maintenance of Medical and Dental records based on local military medicine procedures. The TSC will provide details.
 - v. Compile a Recall List.
 - w. Submit the Inaugural Diary to establish the manpower accounts and activate the Unit Identification Code in the Source Data System. This will require the reporting of one Enlisted and one Officer, using a gain Transaction Code with the use of a Diary Message Reporting System message. This should be done in advance of the initial manning date.
 - x. Coordinate with the TSC to establish the Security Certification of office spaces for retention of classified material.
 - y. Request of NAVSEA Non-Judicial Punishment (NJP) and Special Court Martial authority for the PCO. If the PCO is ordered in as OIC, NJP authority is limited.

- z. Develop a planning schedule to incorporate Department Head training and the overall command planning schedule.
2. The following is a list of actions that must occur to support activity at the Construction Site.
- a. Obtain office space for the Prospective Commanding Officer/Prospective Executive Officer, Command Master Chief, and other crew personnel.
 - b. Arrange for installation and access to telephone service. The Supervising Authority will provide details.
 - c. Obtain phone listing for key Industrial Activity and Supervising Authority personnel.
 - d. Obtain Master Construction Schedule from the Supervising Authority Project Officer.
 - e. Make arrangements for the crew to receive badges for access to the industrial area.
 - f. Make arrangements for the crew to receive all necessary safety equipment (hard hats, safety glasses, safety shoes, etc.).
 - g. Arrange for the crew at the Construction Site to receive safety briefings.
 - h. Arrange for crew briefings on necessary Radiological Control procedures.
 - i. Arrange for the Supervising Authority to take action to add the PCU to the Standard Navy Distribution List.
 - j. Obtain copies of Supervising Authority instructions related to new construction activities.
 - k. Obtain a System Testing Schedule and Turnover Schedule. The Supervising Authority will provide assistance.
 - l. Request authorization for the crew to draw Basic Allowance for Subsistence if government messing is not available at the Construction Site. The BUPERS Manual provides direction.
 - m. Coordinate with the ISIC the Security Certification of office spaces to be used for the retention of classified material.

APPENDIX Q**BASIC REQUIREMENTS FOR INITIAL MAN-UP PERSONNEL OF THE PCU**

The following is a list of actions that should be undertaken upon the arrival of the first members of a PCU:

1. Obtain office space for the Prospective Commanding Officer/Prospective Executive Officer, Command Master Chief, and other crew personnel.
2. Arrange for installation and access to telephone service. The Supervising Authority will provide details.
3. Obtain phone listing for key Industrial Activity and Supervising Authority personnel.
4. Obtain Master Construction Schedule from the Supervising Authority Project Officer.
5. Make arrangements for the crew to receive badges for access to the industrial area.
6. Make arrangements for the crew to receive all necessary safety equipment (hard hats, safety glasses, safety shoes, etc.).
7. Arrange for the crew at the Construction Site to receive safety briefings.
8. Arrange for crew briefings on necessary Radiological Control procedures.
9. Arrange for the Supervising Authority to take action to add the PCU to the Standard Navy Distribution List.
10. Obtain copies of Supervising Authority instructions related to new construction activities.
11. Obtain a System Testing Schedule and Turnover Schedule. The Supervising Authority will provide assistance.
12. Request authorization for the crew to draw Basic Allowance for Subsistence, if government messing is not available at the construction site. The BUPERS Manual provides direction.
13. Request of NAVSEA NJP and Special Court Martial authority for the PCO. If the PCO is ordered in as OIC, NJP authority is limited.
14. Develop a planning schedule to incorporate Department Head training and the overall command planning schedule.
15. Submit the Inaugural Diary to establish the manpower account and activate the Unit Identification Code in the Source Data System. This will require the reporting of one Enlisted and one Officer, using a gain Transaction Code with the use of a Diary Message Reporting System message. This should be done in advance of the initial manning date.
16. Set up office spaces and obtain the necessary instructions and publications necessary to function as an Administrative Office.
17. Establish a Personnel Office to assist/check-in newly reporting personnel.
18. Arrange a meeting with the local Personnel Support Detachment to formulate a memorandum of agreement to include Service Record maintenance, Pay Account maintenance, assignment of disbursing support personnel from the ship, liquidation of travel claims, authorization for travel advances and other personnel related matters.
19. Arrange for maintenance of Medical and Dental records based on local military medicine procedures. The TSC will provide details.
20. Compile a Recall List.

21. Coordinate with the ISIC the Security Certification of office spaces to be used for the retention of classified material.
22. Upon completion of the Security Certification coordinate with the Supervising Authority mailroom for delivery of the ship's mail.

APPENDIX R**GENERIC BASE LINE OF FLEET INTRODUCTION TEAM
FUNCTIONS AND RESPONSIBILITIES**

1. Perform all tasks normally assigned to the PCO until the PCO has reported to the Construction Site and assumed duties.
2. Provide assistance to the PCO in carrying out duties according to Navy Regulations.
3. Provide continuity in the management and administration of pre-commissioning facilities at the Construction Site.
4. Coordinate the overall pre-commissioning crew training program for both nucleus and balance crews.
5. Schedule and conduct crew training at the Construction Site. Such training shall be structured to support the Force Commander's standard for Crew Certification. Additional training provided will consist of:
 - a. Basic Damage Control Training (100, 200 and 300 series).
 - b. Ship Familiarization Training.
 - c. Enlisted Surface/Aviation Warfare Specialist Qualification/Requalification Training.
6. Provide each ship with standardized tailored Lesson Training Guides (where appropriate) in the areas of:
 - a. Engineering.
 - b. Mess Specialist.
 - c. Supply.
 - d. Communications.
 - e. Operations.
 - f. Weapons.
 - g. Deck.
 - h. Air.
7. Provide each PCO with standardized administrative, organizational and procedural manuals, bills, and directives for the ship class.
8. Monitor the progress of construction, outfitting, test and trials of each ship.
9. Perform the specific functions as assigned by the Force Commander or higher authority.
10. Provide familiarization training if directed.
11. Provide continuity between successive PCUs.
 - a. Maintain results of significant trials, inspections, assist visits, design and progress meetings, etc., in order to provide lessons learned and a corporate history to each successive pre-commissioning crew.
 - b. Detailed reports of government and contractor material and operational tests and inspections are maintained by the Supervising Authority.
 - c. Develop a Plan of Action and Milestones (POAM) for each ship to support the mission objectives to consist of actions and milestones to be accomplished by the FIT and the ship before sailaway.
 - d. Tailor the POAM to each specific ship based on the delivery date. The POAM will start approximately one year before delivery and end upon sailaway. (Start date will vary depending on FIT establishment and crew manning).
 - e. Maintain copies of the POAMs at the FIT, PCU and Pre-Commissioning Detachment.
 - f. Update and perform quarterly reviews of the POAM.

12. Maintain a Standard Products POAM.

- a. Ensure that each ship receives their initial outfit of standard products such as directives, publications, forms, instructions, charts, etc. These products will be ordered by the FIT in accordance with the POAM, maintained at the FIT, and given to ship upon delivery.
- b. In addition, locally developed standard administrative products such as the Standard Organization and Regulations Manual, Standard Operating Procedures, instructions, notices, etc., in support of the mission goals, will be tailored to each specific ship by the FIT with Ship's Force assistance.

13. Conduct Familiarization Training.

- a. Training will consist of lectures and ship tours which cover:
 - Ship Capabilities
 - Characteristics and Mission
 - Damage Control
 - Propulsion
 - Electrical
 - Auxiliaries
 - Deck
 - Communications
 - Navigation
 - Combat Systems
- b. Familiarization Training will be performed in a manner that will also encompass Enlisted Surface/Aviation Warfare Specialist qualification/requalification training.
- c. Provide each student a detailed and comprehensive Training Guide of each topic, for reference and study purposes.

14. Assist the ship in preparations for LOA to include:

- a. Assist in preparations for the ISIC and ETG visits (Pre-industrial, Industrial and Pre-LOA) to include the areas of administration, material, level of knowledge and firefighting.
- b. Provide plans (in the form of ship's notices) for the Pre-Industrial and Pre-LOA visits.
- c. Assist in EOSS validation (cold and hot checks to include hand over hand verification of piping systems and components) performed by the Navy Shipbuilding Program Manager.
- d. Provide a standard package of cold and hot checks (schedule and procedures) required to support material checks for LOA. Conduct training in the execution of cold and hot checks.
- e. Provide standard engineering administration (EDORM, Standing Orders, Main Space Fire Doctrine, Restricted Maneuvering Doctrine, logs, management programs, etc.).
- f. Provide a standard ship engineering training plan which will include Lesson Topic Guides, Lesson Topic Matrix, Evolution Training Matrix, Casualty Control Training Matrix, Watch Team Replacement Plan, Quadrant Training Plan, Month Training Plan and Watchstander Proficiency Logs. Conduct training on implementation and execution of the engineering training plan.
- g. Conduct training (lectures, seminars, drills, etc.) to improve the level of knowledge and firefighting capability of the crew in support of LOA. Conduct Damage Control training to combat a Main Space Fire. Provide procedures, drill packages and training for the Engineering Casualty Control Training Team and Damage Control Training Team.

15. Assist the ship in preparations for Crew Certification to include:
 - a. Provide plans (in the form of ship's notices) for Crew Certification.
 - b. Provide procedures, drill packages and training (lectures, seminars, drills, etc.) for the Seamanship Training Team and Combat Systems Training Team.
16. Assist with the implementation of PMS to include:
 - a. Provide training to the ship's 3-M Coordinator concerning ship specific/unique PMS, Waterfront Maintenance Management System Net and/or SNAP.
 - b. Assist in Phase I and II PMS installation by local RMC.
17. Order forms and publications.
 - a. Order in accordance with the ship POAM and turn over to the crew upon delivery of the ship.
 - b. Include Initial Outfit List of publications and forms as well as Technical Manuals, SIBs, Naval Warfare Publications, Naval Telecommunication Procedures (NTP), charts, command-specific instructions and notices, etc.
18. Assist the ship in the load out of storerooms and operating spaces to include:
 - a. Assist in developing load out plan.
 - b. Assist in the coordination between ship, Supervising Authority, contractor and FOSSAC.
 - c. Act as technical advisor to the Supply Officer in matters concerning load out.
 - d. Provide training to Supply Department personnel in support of load out.
19. Maintain a reference library.
 - a. A master reference library will be located in the FIT building and will include general and ship specific directives, forms, publications, instructions, notices, Technical Manuals, PQS, Naval Warfare Publications, NTPs, SIBs, charts, EOSS, PMS, message correspondence, etc.
 - b. A satellite reference library will be located within the pre-commissioning building. This library will consist of immediate reference materials, Naval Ships' Technical Manuals, SIBs, Technical Manuals, instructions and notices.
 - c. A basic set of unclassified reference material will be maintained at the PCU for the pre-commissioning crews. Classified reference material for the pre-commissioning crews will be maintained at the FIT facilities due to the lack of adequate security at the PCU.
 - d. Liaison with the Supervising Authority to obtain technical documents such as contract specifications, drawings, test and inspection results, etc. when required.
 - e. Provide access to various electronic bulletin boards throughout the Navy via computer-modem hookup.
20. Provide audio/visual support consisting of projectors (overhead, slide), screen, video cassette recorder (VHS, BETA), and marker boards.
21. Provide situational administrative support as required.
 - a. Provide supplemental administrative support for events such as LOA, Crew Certification, Commissioning, etc.
 - b. Support may include word processing as well as E-mail, laminating, fax and copier service.
22. Maintain communication guard for PCUs until delivery.
 - a. Assist PCU Radiomen in processing (receiving and transmitting) standard naval messages up to and including Secret.
 - b. Locate the GATEGUARD terminals in the classified material storeroom at the FIT.

23. Provide secure stowage for classified material.
 - a. Store classified material for the FIT and PCU in General Services Administration approved safes located in the FIT's facilities.
 - b. Restrict access to those personnel authorized by the OIC/PCO.
 - c. Maintain security through a combination of General Services Administration approved storage containers, controlled access (key and cipher locks) and intrusion detection systems.
24. Coordinate off-site training such as schools for pre-commissioning crew between the Ship, BUPERS and Navy Shipbuilding Program Manager.

APPENDIX S

SAMPLE NAVSEA MESSAGE TO TYCOM CONCERNING PCU FBW SCS MATERIAL CONDITION
READINESS FOR ALPHA SEA TRIALS (SUBMARINES)

FROM: COMNAVSEASYS COM WASHINGTON DC//
TO: COMSUB<LANT/PAC><NORFOLK VA/PEARL HARBOR HI>//
INFO CNO WASHINGTON DC
COM<LANT/PAC>FLT<NORFOLK VA/PEARL HARBOR HI>
<DIRSSP WASHINGTON DC FOR SSBN/SSGN>
COMSUBGRU <NO.>
COMSUBRON <NO.>
PRECOMUNIT <SHIP NAME>
<SUPERVISING AUTHORITY>
BT
UNCLAS // N09094 //
MSGID/GENADMIN/COMNAVSEASYS COM//
SUBJ/(SUBS) PRECOMUNIT <SHIP NAME/HULL NO.> FLY-BY-WIRE SHIP CONTROL SYSTEM (FBW SCS)
MATERIAL CONDITION READINESS FOR ALPHA SEA TRIALS.//
REF/A/DOC/NAVSEA T9044-AD-MAN-010//
REF/B/DOC/COMUSFLTFORCOMINST 4790.3 //
REF/C/MSG/<SUPERVISING AUTHORITY>/<DTG>// {G.2.1}
REF/D/LTR/SUB<LANT/PAC>/<SER NO./DATE>//
REF/E/LTR/NAVSEA/<SER NO./DATE>//
NARR/REF A IS THE REQUIREMENTS MANUAL FOR SUBMARINE FLY-BY-WIRE SHIP CONTROL
SYSTEMS. REF B IS JOINT FLEET MAINTENANCE MANUAL. REF C IS <SUPERVISING AUTHORITY> MSG
REPORTING FLY-BY-WIRE SHIP CONTROL SYSTEM MATERIAL CONDITION READINESS OF <SHIP
NAME/HULL NO.> FOR FAST CRUISE AND ALPHA SEA TRIALS. REF D CONCURRED WITH THE SEA
TRIALS AGENDA FOR <SHIP NAME/HULL NO.>. REF E APPROVED THE SEA TRIALS AGENDA FOR <SHIP
NAME/HULL NO.>.///
RMKS/1. IAW REFS A AND B, AND AS REPORTED BY REF C, THE MATERIAL CONDITION OF <SHIP
NAME/HULL NO.> FLY-BY-WIRE SHIP CONTROL SYSTEM IS CERTIFIED SATISFACTORY FOR USE
DURING SEA TRIALS, UPON SATISFACTORY COMPLETION OF FAST CRUISE AND RESOLUTION OF
MANDATORY DEFICIENCIES, IN ACCORDANCE WITH THE SEA TRIALS AGENDA CONCURRED IN
BY REF D AND APPROVED BY REF E.
2. THERE ARE NO FLY-BY-WIRE SHIP CONTROL SYSTEM DEVIATIONS AND WAIVERS WITH
CONDITIONS NOR FLY-BY-WIRE SHIP CONTROL SYSTEM or RELATED SHIP OPERATING
RESTRICTIONS/LIMITS WHICH HAVE NOT BEEN SATISFIED. <or identify operating restrictions/limits and list
conditional Deviations and Waivers including Deviation Number, Short Title, and Expected Clearance Date/Key Event⁽¹⁾>.
3. THIS CERTIFICATION IS VALID THROUGHOUT TRIALS UNLESS A DEFICIENCY HAS BEEN
DISCOVERED. SHIP SPEED IS RESTRICTED TO LESS THAN 20 KNOTS WHEN A FBW SCS FAULT
CONDITION RESULTS IN A MAJOR NON-CONFORMANCE AFFECTING CONTROL OF SHIPS PITCH,
HEADING, DEPTH OR CONTROL SURFACES. THESE DEFICIENCIES MUST BE REPORTED TO
NAVSEA AND THE APPROPRIATE FLEET AND TYPE COMMANDERS. PREVIOUS NAVSEA
CERTIFICATION OF THE FBW SCS MATERIAL CONDITION SHALL BE SUSPENDED UNTIL NAVSEA
REVIEWS THE REPORT AND CERTIFIES TO THE TYCOM THAT THE FBW SCS MATERIAL CONDITION
IS SATISFACTORY FOR SEA TRIALS IN ACCORDANCE WITH THE SEA TRIAL AGENDA APPROVED
BY REFERENCE E. THE SHIP'S SPEED IS RESTRICTED TO LESS THAN 20 KNOTS UNTIL
SATISFACTORY RESOLUTION OF THE MAJOR NON-CONFORMANCE AND TYCOM APPROVAL TO
OPERATE THE FBW SCS TO PREVIOUSLY AUTHORIZED CONDITIONS IS GRANTED, UNLESS
SPECIFICALLY ADDRESSED IN THE SEA TRIAL AGENDA.
4. REQUEST NAVSEA PMS<> BE INFO ADDEE ON ALL SEA TRIAL SITREPS.
5. RECOMMENDATION TO AUTHORIZE DIVING WILL BE ADDRESSED BY SEPCOR.

⁽¹⁾Subject to Navy Shipbuilding Program Manager approval, cumulative lists of conditional Deviations and Waivers which are deemed too lengthy for messages may be communicated in a letter format, with the letter referenced by the applicable message.

COMUSFLTFORCOMINST 4790.3 REV C

BT

NOTE: ENSURE MESSAGES ARE IN ACCORDANCE WITH CURRENT MESSAGE FORMAT AND CURRENT PLAD IS UTILIZED.

APPENDIX T

SAMPLE NAVSEA MESSAGE TO TYCOM CONCERNING PCU FBW SCS MATERIAL CONDITION
INITIAL CERTIFICATION (SUBMARINES)

FROM: COMNAVSEASYS COM WASHINGTON DC//
 TO: COMSUB<LANT/PAC><NORFOLK VA/PEARL HARBOR HI>
 INFO CNO WASHINGTON DC
 COM<LANT/PAC>FLT<NORFOLK VA/PEARL HARBOR HI>
 <DIRSSP WASHINGTON DC FOR SSBN/SSGN>
 COMSUBGRU <NO.>
 COMSUBRON <NO.>
 PRECOMUNIT <SHIP NAME>
 <SUPERVISING AUTHORITY>
 BT
 UNCLAS // N09094 //
 MSGID/GENADMIN/COMNAVSEASYS COM//
 SUBJ/(SUBS) RECOMMENDATION FOR <SHIP NAME/HULL NO.> FLY-BY-WIRE SHIP CONTROL SYSTEM
 UNRESTRICTED USE IN SUPPORT OF SUBMARINE UNRESTRICTED OPERATIONS//
 REF/A/DOC/NAVSEA T9044-AD-MAN-010//
 REF/B/MSG/<SUPERVISING AUTHORITY>/<DTG>// {G.2.6}
 REF/C/SSM VOLUME 7 SHIP CONTROL SYSTEM
 NARR/REF A IS THE REQUIREMENTS MANUAL FOR SUBMARINE FLY-BY-WIRE SHIP CONTROL
 SYSTEMS. REF B IS <SUPERVISING AUTHORITY> REPORT OF <SHIP NAME/HULL NO.> FLY-BY-WIRE SHIP
 CONTROL SYSTEM MATERIAL CONDITION READINESS FOR UNRESTRICTED USE.
 RMKS/1. IAW REF A, REF B REPORTED MATERIAL CONDITION READINESS OF <SHIP NAME/HULL NO.>
 FLY-BY-WIRE SHIP CONTROL SYSTEM IS SATISFACTORY AND NO OUTSTANDING LIMITING
 DISCREPANCIES EXIST.
 2. REF B ALSO REPORTED SATISFACTORY COMPLETION OF ALL FLY-BY-WIRE SHIP CONTROL
 SYSTEM SEA TRIAL TEST REQUIREMENTS AND RESOLUTION OF MANDATORY SEA TRIAL
 DEFICIENCIES. <IF ANY DISCREPANCIES ARE DEFERRED SO STATE>./.
 3. IAW REFS A AND C, NAVSEA CERTIFIES THAT THE MATERIAL CONDITION OF <SHIP NAME/HULL
 NO.> FLY-BY-WIRE SHIP CONTROL SYSTEM IS SATISFACTORY AND RECOMMENDS THE SHIP'S FLY-
 BY-WIRE SHIP CONTROL SYSTEM BE AUTHORIZED UNRESTRICTED USE IN SUPPORT OF
 SUBMARINE UNRESTRICTED OPERATIONS IN ACCORDANCE WITH SSMS./SUBJECT TO
 COMPLIANCE WITH REF A <WITH THE FOLLOWING RESTRICTIONS: list any ship or system operating restrictions/limits which
 may be applicable>.
 4. RECOMMENDATION FOR SHIP'S UNRESTRICTED OPERATION TO TEST DEPTH WILL BE
 ADDRESSED BY SEPARATE CORRESPONDENCE.
 BT

**NOTE: ENSURE MESSAGES ARE IN ACCORDANCE WITH CURRENT MESSAGE FORMAT AND
 CURRENT PLAD IS UTILIZED.**

(This Page Intentionally Left Blank)

APPENDIX U

SAMPLE NAVSEA MESSAGE TO TYCOM CONCERNING PCU RECOMMENDATION FOR
FLY-BY-WIRE SHIP CONTROL SYSTEM CERTIFICATION

FROM: COMNAVSEASYS COM WASHINGTON DC//
 TO: COMSUB<LANT/PAC><NORFOLK VA/PEARL HARBOR HI>
 INFO CNO WASHINGTON DC
 COM<LANT/PAC>FLT<NORFOLK VA/PEARL HARBOR HI>
 <DIRSSP WASHINGTON DC FOR SSBN/SSGN>
 COMSUBGRU <NO.>
 COMSUBRON <NO.>
 PRECOMUNIT <SHIP NAME>
 <SUPERVISING AUTHORITY>
 BT
 UNCLAS // N09094 //
 MSGID/GENADMIN/COMNAVSEASYS COM//
 SUBJ/(SUBS) RECOMMENDATION FOR FLY-BE-WIRE SHIP CONTROL SYSTEM UNRESTRICTED USE
 IN SUPPORT OF UNRESTRICTED OPERATIONS FOR <SHIP NAME/HULL NO.>//
 REF/A/DOC/NAVSEA T9044-AD-MAN-010//
 REF/B/MSG/<SUPERVISING AUTHORITY>/<DTG>// {G.2.8}
 REF/C/SSM VOLUME 7 SHIP CONTROL SYSTEM
 NARR/REF A IS THE REQUIREMENTS MANUAL FOR SUBMARINE FLY-BY-WIRE SHIP CONTROL
 SYSTEMS. REF B IS <SUPERVISING AUTHORITY> REPORT OF <SHIP NAME/HULL NO> MATERIAL CONDITION
 READINESS FOR THE FLY-BY-WIRE SHIP CONTROL SYSTEM
 RMKS/1. UPON COMPLETION OF HYDRODYNAMIC TRIALS <FOR FIRST SHIP OF CLASS>. IAW REF
 A, REF B REPORTED THE MATERIAL CONDITION READINESS OF <SHIP NAME/HULL NO.> FLY-BY-WIRE
 SHIP CONTROL SYSTEM IS SATISFACTORY AND NO OUTSTANDING LIMITING DISCREPANCIES
 EXIST.
 IF THERE ARE SO STATE.
 2. REF B ALSO REPORTED SATISFACTORY COMPLETION OF ALL FLY-BY-WIRE SHIP CONTROL
 SYSTEM SEA TRIAL TEST REQUIREMENTS AND RESOLUTION OF MANDATORY SEA TRIAL
 DEFICIENCIES.
 <IF ANY DISCREPANCIES ARE DEFERRED SO STATE>
 3. IAW REFS A AND C, NAVSEA CERTIFIES THAT THE MATERIAL CONDITION OF <SHIP NAME/HULL
 No.> FLY-BY-WIRE SHIP CONTROL SYSTEM IS SATISFACTORY AND RECOMMENDS UNRESTRICTED
 USE OF THE SYSTEM IN SUPPORT OF THE SHIP'S UNRESTRICTED OPERATIONS IN ACCORDANCE
 WITH SSMS./SUBJECT TO COMPLIANCE WITH REF A <WITH THE FOLLOWING RESTRICTIONS: list any restrictions
 which may be applicable.>.
 BT

**NOTE: ENSURE MESSAGES ARE IN ACCORDANCE WITH CURRENT MESSAGE FORMAT AND
CURRENT PLAD IS UTILIZED.**

(This Page Intentionally Left Blank)

VOLUME I
CHAPTER 3
PRE DELIVERY

REFERENCES.

- (a) NAVSEA 0900-LP-095-4010 - Ship Test and Evaluation Planning Guide
- (b) NAVSEA S9040-AA-GTP-010 - Shipboard Systems Certification Requirements For Surface Ship Industrial Periods (Non-Nuclear)
- (c) OPNAVINST 9080.3 - Procedures for Tests and Trials of Navy Nuclear Powered Ships Under Construction, Modernization, Conversion, Refueling and Overhaul
- (d) OPNAVINST 4700.8 - Trials, Acceptance, Commissioning, Fitting Out, Shakedown and Post Shakedown Availability of U.S. Naval Ships Undergoing Construction or Conversion
- (e) COMSUBLANT/COMSUBPACINST 3540.10 - Periodic Monitoring of Submarines and Support Facilities
- (f) COMNAVAIRLANT/COMNAVAIRPACINST 3500.20 - Aircraft Carrier Training and Readiness Manual
- (g) COMNAVSURFLANT/COMNAVSURFPACINST 3502.2 - Surface Force Training Manual
- (h) COMNAVSUBFORINST 5400.25 - Standard Submarine Supply Department Organization and Regulations Manual
- (i) COMNAVSUBFORINST 5400.29 - Standard Submarine Navigation/Operations Department Organization and Regulations Manual
- (j) COMNAVSUBFORINST 5400.40 - Standard Submarine Combat Systems Department Organization and Regulations Manual (SSN)
- (k) COMNAVSUBFORINST 5400.41 - Standard Submarine SSBN 726 Class Weapons Department Organization and Regulations Manual
- (l) COMNAVSUBFORINST 5400.47 - Standard Submarine Combat Systems Department Organization and Regulations Manual (SSGN)
- (m) COMNAVAIRLANTINST 9080.2 - Conduct of Trials and Inspections Incident to Construction, Overhauls or Availabilities of Nuclear Powered Aircraft Carriers (CVN)
- (n) OPNAVINST 3120.28 - Certification of the Aviation Capability of Naval Ships Operating Aircraft
- (o) COMPACFLTINST 9830.1 - Certification of Aviation Facilities in Naval Ships Operating Aircraft
- (p) COMLANFLTINST 3500.18 - Certification and Readiness of Aviation Facilities in Naval Ships Operating Aircraft
- (q) NAVAIRINST 3120.1 - Lead Systems Command Procedures and Responsibilities for Certification of Aviation Facilities and Equipment in Naval Ships Operating Aircraft
- (r) COMNAVSURFPACINST 3501.4 - Aviation Readiness Evaluation (ARE) and Certification of Aviation Facilities Onboard COMNAVSURFPAC Ships
- (s) NAVAIRINST 13800.11 - Procedures and Responsibilities for Certification and Verification of the Precision Approach and Landing System
- (t) NAVSEAINST 4734.1 - NAVSEA Test, Measurement, and Diagnostic Equipment (TMDE) and Calibration Programs
- (u) NAVAIRINST 13640.1 - NAVAL Aviation Metrology and Calibration (METCAL) Program
- (v) NAVSEA ST700-AM-GYD-010 - Metrology and Calibration (METCAL) Laboratory Requirements and Certification Guide
- (w) NAVAIR 17-35QAL-15 - NAVAL Aircraft Carrier and Amphibious Assault Ships Metrology and Calibration (METCAL) Program Manual
- (x) OPNAVINST C5510.93 - Navy Implementation of National Policy on Control of Compromising Emanations
- (y) MIL-STD-1680 - Installation Criteria for Shipboard Secure Electrical Information Processing Systems
- (z) OPNAVINST 9640.1 - Shipboard Habitability Program
- (aa) OPNAVINST 3120.32 - Standard Organization and Regulations of the U.S. Navy
- (ab) OPNAVINST C8950.2 - Magnetic Silencing
- (ac) NAVSEA S9086-QN-STM-010 - NSTM Chapter 475 (Magnetic Silencing)

- (ad) COMNAVSURFORINST 3540.1 - Engineering Operations Assessment, Training and Certification for Conventionally Powered Surface Ships
- (ae) COMNAVSURFORINST 3540.2 - Surface Force Engineering Readiness Process
- (af) NAVSEA S9086-T4-STM-010 - NSTM Chapter 589 (Cranes)
- (ag) NAVSEAINST 4790.8/OPNAVINST 4790.4 - Ship's Maintenance and Material Management (3-M) Manual
- (ah) NAVSEA 0924-062-0010 - Submarine Safety (SUBSAFE) Requirements Manual
- (ai) NAVSEA S9073-AW-SNC-010 - Ship Acoustical Surveys for Submarines
- (aj) NAVSEA 0989-028-5000 - Manual for Control of Testing and Plant Conditions (Nuclear)
- (ak) NAVSEA S9002-AK-CCM-010/6010 - Industrial Ship Safety Manual for Submarines

LISTING OF APPENDICES.

- A Areas to be Evaluated During Arrival Assists
- B Areas to be Evaluated During Monitoring Inspections
- C Sample Pre-Reactor Safeguard Examination Notice
- D In-Service Compartment Surveillance Guide (Aircraft Carriers and Submarines Only)
- E Sample Pre-Commissioning Habitability Inspection Checklist for New Construction Ships

3.1 PURPOSE. This chapter addresses the major evolutions confronting the crew from initial man-up through Dock Trials, Fast Cruise and the commencement of Sea Trials.

3.2 SHIPBUILDER'S TEST PROGRAM. Throughout the building phase, the Shipbuilder is responsible for the testing/certification of installed equipment and systems. Reference (a) establishes the Test and Evaluation policy for all phases of a ship's life cycle. This guide contains information concerning the documentation and procedural requirements for a ship's Acquisition, Test and Evaluation Program. Reference (a), in conjunction with the Navy Shipbuilding Program Manager's prepared System Acquisition, Test and Evaluation Handbooks, provides familiarization and an understanding of the total Ship Test Program.

3.3 INSPECTIONS/CERTIFICATIONS/ASSISTS. There are numerous inspections/certifications associated with new construction. Reference (b), which can be obtained from the Supervising Authority, identifies all the certification requirements which have been approved for accomplishment during surface ship industrial periods. The following paragraphs deal with generic inspections or platform unique certifications.

3.3.1 Arrival Assist.

- a. Purpose. To determine that adequate plans have been developed and implemented to support the requirements of Ship's Force training, administration and testing during new construction and to evaluate the ship's ability to conduct various evolutions.
- b. Conduct. The arrival assist visit may be conducted as a single visit or as a series of visits. Appendix A of this chapter provides sample areas to be reviewed during the arrival assist visit.
- c. Scheduling. The arrival assist should be scheduled for accomplishment within a two month period following the arrival of the first crew increment.
- d. Reports. Formal reports are not required. However, the Immediate Superior in Command (ISIC) should inform the Type Commander (TYCOM) in the event that progress in preparations is evaluated as unsatisfactory.

3.3.2 Periodic Monitoring/Inspections/Visits.

- a. Purpose.
 - (1) To provide ships in new construction with training and administrative assistance as required by references (c) and (d). The focus will be to improve Ship's Force involvement with the construction process, maintenance and training tasks. Visits of this nature are defined as Tech Assists.

- (2) To evaluate the effectiveness of the ship's administration and training policies. Inspections of this nature are defined as Work-ups and normally require the addition of at least two officers to the inspection team.
- (3) To conduct spot checks to monitor progress in specific material, administrative and training areas. Visits of this nature are defined as Monitoring Visits.
- b. Conduct. The extent, type, and frequency of periodic monitoring inspections and visits should be determined by the ISIC. Submarine monitoring inspections may be combined with those required by reference (e). The initial inspection should be broad in scope in order to apprise the ISIC of the adequacy of the ship's performance and progress.
- c. Scheduling. The initial inspection should be conducted within a 45 day time period after the arrival inspection. The initial visit will indicate the frequency and scope of subsequent Tech Assists and Monitoring Visits. Some inspections should be conducted on an unannounced basis. In general, any required Work-ups should be scheduled in advance of Key Events. All inspections should be scheduled to minimize interference with industrial activity and Ship's Force work.
- d. Reports. Formal reports are not required. However, the ISIC should advise the TYCOM of situations where the completion of Key Events is in jeopardy due to a lack of progress in any of the subject areas identified in Appendix B of this chapter.
- e. Inspection Areas. Initial inspections normally examine the effectiveness of Ship's Force follow-up actions as a result of the arrival assist. Subsequent inspections and visits should review the areas designated in Appendix B of this chapter as appropriate.

3.3.3 Pre-Reactor Safeguard Examination (Nuclear Powered Ships only).

- a. Purpose. To evaluate the readiness of the Engineering/Reactor Department to undergo an RSE by representatives of Naval Sea Systems Command Nuclear Propulsion Directorate (NAVSEA 08). Appendix C of this chapter provides a sample Pre-RSE Notice which should be tailored to fit your specific platform.
- b. Conduct. The Pre-RSE performed by the ISIC with TYCOM assistance is not intended to duplicate the inspections for which readiness is being evaluated. It is prudent, however, to use an inspection plan similar to that employed by NAVSEA 08. Normally the crew's readiness can be assessed within two days using such a plan. The Supervising Authority will arrange for minimum industrial activity work interference during this inspection.
- c. Scheduling. The ISIC shall conduct a Pre-RSE within six weeks of intended criticality. The Pre-RSE shall be scheduled such that the qualification program and material condition of the ship are sufficiently complete to allow for a thorough inspection, but early enough to allow time for the correction of identified deficiencies prior to criticality. The TYCOM should be advised approximately two months prior to the tentative date and confirmed dates should be established approximately one month prior to the inspection.
- d. Composition of the Inspection Team. The Pre-RSE Inspection Team should consist of:
 - (1) A nuclear trained member of the ISIC Staff, usually the Deputy Commander for Readiness or Training.
 - (2) A qualified nuclear engineer with experience in the billet.
 - (3) A nuclear trained officer from the TYCOM Staff. Arrangements for the participation of TYCOM Staff members should be initiated by the ISIC at least one month prior to the anticipated inspection date.
 - (4) The Prospective Commanding Officer (PCO) of the next local ship in a new construction status.
 - (5) The TYCOM industrial activity representative.
- e. Reports. The Senior Inspector should provide the ship with an informal report of the findings with a copy to the ISIC and TYCOM.

- f. Inspection Areas. The Pre-RSE should, as a minimum, encompass the following:
 - (1) An administrative review.
 - (2) Observation of basic drills and evolutions not requiring reactor operation or special conditions.
 - (3) Personnel interviews and written tests.
 - (4) Material inspection.

3.3.4 Crew Certification. Crew certification is required for new construction ships. Depending upon the platform and TYCOM policy, crew certification will be accomplished in two, three or four phases.

- a. Purpose. Initial phases determine the state of readiness and training of Ship's Force, particularly in the areas of watchstander qualifications, damage control readiness, status of operational and emergency bills, onboard supply of essential technical manuals and general operational knowledge. Later phases are structured to certify that the state of crew training is satisfactory for at-sea operations.
- b. Scope. Certifications for submarines and surface ships will be conducted using the guidance of the applicable TYCOM training manual, references (f), (g), and (h) through (l). Reference (m) provides additional direction for aircraft carriers.

3.3.5 Sonar Certification (Applicable Surface Force Ships and Submarines). Sonar certification for surface force ships is accomplished in accordance with reference (b). Submarine sonar certification is accomplished in accordance with references (h) through (l), during a designated Sea Trial just prior to the Combined Trial. Sonar certification is a prerequisite for Antisubmarine Warfare certification on surface ships and the Weapons/Tactical Readiness Evaluation on submarines.

3.3.6 Aviation Facility Certification (Air Capable Ships only). Reference (n) requires that all aviation facilities aboard naval ships which operate aircraft be formally inspected and certified adequate and safe for flight operations. It further directs, as implemented by references (o) and (p), that Commander, Pacific Fleet (COMPACFLT) and Commander, United States Fleet Forces (USFF) shall establish responsibilities and procedures for mandatory certification of all ships with aviation facilities. Reference (n) also directs the Chief of Naval Operations (CNO) to establish responsibilities and procedures for mandatory certification of all ships' aviation facilities, provide for certification inspection teams and issue approved standards for certification. Naval Air Systems Command (NAVAIR) has overall responsibility for certification of aviation facilities and equipment in Naval ships. Aviation facility and equipment certification is a procedure which verifies and documents that the aviation facilities and equipment aboard ships are properly installed, operational, and adequate for the safe conduct of aircraft operations. Details for certifications can be found in reference (q), and in TYCOM specific instructions such as reference (r).

- a. Management Structure.
 - (1) The Navy Shipbuilding Program Manager is responsible for budgeting for the certification of ships involved in construction and modernization programs.
 - (2) Naval Air Warfare Center (NAWC) administers the aviation facilities and equipment certification programs and will establish test programs and procedures for each aviation facility and equipment component.
- b. Certification Procedures.
 - (1) Requests. Submit requests for certification directly to NAWC. The ship's TYCOM will be advised of all requests for equipment and facility certification. Individual ships desiring certification inspections should submit requests via their TYCOM to ensure optimum scheduling of the certification team. Automatic Carrier Landing System certification requests will be submitted per reference (s).
 - (2) Inspection and Testing. The ship's aviation facilities and equipment will be inspected and tested by a team coordinated by a NAWC representative. Upon completion, the NAWC team coordinator will, (via message to NAWC, the TYCOM, and other appropriate commands) make a recommendation to either grant, rescind, or withhold certification. This recommendation is to be predicated upon all aviation facility systems or equipment being properly installed, configured, operational, and maintained as prescribed by applicable

technical manuals or directives. The message will also specify the ship's current certification status, including deficiencies that preclude full certification for the operational capabilities specified by the CNO.

- (3) Certification. NAVAIR or NAWC grants or rescinds certification via message after review of the recommendation from the NAWC team coordinator and any other information that may be available. The certification message will be addressed to the TYCOM and other appropriate commands. It will specify the ship's present aviation status, including any corrections that must be accomplished to achieve full certification for the operational capabilities specified by the CNO. Certifications granted will remain in effect until such time that major equipment modifications or alterations are accomplished or until the next overhaul (not to exceed two years on Air Capable Ships and Amphibious Assault Ships unless rescinded by NAVAIR or NAWC.
- c. Technical Publications. A listing of technical publications required for Air Certification can be obtained from the TYCOM. References (b) and (q) list specific certifications required for aviation platforms.

3.3.7 Salvage Inspection (Submarines only).

- a. Purpose. To determine the readiness of submarine rescue and salvage equipment.
- b. Conduct. Submarine Salvage Inspections will be conducted in accordance with the direction of Volume IV, Chapter 18 of this manual.

3.3.8 NAVSEA Calibration Activity/Aircraft Intermediate Maintenance Department Calibration Laboratory Initial Certification (Submarines, Aircraft Carriers and Surface Forces, as appropriate).

- a. Purpose. To verify the NAVSEA/NAVAIR Designated Command has in place the necessary documentation, facilities, equipment and trained personnel to support calibrations of Test, Measurement and Diagnostic Equipment (TMDE) as specified in references (t), (u) and (v).
- b. Conduct. Initial certification is conducted by the NAVSEA/NAVAIR Metrology and Calibration (METCAL) Technical Representatives in accordance with the requirements of references (v) and (w). **NAVSEA METCAL Technical Representatives are the NAVSEA METCAL Quality Manager and NAVSEA METCAL Engineering Agent.**
- c. Scheduling. Initial certification should be accomplished after approval of Establishment of Field Calibration Activity Request and prior to or concurrent with delivery. Coordination between the TYCOM METCAL Point of Contact, METCAL Technical Representative, the Navy Shipbuilding's Program Manager and Ship's Calibration Coordinator is required to insure all participants can support the certification date and that all required TMDE is available.
- d. Reports. Reports will be per the requirements of reference (v) and submitted by letter to the applicable TYCOM and Commanding Officer (CO).
- e. Additional information concerning calibration can be found in Volume VI, Chapter 9 of this manual.

3.3.9 National Policy on the Control of Compromising Emanations Inspection.

- a. Reference (x) promulgates the Navy's implementation of the National Policy on the Control of Compromising Emanations (TEMPEST). Reference (y) provides installation criteria for shipboard secure electrical information processing systems.
- b. All ships are considered to be operating under an "acceptable risk" category until such time as they have been certified to meet National Policy. Two types of inspections are conducted to certify ships:
 - (1) Instrumented TEMPEST Survey. The Instrumented TEMPEST Survey is a comprehensive inspection which will only be done on selected ships to certify the ship class.
 - (2) Visual TEMPEST Inspection (VTI). The VTI is a less comprehensive inspection to certify compliance with class and CNO standards. VTIs can be conducted by Regional Maintenance Centers (RMC), industrial activities and Navy Command, Control, and Ocean Surveillance Center Naval In-service Engineering.

- c. A VTI will be accomplished on all new construction ships. This inspection will be scheduled upon the completion of the installation of all Radio Room/secure electrical information processing equipment. In addition, a TEMPEST file needs to be established to include all actions pertaining to installations, modifications or alterations to secure electrical information processing equipment or centers. The specific information to be retained is identified in reference (x).

3.3.10 Diesel Inspection.

- a. Purpose. To validate/certify engine alignment, foundation integrity, engine frame integrity, shimming and stressing requirements, hold down bolts, blower operation and engine performance.
- b. Conduct. Diesel inspections shall be conducted in accordance with Volume IV, Chapter 4 of this manual.

3.3.11 Habitability Inspection. Navy ships are built to meet habitability standards for berthing areas, messing areas, water closets, laundry and barber facilities as set forth in reference (z). Prior to certifying readiness for In-Service the ISIC will conduct a Habitability Inspection to determine that the ship is materially ready for the crew to move aboard. The results of the Habitability Inspection shall be reported to the TYCOM by message (see Volume I, Chapter 2, Appendix A₄ of this manual for sample message).

- a. The Habitability Inspection for submarines is conducted two to four weeks prior to certifying the ship's readiness for In-Service, two to four months prior to this certification for aircraft carriers and just prior to delivery and crew move aboard for all others.
- b. Compartment Surveillance Guide. Appendix D of this chapter has been included to serve as a guide when preparing for the Habitability Inspection and In-Service. Appendix E of this chapter is a sample checklist which can be tailored to any platform.

3.3.12 Requirements for In-Service. Assigned Ship's Force constitutes the only group of personnel authorized to operate naval nuclear powered ships during dockside testing and Sea Trials. Because of this requirement, references (c) and (d) specify that nuclear powered ships in construction are assigned an active status of In-Service prior to commencement of the first Sea Trial (two to four weeks for submarines, two to four months for aircraft carriers) and retains that status until delivery of the ship. To support this event the contractor is required to make the ship available to the Navy for a period of two days for a Habitability Inspection two to four weeks prior to In-Service. At In-Service, the responsibility for, and custody of, fissionable materials is transferred from the Supervising Authority to the Officer In Charge (OIC) of the ship. The PCO becomes the OIC of the ship and continues in this capacity until Commissioning at which time the OIC becomes the CO.

- a. Responsibilities for Safety of the Ship. Placing the ship In-Service has an impact upon the established responsibilities for safety of the ship.
 - (1) Prior to In-Service, or Delivery for Surface Ships, the industrial activity's responsibilities for the safety of the ship are all inclusive. The Supervising Authority is responsible for monitoring the industrial activity's safety and fire protection program.
 - (2) At In-Service the PCO assumes the duties of OIC and the responsibility for the safety of the ship. Reference (aa) states that the OIC of a ship In-Service has the same responsibilities for the safety of the ship as a CO of a commissioned ship.
- b. Division of Responsibility. In order to establish clear lines of responsibility at In-Service and to eliminate unnecessary duplication of effort, the following shall apply:
 - (1) Ship's Force. At In-Service, Ship's Force must have operational control of all ship's systems required to maintain ship safety (i.e., ventilation, firefighting and flood control) in the ship and will stand all shipboard watches, making all security patrols of the ship, the moorings, and the immediate adjacent pier.
 - (2) Industrial Activity. The industrial activity continues to perform all contract requirements until delivery. The industrial activity will support Ship's Force in the performance of those requirements assumed by Ship's Force as required.

- (3) Supervising Authority. During preparations for In-Service, conduct liaison between Ship's Force and the industrial activity to ensure that the above division of responsibility is understood and agreed to. Verify that a schedule of compartment/space and system turnover is prepared, mutually agreed to, and that a means to identify deficiencies in systems and spaces turned over to Ship's Force is executed.

3.3.13 Degaussing/Deperming. Reference (ab) establishes the provision for checking, operating and maintaining degaussing systems. Reference (ac) contains basic principles and background information concerning degaussing.

- a. Deperming, a method of neutralizing the magnetic field of a ship's hull to minimize permanent magnetism, is required for all new construction ships.
- b. A listing of degaussing/deperming facilities currently available is contained in the Degaussing Folder (NAVSEA Form 8950/1) which is issued to individual ships.
- c. Degaussing/deperming requirements shall be accomplished in accordance with Volume VI, Chapter 12 of this manual.

3.3.14 Light-Off Assessment (Surface Force Ships only).

- a. Light-Off Assessments (LOA) for boilers, Main Propulsion diesel and gas turbine ships will be conducted before propulsion plant operations at an appropriate time before completion of the fitting out availability. The ISIC, with the assistance of Afloat Training Group Atlantic/Pacific, will determine if ship's training procedures and status support safe plant operations, if management programs are effective, if the propulsion plant is ready for light-off and Ship's Force ability to combat a main space fire.
- b. References (ad) and (ae) address propulsion plant LOAs administered by the ISIC, with the assistance of Afloat Training Group Atlantic/Pacific, and recommend that Ship's Force is to have a minimum of two weeks after completion of industrial activity work in the engineering spaces prior to the LOA. Experience has shown this two week period is crucial, not only to successful completion of the LOA but to the operation of the ship subsequent to construction. If it appears the two week interval is in jeopardy, the ship's OIC should discuss ways to speed up the industrial activity work with the Ship Superintendent or this subject should be addressed at Supervising Authority progress conferences.
- c. Completion of industrial activity work should be interpreted as meaning that all known work and testing authorized for accomplishment by other than Ship's Force, and which is necessary to support LOA, is complete, including the removal of associated staging and equipment, reinstallation of access doors and hatches, cleanup and painting. Fuel and lube oil, and feedwater should be on board. Partial or temporary installations do not meet completion criteria except as necessary to support the LOA itself or, in the case of lagging pads, as necessary to allow readjustment upon light-off to hot settings of regulators, reducers, and relief valves. The systems and spaces involved in LOA vary from ship to ship, but normally include all systems and spaces needed to support the plant(s) being inspected. This would include main and auxiliary machinery spaces, switchboards, diesels, shaft alleys, uptakes, repair lockers, oil laboratories and calibration laboratories for Automatic Boiler Control systems, etc. Confirm spaces subject to inspection with the Afloat Training Group.
- d. Emergent work items or additional discrepancies requiring industrial activity work that become apparent during the pre-LOA period need to be accommodated. Normally these requirements can be worked during night shifts or inclusive weekends. However, any industrial activity work during this period will be permitted only with the consent of the Supervising Authority and the OIC.
- e. This Key Event is largely an exercise in attention to detail and coordination at and between all three levels of maintenance activity (Ship's Force, the Shipbuilder and the Supervising Authority). LOA preparations should begin months before the availability.
- f. First-hand inspections of main and auxiliary machinery spaces are most effective when industrial activity personnel are not on board (weekends and holidays). During these periods, joint inspections by the Engineer Officer with Leading Petty Officers are recommended for every main space. Similar inspections of the auxiliary spaces should be conducted by either the CO or the Executive Officer, along

with the Leading Petty Officers of those spaces. Discrepancy lists convert readily to work lists. Night repair teams (primarily composed of duty section personnel) can work discrepancies when industrial activity workers are not in the way.

- g. The Plan of Action and Milestones for a successful LOA must be written in detail, at the minor equipment/minor task level, and the more detailed, the better. It is a dynamic document and requires updating and revision daily as the LOA date approaches.

3.3.15 Shipboard Crane Certification Program (Surface Force Ships and Aircraft Carriers as appropriate). The Shipboard Crane Certification Program established by reference (af) is intended to improve the reliability and safety of all shipboard cranes and is applicable to all cranes mounted on board and cranes assigned to forces afloat (exceptions are listed in reference (af)). Initial crane certification should be accomplished per reference (af).

3.3.16 Marine Gas Turbine Inspection.

- a. Purpose. To validate/certify engine alignment, foundation integrity, engine frame integrity, engine resilient mounts, fluid system cleanliness, intake and uptake cleanliness, compressor and turbine blade integrity, fluids leakage, controls and instrumentation functionality and engine starting and performance.
- b. Conduct. Marine Gas Turbine inspections shall be conducted in accordance with Volume IV, Chapter 23 of this manual.

3.4 MAINTENANCE AND MATERIAL MANAGEMENT PROGRAM.

3.4.1 Planned Maintenance System.

- a. The installation of the Planned Maintenance System (PMS) on new construction ships should be scheduled to provide maintenance documentation to support the Operational Control Transfer (OCT) of systems/equipment from the shipbuilder to Ship's Force. This early load out of PMS allows Ship's Force personnel to become familiar with the maintenance procedures and facilitates the identification of problems with the Maintenance Requirement Cards (MRC) prior to the ship being placed in operation. Local RMC coordinates the scheduling of PMS installations with the ship's Maintenance and Material Management (3-M) Coordinator. In addition, Naval Sea Logistics Center (NAVSEALOGCEN) is responsible for:
 - (1) Generating a preliminary List of Effective Pages (LOEP) for Phase I validation.
 - (2) Conducting Phase I of the PMS installation.
 - (3) Generating a final LOEP based on Phase I and 3-M Coordinator Feedback.
 - (4) Notifying local RMC of the required PMS documentation (LOEP requirements) and the date the documentation is required to support Phase II PMS installation.
 - (5) Compile Phase II PMS package and forward to ship.
 - (6) Conduct Phase II PMS installation.
 - (7) Effect additional LOEP corrections as a result of Phase II.
 - (8) Outbrief with ship's PCO/OIC concerning status of ship's 3-M program.
- b. PMS installation for nuclear powered ships will be conducted approximately six months prior to initial reactor plant criticality. The installation for Surface Force Ships will be conducted at least three months prior to delivery. Installation of PMS is accomplished in two phases.
 - (1) Phase I. Phase I results in the establishment of a ship's LOEP. Local RMC, utilizing either the LOEP from the previous ship of the class or configuration information provided by Submarine Maintenance Engineering, Planning and Procurement (SUBMEPP) Activity (Submarines only), Supervisor of Shipbuilding Newport News PMS 312C, (Aircraft Carriers) or applicable TYCOM (Surface Force Ships), generates a preliminary LOEP for Ship's Force review. This preliminary LOEP and copies of the listed Maintenance Index Pages (MIP) are delivered to the new construction unit for a review by the ship's 3-M Coordinator, Work

Center Supervisors and maintenance personnel. Ship's Force personnel review the documentation, verify MIP to Work Center assignments and approve the preliminary LOEP. Phase I occurs approximately two months prior to Phase II.

- (2) Phase II. Phase II is the actual load out of PMS documentation, final verification of the LOEP, generation of preliminary schedules for local RMC review and a Ship's Force validation of provided documentation. Depending upon the ship class, quantity of documentation, and/or Ship's Force preparation, Phase II can last from two to four days. Additionally, maintenance support organizations such as Naval Surface Warfare Center, Carderock Division (NSWCCD), SUBMEPP or Submarine Monitoring, Maintenance and Support Program Office may be participants.
- c. The preparation of preliminary Cycle, Quarterly, or Weekly schedules to support PMS load out prior to the preparation of First Quarter after Overhaul schedules is recommended. As a minimum, the development of a cycle schedule for each work center should be accomplished prior to Phase II PMS installation. As systems/equipment is turned over, Ship's Force maintenance should be scheduled to support. This preliminary quarterly schedule (schedule "A") is utilized to track maintenance prior to the official First Quarter after Overhaul start date. Additional preliminary quarterly schedules identified as "B", "C", etc. may be developed as required.
 - d. The "official" PMS start date depends upon several factors: OCT of equipment, available man power, availability of supporting documentation and the availability of tools, parts, test equipment, and material. The start date is also an arbitrary date arrived at by the ship's 3-M Manager and 3-M Coordinator. A start date should be selected that causes as little disruption and preparation of schedules as possible. Utilization of preliminary schedules as discussed in paragraph 3.4.1.c of this chapter will allow for the flexibility to start PMS "officially" at the beginning of a quarter. However, should this approach not support your situation, the starting of PMS should be indicated on your quarterly schedule with a yellow vertical line, top to bottom, indicating your start date.
 - e. Inactive Equipment Maintenance (IEM).
 - (1) IEM, per the direction of reference (ag), may be implemented anytime that an equipment will be out of service for thirty days or longer. The implementation of IEM may be appropriate for those systems/equipment which was transferred to ship's custody early in the construction cycle. Ship's Force should follow the guidance of reference (ag) when implementing.
 - (2) In deciding whether to place equipment in lay up, consideration should be given to the training opportunity lost. As long as equipment is in an active status, Ship's Force will be performing PMS. By virtue of accomplishing those maintenance tasks, they will become more familiar with the equipment, its operation and the maintenance procedures. Maintaining equipment in an active status also allows for the identification of procedural problems within the MRCs.

3.4.2 Technical Feedback Reports. Ship's Force should start using Technical Feedback Reports (TFBR) to report problems with PMS as soon as the PMS package is installed. TFBRs should be submitted per the requirements of reference (ag). The TFBR tracking log should be established, even if PMS has not officially started. TFBRs are processed through the ISIC for further processing to RMC. If an ISIC is not available, TFBRs are to be processed through the TYCOM or directly to RMC. New construction ships will provide their TFBRs to the local RMC. The current contact information for the RMCs is listed in Volume VI, Chapter 2, Appendix A of this manual.

3.4.3 Establishment of Current Ship's Maintenance Project. The ship's Current Ship's Maintenance Project (CSMP) will be initialized at delivery. That does not mean however, that significant maintenance related events do not happen during the construction period. In fact, every industrial activity has their own deficiency tracking programs, all of which contain a certain degree of data that should be retained in the ship's CSMP. The problem is that this data resides on industrial activity computers which for the most part do not "talk" to Navy computers. When the ship leaves the industrial activity, it generally leaves without this data. Ship's Force will load into the CSMP any deficiencies not adjudicated at delivery and any historical construction related maintenance data deemed worthy of future retrieval.

3.4.4 Naval Tactical Command Support System. Space & Naval Warfare Systems Center Atlantic (SSC Atlantic) and Space & Naval Warfare Systems Center Pacific (SSC Pacific) are responsible for the software installation, installation training, hardware support and software support. Ship's Force should initiate liaison with the appropriate SSC Atlantic and Pacific team to facilitate installation or installation training. All support requests are initiated via the Navy 311 Help Desk. Additional details describing the SSC Atlantic and Pacific support functions are addressed in Chapter 2, paragraph 2.10.5 of this volume.

3.5 EQUIPMENT LOAD OUT.

3.5.1 Test Equipment. The General Purpose Electronic Test Equipment (GPETE) load out involves personnel from the ship, the Supervising Authority, NAWC, China Lake, CA. The actual load out will vary dependent upon the platform. Generally, the equipment arrives during the construction phase and is stored by the shipbuilder until load out. Ship's Force, if not requested to do so by the Supervising Authority, should inventory and identify shortages while the GPETE is in storage. Coordinate with TYCOM METCAL Point of Contact to assist in resolving TMDE deficiencies.

3.5.2 Hand Tools and Weight Handling Equipment. Hand tools and weight handling equipment will also be arriving. Inventory of this equipment against Allowance Equipage Lists (AEL)/Allowance Parts Lists (APL) or class specific load lists at the earliest opportunity ensures the required support material is available when maintenance of equipment begins. Weight handling equipment requires certification prior to use and while it may be months before this equipment is required, a recall schedule should be developed to get the equipment certified.

3.6 LOGISTIC SUPPORT.

3.6.1 Technical Manuals and Drawings. Technical manuals and drawings are provided by the Supervising Authority and the Navy. The shipbuilder develops and provides manuals and drawings for all Contractor Furnished Equipment (CFE), including equipment furnished by subcontractors. In the case of Government Furnished Equipment (GFE), the shipbuilder will identify the required manuals to the Navy Publication and Printing Service Manuals Office, Washington, D.C., via the Supervising Authority and the Navy Shipbuilding Program Manager. Navy Publication and Printing Service Manuals Office will deliver the manuals to the shipbuilder. For the first ship of a class, equipment manuals for new design GFE may not be immediately available from the Navy Publication and Printing Service Manuals Office. These manuals will be shipped with the equipment by the vendor. The shipbuilder shall provide stowage and custody of this documentation until actual shipboard load out. To ensure all required technical manuals and drawings are received, initial documentation validation should be accomplished on a random sampling basis with emphasis placed on low visibility items such as power supplies and electronic subsystem manuals. Final validation will occur during load out. Each Navy Shipbuilding Program Manager has assigned an activity with the responsibility for loading out of Technical Manuals and Drawings. Contact the Supervising Authority or the Navy Distance Support Anchor Desk to determine the Navy Shipbuilding Program Manager. The Anchor Desk can be reached at 1-877-418-6824 or by e-mail (help@anchordesk.navy.mil).

- a. Ship Systems Manual (SSM)/Ship Information Book (SIB). The SSM/SIB (SSM for submarines and SIB for surface force ships and aircraft carriers) are the primary descriptive and operating manuals for non-propulsion plant ship systems. They are designed as a class manual and are the basic source of information for locating, describing and operating the following non-propulsion plant systems:
 - (1) Mechanical.
 - (2) Piping.
 - (3) Electrical.
 - (4) Electronic.

These manuals do not provide detailed maintenance information but do reference sources of information on maintaining, testing, troubleshooting, installing and removing these systems and equipment. SSMs and SIBs must be turned over to the ship prior to or at OCT or custody transfer of the system or equipment.

- b. Engineering Drawings. All engineering drawings belong to one of two groups: ship construction drawings or equipment drawings. Each group is made up of several types of drawings.

- (1) Ship Construction Drawings. These drawings are developed for building the ship and to reflect installed systems. These drawings are each assigned a seven-digit NAVSEA number and depending upon the platform a three-digit Component Identification Number/Ship Work Breakdown Structure/Expanded Ship Work Breakdown Structure may appear on the drawing. The NAVSEA number identifies the drawing and the Component Identification Number/Ship Work Breakdown Structure/Expanded Ship Work Breakdown Structure assigns the drawing to a group of related drawings. Ship construction drawings are usually “class drawings” however, ships of a class, built at different times, may vary from the original design as improvements are made. This necessitates the development of hull unique construction drawings which have been verified by the shipbuilder and Supervising Authority to reflect an individual ship’s configuration. Systems requiring these Selected Record Drawings (SRD) are identified in the ship’s building specifications.
 - (2) Equipment Drawings. Equipment drawings describe equipment shown on ship construction drawings. They are prepared by industrial activities and/or equipment manufacturers and may be called vendor drawings. Equipment drawings are rarely assigned NAVSEA or any other government controlled number. These drawings are identified by a Commercial and Government Entity code with a manufacturer’s drawing number.
- c. Drawing Types. Engineering practices have developed common titles that are used on most drawings. By understanding the kind of technical information associated with each title, the drawing needed for a given job can be determined. The following is a list of common drawing types (they may be either equipment or ship construction drawing group types).
- (1) System diagrams - A system diagram shows how a system is designed and describes the relationship among system components. System diagrams do not include physical or dimensional data, but normally refer to other drawings and documents that contain detailed information.
 - (2) Arrangement drawings - Arrangement drawings show locations, dimensions, and other system component information necessary to make correct installation on the ship.
 - (3) Assembly and subassembly drawings - Assembly and subassembly drawings show how individual parts fit together to form a larger component or equipment.
 - (4) Installation drawings - Installation drawings show piping, foundations, ventilation ducting, and other installation details. Installation drawings are used to install systems and equipment in the ship.
 - (5) Outline drawings - Outline drawings show the outward appearance of major system components and contain dimensions and service requirements necessary to install the component.
 - (6) Detail drawings - Detail drawings show dimensions and other manufacturing data for individual parts of components.
 - (7) Electrical drawings - Electrical drawings have a family of titles similar to those of other engineering drawings. Proceeding from the general to the detailed the following are the common electrical drawing types:
 - (a) Electrical system wiring diagrams - Electrical system wiring diagrams show how the overall system is intended to function.
 - (b) Cabling drawings - Cabling drawings describe cable runs in greater detail (similar to piping system diagrams).
 - (c) Wireway drawings - Wireway drawings show how cables are routed from one point to another in the ship (similar to system arrangement drawings).
 - (d) Schematic wiring diagrams - Schematic wiring diagrams describe individual wires inside the cables and how they connect to components.

- (e) Wiring tables - Wiring tables provide detailed point-to-point data for connecting ship's wiring between components.
- d. Technical Variance Documentation (TVD). Drawings may be amended with supplementary information called TVD. A set of TVD is a collection of documents describing how the as-built configuration of a ship differs from the class drawing design. TVD is not intended to be a revision to a drawing. Liaison Problem and Solution Sheets, Engineering Notices, Waivers and Deviations are some of the documents that make up TVD.
- e. Format of Onboard Drawings. Very few drawings are provided to ships and shore facilities in hard copy form. Most are on microfilm aperture cards or microfiche, collectively known as microform. For selected platforms, Compact Disc Read Only Memory (CD-ROM) is being utilized. However, some of the more important SRDs are provided in hard copy as well as in other mediums.
- f. Ship Drawing Index (SDI). The SDI lists all drawings for a class of ship. Using the SDI is the only way to determine a drawing's applicability. In addition to drawing applicability, it provides drawing revision applicability and TVD applicability. The SDI will also identify whether a drawing contains Submarine Safety (SUBSAFE) information, Noise Control information or is an SRD.

3.6.2 Unrestricted Operations Maintenance Requirement Cards (Submarines only).

- a. Reference (ah) establishes the maintenance requirements and identifies the responsibilities and actions required to support continued unrestricted submarine operations to design test depth. This program is invoked on all SUBSAFE certified submarines. To support this program the Navy Shipbuilding Program Manager issues individual manuals containing required, periodic SUBSAFE maintenance actions for each class and in some instances particular ships.
- b. Load out of Unrestricted Operations (URO) MRCs will be accomplished at delivery. The ISIC Quality Assurance Officer will provide to the ship's Quality Assurance Officer the ship's copy of the "URO CD-ROM". SUBMEPP manages the URO program for Navy Shipbuilding Program Managers.
- c. Additional information concerning the URO program can be found in Volume VI, Chapter 25 of this manual.

3.7 OPERATIONAL CONTROL TRANSFER. OCT, depending on the platform, will happen in one of several ways. The entire ship is turned over at one specific time (ship custody transfer), compartments/spaces are turned over as completed, or systems are turned over as completed without regard to space completion.

- a. The shipbuilder will:
 - (1) Ensure all testing is complete to the most practical extent possible.
 - (2) Provide Ship's Force and the Supervising Authority with a turnover schedule.
 - (3) Conduct a review of all existing work/deficiencies with Ship's Force and the Supervising Authority and determine those items that must be cleared or resolved to support a safe and operational system turnover.
 - (4) Verify system, space or ship ready for turnover.
 - (5) Conduct walk-through with Ship's Force.
 - (6) Execute turn-over.
- b. Ship's Force should be prepared to:
 - (1) Provide system experts for walk-throughs.
 - (2) Address concerns regarding turn-over to the Supervising Authority's Ship Manager.
 - (3) Ensure all work/deficiencies are cleared or resolved to ship's satisfaction prior to acceptance.
 - (4) Assume maintenance responsibility upon receipt. (PMS installation should be scheduled to support OCT).

NOTE: IN SOME INSTANCES SYSTEMS MAY BE TURNED OVER THAT REQUIRE TEMPORARY SUPPORT SYSTEMS. THE INDUSTRIAL ACTIVITY WILL PROVIDE OPERATING INSTRUCTIONS, DRAWINGS (AS NECESSARY) AND OPERATING INDOCTRINATION TO SHIP'S FORCE. FOLLOWING THE REMOVAL OF TEMPORARY SUPPORT SYSTEMS, SHIP'S FORCE AND THE SHIPBUILDER SHOULD BE PREPARED TO CONDUCT ADDITIONAL WALK-THROUGHS.

3.7.1 Sound Silencing Programs Unique to New Construction (MHC/SSN only).

- a. Isolation System Survey. During the construction process, the shipbuilder, through Noise Reduction Program requirements, periodically inspects the ship to identify incorrect installation and poor construction techniques relating to the silencing nature of the ship. It is imperative that no sound shorts exist between sound isolated systems/components and the hull structure. Ship's Force can play a major role in the inspection process by identifying deficiencies. This survey is the basis for acoustic measurements to be completed in subsequent surveys. Additional information concerning submarine noise reduction surveys is addressed in Volume VI, Chapter 23 of this manual.
- b. (Submarines only) Topside and Housekeeping Survey. During the construction process, this survey is completed to accomplish two aspects of silencing. First, the topside inspection checks the outside of the pressure hull, especially flow exposed areas, to ensure that tones or rattles are not caused by loose gear, fairing plates, and other discontinuities. Secondly, the housekeeping inspection checks the inside of the pressure hull to ensure sound shorts do not occur as a result of installation of lockers and locker doors, stowage, clogged ventilation ducts or filters, etc. This survey usually identifies problems associated with items not covered by ship design, but those items typically handled by the ship.
- c. Structureborne and Oversight Surveys. Upon installation of Noise Critical components and their associated operating systems, structureborne noise surveys are accomplished to check the acoustic nature of the installation. Proper installation of isolation features and proper maintenance of the component during any lay up is crucial to the success of this survey. Ship's Force must continually be aware of the installation practices of the shipbuilder and thoroughly inspect the installation for sound shorts and proper alignment prior to system/component turnover. The Oversight Survey is accomplished outside the hull (pressure hull for submarines) as an indication of radiated noise. Proper operation of systems and components during this process is crucial to satisfactory acoustic levels. Reference (ai) provides additional information concerning acoustic surveys for submarines.

(This Page Intentionally Left Blank)

APPENDIX A
AREAS TO BE EVALUATED DURING
ARRIVAL ASSISTS

1. As a minimum, the following areas should be evaluated. Duplicate inspection of areas covered by other inspections need not be made.

1.1 Training program which should include instructions in the following:

- a. Industrial activity organization, including management and working levels.
- b. Industrial activity procedures and practices, including:
 - (1) OCT.
 - (2) Tag-Out.
 - (3) Ripout.
 - (4) Industrial Activity Deficiency Correction.
 - (5) General Testing Requirements. Personnel should be familiar with references (aj) and (ak).
 - (6) The industrial activity system for accomplishing planned maintenance on equipment under their cognizance.
- c. General schedule of Key Events and phases of work and testing.
- d. Safety requirements including Ship's Force and industrial activity responsibilities for:
 - (1) Dry Dock Safety.
 - (2) Fire Watches.
 - (3) Watertight Integrity.
 - (4) Reactor Plant Safety.

1.2 Status of administrative preparations, including:

- a. Ship and department organization manuals and directives to ensure administration is in accordance with current requirements.
- b. Ship and departmental training plans for implementation during construction.
- c. Procedures for qualifying underway/steaming watchstanders and maintaining proficiency for inport watchstanders, including:
 - (1) Formal provisional qualification procedures.
 - (2) Qualification goals for Key Events, such as undocking/launching, operational testing of ship and propulsion plant systems, steam testing, initial criticality, etc. The goals for Fast Cruise should include a three section watch capability for the entire crew.
- d. Procedures for maintenance and security of Ship's Force barge or office spaces.
- e. General plan for Ship's Force responsible actions including provisions for:
 - (1) Barge, berthing and messing facilities.
 - (2) Routine ship and barge watch bill.
 - (3) Scheduling of required shore based schools and leave for personnel.
 - (4) Ship's Force planned maintenance routines.
 - (5) Provisions for shift work during known periods of intensive testing (e.g., Hot Ops, Power Range Testing).

(6) Target dates for completion of key ship and department directives and procedures.

1.3 Evaluate the capability of the crew to perform industrial activity type evolutions including:

- a. Ability to review industrial activity Work Authorization Forms, major system tag-outs, and test procedures.
- b. Inport and dry dock watchstanding procedures including special inspection requirements for systems in abnormal lineups or partially removed.
- c. Ability to inspect and monitor ship conditions in relation to the special requirements for watertight integrity. This evaluation should include observation of a trim/draft change calculation by the Ship's Safety Council representative.

1.4 Ensure that Ship's Force has a satisfactory understanding of the following:

- a. Relationship with the industrial activity and Supervising Authority including ship's responsibility regarding weekly management meetings.
- b. Relationships with the ISIC and the TYCOM Type Desk, including the ship's responsibility for reporting problem areas.
- c. Relationship with the local Naval Reactors Representative.
- d. Functions and responsibilities of the Joint Test Groups (Nuclear/Hull, Propulsion and Auxiliaries/Weapons) and the Ship's Safety Council.
- e. Control mechanisms for work/tests affecting ship's condition.
- f. Relationship with the TYCOM industrial activity representative (if assigned).

APPENDIX B
AREAS TO BE EVALUATED DURING
MONITORING INSPECTIONS

1. Procedures and administrative steps for provisional watchstation qualifications.
2. Department organization manuals.
3. Department instructions and administrative procedures.
4. Ship's instructions and administrative procedures.
5. Equipment logs, operating instructions and casualty procedures.
6. Ship's standard operating procedures and the Ship's Organization and Regulations Manual.
7. Training planned and conducted to support initial qualifications for watchstander proficiency.
8. Watchstanding performance.
9. Spot checks of ship's records and logs in use.
10. Status of Ship's Force work.
11. Status of Ship's Force responsible planned maintenance.
12. Inspect installed equipment for cleanliness and adequate protection from damage.
13. Tag-Out and Work Authorization Logs. Spot check for compliance in accordance with current directives.
14. Inspect ship for hazards.
15. Inspect provisions for casualty control including watertight integrity.
16. Verify that items are drawn from the ship's Coordinated Shipboard Allowance List (COSAL) stock only on an emergency basis and that such issues are well documented with appropriate adjustments to the inventory records.
17. Evaluate general safety practices.
18. Evaluate the response of the Supply System to requisitions in support of Ship's Force work. (Post Shakedown Availability requirement only.)
19. Status of technical manuals, drawings, maintenance documentation, etc., onboard.

(This Page Intentionally Left Blank)

APPENDIX C

SAMPLE PRE-REACTOR SAFEGUARD EXAMINATION NOTICE

(Ship Name)

NOTE 3540

PCU (Ship Name and Hull No.) NOTICE 3540

Subj: PRE-REACTOR SAFEGUARDS EXAMINATION (RSE)

Encl: (1) Schedule of Examination
 (2) Officer Roster
 (3) Crew Roster
 (4) Initial Criticality and Power Range Testing Watchbill
 (5) Interview Schedule
 (6) ELT Evolution Schedule
 (7) Status of Propulsion Plant Systems and Spaces for Initial Criticality

1. Purpose. To promulgate information pertinent to the conduct of the Pre-RSE.
2. Discussion. A Pre-RSE is scheduled for PCU (Ship Name) on (Date). All examination activities will be conducted in the crew spaces in Building ___ at _____ Shipyard with the exception of observed drills and evolutions which are to be conducted onboard.
3. Inspection Team Conference Rooms. The Wardroom in Building ___ will be available for the private use of the Inspection Team throughout the examination. During the drill periods, the Wardroom aboard (Ship Name) will be available for use by the Inspection Team.
4. Responsibilities.
 - a. The Executive Officer is responsible for the overall coordination and execution of the examination per the schedule contained in enclosure (1). Crew members as designated by enclosures (2) and (3) will participate.
 - b. Enclosure (4) provides the intended watchbill for manning watches throughout initial criticality preparations and power range testing.
5. Interviews. All interviews will be conducted in accordance with the schedule contained in enclosure (5). Personnel shall not discuss the interviews until all interviews are complete.

<u>Interview (Subject Area)</u>	<u>Locations</u>	<u>Groups Interviewed</u>
A Fluids	WEPS/SUP Office	EOOW/EWS and M Div
B Reactor Theory	NAV Office	EOOW/EWS, RC Div and 2 EPCP/2 SPCP Operators
C Electrical	ENG Office	EOOW/EWS, E Div and RC Div
D CHEM/RADCON	XO Office	EOOW/EWS and all ELTs
E Integrated Plant Ops	CO Office	EOOW

(Ship Name) NOTE 3540

6. Records Review. Record reviews will be conducted in a large classroom. Records will be pre-staged in the logroom or designated area and moved to the classroom just prior to the scheduled review.

7. Meals. The (Name & Location of Mess Facility) will be available for meals. Working lunches in the (Name & Location of Mess Facility) are available.

A.B. SKIPPER

Distribution:

RSE Team (7)

(Ship Name) NOTE 3540

PRE-RSE SCHEDULE OF EXAMINATIONDD/MM

0600 Relieve the watch: Section I.
 0700 RSE Team arrives at PCU (Ship Name).
 0700-0730 Continental Breakfast in the Wardroom.
 0730-0800 Team meets with Commanding Officer, Executive Officer, and Engineer Officer to discuss the examination.
 0730 Long Form Pre-Critical Check off.
 0800-1000 ELT Evolution per enclosure (6).
 1000-1300 Individual interviews per enclosure (5).
 1100-1130 Relieve the watch: Section II.
 1130-1300 Observed evolutions and material inspection. Section II.
 1300-1330 Lunch.
 1330-1530 Individual interviews continued. Sections I, III.
 1330-1530 ELT chemistry/dosimetry observations per enclosure (6).
 1330-1530 Observed evolutions and material inspection continued.
 1500-1530 Relieve the watch: Section III.
 1530-1630 Drill Team brief shipboard in Wardroom.
 1530-1600 Inspection Team meeting in Wardroom (onboard).
 1630-1800 Drills: Section III.
 1800-1830 Relieve the watch: Section I.
 1830-2000 Drills: Section I.

DD/MM

0700 Relieve the watch: Section II.
 0700-0745 Continental Breakfast in the Wardroom.
 0730-0750 ELT Evolution per enclosure (6).
 0800-1000 Individual interviews per enclosure (5).
 0800-0900 EWS Group interview (Location).
 0800-1000 Training Records/Qualification Record review in large classroom.
 0900-1000 EOOW Group interviews.
 1000-1100 Watch Section Seminar. Section I.
 1000-1200 Admin review in large classroom.
 1200-1230 Lunch.
 1230-1630 Critique Preparations.
 1300 Relieve the watch: Section I.
 1630-1730 Critique, large classroom.

Encl (1)

SAMPLE OFFICER ROSTER

Name	Rank	Report Date	Billet	EOOW Qual Status	Prototype	Experience
IOWA STATE, '73, BS CHEMICAL ENGINEERING	CDR	91NOV21	CO	QUALIFIED	S1W JUN74-JAN75	SSN 637/E, MPA; S8G PROTOTYPE/ INST/DEPT HEAD; SSN 650/ENG; CSG2/ENG READINESS SSN 607/EXEC OFF
NROTC, '78, RPI, BS MECHANICAL ENGINEERING	LCDR	91NOV21	XO	QUALIFIED	S1C FEB79-AUG79	CMD NUC QUALIFIED; SSN 689/CRA/MPA, SONAR/FT, WEPS; SSBN 642/ENG; SSN 571/OIC
OCS, '83, PURDUE UNIVERSITY, BS CHEMICAL ENGINEERING	LCDR	91NOV21	ENG	QUALIFIED	S8G JUN84-DEC84	QUALIFIED ENG/S8G; SSBN 730/DCA, RCA
NROTC, '83, UNIVERSITY OF KANSAS, BS ELECTRICAL ENGINEERING	LT	91NOV21	NAV	QUALIFIED	S3G JUN84-DEC84	QUALIFIED ENG/S5W; SSN 661/E, MPA, TM, COMM; S1C PROTOTYPE INSTRUCTOR
NROTC, '84, MARQUETTE UNIVERSITY, BS ELECTRICAL ENGINEERING	LT	92JAN14	WEPS	QUALIFIED	A1W JAN85-JUN85	CMD NUC QUALIFIED; QUALIFIED ENG/S5W; SSN 683/CRA, RCA, E, SONAR; SSBN 659/NAV
OCS, '88, CLARKSON UNIVERSITY, BS ELECTRICAL ENGINEERING	LT	91NOV21		QUALIFIED	S3G JUL89-JAN90	QUALIFIED ENG/S6G; SSBN 654/DCA, RCA, AWEPS

SAMPLE ELECTRICAL DIVISION ROSTER

Name	Rate/NEC	Report Date	Senior Special Quals	Watch in Training % Progress	Prototype	Experience
	EMC/3364	91NOV21	EWS/EDPO	QUALIFIED	S1C JUL76-DEC76	SSBN 635/EO, SRO SSN 690/EWS, EDPO
	EM1/3364	91NOV21	EO/SRO	EWS/60%	D1G JUL76-DEC76	SSBN 598/EWS; S8G PROTOTYPE INSTRUCTOR/EWS; SSN 605/EWS; SSN 754/EWS; AS 11/R-10
	EM1/3364	91NOV21	EO/SRO	EWS/60%	S7G OCT82-APR83	SSBN 636/SRO; SSN 725/SRO, EWS; CSS2/PMT
	EM1/3364	91NOV21	EO/SRO	EWS/60%	S1C APR81-OCT81	SSBN 626/EWS; NUC FIELD A SCOL INSTRUCTOR; SSN 650/EO, SRO
	EM2/3354	92MAY25	AEA/SEO	EO/20%	S1C OCT91-APR92	
	EM2/3354	91NOV21	AEA/SEO	EO/50%	S1C APR91-OCT91	
	EM2/3354	92FEB14	EO	SRO/90%	D1G MAY89-NOV89	D1G STAFF INSTRUCTOR/SRO
	EM2/3354	91NOV21	AEA/SEO	EO/20%	A1W APR91-OCT91	

SAMPLE REACTOR CONTROLS DIVISION ROSTER

Name	Rate/NEC	Report Date	Senior Special Quals	Watch in Training % Progress	Prototype	Experience
	ETC/3363	91NOV21	EWS/EDPO	QUALIFIED	A1W AUG82-FEB83	SSBN 641 (G)/RO SSBN 641 (B)/SRO SSBN 635/SRO NPTU INSTRUCTOR
	ET1/3363	91NOV21	SRO/RO	QUALIFIED	S8G APR81-OCT81	SSN 650/SRO SSN 709/SRO NSSF NLON/R8 QUALITY ASSURANCE
	ET1/3363	91NOV21	SRO/RO	QUALIFIED	S1W FEB84-AUG84	SPU S1W/RO SSN 662/RO, SRO, EDPO, EWS
	ET1/3363	91NOV21	SRO/RO	QUALIFIED	S7G DEC82-JUN83	SSBN 634/RO, SRO NSSF RADCON
	ET2/3353	92JAN20	RT/SEO	RO/80%	D1G MAY91-DEC91	
	ET2/3353	92JAN19	RT/SEO	RO/80%	D1G MAY91-DEC91	
	ET2/3353	92FEB14	RT/SEO	RO/30%	S1C JAN90-JUL90	
	ET2/3353	91DEC27	RT/SEO	RO/50%	S1C MAY91- NOV91	

SAMPLE MACHINERY DIVISION ROSTER

Name	Rate/NEC	Report Date	Senior Special Quals	Watch in Training % Progress	Prototype	Experience
	MMCS/3365	92APR24	EWS/EDPO	QUALIFIED	D1G JUL73-JAN74	SSN 588/EWS; S8G PROTOTYPE/EWS AS 37/NUC PLANNING; SSN 712/EWS NSSF NUC PLANNING SSN 705 NSSF QUALITY ASSURANCE
	MMC/3365	91NOV21	EWS/EDPO	QUALIFIED	D1G JUL82-JAN83	SSN 717/EWS, EDPO CSS7/PMT
	MM1/3365	91NOV21	ERS	EWS/50%	S1C FEB82- AUG82	SSN 591/ERS SSN 678/EWS, EDPO
	MM1/3365	92JAN16	ERS	EWS/90%	S1W SEP81- MAR82	SSN 707/EWS, EDPO CSG7/MATERIAL
	MM1/3365	91NOV21	ERS	EWS/25%	S7G OCT83- MAR84	SSBN 728/ERS
	MM1/3365	91NOV21	ERS	EWS/25%	S1W MAR83- SEP83	SSBN 654/ERS NSSF NLON/NUC REPAIR
	MM1/3365	91NOV21	ERS	EWS/25%	S8G JAN87- AUG87	SSN 719/ERS
	MM1/3365	91DEC16	ERS	EWS/50%	S8G JAN88/JUL88	SSBN 658/EDPO, EWS

I-3C-7

SAMPLE REACTOR LABORATORY DIVISION ROSTER

Name	Rate/NEC	Report Date	Senior Special Quals	Watch in Training % Progress	Prototype	Experience
	MM1/3366	91NOV21	EWS/EDPO/LELT	QUALIFIED	S1W AUG83-MAY84	SSN 598/SRW SSN 607/ELT NSSF R-5/RCM SSN 725/EWS, EDPO, LELT SSN 762/EWS, EDPO, LELT
	MM1/3356	91NOV21	ERS	EWS/10%	S5G OCT88-APR89	S5G PROTOTYPE/ERS, ELT
	MM2/3356	91DEC31	ERUL	ERS/30%	S3G DEC88-JUN89	S3G PROTOTYPE/ELT, SRW
	MM2/3356	91NOV21	ERLL/ERF	ERUL/30%	MTS-635 JAN91-JUN91	
	MM2/3356	91NOV21	ERLL/ERF	ERUL/30%	S1C JAN91-JUN91	
	MM3/3356	92JUL17	ERF	ERLL/50%	S7G JUN91-MAR92	

**SAMPLE
ENGINEERING DEPARTMENT
INITIAL CRITICALITY
WATCHBILL**

Watch Station	Section I	Section II	Section III
EOOW			
EWS			
ERS			
RO			
EO			
RT			
AEA			
CH/CD			
ELT			
ROD CONTROL MONITOR			
SRW			
SSW	CO	XO	ENGINEER
NI MONITORS			
OTHERS: PERSONNEL NOT ON WATCH:			

NOTES:

Encl (4)

**SAMPLE
ENGINEERING DEPARTMENT
POWER RANGE TESTING
WATCHBILL**

Watch Station	Section I	Section II	Section III
EOOW			
EWS			
ERS			
RO			
EO			
RT			
AEA			
FEED STATION			
ELT			
ERLL			
ERUL			
ERF			
MANEUVERING PHONE TALKER			
HOTWELL LEVEL CONTROLLER			
STEAM DUMP 1			
2			
3			
SSW	CO	XO	ENGINEER
OTHERS: PERSONNEL NOT ON WATCH:			

NOTES:

Encl (4)

NOTE 3540

SAMPLE INTERVIEW SCHEDULE

INTERVIEWER - A - _____
 SUBJECT AREA - FLUIDS
 LOCATION: _____

<u>(DATE)</u> <u>TIME</u>	<u>SENIOR</u> <u>WATCHSTATION</u>	<u>NAME(S)</u>
0800	EOOW	
0830	EWS	
0900	ERS/ERF	
0930	ERS	
1000	ERS	
1030	EOOW	
1100	ERUL	
1130	ERUL	
1200	EWS/ERS	
1230	ERS	
1300	LUNCH	
1330	ERF	
1400	EOOW	
1430	EOOW	
1500	ERS/ERUL	

Note: Personnel not interviewed: (List)

SHIP'S MONITORS

PRIMARY: _____

ALTERNATE: _____

Encl (5)

SAMPLE INTERVIEW SCHEDULE

INTERVIEWER - B - _____
 SUBJECT AREA - REACTOR THEORY
 LOCATION: _____

<u>(DATE)</u> <u>TIME</u>	<u>SENIOR</u> <u>WATCHSTATION</u>	<u>NAME(S)</u>
0800	EWS	
0830	EO	
0900	EWS	
0930	EOOW	
1000	RO	
1030	RT	
1100	EOOW	
1130	EOOW	
1200	EOOW	
1230	EWS	
1300	LUNCH	
1330	TH	
1400	RO	
1430	RT	
1500		

Note: Personnel not interviewed: (List)

SHIP'S MONITORS
 PRIMARY: _____
 ALTERNATE: _____

NOTE 3540

SAMPLE INTERVIEW SCHEDULE

INTERVIEWER - C - _____
 SUBJECT AREA - ELECTRICAL
 LOCATION: _____

<u>(DATE)</u> <u>TIME</u>	<u>SENIOR</u> <u>WATCHSTATION</u>	<u>NAME(S)</u>
0800	EWS	
0830	EWS	
0900	RO/RO/RT	
0930	EO	
1000	EOOW	
1030	EWS	
1100	EOOW	
1130	EOOW	
1200	EO/EO/RT	
1230	AEA	
1300	LUNCH	
1330	EO	
1400	AEA	
1430	RO/RO/RT	
1500	EOOW	

Note: Personnel not interviewed: (List)

SHIP'S MONITORS

PRIMARY: _____

ALTERNATE: _____

Encl (5)

SAMPLE INTERVIEW SCHEDULE

INTERVIEWER - D - _____
 SUBJECT AREA - CHEMISTRY/RADIOLOGICAL CONTROLS
 LOCATION: _____

<u>(DATE)</u> <u>TIME</u>	<u>SENIOR</u> <u>WATCHSTATION</u>	<u>NAME(S)</u>
1000	EOOW	
1030	EOOW	
1100	EOOW	
1130	ELT	
1200	EWS	
1230	LELT	

<u>(DATE)</u>	
0800	EOOW
0830	EOOW
0900	ELT
0930	EWS

Note: Personnel not interviewed: (List)

SHIP'S MONITORS
 PRIMARY: _____
 ALTERNATE: _____

Encl (5)

SAMPLE INTERVIEW SCHEDULE

INTERVIEWER - E - _____
 SUBJECT AREA - INTEGRATED PLANT OPERATIONS
 LOCATIONS: _____

<u>(DATE)</u> <u>TIME</u>	<u>SENIOR</u> <u>WATCHSTATION</u>	<u>NAME(S)</u>
0800	EOOW	
0830	EOOW	
0900	EOOW	
0930	EOOW	
1000	N/A	
1030	N/A	
1100	N/A	
1130 - 1300	Observed Evolutions and Material Inspection	
1300 - 1330	LUNCH	
1330 - 1530	Observed Evolutions and Material Inspection	

Note: Personnel not interviewed: (List)

SHIP'S MONITORS

PRIMARY: _____

ALTERNATE: _____

Encl (5)

**SAMPLE
ELT EVOLUTION SCHEDULE**

<u>(DATE)</u>	<u>TIME</u>	<u>NAME</u>	<u>EVOLUTION</u>
	0800		PRIMARY SAMPLE
	0900		SECONDARY SAMPLE
	0930		SECONDARY SAMPLE
	1330		SECONDARY SAMPLE
	1400		SECONDARY SAMPLE
	1430		DOSIMETRY
	1450		DOSIMETRY
	1510		DOSIMETRY

Encl (6)

NOTE 3540

**SAMPLE
STATUS OF PROPULSION PLANT SYSTEMS AND SPACES
FOR INITIAL CRITICALITY**

1. Systems required for initial criticality not yet under the operational control of Ship's Force include:

(List those systems or portions of systems and components which are required for initial criticality but are not yet under the operational control of Ship's Force.)

2. Systems under operational control of Ship's Force include:

(List the systems, components and spaces under the control of Ship's Force.)

3. Significant propulsion plant material deficiencies:

(List significant propulsion plant material deficiencies.)

Encl (7)

**SAMPLE
STATUS OF PROPULSION PLANT SYSTEMS AND SPACES
FOR INITIAL CRITICALITY
(Cont'd)**

TEMPORARY SYSTEMS INSTALLED TO SUPPORT TESTING

(List the temporary systems installed to support testing.)

DRILL SIMULATIONS AND LIMITATIONS

(List the conditions and limitations of simulations. System status and conditions which are outside the normal parameters and normal configuration will be defined. Staging of “temporary” equipment or identification of expected simulations shall be specified.)

Encl (7)

**SAMPLE
STATUS OF PROPULSION PLANT SYSTEMS AND SPACES
FOR INITIAL CRITICALITY
(Cont'd)**

SIGNIFICANT ENGINEERING DEPARTMENT ADMINISTRATIVE DEFICIENCIES

Departmental

1. Qualifications. Due to significant shiftwork delays for Post-Core Fill and Hot-Ops, Phase II (Initial Criticality) qualifications are not complete. They will be completed by (Date).
2. CO RSE Interviews/Qualifications. Due to delays in qualifications noted in paragraph (1), these are not complete. The CO has issued a letter (Date) to the Engineering Department detailing the scope and conduct of these interviews. A copy of this letter has been provided to the Senior Member.
3. Change 11 to the qualification instruction is not implemented in all qualification cards (to be promulgated (Date)).
4. Some Department and EOOW/EWS exams from (Date) do not have reexam for exam failures.

Machinery Division

1. Material History
 - a. Hull and tank information recorded on Material History Cards vice Hull Cards.
 - b. No QA records - no QA work performed, no QAIs qualified.

Reactor Controls Division

1. Material History. Rod Control and SVFC Material History has not been updated with data that has just been received from recent Hot Operation Testing.

Electrical Division

1. Superseded cyclic primary PMS schedule has been accidentally destroyed.

Reactor Laboratory

(List deficiencies concerning the Reactor Laboratory.)

Encl (7)

(This Page Intentionally Left Blank)

APPENDIX D**IN-SERVICE COMPARTMENT SURVEILLANCE GUIDE
(AIRCRAFT CARRIERS AND SUBMARINES ONLY)**

1. As directed by OPNAVINST 4700.8, approximately two to four weeks for submarines, or two to four months for aircraft carriers, prior to the first Sea Trial, a nuclear ship is to be placed "In-Service". A prerequisite to placing the ship "In-Service" is satisfactory habitability conditions. There still remains industrial and fitting out work prior to ship completion and readiness for Sea Trials. The accepting authority must take the action above into consideration when scheduling the habitability inspection prior to the crew moving on board. The purpose of this inspection is to ascertain whether or not the spaces within which the crew will live, primarily berthing and messing, are clean, safe, and ready to receive the crew.
2. Spaces that are considered finished and have been inspected by Ship's Force should be complete to approved plans.
3. The following is a list of attributes which should be checked for completeness during "In-Service" inspections of spaces in the final phases of construction.
 - a. Cable hanger/banding - properly installed.
 - b. Cleanliness - equipment, equipment space, and bilge area free of industrial dirt and debris (there may be areas of light dust).
 - c. System completeness - handwheels, spray shields, etc. are installed.
 - d. Bilges - free of standing oil.
 - e. Compartment free of damage - pipe scars, arc strikes, etc.
 - f. Grounding straps - properly installed.
 - g. Lockers - stowage and shelving solidly attached and operable.
 - h. Compartment lighting - installed and operable.
 - i. Compartments - to be free from construction material and any unsecured objects that may cause a threat to personnel safety.
 - j. Safety chains, ladders, and handrails - installed, fastened in place, and per plan.
 - k. Permanent deck plates - corners bolted down, well fitted, and do not present a tripping hazard (deck plates over bilge areas need not be bolted at this time).
 - l. Welding - all structures complete.
 - m. Preservation paint - neat and complete, with approved color schemes. Basic preservation applied to all structures and equipment (areas of minor rust and bare ferrous metal are acceptable at this time in compartments in the final phases of construction).
 - n. Appearance paint (applied for cosmetics rather than preservation) - applied to routinely visible surfaces and presents a neat appearance.
 - o. Accessibility of equipment - convenient for operation, repairs, replacement, maintenance, testing, and visible use.
 - p. Store Rooms - complete (installations and painting).
 - q. Marking of equipment - valve labels, name plates, instruction and warning plates installed and readable.
 - r. Protection of equipment from any damage - as required by plans or planned maintenance guidance (e.g., Scott Foam).
 - s. Berthing/Messing arrangement - proper type, accessibility, clearance, seating capacity, etc. per plan.
 - t. Joiner work - compartment bulkheads/overhead structures, moldings, and furniture installation complete and presents a neat appearance; formica will be free of damage.

- u. Condition of deck coverings (Tile/Terrazzo) - free of any damage and major discoloration.
- v. Watertight and non-watertight doors - installation complete, well fitted, with proper operation (ease of opening and closing) and protection devices installed.

APPENDIX E

**SAMPLE PRE-COMMISSIONING HABITABILITY
INSPECTION CHECKLIST FOR NEW CONSTRUCTION SHIPS**

Ref: (a) OPNAVINST 4700.8 - Trials, Acceptance, Commissioning, Fitting Out, Shakedown and Post Shakedown Availability of U.S. Naval Ships Undergoing Construction or Conversion

1. A pre-commissioning habitability inspection is required for new construction ships by reference (a). The purpose of the inspection is to verify that living and messing spaces are clean, safe and ready to receive the crew. Upon completion of the inspection, the inspection team leader will provide copies of the deficiency list to the Navy Shipbuilding Program Manager's representative, the Supervising Authority, the Commanding Officer of the ship's pre-commissioning unit and the TYCOM.
2. This assessment is not of the magnitude or detail required by the Supervising Authority to ensure shipbuilder compliance with all building specifications in the contract or by the Board of Inspection and Survey during acceptance trials. This assessment is a qualitative judgment of the ability of the crew to live on board safely and comfortably during the fitting out period. This assessment does not fulfill shipboard system certification requirements or other inspection requirements related to food service sanitation, laundry and dry cleaning, potable water and marine sanitation devices.
3. Areas to be inspected include general safety and sanitation, galley, scullery, messing, dry food storage spaces, refrigerated food storage spaces, berthing spaces, washrooms, showers, heads, lounges and potable water. Only spaces designated to support initial crew move aboard will be inspected. For example, if only the aft galley will be used at move aboard, the forward galley will not be inspected.
4. It is understood that not all equipment, spaces and systems aboard the ship will be completed and transferred to Ship's Force at the time of the assessment. If a space/system to be inspected has not been transferred to the crew, the shipbuilder and Supervising Authority will present the space/system to the inspector. If a space/system has been accepted by the crew, the crew will present the space; cognizant shipbuilder and Supervising Authority personnel should be present. As remaining habitability related spaces/systems are completed after crew move aboard, the Supervising Authority and Ship's Force are responsible for inspecting spaces/systems per the turnover procedure specified in the contract.
5. The pre-commissioning habitability inspection team will evaluate the following areas utilizing the enclosed inspection checklists:
 - A. General
 - B. Food Service
 - C. Living Spaces
 - D. Freshwater
 - E. Collection, Holding and Transfer (CHT) System (See Note)
 - F. Laundry and Dry Cleaning (See Note)

Note: Operational laundry facilities and waste removal systems are considered desirable to support crew move aboard. If requested by the Supervising Authority the inspection team will assess the readiness of these areas during the habitability inspection. Other crew support spaces, such as Barber Shops, may also be included in the inspection if requested by the Supervising Authority and agreed upon by the inspection team.

(This Page Intentionally Left Blank)

**SAMPLE PRE-COMMISSIONING HABITABILITY
INSPECTION CHECK LIST FOR NEW CONSTRUCTION SHIPS (Cont'd)**

Compartment Number: _____ Division: _____

	<u>YES</u>	<u>NO</u>
<p>A. GENERAL</p> <ol style="list-style-type: none"> 1. All trash and rubbish removed. 2. Spaces neat, clean and in a usable condition. 3. Wireways and other exposed areas that could serve as a path for rats are free of foreign matter. 4. Electrical wires or plugs are not located so as to be easily tripped over. 5. Drains open with covers attached. 6. Ventilation (heating and cooling) and lighting adequate to maintain healthful and comfortable conditions. 7. Electrical outlets required for habitability are installed and operable. 8. Spaces are free of major safety discrepancies. 9. Damage Control equipment installed per ship plan and labeled. <p>B. FOOD SERVICE</p> <ol style="list-style-type: none"> 1. Facility <ol style="list-style-type: none"> a. Decks sloped properly to allow drainage into deck drains. b. Adequate and convenient hand washing facilities with hot and cold running water, dispensed soap and single service disposable towels provided in or adjacent to food service facility (OPNAVINST 5100.19, Section IV CH2, Part D.2). c. Drain lines from refrigerators, ventilator hoods and other food service equipment drain through an air gap into a deck drain or funnel with removable grating (NAVSUPINST 4061.11; GEN SPECS sect. 528 (if cited in the contract)). d. Signs posted reminding personnel to wash hands and to not smoke (NAVMED P-5010, Article 1-6). e. Equipment operating and safety instructions prominently posted on or conspicuously near the equipment to which it relates (OPNAVINST 5100.19, Section V). f. Steam and hot water lines properly lagged and sheathed (OPNAVINST 5100.19, Enclosure (1), Section III). g. Furniture installed in prescribed arrangement and neat, clean and in usable condition. 		

Inspector: _____ Date: _____

	<u>YES</u>	<u>NO</u>
<p>h. Racks and bins installed in storerooms.</p> <p>2. Equipment</p> <p>a. Deck mounted equipment sealed to the deck or elevated on legs that provide at least 8 inches of clearance between the deck and equipment (NAVMED P-5010, Article 1-8).</p> <p>b. Decks in food service areas maintained in good repair (NAVMED P-5010, Article 1-15).</p> <p>c. All equipment accessible.</p> <p>d. Food contact surfaces made of smooth, corrosion resistant, non-toxic (FDA Food, Drug and Cosmetic Act guidelines), stable non-absorbent materials that will not impart odors, color or taste, nor contribute to adulteration of food (NAVMED P-5010, Article 1-8 (3)).</p> <p>e. Vegetable peelers, vegetable slicers, can openers, meat slicers, ranges, ovens, grills, deep fat fryers, microwave ovens, toasters, mixing machines, pressure cookers, steam jacketed kettles, steam tables, steam table and salad bar inserts, soft ice cream machines, baking and roasting pans, cooking and serving utensils, food carts, storage racks and shelving properly installed, sanitized and operationally tested (NAVMED P-5010, Article 1-17; NAVSUP P-421, Chapter 2).</p> <p>f. On/off toggle switches on food service equipment have toggle switch guards installed to prevent inadvertent operation (OPNAVINST 5100.19, Section V).</p> <p>g. Safety interlocks on food preparation equipment maintained in proper operating condition.</p> <p>h. Steam Jacketed Kettles.</p> <p>(1) Equipped with functional steam safety release valve (GEN SPECS, Section 528, Article C 1905 g(4)) if applicable.</p> <p>(2) Chains at least 18 inches long attached to steam safety release valves (GEN SPECS, Section 528, Article C1905 g(4)) if applicable.</p> <p>(3) Steam discharge piped down to kettle coamings and directed away from operators feet (GEN SPECS, Section 651 b) if applicable.</p> <p>i. Equipment free from salt water connections except NAVMEDCOM approved garbage grinders or refrigeration units (NAVMED P-5010, Article 1-8 (3)).</p> <p>j. Food service spaces and equipment free from cross connections with non-potable liquids or submerged freshwater inlets (NAVMED P-5010, Articles 1-47, 1-61 and 1-8 (3)).</p>		

Inspector: _____ Date: _____

	<u>YES</u>	<u>NO</u>
<p>3. Ventilation</p> <ul style="list-style-type: none"> a. Grease filters and hoods are installed in appropriate places, are free from grease buildup and can be washed at least weekly (NAVMED P-5010, Article 1073; NAVSUPINST 4061.11). b. Ventilation grease interceptor hoods (Gaylords) are installed in proper places and are able to be cleaned daily (NAVSUPINST 4061.11). c. Spaces adequately ventilated to keep them free of excessive heat, steam, condensation, vapors, smoke or gases. d. Vent ducts free of excessive grease and debris which could be a fire hazard. 		
<p>4. Lighting</p> <ul style="list-style-type: none"> a. Illumination levels adequate. b. Lighting fixtures in food service areas shielded. 		
<p>5. Refrigeration</p> <ul style="list-style-type: none"> a. Frost build-up no more than 1/4 of an inch (NAVMED P-5010, Article 1-34). b. Refrigeration spaces clean (NAVMED P-5010, Article 1-31). c. One portable or built-in air measurement thermometer provided in all refrigerated storage spaces which is accurate to +/- 3°F. d. Refrigerated spaces maintained at (NAVMED P-5010, Article 1-34): <ul style="list-style-type: none"> (1) Freezers 0°F or lower. (2) Chilled Bulk Storage 33-36°F. (3) Thaw Boxes 36-38°F. (4) Dairy Products Box 32-34°F. (5) Milk Dispenser Cabinet 32-40°F. (6) Reach-in Refrigerator 34-40°F. e. Interior safety release latches installed and operable in all bulk refrigeration and freezer units (NAVSUPINST 4061.11). 		
<p>6. Serving Lines and Salad Bars</p> <ul style="list-style-type: none"> a. Serving line areas clean. b. Functional sneeze shields installed on serving lines and salad bars (NAVMED P-5010, Article 1-40). c. Serving line inserts heatable to a minimum of 140°F (NAVMED P-5010, Article 1-40). 		

Inspector: _____ Date: _____

	<u>YES</u>	<u>NO</u>
d. Salad bars capable of being maintained at 40°F or below (NAVMED P-5010, Article 1-40).		
7. Milk Dispensers and Holding Cabinets		
a. Bulk milk dispenser and holding cabinets capable of being maintained at 32-40°F (NAVMED P-5010, Article 1-21).		
b. Dispenser and holding cabinets have accurate temperature gages or thermometers.		
c. Dairy box capable of being maintained at 33-34°F (NAVMED P-5010, Article 1-34).		
8. Ice Machines		
a. Ice compartment drains are aligned to the deck drains with an air gap (NAVMED P-5010, Article 1-36).		
b. Ice scoop, stored handle up, in a covered and freely draining bracket outside ice storage compartment or inside the ice machine on a bracket above the highest level of the ice (NAVMED P-5010, Article 1-36).		
9. Manual Dishwashing		
a. Utensils move from dirty to clean side of wash area without risk of cross contamination by handling or splashing.		
b. A three compartment sink installed for washing pots, pans and utensils.		
c. Booster heater installed and functional.		
d. Temperature gage installed or thermometer used to monitor wash and rinse temperatures.		
e. Wash water temperature ranges between 95-125°F.		
f. Final rinse water temperature reaches at least 170°F.		
g. Long-handled dip baskets available.		
10. Dishwashing Machine		
a. Center and end curtains installed.		
b. Temperature gages accurate to +/- 3°F.		
c. Multiple tank conveyor dishwashing machine meets following requirements (NAVMED P-5010, Article 1-9):		
(1) Wash temperature 150-160°F for 7 seconds.		
(2) Rinse temperature 160-180°F for 7 seconds.		
(3) Final rinse temperature 180-195°F with a conveyor speed of 15 feet per minute at 15 - 25 psi or as specified in the machine technical manual.		

Inspector: _____ Date: _____

- d. Operating instructions posted on, or conspicuously near, the machine (OPNAVINST 5100.19, Section V. 16).

C. LIVING SPACES

1. Bunks and lockers neat and in usable condition and bunk curtains installed.
2. Plumbing fixtures installed in washrooms, showers and water closets, including shower heads and soap dishes and other necessary items.
3. Prescribed deck covering installed.
4. Adequate furniture and equipment installed to provide reasonable comfort, relaxation and entertainment in lounge areas.
5. Berthing spaces are clean, adequately ventilated and well illuminated (OPNAVINST 9640.1 and NAVMED P-5010, Chapter 2).
6. Drinking fountains are of the jet-angle type with clean bowls, orifices and orifice guards (NAVMED P-5010, Chapter 2).
7. No Category I flammables, combustibles or aerosol containers stored in berthing spaces (NSTM 670).
8. Sinks, urinals and commodes are clean, odor free and operable (NAVMED P-5010, Chapter 2).
9. The temperature of the hot water supplied for personal use of the crew does not exceed 130°F (NSTM 533).
10. Temperatures in berthing and messing spaces do not exceed 80°F (OPNAVINST 9640.1).
11. Temperatures in living, sanitary, messing, medical, control spaces, and normal working stations are not lower than 65°F (OPNAVINST 9640.1).
12. There are separate sleeping quarters for males and females (OPNAVINST 1300.17).

D. FRESHWATER

1. Surveillance
 - a. Halogen residual present (NAVMED P-5010, Chapter 6, Article 52).
 - b. Bacterial analysis obtained from points representative of the entire distribution system (NAVMED P-5010, Chapter 6, Article 53).

<u>YES</u>	<u>NO</u>

Inspector: _____ Date: _____

	<u>YES</u>	<u>NO</u>
<ul style="list-style-type: none"> c. Ice machines tested for bacterial contamination (NAVMED P-5010, Chapter 6, Article 53). d. Potable water processed or obtained from an approved source (NAVMED P-5010, Chapter 6, Article 54). 		
<p>2. Bromination System and Equipment (when applicable)</p> <ul style="list-style-type: none"> a. Brominators are properly installed and functional (NAVMED P-5010, Chapter 6, Article 21). b. Warning plate installed next to unit (NSTM Chapter 533, Section 3.1.3.2.3 and Figure 533-5). c. Four foot hose with quick opening valve and vacuum breaker installed nearby (NSTM Chapter 533, Section 3.1.3.2.2). d. Bromine cartridges stored in dry, clean, well-ventilated storeroom (NSTM Chapter 533, Section 3.1.3.2.1). e. Locker or bin has label plate inscribed "Bromine Cartridges" (NSTM Chapter 533, Section 3.1.3.2.1). f. Storage locker has warning plate (NSTM Chapter 533, Section 3.1.3.2.1 and Figure 533-6). 		
<p>3. Chlorination System and Equipment</p> <ul style="list-style-type: none"> a. HTH stored in a metal box with three 1/4" holes, painted gray and labeled with red letters on white or black background "HAZARDOUS MATERIAL, CALCIUM HYPOCHLORITE" (OPNAVINST 5100.19, Chapter 23). b. HTH lockers not installed in machinery space, flammable liquids store room, berthing space or oil and water test lab areas (OPNAVINST 5100.19, Chapter 23). 		
<p>4. Sounding Tubes</p> <ul style="list-style-type: none"> a. Equipped with screw caps (NAVMED P-5010, Article 6-8.3). b. Screw caps have keeper chains attaching them to sounding tubes (NAVMED P-5010, Article 6-8.3). c. Padlocks secure caps (NSTM, Chapter 533, Section 2.3.6). d. Label plates present (NAVMED P-5010, Article 19.1). e. Caps color coded dark blue (NAVMED P-5010, Article 19.1). 		
<p>5. Potable Water Hoses</p> <ul style="list-style-type: none"> a. New hoses disinfected with solution not less than 100 ppm FAC for at least 2 minutes (NSTM, Chapter 533, Section 3.3.3). b. Labeled "Potable Water Only" at 10 foot intervals (NAVMED P-5010, Article 6-19 and NSTM Chapter 533, Section 2.1.3). 		

Inspector: _____ Date: _____

	<u>YES</u>	<u>NO</u>
<ul style="list-style-type: none"> c. End couplings color coded dark blue (NAVMED P-5010, Article 6-19). d. Stored with ends capped or coupled together (NSTM, Chapter 533, Section 2.1.3). e. Hoses not used for any other purpose (NAVMED P-5010, Article 6-8 and NSTM Chapter 533, Section 2.1.3). 		
6. Potable Water Hose Lockers		
<ul style="list-style-type: none"> a. Located at least 18 inches off deck and hose disinfecting instructions posted in a conspicuous location in the hose storage areas (NAVMED P-5010, Article 6-8 and NSTM 533, Section 2.1.3). b. Padlocked, vermin proof and labeled "Potable Water Hose" (NAVMED P-5010, Article 6-8 and NSTM 533, Section 2.1.3). 		
7. Potable Water Receiving Connections		
<ul style="list-style-type: none"> a. Located at least 18 inches off deck, are not cross connected with any non-potable waterline or system and are turned down to protect against contamination (NAVMED P-5010, Article 6-8 and NSTM 533, Section 2.1.2). b. Conspicuously designated by warning plate "Potable Water Only", closed with screw cap when not in use, and cap has keeper chain attached to riser (NAVMED P-5010, Article 6-8 and NSTM 533, Section 2.1.2). c. Valve handwheel color coded dark blue (NSTM 505). 		
8. Cross Connections		
<ul style="list-style-type: none"> a. Potable water connections to the following equipment provided with either an air gap of at least two supply pipe diameters, or a vacuum breaker backflow preventer installed at least six inches above the maximum potable fill level (NSTM, Chapter 533, Sections 2.3.3.1 and 2.3.5.2): <ul style="list-style-type: none"> (1) X-ray and photo developing equipment and associated chemical mixing tanks. (2) Laundry washing machines. (3) Diesel engine cooling jackets. (4) Garbage disposals. (5) Gaylord hood automatic washdown system (vacuum breaker installed upstream from detergent injector) (GEN SPECS, Section 532b3) if applicable. (6) Steam tables, steam kettles, potato peelers, sinks and other food service equipment. (7) Bridge/helicopter control tower window washer tanks. 		

Inspector: _____ Date: _____

	<u>YES</u>	<u>NO</u>
<p>(8) Other equipment containing non-potable liquids.</p> <p>b. Continuous pressure backflow preventer with intermediate vent provided wherever a permanent or hose connection is made below the overflow level of equipment containing non-potable liquids and a manual or automatic cutout valve is installed downstream of the vacuum breaker (GEN SPECS, Section 532bl) if applicable.</p> <p>c. Reduced pressure backflow preventer provided wherever a permanent or hose connection is made to equipment or a system that could subject the potable water system to a positive pressure such as the chill water expansion tank (GEN SPECS, Section 532bl) if applicable.</p> <p>d. Sink and space faucets with standard 3/4 inch hose threads equipped with a hose connection vacuum breaker (NSTM 533, Section 2.3.5.1).</p> <p>e. Laboratory and shop (photo and battery shop) sinks with non-standard hose connections equipped with either an integral vacuum breaker or hose vacuum breaker (NSTM 533, Section 2.3.5.2).</p> <p>f. Hose connections to the potable water system disconnected when not in use (NSTM 533, Section 2.3.4).</p> <p>g. Label plate having the following wording in one inch high red letters installed in a conspicuous location near each hose connection to the potable water system: "CAUTION DISCONNECT HOSE WHEN NOT IN USE" (NSTM 533, Section 2.3.4).</p> <p>h. Two check valves installed in the potable water supply to carbonated beverage dispensers with no copper, brass or bronze pipe, valves or fittings downstream of check valves (GEN SPECS 532, Section 532bl) if applicable.</p> <p><u>E. CHT SYSTEM</u></p> <p>1. Personal Hygiene</p> <p>a. Handwashing facilities located in or near pump rooms or comminutor spaces (OPNAVINST 5100.19, C1504.1.(6) and NSTM 593, Section 4.2.14.7).</p> <p>b. Signs posted in CHT spaces near each sewage pump controller requiring hand washing with soap and water prior to leaving area, and prohibiting eating, drinking and smoking while work is in progress (NAVMED P-5010, Chapter 7, Article 19(6) and NSTM 593).</p> <p>2. Pump Room Safety</p>		

Inspector: _____ Date: _____

	<u>YES</u>	<u>NO</u>
<ul style="list-style-type: none"> a. Slightly negative pressure exhaust ventilation with duct installed 9 inches from the deck in CHT pump rooms (NAVMED P-5010, Chapter 7, Article 22 and NSTM 512). b. Indicator light installed outside compartment indicating ventilation system is operating (NAVMED P-5010, Chapter 7, Article 22). c. Two emergency escape breathing devices (EEBD) placed in each CHT pump room (NAVMED P-5010, Chapter 7, Article 22 and NSTM 593, Section 4.2.21.3.1.4). d. Placard installed at the access of each CHT pump room outlining safety precautions to be followed if a sewage spill occurs (NAVMED P-5010, Chapter 7, Article 22d). e. Warning sign posted near each sewage pump controller: "CAUTION, WHEN HIGH LEVEL ALARM SOUNDS DIVERT UPPER DECK DRAINS OVERBOARD AND CLOSE ISOLATION VALVES ON DRAINS BELOW OVERBOARD DISCHARGE" (GEN SPECS 593a) if applicable. f. Audible and visual alarms for high and low sewage tank levels wired to signal in a continuously manned station and in the CHT pump room (NSTM 593, Section 4.2.5 and GEN SPECS 593a). 		
<p>3. Ship-Shore Transfer</p> <ul style="list-style-type: none"> a. Sewage fuser properly labeled (GEN SPECS 593a). b. Label plates at each deck discharge connection with warning against disconnecting sewage hose while it is pressurized, hose hook-up/disconnect procedures and sanitary and health precautions (GEN SPECS 593a) if applicable. 		
<p>4. Surveillance</p> <ul style="list-style-type: none"> a. Removable drip pans installed beneath comminutors mounted off deck, or a two to four inch coaming around deck-mounted comminutors to aid in detection of possible leakage (NSTM 593, Section 4.2.14). b. Removable drip pans provided in health sensitive areas under valves and take-down joints to detect possible leakage (NSTM 593, Section 4.2.14). 		
<p>5. General Requirements</p> <ul style="list-style-type: none"> a. CHT space capable of containing sewage spills (NSTM 593, Section 4.2.14 and GEN SPECS 593a). b. Proper color-coding of handwheels, valves, fusers and caps (NSTM 505, Table 505-16). c. Functional eductor or sump pump installed in CHT spaces (NSTM 593, Section 4.2.14). 		

Inspector: _____ Date: _____

F. LAUNDRY AND DRY CLEANING

1. Laundry and dry cleaning facilities are operational (OPNAVINST 9640.1).
2. Adequate ventilation available (NAVMED P-5010, Article 2-40.1).
3. Fixtures and appliances connected to prevent backflow or cross-connection with the potable water supply (NAVMED P-5010, Article 2-37.3).
4. Adequate drinking water furnished by drinking fountain (NAVMED P-5010, Article 2-37.4).
5. Rooms or spaces designed, and machines and equipment arranged, so that a separate flow of clean and soiled garments will be maintained through the laundry or cleaning process (NAVMED P-5010, Article 2-37.8).
6. All steam and hot water pipes are insulated with approved (non-asbestos) lagging (NAVMED P-5010, Article 2-40.2).
7. Adequate lighting levels are provided (NAVMED P-5010, Article 2-40.3).
8. Automatic safety devices on all equipment clearly identified and operational (NAVMED P-5010, Article 2-40.7).
9. Guard rails are installed for ironers, compressors, and other dangerous pieces of equipment. Drive shafts, exposed belts, and gears should be enclosed (NAVMED P-5010, Article 2-40.8).

<u>YES</u>	<u>NO</u>

Inspector: _____ Date: _____

VOLUME I
CHAPTER 4
TRIALS

REFERENCES.

- (a) OPNAVINST 9080.3 - Procedures for Tests and Trials of Navy Nuclear Powered Ships Under Construction, Modernization, Conversion, Refueling and Overhaul
- (b) COMNAVAIRLANTINST 9080.2 - Conduct of Trials and Inspections Incident to Construction, Overhauls or Availabilities of Nuclear Powered Aircraft Carriers (CVN)
- (c) COMNAVAIRLANT/COMNAVAIRPACINST 3500.20 - Aircraft Carrier Training and Readiness Manual
- (d) OPNAVINST 4700.8 - Trials, Acceptance, Commissioning, Fitting Out, Shakedown and Post Shakedown Availability of U.S. Naval Ships Undergoing Construction or Conversion
- (e) COMNAVSURFLANT/COMNAVSURFPACINST 3502.2 - Surface Force Training Manual
- (f) INSURVINST 4730.2 - Trials and Material Inspections of Submarines
- (g) NAVSEA S9086-C4-STM-000 - NSTM Chapter 094 (Trials)
- (h) INSURVINST 4730.1 - Material Inspections (MI) of Surface Ships
- (i) NAVSEAINST C9094.2 - Submarine Valve Operation Requirements for Builders and Post-Overhaul Sea Trial Test Dives
- (j) OPNAVINST C3000.5 - Operation of Naval Nuclear Powered Ships
- (k) OPNAVINST 4730.5 - Trials and Material Inspections of Ships Conducted by the Board of Inspection and Survey
- (l) INSURVINST 4730.11 - Preparation of Deficiency Forms
- (m) NAVSEAINST 4790.8/OPNAVINST 4790.4 - Ships' Maintenance and Material Management (3-M) Manual
- (n) NAVSEA S0300-B2-MAN-010 - Supervisor of Shipbuilding, Conversion and Repair Operations Manual
- (o) OPNAVINST C9210.2 - Engineering Department Manual for Naval Nuclear Propulsion Plants
- (p) COMNAVSUBFOR OPORD 2000
- (q) COMSUBLANTINST 5400.4/COMSUBPACINST 5400.7 - Submarine Force, U.S. Atlantic/Pacific Fleet Regulations

LISTING OF APPENDICES.

- A Specific Dock Trial Test Areas
- B Minimum Fast Cruise Requirements
- C Listing of Tests to Be Performed During Aircraft Carrier Builder's Trials
- D Listing of Tests to Be Performed During Initial Tightness Dive
- E Escort Ship Capabilities for Submarine Sea Trials
- F Listing of Tests to be Performed Prior to, During and Following First Dive to Test Depth
- G Submarine Sea Trial Situation Report (SITREP)

4.1 **PURPOSE.** To identify the Trials incident to new construction, provide a brief description of each, identify unique support requirements and list specific test areas.

4.2 **DOCK TRIALS.**

4.2.1 **Purpose.** To demonstrate that major systems and equipment is ready to support Fast Cruise and Sea Trials.

4.2.2 **Conduct.** Dock Trials are conducted by Ship's Force in accordance with reference (a) for nuclear powered ships and in accordance with the Builder's Contract for Surface Force Ships. Normally a period of one day is assigned for integrated Dock Trials, tests and evolutions.

4.2.3 Scheduling. Dock Trials must take place prior to crew certification for submarines, prior to Fast Cruise for aircraft carriers and prior to the first Ship's Force underway period for Surface Force Ships. Dock Trials should be scheduled by mutual agreement between the ship, shipbuilder and the Supervising Authority. Dock Trials should be completed with adequate time allowed to correct deficiencies.

NOTE: THE SHIPBUILDER/SUPERVISING AUTHORITY MAY DESIRE TO CONDUCT "MACHINERY CHECKOUT" OR SYSTEM CHECKS PRIOR TO DOCK TRIALS IN ORDER TO TEST SHIP SYSTEMS. COMPLETION OF REPAIRS AND MODIFICATIONS ARE NOT REQUIRED EXCEPT FOR SYSTEMS THAT DIRECTLY SUPPORT THE TESTS. IN ORDER TO SUPPORT THESE EVOLUTIONS, CLOSE LIAISON BETWEEN THE PROSPECTIVE COMMANDING OFFICER (PCO)/OFFICER IN CHARGE (OIC) AND THE SHIPBUILDER/SUPERVISING AUTHORITY WILL BE REQUIRED.

NOTE: SHIP'S FORCE MUST HAVE OPERATIONAL CONTROL OF ALL SHIP'S SYSTEMS REQUIRED FOR SEA TRIALS PRIOR TO THE CONDUCT OF DOCK TRIALS.

4.2.4 Specific Test Areas. There are specific tests which relate to both system and ship safety which must be conducted in preparation for Fast Cruise and Sea Trials. Appendix A of this chapter lists the minimum alongside tests to be conducted by Ship's Force during Dock Trials. References (b) and (c) provide additional information for aircraft carriers.

4.3 FAST CRUISE.

4.3.1 Purpose. To train the crew and determine the crew's ability to safely take the ship to sea.

4.3.2 Conduct.

- a. Fast Cruise is conducted in accordance with references (a), (d), and (e).
- b. In addition to the normal underway routine, the Commanding Officer (CO) or OIC shall have all equipment operated to check for proper operation and to determine the state of training of the crew. Fast Cruise shall, as far as is practical, simulate at-sea operating conditions. It is to be conducted by Ship's Force and is to be unhampered by construction or repair work or by movement of industrial activity personnel through the ship. Neither the shipbuilder nor the Supervising Authority shall schedule any trials, tests or other work on the ship during this period.
- c. The ship will be operated as if underway, simulating the various evolutions required for safe operation. Each underway watch section shall be exercised in the evolutions which are normally performed on a section basis. Check out all communication systems during each evolution. Ensure that each is in proper working order and that, where duplicate systems exist, a priority system is designated.
- d. (Submarines only) The Fast Cruise should be a minimum of four days in duration. It should be completed within a five-day period. It should end not more than three days prior to underway trials. Normally, the ship will go to sea for underway trials within a day after completion of Fast Cruise. Should the 72 hour period be exceeded, the Type Commander (TYCOM) may direct an additional Fast Cruise.

4.3.3 Scheduling. Fast Cruise is scheduled immediately prior to underway trials. Approximately 7 days prior to the first underway trial, the Supervising Authority with the concurrence of the CO/OIC notifies the Navy Shipbuilding Program Manager that the ship is ready to commence Fast Cruise (Volume I, Chapter 2, paragraph 2.4.1.v of this manual refers).

4.3.4 Specific Test Areas. Appendix B of this chapter lists the minimum evolutions and drills to be conducted during Fast Cruise. Additional drills and evolutions are at the discretion of the PCO or OIC. References (b) and (c) provide additional information for aircraft carriers, reference (e) for Surface Force Ships.

4.3.5 Reports (Nuclear Powered Ships only). The Supervising Authority with concurrence from the PCO/OIC reports the successful completion of Fast Cruise using the format of Volume I, Chapter 2, Appendix B₇ of this manual (submarines only). Volume I, Chapter 2, paragraph 2.4.1 of this manual refers.

4.4 SEA TRIALS.

4.4.1 General.

- a. The policies, procedures and responsibilities pertaining to Sea Trials for ships undergoing construction are set forth with reference (d). References (a), (f), (g) and (h) augment the basic instruction.
- b. Sea Trials for the various platforms undergoing construction differ in complexity, conduct and scope of Ship's Force involvement. Surface Force Ship platforms such as the DDGs or LHDs go through Builder's Trials (BT) which for the most part are conducted with little to no involvement by Ship's Force. Industrial activity employees take the ship to sea and perform the majority of system/equipment testing. Paragraph 4.4.2 of this chapter provides additional information concerning BTs.
- c. Nuclear powered ships' Sea Trials, however, are much more orientated to Ship's Force involvement. Ship's Force is responsible for taking the ship to sea and operating all shipboard equipment. The terms Alpha Trial, Bravo Trial, Charlie Trial, Combined Trial (CT) and Guarantee Material Inspection (GMI) are most often associated with submarine Sea Trials whereas aircraft carriers undergo BTs prior to Acceptance Trials (AT). Subsequent paragraphs provide amplifying information concerning these trials.
- d. Underway trials following construction, particularly initial submerged and test depth trials for submarines, must be undertaken with the knowledge that the crew lacks recent experience operating as a unit and that the ship's structure and fittings have not been tested in an at-sea environment. All tests and procedures must be conducted carefully and methodically. In the case of submarines, systems and components designed to operate at test depth should not be exercised at test depth for the sole purpose of proving the design. They should be operated at the deepest depth at which they might be used. Trials and tests which are inherently hazardous should not be conducted. For example, a submarine's hovering system should not be demonstrated at test depth. Reference (i) provides additional information concerning the testing of submarine seawater systems during underway Sea Trials. Sea Trials following new construction are normally conducted with a significant number of "riders". These riders represent Naval Sea Systems Command (NAVSEA), TYCOM, Shipbuilder and Board of Inspection and Survey (INSURV) personnel onboard to observe various tests and trial evolutions. The ship's normal load out of Lithium Hydroxide canisters, Lithium Hydroxide curtains, Emergency Air Breathing (EAB) masks, Submarine Escape Immersion Ensemble suits and Oxygen candles is not sufficient to support this increase in personnel. Therefore, an additional four Lithium Hydroxide canisters, four Lithium Hydroxide curtains, one EAB mask, one Submarine Escape Immersion Ensemble suit (as applicable), and two oxygen candles shall be carried for each rider exceeding normal crew manning. Lithium Hydroxide canisters, EABs, Submarine Escape Immersion Ensemble suits (as applicable) and Lithium Hydroxide curtains are to be obtained from the industrial activity.
- e. The following general conditions apply:
 - (1) A shipbuilder generated, Supervising Authority/Navy Shipbuilding Program Manager/TYCOM approved agenda is required for each Sea Trial.
 - (2) All trial periods must be organized such that each member of the crew has an opportunity to get six uninterrupted hours of sleep during each 24 hour period. Sea Trial elements which can be accomplished by a normal watch section may be conducted concurrently with crew rest periods.
 - (3) Sea Trials should normally be scheduled to allow at least three weeks between CT/AT and the scheduled delivery date.
 - (4) The prerequisites for aircraft carrier and submarine Sea Trials are a Pre-Critical Reactor Safeguard Examination (RSE), Crew Certification, Dock Trials and Fast Cruise.
 - (5) Each submarine watch section shall be provided with approximately two hours experience submerged at moderate speeds prior to the deep dive or full power run.

- (6) Critical operation of reactors while naval nuclear powered ships are in a Naval or private industrial activity will be governed by reference (j). Prior to delivery, permission to conduct critical reactor plant operations must be obtained by the Supervising Authority from NAVSEA Nuclear Propulsion Directorate (08).
- (7) During inspections, deficiencies should be limited to those items for which a correction is mandatory to ensure safe operation during Sea Trials.
- (8) At the start of Fast Cruise the ship should be ready in all respects for the commencement of Sea Trials with the exception of the additional training the crew will receive during Fast Cruise.
- (9) Inspectors must determine that all work/testing necessary to support Sea Trials has been completed or identified for completion prior to commencement of Fast Cruise including the following:
 - (a) All ship systems which affect safe operation during Sea Trials must be operable.
 - (b) All work necessary for safe operation of the ship during Sea Trials has been satisfactorily completed and tested. Included must be a check for any special configuration or installations ensuring that they have been authorized by the proper authority (NAVSEA and TYCOM), that their impact has been fully assessed and that the Sea Trial agenda addresses these impacts or limitations.
- (10) NAVSEA and the Supervising Authority are expected to properly discharge their responsibilities for quality assurance and control of authorized industrial work (e.g., it is not necessary for the Immediate Superior in Command (ISIC) inspections to inspect the quality of the pressure hull radiographs or other nondestructive test records of the industrial activity).
- (11) Following completion of the required training and material readiness certification, the CO/OIC must keep the ISIC fully informed of any changes in personnel, training and/or material status which could affect the validity of certification. Prompt notification is required to permit revision of Operational Orders and services required.
- (12) (Submarines only) Prior to getting underway for Sea Trials, Shipyard, Ship's Force and Type Commander shall jointly agree that the required seven day supply of Oxygen (O₂) and seven day supply of Carbon Dioxide (CO₂) removal capacity will be available in each compartment, based upon the number of expected occupants of that compartment, independent of the supply and removal capacity in the other compartment(s).
- (13) Sea Trial Situation Reports (SITREP) (Submarines only). Ships executing Sea Trials associated with a new construction program shall submit daily SITREPs using the message format in Appendix G in accordance with the SITREP guidelines contained in Volume II, Part I, Chapter 3, paragraph 3.6.8.3.9 of this manual.

4.4.2 Builder's Trials. BTs conducted by a private shipbuilder are normally comprised of a Builder's Dock Trial (BDT) and one or more Builder's Sea Trials (BST). Some DDGs are currently undergoing three BSTs. The first BST, referred to as an Alpha Trial by the DDG community, is primarily a propulsion plant trial. The second BST, referred to as a Bravo Trial, primarily covers Combat System evolutions and the third BST is the AT. While the actual content of BSTs will be dependent upon the platform, the primary purpose is still the same; the validation of ship's equipment and systems in preparation for Charlie Trials/AT. Appendix C of this chapter provides a sample listing of tests to be performed during an aircraft carrier's BT.

4.4.3 Alpha Sea Trial (Submarines only). A submarine's first underway period primarily conducted for propulsion plant testing and the initial tightness dive. (First ship of each class normally conducts a dive to Test Depth during this trial).

- a. Testing. The tests and evolutions to be carried out while on the surface en route to the test dive area, just prior to the initial dive and during the initial dive are identified in Appendix D of this chapter.

- b. Restrictions. The following rules apply to the conduct of trials and tests associated with ship construction, Navy Shipbuilding Program Manager sponsored Trials/Tests or any other situation where the ship is requested to conduct trials or tests:
- (1) No test or trial event shall be conducted that requires crew intervention to avoid exceeding normal operating limits. Trial agendas will be based on the expectation that the ship will remain within normal operating limits of the Submerged Operating Envelope (SOE) and at angles less than 30 degrees.
 - (2) The trial director must be prepared to project whether the next event might exceed normal operating limits based on the empirical results of the previous event. A run that is predicted to exceed normal operating limits should be deleted along with the more demanding runs of that sequence.
 - (3) Any run which will result in exceeding normal limits of the SOE or 30 degree angles but which is essential to provide adequate test data must be specifically approved by the TYCOM. The test/trial sponsor will obtain this permission.
 - (4) A violation of the SOE limit or exceeding a 30 degree angle, not previously approved, shall be reported by unit Situation Report (SITREP). No further testing or trials shall be conducted until TYCOM concurrence is obtained.
 - (5) Specific written approval by the TYCOM is not required to operate outside the upper limits of the SOE, i.e., shallow and fast, while conducting the following operations during Sea Trials or tests in accordance with an agenda approved by the ISIC, Navy Shipbuilding Program Manager or higher authority:
 - (a) Conducting full power runs or cavitation curves.
 - (b) Navy Shipbuilding Program Manager sponsored acoustic trials in accordance with an approved acoustic trial agenda.
 - (6) The first underway will be limited in scope. The initial tightness dive will be a deliberate, planned, step-by-step evolution as defined in Appendix D of this chapter, using conservative angles and moderate speed. The maximum water depth for this dive shall be 400 feet, as prescribed by Appendix D of this chapter.
- c. Escort.
- (1) The submarine shall be accompanied by an escort properly equipped with sonar communication equipment. The escort ship must have the capabilities identified in Appendix E of this chapter. Specifically an escort is required for:

NOTE: FOR ALPHA SEA TRIAL, A BACK-UP ESCORT WILL BE ASSIGNED AND READY IN CASE OF FAILURE OF THE PRIMARY ESCORT.

- (a) Initial tightness dive after construction and the first dive to any deeper depth.
- (b) Initial deep dive after construction.
- (c) Emergency Main Ballast Tank (EMBT) blow test under the following conditions:
 - 1 Blow for first time from each depth. Trial agenda will specify depths.
 - 2 Any blow from greater than 400 feet. Rationale is to give submarine added protection to prevent interference from any surface contact.

NOTE: IN ALL CASES, HULL STRENGTH/TIGHTNESS AND VALVE OPERATIONS WILL HAVE BEEN TESTED TO A DEPTH EQUAL TO OR GREATER THAN EMBT BLOW DEPTH BEFORE TESTING EMBT BLOW SYSTEM.

- (d) The second and subsequent underway periods if major hull and system work has been accomplished since the last Sea Trial.

- (2) Alternate Escort. If a surface ship meeting the requirements of Appendix E of this chapter is not available, then a submarine with the required capabilities will be assigned. In any event, each situation must be examined on a case basis and approval by the TYCOM must be obtained to conduct the initial tightness or test depth dives.
 - (3) When an escort ship is other than a submarine, an officer qualified in submarines (Gold Dolphins) must be embarked during the escort duty.
 - (4) Assignment of Submarine Rescue Diving Recompression System (SRDRS). A SRDRS consisting of a designated SRDRS support ship, will be placed in a modified alert status at the beginning of those Sea Trials requiring an escort for:
 - (a) Ship's initial tightness and deep dive events.
 - (b) Subsequent Sea Trials until the completion of the initial dive to design test depth.
 - (c) If, in the TYCOM's judgement, a Sea Trial requires an escort due to major hull cuts, etc., the TYCOM shall obtain Navy Shipbuilding Program Manager concurrence when determining the need for escort/SRDRS services. The ship conducting Sea Trials will notify Commander, Submarine Development Squadron Five and Commander Naval Sea Systems Command (COMNAVSEASYSCOM) when SRDRS is no longer required due to completion of the events necessitating the alert status or due to delays in completing Sea Trials.
 - (d) The cognizant shipyard activity and Commander Submarine Force Atlantic/Commander Submarine Force Pacific shall notify COMNAVSEASYSCOM and Commander, Submarine Development Squadron Five 30 Days prior to the SRDRS need date. All changes in the requested modified alert date will be immediately identified to COMNAVSEASYSCOM and Commander, Submarine Development Squadron Five. Sample messages in Volume II, Part I, chapter 3, Appendices BN and CQ of this manual.
 - (e) Commander Submarine Force Atlantic/Commander Submarine Force Pacific shall identify the SRDRS support ship in the tasking message. The TYCOM shall ensure Airport/Seaport verification checks are current or accomplished to support SRDRS activation.
 - (f) The SRDRS is not required to be placed in a modified alert status for those Sea Trials requiring an escort solely for the accomplishment of an EMBT blow from depths greater than 400 feet.
- d. Reporting Criteria. The Supervising Authority is responsible for reporting the satisfactory completion of Alpha Sea Trial to the Navy Shipbuilding Program Manager. Volume I, Chapter 2, Appendix C1 of this manual refers.

4.4.4 Bravo Sea Trial (Submarines only). Bravo Sea Trial is generally the submarine's second underway period and first dive to Test Depth.

NOTE: THE FIRST SHIP OF EACH CLASS NORMALLY CONDUCTS ITS FIRST DIVE TO TEST DEPTH DURING ALPHA TRIAL.

- a. Testing.
 - (1) The tests and evolutions to be carried out following the initial tightness dive and prior to the deep dive, during the deep dive, submerged following the deep dive, and on the surface following the deep dive, are identified with Appendix F of this chapter.
 - (2) Shutter Stall Speed. Run ahead at maximum speed allowed by SOE. Operate torpedo tube shutters and ejection pump shutters. If shutters do not open, gradually reduce speed until shutters open. This establishes "stall speed" for each shutter.
- b. Restrictions. As specified in paragraph 4.4.3.b of this chapter.
- c. Escort. As specified in paragraph 4.4.3.c of this chapter.

- d. Reporting Criteria. With the exception of reporting the deficiencies during the trial, reporting of the completion of Bravo Trial is not required. Daily SITREPs to the Supervising Authority and the Supervising Authority's message concerning the completion of all trials (Volume I, Chapter 2, Appendix D1 of this manual refers) satisfies the reporting requirements.

4.4.5 Charlie Sea Trial (Submarines only). Charlie Sea Trials are conducted prior to CT. Bravo Trial retest items are also included in this trial. The standard restrictions and escort requirements as specified per paragraphs 4.4.3.b and 4.4.3.c of this chapter apply.

4.4.6 Acoustic Trials (Platform and Radiated) (Submarines only). New construction acoustic trials, performed by the shipbuilder, are accomplished to determine, under various conditions of operation, the radiated and platform acoustic signatures of the submarine, the controlling noise offenders including those which are speed dependent, and whether or not the submarine meets its underway noise objectives. Proper operation of systems/components and the use of proper personnel quieting techniques is vital for successful acoustic measurements. Acoustic trials performed by Naval Surface Warfare Center (NSWC) are used to establish the ship's baseline signature for normal operating conditions by performing independent measurements under preset conditions of speed, depth, aspect angle, and machinery line up. It is imperative that Ship's Force understand that this trial will determine its future operating conditions during various "patrol quiet" conditions.

4.4.7 Shock Trials. Shock Trials are designed to test the survivability characteristics of a ship under deliberate and controlled conditions. Normally scheduled for the first ship of a class just before Post Shakedown Availability (PSA); Shock Trials satisfy Congressionally mandated Live Fire Test and Evaluation requirements. Navy Shipbuilding Program Managers are responsible for the development of a management plan for the conduct of Shock Trials.

4.4.8 Acceptance Trials/Combined Trials/Final Contract Trials/Guarantee Material Inspection.

- a. Reference (d) tasks the INSURV with conducting an independent verification of the readiness of a newly constructed ship prior to its acceptance into Naval Service. Reference (k) states that the procedures for conducting trials and inspections shall be specified by the President, INSURV. References (f) and (h) provide those procedures for submarines and surface ships respectively. References (f) and (h) are augmented by reference (a) in their application to nuclear powered ships. References (l) and (m) provide detailed information concerning the documentation of deficiencies. In addition, each Supervising Authority, TYCOM, the Naval Ships' Technical Manual (NSTM) and reference (n) all provide additional information concerning AT/CT/GMI/Final Contract Trials (FCT). TYCOM directives are identified in the applicable TYCOM 5215 Notice.
- b. Prior to the acceptance and delivery of a new ship, all machinery, electronics and weapons systems installed shall be subjected to ATs to determine that the installations are capable of meeting performance specifications. Depending upon the platform type these trials are referred to as either ATs, or CTs. This independent verification of the ship's readiness for acceptance and recommendation for fleet introduction, as specified in reference (d), is the responsibility of the President, INSURV.
- c. These trials are generally two part evolutions. There is an underway portion during which time the INSURV observes the performance of the ship and all equipment and systems. Upon completion of the underway portion, trial board designated equipment and associated components are disassembled for post trial examination (the open and inspect evolution). References (f) and (h) provide amplifying information concerning this issue.
- d. CTs, usually the norm for submarines, are a combination of ATs and FCTs. The AT for non-submarine platforms results in a conditional acceptance primarily based on the fact that the ship still requires fitting out. Submarines go through the fitting out period during the construction phase which produces a completed ready for sea vessel at delivery. The standard restrictions and escort requirements as specified per paragraphs 4.4.3.b and 4.4.3.c of this chapter apply.
- e. FCTs are conducted after the ship has been fully equipped, armed, made complete and ready for service. These trials are normally held just prior to PSA and prior to the end of the guarantee period. Their objective is to determine if there are any defects, failures or deterioration, other than that due to normal wear and tear, directly related to shipbuilder fault which have not been corrected or resolved. The scope of FCTs is essentially the same as AT.

- f. A GMI is a material inspection, conducted on submarines prior to PSA by an INSURV in accordance with reference (f).
- g. INSURV reports from previous ships as held by the Supervising Authority provide familiarity with problems and corrective actions already taken. In addition, these reports provide a baseline for conducting shipboard inspections and generating inputs for the PCO's monthly progress reports.

APPENDIX A
SPECIFIC DOCK TRIAL TEST AREAS

Test Area	Class of Ship			
	MSC Ships	CVN	Surface Force Ships	SSN
1. Check all sound powered/interior communications circuits between all stations.	X	X	X	X
2. Test all alarms, i.e., General Quarters, Collision, etc.	X	X	X	X
3. Test each indication on Ballast Control Panel.				X
4. Test whistle.	X	X	X	X
5. Check emergency lights.	X	X	X	X
6. Operate all hydraulic plants using each installed pump.	X	X	X	X
7. Conduct a complete air charge using only ship's compressors.				X
8. Conduct a normal battery charge using only ship's power and equipment.				X
9. Conduct low pressure blow of all MBTs. Thereafter conduct dockside operation portion of URO MRC 022.				X
10. Flood sanitary tanks and then blow/pump them.				X
11. Operate each main vent valve in hand and power. Following operation, with vent valves shut, conduct a controlled removal of MBT vent covers, one at a time, to check MBT vents for leaks.				X
12. Operate the outboard induction valve in hand and power.				X
13. Operate the diesel engine exhaust valve in hand and power.				X
14. Operate inboard induction valves.				X

Test Area	Class of Ship			
	MSC Ships	CVN	Surface Force Ships	SSN
15. Raise, train and lower periscopes, snorkel, radar and antenna masts and fairings.				X
16. Test operation of all radio transmitters and receivers using all antennas.	X	X	X	X
17. Operate all radar equipment at rated conditions.	X	X	X	X
18. Operate all sonar equipment at rated conditions.			X	X
19. Take and plot fixes using all navigation equipment and each antenna.	X	X	X	X
20. Test operation of drain pump(s) from all operating locations using each bilge suction.				X
21. Test operation of trim/ballast control/list control system and pump by pumping to and from each tank and by pumping to and from sea (from all operating locations).	X	X	X	X
22. Calculate and enter the diving trim compensation.				X
23. Test operation of portable submersible pump from each installed outlet.	X	X	X	X
24. Fire waterslugs from torpedo room.				X
25. Fire waterslugs from weapons launch console.				X
26. Test magazine/pyro flooding system.	X	X	X	X
27. Operate each lube oil system, including pumps, controllers, purifiers and indicators.	X	X	X	X
28. Energize the Navigation System and gyrocompass; determine that they settle out; take azimuth; check all repeaters.	X	X	X	X
29. Check fresh water system, have water samples analyzed.	X	X	X	X

Test Area	Class of Ship			
	MSC Ships	CVN	Surface Force Ships	SSN
30. Test capstans.	X	X	X	X
31. Test bow and stern planes in all modes in accordance with applicable class operating procedures.				X
32. Operate steering system. Test normal and emergency rudder angle indicators, if applicable.	X	X	X	X
33. Check alignment of periscopes, TBTs and all bearing and range repeaters.				X
34. Test engine order telegraphs.	X	X	X	X
35. Test ABTs.	X	X	X	X
36. Operate each watertight door and hatch.	X	X	X	X
37. Check operation of escape hatch/scuttle fittings.	X	X	X	X
38. Operate each bulkhead flapper and each inter-compartment air salvage valve.				X
39. Operate Signal Ejector by impulse and by hand. Demonstrate satisfactory operation of the Signal Ejector both locally and remotely by firing waterslugs and operating the hand rammer through one complete cycle.				X
40. Turn on and check navigation/running lights for brightness and proper lenses (to be done at night). Includes Flight Deck lighting.	X	X	X	X
41. Check air conditioning, chill water, ventilation, and heating systems.	X	X	X	X
42. Check underwater log.	X	X	X	X
43. Check operation of all 400 cycle generating equipment.	X	X	X	X

Test Area	Class of Ship			
	MSC Ships	CVN	Surface Force Ships	SSN
44. Check out all galley, messing, and ship's service equipment.	X	X	X	X
45. Check fathometer.	X	X	X	X
46. Check bilge flooding alarms.	X	X	X	X
47. Check dummy log.	X	X	X	X
48. Check all HP and LP air system.	X	X	X	X
49. Operate distilling units.	X	X	X	X
50. Check out anchor windlass and brake operation.	X	X	X	X
51. Check battery water system.				X
52. Check out atmosphere monitoring equipment, both installed and portable.		X		X
53. Operate oxygen generator, CO ₂ scrubbers, CO burners, and emergency air breathing system.				X
54. If possible, lower, train (if applicable), operate and raise secondary propulsion motor(s).				X
55. Ensure that all required planned maintenance to ship depth detectors is complete.				X
56. Operate the diesel.	X	X	X	X
57. Engage and disengage the clutch.			X	X
58. Test Main Engines; Submarines jack main engines.	X	X	X	X
59. Ensure 7 day supply of oxygen onboard.				X
60. Check out all TV monitoring systems.	X	X	X	X
61. Check out SASS upper and lower trolley cars.		X		

Test Area	Class of Ship			
	MSC Ships	CVN	Surface Force Ships	SSN
62. Check out small arms lockers and security devices.	X	X	X	X
63. Check out all IFF equipment.	X	X	X	X
64. Check out degaussing equipment (where applicable).	X	X	X	X
65. Check out Hangar Bay doors.	X	X	X	
66. Check out damage control equipment.	X	X	X	X
67. Inspect and operate oxygen and nitrogen systems.	X	X	X	X
68. Check out all tank level indicating systems.	X	X	X	X
69. Check out Flight Deck communications.	X	X	X	
70. Check out meteorological equipment.	X	X	X	
71. Check out graphics preparation/display equipment.	X	X	X	
72. Check out Weapon Systems. Check to include loading of dummy missile at each launch station, transmission of fire control signals and operation of launchers in all modes.	X	X	X	X
73. Operate all electrical/mechanical medical equipment.	X	X	X	X
74. Inspect all compartments for proper stowage and cleanliness.	X	X	X	X
75. Inspect boiler and diesel fuel oil systems.	X	X	X	X
76. Test and inspect jet blast deflectors.		X		
77. Test and inspect JP-5 fuel systems.	X	X	X	
78. Test and inspect all aircraft starting and handling equipment.	X	X	X	

Test Area	Class of Ship			
	MSC Ships	CVN	Surface Force Ships	SSN
79. Test and inspect aircraft landing equipment including landing signal officer equipment, arresting gear, crash barriers, as applicable.	X	X	X	
80. Operate all RAS equipment.	X	X	X	
81. Inspect paint lockers and sprinkling systems.	X	X	X	
82. Operate all accommodation ladders.	X	X	X	
83. Operate all conveyors.	X	X	X	
84. Launch and raise motor whaleboat.	X	X	X	
85. Operate all boats.	X	X	X	
86. Test and inspect lifeboat/life raft stowage and launch equipment.	X	X	X	
87. Test and inspect all elevators in all modes of operation.	X	X	X	
88. Test and inspect all fire fighting systems.	X	X	X	X
89. Test and inspect refrigeration systems.	X	X	X	X
90. Test and inspect all seawater cooling systems.	X	X	X	X
91. Operate stern gate doors.			X	
92. Operate boat handling cranes.			X	
93. Conduct URO MRC 029.				X
94. Test and inspect Torpedo Handling System.				X
95. Test and inspect aircraft elevators.		X	X	
96. Test and inspect aircraft launching equipment including catapults.		X		

Test Area	Class of Ship			
	MSC Ships	CVN	Surface Force Ships	SSN
97. Record megger readings of all antennas where meggering is permissible. (Note: This evolution is not required for PSA unless antennas/hull fittings are specifically worked during PSA.)				X

(This Page Intentionally Left Blank)

APPENDIX B
MINIMUM FAST CRUISE REQUIREMENTS

Test Area	Class of Ship			
	MSC Ships	CVN	Surface Force Ships	SSN
1. Make all preparations for getting underway.	X	X	X	X
2. Station the maneuvering watch/sea and anchor detail.	X	X	X	X
3. Station the normal underway watch (section watches).	X	X	X	X
4. Simulate getting underway and return to port. (Day and Night)	X	X	X	X
5. Walk through all major Sea Trial evolutions.	X	X	X	X
6. Walk through the cycling of hull and back-up valves to be tested during the deep dive.				X
7. Exercise the reduced visibility detail.	X	X	X	X
8. Spot check storage and availability of spare parts and tools. Verify adequacy of stores and provisions.	X	X	X	X
9. Rig for dive and rig for surface.				X
10. Simulate diving and surfacing.				X
11. Rig for deep submergence.				X
12. Conduct the following emergency drills:				
a. Fire	X	X	X	X
b. Collision	X	X	X	X
c. Flooding	X	X	X	X
d. Toxic Gas				X
e. Abandon Ship	X	X	X	X
f. Man Overboard	X	X	X	X

Test Area	Class of Ship			
	MSC Ships	CVN	Surface Force Ships	SSN
g. Submarine Escape				X
h. Loss of AC Power	X	X	X	X
i. Emergency Ventilation				X
j. Loss of Air Conditioning/ACW		X		X
k. Loss of Lighting	X	X	X	X
l. Loss of Interior Communications	X	X	X	X
m. Loss of Steering	X	X	X	X
n. Engine Casualty Control	X	X	X	X
o. Flight deck and hangar deck crash/fire drills, barricade drills, and MOVLAS drills		X		
13. Set General Quarters. Exercise the crew at battle stations.	X	X	X	X
14. Conduct communication and ECM drills.	X	X	X	X
15. Conduct an air charge to all air banks.				X
16. Bleed oxygen and ventilate ship. Ensure 7 day supply of oxygen onboard.				X
17. Anchor (walk-through).	X	X	X	X
18. Exercise damage control party with emergency and damage control equipment.	X	X	X	X
19. Operate atmosphere control equipment and take air samples.				X
20. Perform the minimum Fast Cruise requirements for nuclear propulsion plants contained in reference (o).		X		X
21. Operate air conditioning plants to demonstrate ability to carry the maximum existing ship's air conditioning load or 100% capacity.	X	X	X	X

Test Area	Class of Ship			
	MSC Ships	CVN	Surface Force Ships	SSN
22. Operate fresh water/seawater heat exchangers at sufficient load to demonstrate proper operation.				X
23. Simulate underway conditions, performing all evolutions and operating all equipment.	X	X	X	X
24. Simulate boat transfer at sea.	X		X	
25. Conduct competitive and non-competitive drills and exercises such as aircraft tracking and aircraft control.	X	X	X	
26. Light-off main propulsion plant, shift to ship's power and run all engines with steam for a short period of time.	X	X	X	X
27. Man Towing/Salvage/Fueling Stations.	X	X	X	
28. Set Flight Quarters as applicable.	X	X	X	

(This Page Intentionally Left Blank)

APPENDIX C

**LISTING OF TESTS TO BE PERFORMED DURING
AIRCRAFT CARRIER BUILDER'S TRIALS**

1. The following systems and components will be tested during Aircraft Carrier Builder's Trials:

- a. Auxiliaries
 - Emergency Diesel Generators
 - O₂N₂ Plants (Forward and Aft)
 - Steering Gears
 - Motor Driven Fire Pumps and Eductors
 - Anchor Windlass
 - Stores Conveyors
 - Hot Water Heaters
 - HP Air Compressors
 - Ship Service and Control Air Compressors
 - Air Filter Cleaning
 - Air Conditioning/Refrigeration Systems
 - Turbine Generator and Diesel Generator (Load Transfer Operations)
- b. Aviation
 - Aircraft Elevators 1, 2, 3, 4
 - Aircraft Starting and Servicing Power
 - Boat and Airplane Crane
 - Flight Deck Night Lighting
 - Arresting Gear
 - Aircraft Barricade
 - Jet Engine Test Facility
 - Elevator Doors and Hangar Bay Division Doors
 - Landing Officer's Console and Windscreen
 - Visual Landing Aid
 - Catapults (No Load Launching)
 - Jet Blast Deflectors
 - Integrated Catapult Control Stations
 - Hangar Bay Darken Ship Switches
 - JP-5 Filling, Transfer and Service System
- c. Combat Systems
 - Upper Stage Weapons Elevators
 - Flight Deck Hatches
 - Magazine Sprinkling and Alarms
 - Lower Stage Weapons Elevator 7 Hatches
 - Inspect Masts
- d. Damage Control
 - Halon Fire Protection System
 - Machinery Space and Pump Rooms 2 and 3 AFFF
 - Diesel Driven Portable Pumps
 - Aqueous Potassium Carbonate System
 - Miscellaneous Sprinkling Systems
 - Electrical Driven Portable Pumps
 - List Control Pumps
 - Magazine Sprinkling and Alarms Systems

- CO₂ Hose Reels
- Hydraulically Operated Valves
- Hangar Bay and Weapons Elevator AFFF
- Turbine Driven Fire Pumps
- e. Deck
 - Ship's Boats
 - Boat and Airplane Crane
 - Anchor Windlass
 - Sliding Padeyes
 - Replenishing-At-Sea Winches
 - Trash Burners
 - Mooring and Warping Capstans
 - Replenishing-At-Sea Support Legs
- f. Electrical
 - Ship Service and Coolant Turbine Generators
 - Aircraft Elevators 1, 2, 3, 4
 - Emergency Diesel Generators
 - Aircraft Starting and Servicing Power
 - Steering Gear
 - Gyro-Compass Standby Power Supply
 - Anchor Windlass
 - Miscellaneous Alarms (Non-Navigational)
 - IC CKTs: BZ/JB, CX, DA, 1DL, 3DL, 4FD, 14FD
 - Degaussing System
 - General, Chemical and Collision Alarms From All Stations
 - Flight Deck Crash Alarms
 - Flight Deck Night Lighting
 - Navigation Lights
 - Hangar Bay Darken Ship Switches:
 - Turbine Generator and Diesel Generator Load Transfer Operations
 - Mooring and Warping Capstans
 - 400 HZ MG Set Parallel Operations
- g. Environmental Protection
 - Collection, Holding and Transfer (CHT) Dockside Pumping
 - CHT SYS - Switch To Holding Mode
 - CHT SYS - Switch To At-Sea Mode
 - CHT Valve Rooms 3 Thru 9 Valve Operations (4th Deck)
 - NOTE: All Scuppers Must Be Operated For CHT Certification
- h. Main Propulsion
 - Shaft Seals Including Inflatable Seals
- i. Medical and Dental
 - Brominators
- j. Navigation
 - Steering Gear
 - Engine Order Telegraph
 - Rudder Angle Indicating System
 - Gyro-Compass Standby Power Supply
 - General Announcing System
 - Bridge Announcing System

Ship's Whistles
Pelorus, Signal Lights and Big Eyes
Degaussing System
Visibility - Pilot House, Bridge and Lookout Stations
Navigation Lights
AN/SRN-25 Radio Navigation
AN/SRN-9 Satellite Navigation
AN/SPS-64 Navigation Radar
AN/WRN-6 GPS
Wind Direction
DRTs and DRAI
Magnetic Compass
AN/WSN-1 Navigation System
MK 19 Compass

k. Supply

Stores Conveyors
Laundry
Dumbwaiter
Bridge Crane
Scullery

(This Page Intentionally Left Blank)

APPENDIX D
LISTING OF TESTS TO BE
PERFORMED DURING INITIAL TIGHTNESS DIVE
(SUBMARINES ONLY)

1. The following tests and evolutions will be carried out on the surface en route to the test dive area and prior to the initial tightness dive:

- a. Underway. Rig for dive (for Alpha Trial, rig for deep submergence is required for the initial dive). Compensate. Start-up reverse osmosis units.
- b. Ship's Force instruct Sea Trial riders on the proper use of EAB masks.
- c. Conduct operational test of rudder in normal and emergency modes.
- d. Navigation system check. Take fixes by all electronic, celestial, and visual means and compare.
- e. Test underwater log(s) using the base course/reciprocal course method (i.e., inertial reference method) or other approved functional procedures to determine accuracy.
- f. Check accuracy of all bearing transmitters and indicators. Compare sonar, visual and radar bearings.
- g. Check operation of all radar.
- h. Check all radio transmitters, receivers and electronic equipment.
- i. Inspect stern tube packing gland/seals and circulating water flow for excessive heating, leakage and audible noise.
- j. Check Dead Reckoning Analyzer Indicator (DRAI), Dead Reckoning Analyzer (DRA), Dead Reckoning Tracers (DRT) and RPM indication. If certified for electronic navigation, verify satisfactory operation of the Voyage Management System including the ability to receive inputs from the Navigation System, Electromagnetic Logs, Radar bearings, Sonar bearings, fathometer and Gyrocompass, as applicable.
- k. Test fathometer(s) and compare with charted soundings.
- l. Run ahead at full power long enough for temperatures to reach a stable value. After readings have stabilized, operate rudder through full throw in each direction in normal and emergency power. Time evolution and compare with design values. Check out hand modes.
- m. Ahead flank to back emergency.
- n. Fire Control System operation.
- o. Check operation and accuracy of ship's gyrocompass.
- p. Check operation of magazine/pyro locker flooding if not tested in industrial activity.
- q. Rendezvous with escort. Conduct radio and sonar communications checks. (See Note 1).
- r. Test all bottomside sonar.
- s. Test bow/sail and stern plane operations in all modes.
- t. Flood variable tanks to computed compensation.
- u. Record megger readings of all antennas where meggering is permissible. (See Note 8).
- v. Operate trim and drain pumps.
- w. Test variable ballast system for proper operation.

NOTE: CONDUCT PARAGRAPHS 1 AND 3 OF URO MRC 022 (DOCKSIDE OPERATION OF EMBT BLOW SYSTEM VALVES) OR EQUIVALENT SHIPYARD TEST PROCEDURE DURING DOCK TRIALS PER APPENDIX A OF THIS CHAPTER FOR THE TEST OF THE EMBT BLOW SYSTEM. ENSURE THE REMAINING PORTIONS OF URO MRC 022, OR AN EQUIVALENT NAVSEA APPROVED TEST PROCEDURE, THE TEST OF THE EMBT BLOW SYSTEM, ARE COMPLETED PRIOR TO INITIAL DIVE TO TEST DEPTH ON ALPHA SEA TRIAL (INITIAL BUILDER'S SEA TRIAL).

- x. Perform a low pressure, normal and EMBT blow for as long as necessary to verify system operability. A static blow shall not be used to test the EMBT blow system.
- y. Operate on the Emergency Propulsion Motor (EPM) for 10 minutes.
- z. Motor generator set operation.
- aa. Ventilate ship.
- ab. Start atmosphere control equipment.
- ac. Additional requirements may be imposed at the discretion of the CO.

NOTE: REQUIRED SYSTEMS ARE LISTED IN PARAGRAPH 4b OF REFERENCE (i). OBSERVE RESTRICTIONS ON OPERATION OF SYSTEMS LISTED IN PARAGRAPH 4d OF REFERENCE (i). BALL VALVE TRASH DISPOSAL UNITS (TDU) (WITHOUT REMOTE CLOSURES) WILL NOT BE OPERATED BELOW 200 FEET.

2. The following tests and evolutions will be carried out immediately prior to or during the initial tightness dive:
- a. Obtain navigational fix and take sounding. Maximum depth of water is 400 feet as specified in reference (p).
 - b. Conduct a dive to periscope depth. Obtain stop trim, if practical, at periscope depth. If sea state requires deeper submergence, proceed slowly to 150 feet for SSN 688 Class submarines (155 feet for SSN 774 Class submarines), (160 feet for SSN 21 and SSBN/SSGN 726 Class submarines) to obtain stop trim. Maximum keel depth shall be per Table 1 of Appendix F.
 - c. Inspect the discharge of all automatic drains in each EMBT Blow quadrant for sea water leakage prior to the first dive when the ballast tanks are flooded (e.g., at periscope depth).
 - d. Check operation of ship control systems, including depth indication. (See Note 2).
 - e. Shoot pyrotechnics from each ejector by hand and impulse methods, as applicable (see Notes 3 and 4).
 - f. Communicate with escort on WQC at each depth increment or at ten minute intervals, whichever is sooner. If communications are lost, return to depth at which communications can be established before continuing (see Note 1).
 - g. All hands inspect for leaks and report them to the Sea Trial coordinator.
 - h. Operate all periscopes, checking optics and for leakage. Operate all masts.
 - i. Test full throw of rudder and planes at slow speeds.
 - j. Test operation of trim and drain systems.
 - k. Check all sonar equipment on each hydrophone.
 - l. Comply with the Command Control Systems (CS/CCS) Test Program regarding the shooting of waterslugs. This event is not required by the TYCOM if not required by the CS/CCS Test Program (see Notes 3 and 4).
 - m. Snorkel, test operation of stills and air compressors (see Notes 4 and 5).
 - n. Operate all hull and back-up valves and equalize sea pressure on all systems designed for test depth (see Notes 4, 6 and 7).
 - o. Check hovering system (where applicable) (see Note 4).

- p. Ensure air banks are charged to within 200 psi of full pressure.
- q. Line up MBT blow system for maximum blow rate.
- r. Conduct EMBT blow from 200 feet keel depth. Check bank pressure before and after surfacing. Surfacing with EMBT blow may be delayed to permit additional testing, commencing pre-transit valve operating cycling or transit submerged. However, first surface after initial tightness dive must be by EMBT blow from 200 feet.
- s. Additional requirements may be imposed at the discretion of the CO.

NOTES

1. **In the execution of any Sea Trial, whether escorted or not, submarine COs are reminded of their responsibility to communicate with escorts and/or shore authorities within prescribed, previously agreed upon time limits to avoid initiation of inadvertent lost contact or submarine disaster procedures.**
2. **Compare all depth and pressure gages. Depth and pressure gages should be checked as soon as the next specified depth is reached.**
3. **Integrity of launchers or signal ejectors shall be established by admitting sea pressure through equalizing lines or flooding connection and the muzzle valve/door operated before conducting operational tests. Shoot water slugs from specified launchers or signal ejectors, at specified depths, as required by the CS/CCS test program. Shoot pyrotechnics on initial dive and at test depth on the deep dive. Shooting of pyrotechnics during the initial dive shall be accomplished in conjunction with the 200 foot EMBT Blow. Shooting of pyrotechnics at test depth during the deep dive shall be accomplished in conjunction with the test depth EMBT blow.**
4. **Those seawater systems which are not required for normal safe operation of the ship at test depth but which have been designed for and may be subjected to test depth pressure should not be subjected to submergence pressure during the initial dive to any specified depth (e.g., a blown sanitary tank). (See reference (i)).**
5. **Check operation of electrodes; head valve and each snorkel safety circuit.**
6. **Depth increments for cycling vital sea valves are as set forth in reference (i).**
7. **This evolution (initial operation of hull and back-up valves in fully submerged condition) at depths other than specified in reference (i) is intended for crew training and is not technically required. Evolution may be abbreviated or deleted on a case basis with concurrence of the embarked TYCOM representative.**
8. **Meggering of antenna may be accomplished during dock trials but must be accomplished prior to initial deep dive.**

(This Page Intentionally Left Blank)

APPENDIX E**ESCORT SHIP CAPABILITIES FOR SUBMARINE SEA TRIALS**

1. Radio Communication:
 - a. Ability to transmit and receive on two Ultrahigh Frequency (UHF) and on High Frequency (HF) circuits simultaneously including 243.0 MHZ or equivalent system capabilities (Very High Frequency (VHF) and INMARSAT-C).
 - b. Equipped to tape record all non-secure radio transmissions between the submarine and the escort.
 - c. Capability to communicate on the submarine UHF/HF or equivalent system capabilities (VHF/INMARSAT-C) circuits.
2. Sonar and Sonar Communications:
 - a. Equipped with underwater telephone capable of communicating to the submarine's test depth or equivalent system capabilities.
 - b. Sufficient operators to man underwater telephone on a continuous basis, including a Continuous Wave (CW) capable operator on call if the requirement for CW communication develops.
 - c. Equipped to tape record (installed or portable) all transmissions between the submarine and the escort by underwater telephone.
 - d. Explosive charge signals or active sonar called for by AXP-1.
3. Navigation:
 - a. Equipped with an operable LORAN C, Global Positioning System (GPS) or the latest accurate off-the-shelf navigational equipment.
 - b. Equipped with an operable DRT or equivalent system capability.
 - c. Possess navigational capability to fix his position to two miles average accuracy.
 - d. Fathometer.
 - e. Gyrocompass.
 - f. Underwater log or equivalent system capability.
4. Sea keeping and speed:
 - a. Ability to remain at sea for one week in State 6 seas.
 - b. Be capable of making 10 knots. Escorts will keep the submarine informed of any speed or sea state limitations. In addition, if the escort has an unfaired WQC hydrophone, it shall notify the submarine of the maximum sea state and speed which will not restrict WQC communications. If the submarine requires a speed above this limit, the submarine should run a track about the escort within WQC range.

(This Page Intentionally Left Blank)

APPENDIX F
LISTING OF TESTS TO BE
PERFORMED PRIOR TO, DURING AND
FOLLOWING FIRST DIVE TO TEST DEPTH

1. The following tests and evolutions, as summarized in Table 1 of this appendix, will be carried out following the initial tightness dive and prior to the deep dive:

- a. Six hours of Independent Ship Exercise for crew training. (see Note 1).
- b. Charge air banks and battery if necessary. The ship may be submerged while charging air banks provided the depth of the ship does not exceed other guidelines in this instruction, or those of the flooding bill or ship's operating procedures.
- c. Operate IFF and ESM equipment. If possible use aircraft. (see Note 2).

2. The following tests and evolutions, as summarized in Table 1 of this appendix, will be carried out immediately prior to or during the first deep dive. Per Volume V of this manual, a second deep dive must be performed to complete valve cycling and operation of systems not required for normal safe operation of the ship, i.e., torpedo tubes, Trash Disposal Unit (TDU), hovering, plumbing. (see Note 3).

- a. Ensure that air banks are charged to within 200 psi of full pressure.
- b. Ensure all MBT blow systems are fully operational and in a normal line up configuration.
- c. Take sounding. Maximum water depth is given in reference (p). Accurately fix the ship's position within the specified dive area (reference (p)).
- d. Conduct a dive to periscope depth. Obtain speed trim, if practical, at periscope depth. If sea state requires deeper submergence, proceed slowly to (150 feet for SSN 688 Class submarines), (155 feet for SSN 774 Class submarines), (160 feet for SSN 21 and SSBN/SSGN 726 Class submarines) to obtain speed trim. (see Note 4).
- e. Obtain stop trim. Take readings and water samples required to make a check of ballasting. Stop trim should be conducted at the most desirable time during the trials.
- f. Trim ship to maintain neutral buoyancy. (see Note 5).
- g. Line up propulsion plant for maximum reliability in accordance with ship's instructions.
- h. Rig ship for deep submergence, except reverse osmosis units. All systems should be in the maximum secure condition with unnecessary sea systems isolated. (see Note 6).
- i. Station personnel throughout the ship to inspect for leaks.
- j. At depths specified in reference (i):
 - (1) Inspect for leaks.
 - (2) Adjust trim. (see Note 5).
 - (3) Communicate with escort at each 100 feet depth increment or at 10 minute intervals, whichever is sooner. If communications are lost, return to depth at which communications can be reestablished before continuing. (see Note 7).

NOTE REQUIRED SYSTEMS ARE LISTED IN PARAGRAPH 4b OF REFERENCE (i). OBSERVE RESTRICTIONS ON OPERATION OF SYSTEMS LISTED IN PARAGRAPH 4d OF REFERENCE (i). BALL VALVE TRASH DISPOSAL UNITS (TDU) (WITHOUT REMOTE CLOSURES) WILL NOT BE OPERATED BELOW 200 FEET.

- k. At depths listed for hull valve cycling in reference (i) (as applicable) per NAVSEA approved Deep Dive Test Form:
 - (1) Check accuracy of gages and repeaters.

- (2) Conduct operational test of signal ejectors. (see Note 8).
 - (3) Check shaft bearings and stern tubes for excessive heating, leakage and noise. Shaft seals must be tested at each depth and for the required time, as specified in the approved class test form.
 - (4) Cycle rudder and planes through full throw to check for binding. (see Note 9).
 - (5) Operate all hull and back-up valves (using remote closures, as applicable, from flooding control stations) of seawater systems required to maintain propulsion and other functions vital to the ship's operation at increments of depth specified in reference (i). Required systems are listed in paragraph 4.b. of reference (i). Observe restrictions on operation of systems listed in paragraph 4.d. of reference (i).
 - (6) Check operation of bulkhead flappers and watertight doors for binding.
 - (7) Operate trim and drain pumps, discharging to sea.
 - (8) Cycle components of each torpedo tube. Check for leakage. Establish integrity of torpedo tubes by admitting sea pressure through equalizing lines or flooding connection before cycling components (see Notes 3, 8 and 16).
 - (9) Vent negative tank inboard (if installed). (see Notes 3 and 10).
 - (10) Cycle main vents to check for binding.
- l. At maximum authorized operating depth:
 - (1) Repeat item 2.k.(1) of this appendix - Depth gages and repeaters.
 - (2) Operate each signal ejector by impulse and hand, as applicable. (see Notes 3 and 8).
 - (3) Repeat item 2.k.(3) of this appendix - Shafting and bearings.
 - (4) Repeat item 2.k.(5) of this appendix - Hull and back-up valves.
 - (5) Repeat item 2.k.(6) of this appendix - Bulkhead flappers and watertight doors.
 - (6) Repeat item 2.k.(7) of this appendix - Trim and drain pumps.
 - (7) Repeat item 2.k.(8) of this appendix - Torpedo tubes. (see Notes 3 and 16).
 - (8) Repeat item 2.k.(9) of this appendix - Negative tank (if applicable).
 - (9) Equalize TDU with sea pressure through trim line. During conduct of the Deep Dive Test Form on new construction submarines, the TDU Hull Valve will be cycled at depths specified by reference (i) in order to meet material certification requirements. (see Note 3).
 - (10) Equalize sea systems and cycle hull and back-up valves as specified in reference (i).
 - (11) Repeat item 2.k.(10) of this appendix - Cycle main vents and check for binding.
 - m. After the deep dive, surface fully with EMBT blow from the depth required per the NAVSEA approved EMBT Test Procedure and the approved Sea Trial Agenda. Check air bank pressures before and after blow.
 - n. Additional requirements may be imposed at the discretion of the CO.
3. The following tests and evolutions will be carried out submerged following the deep dive:
- a. Steering and diving operation at full speed. (see Notes 4 and 11).
 - b. Full power run. (see Notes 11, 12 and 13).
 - c. Steep angles - operate the ship through several depth changes using large up and down angles to check operation of ship machinery. (see Notes 11 and 14).
 - d. Time raising each periscope and mast at maximum depth and speed for which they were designed. Check training feature where applicable.

- e. Run and observe air conditioning plants throughout trials. Operate the air conditioning plant to demonstrate ability to carry entire maximum existing ship's air conditioning load, or 100 percent capacity.
 - f. Run and observe refrigeration plant throughout trials.
 - g. Missile fire control erection performance tests (Vertical Launch System (VLS) on SSN).
 - h. Missile fire control alignment (VLS on SSN).
 - i. Missile tube muzzle hatch operation (VLS on SSN).
 - j. Missile compensation system operation submerged (VLS on SSN).
 - k. Additional requirements may be imposed at the discretion of the CO.
 - l. Comply with the CS/CCS test program with regard to firing of water slugs and testing of torpedo tubes. (see Notes 3, 8 and 16).
4. The following tests and evolutions will be carried out on the surface following the deep dive:
- a. Note condition of periscope optics.
 - b. Measure resistance to ground of all external electrical cables.
 - c. Take radio antenna megger readings immediately after surfacing, again in one-half hour, and compare with readings obtained in Appendix D, step 1.v. of this chapter.
 - d. With ship proceeding at full speed, conduct low pressure blow (if installed) to check whether or not circulation water systems and machinery become air bound.
 - e. Measure resistance, across and to ground from each side, of all sonar hydrophones, projectors and transducers. (see Note 15).

TABLE 1. SUMMARY OF SIGNIFICANT UNDERWAY TRIAL REQUIREMENTS

Sea Trials	Initial Tightness Dive	Transit	Deep Dive
Policy References	Appendix D, paragraph 2 of this chapter.	Appendix F, paragraph 1 of this chapter.	Appendix F, paragraph 2 of this chapter.
Start Depth	Surface	Surface to 400 ft.	Surface to 400 ft.
Conduct Depth	Periscope depth or about 150 ft for SSN 688 Class (155 ft for SSN 774 Class), (160 ft for SSN 21 and SSBN/SSGN 726 Class) if sea state dictates for trim. Remaining events of Appendix D, paragraph 2 of this chapter no deeper than 200 ft.	Surface to 400 ft but not to exceed deepest depth previously escorted or valve cycling accomplished. Additional trials and testing permitted within the Independent Ship Exercise, crew rest and other requirements of this instruction.	200 ft increments to one half Maximum Authorized Operating Depth, then 100 ft increments to Maximum Authorized Operating Depth.
Maximum Keel Depth	200 ft.	One half test depth.	Maximum Authorized Operating Depth.
Finish Event	Surface from 200 ft with EMBT blow.*	Rendezvous with escort.	Deep dive will be terminated with an EMBT blow from Maximum Authorized Operating Depth Appendix F section 2.
Escort Required	Yes**	No	Yes**
Water Depth	400 ft per reference (p)	Unlimited.	Reference (p).

* May be delayed to permit additional testing, commencing pre-transit valve operating cycling or transit submerged. However, first surface after initial tightness dive must be by EMBT blow from 200 feet.

** An escort is required on the initial tightness dive and on subsequent first dive to any deeper depths, i.e., the first dive to any depth requires an escort. EMBT blow escort requirements given in paragraph 4.4.3.c of this chapter.

NOTES

1. Each person involved in Sea Trials should be allowed a minimum of six hours of continuous, uninterrupted sleep during any 24 hour period encompassed by the Sea Trial.
2. Event is optional with regard to sequence. May be conducted at any time during Sea Trials and is not a prerequisite to the deep dive. If listed with initial tightness dive events, completion is not mandatory prior to proceeding with remainder of trials.
3. Those seawater systems which are not required for normal safe operation of the ship at test depth but which have been designed for and may be subjected to test depth pressure should not be subjected to submergence pressure during the initial dive to any specified depth (e.g., a blown sanitary tank). (See reference (i)).
4. At maximum safe speed, operate the rudder and planes through full throw in both directions in normal and emergency power. Time evolutions and check against design values.
5. Deep dive should be conducted using moderate speed, or as approved by NAVSEA, and constantly adjusting trim, at depths specified in reference (i), to maintain neutral buoyancy. Moderate speed shall be defined as that range of speed that allows the ship to recover from a loss of stern plane control or flooding casualty.
6. Reference (i) prescribes procedures for systems operation during deep dive.
7. In the execution of any Sea Trial, whether escorted or not, submarine COs are reminded of their responsibility to communicate with escorts and/or shore authorities within prescribed, previously agreed upon time limits to avoid initiation of inadvertent lost contact or submarine disaster procedures.
8. Integrity of launchers or signal ejectors shall be established by admitting sea pressure through equalizing lines or flooding connection and the muzzle valve/door operated before conducting operational tests. Shoot water slugs from specified launchers or signal ejectors, at specified depths, as required by the CS/CCS test program. Shoot pyrotechnics on initial dive and at test depth on the deep dive. Shooting of pyrotechnics during the initial dive shall be accomplished in conjunction with the 200 foot EMBT Blow. Shooting of pyrotechnics at test depth during the deep dive shall be accomplished in conjunction with the test depth EMBT blow.
9. Cycling of rudder and planes through full throw should be limited to 90% of test depth.
10. Test to demonstrate the ability of the tank to withstand external pressure.
11. The required sequence of events is initial dive, deep dive, full power run submerged, then high speed maneuverability and steep angle tests. On initial propulsion plant trials for new construction nuclear powered submarines, the deep dive will be to test depth minus 300 feet unless otherwise approved by NAVSEA or the TYCOM and reflected in the Sea Trial Agenda.
12. Run full power submerged for at least two hours. COs may schedule the full power run for four hours if deemed necessary. Operate at minimum non-cavitating depth but not to exceed 400 feet. Water depth is not limited for this event.
13. Propulsion Plant Tests. The full power trial for new construction submarines will be in accordance with building specifications or directions from the Navy Shipbuilding Program Manager. Submarine depth during the submerged full power trials should be limited to 400 feet. The submerged full power ahead test for commissioned nuclear powered submarines shall be terminated by a back emergency bell. The duration of the back emergency bell shall be limited to 45 seconds, to be followed immediately by an appropriate ahead bell. Caution must be exercised to avoid stern way.
14. Completion of full power, deep dives and EMBT Blow Test Forms are prerequisites for the high speed maneuverability and steep angle tests. Initial high speed ship control tests, steep angle tests and exercises of major casualties shall be conducted in water that does not exceed one and one-half times design test depth, which equates to collapse depth.
15. The spherical array need not be done if an array purge or power into the array measurements are scheduled at a later date.
16. Fire water slugs from torpedo tubes at the depths and speeds required by the CS/CCS test program (or Combat Systems Assessment or Non-Propulsion Electronic System Operability, Verification and Evaluation, as applicable).

(This Page Intentionally Left Blank)

APPENDIX G
SUBMARINE SEA TRIAL SITUATION REPORT
(SITREP)

FM USS <SHIP NAME>//
 TO COMSUB<LANT/PAC> <NORFOLK VA/PEARL HARBOR HI>//N4//
 INFO CNO WASHINGTON DC//N77//
 COM<LANT/PAC>FLT <NORFOLK VA/PEARL HARBOR HI>N43//
 COMNAVSEASYSKOM WASHINGTON DC//PMS 392/08O//
 DIRSSP WASHINGTON DC//205// {For SSBN/SSGN Only}
 <SUBOPAUTH>// {IF OTHER THAN PARENT TYCOM}
 COMSUBRON ELEVEN//
 COMSUBGRU <NO.>//N5//
 COMSUB<RON/GRU NO.>//
 <SUPERVISING AUTHORITY>//<CODES>//
 (OTHER UNITS IN AREA IF APPLICABLE)//

BT

UNCLAS //N09094//

MSGID/GENADMIN/USS <SHIP NAME>//
 SUBJ/(TYPE AVAILABILITY) SITREP (SEQUENTIAL NUMBER)//
 REF/A/DOC/COMUSFLTFORCOM/<DATE>//
 REF/B/DOC/AS APPLICABLE/<DATE>//

NARR/ REF A IS COMUSFLTFORCOMINST 4790.3, JOINT FLEET MAINTENANCE MANUAL, VOLUME II.

RMKS/1. CO'S SUMMARY, EVENTS 1-9 COMPLETED WITH THE FOLLOWING DEFICIENCIES NOTED:

A. SUBSAFE/URO DEFICIENCIES.

- 1) #1 SCOPE HULL GLAND LEAK 1 DPM AT 20% TD
- 2) TDU VENT, TD-104 LEAKS 3 DPM AT 65% TD.
- 3) STERN PLANES AUX ANGLE INDICATOR ON BCP DOES NOT ILLUMINATE, URO-16

B. NON-SUBSAFE/URO DEFICIENCIES.

- 1) SCULLERY DRAIN LEAKING AT FITTING F-18, 27 DPM
- 2) 3 FLOOR TILES IN CREWS MESS LIFTED AFFECTING SANITATION
- 3) CO HOT WATER SHOWER RECIRC PUMP FAILED

2. PREVIOUS DEFICIENCIES REPORTED AND STATUS.

(LIST ALL PREVIOUS DEFICIENCIES AND CURRENT STATUS-THE GOAL IS TO CAPTURE THE COMPLETE MATERIAL CONDITION IN EACH MESSAGE) STATUS = REPAIRED (R), CORRECTIVE ACTION REQUIRED (CAR), NOT APPLICABLE (NA)

EXAMPLE -

- 1) SCULLERY DRAIN LEAKING AT FITTING F-18, 27 DPM -R
 - 2) 3 FLOOR TILES IN CREWS MESS LIFTED AFFECTING SANITATION - CAR
 - 3) CO HOT WATER SHOWER RECIRC PUMP FAILED - CAR
 - 4) #1 SCOPE HULL GLAND LEAK 1 DPM AT 20% TD - CAR
 - 5) TDU VENT, TD-104 LEAKS 3 DPM AT 65% TD - CAR
 - 6) STERN PLANES AUX ANGLE INDICATOR ON BCP DOES NOT ILLUMINATE, URO-16 - R
3. ADDITIONAL INFO.

1) DESCRIBE ANY ADDITIONAL INFO DESIRED OR LIST "NONE".

4. TYCOM, NAVSHIPYD, AND NAVSEA REPS CONCUR-DO NOT CONCUR (AS APPROPRIATE).//

BT

NOTE: ENSURE MESSAGES ARE IN ACCORDANCE WITH CURRENT MESSAGE FORMAT AND CURRENT PLAIN LANGUAGE ADDRESS DIRECTORY (PLAD) IS UTILIZED.

(This Page Intentionally Left Blank)

VOLUME I
CHAPTER 5
POST DELIVERY DEFICIENCIES

REFERENCES.

- (a) NAVSEAINST 4790.8/OPNAVINST 4790.4 - Ships' Maintenance and Material Management (3-M) Manual
- (b) INSURVINST 4730.1 - Material Inspections (MI) of Surface Ships
- (c) INSURVINST 4730.2 - Trials and Material Inspections of Submarines

LISTING OF APPENDICES.

- A Sample Page of 4760-1 Report with Representative Data
- B Legend and Explanation of Symbols Used in Report 4760-1
- C Preparation for Guarantee Material Inspection/Final Contract Trials

5.1 **PURPOSE.** The purpose of this chapter is to provide a procedure to identify and document deficiencies found in new construction ships. This chapter focuses on the period from initial Acceptance Trials (AT) until the termination of funding responsibility under the Shipbuilding and Conversion, Navy (SCN) appropriation. Proper management of these deficiencies is necessary to ensure:

- a. Final settlement of the construction contract with the shipbuilder.
- b. Correction of the maximum number of shipbuilder responsible deficiencies under terms of the construction contract.
- c. Correction of the maximum number of government responsible deficiencies under the SCN appropriation.
- d. Identification of all new construction deficiencies which must be corrected subsequent to the guarantee period under appropriations other than SCN, and identification of improvement items which have class application.

Deficiency items not adjudicated prior to Combined Trials (CT) and the Guarantee Material Inspection (GMI) for submarines or during ATs and Final Contract Trials (FCT) for all other ships are identified to the Navy by the Board of Inspection and Survey (INSURV). Additional items are identified during Naval Sea Systems Command (NAVSEA) Acoustic Trials, Combat System Certification Trials (CSCT) and by the Commanding Officer (CO) of the ship during the contract guarantee period and reported to the Supervising Authority.

5.2 **DEFICIENCY CORRECTION.** Deficiencies are addressed in terms of three general categories. The procedure for initiating corrective action for a deficiency is determined by the category.

5.2.1 **Government Responsible Items.** The obligation and work limiting date for all shipbuilding programs under the SCN appropriation will normally be at the end of the 11th month following completion of the fitting out period. For submarines, the fitting out period ends at delivery. Government responsible work accomplished in support of a new construction ship and funded under SCN is limited to work which can be completed prior to the end of this 11 month period. Authorization for correction of non-reactor plant government responsible deficiencies is provided by the Navy Shipbuilding Program Manager based on a priority assignment by the ship and recommendations from the Type Commander (TYCOM). Authorization for correction of reactor plant government responsible deficiencies is provided by NAVSEA Nuclear Propulsion Directorate (08).

5.2.2 **Shipbuilder Responsible Items.** Construction contracts with private industrial activities contain a guarantee clause. The rights of the government concerning deficiencies identified during the guarantee period are set forth in the contract. Deficiencies must be identified and reported to the shipbuilder and cognizant government agencies prior to the end of the guarantee period in order for corrective action to be established. Correction of deficiencies designated shipbuilder responsible can be accomplished during any subsequent period that the ship is made available to the shipbuilder. Availability of the ship is usually limited to the Post Shakedown Availability (PSA), except under special circumstances when immediate corrective action prior to PSA is required to permit the ship to meet

operational commitments. The ship may also be made available to the shipbuilder after PSA to permit follow-up corrective action on shipbuilder responsible deficiencies identified during the guarantee period but not satisfactorily corrected during PSA.

5.2.3 Recommended Changes in Characteristics, Design Specifications, or Plans. Improvements to the ship recommended by INSURV will be investigated by the Navy Shipbuilding Program Manager. Action, as appropriate, will be initiated by a government approved change. This change may be in the form of a Field Modification Request (FMR), Headquarters Modification Request (HMR), Ship Change, Strategic Systems Programs Alteration (SPALT), Service Change and Field or Engineering Change Proposal. Changes of this nature usually have application to more than one ship of the class. Improvements to the ship recommended by Ship's Force should be forwarded by the CO in accordance with Volume VI, Chapter 3 (submarines) or Volume VI, Chapter 36 (surface force ships/aircraft carriers) as appropriate, of this manual to the Navy Shipbuilding Program Manager via the Supervising Authority.

5.3 REQUIRED REPORTS. The responsibility for ensuring deficiencies are corrected rests jointly with the CO, the Supervising Authority and the Navy Shipbuilding Program Manager. The method of corrective action varies with the type of deficiency and may involve the coordinated action of several activities. In order to effectively prosecute each deficiency, special reporting and handling procedures are necessary. The Ship's Maintenance Data System shall be implemented not later than delivery in accordance with reference (a). This will provide a smooth transition into the appropriate ship and shore based data management systems and permit Maintenance and Material Management (3-M) documentation of all INSURV deficiencies for use with the Consolidated Report. The Consolidated Report provides follow-up action on all deficiencies and minimizes administrative effort.

- a. Consolidated Report. A Consolidated Report, compiled by the Navy Shipbuilding Program Manager, combines into one document the screening actions, reports of completed actions and significant information as listed below (as applicable):
 - (1) AT/CT INSURV Report.
 - (2) FCT/GMI INSURV Report.
 - (3) Post Delivery Deficiency Items (PDDI).
 - (4) CSCT.
 - (5) Silencing Deficiencies.
 - (6) HMRS.
 - (7) Navy Shipbuilding Program Manager action on all deficiencies.
 - (8) Shipbuilder Delivery Letter.
 - (9) Supervising Authority evaluation of shipbuilder comments on Deficiency Items.
 - (10) Priority assignment of all deficiencies.
 - (11) TYCOM action on all deficiencies.
 - (12) Authorized action for PSA for appropriate items.
 - (13) Final status of all deficiencies at the end of the SCN funding period (PSA Completion Report).
 - (14) TYCOM final action on each item uncorrected at the end of the SCN funding period.
 - (15) Identification of deficiencies requiring Navy Shipbuilding Program Manager action to develop corrective action.
 - (16) Estimated cost to the government for correction by Forces Afloat of shipbuilder responsible deficiencies.
 - (17) Antenna Inspection Deficiency Items.

- b. Report Format. Appendix A of this chapter is an example of a completed page of the Consolidated Report, containing sample entries from various parts. The symbols used in defining the action taken by each activity are described in Appendix B of this chapter along with a discussion of the use of each column. The Consolidated Report typically consists of the following parts:
- (1) Part A Key Definitions for Symbols used in the PSA Work Package.
 - (2) Part B INSURV Deficiencies.
 - (3) Part C-I Non-Nuclear HMRs.
 - (4) Part C-II Other Non-Nuclear Items.
 - (5) Part C-III Non-Nuclear CSCT Items.
 - (6) Part D Antenna Inspection Deficiency Items.
 - (7) Part E PDDIs.
 - (8) Part F Silencing Deficiencies.
- c. Preparation.
- (1) Part B:
 - (a) List of INSURV deficiency items: Prepared by the Navy Shipbuilding Program Manager and distributed following CT/AT.
 - (b) List of INSURV GMI/FCT items: Prepared by the ship in accordance with Appendix C of this chapter immediately following the GMI/FCT for use by NAVSEA at the GMI/FCT Card Conference. The Navy Shipbuilding Program Manager will distribute a finalized GMI/FCT list following the GMI/FCT Card Conference.
 - (2) Part C-I, C-II, C-III, D and F: Prepared and distributed by the Navy Shipbuilding Program Manager.
 - (3) Part E: Prepared by the ship as discussed in section 5.6 of this chapter.
- d. Reporting.
- (1) Thirty days after delivery, the ship will submit marked up copies of Part B indicating the priority assignment of each uncorrected CT/AT deficiency (Navy Shipbuilding Program Manager, TYCOM, Immediate Superior in Command (ISIC), Supervising Authority).
 - (2) The Navy Shipbuilding Program Manager will prepare and distribute marked up copies of Parts C-I, C-II, C-III, D and F as the information becomes available.
 - (3) Priority assignment for Part B deficiencies (including review of all uncorrected CT/AT deficiencies) is determined at the GMI/FCT Card Conference. Marked up copies are retained by all participants. (Navy Shipbuilding Program Manager, TYCOM, ISIC, Ship, Supervising Authority).
 - (4) The ship will report deficiencies discovered after GMI/FCT and before the end of the SCN period in accordance with section 5.6 of this chapter.
 - (5) Deficiencies listed in the Consolidated Report which are corrected by Forces Afloat are to be reported in writing to the Navy Shipbuilding Program Manager with copies to the TYCOM, the Supervising Authority as appropriate, and the scheduled PSA activity. This report will normally be submitted by the ship at the end of a refit or maintenance period. Negative reports are not required.
 - (6) The ship will submit a marked up copy of the Consolidated Report to the TYCOM; copy to the ISIC, Navy Shipbuilding Program Manager, Supervising Authority, Submarine Maintenance Engineering, Planning and Procurement (SUBMEPP) Activity (for submarines), Surface Maintenance Engineering, Planning Program (SURFMEPP) (for surface force ships)

and the President of the INSURV Board thirty days after PSA or at the end of the guarantee period, whichever is later. This report will indicate the final status of all deficiencies identified during the guarantee period.

5.4 COMBINED TRIALS/ACCEPTANCE TRIALS. The CT/AT is scheduled by the Supervising Authority and conducted by the INSURV Board. The Supervising Authority in conjunction with the ship's CO will present to the INSURV Board known deficiencies which require correction.

5.5 GUARANTEE MATERIAL INSPECTION/FINAL CONTRACT TRIALS. GMIs/FCTs are scheduled by the TYCOM and conducted by the INSURV Board after shakedown, prior to the end of the guarantee period. These inspections/trials provide a formal evaluation of the material condition of each newly constructed ship after limited service. GMIs/FCTs are conducted sufficiently in advance of PSA to allow "lead time" for the procurement of material and the advanced planning required for the correction of deficiencies during the availability. The CO will present the ship's material status to the INSURV Board following the guidance in Appendix C of this chapter. GMIs are conducted for submarines; all other ships will undergo an FCT.

5.6 POST DELIVERY DEFICIENCY ITEMS. The CO is responsible for reporting deficiencies not otherwise identified by INSURV, until the end of the SCN period in accordance with the following procedures. By using the same format for PDDI reporting as for INSURV items and by extending the use of the Consolidated Report to include these items, the same management attention is afforded to all construction deficiencies.

- a. The following types of problems should be reported as PDDIs:
 - (1) Recurring failures in a piece of equipment or machinery such that the reliability is considered unsatisfactory.
 - (2) Major equipment or component malfunction which requires outside assistance to correct (vendor or industrial activity).
 - (3) Symptoms of major machinery problems which require investigation to determine the extent of the problem. (Improper temperatures, pressures, leakage, vibration, noise, etc.).
 - (4) Insufficient supply support for specific equipment or machinery based on operational experience. Allowance deficiencies reported as PDDIs should be supplemented by submission of Allowance Change Requests/Configuration Change Reports as appropriate.
 - (5) Excessive or accelerated wear, erosion, or corrosion determined through inspection.
 - (6) Improper bonding of preservation on surfaces that must be protected.
 - (7) Any casualty which results in a Casualty Report (CASREP). Insert an amplification data set immediately after the Parts Identification data set consisting of "AMPN/PDDI:___-___/\"", ensuring that the CASREP includes all appropriate PDDI addressees. A separate PDDI must also be submitted.
 - (8) Identification of any condition or defect which requires a Departure from Specification request.
 - (9) Improper alignment, clearance, or resistance to ground which indicates an unaccounted for change from baseline data.
 - (10) Significant internal and external valve leakage. (Primary, seawater, steam, air, hydraulics, etc.).
 - (11) Any significant AT/CT deficiency item reported corrected which has recurred. Refer to the AT/INSURV number in the text of the deficiency description.
 - (12) Any AT/CT deficiency item reported corrected by the shipbuilder which is not considered by the ship to be complete. Refer to the AT/INSURV number in the text of the deficiency description.

NOTE: DEFICIENCIES AND MATERIAL PROBLEMS WHICH ARE CORRECTED BY SHIP'S FORCE WITHOUT ASSISTANCE SHOULD NOT BE REPORTED AS PDDIs.

- b. Reporting.

- (1) Between delivery and GMI/FCT, uncorrected deficiencies of the nature described above should be documented in the Current Ship's Maintenance Project (CSMP) and presented to the INSURV Board for consideration during GMI/FCT.
- (2) Problems requiring corrective action prior to PSA, or of such significance that planning will have to commence as early as possible, should be reported by OPNAV 4790/2K without delay. The OPNAV 4790/2K must contain the sequential identification number of the PDDI and a brief description of the problem being reported. Multiple PDDIs per report are encouraged. Items reported by OPNAV 4790/2K should be included in the next regular PDDI report. The OPNAV 4790/2K should also be sent by message, or email where appropriate, and shall be addressed to the Supervising Authority, with information copies to the Navy Shipbuilding Program Manager, TYCOM (N40), the ISIC, and NAVSEA 08 (for items with nuclear cognizance).
- (3) Routine PDDIs shall be reported by OPNAV 4790/2K and summarized at least monthly after the GMI/FCT.
- (4) All PDDIs shall be assigned a sequential number identifying the item for administrative purposes and a priority in the "ship" column of the 4760-1 Report. This forms Part E of the Consolidated Report. Report Form 4760-1 will be provided to the ship at the GMI/FCT Card Conference.
- (5) Distribution of the PDDI report by the ship will be as follows:
 - (a) Advance copy to the Supervising Authority.
 - (b) Advance copy to the Navy Shipbuilding Program Manager. (Nuclear deficiencies to NAVSEA 08).
 - (c) Copy to the ISIC.
 - (d) Original to the Supervising Authority via the TYCOM and the Navy Shipbuilding Program Manager.
- (6) All PDDIs shall be assigned a Job Sequence Number (JSN) in the ship's JSN log prior to input into the ship's CSMP. The CSMP summary line (Block 37, OPNAV 4790/2K) will contain the PDDI sequential number for cross reference.

(This Page Intentionally Left Blank)

APPENDIX A

SAMPLE PAGE OF 4760-1 REPORT WITH REPRESENTATIVE DATA

USS _____

REPORT 4760-1

Item	Description	N/S Action	K	SOS	Ship	TY	PSA	Final	Tycom	N/S
1K1ax (CT)	Snorkel safety circuit high vacuum trip does not function.	K	KA	XK	XK	--	--	--	--	--
1A509ax (GMI)	Nitrogen stowage capacity insufficient to support requirements of oxygen generator operation for extended operations.	NA3 ShipAlt will be accomp IAW FMP	--	A	A		SA	SSN 1070K		NA3
594-16 (PDDI)	SPM inoperable due to zero ground.				A	A	KA	XK	--	--
SI-2 (CSCT)	Bow area rattle, affects BQA-8 hydrophones #3 and #4.	K					K	XF	--	--

Page

I-5A-1

COMUSFLTFORCOMINST 4790.3 REV C

(This Page Intentionally Left Blank)

APPENDIX B

LEGEND AND EXPLANATION OF SYMBOLS USED IN REPORT 4760-1

1. Each activity will enter in the applicable column the appropriate symbol to indicate status, position, priority, responsibility or authorization for each item.
2. Extra pages shall be added to the package as necessary to provide history, results of investigations or comments to clarify the position or the item itself.
3. The action taken for each item in each of the columns from the "N/S Action" column through the "PSA" column will be an integrated action by all concerned following INSURV CT/AT, GMI/FCT, and PSA related conferences.
4. The following is a brief description of the purpose of each column:
 - a. Column "N/S Action" - Indicates Navy Shipbuilding Program Manager assignment of responsibility. No government SCN funded work is authorized in this column. Authorization of work will be as stated under the "PSA" column for each line item in the work package.
 - b. Column "K" - Column "K" is used to indicate the position of the shipbuilder for an item indicated in column "N/S Action" as being the responsibility of the shipbuilder to correct. The shipbuilder may prepare insert pages for comments as appropriate. A rationale is to be provided for all items not accepted (marked "KZ") by the shipbuilder.
 - c. Column "SOS" - This column is used to indicate the position of the Supervising Authority for each of the items as feasible but especially for those items on which the shipbuilder has responded in column "K".
 - d. Column "Ship" - This column is used by the ship to indicate the status or action desired for each item still considered open, including a priority assignment regardless of the responsibility/action indicated by INSURV or assigned by the Navy Shipbuilding Program Manager or reported corrected by the Supervising Authority. Comments from Ship's Force providing further information and clarification as insert pages are especially helpful in planning correction of any item.
 - e. Column "TY" - This column indicates the position of the TYCOM on the priority assignment of the ship.
 - f. Column "PSA" - This column is used by NAVSEA. Authorization of SCN funded work appears only in this column.
 - g. Column "Final" (Ship and Supervising Authority) - This column is used to indicate the final status of each deficiency at the end of the SCN funded period. This column may be used by the shipbuilder to report to the Supervising Authority the status of deficiencies at the end of the guarantee period. This column is used by Supervising Authority to provide the final status of all authorized work (government and shipbuilder) as reported by the shipbuilder at completion of PSA. This information should be used as a portion of the Departure Report which is to be forwarded to the Navy Shipbuilding Program Manager not later than 50 days following the end of the ship's PSA. Comments and recommendations by the Supervising Authority advising correction or non-correction of open items are required.
 - h. Column "TYCOM" (Final) - This column is used to indicate the action desired by the TYCOM on all items still open at the end of the PSA period. This data will be reviewed at a "Disposition Conference" to be convened and chaired by the Navy Shipbuilding Program Manager.
 - i. Column "N/S" (Final) - This column will be used by the Ship Program Manager to report on agreements made between the TYCOM and the Navy Shipbuilding Program Manager during the "Disposition Conference" for each open deficiency item.
5. The following list of symbols is provided in alphabetical order for ease of use. In the interest of simplification, many symbols have been combined.

Key	Used In The Following Columns	Definition
A	Ship, TY, PSA	Navy Shipbuilding Program Manager authorize correction of the item by the industrial activity as an item for first priority.
B	Ship, TY, PSA	Navy Shipbuilding Program Manager authorize correction of the item by the industrial activity as a highly desirable second priority item of work.
C	Ship, TY, PSA	Navy Shipbuilding Program Manager authorize correction of the item by the industrial activity within available funds as third order of priority.
F	N/S Action thru N/S	Forces Afloat to correct using TYCOM funds. This includes TYCOM Alteration and Improvement (A&I) Items.
FL	Final, TYCOM	Ship's Force submit request for alteration or request for change to ship's allowance.
FU	Ship, Final	Forces Afloat will follow-up on material through procurement and correct the deficiency.
FV	Ship thru Final	Forces Afloat will correct with technical assistance from equipment manufacturer/vendor or the Navy Shipbuilding Program Manager.
G	N/S Action	Government responsible to correct condition noted as necessary to comply with shipbuilding specifications. No work authorized except by specific Navy Shipbuilding Program Manager action.
G/F	N/S Action, PSA	Government responsible to approve for accomplishment for Forces Afloat. Navy Shipbuilding Program Manager/Supervising Authority will provide material or technical/design assist as required.
GI	All	Navy Shipbuilding Program Manager investigate and authorize correction as appropriate.
G/V	N/S Action, PSA	Government responsible - equipment still under guarantee. Vendor responsible for correcting condition as noted. Supervising Authority responsible to ensure vendor is available and correction is taken under vendor supervision.
K	N/S Action, PSA	Shipbuilder responsible, authorized to correct condition noted as necessary to comply with shipbuilding specifications.
KA	K	Shipbuilder accepts responsibility for correction with or without comment. Comment on attached supplementary page.
K/F	N/S Action, PSA	Shipbuilder responsible to make installations and all repair work. Shipboard testing approved for accomplishment by Forces Afloat.
K/G	N/S	Shipbuilder responsible, authorized to investigate and correct condition noted as necessary to comply with shipbuilding specifications. Government responsible for defects in Government Furnished Equipment (GFE) or Government Furnished Information (GFI). No work authorized for government portion of item without separate specific Navy Shipbuilding Program Manager action.
KI	K	Shipbuilder accepts item for investigation with determination of responsibility to be made after investigation.
KZ	K	Shipbuilder does not accept the item as his responsibility. Rationale to be provided on attached supplementary page.

Key	Used In The Following Columns	Definition
NA	N/S Action	Not authorized using SCN funds: 1. Cost not commensurate with gain. 2. No longer considered a deficiency. 3. Recommend correction be accomplished by a Ship Alteration (SHIPALT) during future availability.
SA	Final, TYCOM, N/S	Recommend SHIPALT be developed to correct.
SC	SOS	Comments of shipbuilder are accepted and concurred with by the Supervising Authority.
SI	N/S Action	Silencing deficiency items with responsibility and authorization to be determined by separate Navy Shipbuilding Program Manager action.
SM	PSA	Supervising Authority is authorized to procure material and turn same over to Ship's Force for installation. A copy of the requisitioning document will be provided to Ship's Force to allow supply follow-up action if necessary.
SZ	SOS	Item remains controversial. Comments of the Supervising Authority are provided on attached supplementary page.
TY	PSA	Approved for correction by the industrial activity when authorized and funded by the TYCOM.
V	Ship, TY, PSA	Government provide vendor service for Forces Afloat to assist during PSA.
XF	SOS thru Final	Item was corrected by Forces Afloat.
XG	SOS thru Final	Item was corrected by shipbuilder or other industrial activity under a work specification, job order, or FMR funded by the government.
XK	SOS thru Final	Shipbuilder has completed corrective action.
#	N/S Action, PSA	Changes to Navy Shipbuilding Program Manager action.
*	PSA	Authority to be provided separately by NAVSEA 08 action.

(This Page Intentionally Left Blank)

APPENDIX C**PREPARATION FOR GUARANTEE MATERIAL INSPECTION/FINAL CONTRACT TRIALS**

1. To properly prepare for and document deficiencies for the GMI/FCT conducted by the INSURV Board and conduct the GMI Card Conference, the following guidance is provided.

a. Pre-GMI/FCT Documents

- (1) Ship's Force provide to the INSURV Board:
 - (a) For previously reported CT/AT items, provide two copies of the Navy Shipbuilding Program Manager's Initial PSA Consolidated List with all INSURV items considered complete by Ship's Force lined out. Do not obliterate items lined out.
 - (b) Document all new deficiencies which have occurred since CT/AT on OPNAV 4790/2Ks in accordance with reference (a).
- (2) Upon arrival, Ship's Force provide to Navy Shipbuilding Program Manager representative(s) one complete set of each of the Pre-GMI/FCT documents as outlined in paragraph 1.a.(1) above.
- (3) Ship's Force submit required number of copies of all documents for entry into the CSMP in accordance with reference (a).

b. Action on Final GMI/FCT Documents

- (1) The INSURV Board will return the complete listing of GMI/FCT findings to the Navy Shipbuilding Program Manager representative(s) for follow-up action. This listing will include all items in format per paragraph 1.a.(1) above. The Navy Shipbuilding Program Manager will assemble this listing and prepare the GMI/FCT Consolidated Report, Section B, as required by this instruction. Type only the new documented findings from the OPNAV 4790/2Ks (1.a.(1)(b) above).
- (2) Ship's Force will provide working spaces and administrative support as required by references (b) and (c).

(This Page Intentionally Left Blank)

VOLUME I
CHAPTER 6
POST SHAKEDOWN AVAILABILITY

REFERENCES.

- (a) OPNAVINST 4700.8 - Trials, Acceptance, Commissioning, Fitting Out, Shakedown, and Post Shakedown Availability of U.S. Naval Ships Undergoing Construction or Conversion
- (b) NAVSO P 1000 - Navy Comptroller Manual
- (c) NAVSEAINST 4790.8/OPNAVINST 4790.4 - Ships' Maintenance and Material Management (3-M) Manual
- (d) INSURVINST 4730.11 - Preparation of Deficiency Forms
- (e) OPNAVINST 3540.3 - Naval Nuclear Propulsion Examining Boards

LISTING OF APPENDICES.

- A Major Funding Milestones During Construction/Conversion
- B Post Shakedown Availability Planning Events Milestone Schedule
- C Summary of Major Milestones for Post Shakedown Availability

6.1 PURPOSE.

- a. Post Shakedown Availability (PSA) is an industrial activity availability assigned to correct deficiencies found during the shakedown cruise or to accomplish other authorized improvements. PSAs are scheduled to commence after delivery and to be completed prior to the Shipbuilding and Conversion, Navy (SCN) obligation work limiting date. This date occurs at the end of the 11th month after the month in which the Fitting Out Period completed for surface units or at the end of the 11th month after the month in which delivery occurs for submarines. Appendix A of this chapter, taken from reference (a), reflects the Major Milestones during Construction related to funding. Funding guidelines for PSA are outlined in reference (b).
- b. The length of time designated for PSAs will vary dependent on the platform. Acceptance Trial (AT), Final Contract Trial (FCT), Combined Trial (CT) and Guarantee Material Inspection (GMI) related deficiencies constitute the majority of the PSA workload. Navy Shipbuilding Program Manager planned, authorized and funded modifications may also be included.

6.2 PLANNING AND EXECUTION. The events leading to a successful completion of PSA involve several activities and a variety of actions and reports. Appendix B of this chapter outlines the schedule of PSA planning events.

6.3 TRIALS, INSPECTIONS AND CREW CERTIFICATION. For nuclear and Surface Force Ships, Appendix C of this chapter provides a summary of major milestones required for PSA. For submarines, Appendices BC and CC in Volume II, Part I, Chapter 3 of this manual provide a summary of major milestones.

6.4 SEA TRIALS.

6.4.1 General. Sea Trials are required to test work completed during PSA. The mandatory submarine requirements for PSA Sea Trials are identified in Volume II, Part I, Chapter 3 of this manual. Volume II, Part I, Chapter 3, Appendix K of this manual provides a list of the minimum tests to be performed during Sea Trials for Surface Force Ships. The industrial activity shall include at least two days in the availability for Sea Trials. The industrial activity shall prepare an agenda for Sea Trials conducted after a PSA. Extensions or reductions of the Sea Trial period may be granted where warranted by the scope of work accomplished. Where an extension of Sea Trial and a change in the availability schedule is required, requests for such extensions must be submitted by the industrial activity to the Type Commander (TYCOM) as early as practical. All deficiencies resulting from Sea Trials shall be satisfactorily resolved prior to completion of the availability. If no Sea Trial deficiencies are found, the availability may be completed with TYCOM concurrence at the completion of Sea Trials.

6.5 DEFICIENCY CORRECTION PERIOD. A deficiency correction period will be scheduled after Sea Trials and prior to PSA completion. The scheduled length of this deficiency correction period shall be determined by the type and magnitude of the remaining deficiencies.

6.6 PERIOD FOLLOWING POST SHAKEDOWN AVAILABILITY. Depending on the PSA contract, the industrial activity will normally guarantee work accomplished during an availability for a period of 90 days from the completion of the availability. This does not include responsibility for malfunctioning machinery and equipment due to normal wear, improper adjustment, or tuning by Ship's Force and failure of limited life components. Ship's Force is required to report guarantee items to the industrial activity prior to the guarantee period expiration date. If operational commitments prohibit reporting prior to the 90 day period, the ship should report problems as soon as operations permit. A message is the preferred method of reporting these items. The message outlining specific deficiencies should be submitted to the Supervising Authority with a copy to the TYCOM, the Immediate Superior in Command (ISIC) and the Navy Shipbuilding Program Manager who will pass a copy to Naval Sea Systems Command (NAVSEA) 04, and to NAVSEA 08 for nuclear cognizant issues. Additionally, any Casualty Reports (CASREP) submitted during the guarantee period must also be addressed to the Supervising Authority and the Navy Shipbuilding Program Manager with passing instructions to NAVSEA 04, and to NAVSEA 08 for nuclear cognizant issues.

**APPENDIX A
MAJOR FUNDING MILESTONES DURING
CONSTRUCTION/CONVERSION**

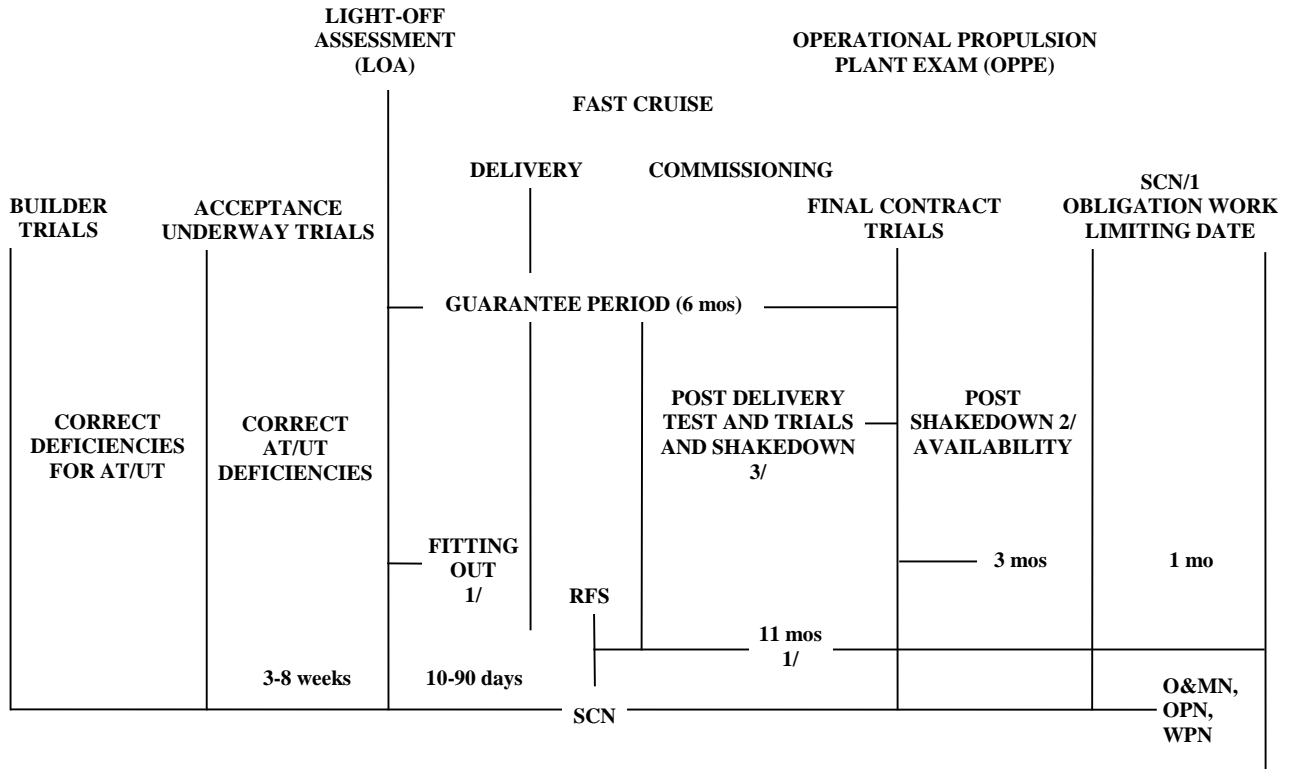

NOTE:

1. SSN/CVN fitting out is complete prior to delivery. Hence, the SCN obligation work limiting date is at the end of the 11th month after the month in which delivery occurs.
2. PSA is normally scheduled to complete approximately one month prior to the obligation limiting date.
3. Total period of PDT&T and Shakedown shall be a minimum of six months. A waiver may be granted for a period greater than eight months; a request to extend SCN obligation limiting date may be required.

(This Page Intentionally Left Blank)

APPENDIX B

POST SHAKEDOWN AVAILABILITY PLANNING EVENTS MILESTONE SCHEDULE

NOTE: EVENT TIMES ARE IN DAYS BEFORE AND AFTER DELIVERY AND ARE APPROXIMATE. SIGNIFICANT ADJUSTMENT MAY BE REQUIRED FOR PSAs THAT COMMENCE AT OTHER TIMES AFTER DELIVERY.

Time	Event
-90	a. Ship review and update Out of Commission List.
-30	a. Ship review and update Maintenance Data System and Equipment Deficiency Log in accordance with reference (c).
-21	a. Supervising Authority prepare OPNAV 4790/2Ks for all deficiencies to be presented to the Board of Inspection and Survey (INSURV) at AT/CT in accordance with reference (d). b. AT/CT conducted by the INSURV Board. c. Conference following critique of AT/CT. (1) <u>Purpose</u> - to identify and resolve controversies over responsibility and timing for correction of deficiencies. (2) <u>Participants</u> - Navy Shipbuilding Program Manager, Supervising Authority, Shipbuilder and Ship. d. Supervising Authority provide ship one copy of each documented INSURV item for input at delivery into the Current Ship's Maintenance Project (CSMP) in accordance with reference (c).
0	a. Delivery. b. Navy Shipbuilding Program Manager issue Section B of Consolidated Report. c. Ship's Force submit OPNAV 4790/2Ks for all INSURV items and for all other material deficiencies that qualify for the CSMP.
10	a. Shipbuilder issues delivery letter.
20	a. Supervising Authority comments on delivery letter.
27	a. PSA Planning Conference. (1) <u>Purpose</u> - To establish PSA work package from input to date and to identify required advance planning actions. (2) <u>Participants</u> - Navy Shipbuilding Program Manager, Supervising Authority, TYCOM, Ship and Shipbuilder.
30	a. Ship submit priority list of AT/CT deficiencies.
35	a. TYCOM comments on ship's priority list.
40	a. Navy Shipbuilding Program Manager issue list of SCN funded items authorized for accomplishment during PSA.

Time	Event
42	a. TYCOM assign availability.
45	a. Supervising Authority issue initial PSA work package. b. (Submarines only) Latest date for the conduct of Navy Shipbuilding Program Manager sponsored Acoustic and Combat System Certification Trials in order to present to the INSURV Board at the GMI.
50	a. Prepare for FCT/GMI in accordance with reference (c). b. TYCOM representative places ship in "INSURV Window" and calls down ship's Pre-INSURV Package.
54	a. FCT/GMI by the INSURV Board. b. Conference following FCT/GMI critique (may coincide with Planning or Pre-Arrival Conference). <ul style="list-style-type: none"> (1) <u>Purpose</u> - To assign responsibility for correction of deficiencies and to assign ship/TYCOM priorities. (2) <u>Participants</u> - Navy Shipbuilding Program Manager, Supervising Authority, Shipbuilder, TYCOM, Ship, and ISIC (optional). c. Navy Shipbuilding Program Manager issue Section B of Consolidated Report. d. Ship comply with reference (c) for documenting INSURV items.
75	a. (Submarines only) Silencing Deficiency Conference: <ul style="list-style-type: none"> (1) <u>Purpose</u> - Naval Surface Warfare Center Carderock Division (NSWCCD) presents results of acoustic trials data analysis. (2) <u>Participants</u> - NSWCCD, Navy Shipbuilding Program Manager, Shipbuilder, TYCOM, Ship.
90	a. Navy Shipbuilding Program Manager issue final list of SCN funded items authorized for accomplishment during PSA.
100	a. Supervising Authority issue final PSA work package.
149	a. Pre-Arrival Conference: <ul style="list-style-type: none"> (1) <u>Purpose</u> - To review all work authorized by all customers with available cost estimates and to establish arrival procedures and conditions for the ship. Review and take action on Post Delivery Deficiency Items (PDDI). (2) <u>Participants</u> - Navy Shipbuilding Program Manager, Supervising Authority, Shipbuilder, TYCOM, ISIC and Ship.
154	a. Commence PSA. b. Arrival Conference (Navy Shipbuilding Program Manager and TYCOM participation not required unless specifically requested).

Time	Event
214-274	a. End PSA. (Completion date varies with platform).
	a. Ship submit final status report of all deficiencies (Departure Report).
*	a. TYCOM comment on final status report from ship and submit recommendations for Navy Shipbuilding Program Manager action.
**	b. TYCOM issue follow-up letter requesting Navy Shipbuilding Program Manager final resolution and action on government responsible uncorrected deficiencies.
***	a. Work limiting date for SCN appropriation.

* 30 days after completion of PSA

** 45 days after completion of PSA

*** Refer to Appendix A of this chapter, Note (1)

(This Page Intentionally Left Blank)

APPENDIX C

SUMMARY OF MAJOR MILESTONES FOR POST SHAKEDOWN AVAILABILITY

Event	Cognizance	Approximate Schedule see Note 1
A. Periodic Monitoring Inspections	ISIC/TYCOM	Start to completion
B. (Nuclear Powered Ships only) Pre-Criticality Inspection (required if reactor shutdown greater than 16 weeks)	ISIC/TYCOM	Criticality -4 weeks
C. (Nuclear Powered Ships only) Post-Overhaul Reactor Safeguard Examination (per reference (e) if reactor shutdown greater than 6 months)	Fleet Commander	Criticality -4 weeks
D. Light-Off Assessment (LOA) (if propulsion plant shut down greater than 120 days)	Fleet Commander/ TYCOM	-30 days
E. (Nuclear Powered Ships only) Approve Sea Trials Agenda	ISIC/TYCOM	-30 days
F. Dock Trials	Commanding Officer (CO) of ship	-21 days
G. Crew Certification	ISIC/TYCOM	-9 days
H. (Nuclear Powered Ships only) Message Certifying Crew and Material Readiness to Navy Shipbuilding Program Manager	TYCOM	-8 days
I. (Nuclear Powered Ships only) Authorize Ship to Commence Fast Cruise upon receipt of NAVSEA Permission to Conduct Critical Operations	TYCOM	-8 days
J. Commence Fast Cruise	CO of Ship	-7 days (2 days on, 1 off, 2 on)(length of Fast Cruise may be reduced based on length and extent of availability)
K. Report Completion of Fast Cruise and Ready for Sea Trials Message	Supervising Authority to TYCOM (CO of Ship concur)	-1 day
L. Authorize Commencement of Sea Trials Message	TYCOM to ISIC/TYCOM to Ship	-1 day
M. Commence Sea Trials	CO of Ship	0
N. Sea Trials Completion Message	Supervising Authority	+1 day

NOTE 1: Unless otherwise indicated, scheduled date referenced to Sea Trials underway date.

(This Page Intentionally Left Blank)

JOINT FLEET MAINTENANCE MANUAL
VOLUME II
INTEGRATED FLEET MAINTENANCE
LIST OF EFFECTIVE PAGES

Page Numbers	Change in Effect	Page Numbers	Change in Effect
i thru v	Change 5	II-I-2F-1	Change 2
vi thru x	Change 3	II-I-2F-2	REV C
xi thru xviii	Change 5	II-I-3-1 thru II-I-3-3	Change 2
xix thru xx	Change 4	II-I-3-4	Change 4
xxi thru xxiv	Change 3	II-I-3-5	Change 5
II-I-1-1 thru II-I-1-2	REV C	II-I-3-6	Change 2
II-I-1A-1	Change 2	II-I-3-7	REV C
II-I-1A-2	Change 5	II-I-3-8	Change 2
II-I-1A-3	Change 3	II-I-3-9 thru II-I-3-69	Change 5
II-I-1A-4	Change 5	II-I-3-70	Change 2
II-I-1A-5 thru II-I-1A-6	Change 4	II-I-3A-1	Change 4
II-I-1B-1	Change 1	II-I-3A-2 thru II-I-3A-4	REV C
II-I-1B-2	REV C	II-I-3B-1 thru II-I-3B-2	Change 2
II-I-1B-3	Change 4	II-I-3C-1 thru II-I-3C-2	Change 3
II-I-1B-4	Change 3	II-I-3D-1	REV C
II-I-2-1 thru II-I-22	Change 5	II-I-3D-2	Change 1
II-I-2A-1	Change 1	II-I-3E-1 thru II-I-3E-2	REV C
II-I-2A-2 thru II-I-2A-12	REV C	II-I-3F-1 thru II-I-3F-2	REV C
II-I-2B-1	REV C	II-I-3F-3	Change 1
II-I-2B-2	Change 1	II-I-3F-4	REV C
II-I-2C-1	Change 4	II-I-3G-1 thru II-I-3G-2	REV C
II-I-2C-2	REV C	II-I-3H-1 thru II-I-3H-2	REV C
II-I-2D-1 thru II-I-2D-2	REV C	II-I-3I-1	REV C
II-I-2E-1	Change 5	II-I-3I-2 thru II-I-3I-4	Change 1
II-I-2E-2	REV C	II-I-3J-1	Change 2

Page Numbers	Change in Effect	Page Numbers	Change in Effect
II-I-3J-2	REV C	II-I-3AC-1 thru II-I-3AC-2	REV C
II-I-3K-1 thru II-I-3K-6	Change 2	II-I-3AD-1 thru II-I-3AD-2	REV C
II-I-3K-7 thru II-I-3K-8	REV C	II-I-3AE-1 thru II-I-3AE-2	REV C
II-I-3L-1	Change 2	II-I-3AF-1 thru II-I-3AF-2	REV C
II-I-3L-2 thru II-I-3L-4	REV C	II-I-3AG-1 thru II-I-3AG-2	REV C
II-I-3M-1	REV C	II-I-3AH-1 thru II-I-3AH-2	REV C
II-I-3M-2	Change 2	II-I-3AI-1 thru II-I-3AI-2	REV C
II-I-3N-1	REV C	II-I-3AJ-1	Change 1
II-I-3N-2 thru II-I-3N-3	Change 2	II-I-3AJ-2	REV C
II-I-3N-4	Change 3	II-I-3AK-1	Change 2
II-I-3N-5	Change 5	II-I-3AK-2	REV C
II-I-3N-6	Change 2	II-I-3AL-1	Change 5
II-I-3O-1 thru II-I-3O-2	REV C	II-I-3AL-2	REV C
II-I-3O-3	Change 4	II-I-3AM-1	Change 3
II-I-3O-4	Change 2	II-I-3AM-2	Change 5
II-I-3O-5	Change 5	II-I-3AN-1	Change 5
II-I-3O-6	Change 3	II-I-3AN-2	REV C
II-I-3O-7	Change 4	II-I-3AO-1 thru II-I-3AO-5	Change 5
II-I-3O-8	Change 2	II-I-3AO-6	Change 1
II-I-3O-9	Change 5	II-I-3BA-1 thru II-I-3BA-2	REV C
II-I-3O-10	REV C	II-I-3BB-1	Change 1
II-I-3P-1	Change 2	II-I-3BB-2	REV C
II-I-3P-2	REV C	II-I-3BC-1 thru II-I-3BC-2	Change 2
II-I-3Q-1 thru II-I-3Q-2	Change 2	II-I-3BD-1 thru II-I-3BD-2	REV C
II-I-3Q-3 thru II-I-3Q-8	REV C	II-I-3BE-1 thru II-I-3BE-2	REV C
II-I-3R-1	Change 2	II-I-3BF-1	Change 1
II-I-3R-2	Change 4	II-I-3BF-2	REV C
II-I-3AA-1 thru II-I-3AA-2	REV C	II-I-3BG-1 thru II-I-3BG-2	REV C
II-I-3AB-1 thru II-I-3AB-2	REV C	II-I-3BH-1 thru II-I-3BH-2	REV C

Page Numbers	Change in Effect	Page Numbers	Change in Effect
II-I-3BI-1 thru II-I-3BI-2	REV C	II-I-3CG-2	REV C
II-I-3BJ-1 thru II-I-3BJ-2	REV C	II-I-3CH-1	Change 1
II-I-3BK-1	Change 1	II-I-3CH-2	REV C
II-I-3BK-2	REV C	II-I-3CI-1	Change 1
II-I-3BL-1 thru II-I-3BL-2	REV C	II-I-3CI-2	REV C
II-I-3BM-1	REV C	II-I-3CJ-1 thru II-I-3CJ-2	REV C
II-I-3BM-2	Change 3	II-I-3CK-1 thru II-I-3CK-2	REV C
II-I-3BN-1 thru II-I-3BN-2	REV C	II-I-3CL-1	Change 1
II-I-3BO-1	Change 1	II-I-3CL-2	Change 2
II-I-3BO-2	REV C	II-I-3CM-1	Change 1
II-I-3BP-1	Change 4	II-I-3CM-2	REV C
II-I-3BP-2	REV C	II-I-3CN-1 thru II-I-3CN-2	REV C
II-I-3BQ-1	Change 4	II-I-3CO-1 thru II-I-3CO-2	REV C
II-I-3BQ-2	REV C	II-I-3CP-1	REV C
II-I-3BR-1 thru II-I-3BR-2	Change 4	II-I-3CP-2	Change 3
II-I-3BS-1	Change 4	II-I-3CQ-1 thru II-I-3CQ-2	REV C
II-I-3BS-2	REV C	II-I-3CR-1	Change 4
II-I-3BT-1	Change 4	II-I-3CR-2	REV C
II-I-3BT-2	REV C	II-I-3CS-1 thru II-I-3CS-2	Change 4
II-I-3CA-1 thru II-I-3CA-2	REV C	II-I-3CT-1 thru II-I-3CT-2	Change 4
II-I-3CB-1	Change 2	II-I-3CU-1 thru II-I-3CU-2	REV C
II-I-3CB-2	REV C	II-I-3CV-1	Change 4
II-I-3CC-1 thru II-I-3CC-3	Change 2	II-I-3CV-2	REV C
II-I-3CC-4	REV C	II-I-4-1	Change 1
II-I-3CD-1	Change 1	II-I-4-2 thru II-I-4-6	Change 4
II-I-3CD-2	Change 2	II-I-4-7	Change 5
II-I-3CE-1 thru II-I-3CE-2	REV C	II-I-4-8 thru II-I-4-21	Change 4
II-I-3CF-1 thru II-I-3CF-2	REV C	II-I-4-22	Change 5
II-I-3CG-1	Change 1	II-I-4-23 thru II-I-4-28	Change 4

Page Numbers	Change in Effect	Page Numbers	Change in Effect
II-I-4A-1	Change 3	II-I-4R-1	Change 3
II-I-4A-2	REV C	II-I-4R-2	REV C
II-I-4B-1 thru II-I-4B-2	REV C	II-I-4S-1	Change 1
II-I-4C-1 thru II-I-4C-2	REV C	II-I-4S-2	REV C
II-I-4D-1 thru II-I-4D-4	REV C	II-I-4T-1 thru II-I-4T-2	REV C
II-I-4E-1 thru II-I-4E-2	REV C	II-I-4U-1	Change 1
II-I-4E-3	Change 3	II-I-4U-2	REV C
II-I-4E-4 thru II-I-4E-6	REV C	II-I-4V-1 thru II-I-4V-2	REV C
II-I-4F-1 thru II-I-4F-2	REV C	II-I-4W-1 thru II-I-4W-2	REV C
II-I-4G-1 thru II-I-4G-2	REV C	II-I-4X-1 thru II-I-4X-2	REV C
II-I-4H-1	Change 4	II-I-4Y-1 thru II-I-4Y-2	REV C
II-I-4H-2	Change 2	II-II-1-1 thru II-II-1-4	Change 1
II-I-4H-3 thru II-I-4H-6	Change 3	II-II-1-5	Change 3
II-I-4H-7 thru II-I-4H-8	Change 4	II-II-1-6	Change 1
II-I-4I-1 thru II-I-4I-2	REV C	II-II-1-7	Change 2
II-I-4J-1 thru II-I-4J-2	REV C	II-II-1-8 thru II-II-1-9	Change 3
II-I-4K-1	Change 1	II-II-1-10	Change 1
II-I-4K-2	REV C	II-II-1A-1 thru II-II-1A-7	Change 1
II-I-4L-1 thru II-I-4L-2	REV C	II-II-1A-8	REV C
II-I-4M-1	Change 2	II-II-2-1 thru II-II-2-2	Change 3
II-I-4M-2 thru II-I-4M-4	REV C	II-II-2-3	Change 2
II-I-4N-1 thru II-I-4N-2	REV C	II-II-2-4	REV C
II-I-4O-1	Change 1	II-II-2-5	Change 1
II-I-4O-2	REV C	II-II-2-6	Change 5
II-I-4P-1 thru II-I-4P-2	REV C	II-II-2-7	Change 3
II-I-4Q-1 thru II-I-4Q-2	REV C	II-II-2-8 thru II-II-2-10	Change 4
II-I-4Q-3	Change 1	II-II-2-11	Change 2
II-I-4Q-4	Change 5	II-II-2-12	Change 3
II-I-4Q-5 thru II-I-4Q-6	REV C	II-II-2A-1 thru II-II-2A-2	Change 3

Page Numbers	Change in Effect	Page Numbers	Change in Effect
II-II-2A-3 thru II-II-2A-4	REV C	II-III-5-1 thru II-III-5-6	REV C
II-II-2B-1 thru II-II-2B-3	Change 2	II-III-5A-1 thru II-III-5A-2	REV C
II-II-2B-4	Change 3	II-III-5B-1 thru II-III-5B-2	REV C
II-II-2B-5 thru II-II-2B-6	REV C	II-III-5C-1 thru II-III-5C-2	REV C
II-II-2C-1	Change 3	II-III-5D-1 thru II-III-5D-2	REV C
II-II-2C-2	REV C	II-III-5E-1 thru II-III-5E-4	REV C
II-II-2D-1 thru II-II-2D-6	Change 2		
II-II-2D-7 thru II-II-2D-26	Change 5		
II-II-2E-1 thru II-II-2E-2	REV C		
II-II-2F-1	Change 3		
II-II-2F-2	REV C		
II-II-2G-1	Change 3		
II-II-2G-2	REV C		
II-II-2H-1 thru II-II-2H-2	REV C		
II-II-2H-3 thru II-II-2H-4	Change 3		
II-II-3-1	Change 2		
II-II-3-2	Change 5		
II-II-3-3 thru II-II-3-4	Change 2		
II-III-FWD-1 thru II-III-FWD-2	REV C		
II-III-1-1 thru II-III-1-2	REV C		
II-III-2-1 thru II-III-2-3	REV C		
II-III-2-4	Change 2		
II-III-2-5	REV C		
II-III-2-6	Change 2		
II-III-2-7 thru II-III-2-9	REV C		
II-III-2-10	Change 2		
II-III-2-11 thru II-III-2-20	REV C		
II-III-3-1 thru II-III-3-4	REV C		
II-III-4-1 thru II-III-4-4	REV C		

(This Page Intentionally Left Blank)

JOINT FLEET MAINTENANCE MANUAL
VOLUME II
INTEGRATED FLEET MAINTENANCE
RECORD OF CHANGES

CHANGE NO.	DATE	TITLE OR BRIEF DESCRIPTION	ENTERED BY (INITIALS)

(This Page Intentionally Left Blank)

JOINT FLEET MAINTENANCE MANUAL CHANGE REQUEST FORM	
<p>FROM: ACTIVITY/SHIP _____ E-MAIL ADDRESS _____ CODE/DEPT/SHOP _____ DATE _____ ORIGINATOR _____ TEL EXT () _____</p>	
<p>VOL-PART-PARA NO. _____ FIGURE _____ TABLE _____ PROCESSING NORMAL _____ URGENT* _____ * (Justify in rationale below if urgent is marked and transmit via e-mail as "High Importance") PROBLEM DESCRIPTION:</p>	
<p>RECOMMENDED CHANGE: (Include any proposed text addition/deletion)</p>	
<p>RATIONALE:</p>	

E-mail to PTNH.SUBMEPP.JFMMMGR@Navy.Mil

(If mailing, fold on dotted line on reverse side and mail to Submarine Maintenance Engineering, Planning and Procurement (SUBMEPP) Activity or send facsimile to (207) 438-6210.)

FOLD

Commanding Officer

OFFICIAL BUSINESS

Commanding Officer
Submarine Maintenance Engineering,
Planning and Procurement (SUBMEPP) Activity
Attn: Code 1832JM
P.O. Box 2500
Portsmouth Naval Shipyard
Portsmouth, NH 03804-2500

FOLD

JOINT FLEET MAINTENANCE MANUAL
VOLUME II
INTEGRATED FLEET MAINTENANCE
TABLE OF CONTENTS

	Page No.
LIST OF EFFECTIVE PAGES	i
RECORD OF CHANGES	vii
JOINT FLEET MAINTENANCE MANUAL CHANGE REQUEST FORM.....	ix
PART I	
CHAPTER 1 - INTRODUCTION	
1.1 Purpose	II-I-1-1
1.2 Scope	II-I-1-1
1.3 Changes and Corrections	II-I-1-2
1.4 Request for Copies of the Manual	II-I-1-2
Appendices	
A List of Acronyms	II-I-1A-1
B Glossary of Terms.....	II-I-1B-1
CHAPTER 2 - MAINTENANCE AND MODERNIZATION PROGRAM	
2.1 Purpose	II-I-2-2
2.1.1 Naval Supervisory Authority	II-I-2-2
2.1.2 Lead Maintenance Activity.....	II-I-2-5
2.1.3 Ship's Responsibility.....	II-I-2-6
2.2 Maintenance Accomplishment Levels	II-I-2-6
2.2.1 Fleet Maintenance.....	II-I-2-6
2.2.2 Industrial Maintenance	II-I-2-6
2.3 Reliability Centered Maintenance.....	II-I-2-7
2.4 Condition Based Maintenance	II-I-2-7
2.4.1 Unrestricted Operations (Submarines Only).....	II-I-2-7
2.4.2 Periodic Maintenance Requirements Program (Submarines Only)	II-I-2-7
2.4.3 Material Condition Assessment Feedback Program (Submarines Only).....	II-I-2-7
2.4.4 Machinery Condition Analysis (Surface Force Ships and Aircraft Carriers).....	II-I-2-8
2.4.4.1 General.....	II-I-2-8
2.4.4.2 Automated Machinery Condition Analysis.....	II-I-2-8
2.4.4.3 Machinery Condition Analysis Surveys.....	II-I-2-8
2.4.4.4 Ship's Force Machinery Vibration Analysis Program.....	II-I-2-8
2.4.5 Ship Assessment, Groom and Evaluation	II-I-2-8
2.4.6 Performance Monitoring Team.....	II-I-2-8
2.4.7 Command, Control, Communications, Computers and Combat Systems Readiness Assessment Program (Aircraft Carriers Only).....	II-I-2-9
2.4.8 Electronic Systems Review (SSBN/SSGN 726 Class Submarines Only)	II-I-2-9
2.5 System/Component Maintenance Programs (Submarines and Aircraft Carriers Only).....	II-I-2-9
2.5.1 Advanced Equipment Repair Program (Submarines Only)	II-I-2-9
2.5.2 TRIDENT Planned Equipment Replacement Program (SSBN/SSGN 726 Class Submarines Only)	II-I-2-10
2.5.3 Aircraft Carrier Planned Equipment Replacement Program (Aircraft Carriers Only).....	II-I-2-10

2.5.4	SEAWOLF Class Rotatable Pool Program.....	II-I-2-10
2.6	Modernization.....	II-I-2-10
2.6.1	Navy Modernization Program	II-I-2-10
2.6.2	Types of Ship Changes	II-I-2-11
2.6.3	Navy Data Environment System.....	II-I-2-11
2.6.3.1	Submarine Force Navy Modernization Process	II-I-2-11
2.7	Integrated Fleet Maintenance Management.....	II-I-2-11
2.7.1	Continuous Maintenance	II-I-2-12
2.7.1.1	Continuous Screening Process	II-I-2-12
2.7.1.2	Continuous Planning Process.....	II-I-2-12
2.7.1.3	Continuous Execution Process.....	II-I-2-12
2.8	Technical Assistance	II-I-2-12
2.8.1	Regional Maintenance Center.....	II-I-2-12
2.8.2	Ship Assessment, Groom and Evaluation.....	II-I-2-12
2.8.3	Carrier and Field Service Unit.....	II-I-2-13
2.8.4	Elevator Support Unit.....	II-I-2-13
2.8.5	Propulsion Plant Engineering Activity (Aircraft Carriers Only)	II-I-2-13
2.8.6	Waterfront Corrective Action Program	II-I-2-13
2.8.7	Fleet Maintenance Support Branch (Nuclear Powered Vessels Only).....	II-I-2-13
2.9	Propulsion Plant Material Condition (Aircraft Carriers Only).....	II-I-2-13
2.9.1	Purpose	II-I-2-13
2.9.2	Applicability	II-I-2-13
2.9.3	Ship's Force Requirements	II-I-2-13
2.9.3.1	Reactor Maintenance Officer	II-I-2-13
2.9.3.2	Material Condition Assessment Process	II-I-2-14
2.9.3.3	Methods for Assessment of Material Condition.....	II-I-2-18
2.9.3.3.1	Attributes and Acceptance Standards for Material Condition Inspections.....	II-I-2-19
2.9.3.4	Propulsion Plant Planned Maintenance.....	II-I-2-19
2.9.3.5	Training for Ship's Force	II-I-2-19
2.9.4	Type Commander Responsibilities.....	II-I-2-19
2.9.4.1	Type Commander Mobile Training Team Visits	II-I-2-20
2.9.5	Assessing Deficiency Impact and Scheduling Corrective Action.....	II-I-2-20
2.10	100 Hour Transition Periods (Surface Force Ships Only)	II-I-2-20
2.10.1	Critical Time Period	II-I-2-20
2.10.2	First 100 Hour Plan.....	II-I-2-20
2.10.3	Final 100 Hour Plan.....	II-I-2-21

Appendices

A	Material Condition Assessment Process Timeline.....	II-I-2A-1
B	CVN Propulsion Plant Material Condition Assessments.....	II-I-2B-1
C	System Certification Checklist for CNO Availability Key Events (Aircraft Carriers Only)	II-I-2C-1
D	Scope of Visual Inspections of Reactor Plant Fluid Systems	II-I-2D-1
E	First 100 Hours for Surface Force Scheduled Availability.....	II-I-2E-1
F	Final 100 Hours for Surface Force Scheduled Availability	II-I-2F-1

CHAPTER 3 - CHIEF OF NAVAL OPERATIONS SCHEDULED MAINTENANCE AVAILABILITIES

3.1	Purpose	II-I-3-4
3.2	Chief of Naval Operations Scheduled Maintenance Availabilities.....	II-I-3-4
3.2.1	Early Start	II-I-3-5
3.2.2	Early Start Concurrence.....	II-I-3-5
3.2.3	Readiness to Start Availability (Aircraft Carriers and Surface Force Ships Only).....	II-I-3-5
3.2.3.1	Readiness to Start Brief.....	II-I-3-5

3.3	Maintenance Policies and Procedures.....	II-I-3-6
3.3.1	Critical Path Jobs.....	II-I-3-6
3.3.2	Work Sequence Schedule.....	II-I-3-6
3.3.3	Milestones.....	II-I-3-6
3.3.4	Production Completion Date.....	II-I-3-7
3.3.5	Combat Systems Production Completion Date (AEGIS Light Off for AEGIS ships) (Surface Force Ships Only).....	II-I-3-8
3.3.6	Memorandum of Agreement.....	II-I-3-8
3.3.7	Responsibilities.....	II-I-3-9
3.3.7.1	Fleet Commander.....	II-I-3-9
3.3.7.2	Type Commander.....	II-I-3-9
3.3.7.3	Type Commander/Immediate Superior In Command (Group or Squadron).....	II-I-3-10
3.3.7.4	Submarine Maintenance Engineering Planning and Procurement Activity/Planning Engineering Repairs and Alterations.....	II-I-3-11
3.3.7.5	(Surface Force Ships only) Surface Maintenance Engineering Planning Program (SURFMEPP).....	II-I-3-11
3.3.7.6	Ship's Commanding Officer.....	II-I-3-12
3.3.7.7	Maintenance Team (Surface Force Ships Only).....	II-I-3-13
3.3.7.8	Technical Warrant Holders and In-Service Engineering Agents (Surface Force Ships Only).....	II-I-3-13
3.3.7.9	NAVSEA 05D (Surface Force Ships Only).....	II-I-3-13
3.4	Availability Work Package Planning.....	II-I-3-13
3.4.1	Forces Afloat Planning Sources.....	II-I-3-13
3.4.2	Forces Afloat Planning Actions.....	II-I-3-14
3.4.2.1	Forces Afloat Work Package Preparations.....	II-I-3-14
3.4.3	Availability Work Packages.....	II-I-3-15
3.4.3.1	Availability Work Package Content.....	II-I-3-15
3.4.3.2	Availability Work Package Sources.....	II-I-3-15
3.4.3.3	Availability Work Package Development.....	II-I-3-15
3.5	Availability Planning.....	II-I-3-16
3.5.1	Ship's Force Pre-Planning.....	II-I-3-16
3.5.1.1	Industrial Activity Visit.....	II-I-3-17
3.5.1.2	BAWP Milestones for Surface Force Ships.....	II-I-3-18
3.5.1.2.1	Corrosion Planning Conference.....	II-I-3-18
3.5.1.2.2	Life Cycle Planning Conference.....	II-I-3-18
3.5.1.2.3	Baseline Availability Work Package.....	II-I-3-18
3.5.1.2.4	Fleet Readiness Plan Mid-Cycle Review.....	II-I-3-19
3.5.1.2.5	Mid-Cycle Review.....	II-I-3-19
3.5.1.2.6	Review of BAWP and CSMP.....	II-I-3-19
3.5.1.2.7	Updating the BAWP.....	II-I-3-19
3.5.1.2.8	BAWP Turnover to TYCOM.....	II-I-3-20
3.5.1.3	Availability Coordinator (Submarines Only).....	II-I-3-20
3.5.2	Docking Conference.....	II-I-3-20
3.5.3	Ship's Force Administrative Preparations.....	II-I-3-20
3.5.4	TYCOM AWP Schedule and Documentation Requirements (Surface Force Ships Only).....	II-I-3-21
3.5.4.1	Resource Allocation.....	II-I-3-21
3.5.4.2	Technical Resolution.....	II-I-3-21
3.5.4.3	Change Notifications.....	II-I-3-21
3.5.4.4	Technical Deferral and Adjudication Process for Post-AWP Definitization (for Cost Contracts and Award (Firm Fixed Price Contracts) Through the End of the Execution Period).....	II-I-3-21
3.5.5	BAWP/AWP Change Management Process (Surface Force Ships Only).....	II-I-3-22
3.5.5.1	Branding.....	II-I-3-22
3.5.5.2	CMP Cancellation Deferral Notification System.....	II-I-3-22
3.5.5.3	BAWP Work Item Branding Categories.....	II-I-3-22
3.5.5.4	Branding Responsibility.....	II-I-3-23
3.5.5.5	Change Request Types.....	II-I-3-23

3.5.5.6	Deferral Process for an “A” Branded Mandatory Requirement (Surface Force Ships Only)	II-I-3-23
3.5.6	Modernization (Surface Force Ships Only)	II-I-3-24
3.5.6.1	Modernization List.....	II-I-3-24
3.5.6.2	BAWP/AWP Update	II-I-3-24
3.6	Availability Execution	II-I-3-24
3.6.1	Responsibilities.....	II-I-3-24
3.6.1.1	Fleet Commander.....	II-I-3-24
3.6.1.2	Type Commander/Immediate Superior In Command (Group or Squadron).....	II-I-3-24
3.6.1.2.1	Extended Operating Cycles	II-I-3-26
3.6.1.3	Fleet Maintenance Activity	II-I-3-26
3.6.1.4	Ship's Force and MST (if assigned)	II-I-3-26
3.6.2	Arrival Conference	II-I-3-27
3.6.2.1	Scheduling and Conducting	II-I-3-27
3.6.3	Routine Meetings and Conferences	II-I-3-27
3.6.3.1	Weekly Management Meetings.....	II-I-3-27
3.6.3.2	Docking/Undocking Conferences	II-I-3-29
3.6.3.3	Interim Completion Conferences (Surface Force Ships Only).....	II-I-3-29
3.6.4	Assist Ship's Force Funds.....	II-I-3-29
3.6.5	Integrated Logistics Overhaul.....	II-I-3-29
3.6.6	Ship's Selected Records.....	II-I-3-31
3.6.7	New Work.....	II-I-3-31
3.6.8	Trials, Inspections and Crew Certification	II-I-3-32
3.6.8.1	Surface Force Ship.....	II-I-3-32
3.6.8.1.1	Availability Work Certification and Completion Requirements (Surface Force Ship Only)	II-I-3-33
3.6.8.1.2	Key Event/Milestone Readiness (Surface Force Ship Only)	II-I-3-34
3.6.8.1.3	Availability/Key Event/Milestone Certification Procedures (Surface Force Ship Only)	II-I-3-36
3.6.8.1.4	Availability Certification Requirements and Procedures (Surface Force Ship only)	II-I-3-36
3.6.8.2	Aircraft Carriers	II-I-3-41
3.6.8.3	Trials, Inspections and Certification Minor Availabilities (Less Than Six Months) (Submarines Only)	II-I-3-42
3.6.8.3.1	Operating Depth Policy	II-I-3-45
3.6.8.3.2	Propulsion Plant Tests (If Required).....	II-I-3-45
3.6.8.3.3	Ocean Engineering Project Availability	II-I-3-45
3.6.8.3.4	Salvage Inspection (As Required)	II-I-3-45
3.6.8.3.5	Phase II Crew/Material Condition Inspection.....	II-I-3-45
3.6.8.3.6	Pre-Critical Inspections.....	II-I-3-45
3.6.8.3.6.1	Scheduling of Pre-Critical Inspections	II-I-3-45
3.6.8.3.6.2	Composition of the Inspection Team	II-I-3-46
3.6.8.3.6.3	Reports of Inspection	II-I-3-46
3.6.8.3.7	Dock Trials	II-I-3-46
3.6.8.3.8	Fast Cruise	II-I-3-46
3.6.8.3.9	Sea Trials	II-I-3-46
3.6.8.3.10	Interrupted Sea Trials	II-I-3-48
3.6.8.3.11	Availability Completion Prerequisites	II-I-3-48
3.6.8.4	Trials, Inspections and Certification Major Availabilities (Greater Than Six Months) (Submarines Only).....	II-I-3-49
3.6.8.4.1	Responsibilities.....	II-I-3-52
3.6.8.4.2	Type Commander Embarked Representative	II-I-3-60
3.6.8.4.3	Availability Completion Prerequisites	II-I-3-60
3.6.8.4.4	Inspection Procedures	II-I-3-61
3.6.8.4.5	Dock Trials	II-I-3-64
3.6.8.4.6	Fast Cruise	II-I-3-64
3.6.8.4.7	Sea Trials	II-I-3-64

3.6.8.4.8	Interrupted/Additional Sea Trials	II-I-3-66
3.6.8.4.9	Availability Completion Prerequisites	II-I-3-67
3.7	Completion of Availability	II-I-3-67
3.8	Availability Completion Departure Conference	II-I-3-68
3.8.1	Departure Conference and Availability Completion Message.....	II-I-3-68
3.9	Post Availability	II-I-3-68
3.9.1	Completed Availability Work Package	II-I-3-68
3.9.2	End-of-Cycle Analysis (Surface Force Ships Only)	II-I-3-68
3.9.3	Post-Availability Analysis (Surface Force Ships Only).....	II-I-3-68
3.10	Baseline Availability Work Package Close-Out (Surface Force Ships Only)	II-I-3-68
3.10.1	Fleet Readiness Plan Maintenance Cycle BAWP Close-Out.....	II-I-3-68
3.10.2	BAWP Close-Out Verification and Assessment Meeting	II-I-3-68
3.10.2.1	Attendees.....	II-I-3-68
3.10.2.2	BAWP Close-Out Letter	II-I-3-69

Appendices

A	Typical CNO Availability Planning Milestones (Submarines Only).....	II-I-3A-1
B	Typical CNO Availability Planning Milestones (Surface Force Ships Only).....	II-I-3B-1
C	Typical CNO Availability Planning Milestones (Aircraft Carriers Only)	II-I-3C-1
D	Suggested Guidelines for Forces Afloat Review of Availability Work Packages	II-I-3D-1
E	Monitoring Procedures (Surface Force Ships and Aircraft Carriers).....	II-I-3E-1
F ₁	SITREP/Progress Report (Aircraft Carriers Only)	II-I-3F-1
F ₂	SITREP/Progress Report (Surface Force Ships Only).....	II-I-3F-3
G	Sample New Work Forwarding Letter and Index	II-I-3G-1
H	Suggested Message Format for a New Work Candidate	II-I-3H-1
I	Minimum Dock Trials Requirements (Surface Force Ships and Aircraft Carriers).....	II-I-3I-1
J	Minimum Fast Cruise Requirements (Surface Force Ships and Aircraft Carriers).....	II-I-3J-1
K	Minimum Tests to be Performed During Sea Trials (Surface Force Ships and Aircraft Carriers).....	II-I-3K-1
L	Minimum Dock Trials Requirements (Submarines Only)	II-I-3L-1
M	Minimum Fast Cruise Requirements (Submarines Only)	II-I-3M-1
N	Minimum Sea Trials Requirements for Chief of Naval Operations Availabilities Less Than Six Months Duration (Submarines Only)	II-I-3N-1
O	Minimum Sea Trials Requirements for Chief of Naval Operations Availabilities Greater Than Six Months Duration (Submarines Only)	II-I-3O-1
P	Summary of Significant Post Repair Sea Trial Requirements (Submarines Only).....	II-I-3P-1
Q	Applicable RMC Availability Completion Certification Sheet (Surface Force Ships Only).....	II-I-3Q-1
R	Availability Quality Management Plan (QMP) (Surface Force Ships Only).....	II-I-3R-1

SAMPLE MESSAGES FOR CNO SCHEDULED AVAILABILITIES (SURFACE FORCE SHIPS ONLY)

AA	Sample Ship's Request for Permission to Commence Fast Cruise (Surface Force Ships and Aircraft Carriers).....	II-I-3AA-1
AB	Sample Ship's Report of Fast Cruise Completion (Surface Force Ships and Aircraft Carriers).....	II-I-3AB-1
AC	Sample Supervising Authority Readiness for Sea Trial Message (Surface Force Ships and Aircraft Carriers).....	II-I-3AC-1
AD	Sample Prime Contractor Availability Key Event Readiness Certification Memorandum (Surface Force Ships Only)	II-I-3AD-1
AE	Sample Fleet Maintenance Activity Availability Key Event Readiness Certification Memorandum (Surface Force Ships Only).....	II-I-3AE-1
AF	Sample Naval Shipyard Availability Key Event Readiness Certification Memorandum (Surface Force Ships Only)	II-I-3AF-1
AG	Sample Alteration Installation Team Availability Key Event Readiness Certification Memorandum (Surface Force Ships Only).....	II-I-3AG-1
AH	Sample Ship's Force Availability Key Event Readiness Certification Memorandum (Surface Force Ships Only).....	II-I-3AH-1

AI	Sample Quality Assurance Availability Key Event Readiness Certification Memorandum (Surface Force Ships Only).....	II-I-3AI-1
AJ	Sample Final Availability Key Event Readiness Certification Memorandum (Surface Force Ships Only).....	II-I-3AJ-1
AK	Branding Category (CAT) A Change Deferral Process (Surface Force Ships Only)	II-I-3AK-1
AL	BAWP Change Deferral Request (SAMPLE)	II-I-3AL-1
AM	Availability Planning Conference Agenda Sample (Surface Force Ships Only)	II-I-3AM-1
AN	BAWP Work Item Branding Categories (Surface Force Ships Only)	II-I-3AN-1
AO	BAWP to AWP Process (Surface Force Ships Only)	II-I-3AO-1

SAMPLE MESSAGES FOR CNO SCHEDULED AVAILABILITIES OF LESS THAN SIX MONTHS IN DURATION (SUBMARINES ONLY)

BA	Sample TYCOM Message Concerning Escort Services	II-I-3BA-1
BB	Sample ISIC Message to TYCOM Concerning Crew Certification and Material Condition for Fast Cruise and Sea Trials.....	II-I-3BB-1
BC	Major Trial and Inspection Milestones	II-I-3BC-1
BD	Sample TYCOM Message to Ship Concerning Sea Trials Depth Authorization	II-I-3BD-1
BE	Sample Ship Message to TYCOM Concerning Readiness for Follow-On Sea Trials	II-I-3BE-1
BF	Sample ISIC Message to TYCOM Concerning Material Certification for Follow-On Sea Trials.....	II-I-3BF-1
BG	Sample TYCOM Message to Ship Concerning Follow-On Sea Trials Depth Authorization	II-I-3BG-1
BH	Sample Ship Message to ISIC Concerning Readiness for Fast Cruise	II-I-3BH-1
BI	Sample ISIC Message to Ship Authorizing Commencement of Fast Cruise	II-I-3BI-1
BJ	Sample Ship Message to ISIC and TYCOM Concerning Readiness for Sea Trials	II-I-3BJ-1
BK	Sample ISIC Message to TYCOM Concerning Final Material Certification Prior to Sea Trials	II-I-3BK-1
BL	Sample Ship Message to ISIC and TYCOM Concerning Material Certification Upon Completion of Sea Trials	II-I-3BL-1
BM	Submarine Sea Trial Situation Report (SITREP)	II-I-3BM-1
BN	Sample Message Concerning Mod Alert Notification	II-I-3BN-1
BO	Sample TYCOM Message to Ship Concerning URO.....	II-I-3BO-1
BP	Message Scenario for CNO Availabilities of Less than Six Months in Duration	II-I-3BP-1
BQ	Sample ISIC Message to TYCOM Concerning Fly-By-Wire Crew Certification and Fly-By-Wire Material Condition for At-Sea Testing or Fast Cruise and Sea Trials	II-I-3BQ-1
BR	Sample TYCOM Message to Ship Concerning Authorization to Use Fly-By-Wire Ship Control Systems	II-I-3BR-1
BS	Sample ISIC Message to TYCOM Concerning Fly-By-Wire Material Certification Upon Completion of At-Sea Testing or Sea Trials	II-I-3BS-1
BT	Sample TYCOM Message to Ship Concerning URO for Fly-By-Wire Ship Control Systems.....	II-I-3BT-1

SAMPLE MESSAGES FOR CNO SCHEDULED AVAILABILITIES OF GREATER THAN SIX MONTHS DURATION (SUBMARINES ONLY)

CA	Sample SRDRS Support Services Message.....	II-I-3CA-1
CB	Sample ISIC Message to TYCOM Concerning Crew Certification	II-I-3CB-1
CC	Major Trial and Inspection Milestones	II-I-3CC-1
CD	Sample TYCOM Message to Ship Concerning Completion Prerequisites.....	II-I-3CD-1
CE	Sample TYCOM Message to NAVSEA Concerning Fast Cruise and Critical Reactor Operations	II-I-3CE-1
CF	Sample TYCOM Message to Ship Concerning Sea Trials Depth Authorization	II-I-3CF-1
CG	Sample TYCOM Message to Ship Concerning URO.....	II-I-3CG-1
CH	Sample ISIC Message to TYCOM Concerning Material Certification Prior to Sea Trials	II-I-3CH-1
CI	Sample ISIC Message to TYCOM Concerning Material Certification upon Completion of Sea Trials	II-I-3CI-1
CJ	Sample Ship Message to TYCOM Concerning Readiness for Fast Cruise	II-I-3CJ-1
CK	Sample Ship Message to TYCOM Concerning Readiness for Sea Trials	II-I-3CK-1

CL	Sample TYCOM Message Concerning Resumption of Sea Trials Completion Prerequisites.....	II-I-3CL-1
CM	Sample ISIC Message to TYCOM Concerning Material Certification for Follow-On Sea Trials.....	II-I-3CM-1
CN	Sample Ship Message to TYCOM Concerning Readiness for Follow-On Sea Trials	II-I-3CN-1
CO	Sample TYCOM Message to Ship Concerning Follow-On Sea Trials Depth Authorization	II-I-3CO-1
CP	Submarine Sea Trial Situation Report (SITREP)	II-I-3CP-1
CQ	Sample Message Concerning Mod Alert Notification	II-I-3CQ-1
CR	Message Scenario for CNO Availabilities of Greater than Six Months in Duration	II-I-3CR-1
CS	Sample NAVSEA Message to TYCOM Concerning Fly-By-Wire Ship Control Systems Material Condition Readiness for Sea Trials	II-I-3CS-1
CT	Sample TYCOM Message to Ship Concerning Authorization to Use Fly-By-Wire Ship Control Systems	II-I-3CT-1
CU	Sample ISIC Message to TYCOM Concerning Fly-By-Wire Material Certification Upon Completion of At-Sea Testing or Sea Trials	II-I-3CU-1
CV	Sample TYCOM Message to Ship Concerning URO for Fly-By-Wire Ship Control Systems	II-I-3CV-1

CHAPTER 4 - FLEET MAINTENANCE AVAILABILITIES

4.1	Purpose	II-I-4-2
4.2	Definitions	II-I-4-2
4.2.1	Fleet Maintenance Activity.....	II-I-4-2
4.2.2	Lead Maintenance Activity.....	II-I-4-2
4.2.3	Executing Activity	II-I-4-2
4.2.4	Business Case Analysis	II-I-4-2
4.2.5	Planning Board for Maintenance	II-I-4-3
4.2.6	Maintenance and Modernization Business Plan	II-I-4-3
4.2.7	Immediate Superior In Command.....	II-I-4-3
4.3	Fleet Maintenance Availabilities	II-I-4-3
4.3.1	Ship's Force Upkeep.....	II-I-4-3
4.3.2	Scheduled Continuous Maintenance Availability.....	II-I-4-3
4.3.3	Unscheduled Continuous Maintenance Availability.....	II-I-4-4
4.3.4	Emergent Availability.....	II-I-4-4
4.4	Common Elements.....	II-I-4-4
4.4.1	Responsibilities.....	II-I-4-4
4.4.1.1	Immediate Superior In Command	II-I-4-4
4.4.1.2	Regional Maintenance Center/Lead Maintenance Activity	II-I-4-4
4.4.1.3	Ship's Maintenance Team	II-I-4-5
4.4.1.4	Assigning Lead Maintenance Activity/Ship's Force Maintenance Responsibility..	II-I-4-5
4.4.1.5	Fleet Maintenance Activity/Nuclear Regional Maintenance Department Radiological Controls Support.....	II-I-4-6
4.4.2	Submission of Work Candidates.....	II-I-4-6
4.4.2.1	Documenting Requests	II-I-4-6
4.4.2.2	Message Work Candidates.....	II-I-4-6
4.4.3	Critical Jobs	II-I-4-6
4.4.4	Integrated Work Schedule	II-I-4-7
4.4.5	Technical Assistance and Assessment	II-I-4-7
4.4.6	Late Work and Scope Control	II-I-4-7
4.4.7	Memorandum of Agreement.....	II-I-4-7
4.4.8	Radiological Controls	II-I-4-7
4.4.9	Ship to Shop Material Control	II-I-4-7
4.4.10	Shipchecks	II-I-4-8
4.4.11	Lead Maintenance Activity Daily Production Meeting	II-I-4-8
4.4.12	Lead Maintenance Activity Progress Review.....	II-I-4-8

4.4.13	100 Hour Transition Periods (Submarines only)	II-I-4-9
4.4.13.1	First 100 Hour Plan (Submarines only).....	II-I-4-9
4.4.13.2	Final 100 Hour Plan (Submarines only).....	II-I-4-10
4.5	Ship's Force Upkeep	II-I-4-10
4.5.1	Upkeep Work Planning.....	II-I-4-10
4.5.1.1	Planning Sources.....	II-I-4-10
4.5.1.2	Ship's Force Planning Actions	II-I-4-10
4.5.2	Ship's Force Upkeep Work Execution	II-I-4-10
4.5.3	Ship's Force Upkeep Work Completion	II-I-4-10
4.5.3.1	Management Closeout Procedures	II-I-4-10
4.5.3.2	Dock Trials/Fast Cruise/Sea Trials	II-I-4-11
4.5.4	Ship Certification Prior to Underway (Submarines Only).....	II-I-4-11
4.6	Scheduled Continuous Maintenance Availability.....	II-I-4-11
4.6.1	Scheduled Continuous Maintenance Availability Planning.....	II-I-4-11
4.6.1.1	Scheduled Continuous Maintenance Availabilities Planning Sources	II-I-4-11
4.6.1.2	Scheduled Continuous Maintenance Availability Planning Functions	II-I-4-12
4.6.1.3	Issue Availability Planning Response Message (Submarines only).....	II-I-4-14
4.6.1.4	Arrival Conference.....	II-I-4-14
4.6.2	Continuous Maintenance Availability Execution	II-I-4-16
4.6.3	Continuous Maintenance Availability Completion Procedures	II-I-4-16
4.6.3.1	Management Reports Close-out Procedures	II-I-4-16
4.6.3.2	End of Scheduled Continuous Maintenance Availability Departure and Assessment Conference	II-I-4-16
4.6.3.3	Fast Cruise/Sea Trials	II-I-4-18
4.6.4	Hot Wash/Lessons Learned	II-I-4-18
4.6.5	Maintenance Management Performance Goals (Submarine Tenders only).....	II-I-4-18
4.6.5.1	Activity Performance Summary.....	II-I-4-18
4.6.5.2	Available Production Hours.....	II-I-4-19
4.6.5.3	Performance Indices.....	II-I-4-19
4.7	Year Long Continuous Maintenance	II-I-4-20
4.7.1	Year Long Continuous Maintenance Planning	II-I-4-20
4.7.2	Year Long Continuous Maintenance Work Execution	II-I-4-21
4.7.3	Continuous Maintenance Completion.....	II-I-4-21
4.8	Emergent Availability.....	II-I-4-21
4.8.1	Emergent Availability Planning.....	II-I-4-21
4.8.2	Work Execution	II-I-4-21
4.8.3	Availability Completion	II-I-4-21
4.9	Interim Drydocking/Pre-Inactivation Restricted Availabilities	II-I-4-21
4.9.1	Type Commander/Immediate Superior In Command (Group or Squadron) Responsibilities	II-I-4-21
4.9.2	Certification Availabilities (Less Than Six Months) (Submarines Only)	II-I-4-22
4.9.3	Operating Depth Policy	II-I-4-24
4.9.4	Propulsion Plant Tests (If Required).....	II-I-4-24
4.9.5	Phase II Crew/Material Condition Inspection.....	II-I-4-24
4.9.6	Pre-Critical Inspections.....	II-I-4-24
4.9.6.1	Scheduling of Pre-Critical Inspections.....	II-I-4-24
4.9.6.2	Composition of the Inspection Team	II-I-4-24
4.9.6.3	Reports of Inspection	II-I-4-25
4.9.7	Dock Trials	II-I-4-25
4.9.8	Fast Cruise	II-I-4-25
4.9.9	Sea Trials	II-I-4-25
4.9.10	Interrupted Sea Trials	II-I-4-27

Appendices

A	Sample Message to TYCOM from ISIC Requesting Concurrence to Defer, Delete or Shorten a Scheduled CMAV.....	II-I-4A-1
B	Sample TYCOM Message Concerning Escort Services for IDD or PIRA Availabilities	II-I-4B-1

C	Suggested Format for a Message Work Candidate	II-I-4C-1
D	Business Case Analysis Tool.....	II-I-4D-1
E1	Availability Key Event List	II-I-4E-1
E2	CMAV Key Event Codes	II-I-4E-3
F	Availability Planning Message (Submarines Only).....	II-I-4F-1
G	Final 100 Hours for Scheduled CMAV	II-I-4G-1
H ₁	Availability Milestone Schedule (SSNs and SSGNs Only).....	II-I-4H-1
H ₂	Availability Milestone Schedule (SSBNs Only).....	II-I-4H-7
I	Availability Planning Response Message (Submarines Only).....	II-I-4I-1
J	Major Trial and Inspection Milestones for IDD and PIRA Availabilities	II-I-4J-1
K	Sample ISIC Message to TYCOM Concerning Crew Certification and Material Condition for Fast Cruise and Sea Trials for IDD or PIRA Availabilities	II-I-4K-1
L	Sample Ship Message to ISIC and TYCOM Concerning Material Certification Upon Completion of Sea Trials for IDD or PIRA Availabilities	II-I-4L-1
M	Dock Trials Guidelines for IDD or PIRA Availabilities.....	II-I-4M-1
N	Fast Cruise Requirements for IDD or PIRA Availabilities.....	II-I-4N-1
O	Sample ISIC Message to TYCOM Concerning Final Material Certification Prior to Sea Trials for IDD or PIRA Availabilities.....	II-I-4O-1
P	Sample TYCOM Message to Ship Concerning Sea Trials Depth Authorization for IDD or PIRA Availabilities.....	II-I-4P-1
Q	Minimum Sea Trials Requirements for IDD or PIRA Availabilities.....	II-I-4Q-1
R	Submarine Sea Trial Situation Report (SITREP)	II-I-4R-1
S	Sample TYCOM Message to Ship Concerning URO for IDD or PIRA Availabilities	II-I-4S-1
T	Sample Ship Message to TYCOM Concerning Readiness for Follow-On Sea Trials for IDD or PIRA Availabilities.....	II-I-4T-1
U	Sample ISIC Message to TYCOM Concerning Material Certification for Follow-On Sea Trials in Cases Where a Previous Sea Trial was Aborted or Corrective Actions for Sea Trial Deficiencies Require an Additional Deep Dive for IDD or PIRA Availabilities.....	II-I-4U-1
V	Sample TYCOM Message to Ship Concerning Follow-On Sea Trials Depth Authorization for IDD or PIRA Availabilities.....	II-I-4V-1
W	Sample Ship Message to ISIC Concerning Readiness for Fast Cruise for IDD or PIRA Availabilities	II-I-4W-1
X	Sample ISIC Message to Ship Authorizing Commencement of Fast Cruise for IDD or PIRA Availabilities	II-I-4X-1
Y	Sample Ship Message to ISIC and TYCOM Concerning Readiness for Sea Trials for IDD or PIRA Availabilities.....	II-I-4Y-1

PART II

CHAPTER 1 - SHIP MAINTENANCE VALIDATION, SCREENING AND BROKERING

1.1	Purpose	II-II-1-1
1.2	Maintenance.....	II-II-1-1
1.2.1	Regional Maintenance Centers	II-II-1-1
1.2.2	Maintenance Team.....	II-II-1-1
1.2.3	Class Maintenance Plan.....	II-II-1-1
1.3	Work Candidates	II-II-1-2
1.3.1	Current Ship’s Maintenance Project Composition.....	II-II-1-2
1.3.2	Requirements	II-II-1-2
1.3.3	Elements	II-II-1-2
1.3.4	Guidelines.....	II-II-1-3
1.3.5	Validation	II-II-1-4
1.3.6	Verification.....	II-II-1-4
1.4	Screening/Brokering	II-II-1-4
1.4.1	Screening and Brokering Work Candidates.....	II-II-1-4

1.4.2	Screening/Brokering	II-II-1-5
1.4.3	Key Data	II-II-1-5
1.4.4	Guidelines	II-II-1-6
1.4.5	Additional Requirements for Scheduled Mandatory Tasks Pushed by CMP.....	II-II-1-7
1.5	Assessments	II-II-1-8
1.5.1	Maintenance Team.....	II-II-1-8
1.5.2	Type Commander	II-II-1-9
Appendices		
A	Availability Creation and Numbering.....	II-II-1A-1

CHAPTER 2 - SURFACE SHIP AND AIRCRAFT CARRIER WORK PACKAGE PREPARATION

2.1	Purpose	II-II-2-1
2.1.1	Prorated Business Rules	II-II-2-1
2.1.2	Responsibilities	II-II-2-1
2.2	Scope	II-II-2-1
2.3	Executing Activity Planning.....	II-II-2-2
2.4	Master Specification Catalog.....	II-II-2-2
2.4.1	Work Package Preparation.....	II-II-2-2
2.4.2	Use of the Master Specification Catalog	II-II-2-2
2.4.3	Central Planning Activities	II-II-2-3
2.4.4	General Process	II-II-2-3
2.4.5	Common Business Rules	II-II-2-4
2.4.6	Prorate Information.....	II-II-2-4
2.4.6.1	Prorate Distribution Process.....	II-II-2-4
2.4.6.2	Prorate Factors.....	II-II-2-5
2.5	Milestones.....	II-II-2-6
2.5.1	Committed Work at 80% Lock.....	II-II-2-6
2.5.2	Committed Work at 100% Lock.....	II-II-2-7
2.5.2.1	Automated Work Request Screening	II-II-2-7
2.5.3	Flow Metric	II-II-2-7
2.6	Continuous Maintenance Availabilities	II-II-2-7
2.6.1	Continuous Maintenance Availability Types.....	II-II-2-8
2.6.2	Continuous Maintenance Availability Business Rules	II-II-2-8
2.6.2.1	Applicability.....	II-II-2-8
2.6.2.2	Ship Specification Package	II-II-2-8
2.6.2.3	Planning.....	II-II-2-8
2.6.2.4	Planners and Estimators	II-II-2-9
2.6.2.4.1	Key Terms	II-II-2-9
2.6.2.4.2	Planning/Estimating Process.....	II-II-2-9
2.6.2.5	Maintenance Team Program Manager	II-II-2-10
2.6.2.6	Advanced Planning Manager	II-II-2-10
2.6.2.7	Scheduled Availabilities.....	II-II-2-10
2.6.2.8	Unscheduled Availabilities	II-II-2-11
2.6.3	Continuous Maintenance Availability Applicability	II-II-2-11
2.6.4	Work Included in Continuous Maintenance Availabilities	II-II-2-11
2.6.5	Concurrent Continuous Maintenance Availabilities	II-II-2-11
2.6.6	Ship Movement During a Continuous Maintenance Availability.....	II-II-2-11
2.6.7	Continuous Maintenance Availability Metrics	II-II-2-11
2.6.8	Continuous Maintenance Availability Late Work Premium (XAZ only).....	II-II-2-12
2.6.9	Continuous Maintenance Planning	II-II-2-12
2.7	Advance Planning Status Messages.....	II-II-2-12
2.8	Maintenance Teams Executing Maintenance with Firm Fixed Price Contracts	II-II-2-12

Appendices

A	Prorate Items with Explanations	II-II-2A-1
B	Master Specification Catalog Maintenance Office Guidelines	II-II-2B-1
C	Surface Ship Prorate Process	II-II-2C-1
D	Surface Ship Availability Milestones.....	II-II-2D-1
E	Aircraft Carrier Navy Modernization Process Milestones	II-II-2E-1
F	Planning Priority Matrix	II-II-2F-1
G	Depot Planning Priority Schedule (PSIA).....	II-II-2G-1
H ₁	Process Flowchart Firm Fixed Price CNO Availability	II-II-2H-1
H ₂	Process Flowchart Firm Fixed Price CMAV or Emergency Availability	II-II-2H-2
H ₃	Process Flowchart Firm Fixed Price PSIA CNO Availability	II-II-2H-3
H ₄	Process Flowchart Firm Fixed Price PSIA CMAV Availability.....	II-II-2H-4

CHAPTER 3 - MAINTENANCE WORK CLOSEOUT

3.1	Purpose	II-II-3-1
3.2	Scope.....	II-II-3-1
3.3	Background.....	II-II-3-1
3.4	Work Closeout Procedures	II-II-3-1
3.4.1	Depot Maintenance Activity Responsibilities	II-II-3-1
3.4.1.1	Private Shipyards Using the Navy Maintenance Database	II-II-3-1
3.4.1.2	Naval Shipyards and Facilities Using Advanced Industrial Management (AIM) or AIM Express (AIMXP)	II-II-3-2
3.4.1.3	Depot Maintenance Activities Not Using Navy Maintenance Database or Advanced Industrial Management.....	II-II-3-2
3.4.2	Fleet Maintenance Activity Responsibilities.....	II-II-3-2
3.4.2.1	Fleet Maintenance Activities Managing 2-kilos Using AIM, AIMXP, Advanced Industrial Management for Regional Maintenance Centers (AIM4RMC) or Tech Assist, Assessments and Scheduling Information Software (TAAS-INFO)	II-II-3-2
3.4.2.2	Fleet Maintenance Activities Managing 2-kilos Using Logistics Data System	II-II-3-2
3.4.2.3	Fleet Maintenance Activities Managing 2-kilos in a System Other Than AIM, AIMXP, AIM4RMC, TAAS-INFO or LDS	II-II-3-2
3.4.3	Maintenance Team Responsibilities.....	II-II-3-2
3.4.3.1	Work Executed by Private Shipyards Using the Navy Maintenance Database	II-II-3-3
3.4.3.2	Work Executed by Maintenance Activities Using AIM, AIMXP, AIM4RMC, LDS or TAAS-INFO	II-II-3-3
3.4.3.3	Work Executed by Maintenance Activities Not Using NMD, AIM, AIMXP, AIM4RMC, LDS or TAAS-INFO	II-II-3-3

PART III

FOREWORD - MISSION FUNDED FLEET MAINTENANCE ACTIVITIES

1.1	Purpose.....	II-III-FWD-1
1.2	Scope.....	II-III-FWD-1
1.2.1	Applicability	II-III-FWD-1
1.2.2	Authority.....	II-III-FWD-1
1.3	Organization.....	II-III-FWD-1
1.3.1	Basic Principles for Costing Maintenance	II-III-FWD-1
1.3.2	Special Requirements Associated with Maintenance Costing.....	II-III-FWD-1
1.4	Benefits of Capturing Costs.....	II-III-FWD-2

CHAPTER 1 - UNIFORM COSTING POLICIES AND PROCEDURES FOR FLEET MAINTENANCE ACTIVITIES

1.1	Purpose.....	II-III-1-1
1.2	Uniform Costing Policies and Procedures.....	II-III-1-1
1.2.1	Function.....	II-III-1-1
1.2.2	Classification.....	II-III-1-1
1.2.3	Uniformity.....	II-III-1-1
1.2.4	Control.....	II-III-1-1
1.2.5	Proration.....	II-III-1-1
1.2.6	Unique or New Requirements.....	II-III-1-1
1.2.7	Performance.....	II-III-1-1
1.2.8	Direct Cost Basic Definition.....	II-III-1-1
1.2.9	Mission Overhead Costs Basic Definition.....	II-III-1-2

CHAPTER 2 - DETAILED COSTING GUIDANCE FOR FLEET MAINTENANCE ACTIVITIES

2.1	Purpose.....	II-III-2-1
2.2	Types of Costs.....	II-III-2-1
2.2.1	Accommodation Storage and Handling.....	II-III-2-1
2.2.2	Administrative Assistance to Managers and Supervisors.....	II-III-2-1
2.2.3	Administrative Services for Tenants.....	II-III-2-2
2.2.4	Allowance List Outfit Material Items - Outfit Supply Activity Furnished Material.....	II-III-2-2
2.2.5	Issue and Return of Anti-Contamination Clothing.....	II-III-2-2
2.2.6	Funding Support of Board of Inspection and Survey.....	II-III-2-2
2.2.7	Calibration of Instruments.....	II-III-2-2
2.2.8	Clerical and Office Automation Staff.....	II-III-2-2
2.2.9	Administration and Review of Contractor Work.....	II-III-2-3
2.2.10	Crane Operators.....	II-III-2-3
2.2.11	Special Test and Certification of Cranes.....	II-III-2-3
2.2.12	Continuous Process Improvement.....	II-III-2-3
2.2.13	Data Processing Resources.....	II-III-2-3
2.2.14	Decontamination of Equipment and Tools.....	II-III-2-4
2.2.15	Delay Time.....	II-III-2-4
2.2.16	Dive Lockers.....	II-III-2-5
2.2.17	Dosimetry Issuing and Processing.....	II-III-2-5
2.2.18	Drills - Conducting and Participation.....	II-III-2-5
2.2.19	Dry Dock Blocks and Dock Caps.....	II-III-2-5
2.2.20	Dry Dock Operation.....	II-III-2-5
2.2.21	Preparation of Engineering Procedures for Specific Authorized Work.....	II-III-2-6
2.2.22	Equipment Maintenance.....	II-III-2-6
2.2.23	Equipment Rental.....	II-III-2-6
2.2.24	Disposal of Excess Plant Property.....	II-III-2-6
2.2.25	Fuel.....	II-III-2-7
2.2.26	Guarantee Work.....	II-III-2-7
2.2.27	Incentive Awards Program for Civilian and Military Personnel Assigned to the Activity.....	II-III-2-7
2.2.28	Inspection, Including Non-Destructive Testing.....	II-III-2-7
2.2.29	Inspection Services.....	II-III-2-8
2.2.30	Installation of Equipment.....	II-III-2-8
2.2.31	Janitorial Services and Work Area Clean-Up.....	II-III-2-9
2.2.32	Laundry Service.....	II-III-2-9
2.2.33	Lean.....	II-III-2-9
2.2.34	Lost and Damaged Tools.....	II-III-2-9
2.2.35	Lost Time.....	II-III-2-9
2.2.36	Upkeep of Maintenance Equipment.....	II-III-2-9

2.2.37	Maintenance of Nuclear Equipment	II-III-2-10
2.2.38	Management and Industrial Engineering Studies	II-III-2-10
2.2.39	Material Handling and Expediting.....	II-III-2-10
2.2.40	Fitness for Duty Medical Examination	II-III-2-10
2.2.41	Metal Stock Cutting (Bar, Pipe, Plate, Cable, etc.).....	II-III-2-11
2.2.42	Acquisition of Minor Property.....	II-III-2-11
2.2.43	Miscellaneous Expenses of the Production Resources Department Shops.....	II-III-2-11
2.2.44	Mock-Up Work.....	II-III-2-11
2.2.45	Pilot and Tug Service.....	II-III-2-11
2.2.46	Planning and Estimating Services.....	II-III-2-12
2.2.47	Acquisition of Plant Property Equipment	II-III-2-12
2.2.48	Pollutant Clean-Up	II-III-2-13
2.2.49	Pre-Expended Bins	II-III-2-13
2.2.50	Printing, Reproduction and Duplication	II-III-2-13
2.2.51	Programming Effort for Numerically-Controlled Machines.....	II-III-2-13
2.2.52	Purchase of Gas, Liquid or Solid.....	II-III-2-13
2.2.53	Radiological Control Engineering	II-III-2-13
2.2.54	Radiological Waste Processing.....	II-III-2-14
2.2.55	Refueling Equipment.....	II-III-2-14
2.2.56	Ripout Material.....	II-III-2-14
2.2.57	Satellite Steam Boiler	II-III-2-15
2.2.58	Security Furnished by the Fleet Maintenance Activity.....	II-III-2-15
2.2.59	Service Craft and Floating Equipment (Other than Nuclear).....	II-III-2-15
2.2.60	Services in Support of Centralized Tools and Equipment	II-III-2-15
2.2.61	Temporary Services	II-III-2-16
2.2.62	Severance Pay.....	II-III-2-16
2.2.63	Special Programs (External/Claimant Authorized).....	II-III-2-16
2.2.64	Supervision	II-III-2-17
2.2.65	Consumable Supplies.....	II-III-2-17
2.2.66	Operation and Maintenance of Tank Cleaning System.....	II-III-2-17
2.2.67	Telephone Services.....	II-III-2-17
2.2.68	Issue of Uncontaminated and Contaminated On Return Tools.....	II-III-2-17
2.2.69	Training of Personnel	II-III-2-18
2.2.70	Traumatic Injuries - Continuation of Pay	II-III-2-19
2.2.71	Utilities for Ships.....	II-III-2-19

CHAPTER 3 - UNIFORM COSTING POLICIES AND PROCEDURES RESPONSIBILITIES

3.1	Direct and Indirect Cost Identification Functions and Tasks Overview	II-III-3-1
3.1.1	Financial Management Organization.....	II-III-3-1
3.2	Organizational Relationships for Financial Management of Maintenance Activities	II-III-3-1
3.2.1	General.....	II-III-3-1
3.2.2	Chief of Naval Operations	II-III-3-1
3.2.3	Systems Commands	II-III-3-1
3.2.4	Naval Sea Systems Command	II-III-3-2
3.2.5	The Atlantic and Pacific Fleets	II-III-3-2
3.2.6	Type Commanders.....	II-III-3-2
3.2.7	Regional Maintenance Centers/Fleet Maintenance Activities	II-III-3-2
3.2.8	User Commands or Activities (Users).....	II-III-3-3
3.2.9	Naval Inactive Ship Maintenance Facilities.....	II-III-3-3
3.2.10	Naval Reserve Force Vessels.....	II-III-3-3
3.2.11	Foreign Governments	II-III-3-3
3.2.12	Private Companies - Demilitarizing and Stripping	II-III-3-4
3.3	Standards of Conduct.....	II-III-3-4

CHAPTER 4 - RETENTION OF FINANCIAL RECORDS

4.1	Purpose	II-III-4-1
-----	---------------	------------

4.2	General.....	II-III-4-1
4.2.1	Maintenance Cost Record Requirements.....	II-III-4-1
4.2.2	Record Retention in General.....	II-III-4-1
4.3	Immediate Superior In Command Record Retention.....	II-III-4-2
4.3.1	Financial Record Retention.....	II-III-4-2
4.3.2	Inspection Record Retention.....	II-III-4-2
4.3.3	Command Evaluation and Independent Audit Record Retention.....	II-III-4-2
4.3.4	Assessments, Evaluations and Audits.....	II-III-4-2
4.3.5	Training.....	II-III-4-2
4.4	Fleet Maintenance Activity Financial Management Record Retention.....	II-III-4-2
4.5	Lost Records.....	II-III-4-2

CHAPTER 5 - FINANCIAL AUDITS, EVALUATIONS AND ASSESSMENTS

5.1	Purpose.....	II-III-5-1
5.2	General.....	II-III-5-1
5.2.1	Audits.....	II-III-5-1
5.2.2	Evaluation.....	II-III-5-2
5.2.3	Assessments.....	II-III-5-2
5.2.4	Key Elements of an Effective Command Evaluation Review.....	II-III-5-2
5.2.5	Record Retention.....	II-III-5-2
5.3	Responsibilities and Procedures.....	II-III-5-2
5.3.1	Fleet Maintenance Activity Audit and Evaluation Program.....	II-III-5-2
5.3.2	Management Metrics for Direct Versus Indirect Costing.....	II-III-5-3
5.3.2.1	Metric Number 1, Total Indirect Time.....	II-III-5-3
5.3.2.1.1	Activity Goal.....	II-III-5-3
5.3.2.1.2	Activity Level.....	II-III-5-3
5.3.2.2	Metric Number 2, Direct Positions Charging Indirect.....	II-III-5-4
5.3.2.2.1	Activity Goal.....	II-III-5-4
5.3.2.2.2	Activity Level.....	II-III-5-4
5.3.2.3	Metric Number 3, Indirect Charges Against Reimbursable Orders.....	II-III-5-4
5.3.2.3.1	Activity Goal.....	II-III-5-4
5.3.2.3.2	Activity Level.....	II-III-5-4
5.3.3	Immediate Superior In Command Financial Management Assessments and Audits.....	II-III-5-4
5.4	Reporting Audit Results and Corrective Action.....	II-III-5-5
5.4.1	Reporting Requirements for External Audits and Assessments.....	II-III-5-5
5.4.2	Correcting Deficiencies in Job Order Numbers and/or Financial Records.....	II-III-5-5
5.4.3	Assessments, Evaluations and Audits.....	II-III-5-6

APPENDICES

A	Vertical Audits.....	II-III-5A-1
B	Horizontal Audits.....	II-III-5B-1
C	Checklist for Evaluating Direct Versus Indirect Costing.....	II-III-5C-1
D	Financial Management Audit Discrepancy Form.....	II-III-5D-1
E	Financial Management Discrepancy Form.....	II-III-5E-1

VOLUME II
PART I
CHAPTER 1
INTRODUCTION

REFERENCES.

- (a) OPNAVNOTE 4700 - Representative Intervals, Durations, Maintenance Cycles, and Repair Mandays for Depot Level Maintenance Availabilities of U.S. Navy Ships
- (b) OPNAVINST 4780.6 - Policy for Administering Service Craft and Boats in the U.S. Navy
- (c) OPNAVINST 4700.7 - Maintenance Policy for U.S. Naval Ships
- (d) OPNAVINST 3120.32 - Standard Organization and Regulations of the U.S. Navy
- (e) NAVSEAINST C9094.2 - Submarine Valve Operation Requirements for Builders and Post-Overhaul Sea Trial Test Dives
- (f) COMLANTFLTINST 5400.2 - U.S. Atlantic Fleet Regulations
- (g) COMPACFLTINST 5400.3 - U.S. Pacific Fleet Regulations
- (h) NAVSEAINST 4790.8/OPNAVINST 4790.4 - Ships' Maintenance and Material Management (3-M) Manual
- (i) SSPINST 4720.1 - Policies and Procedures for Alteration of Strategic Weapon System Equipment

LISTING OF APPENDICES.

- A List of Acronyms
- B Glossary of Terms

1.1 PURPOSE. The purpose of this volume is:

- a. To provide guidance for implementing and executing the management of an integrated fleet maintenance process for all Navy ships throughout their life cycle. This includes establishing policies and responsibilities for determining, authorizing, planning, scheduling, performing and evaluating maintenance of ships, to ensure quality, safety and maximum operational and material readiness. References (a) through (i) shall be used in conjunction with this volume in establishing an effective maintenance program.
- b. To outline current maintenance process policies and responsibilities for all maintenance availabilities and delineate programs and associated data management systems required for accomplishing this maintenance.

1.2 SCOPE.

- a. This volume applies to all ships of the Navy (active and reserve); it does not apply to civilian operated ships assigned to the Military Sealift Command. Throughout this manual, the term "ship" refers to all surface ships, aircraft carriers, submarines and those patrol and service craft specified in reference (a). Reference (b) provides policy and guidance for maintenance of service craft and boats not addressed in reference (c).
- b. The Foreword of this manual contains a master list of references. These references are arranged in alphanumeric order to facilitate the ordering of documents. References used in specific chapters are listed at the beginning of that chapter. Appendices A and B of this chapter contain a list of acronyms and glossary of terms used in this specific volume.
- c. Equipment under the cognizance of Naval Sea Systems Command Nuclear Propulsion Directorate (NAVSEA 08) is maintained in accordance with NAVSEA 08 directives.
- d. Nuclear-Powered Ballistic Missile Submarine (SSBN) Strategic Weapon System (SWS) and Nuclear-Powered Guided Missile Submarine (SSGN) Attack Weapons Systems (AWS) equipment under the cognizance of Strategic Systems Programs (SSP) is operated, maintained, modified and/or modernized in accordance with approved SSP directives/instructions.

- (1) Reference (i) defines policies, controls, processes and procedures for the accomplishment of all SSP Alterations (SPALT) issued by the Director, Strategic Systems Programs for all SSP cognizant equipment on both SSBNs and SSGNs. Reference (i) further defines the methodology and processes to plan, document, coordinate, install, and test SWS/AWS hardware, software and/or modernization SPALTs.
- (2) Adherence to reference (i) ensures that all related or affected Equipment, Fleet Documentation, Training, Logistic and Maintenance functions under the cognizance of SSP are fully integrated as part of the SPALT. Only SSP authorized SWS/AWS SPALTs are installed on SSBNs and SSGNs.
- (3) Applicable and required local support services such as Crane, Riggers, Power Isolation/Tag-Out, Hazardous Material, Quality Assurance/Critical Skill requirements, etc., for the conduct of a SPALT shall be identified within the Director, Strategic Systems Programs SPALT document, related Ordnance Document, and/or SPALT installation pre-briefings (as appropriate). This information shall be communicated/provided to all involved and affected local activities in accordance with the SPALT process no later than forty-five (45) days prior to the conduct of a SPALT, as outlined and defined within reference (i).
- (4) An SSP Contractor/Government Team shall provide the required operational and engineering support for all SPALT, Maintenance and Repair Activities to SWS/AWS equipment under the cognizance of SSP. The respective responsibilities of SSP Contractor/Government Teams, the Fleet Maintenance Activity and other local Commands for the execution of the SSP SPALT program shall be documented in an overarching Memorandum of Agreement in order to define areas of responsibility for all activities involved in the accomplishment of authorized alterations in a timely, efficient, and coordinated manner.

1.3 CHANGES AND CORRECTIONS. Changes and corrections will be issued as required. Comments and suggestions for improving or changing this volume are invited. Address comments, recommendations, and requested changes to Submarine Maintenance Engineering, Planning and Procurement (SUBMEPP) Activity utilizing the change request form located in the front of this manual. If changes are submitted in electronic format, facsimile or E-mail, each change request shall contain the information required on the change request form.

1.4 REQUEST FOR COPIES OF THE MANUAL. Activities on distribution for the Joint Fleet Maintenance Manual (JFMM) that require additional copies or activities wanting to be added to distribution should submit a letter to their applicable Type Commander (TYCOM), identifying CD-ROM/paper requirements along with justification for the request. To the maximum extent possible, technical publications libraries at each activity will receive all copies of the manual for that activity and coordinate local distribution and updates.

APPENDIX A
LIST OF ACRONYMS

2-Kilo (2K)	3-M Maintenance Action Form
3-M	Maintenance and Material Management
A&I	Alteration and Improvement
ACRN	Accounting Classification Reference Number
AERP	Advanced Equipment Repair Program
AIM	Advanced Industrial Management
AIM4RMC	Advanced Industrial Management for Regional Maintenance Centers
AIMXP	Advanced Industrial Management Express
AIPS	Alteration Installation Planning System
AIT	Alteration Installation Team
AMCA	Automated Machinery Condition Analysis
AMPS	Afloat Master Planning System
ARRS	Analysis, Record and Report Section
ASF	Assist Ship's Force
AWP	Availability Work Package
AWPM	Availability Work Package Manager
AWR	Automated Work Request
AWS	Attack Weapons Systems
BAWP	Baseline Availability Work Package
BCP	Ballast Control Panel
BQC	Emergency Underwater Telephone
C5RA	Command, Control, Communications, Computers and Combat Systems Readiness Assessment
CAR	Corrective Action Request
CARPER	Aircraft Carrier Planned Equipment Replacement
CASREP	Casualty Report
CBM	Condition Based Maintenance
CDMD-OA	Configuration Data Managers Database-Open Architecture
CDNS	Cancellation Deferral Notification System
CFR	Contractor Furnished Report
CHENG	Chief Engineer
CJ	Critical Job
CM	Continuous Maintenance
CMAV	Continuous Maintenance Availability
CMP	Class Maintenance Plan
CNO	Chief of Naval Operations
CNRMC	Commander, Navy Regional Maintenance Center
CNSL	Commander, Naval Surface Atlantic
CNSP	Commander, Naval Surface Pacific
CO	Commanding Officer
COMNAVSEASYSKOM	Commander Naval Sea Systems Command
COMSUBDEVRON	Commander Submarine Development Squadron
COMSUBLANT	Commander Submarine Force, United States Atlantic Fleet
COMSUBPAC	Commander Submarine Force, United States Pacific Fleet
COMSUBRON	Commander, Submarine Squadron
COSAL	Coordinated Shipboard Allowance List
CPA	Carrier Planning Activity
CPJ	Critical Path Job
CS/CCS	Command and Control Systems

CSMP	Current Ship's Maintenance Project
CVN	Nuclear Powered Aircraft Carrier
CWP	Controlled Work Package
DFS	Departure From Specification
DISSUB	Disabled Submarine
DSRA	Docking Selected Restricted Availability
DSS	Deep Submergence System
DTG	Date Time Group
EA	Executing Activity
EAB	Emergency Air Breathing
ECM	Electronic Counter Measure
EDL/ESL	Equipment Deficiency/Status Log
EDSRA	Extended Docking Selected Restricted Availability
EM	Emergent Availability
EMBT	Emergency Main Ballast Tank
EOC	Engineered Operating Cycle
EOG	Electrolytic Oxygen Generator
ESM	Electronic Warfare Support Measures
ESR	Engineering Service Request
FAC	Funding Activity Code
FBW SCS	Fly-By-Wire Ship Control Systems
FDNF	Forward Deployed Naval Forces
FFP	Firm Fixed Price
FMA	Fleet Maintenance Activity
FMPMIS	Fleet Modernization Program Management Information System
FRP	Fleet Readiness Plan
FWP	Formal Work Package
FY	Fiscal Year
HM&E	Hull, Mechanical and Electrical
IDD	Interim Drydocking
IDIQ	Indefinite Delivery, Indefinite Quantity
IEM	Inactive Equipment Maintenance
IFF	Identification Friend or Foe
ILO	Integrated Logistics Overhaul
ILS	Integrated Logistics Support
IMA	Intermediate Maintenance Activity
IMPAC	Integrated Modernization Planning for Aircraft Carriers
INSURV	Board of Inspection and Survey
IPC	Integrated Planning Conference
IPTD	Integrated Project Team Development
ISE	Individual Ships Exercises
ISEA	In-Service Engineering Activity
ISIC	Immediate Superior In Command (Group or Squadron)
IT	Information Technology
IWS	Integrated Work Schedule
JCN	Job Control Number
JFMM	Joint Fleet Maintenance Manual
LAR	Liaison Action Request

LCPC	Life Cycle Planning Conference
LDS	Logistics Data System
LLTM	Long Lead Time Material
LMA	Lead Maintenance Activity
LOA	Light-Off Assessment
MA	Maintenance Activity
MACHALT	Machinery Alteration
MARMC	Mid-Atlantic Regional Maintenance Center
MBT	Main Ballast Tank
MCA (Submarines)	Material Condition Assessment
MCA (Surface Ships)	Machinery Condition Analysis
MCAI	Material Condition Assessment Inspection
MCAP	Material Condition Assessment Process
MDCO	Maintenance Document Control Office
MDS	Maintenance Data System
MIP	Maintenance Index Page
MJC	Master Job Catalog
MLOC	Master Light-Off Checklist
MM	Maintenance Manager
MMBP	Maintenance and Modernization Business Plan
MOA	Memorandum/Memoranda of Agreement
MRC	Maintenance Requirement Card
MSC	Master Specification Catalog
MSCMO	Master Specification Catalog Maintenance Office
MSR	Master Ship Repair Contractor
MST	Maintenance Support Team
MT	Maintenance Team
MTT	Mobile Training Team
MWO	Maintenance Work Order
NAVAIR	Naval Air Systems Command
NAVIMFAC	Naval Intermediate Maintenance Facility
NAVSEA	Naval Sea Systems Command
NAVSEA 08	Naval Sea Systems Command Nuclear Propulsion Directorate
NDE	Navy Data Environment
NDE-SIDE	NDE-SPAWAR Integrated Data Environment
NEC	Navy Enlisted Classification
NMD	Navy Maintenance Database
NMP	Navy Modernization Program
NNSY	Norfolk Naval Shipyard
NPEB	Nuclear Propulsion Examining Board
NRL	Naval Research Laboratory
NRMC	Navy Regional Maintenance Center
NRMD	Nuclear Regional Maintenance Department
NRRO	Naval Reactor Representative Office
NSA	Naval Supervisory Authority
NSSFNL	Naval Submarine Support Facility New London
NSWC	Naval Surface Warfare Center
NSWCCD	Naval Surface Warfare Center, Carderock Division
NSY	Naval Shipyard
NWRMC	Northwest Regional Maintenance Center
OIC	Officer In Charge
OMMS-NG	Organizational Maintenance Management System - Next Generation

OPNAV	Naval Operations
OPORD	Operational Order
OPTAR	Operating Target
OQE	Objective Quality Evidence
ORDALT	Ordinance Alteration
PAC	Pre-Arrival Conference
PARM	Participating Acquisition Resource Managers
PB4M	Planning Board for Maintenance
PCD	Production Completion Date
PCO	Primary Contracting Officer
PE	Port Engineer
PEO	Program Executive Officer
PHNS	Pearl Harbor Naval Shipyard
PIRA	Pre-Inactivation Restricted Availability
PLAD	Plain Language Address Directory
PMA	Phased Maintenance Availability
PMR	Periodic Maintenance Requirement
PMS	Planned Maintenance System
PMT	Performance Monitoring Team
POET	Point of Entry Testing
PORSE	Post Overhaul Reactor Safeguards Examination
PPEA	Propulsion Plant Engineering Activity
PR	Planning Review
PRC	Project Review Conference
PSIA	Private Sector Industrial Activity
PTD	Provisioning Technical Documentation
PVI	Product Verification Inspection
QA	Quality Assurance
QAS	Quality Assurance Supervisor
QMP	Quality Management Plan
QMS	Quality Management System
RCC	Request for Contract Change
RCD	Required Completion Date
REC	Re-Entry Control
RLAR	Reverse Liaison Action Request
RMAIS	Regional Maintenance Automated Information System
RMC	Regional Maintenance Center
RMO	Reactor Maintenance Officer
RMT	Regional Maintenance Team
ROV	Repair of Other Vessels
RPCCR	Reactor Plant Configuration Change Report
RPM	Revolutions Per Minute
RRC	Regional Repair Center
RSE	Reactor Safeguards Examination
RSG	Regional Support Group
SBAT	SUPSHIP Bath
SC	Ship Change
SCA	System Certification Authority
SDI	Ship's Drawing Index
SDM	Ship Design Manager

SEIE	Submarine Escape Immersion Ensemble
SERMC	Southeast Regional Maintenance Center
SF	Ship's Force
SFCC	Submarine Flight Critical Component
SHIPALT	Ship Alteration
SID	Ship Installation Drawing
SITREP	Situation Report
SJM	Selected Job Management
SNAP	Ship's Non-Tactical Automated Data Processing System
SNPMTT	Surface Nuclear Propulsion Mobile Training Team
SOE	Submerged Operating Envelope
SOSMIL	Safety of Ship Maintenance Item List
SPALT	Strategic Systems Programs Alteration
SPAWAR	Space and Naval Warfare Systems Command
SPM	Secondary Propulsion Motor
SPM	Ship Program Manager
SRA	Selected Restricted Availability
SRDRS	Submarine Rescue Diving Recompression System
SRF-JRMC	Ship Repair Facility - Japan Regional Maintenance Center
SSBN	Nuclear-Powered Ballistic Missile Submarine
SSCA	SUBSAFE Certification Audit
SSEOC	Surface Ship Engineered Operating Cycle
SSES	Ship System Engineering Station
SSGC	SUPSHIP Gulf Coast
SSGN	Nuclear-Powered Guided Missile Submarine
SSP	Ship Specification Package
SSP	Strategic Systems Programs
SSPINST	Strategic Systems Programs Instruction
SSR	Ship Selected Records
SSRAC	NAVSEA Standard Specification for Ship Repair and Alteration Committee
SUBLANT	Submarine Atlantic
SUBMEPP	Submarine Maintenance Engineering, Planning and Procurement Activity
SUBPAC	Submarine Pacific
SUBSAFE	Submarine Safety
SUPSHIP	Supervisor of Shipbuilding
SUPSHIP NN	Supervisor of Shipbuilding Newport News
SURFMEPP	Surface Maintenance Engineering Planning Program
SWLIN	Ships Work List Item Number
SWRMC	Southwest Regional Maintenance Center
SWS	Strategic Weapon System
SYSCOM	Systems Command
T/A	Type Availability
TAAS-INFO	Tech Assist, Assessments and Scheduling Information Software
TAMS	TYCOM Alteration Management System
TAR	Technical Analysis Report
TDA	Type Desk Assistant
TDO	Type Desk Officer
TEMPALT	Temporary Alteration
TEMPEST	National Policy on the Control of Compromising Emanations
TEMPMOD	Temporary Modification
TRFKB	TRIDENT Refit Facility Kings Bay
TRIPER	TRIDENT Planned Equipment Replacement
TSO	Temporary Standing Order
TSRA	Total Ship Readiness Assessment
TWD	Technical Work Document

TYCOM	Type Commander
UIC	Unit Identification Code
UNF	Unfunded
UNSEARESCOM	Undersea Rescue Command
UQC	Underwater Telephone
URO	Unrestricted Operation
WAF	Work Authorization Form
WDC	Work Definition Conference
WOO	Window of Opportunity
WPER	Work Package Execution Review
WQC	Underwater Telephone
WSS	Work Sequence Schedule
XAZ	Scheduled Continuous Maintenance Availability
XCM	Unscheduled Continuous Maintenance Availability
XCZ	CNO Scheduled Availability
XEM	Year-long Emergent Work Availability
YLCM	Year Long Continuous Maintenance

APPENDIX B
GLOSSARY OF TERMS

<u>TERM</u>	<u>DEFINITION</u>
Charging to a Unit Identification Code (UIC)	The action describing a person, who is normally categorized as direct support labor, charging his time to a ship's UIC and while not working on a specific work item/Maintenance and Material Management Maintenance Action Form (2K). When recording charges in this manner, he will charge to a Maintenance Work Order (MWO) that was created for that specific purpose. The nature of that MWO will be directly related to production but not to one specific job or 2K.
Deep Dive	The first dive to maximum operating depth. This depth will not necessarily coincide with the design test depth of the hull. See definition of Maximum Operating Depth.
Direct Labor Category	Assigned to those production personnel who charge their time to a MWO that originated from a specific 2K.
Direct Support Labor Category	Assigned to those personnel who are first line supervisors of direct personnel or who directly support production and charge to a UIC use Direct Support Labor. Also includes administrative personnel assigned to production; however, they will normally charge to overhead. Some examples of personnel likely to charge as Direct Support Labor: Port Engineer, Ship Supervisors, Production Quality Assurance, Engineers, Technical Assist Personnel, Planners.
Dock Trials	Dock Trials are those ship trials conducted at the industrial activity to determine the ability of the ship, from a material standpoint, to conduct Sea Trials safely.
Fast Cruise	A period immediately prior to underway trials during which Ship's Force operates the ship for dockside training. Fast Cruise shall, as far as is practical, simulate at-sea operating conditions.
Fleet Maintenance Activity (FMA)	FMAs include tenders, shore based maintenance activities (Regional Maintenance Centers, Naval Ship Repair Facilities, Naval Submarine Support Facilities, Naval Intermediate Maintenance Facilities (NAVIMFAC), TRIDENT Refit Facilities, Weapons Repair Facilities and other activities of that type) and supporting activities (port services, etc. that perform maintenance on Fleet assets).
Indirect Labor Category	Assigned to those personnel who charge their time to a cost center as overhead and do not charge to a UIC or MWO. Some examples of personnel that are considered Indirect: Master At Arms, Training, Career Councilor.
Industrial Activity	The activity responsible for accomplishing construction or repair of ships whether private or public. This includes Naval shipyards, private shipyards, shipbuilders, vendors, Naval Aviation Depots, Naval Ship Repair Facilities and other Naval Repair/Technical Activities (Naval Underwater Weapons Center, Naval Ships Weapons Center, etc.).
Initial Dive	For purposes of seawater valve and system testing, as defined in reference (e), the first dive to a depth not previously reached during the trials.

Lead Maintenance Activity	The single activity responsible for integrating all maintenance and modernization on U.S. Naval ships during any type of availability.
Long Lead Time Material	Material which is not normally available in local stock and may not be received prior to the start of the availability if not ordered prior to the Work Definition Conference (WDC).
Maintenance Manager	Those persons, such as Port Engineers, Ship Superintendents, Ship's Coordinator and Maintenance Planning Managers, assigned to assist Ship's Force in the tracking of work candidates, development of work packages and tracking of FMA/Industrial Activities assigned jobs.
Maintenance Support Team (MST)	Military team that performs the function of Ship's Force, and reports to the supported ship's Immediate Superior In Command (ISIC) and the Operational Commander.
Maintenance Work Order (MWO)	The Automated Information System object that personnel use in order to charge time to a work item/2K.
Major Chief of Naval Operations (CNO) Maintenance Availability	An availability of six months or greater duration performed by industrial activities under NAVSEA management or contract administration or as designated by the TYCOM or NAVSEA.
Master Specification Catalog (MSC)	Database of templates for all Naval Ship Classes. It is a module located within NMD.
Maximum Operating Depth (Also Maximum Authorized Operating Depth)	The depth to the keel for a particular submarine which is authorized by Commander Submarine Force, United States Atlantic Fleet/Commander Submarine Force, United States Pacific Fleet (COMSUBLANT/COMSUBPAC) upon the recommendation of NAVSEA, as the depth not to be exceeded in operations. This depth is normally the Test Depth but may be reduced in specific cases. The depth authorized by COMSUBLANT/COMSUBPAC may be less than, but in no case exceed, the depth recommended by NAVSEA.
Minor CNO Maintenance Availability	An availability of less than six months in duration scheduled by and under Type Commander management.
Moderate Speed	The range of speed that allows the submarine optimum recovery (as shown on applicable submerged operating envelope curves) if loss of stern plane control and/or flooding occurs. Normally 8-15 knots.
Naval Supervisory Authority/Supervisory Authority	The officer designated to represent the Navy Department at an industrial activity; normally a Supervisor of Shipbuilding (new construction), Regional Maintenance Center (Conversion and Repair) or the Commander of a Naval Shipyard.
Navy Maintenance Database (NMD)	Worldwide database used for all repairs across Naval Ship Classes. Used to develop work items for repair or modernization.
Refurbishment Level Maintenance	The actions taken to return a component to "A" condition (like-new condition). Normally done under rotatable pool (Advanced Equipment Repair Program, TRIDENT Planned Equipment Replacement, etc.) programs by Designated Overhaul Points. Designated Overhaul Points must be certified to have the industrial capability to meet the program requirements for performing quality work and have the capacity to meet established Refurbishment Turnaround Times.

Regional Maintenance Team	A site specific, multi-disciplined group of people normally accomplishing “outside shop” or on-platform work. An RMT may be platform or technology specific (e.g., submarines or nuclear) to facilitate necessary worker training and competency. An RMT is generally comprised of both military and civilian workers.
Regional Repair Center	An “inside shop” focusing on a particular product line (e.g., motors) or technology (e.g., machinery). An RRC is generally comprised of both military and civilian workers.
Restoration Level Maintenance	The minimum planned inspection, maintenance and testing criteria to be applied to ensure a component will function satisfactorily until the next planned accomplishment of the maintenance requirement.
Ship’s Force	Members assigned as a ship’s permanent or rotational crew.
Technical Data	Recorded information (regardless of the form or method of recording) of a scientific or technical nature (including computer databases and computer software documentation). This term does not include computer software or financial, administrative, cost or pricing, or management data or other information incidental to contract administration. The term includes recorded information of a scientific or technical nature that is included in computer databases. For these purposes, technical data includes the characteristic of a particular science, trade or profession.
Test Depth (TD)	For the purpose of the proper method of measuring and specifying Test Depth, the following applies: Test Depth shall be measured to the bottom of the keel for all types of submarine operations. Builders trials and trials following major industrial activity availabilities greater than six months, shall be at a tolerance of plus zero (0), minus twenty (20) feet of Test Depth when specified. All other trials can be conducted at 95% to 100% of Test Depth to satisfy all the requirements specified for 100% Test Depth.
Waterline	The term “waterline” in this manual refers to where the hull of a ship meets the surface of water when afloat.
Work	<ul style="list-style-type: none"> a. Any action that actually or potentially changes (including disassembly for the purposes of inspection or repair) the approved configuration of any part, component or ship’s system. b. Any action that removes or affects the ship’s ability to operate ship’s systems or components in accordance with ship’s systems/operating manuals or reactor plant manuals. c. Any testing or inspections required to establish, maintain or reestablish certification. d. Any design, engineering, planning or configuration management functions that involve the final review and/or approval of technical information. <p>Examples of work include the following:</p> <ul style="list-style-type: none"> 1. Action which disassembles or removes any part, component or ship’s system. 2. Action specified in a Technical Work Document.

Work (Cont'd)

3. Any action that removes or affects the ship's ability to operate ship's systems or components in accordance with ship's systems manuals, operating manuals or reactor plant manuals, excluding tagout in accordance with the Tagout Users Manual, including but not limited to:
 - (a) Component or system tests.
 - (b) Intrusive inspections (such as breaking the plane of electrical panels requiring electrical safety).
 - (c) Valve line ups that alter the normal system line up not governed by operating procedures.
 - (d) Removing valve hand wheels, disconnecting of reach rods.

VOLUME II

PART I

CHAPTER 2

MAINTENANCE AND MODERNIZATION PROGRAM

REFERENCES.

- (a) NAVSEAINST 5400.95 - Waterfront Engineering and Technical Authority Policy
- (b) NAVSEA SL720-AA-MAN-030 - Navy Modernization Process Management and Operations Manual (NMP-MOM)
- (c) OPNAVINST 4700.7 - Maintenance Policy for U.S. Naval Ships
- (d) NAVSEA S9002-AK-CCM-010/6010 - Industrial Ship Safety Manual for Submarines
- (e) SSPINST 4720.1 - Policies and Procedures for Alteration of Strategic Weapon System Equipment
- (f) NAVSEA 4350.2 - Contract Work Onboard Nuclear-Powered Ships
- (g) NAVSEA S9AA0-AB-GOS-010 - General Specifications for Overhaul of Surface Ships
- (h) NAVSEA T0300-AA-MMI-010 - Commercial Industrial Services (CIS) Manual
- (i) NAVSEAINST 4710.6 - Submarine Advanced Equipment Repair Program (AERP); Assignment of Responsibilities for and Administration of
- (j) SSN21-081-PMS350L-035 - Rotatable Pool Management Plan for the SEAWOLF Class SSN
- (k) NAVSEAINST C9210.4 - Changes, Repairs and Maintenance to Nuclear Powered Ships
- (l) NAVSEAINST 4720.23 - Deep Submergence Systems Temporary Modifications
- (m) NAVSEAINST 4130.9 - Configuration Control Procedures for Preparation of Ordnance Alterations (ORDALTS) to Expendable and Non-Expendable Items
- (n) NAVSEAINST 4720.15 - Machinery Alterations on HM&E Equipment and Systems
- (o) MIL-STD-2039 - Field Changes and Field Change Kit Preparation
- (p) COMLANFTLTINST 4700.10 - Policies and Procedures for Fleet Technical Support (FTS) (Cancelled)
- (q) COMPACFLTINST 4341.1 - Fleet Technical Assistance (FTA) Program (Cancelled)
- (r) NAVSEA 0989-LP-043-0000 - Commissioned Surface Ship General Reactor Plant Overhaul and Repair Specification
- (s) NAVSEAINST 4730.2 - Shipyard Inspection and Required Conditions of Propulsion Plant Systems (Non-Nuclear) for Nuclear-Powered Surface Ships
- (t) NAVSEA STD DWG 605-5529700 - CVN 68 Class Commissioned Ships Reactor Plant Paint Schedule
- (u) NAVSEA S9086-VD-STM-010-NSTM Chapter 631 - Preservation of Ships in Service - General
- (v) TMIN SL700-AB-GYD-010 - Pictorial Guide for Painting Ships Interiors
- (w) NAVSEA STD DWG 213-4362626 - Lagging and Insulation Schedule for Reactor Plant Systems
- (x) CNAP/CNALINST 9210.4 - Nuclear Propulsion Note 9200-2
- (y) NAVSEAINST 9304.1 - Shipboard Electric Cable and Cableway Inspection and Reporting Procedures
- (z) DOD-STD-2003 - Military, Standard, Electric Plant Installation Standard Methods for Surface Ships and Submarines
- (aa) NAVSEA 0989-LP-062-4000 - Naval Nuclear Quality Control Manual for Shipyards
- (ab) NAVSEA 0989-031-4000 - Reactor Plant Instrumentation and Control Equipment Maintenance
- (ac) NAVSEA 0989-LP-026-1000 - A4W/A1G Reactor Plant Manual
- (ad) OPNAVINST 3120.32 - Standard Organization and Regulations of the U.S. Navy
- (ae) COMLANFTLTINST 5400.2 - U.S. Atlantic Fleet Regulations
- (af) COMPACFLTINST 5400.3 - U.S. Pacific Fleet Regulations
- (ag) OPNAVNOTE 4700 - Representative Intervals, Durations, Maintenance Cycles, and Repair Mandays for Depot Level Maintenance Availabilities of U.S. Navy Ships
- (ah) OPNAVINST 4780.6 - Policy for Administering Service Craft and Boats in the U.S. Navy
- (ai) MIL-STD-3034 - Reliability-Centered Maintenance (RCM) Process
- (aj) MIL-STD-1388 - Logistic Support Analysis
- (ak) OPNAVINST 3120.33 - Submarine Extended Operating Cycle (SEOC) Program
- (al) NAVSEA TL710-AB-MAN-010 - Depot Modernization Period (DMP) Procedures Manual
- (am) OPNAVNOTE 4710 - Fleet Depot Maintenance Schedule
- (an) SSPINST 5600.11 - Preventive Maintenance Management Program for Strategic Weapon Systems Equipment and Associated Material

LISTING OF APPENDICES.

- A Material Condition Assessment Process Timeline
- B CVN Propulsion Plant Material Condition Assessments
- C System Certification Checklist for CNO Availability Key Events (Aircraft Carriers Only)
- D Scope of Visual Inspections of Reactor Plant Fluid Systems
- E First 100 Hours for Surface Force Scheduled Availability
- F Final 100 Hours for Surface Force Scheduled Availability

2.1 PURPOSE. The purpose of this chapter is to provide Fleet Commanders' guidance for the maintenance of ships throughout their operating cycle in accordance with references (a) through (an). This includes maintenance levels, strategies, programs and modernization which define and support all maintenance accomplished in accordance with technical specifications and standards during a ship's operating cycle.

2.1.1 Naval Supervisory Authority.

- a. Naval Supervisory Authority Definition. The Naval Supervisory Authority (NSA) is the single Naval activity, as indicated in Table 2-1 of this chapter, responsible for the integration, oversight and verification of all work accomplished by all activities (i.e., Naval Shipyards (NSY), Regional Maintenance Centers (RMC), Supervisors of Shipbuilding (SUPSHIP) contractors, Type Commander (TYCOM) sponsored contractors, Intermediate Maintenance Activities (IMA), Alteration Installation Teams (AIT) and Ship's Force) working within the assigned availability, and acts as the single point of contact for this work. The NSA will provide the oversight required to ensure that all work in the assigned availability (e.g., Chief of Naval Operations (CNO) availabilities, Continuous Maintenance Availability, Emergent Availability) is authorized and completed in compliance with applicable technical requirements and maintenance/modernization policy, and that all work meets schedule, quality and environmental/safety requirements. The NSA must possess a Naval Sea Systems Command (NAVSEA) technical warrant.
- b. NSA Assignment. In most cases, the NSA is assigned by the Fleet Maintenance Officer and TYCOM in accordance with Table 2.1. An NSA must be assigned to all CNO availabilities and to all contracted work where the majority of the work is performed onboard the ship. However, for repair/maintenance/modernization work packages where TRIDENT Refit Facility Kings Bay (TRFKB), Naval Submarine Support Facility New London (NSSFNL) or the Tender is assigned as the Lead Maintenance Activity (LMA), no NSA Assignment is required (whether or not the work package includes contracted work). Local Technical Authority for the LMA is delegated by their assigned Chief Engineer in accordance with reference (a) as defined in a Memorandum of Agreement (MOA) between the responsible organizations. When such an MOA exists, the LMA (TRFKB, NSSFNL, Tenders) executes the specific NSA responsibilities of paragraphs 2.1.1.d.(1) through 2.1.1.d.(4) of this chapter when no NSA is assigned.
 - (1) Alterations installed by Alteration Installation Teams (AIT) per reference (b) can only be executed in availabilities that have a designated NSA, with the exception of availabilities where TRFKB, NSSFNL, or Tenders are the assigned LMA. If the AIT install is being performed outside a CNO availability, the AIT Sponsor may propose NSA responsibility be assigned to any organization that is qualified as an NSA for the type of work being performed.
 - (2) An NSA is not required if the work is being performed by a U.S. Navy LMA outside a CNO availability.
 - (3) The NSA will normally be the activity assigned based on the geographic area covered by the assigned RMC, NSY or SUPSHIP, as indicated in Volume VI, Chapter 2, Table 2-1 of this manual. If this is not practical, the NSA assignment will be made based on the area of responsibility of the cognizant Chief Engineer as delineated in reference (a).
 - (4) **The NSA designation does not apply to alterations to ships accomplished by AITs where the NSA may be responsible:**
 - (a) Alterations to nuclear components and systems under the cognizance of the Deputy Commander for Nuclear Propulsion (NAVSEA 08).

- (b) Strategic Systems Program Alterations (SPALT) issued by the Director, Strategic Systems Programs and alterations under the TRIDENT SYSTEM Change Management Program.
 - (c) Temporary modifications performed as part of a shipyard availability to support industrial work or associated testing.
 - (d) Temporary Alterations (TEMPALT) to be accomplished on Submarines.
 - (e) Technical support personnel and certification teams who only provide technical guidance, equipment check-out and grooming or certification of systems or on-site training for Ship's Force not associated with the accomplishment of an alteration/Ship Change.
 - (f) Boats, small craft, service craft, equipage and other exceptions including items that are not permanently installed and are portable.
- c. NSA Qualification. In order to be qualified to perform the functions of an NSA, the organization must have a Chief Engineer holding a NAVSEA Technical Warrant. For this reason, the only organizations qualified to perform the functions of NSA are the NSYs, the RMCs and the SUPSHIPS. Facilities such as the Tenders, NSSFNL, TRFKB and Ship's Force cannot be considered NSAs.

NOTE: DELEGATION OF NSA RESPONSIBILITIES CAN BE ACCOMPLISHED THROUGH A MOA THAT IDENTIFIES DUTIES, RESPONSIBILITIES AND OVERSIGHT FUNCTIONS. THE NSA IS RESPONSIBLE FOR ALL WORK ACCOMPLISHED BY ALL ACTIVITIES AND ACTS AS THE SINGLE POINT OF CONTACT.

- d. NSA Responsibilities. These responsibilities include but are not limited to:
- (1) Coordination with other Maintenance Activities (e.g., NSY, RMC, SUPSHIP, AIT, Ordnance Alteration (ORDALT)/TEMPALT Installation Teams) through an authorized MOA.
 - (2) Single point of contact for the LMA and shipboard personnel.
 - (3) Verify completion of work for milestones, key events, end of availability, availability departure report based on documentation provided by all maintenance activities.
 - (4) Based on the amount of work accomplished, the NSA may also assume the role of the LMA per paragraph 2.1.2 of this chapter.
 - (5) For CNO availabilities, the NSA shall:
 - (a) (For NSY only) Also serve as the LMA.
 - (b) Participate in all work definition, planning and completion conferences.
 - (c) Facilitate planning efforts. Ensure detailed planning and integration of the work package is accomplished to provide a schedule that incorporates the work and testing of all organizations involved in the availability. The schedule shall address work definition, key events, shipchecks, job summary, material preparations and strategy preparations. Identify milestones with sufficient detail to measure intermediate progress toward each key event. Ensure orientation briefings and training are conducted as necessary so that personnel understand applicable project processes and requirements. Identify their appropriate points of contact.
 - (d) Prior to Fast Cruise, Sea Trials and availability completion, verify all authorized work has been completed unless waived. For work performed by contractors, ensure all provisions of the contract have been fully executed.
 - (e) During work execution, review all changes to specifications and work items impacting propulsion plant or designated areas of nuclear powered ships to ensure requirements are met.

- (f) Participate in critiques and problem investigations (e.g., Trouble Reports) as necessary.
- (6) For alterations installed by AITs, the NSA, as designated in Table 2-1, as required by reference (b) shall:
 - (a) Monitor the effectiveness and the quality of AIT managers' execution of Quality Assurance oversight responsibilities by assessing their execution of Quality Assurance oversight responsibilities and by Quality Sampling. Request Qualification Records as needed in support of spot checks.
 - (b) Perform inspections of installations, on a sampling basis, and use the sampling evidence to indicate conformance or nonconformance with NAVSEA requirements.
 - (c) Conduct AIT In/Out briefs and coordinate with the AIT Manager and Ship's Force to ensure satisfactory completion of alterations.
 - (d) Receive copies of Integrated Logistics System products from the AIT and verify they were properly distributed.
 - (e) Ensure completion reports are issued and for any work not accomplished, assure a Current Ship's Maintenance Project (CSMP) Job Control Number is issued.

Table 2-1

Maintenance Availability	NSA	LMA
CNO Public (1)	NSY	NSY
CNO Private (1)	RMC/SUPSHIP (2)	Contractor
Non-CNO Public (3) (4)	RMC/NSY	RMC/NSY Fleet Maintenance Activity (FMA)
Non-CNO Private (3)	RMC/SUPSHIP (2)	Contractor
Emergent/Voyage repair (4)	RMC/SUPSHIP/NSY	FMA/RMC/NSY/Contractor
New Construction	SUPSHIP	Contractor
AIT availabilities	RMC/SUPSHIP/NSY	FMA/RMC/NSY/AIT Contractor
Other (4)	N/A	FMA/Ship's Force

NOTES:

1. Per reference (c).
2. Pearl Harbor NSY and Intermediate Maintenance Facility and Puget Sound NSY and Intermediate Maintenance Facility are also considered RMCs.
3. Examples of Non-CNO availabilities are located in Part I, Chapter 4 of this volume.
4. The Tenders, NSSFNL, TRFKB and Ship's Force are not NSAs. If the FMA is executing work, the FMA will be the LMA. The Fleet Maintenance Officer may designate a NSA if necessary.

NOTE: THE LMA IS RESPONSIBLE TO THE NSA WHEN AN NSA IS ASSIGNED OR THE IMMEDIATE SUPERIOR IN COMMAND (ISIC) IF NO NSA IS ASSIGNED.

2.1.2 Lead Maintenance Activity. The single activity responsible for work being accomplished on U.S. Naval ships during any type of availability. For work conducted during periods in which the NSYs or RMCs do not have oversight, an LMA will be designated. LMAs are responsible for:

- a. Conduct or attend routine progress review meetings with all assigned repair activities. Identify and resolve coordination problems and work conflicts. Advise the appropriate maintenance sponsors (e.g., NSA, NAVSEA, TYCOM, AIT Sponsor, Ship's Program Manager, etc.) of significant quality, cost and schedule impacts and problems.
- b. (CNO Availabilities only) Coordinate work and testing controls to include Work Authorization Forms, tagouts and test sequencing per Volume IV, Chapter 10, paragraphs 10.3 and 10.4 of this manual.
- c. Integrate the work of all repair activities. For CNO availabilities, this includes an integrated schedule. For non-CNO availabilities, an integrated schedule may be used, based on the complexity of the work as determined by the LMA. The schedule shall ensure adequate time is provided for crew training.
- d. Report work status to Maintenance Brokers.
- e. Request assistance via Maintenance Broker as needed for outside activity performance.
- f. (CNO Availabilities only) Coordinate preparations by assigned repair activities for all key events (e.g., docking, undocking, hot ops, dock trials, fast cruise, sea trials, etc.) to include verification signature checklists of readiness to start.
- g. Track progress of all maintenance activities.
- h. (Submarines only) Provide management oversight of a ship safety council per reference (d).
- i. (Submarines and CNO Availabilities only) Coordinate sail safety and sail closeout efforts among the assigned repair activities conducting work.
- j. (CNO Availabilities only) Coordinate crane operations, pier laydown areas, dry dock work areas and resolve other real estate conflicts which may impede efficient execution of the availability.
- k. (CNO Availabilities only) Provide sea trials agenda, with all repair activity input, for ship Commanding Officer's concurrence and Type Commander approval.
- l. Maintain a list of activities authorized to work on the ship the LMA is responsible for and ensure the list is updated weekly or on an as-needed basis. Ensure activities working on ship have the proper credentials, work schedule and pedigree (authorized maintenance activity) prior to being added on the work authorization list (e.g., Submarine Safety, Scope of Certification, Fly-By-Wire, Radiological).
- m. Ensure maintenance activities performing maintenance on assigned ships have proper MOA, Standard Work Practices, NAVSEA standard items and/or Strategic Systems Programs Alteration authorization per reference (e) in place and that the MOA, Standard Work Practices, NAVSEA standard items and/or Strategic Systems Programs Alteration authorization address required support for work authorizations and work control. For SUBSAFE, Deep Submergence Systems (DSS), Scope of Certification and Fly-By-Wire work, ensure that the MOA identifies the certifying activity.
- n. Direct maintenance providers to their proper points of contact.
- o. Attend all production/maintenance management meetings to communicate/resolve priorities, problems, job interferences and issues.
- p. Define, identify and provide resolution to coordination problems and work conflicts between the Maintenance Managers, Maintenance Activities, Maintenance Brokers and the ship.
- q. Provide a copy of all Departures From Specifications to Ship's Force Quality Assurance Officer and the Type Commander (TYCOM) N43 organization.
- r. Participate in critiques and problem investigations (e.g., Trouble Reports) as necessary.
- s. Conduct Ship's Force and contractor orientation briefings and training per references (b) or (f), as applicable prior to commencement of shipboard work.
- t. (CNO Availabilities only) Appoint a Ship Safety Officer to chair the Ship Safety Council and coordinate work and testing that affects ship's conditions (i.e., buoyancy, list, trim, stability and watertight integrity) and prevention and protection from fire and flooding.

- u. (Carrier Incremental Availabilities only) A Ship Safety Council is not required, but a Ship Safety Officer will be appointed and on site to oversee any high risk evolutions in accordance with Section 046 of reference (g).

2.1.3 Ship's Responsibility. The ship is responsible to:

- a. Monitor all maintenance activities to ensure they are on the master authorization list.
- b. Ensure a current master authorization list is maintained by the Ship's Duty Officer.
- c. Provide the LMA with information on ship brokered work so all activities are placed on the master authorization list.

2.2 MAINTENANCE ACCOMPLISHMENT LEVELS.

2.2.1 Fleet Maintenance. Fleet maintenance encompasses Organizational and Intermediate level maintenance as defined in reference (b). It includes, but is not limited to:

- a. Ship's Force maintenance that is planned and corrective maintenance which is within the capability and the responsibility of the ship's crew or Maintenance Support Team (if assigned). The work is a blend of equipment operation, condition monitoring, planned maintenance and repairs ranging from simple equipment lubrication to component changeout, and in some cases complete disassembly and repair in-place. The thrust of Ship's Force maintenance is to take advantage of operator experience and onboard rating skills and to ensure the ship is as maintenance self-sufficient as possible.
- b. FMA maintenance is that requiring specialized ratings, skill training in special maintenance processes and technical proficiency or equipment/instrumentation not available to Ship's Force. FMA maintenance normally consists of calibration, repair, refurbishment or replacement of damaged or unserviceable parts, components or assemblies, the emergency manufacture of unavailable parts within the FMA capability, and providing technical assistance.
 - (1) FMAs will accomplish refurbishment level maintenance beyond Ship's Force capability to the maximum extent possible within the policies of this chapter and other directives consistent with the availability of funds, material and skilled manpower.
 - (2) TRIDENT Refit Facilities are additionally tasked and resourced to accomplish industrial restoration level maintenance to SSBN/SSGN 726 Class submarine components as part of the integrated overhaul maintenance strategy for these ships.
 - (3) FMAs include Regional Repair Centers and Regional Maintenance Teams which are capable of conducting in-depth maintenance on their assigned components using the latest available technology.
- c. Strike Force Intermediate Maintenance Activity is composed of the collective StrikeForce elements capable of performing maintenance beyond the organizational level. A Strike Force Intermediate Maintenance Activity maximizes the Strike Force's ability to operate and sustain itself at sea during extended periods in forward areas through improved repair capabilities and material self-sufficiency.
- d. The Commercial Industrial Services program accomplishes Fleet maintenance for essential Fleet repairs that the FMAs have the capability to accomplish but not the shop capacity. The Commercial Industrial Services concept provides a means of using commercial industrial activities to provide maintenance services on a rapid response basis while observing approved commercial contracting procedures. Reference (h) fully describes policies and procedures for Commercial Industrial Services.

2.2.2 Industrial Maintenance. Industrial maintenance is that restoration level maintenance which encompasses Depot level maintenance as defined in reference (c). It includes but is not limited to:

- a. Industrial maintenance that is restoration level work requiring complex industrial processes, journeyman level technician skills, facilities, capabilities or manpower capacity not available at FMAs or to Ship's Force. This capability is provided within the Navy by naval industrial activities, ship repair facilities, Naval Aviation Depots, and commercial industrial activities and repair facilities under contract.

- b. Ship maintenance work scheduled for accomplishment by industrial facilities that in the judgment of the TYCOM, Commander NAVSEA or Commander Space and Naval Warfare Systems Command in their specific areas of responsibility, is not feasible to be accomplished by FMAs or Ship's Force, due to:
 - (1) Having insufficient time or manpower.
 - (2) Being beyond the capabilities of the FMAs.
 - (3) Being of such a nature that split responsibility between Fleet and industrial maintenance activities may occur.

2.3 RELIABILITY CENTERED MAINTENANCE.

- a. Reliability Centered Maintenance is a systematic analysis approach where the system design is evaluated for possible failures, the consequences of these failures, and the recommended maintenance procedures that should be implemented. The objective is to design a planned maintenance program to address possible failure consequences. The emphasis here is on the establishment of planned maintenance requirements (versus corrective maintenance requirements).
- b. Maintenance plans for in-service ships, systems and equipment should be reviewed and modified to incorporate Reliability Centered Maintenance principles in areas where it can be determined that the expected results will be commensurate with associated costs.

2.4 CONDITION BASED MAINTENANCE. Condition Based Maintenance (CBM) is maintenance based on objective evidence of actual or predictable failure of ship's installed systems or components. This includes condition-directed maintenance and periodicity adjustments to time-directed planned maintenance.

- a. A thorough knowledge and assessment of actual equipment condition in relation to its designed condition is the basis for most maintenance decisions. Equipment condition is a broad term which includes static parameters, such as size and shape, and dynamic parameters, such as speed, temperature, pressure, voltage, etc. While each Ship's Force is in the best position to know the condition of its ship and equipment, the complexities of modern design and engineering dictate that specialized assistance be utilized to determine the condition of much of the equipment. Diagnostics, inspections, non-intrusive monitoring for trending/analyses and tests shall be utilized to the maximum extent possible to determine performance and material condition of, and to predict and schedule required corrective maintenance action on, ships systems and equipment.
- b. Further information on CBM is provided by reference (c).
- c. Programs and organizations that are available to assess equipment conditions are described in paragraphs 2.4.1 through 2.4.8 of this chapter. Deficiencies identified by these and other programs and organizations shall be documented in the CSMP.

2.4.1 Unrestricted Operations (Submarines Only). The Unrestricted Operation (URO) program is designed to ensure continued safe submerged operations to design test depth. URO requirements shall be accomplished as scheduled and as described in Volume VI, Chapter 25, and Volume V, Part I, Chapter 5 of this manual.

2.4.2 Periodic Maintenance Requirements Program (Submarines Only). The Periodic Maintenance Requirement program has been established to integrate test, inspection, and maintenance directives from various Systems Commands and to control their input into each ship's CSMP for the required accomplishment by means of the Master Job Catalog. The phrase, "Periodic Maintenance Requirement" encompasses the URO program and the Submarine Engineering Management, Monitoring and Fleet Support Program Office Performance Monitoring Program. All requirements due for accomplishment shall be included in the CSMP at least six months prior to the due date to allow sufficient time for material procurement and maintenance planning. Specific requirements of the Periodic Maintenance Requirement program are described in Volume VI, Chapter 24, of this manual.

2.4.3 Material Condition Assessment Feedback Program (Submarines Only).

- a. The submarine Material Condition Assessment (MCA) program is coordinated by NAVSEA and Submarine Maintenance Engineering, Planning and Procurement (SUBMEPP) Activity and is used to improve the maintenance efficiency of critical, non-nuclear Hull, Mechanical and Electrical (HM&E) components by optimizing component refurbishment periodicities. This assessment of a component's condition at refurbishment, along with other pertinent component data such as performance monitoring

and corrective maintenance data, provides the foundation for extension or reduction of component refurbishment periodicity. Further, it allows for consideration of modification of component design configuration and/or the revision or elimination of component maintenance requirements with confidence that component reliability will not be diminished.

- b. The MCA data collection program consists of MCA data sheets and pre-availability test and inspection information. Other feedback programs and sources of material condition data include, but are not limited to, UROs, Maintenance and Material Management (3-M) System, Casualty Reports, Advanced Equipment Repair Program (AERP), Performance Monitoring Program, etc.
- c. The Integrated Maintenance Analysis Profile database displays planned and corrective maintenance feedback, historical configuration, job completion and alteration installation data in support of the MCA program.

2.4.4 Machinery Condition Analysis (Surface Force Ships and Aircraft Carriers).

2.4.4.1 General. The TYCOM Machinery Condition Analysis (MCA) and Ship's Force Machinery Vibration Analysis programs provide an objective assessment of the mechanical condition of propulsion plant and auxiliary rotating machinery. MCA surveys and Ship's Force Machinery Vibration Analysis and testing directly support the CBM strategy by determining specific maintenance requirements and priorities.

2.4.4.2 Automated Machinery Condition Analysis. The advent of real-time machinery digital sensors, analysis tools, data recording and data transfer has brought Automated Machinery Condition Analysis (AMCA) to the forefront of CBM. AMCA systems are being employed and installed on new ships-of-the-line and back-fitted where practicable on existing ships. The AMCA tools and systems support the MCA programs and MCA surveys. The systems are implementing prognostic, diagnostic and maintenance capabilities for both shipboard and off-ship personnel to utilize to enhance understanding of the mechanical condition of propulsion plant and auxiliary rotating machinery.

2.4.4.3 Machinery Condition Analysis Surveys. MCA surveys combine vibration analysis, visual inspections and a review of operating and maintenance records to objectively determine each machine's condition.

- a. Surveys are conducted before and after each scheduled CNO maintenance availability period. The survey preceding the availability provides a comprehensive list of machines which require repair. The MCA survey after the availability allows time for corrective maintenance actions prior to the ship's deployment and, if applicable, repairs while machinery is still under the availability warranty period. The post-availability survey also establishes a baseline to which future surveys can be compared.
- b. The key to the MCA program is onboard analysis of vibration data. MCA surveys identify machinery problems. A written report details prioritized repair recommendations with appropriate diagnostic and visual inspection data for all machines tested. The report also summarizes machinery repair history.
- c. Reports of failure trends and recurring or continuing mechanical problems are available along with MCA history reports. These reports can be generated based on machine type, ship, ship class, and Fleet.

2.4.4.4 Ship's Force Machinery Vibration Analysis Program. The Ship's Force Machinery Vibration Analysis program uses a fully capable automated diagnostics system to provide many ships with the ability to perform vibration testing. A set of computer programs in the diagnostics system provides the equivalent of a full time vibration engineer so that Ship's Force can test and analyze machinery at any time. Periodic training is provided to Ship's Force.

2.4.5 Ship Assessment, Groom and Evaluation. Ship Assessment, Groom and Evaluation is an existing TYCOM program which provides assessment of the material condition of selected shipboard systems and equipment. Ship Assessment, Groom and Evaluation includes identification of discrepancies to support development of a comprehensive conditioned based industrial availability work package. This program is fully described in Volume VI, Chapter 42 of this manual.

2.4.6 Performance Monitoring Team. The Performance Monitoring Team provides technical support to the Fleet by obtaining data using CBM methodology to monitor mission/safety critical systems and material conditions of selected HM&E systems. Performance Monitoring Team functions include, but are not limited to, the following:

- a. Collecting and analyzing equipment data.

- b. Establishing and maintaining a master database to track equipment performance.
- c. Providing feedback and technical guidance using trend analysis.
- d. Making equipment repair and deferral recommendations.

2.4.7 Command, Control, Communications, Computers and Combat Systems Readiness Assessment Program (Aircraft Carriers Only). The Command, Control, Communications, Computers and Combat Systems Readiness Assessment (C5RA) program is a TYCOM program which provides maintenance training and a comprehensive review and assessment of a ship's Combat Systems prior to deployment. It includes identification of discrepancies to support development of a comprehensive condition based availability work package for a ship's Combat Systems. For a complete description of the C5RA/Total Ship's Readiness Assessment (TSRA) program, refer to applicable TYCOM instructions.

2.4.8 Electronic Systems Review (SSBN/SSGN 726 Class Submarines Only). Fleet Training Support Center Detachments perform periodic Electronic Systems Reviews on SSBN/SSGN 726 Class submarines. The major emphasis of the Electronic Systems Review is on the job training of Ship's Force personnel in the performance of the Planned Maintenance System and maintenance of selected electronic equipment. Areas of review include monitoring for safety related issues, monitoring of the Planned Maintenance System and verifying equipment operability for the following systems: Radar, Electronic Warfare Support Measures, Periscopes, Fire Control, Central Atmosphere Monitoring System, Gyrocompass, Radio, Sonar, Launchers, Torpedo tubes and handling equipment. Additionally, the Electronic Systems Review team will assist division 3-M Coordinators in administrative reviews, perform National Policy on the Control of Compromising Emanations (TEMPEST) inspections or small arms inspections if requested.

2.5 SYSTEM/COMPONENT MAINTENANCE PROGRAMS (SUBMARINES AND AIRCRAFT CARRIERS ONLY).

2.5.1 Advanced Equipment Repair Program (Submarines Only).

- a. AERP is a system for providing new or refurbished non-nuclear components to support specific programmed industrial activity availability and Engineered Operating Cycle (EOC) maintenance requirements. A programmed requirement is one that is identified, budgeted and funded for ultimate end use on a specific submarine hull. Industrial activity availability and EOC requirements are defined as those assets necessary to support the accomplishment of a planned availability work package during scheduled CNO maintenance availabilities. Although similar in concept to the usual rotatable pool or repairable items, the AERP differs in that pool requirements are not determined by usage data. By its nature, the AERP is limited to items of significant value for which it would not be economical to stock on the basis of 'normal' usage. Instead, requirements are specific and are determined by the overall schedule of submarine industrial activity availability and EOC requirements. Only so much material is provided as will meet the programmed needs of the specific ships involved. Range and depth of AERP assets will normally not exceed projected requirements for a two year period.
- b. Components are furnished as Government Furnished Material to maintenance activities performing industrial activity availabilities and maintenance of submarines. The AERP provides the flexibility and speed-of-response required to ensure timely logistic support and engineering direction of complex maintenance planning.
- c. Components selected for management under the AERP are those complex, high value items required to effect the accomplishment of programmed submarine industrial activity availability or EOC requirements in the shortest possible time. However, other factors may also affect the decision to manage certain items under the AERP. Reference (i) provides specific guidance for selection of components.
- d. Various activities may initiate action to include additional components into the AERP. Such action may stem from independent study or the recognition of some Fleet requirement. In identifying potential AERP components, close coordination must be maintained with the Fleet and with the activity assigned responsibility for producing the availability work package for each submarine's availability. The final decision regarding inclusion of an item in the AERP rests with NAVSEA 07.

2.5.2 TRIDENT Planned Equipment Replacement Program (SSBN/SSGN 726 Class Submarines Only). Shipboard equipment which requires significant maintenance during the planned operating cycle, industrial level maintenance, which is beyond the capability of Ship's Force, and which cannot be accomplished during the refit period (without unacceptable impact on other refit requirements), will be supported by TRIDENT Planned Equipment Repair (TRIPER) program. TRIPER equipment will be removed from the ship for refurbishment ashore, replaced with pre-tested, Ready for Issue units and the affected system restored to full operational condition prior to completion of the refit period. Replacement will be accomplished on a planned basis at intervals designed to preclude the failure of the equipment or significant degradation of its associated system. Deviations of greater or less than one refit from established TRIPER change-out periodicities shall require ISIC concurrence. A planned change to shelf stock TRIPER equipment will be accomplished only when sufficient change kits are available to effect the change in all units of a given model of the equipment held in shelf stock. Shelf stock TRIPER equipment is represented in configuration status accounting databases maintained by SUBMEPP.

2.5.3 Aircraft Carrier Planned Equipment Replacement Program (Aircraft Carriers Only). The Aircraft Carrier Planned Equipment Replacement (CARPER) program is designed to ensure that the planned incremental availabilities of the USS NIMITZ (CVN-68) class aircraft carriers are completed on time and within cost by having a pool of historically critical, hard-to-get equipment and components available both for planned replacement and for emergent issue if needed.

2.5.4 SEAWOLF Class Rotatable Pool Program.

- a. The SEAWOLF Rotatable Pool is part of the class maintenance and availability planning process. The purpose of the program is to provide replacement components as scheduled by the Planned Maintenance Cycle Schedule, prior to failure or unacceptable degradation of installed components. Components which have been replaced are refurbished at a Designated Overhaul Point and returned in Ready for Issue status to repeat a similar cycle.
- b. Reactor plant system and equipment under the cognizance of the NAVSEA Nuclear Propulsion Directorate (08) are excluded from the SEAWOLF Rotatable Pool Program.
- c. SUBMEPP has been designated as the SEAWOLF Class Rotatable Pool Program Manager. Reference (j) provides specific guidance for managing the SEAWOLF Rotatable Pool program.

2.6 MODERNIZATION.

2.6.1 Navy Modernization Program. The Navy Modernization Program (NMP) is a CNO managed program to develop, plan, fund and accomplish Ship Changes and alterations in accordance with policies mandated in reference (b). It is executed in accordance with Volume VI, Chapter 3 (Submarines) and Chapter 36 (Surface Ships/Aircraft Carriers) of this manual and applies to all alterations to commissioned ships and craft of the Navy except as follows:

- a. Alterations to those portions of naval nuclear propulsion plants and facilities under the cognizance of the NAVSEA 08 identified in reference (k).
- b. Strategic Systems Program Alterations affecting the configuration and/or capabilities of systems and equipment under the cognizance of the Strategic Systems Programs (SSP). Reference (e) defines the policies, controls, processes and procedures for the accomplishment of all SSP Alterations issued by the Director, SSP for all SSP cognizant equipment on both SSBNs and SSGNs.
- c. TEMPALTs required for mission support or installed for test and evaluation or research and development programs.
- d. Alterations affecting configuration of hardware, software and support equipment of a TRIDENT system is under the cognizance of NAVSEA PMS 392.
- e. Temporary Modifications (TEMPMOD) are required for mission support or installed for test and evaluation or research and development programs associated with DSS and craft in accordance with reference (l). DSS systems on submarines and various craft such as Dry Deck Shelters are managed by NAVSEA PMS 399. DSS systems on various craft for Deep Submergence Rescue Systems are managed by NAVSEA PMS 394. TEMPMODs are managed in the same manner as a TEMPALT.

NOTE: TEMPORARY MODIFICATIONS TO DSS SYSTEMS PERMANENTLY INSTALLED ON SUBMARINES ARE MANAGED AS TEMPALTS.

2.6.2 Types of Ship Changes. There are only two types of Ship Changes in the NMP: Program Changes and Fleet Changes. The Submarine Force breaks these two types of Ship Changes into further sub-categories. See Volume VI, Chapter 3 of this manual for further details and definitions.

- a. Program Changes are programmed for installation by System Commands or Program Executive Offices, as well as funded for accomplishment by the System Commands, Program Executive Offices or other organizations as agreed upon.
- b. Fleet Changes are programmed and budgeted as part of TYCOM Ship Maintenance funding. Fleet Changes typically address safety of personnel and/or equipment, provide increased efficiency, reliability or maintainability and generally do not increase or add new capability.
- c. Non-Navy Ship Change Documents are programmed for installation on Naval vessels by Non-Navy organizations and they are funded for implementation by these organizations per previous agreement.
- d. Combination Ship Change Documents are programmed for installation on Naval vessels by a combination of the above organizations and their implementations are funded by those organizations per previous agreement. Under normal conditions these Ship Change Documents are funded by their Programs; otherwise they are funded by the Fleet.

2.6.3 Navy Data Environment System.

- a. Navy Data Environment (NDE) was designed as an enterprise data model to integrate and merge existing modernization, maintenance and logistics legacy data structures into a single design. The objective of NDE is to consolidate Fleet Modernization Business Processes and legacy Data Systems. The following applications have been merged into the NDE common model:
 - (1) Fleet Modernization Program Management Information System (FMPMIS) (Logistics Module) and Alteration Installation Planning System (AIPS) became (NDE-NM).
 - (2) FMPMIS Program Module and FMPMIS Execution Modules (became NDE Program and Execution Modules respectively).
 - (3) Afloat Master Planning System (NDE AMPS Module).
 - (4) Integrated Logistics Support (ILS) Cert/Master List Module.
- b. The following systems replicate data and interface with NDE to share alteration, scheduling, material and financial data:
 - (1) NDE-SPAWAR Integrated Data Environment (NDE-SIDE).
 - (2) Configuration Data Managers Database-Open Architecture (CDMD-OA).
- c. The following systems will replicate data and interface with NDE to share alteration, scheduling, material and financial data:
 - (1) TYCOM Alteration Management System (TAMS).
 - (2) Integrated Modernization Planning for Aircraft Carriers (IMPAC).

2.6.3.1 Submarine Force Navy Modernization Process. Submarine Force Navy Modernization Process phased implementation details are covered further in reference (b), Section 9 and Volume VI, Chapter 3 of this manual.

2.7 INTEGRATED FLEET MAINTENANCE MANAGEMENT. Integrated Fleet Maintenance Management is the business management model that allows for continuous maintenance by providing a seamless interface between all associated processes. It provides for processing work candidates including storage and retrieval of historical data and feedback to improve the process. The intent is to have a standard management model applicable to all platforms at all maintenance levels encompassing the following:

- a. Discover and document work.
- b. Validate and diagnose work.
- c. Integrate and screen work.
- d. Estimate and task work.

- e. Plan work.
- f. Execute work.
- g. Collect feedback and analyze data.

2.7.1 Continuous Maintenance. Continuous Maintenance is a process that involves the near continuous flow of maintenance candidates to the most appropriate level and maintenance activity for accomplishment. Timed to best support operations, it migrates from a centralized timed based batch process to a decentralized condition based nearly continuous process.

2.7.1.1 Continuous Screening Process. Continuous Screening is a process of screening work as it is discovered. Continuous Screening:

- a. Begins with identification and documentation of work candidates.
- b. Includes validation, estimation and integration of work candidates and the screening of work candidates to availabilities.
- c. Ends with the assignment and release of an availability or individual work candidate to a specific maintenance activity for execution during a specific maintenance period.

2.7.1.2 Continuous Planning Process. Continuous Planning is a process in which work is planned when tasked. Continuous Planning:

- a. Begins with tasking of a work candidate to a planning activity for preparation of a work specification and cost estimate.
- b. Ends when the specification is approved for execution. There is overlap between Continuous Screening and Continuous Planning.

2.7.1.3 Continuous Execution Process. Continuous Execution is a process in which selected emergent and non-emergent work candidates are executed outside of scheduled availabilities. Continuous Execution will not replace the current availability system. Availabilities will still be necessary to accomplish major repairs and extensive configuration changes, as well as provide the ship with a specific period of time to concentrate on maintenance and training. Continuous Execution will assist planning activities and repair activities in leveling their workload while providing the ships with a means of accomplishing repairs when needed with a minimum level of interruption to the ship's inport routine that is acceptable to the ship. The process is used when:

- a. The work candidate is ready for execution.
- b. Capacity exists in the selected repair activity.
- c. Ship's inport schedule supports the required level of repair effort.

2.8 TECHNICAL ASSISTANCE.

2.8.1 Regional Maintenance Center.

- a. The RMCs provide direct support to Fleet and TYCOMs in matters of waterfront technical assistance, maintenance training and logistics services associated with the installation, operation, maintenance, and readiness of shipboard equipment and systems. The RMCs promote Fleet readiness and maintenance self-sufficiency in shipboard systems and equipment through direct technical help in troubleshooting, maintenance and repair, on-the-job maintenance training, logistics reviews, and technical documentation support. These services help correct operational and maintenance problems which are beyond the technical capability or capacity of fleet units or FMAs.
- b. References (p) and (q) have been cancelled. Volume VI, Chapter 2 of this manual fully describes policies and procedures for the RMCs.

2.8.2 Ship Assessment, Groom and Evaluation.

- a. This program is managed and funded by the TYCOM and provides technical assistance to Ship's Force personnel in maintaining a select list of shipboard equipment and systems.
- b. Volume VI, Chapter 42 of this manual provides further explanation of this program.

2.8.3 Carrier and Field Service Unit.

- a. Carrier and Field Service Unit is a branch of the Naval Air Warfare Center designed to provide technical assistance to Fleet personnel for all launch, recovery, and visual landing aids systems.
- b. Volume IV, Chapter 16 of this manual provides further explanation of this program.

2.8.4 Elevator Support Unit.

- a. Elevator Support Unit is an element of NAVSEA's Weapons and Cargo Elevator Improvement Program funded and scheduled by the TYCOM to provide technical assistance for the maintenance, modernization and repair of weapons and cargo handling elevators.
- b. Volume IV, Chapter 8 of this manual provides further explanation of this program.

2.8.5 Propulsion Plant Engineering Activity (Aircraft Carriers Only). CVN 68 Class aircraft carrier technical assistance is available from the Propulsion Plant Engineering Activity (PPEA) for non-nuclear propulsion plant systems. The PPEA provides an additional technical resource for assisting operating aircraft carriers with technical and/or operational issues not associated with SHIPALT installation and configuration control. PPEA Liaison services are requested using the Steam Plant Action Request per reference (r). The Steam Plant Action Request is not intended to replace the Liaison Action Request or Departure from Specifications processes described in Volume V, Part I, Chapter 8 of this manual. The PPEA, using the Steam Plant Liaison Inquiry described in reference (r), will request information, disseminate technical information and direct work that does not require a drawing change or affect system configuration control.

2.8.6 Waterfront Corrective Action Program.

- a. Waterfront Corrective Action Program is a subprogram of the Shipboard Electromagnetic Compatibility Improvement Program, and is part of the RMCs, designed to provide training and technical assistance to Ship's Force in Electromagnetic Interference recognition and reduction.
- b. Volume VI, Chapter 4 of this manual provides further explanation of this program.

2.8.7 Fleet Maintenance Support Branch (Nuclear Powered Vessels Only).

- a. Fleet Maintenance Support Branches' charter is to improve the Fleets ability to perform nuclear maintenance. This is accomplished by the following:
 - (1) Training.
 - (2) Providing on-site technical support.
 - (3) Acting as corporate memory.
- b. Fleet Maintenance Support Branch support should be coordinated through the respective Surface Nuclear Maintenance Training Group and, for submarines, coordinated through the parent ISIC.

2.9 PROPULSION PLANT MATERIAL CONDITION (AIRCRAFT CARRIERS ONLY).

2.9.1 Purpose. This section presents a comprehensive approach to assessing and maintaining propulsion plant material condition on Nuclear Powered Aircraft Carriers (CVN). The cornerstone of this program is the Material Condition Assessment Process (MCAP) which employs incremental maintenance concepts to apply inspections, maintenance, training and both depot and afloat assets toward the consistent identification, evaluation, tracking and correction of propulsion plant material condition deficiencies. The program assigns specific duties to both Ship's Force and the TYCOM staff to ensure the ship has the assets, processes and support in place to effectively manage propulsion plant material condition over the life of the ship. The effectiveness of this process is measured by the material condition of the propulsion plants.

2.9.2 Applicability. The guidance provided in this section focuses on CVNs.

2.9.3 Ship's Force Requirements.

2.9.3.1 Reactor Maintenance Officer. The Reactor Maintenance Officer (RMO) is responsible for the long range planning and management of propulsion plant maintenance throughout the ship's cycle. Specific responsibilities include:

- a. Coordinate with other Reactor Department Principal Assistants to ensure divisions are continuously identifying, evaluating and correcting material deficiencies in the propulsion plants. The RMO will periodically review the MCAP Database (Equipment Deficiency Log (EDL)) and the Equipment Status Logs (ESL) to ensure deficiencies are being identified and documented.
- b. Coordinate with other Reactor Department Principal Assistants to ensure divisions are submitting work requests for inclusion into future availabilities and up-keeps, as necessary to correct significant or overly burdensome material deficiencies.
- c. Function as the ship's liaison for all outside maintenance activities. The RMO shall be the primary point of contact for all matters pertaining to maintenance of the propulsion plants to include coordinating with the TYCOM in the planning, prioritizing and execution of scheduled repairs.
- d. Request assistance as necessary, via the TYCOM, to accomplish nuclear and non-nuclear planned maintenance inspections.
- e. Coordinate (with Reactor Training Assistant/Training Officer) all required shipyard and TYCOM training for the Reactor Department prior to the start of availabilities.
- f. Request training, via the TYCOM, on the execution of material inspections. The training, conducted by a small (a notional five person team consisting of shipyard nuclear and non-nuclear engineers and a MCAP Zone Manager/Coordinator) group of shipyard MCAP experts, is normally conducted in conjunction with the pre-deployment Material Condition Assessment Inspection (Pre-Deployment MCAI). The primary goal of the training is to provide focused information and training to Ship's Force personnel on MCAP inspection attributes and techniques. The RMO shall be the single point of contact for scheduling TYCOM provided and/or funded maintenance and inspection training.
- g. Coordinate, via the TYCOM, the use of groom teams, as needed. Groom teams may be shipyard or contractor personnel who can be scheduled to find and fix discrepancies associated with specific systems or components. Groom teams employ standard tests to evaluate system performance and may assist in the correction of deficiencies as well as their identification and documentation.
- h. Coordinate, with other Reactor Department Principal Assistants, to ensure that deficiency lists generated by groom and inspection teams are incorporated into the MCAP Database (EDL).
- i. During CNO availabilities, perform actions necessary for certification of Reactor Plant Support Systems required to support principal propulsion plant evolutions in accordance with reference (s). Prior to performing work on these components/systems, the RMO shall consult with the shipyard project team to ensure that a clear path to re-certification (or interim certification) is identified.
- j. Assist the Reactor Officer and the other Principal Assistants in the planning and management of SHIPALTS and modifications to reactor plant systems and support systems.
- k. Ensure that non-propulsion plant deficiencies identified as part of the MCAP are passed to the Ship's Maintenance Manager for action. The Ship's Maintenance Manager is responsible for coordinating and reporting the correction of these deficiencies in a timely manner. Increased emphasis on deficiency correction and reporting may be required by the Ship's Maintenance Manager during key event readiness periods.

2.9.3.2 Material Condition Assessment Process. Appendix A presents a notional, 27 to 36-month, MCAP Timeline. This timeline provides visibility of the many areas requiring consideration and action by both the ship and associated Project Team, both inside and outside of CNO availabilities. The timeline provides a template capturing the minimum efforts that should be undertaken throughout the ship's operational cycle to support improvement of propulsion plant material condition. It was developed by a detailed review of associated source documents and experience in MCAP implementation across the fleet and should be tailored by the RMO to suit the ship's individual schedule and circumstances. The following are events from the MCAP Timeline that are of particular significance to Ship's Force that are not specifically addressed in other source documents:

- a. Pre-Deployment Material Condition Assessment Inspection. The Pre-Deployment MCAI is a non-intrusive walk through inspection of propulsion plant spaces conducted by Ship's Force (with shipyard support) prior to deployment. This inspection is conducted as a joint effort in conjunction with pre-

inspection training provided by shipyard engineers and inspectors. The scope of the pre-deployment MCAI exceeds that of the ship's periodic zone inspections and is intended to be a mid-cycle assessment of propulsion plant material condition.

- (1) The objectives of the inspection are:
 - (a) To validate the standards used in the material condition assessment process. This is accomplished through the pre-inspection training provided by shipyard engineers and inspectors. This training is intended to be the most significant opportunity to train and educate Ship's Force personnel with regard to inspection attributes and material standards.
 - (b) To identify deficiencies prior to deployment in time to order and receive material before departure. This ensures that Ship's Force has the material on hand to correct deficiencies while on deployment.
 - (c) To provide a mid-cycle review and validation of the health of the MCAP.
 - (d) To set the tone for continuing inspections during the ship's deployment. Aggressive identification and correction of deficiencies during deployment will result in an overall improved propulsion plant material condition and reduce work package churn in the subsequent CNO availability.
 - (2) Scheduling of the Pre-Deployment MCAI must balance the benefits of early identification of material issues against operational requirements. However, whenever possible, the inspection should be completed no later than three months prior to deployment. The TYCOM Maintenance Program Manager will fund a shipyard MCAP training team (notionally five to ten people in size), when requested by the RMO, to assist in the performance of the MCAI. The training team provides (1) targeted training and deckplate feedback to Ship's Force in support of the inspection, and (2) acts as an independent check for both the ship and the TYCOM that the ship's MCAP program is being administered in a manner that supports the intent of the program. The ship's Commanding Officer retains responsibility for determining the impact and required actions for deficiencies identified during this inspection.
- b. Production Completion Date. Production Completion Date (PCD) is a CNO availability key event that is scheduled two weeks prior to the respective plant hot-operations key event and marks the Project Team's transition from production work to preparations for test events and plant operations. It is intended that all propulsion plant work, deficiency correction and associated testing required for hot-operations (Light Off Assessment) be completed by PCD. However, PCD requires a subjective evaluation by the ship's Commanding Officer, Reactor Officer and Project Superintendent that production work, testing and deficiency correction has been reduced to a level and/or area of the plant such that required key event preparations can proceed satisfactorily, to completion, in the ensuing two-week period. Upon reaching PCD, the Reactor Officer and the rest of the Project Team must be able to shift their focus away from production work and testing to preparations for plant operations. These preparations include but are not limited to:
- Pre-event certifications and resulting discrepancy correction
 - Danger Tag removal and system restoration
 - Ship's Force Startup Maintenance
 - System Valve lineups
 - Continued deep cleaning and small valve maintenance
 - Use of Groom Teams in areas requiring special emphasis
 - Temporary Service Removal
 - Training on Hot Operations/Non-Critical Steaming

Transition to an operational environment and focus

- (1) Previous availabilities have shown that if excessive production work and testing is still ongoing at the time PCD is evaluated as complete, key event preparations will be adversely affected and the hot operations key event date will usually be negatively impacted.
 - (2) If it is necessary to delay PCD, strong consideration should be given to moving the hot operations key event accordingly, in order to protect the integrity of the two-week preparation period. Otherwise, it must be recognized that the transition from a maintenance intensive environment to an operationally focused environment may be negatively impacted.
 - (3) In the event that some production work and testing will be ongoing, the Project Team will generate an exceptions list detailing all work and associated testing that is intended to continue after PCD. The Project Team must **formally** agree that the intensity and/or volume of the items on the exceptions list will not adversely impact the Project's ability to complete preparations for the upcoming event, in an orderly and timely manner.
 - (4) Some specific questions that should be considered when determining whether a project has reached PCD include:
 - (a) Are major system piping and valves intact?
 - (b) Are propulsion plant damage control and fire-fighting systems and the associated repair lockers stocked and operational?
 - (c) Are ladders installed? Are space accesses and at least one of the two escape trunks in each space clear for passage?
 - (d) Are doors, hatches and scuttles installed and operational?
 - (e) Are temporary services removed with the exception of essential support systems and systems installed to support remaining work?
 - (f) Are all deck plates and associated supports installed?
 - (g) Has loose industrial material and debris been removed?
 - (h) Have major lagging repairs been completed? Is the extent of any remaining lagging work minimal (not including temporary lagging installed to support later testing)?
 - (i) Are pre-test inspections and correction of associated deficiencies complete?
 - (j) Has major preservation and painting been completed? Is the extent of remaining touch-up painting acceptable?
 - (k) Have deficiencies identified by the MCAI, weekly walk-throughs, associated cold plant testing, and any rework/retest associated with the testing, been completed or resolved? If not, are the remaining deficiencies at a low enough level that they can be corrected without impacting event preparations?
 - (l) If applicable, has System Turnover been completed? Have all discrepancies identified during the turnover process been corrected?
- c. Deficiency Identification and Correction. The basic organization of a CVN Reactor Department has long established programs in place to support the day-to-day identification and tracking of material deficiencies (3M system, Zone Inspection Programs, MCAP Database, EDL, CSMP, etc.). However, experience has shown that successful programs are those that support **continuous** identification and correction of propulsion plant deficiencies, that have incorporated the timelines of Appendix A and have placed increased emphasis on known problem areas. Some of the propulsion plant maintenance areas that have historically required special attention are listed below. Each CVN may identify additional areas as they progress through the maintenance cycle.

- (1) Valve Maintenance and Inspection. All valves in the propulsion plant are required to be inspected and maintained in accordance with the applicable chapters of the component technical manual. Special emphasis should be placed on the early identification and correction of stem packing leakage in conjunction with the MCAP inspection program. All valves having less than two valve isolation from high-energy systems should be inspected annually at a minimum. Prior to availabilities that will include a plant cool down, particular attention should be given to steam generator isolation valves, safety valves, blowdown and sampling system valves and all 500 series main feed and main steam system valves. Any valve that shows signs of packing leakage or has minimal packing gland adjustment remaining should be entered into the MCAP Database (EDL) for further evaluation.
- (2) Structural Preservation. Areas of the propulsion plant are to be inspected for structural corrosion on a rotating basis in conjunction with the ship's MCAP inspection plan. Particular emphasis should be placed on areas exposed to salt spray (ventilation spaces, weather deck fittings), equipment foundations, low traffic areas, and all out of plant spaces owned by Reactor Department or that contain reactor support equipment. References (t), (u) and (v) provide additional guidance on applying and resurfacing plant structural components and coating color schemes.

NOTE: REFERENCE (v) WAS DISTRIBUTED TO ALL CVNs BY NAVSEA LTR 92T124/0418 DATED 5 NOV 01 AND PROVIDES AN EXCELLENT STANDARDIZED GUIDE OF THE VISUAL CONDITION OF PAINTED COMPONENTS AND SURFACES IN THE INTERIOR OF SHIPS DURING MAINTENANCE AVAILABILITIES OR CONTRACTED PRESERVATION TEAM WORK. ADDITIONAL COPIES ARE AVAILABLE IN SPIRAL BOUND BOOK FORM AND ON CD-ROM FROM THE NAVAL LOGISTICS LIBRARY (<http://nll.navsup.navy.mil/>). ACCESS THE P2003 SHOPPING CART AND INPUT EITHER TECH MANUAL NUMBER SL700-AB-GYD-010 OR NSN 0910-LP-100-4420.

- (3) Lagging and Insulation. Damaged or worn lagging/insulation should be inspected and upgraded using the guidance of references (c), (h), and the CVN 68 Class Incremental Maintenance Plan, Sequencing Plan in conjunction with the ship's MCAP inspection program. Ships should consider maintaining a separate list of lagging removed by Ship's Force as a result of maintenance, wetting or becoming oil soaked. Guidance for installing and maintaining insulation can be found in reference (w). Painting of insulation is covered by the aforementioned Reactor Plant Paint Schedule.
- (4) Paint and Preservation. In conjunction with the structural preservation and bilge preservation inspections discussed in this section, the ship must ensure that the paint and preservation status of general propulsion plant spaces is maintained over time with emphasis placed on the work that will be done during availabilities. The CVN 68 Class Incremental Maintenance Plan, Sequencing Plan provides guidance on rotation plans for propulsion plant spaces. Ships should consider maintaining a list of spaces annotating the dates when spaces were last painted/preserved to assist in long term planning. References (t), (u) and (v) (see NOTE in paragraph 2.9.3.2.c.(2) of this chapter) provide additional guidance on applying and resurfacing plant structural components and coating color schemes.
- (5) Bilge Preservation. Invasive, below the deck level, inspections are the key to maintaining the integrity of bilges and bilge structural members. Ships should ensure that regular bilge inspections are scheduled in conjunction with the ship's MCAP inspection program with increased emphasis during the Pre-Availability and Pre-Deployment MCAI inspections. Progressive maintenance techniques are required for coatings in the propulsion plant bilges to wear as projected and must be resurfaced at the appropriate intervals. Guidance on inspection criteria and establishment of inspection zones can be found in CVN 68 Class Depot Maintenance Requirement Card MRC 631-01. References (t), (u), (v) and (x) (see NOTE in paragraph 2.9.3.2.c.(2) of this chapter) provide additional guidance on applying and resurfacing plant structural components and coating color schemes.

- (6) Oil Leak Identification and Correction. Ships should aggressively identify and correct oil leaks, with particular attention to areas underneath the main engines, turbine generators, lube oil purifiers and in the vicinity of lube oil pumps. Inspection plans should divide the propulsion plant spaces into zones to ensure all areas are inspected annually at a minimum. The list of identified oil leaks can then be prioritized in the MCAP Database (EDL) for correction.
- (7) Electrical Cableway Inspection. Shipboard electrical cableways for the most part are taken for granted. Improperly installed cables in the propulsion plant can not only damage existing cables but may also impact watertight/airtight integrity. Cableways must be properly installed and maintained in accordance with the requirements of references (y) and (z). Additional guidance for conducting cableway assessments in conjunction with the ship's MCAP inspection program is available in Volume VI, Chapter 28 of this manual.
- (8) Typical Recurring Deficiencies. The ship should actively pursue the identification, documentation and correction of typical recurring deficiencies through the periodic MCAP inspections. Listed below are examples of the types of items that should be continuously identified and corrected. TYCOM will provide funding during availabilities, Planned Incremental Availabilities and Docking Planned Incremental Availabilities for the shipyard or other activity to provide assistance in resolution, as required.
 - (a) defective/missing spray shields
 - (b) missing deck plate screws
 - (c) lockwire/locking cable deficiencies
 - (d) mixed/missing/corroded fasteners
 - (e) small valve maintenance deficiencies
 - (f) loose/damaged stuffing tubes
 - (g) missing/damaged pipe hangers
 - (h) missing/misaligned/leaking funnels
 - (i) missing gage fasteners and gage line supports
 - (j) electrical cable and lighting deficiencies
 - (k) missing/damaged label plates
- d. Acceptable-As-Is items. The MCAP database has the ability to provide the ship with information concerning material conditions that have been previously classified as "Acceptable As Is". Each entry should identify the equipment and its location, provide a description of the acceptable condition and a reference to the technical documentation that accepted the condition. Shipyards can use this data during depot availabilities to preclude repetitive research for acceptable, existing conditions that would otherwise be considered deficiencies. The shipyard will provide the ship with electronic copies of all waiver letters, Liaison Action Request responses, Departures from Specifications and any other acceptance documentation generated during an availability. The RMO with the assistance of the Reactor Plant Planning Yard should ensure the data is kept up to date between depot availability periods.

2.9.3.3 Methods for Assessment of Material Condition. There are several methods used to periodically assess and improve the material condition of the propulsion plants for CVN outside of depot availabilities. The existing programs provided by the fleet commanders to improve material condition are addressed in Volume VI, Chapter 42, of this manual. Other methods include:

- a. Material inspections conducted by the Surface Nuclear Propulsion Mobile Training Teams (MTT).
- b. Material inspections conducted by the Board of Inspection and Survey.
- c. Material inspections conducted by the Nuclear Propulsion Examining Board (NPEB).

- d. Periodic inspections conducted by shipyard engineering and inspection groups, usually in conjunction with availability planning. These inspections include Carrier Availability Planning System, Point of Entry Testing (POET), MCAIs and zone inspections of the propulsion plant spaces.
- e. Carrier Engineering Material Assessment Team coordinators groom systems to include Leslie valves, high pressure air compressors, low pressure air systems, governor control systems, distilling plants, etc.
- f. Periodic Ship's Force Zone Inspections.
- g. Pre-Deployment Material Condition Assessment Inspection.

The table shown in Appendix B is a compilation of propulsion plant inspections and references.

2.9.3.3.1 Attributes and Acceptance Standards for Material Condition Inspections. The inspection criteria used for material inspections throughout the ship's operational cycle shall be uniform and consistent to provide an accurate assessment of the material condition of the propulsion plant.

- a. Reference (s) shall be used to inspect non-nuclear propulsion systems and components. The checklist provided in Appendix C is to be used as a guide during CNO Availabilities when reference (r) is invoked for determination of system readiness to support execution of a Key Event. This checklist may also be used outside of availabilities to determine system readiness to support ship operations.
- b. References (aa), (ab) and (r) shall be used to inspect nuclear propulsion systems and components. Inspection criteria for nuclear mechanical systems is listed in Appendix D. Inspection criteria for nuclear electrical systems is listed in reference (ab).

2.9.3.4 Propulsion Plant Planned Maintenance. Reference (ac) lists the planned maintenance pertinent to reactor systems and includes numerous inspections and checks to review material condition. It can be advantageous for the ship to request shipyard quality control inspector or production shop assistance when conducting the annual inspections of the Reactor Compartment and Pressurizer Shed. In addition, the ship should consider requesting assistance when performing periodic inspections of piping hangars, piping and supports in bilges, load centers and reactor vessel shielding.

2.9.3.5 Training for Ship's Force. The TYCOM, in conjunction with other activities (e.g., NSY, Fleet Maintenance Support Branch, Shore Intermediate Maintenance Activity (SIMA), Trident Training Facility), has developed specific training courses to enhance technical maintenance capabilities and inspection techniques. In addition, shipyard personnel can provide training on subjects such as lagging replacement, lockwire/locking cable installation and inspection techniques. Ship's Force requests for specific training topics (e.g., shipyard inspection training prior to conducting the pre-deployment MCAI) shall be processed through the TYCOM. Ship's Force should schedule this training early and ensure sufficient personnel are trained.

2.9.4 Type Commander Responsibilities.

- a. Budget and plan for correction of both typical recurring deficiencies and other material deficiencies during all upkeeps, availabilities, Planned Incremental Availabilities and Docking Planned Incremental Availabilities.
- b. Assign groom teams as necessary, to assist Ship's Force in maintaining the material condition of the propulsion plant.
- c. Provide the maintenance and inspection training requested by Ship's Force. This provisioning of training will include funding a shipyard MCAP team requested by the RMO in support of the pre-deployment MCAI. This small team (five to ten person notional size) provides (1) targeted training and deckplate feedback to Ship's Force in support of the inspection, and (2) acts as an independent check for both the ship and the TYCOM that the ship's MCAP program is being administered in a manner that supports the intent of the program.
- d. Provide training for RMOs through the TYCOM N9 and N43 organizations to ensure they understand common maintenance problems among carriers, the requirements of this chapter and how to better plan for availabilities.

- e. For CNO Availabilities, maintain, with Ship's Force and shipyard input, an Availability Parts Support List containing special parts and routinely required support equipment necessary to support Ship's Force work (e.g., breaker locking clips, valve locking devices, tygon tubing, flexes, thread protectors, foreign material exclusion plugs, valve stems). These material items can then be ordered and procured early so that production work will not be disrupted.
- f. Meet periodically with the Reactor Officer and/or RMO to review the ship's material condition. The need for TYCOM support in identifying and correcting material deficiencies should be addressed at this time.
- g. Provide timely review and scheduling of deficiency correction for items identified during the inspections and grooms of paragraph 2.9.3.3 of this chapter.

2.9.4.1 Type Commander Mobile Training Team Visits. The MTT should periodically evaluate the ship's material condition including a review of the ship's MCAP Database (EDL) to ensure the ship has an effective program for identifying and correcting material condition deficiencies. It is important that the MTT does not critique lists that are too large, since this chapter specifically encourages ship's to document deficiencies that are beyond the capability of the ship or are too numerous to fix considering the ship's operational commitments. Attributes that should be checked include:

- a. Ensure that the MCAP Database (EDL) is current and accurate based on MTT material condition inspections (i.e., is the ship's MCAP Database (EDL) an accurate representation of propulsion plant material condition based on the number, type and severity of items identified by the MTT? Are the plans for corrections realistic?)
- b. Ensure that deficiencies have not remained in the MCAP Database (EDL) for an excessive amount of time (i.e., the turnover rate of the deficiencies). Large backlogs indicate the need for increased Ship's Force attention and/or TYCOM assistance to correct deficiencies.

2.9.5 Assessing Deficiency Impact and Scheduling Corrective Action. During scheduled CNO availabilities shipyard personnel must review applicable plans and specifications in order to determine whether correction of a deficiency is required to support propulsion plant testing key events. Factors that must be considered in making this determination are type and severity of the defect, service of the component involved, accessibility of the defect for repair during shipyard availability versus upkeep period, effect on personnel or equipment safety, impact on system operation and cleanliness or preservation (i.e., required to restore cosmetic appearance versus resistance to corrosion). Every attempt should be made to correct all deficiencies during scheduled CNO availabilities, however, propulsion plant testing key events shall not be delayed in order to correct deficiencies that are not required to support that event. Such deficiencies can be deferred and may be scheduled for correction outside of the availability. Deficiencies that are primarily cosmetic are ideal candidates for deferral consideration. When material condition deficiencies are identified outside of CNO scheduled availabilities, the Reactor Officer determines whether corrective action is necessary and when it should be accomplished. Appendix A provides guidance regarding deficiency disposition in either case.

2.10 100 HOUR TRANSITION PERIODS (SURFACE FORCE SHIPS ONLY).

2.10.1 Critical Time Period. The 100 hours at the beginning and at the end of an availability are critical times for availability execution. The ISIC, TYCOM, NSA/LMA and ship are responsible for coordinating the 100 hour plan. Any job or event that is viewed as hindering the start of the availability shall be included in the 100 hour plan. Communication is vital to ensuring a full understanding of all work and associated requirements. First 100 Hour Plan should be discussed at the following:

- a. For Continuous Maintenance Availability, discuss First 100 Hour Plan at the Work Package Execution Review (WPER).
- b. For CNO Availability, discuss First 100 Hour Plan at the WPER.

Details for the first and final 100 hours shall be as follows:

2.10.2 First 100 Hour Plan. The First 100 Hour Plan will notionally start the first full work day of the availability. The items listed below are the focus of the first 100 hours, as indicated in Appendix E, and will be discussed again at the Arrival Conference.

- a. Conduct Tag-out audit.

- b. Establishing plant conditions.
- c. Establishing working hours and implement work controls (i.e., Tag-outs and Work Authorization Forms (WAF) throughout the availability.
- d. NSA/LMA and Ship's Force will have a plan ready to execute at the start of the availability to place required equipment/systems into Inactive Equipment Maintenance status.
- e. Jobs still requiring ship checks will be listed in the Availability Planning Message.
- f. Test forms required for Ship's Force retest of FMA work will be delivered to the ship within the first 100 hours for Ship's Force to review, plan and write procedures as necessary.
- g. Brief all critical path jobs (i.e., work that requires most of the availability to complete) that will start during the first 100 hours.
- h. Establish who from Ship's Force is authorized to sign off equipment testing (i.e., E-7 and above).
- i. Confirm weekly progress meetings and times with Ship's Force and contractor management.
- j. Submit Availability Start Message to cognizant Fleet Commander.
- k. Provide Ship's Force with an Executive Level Integrated Maintenance Availability schedule (i.e., critical path jobs, long lead time jobs, Maintenance Control Team jobs, high visibility jobs).
- l. Conduct maintenance availability training/stand down for Ship's Force on critical safety systems (i.e., Tag-out/electrical safety, hearing conservation, sight protection, respiratory safety, etc.).

2.10.3 Final 100 Hour Plan. The Final 100 Hour Plan will notionally begin four days prior to the beginning of sea trials; or if no sea trials, last day of the ship's scheduled availability. Items listed below must be completed in accordance with Appendix F, which provides an outline of the final 100 hours.

- a. Production work complete. It is vital all production work is completed by the 100 hour point to allow for the remaining events to occur without delay.
- b. Production related temporary services removed.
- c. Conduct departure conference.
- d. Commence dock trials; complete dock trials.
- e. Conduct Tag-out audit.
- f. WAFs require close out no later than 72 hours prior to the beginning of sea trials; or if no sea trials, end of the availability. Conduct final WAF audit after closeout.
- g. Testing associated with production work is completed and reviewed. (Testing should be ongoing as production work is completed throughout the ship's availability.)
- h. Operationally test systems/equipment repaired or modernized during the availability.
- i. Conduct Pre-Underway checks and Master Light-Off Checklists (MLOC).
- j. Crew watchbills and berthing bills complete.
- k. Conduct Fast Cruise.
- l. Complete Fast Cruise.
- m. Crew rest and final administration.

(This Page Intentionally Left Blank)

APPENDIX A**MATERIAL CONDITION ASSESSMENT PROCESS TIMELINE**

PURPOSE: The timeline of this Appendix lays out the material condition assessment process throughout the ship's Fleet Readiness Training Plan. The plan also includes descriptions of the various events that occur and who is responsible for the actions outlined. With this information, the various stakeholders in the project team can develop a clear understanding of the process. This will encourage better communication, planning and completion of all required actions.

This timeline is provided as a guide to be used for development of a CVN 68 class ship specific timeline for a Planned Incremental Availability or Docking Planned Incremental Availability. The timeline is not applicable to a Refueling Complex Overhaul availability.

Notes:

1. The following timeline is a generic version of a Project Material Condition Assessment Process. The project team will develop a timeline and plan specific to each availability taking into account the ship's schedule (deployment, transit periods, upkeeps and early start periods). The plan includes descriptions of the events (purpose of inspection/action, which activity performs the action, results, etc). The timeline and plan allows the Project Team (shipyards, Ship's Force, TYCOM) to develop a clear understanding of the process. Timeline should be developed to present at the first project planning meeting (target 15 months prior to start of availability).
2. Deficiencies identified during the MCAI and following assessments will be evaluated per the attached Deficiency Evaluation Flowchart.
3. The Pre-deployment MCAI may be required more than once in an MCAP "cycle" given that two (more) deployments may be planned for a carrier in the interval between CNO availabilities. In this instance, the RMO should request the shipyard MCAP training team in conjunction with each performance of the Pre-deployment MCAI.

MCAP

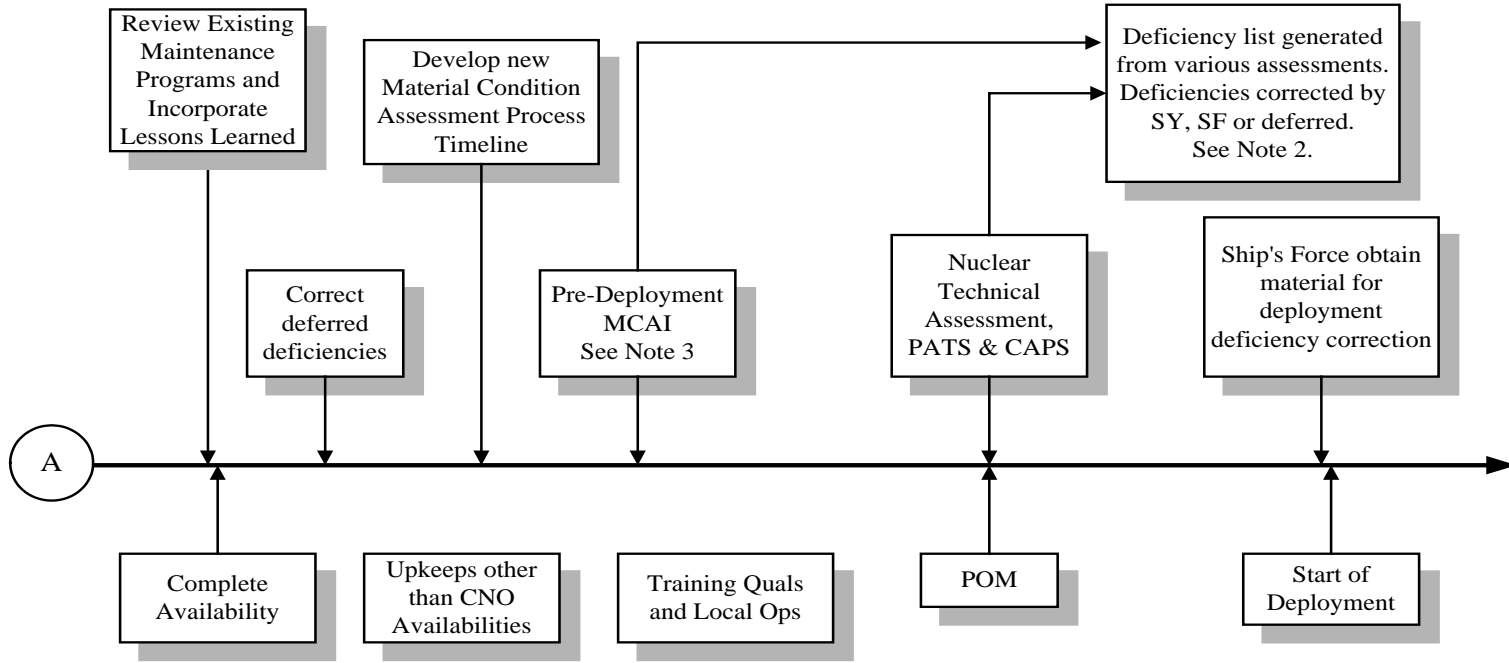

II-I-2-A-2

MCAP

II-I-2A-3

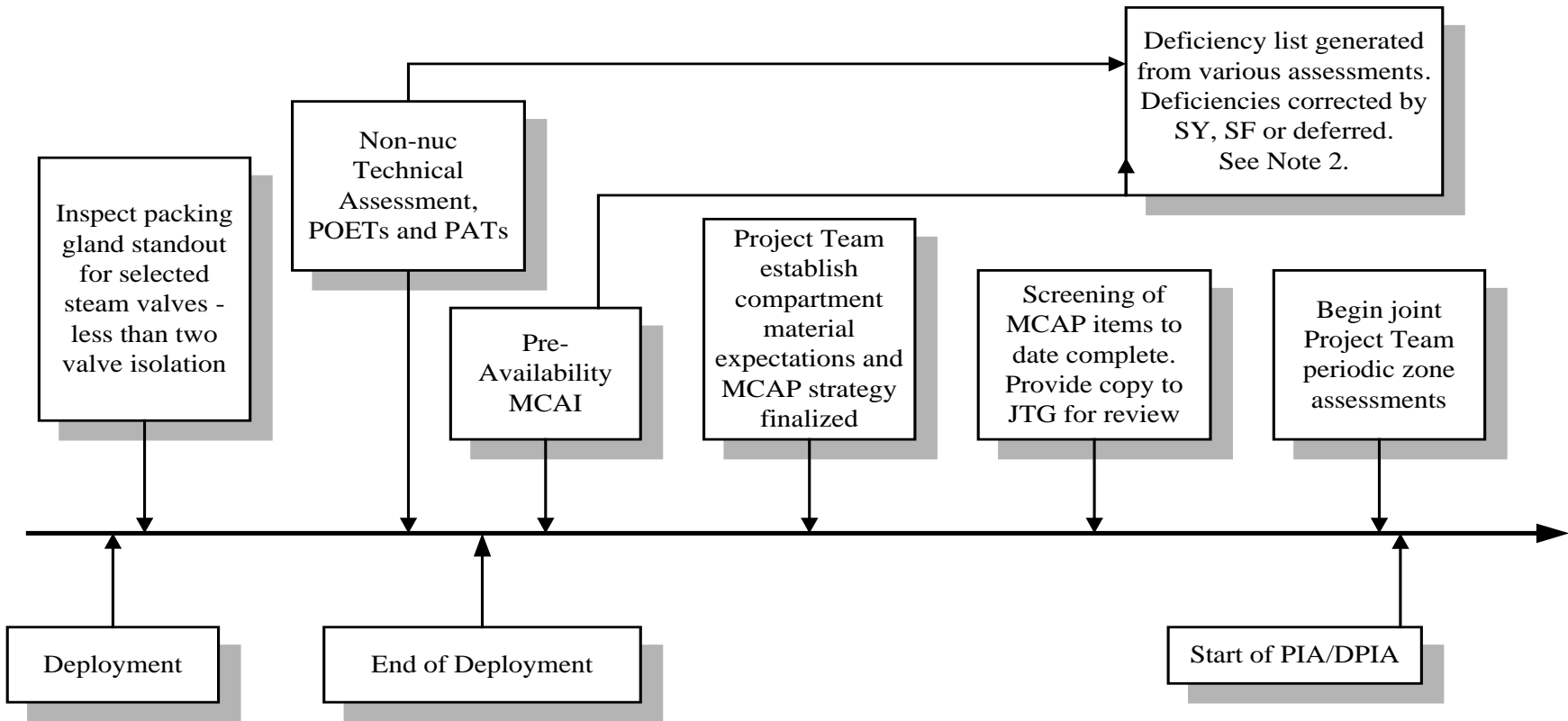

MCAP

II-I-2A-4

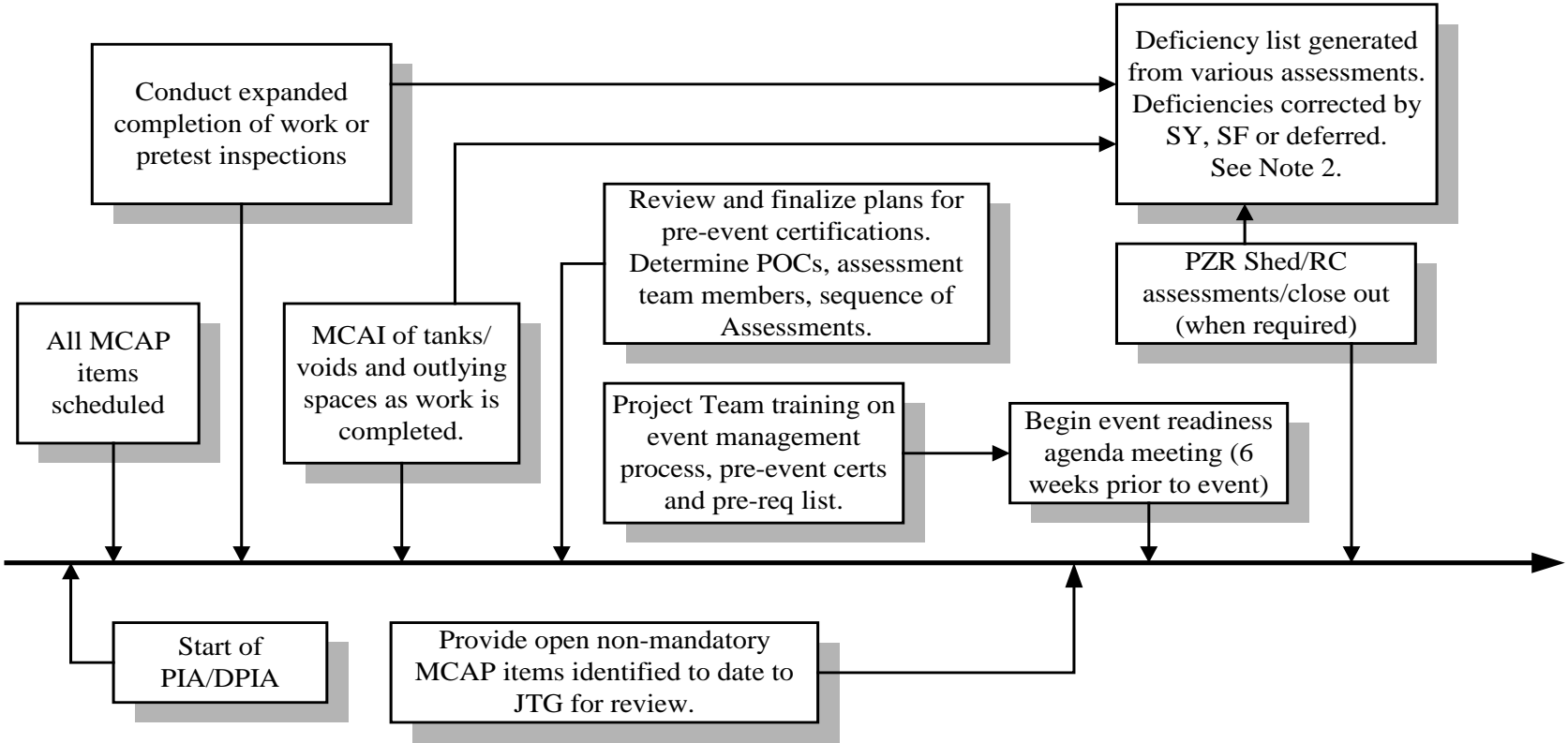

MCAP

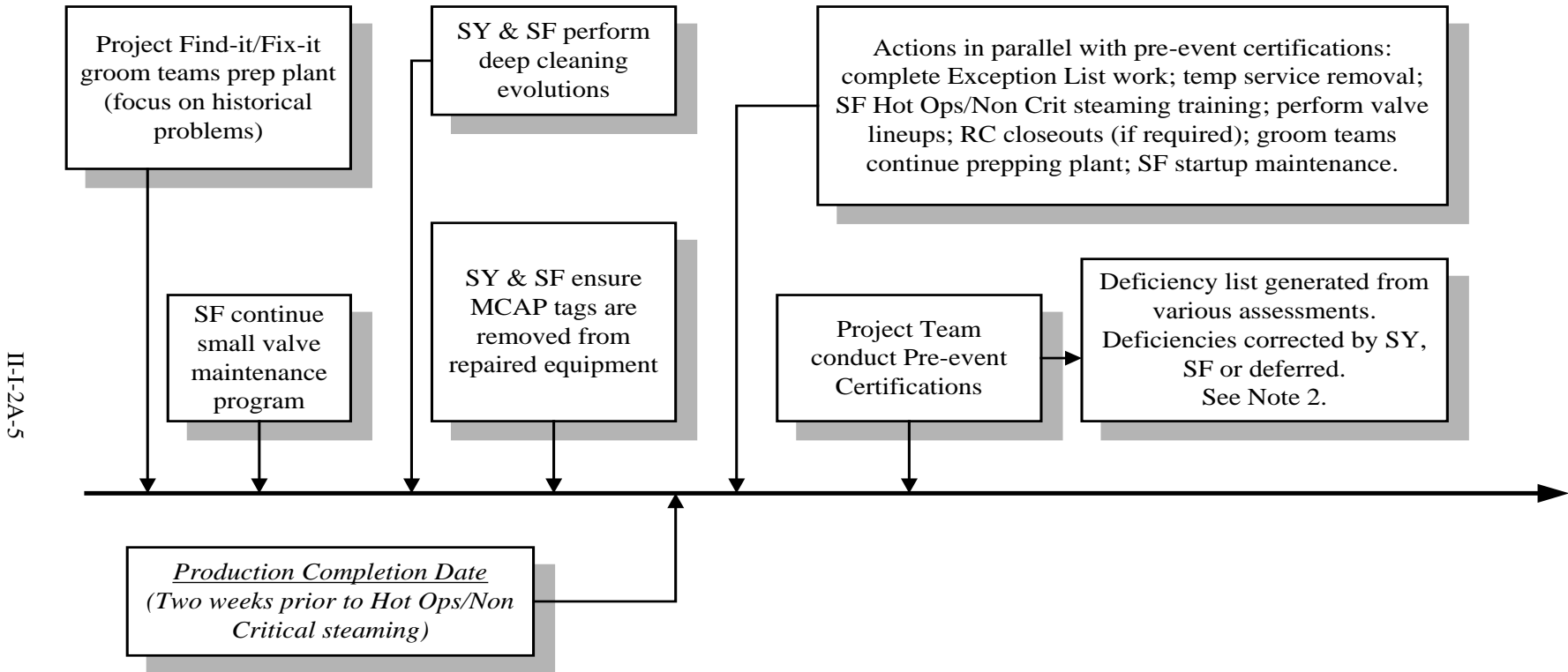

MCAP

Conduct Project Walkthrough for Propulsion Plant Test Program

Conduct Senior Management Walkthrough for Propulsion Plant Test Program

Exceptions List developed and published

Sign Hot Ops/Non-crit steaming Pre-Requisite List (PRL)

Hot Ops deficiencies identified, corrected or deferred

Non-Crit Steam deficiencies identified, corrected or deferred

Sign Power Range Testing Pre-Requisite List (PRL)

Start Hot Ops

Start Non-Critical Steaming

Complete Non-Critical Steaming

PORSE Preps (when required)

PORSE (when required)

II-I-2A-6

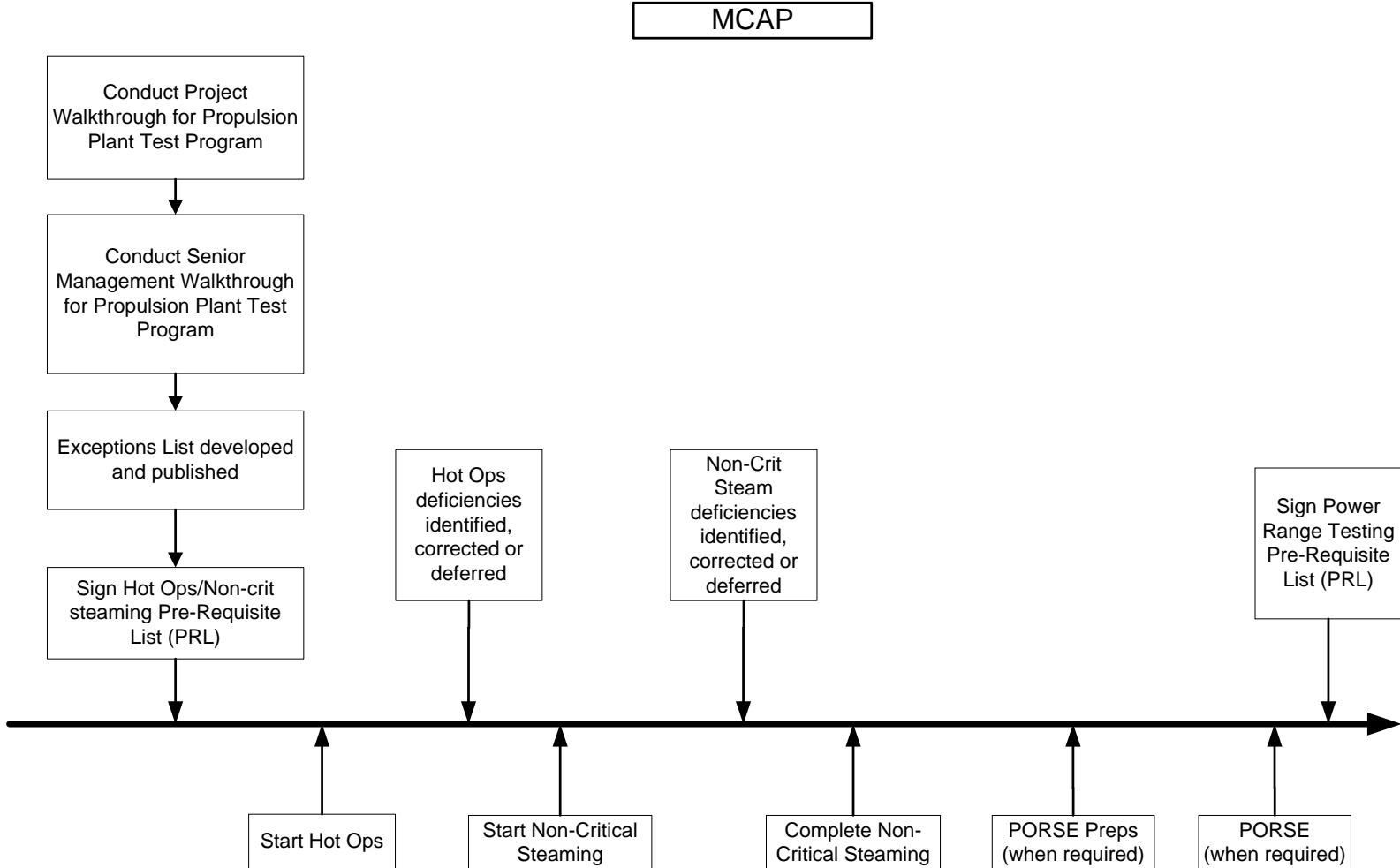

MCAP

II-I-2A-7

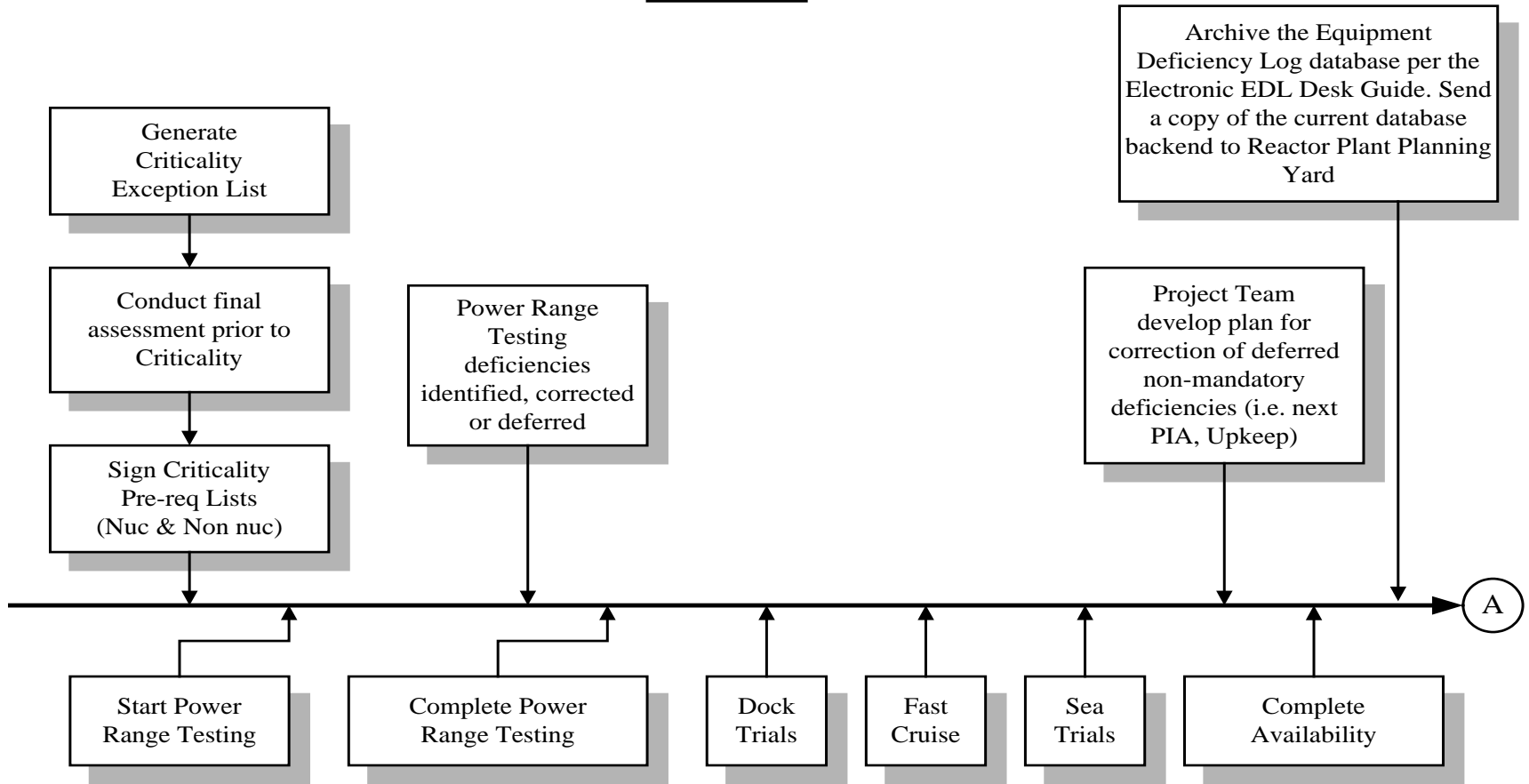

MCAP Deficiency Evaluation Flowchart

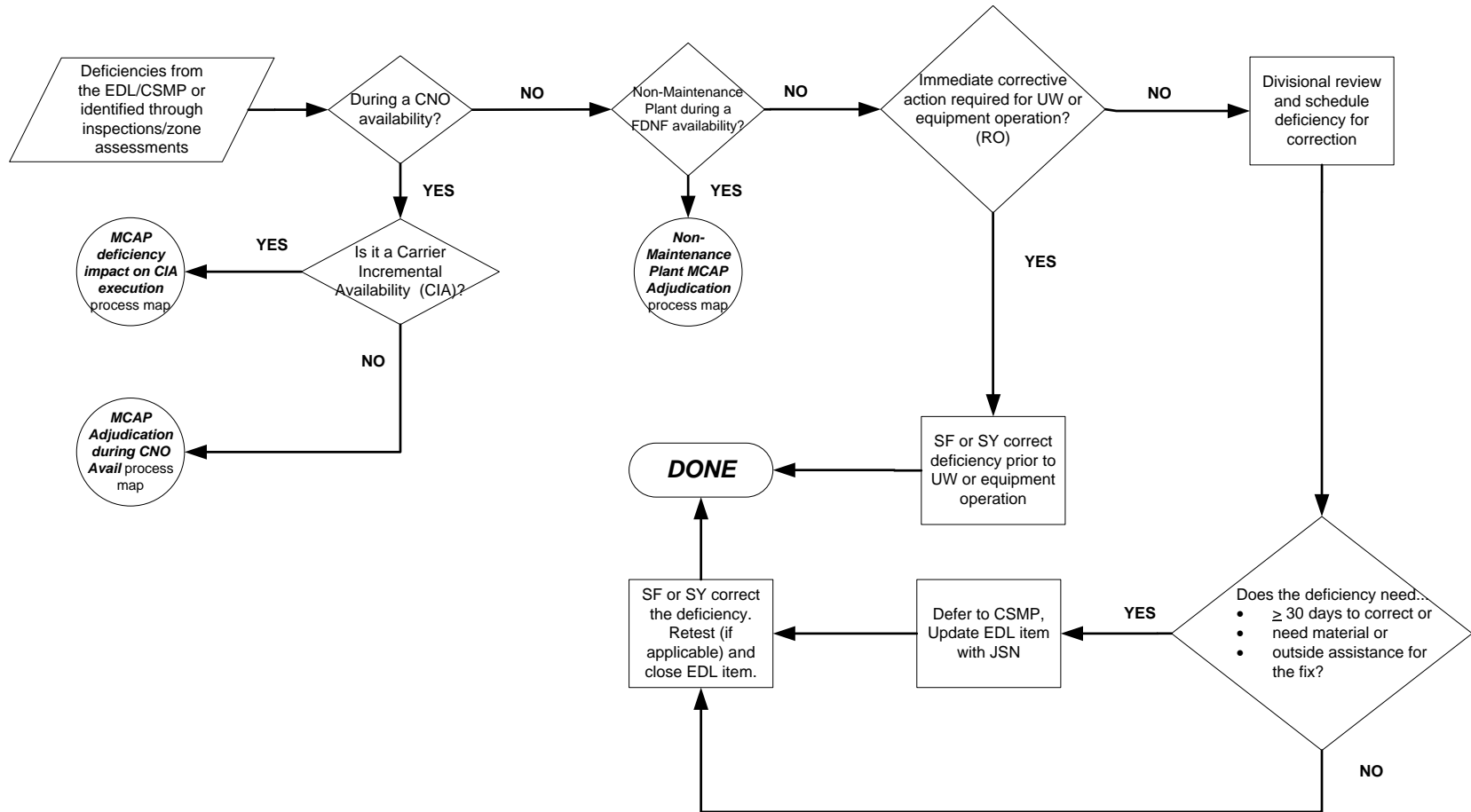

General Notes:

An effort should be made to fix any and all deficiencies as soon as possible. Generally, deficiency correction will fall within one of three general, generic "paths"...

1. The item doesn't meet technical requirements in one or more parameters, and must be fixed prior to the next startup, or a Key Event in a maintenance period.
2. The item doesn't meet technical requirements, and it's preferable to fix the item during the maintenance period in question. You could, however, operate the plant safely with the item as it stands.
3. While not meeting technical requirements, it's an item requiring a small (usually < 8 hours to fix) expenditure of time/labor to correct. Examples include minor paint touchup, small lagging tears, a lagging "button" missing from a sheet of bulkhead lagging.

MCAP Adjudication Process Map (during a CNO availability)

II-I-2-A-9

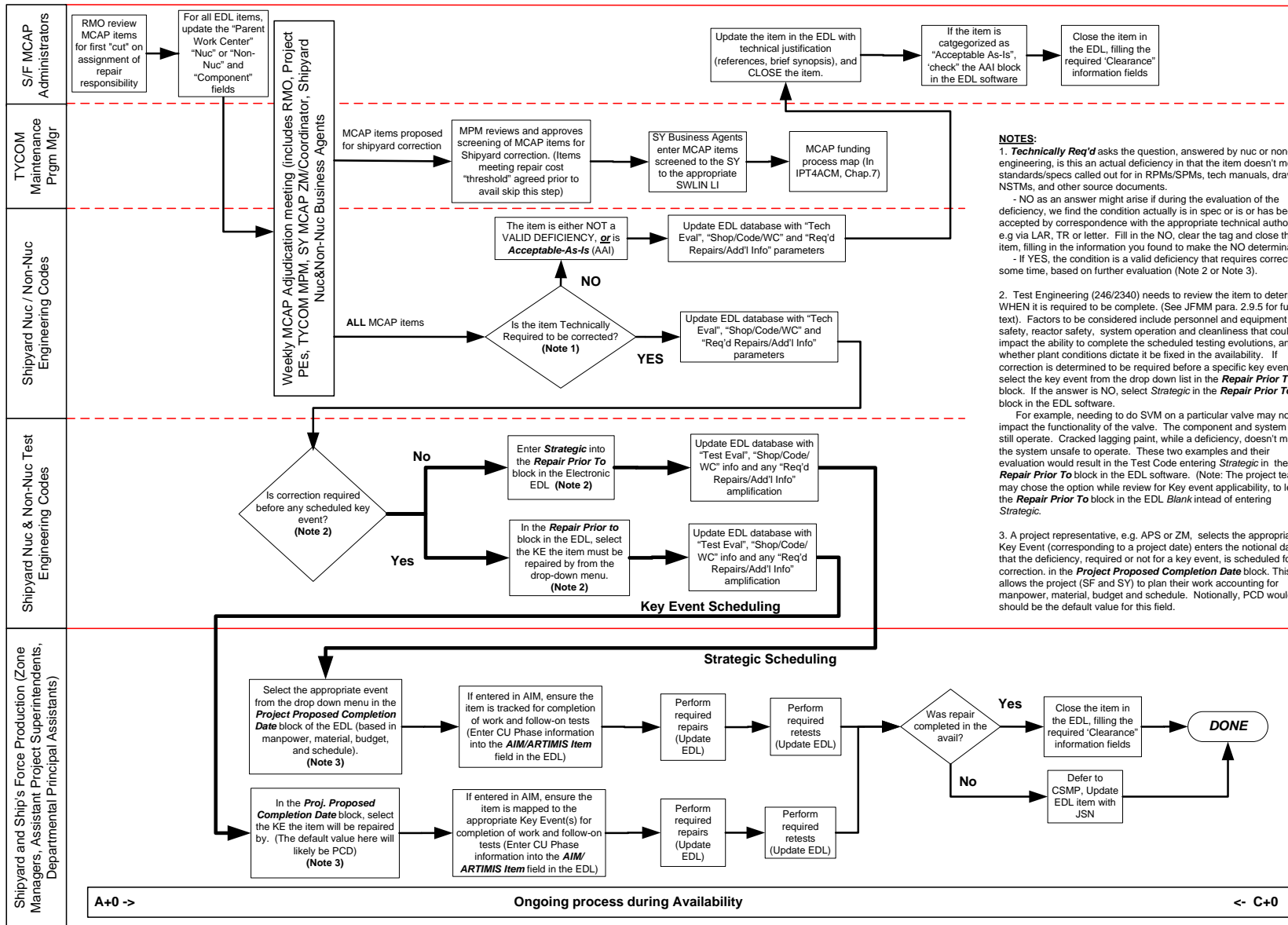

NOTES:

- Technically Req'd** asks the question, answered by nuc or non-nuc engineering, is this an actual deficiency in that the item doesn't meet standards/specs called out for in RPMs/SPMs, tech manuals, drawings, NSTMs, and other source documents.
 - NO as an answer might arise if during the evaluation of the deficiency, we find the condition actually is in spec or is or has been accepted by correspondence with the appropriate technical authority, e.g via LAR, TR or letter. Fill in the NO, clear the tag and close the item, filling in the information you found to make the NO determination.
 - If YES, the condition is a valid deficiency that requires correction at some time, based on further evaluation (Note 2 or Note 3).
- Test Engineering (246/2340) needs to review the item to determine WHEN it is required to be complete. (See JFMM para. 2.9.5 for full text). Factors to be considered include personnel and equipment safety, reactor safety, system operation and cleanliness that could impact the ability to complete the scheduled testing evolutions, and whether plant conditions dictate it be fixed in the availability. If correction is determined to be required before a specific key event, select the key event from the drop down list in the **Repair Prior To** block. If the answer is NO, select **Strategic** in the **Repair Prior To** block in the EDL software. For example, needing to do SVM on a particular valve may not impact the functionality of the valve. The component and system can still operate. Cracked lagging paint, while a deficiency, doesn't make the system unsafe to operate. These two examples and their evaluation would result in the Test Code entering **Strategic** in the **Repair Prior To** block in the EDL software. (Note: The project team may choose the option while review for Key event applicability, to leave the **Repair Prior To** block in the EDL **Blank** instead of entering **Strategic**.)
- A project representative, e.g. APS or ZM, selects the appropriate Key Event (corresponding to a project date) enters the notional date that the deficiency, required or not for a key event, is scheduled for correction, in the **Project Proposed Completion Date** block. This date allows the project (SF and SY) to plan their work accounting for manpower, material, budget and schedule. Notionally, PCD would/ should be the default value for this field.

MCAP deficiency impact on CIA execution

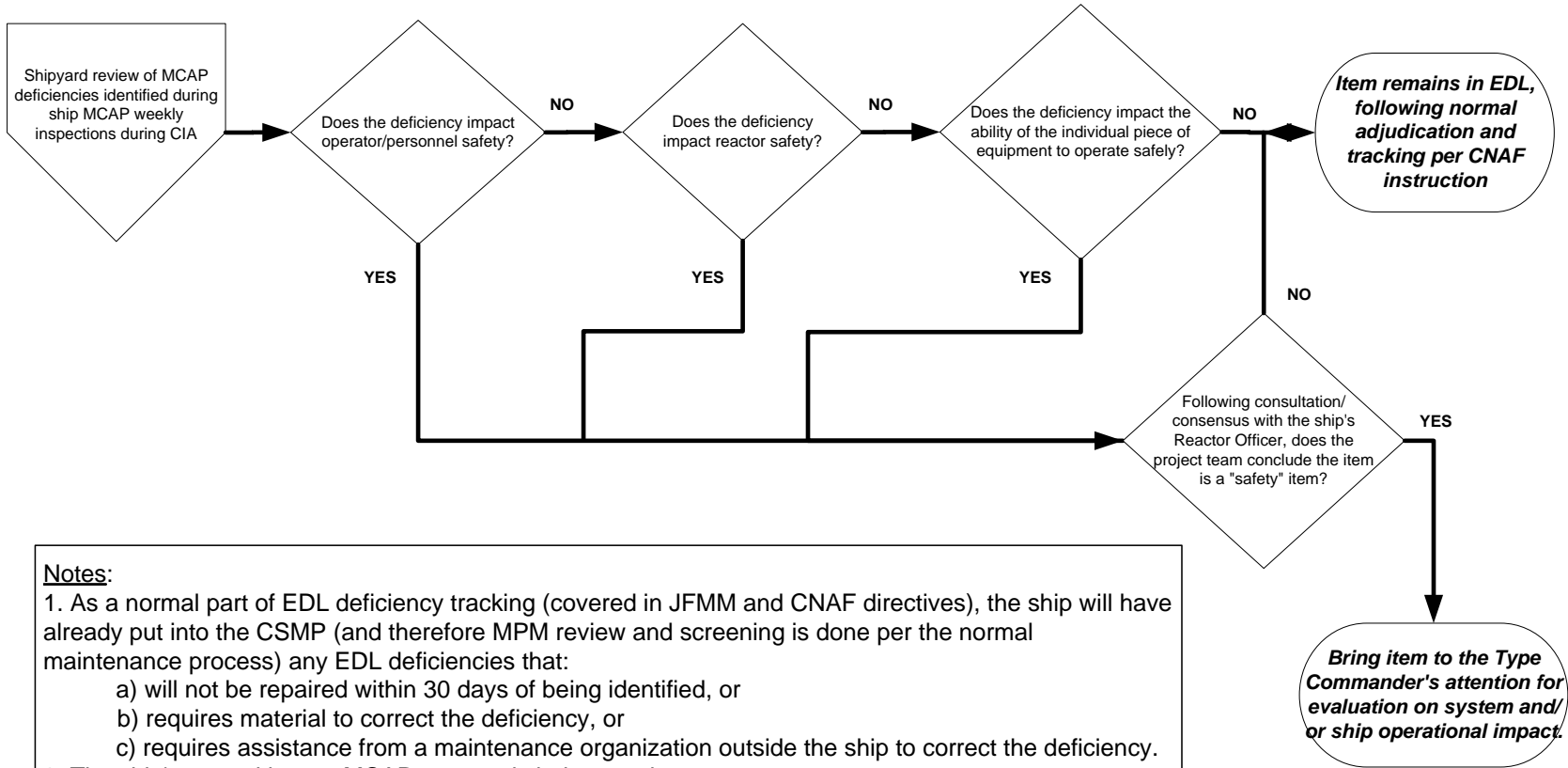

Notes:

1. As a normal part of EDL deficiency tracking (covered in JFMM and CNAF directives), the ship will have already put into the CSMP (and therefore MPM review and screening is done per the normal maintenance process) any EDL deficiencies that:
 - a) will not be repaired within 30 days of being identified, or
 - b) requires material to correct the deficiency, or
 - c) requires assistance from a maintenance organization outside the ship to correct the deficiency.
2. The ship's normal in-port MCAP process is being used.
3. The shipyard is assigned NSA roles and responsibilities for the maintenance period (CIA).
4. The shipyard's engineering and test engineering codes (246/2340) will review MCAP items identified from the weekly ship walkthroughs to determine if any items discovered require repair prior to the end of the inport maintenance period (CIA). Following consultation and consensus with the Reactor Officer/Commanding Officer, the item is brought to the attention of the Type Commander to schedule the repair and evaluate it's impact on ship's schedule.

Non-Maintenance Plant MCAP Adjudication Process Map (during a CNO availability)

II-I-VZ-II

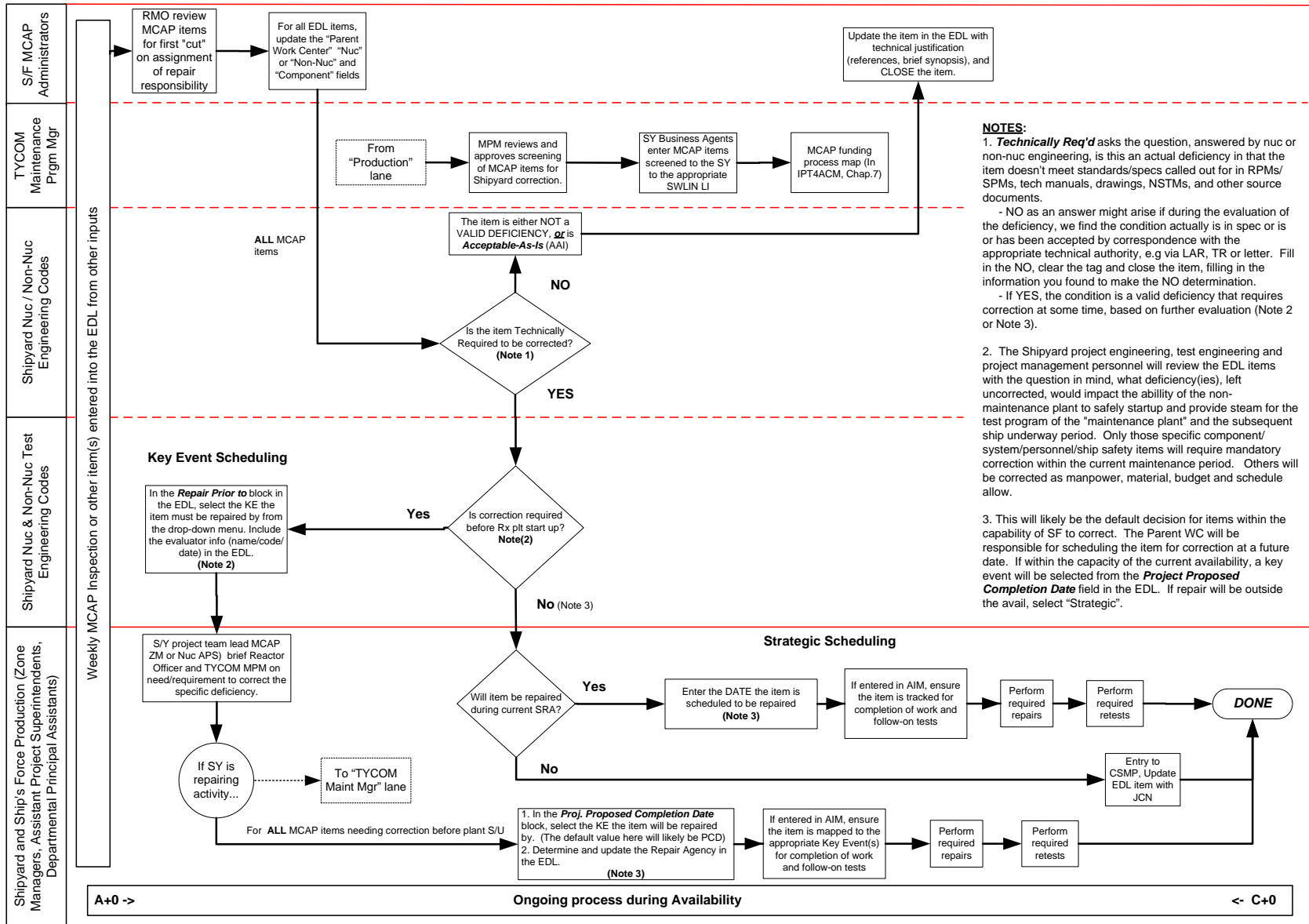

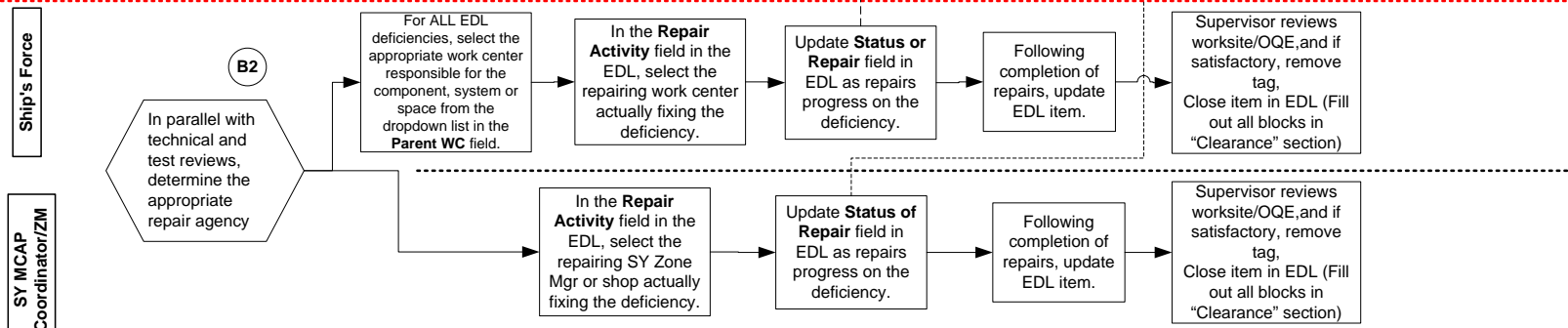
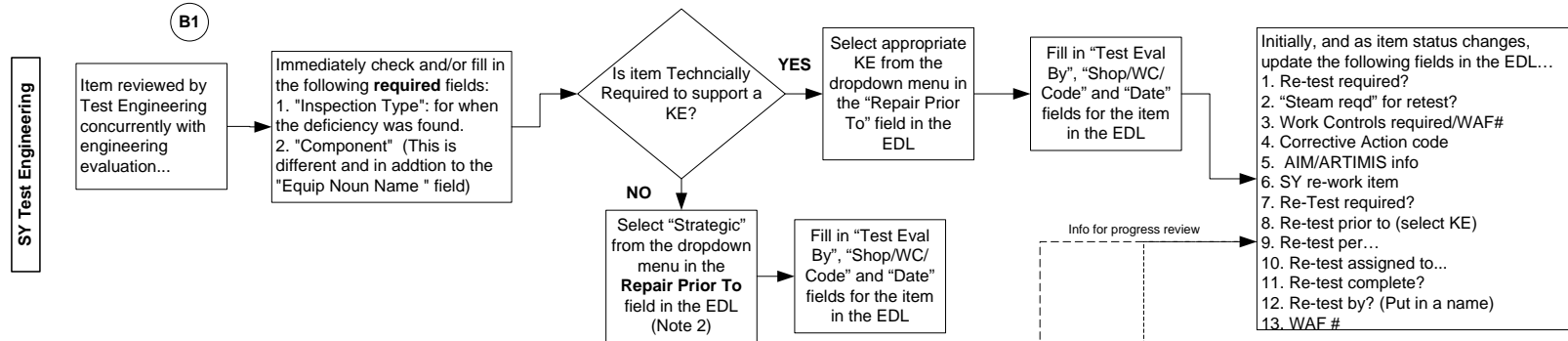
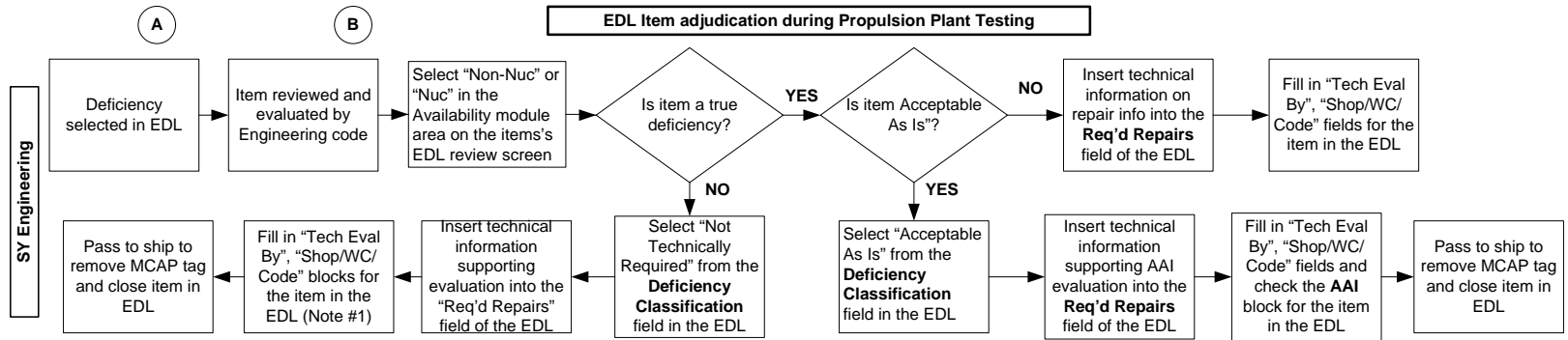

Notes:
 1. If authorized to sign as Project Engineer, check the "SY PE" review block and enter the date in the "Review" area of the EDL screen for the item being reviewed.
 2. Items coded as "Strategic" can continue to be repaired if manpower, material, budget and schedule permit.

APPENDIX B

CVN PROPULSION PLANT MATERIAL CONDITION ASSESSMENTS

			REQUIREMENT			WHO			
ASSESSMENT/ INSPECTION/ TEST	REFERENCE & PARAGRAPH # OF REQUIREMENT(S)	TYPE OF ASSESSMENT	"WHY"	WHEN	WHEN TYPICALLY CONDUCTED	PERFORMS	EVALUATES	INSPECTION/ ACCEPTANCE CRITERIA	COMMENTS
CAPS	A	OPERATIONAL TESTING	DEVELOP AWP	PRE-PRC	A-12 TO A-8	SY, SF, OTHERS AS ASSIGNED BY TYCOM	SY ENGR	A,B,C,D,E,F,G,J,K,O,W	CAPS TASKING ACCOMPLISHED VIA TYCOM LETTER
PRE-DEPLOYMENT NUCLEAR TECH ASSESSMENT	C (9020-0-g) O (3.1.1)	VISUAL ZONE INSPECTION & RECORDS REVIEW	VALIDATE AWP	POM	TYPICALLY BY A-9	SY NUC ENGR	SY NUC ENGR	A,B,C,D,E,F,G,H,O,W	
PRE-DEPLOYMENT MATERIAL CONDITION ASSESSMENT INSPECTION (MCAI)	V	VISUAL ZONE INSPECTION	MID-CYCLE ASSESSMENT OF PROP PLT MATERIAL CONDITION	PRIOR TO DEPLOYMENT	TYPICALLY 2-4 MONTHS PRIOR TO DEPLOYMENT	SF	SF	A,B,D,E,F,G,H,K,O,W	SHIPYARD TRAINING REGARDING INSPECTION ATTRIBUTES AND STANDARDS PROVIDED TO SF IN ADVANCE
PROPULSION PLANT **GROOM TEAM	P	DEFINED BY TYCOM	MAINTAIN HIGH LEVEL OF MATERIAL CONDITION	TYCOM TASKING	PERIODICALLY	RMC, CEMAT	TYCOM	B,D,E,F,G,W	GROOM TEAMS SHOULD BE REQUESTED AND ARRANGED THROUGH THE TYCOM
MACHINERY CONDITION ANALYSIS (MCA) TESTING	L, S (#), U	COMPONENT VIBRATION ANALYSIS	SUPPORT CONDITION BASED MAINTENANCE DECISIONS	PMS AS SCHEDULED. FORMAL DLI MCA VISITS PRE	PERIODICALLY THROUGHOUT CYCLE	SSNN Code 1800, SF	SSNN Code 1800, SF	B,W	
SURFACE NUCLEAR PROPULSION MOBILE TRAINING TEAM (SNPMTT)	NONE	OPERATIONAL & VISUAL	ORSE/PORSE PREPS	ROUTINE	PERIODICALLY THROUGHOUT CYCLE	TYCOM N9	TYCOM N9	A,B,D,E,F,G,W	
ORSE	M	OPERATIONAL & VISUAL	OPNAV, NRC SAFEGUARD INSPECTION	EVERY 12 PLUS OR MINUS 3 MOS	TYPICALLY DURING WORKUPS AND RETURN FROM DEPLOYMENT	NPEB	NPEB	A,B,D,E,F,G,W	
INSURV	N, Q	OPERATIONAL & VISUAL (MI)	LIFECYCLE ASSESSMENT	36 - 54 MOS	AS SCHEDULED	BOARD OF INSPECTION AND SURVEY	BOARD OF INSPECTION AND SURVEY	B,D,E,F,G,N,W	
NON-NUCLEAR POINT-OF- ENTRY TESTING (POET)	R	COMPONENT VISUAL INSPECTION & OPERATIONAL TESTING	VALIDATES AWP & COMPONENT RELIABILITY TO SUPPORT CRITICALITY	PRE- AVAILABILITY	RETURN TRANSIT FROM DEPLOYMENT (A-2 TO A-4)	SY ENGINEERING AND PROJECT TEAM MEMBERS WITH ASSISTANCE FROM SF	SY ENGR	A,B,D,F,J,K,W	SOME GROOMING PERFORMED DURING POET
POST-DEPLOYMENT NUCLEAR TECH ASSESSMENT	C (9020-0-g) O (3.1.1)	VISUAL ZONE INSPECTION & RECORDS REVIEW	VALIDATE AWP	PRE- AVAILABILITY	AFTER RETURN FROM DEPLOYMENT	SY NUC ENGR	SY NUC ENGR	A,B,C,D,E,F,G,H,O,W	
NON-NUCLEAR TECH ASSESSMENT	K (4.a.(1)(a))	VISUAL ZONE INSPECTION & RECORDS REVIEW	VALIDATE AWP	PRE- AVAILABILITY	AFTER RETURN FROM DEPLOYMENT	SY ENGR	SY ENGR	A,B,D,F,J,K,W	
PRE-AVAIL MATERIAL CONDITION ASSESSMENT INSPECTION (MCAI)	C (9020-0-g) O (3.6) K (4.a.(1)(b))	VISUAL ZONE INSPECTION	IDENTIFY DEFICIENCIES FOR EARLY INCLUSION IN THE AWP	LESS THAN 90 DAYS PRIOR TO AVAILABILITY START	TYPICALLY AFTER RETURN FROM DEPLOYMENT	TEAM OF SF AND SY PROJ TM MEMBERS, ENGINEERS, NUCLEAR INSPECTORS	SY ENGR	A,B,C,D,E,F,G,H,K,O,W	
PMS	A, S	VARIOUS	MAINTAIN MATERIAL CONDITION	CONTINUOUS	CONTINUOUS	SF	SF	A,S,W	
NUCLEAR PRETEST INSPECTION	C (9020-0-g) O (3.1.1.(2))	VISUAL OF WORK PERFORMED	CERTIFY READINESS FOR TESTING	PRE-TEST	DURING AVAIL	SY NUC INSPECTORS	SY NUC ENGR	A,B,C,D,E,F,G,H,W	

II-1-2B-1

COMUSFLTFORCOMINST 4790.3 REV C

			REQUIREMENT		WHO				
ASSESSMENT/ INSPECTION/ TEST	REFERENCE & PARAGRAPH # OF REQUIREMENT(S)	TYPE OF ASSESSMENT	"WHY"	WHEN	WHEN TYPICALLY CONDUCTED	PERFORMS	EVALUATES	INSPECTION/ ACCEPTANCE CRITERIA	COMMENTS
NON-NUCLEAR PRETEST INSPECTION	K (4.a.(1)(c))	VISUAL OF WORK PERFORMED	CERTIFY READINESS FOR TESTING	PRE-TEST	DURING AVAIL	SY ENGR	SY ENGR	A,B,D,E,F,G,H,K,W	
PORSE	T (6.a)	VISUAL ZONE INSPECTION & RECORD REVIEW	OPNAV, NRC SAFEGUARD	PRE-CRIT DURING AVAILS SKED GREATER THAN 6 MONTHS	PRIOR TO REACTOR START-UP DURING AVAILS SKED GREATER THAN 6 MONTHS	NPEB	NPEB	A,B,D,E,F,G,W	
NUCLEAR/NON-NUCLEAR PRE-EVENT INSPECTIONS	C (9020-0-g) O (3.7.3) K (4.a.(1)(d))	VISUAL ZONE INSPECTION	VALIDATES PROPULSION PLANT MATERIAL CONDITION FOR AVAIL KEY EVENTS	PRIOR TO HOT OPS/NON-CRIT STEAMING	TYPICALLY AFTER PRODUCTION COMPLETION DATE (PCD)	TEAM OF SF AND SY PROJ TM MEMBERS, ENGINEERS, NUCLEAR INSPECTORS	SY ENGR	A,B,C,D,E,F,G,H,K,O,W	
NUCLEAR/NON-NUCLEAR PRE-CRITICALITY CERTIFICATION	C (9020-0-g) O (3.7) K (4.a.(1)(d))	VISUAL ZONE INSPECTION	VALIDATES PROPULSION PLANT READY FOR CRITICAL OPERATIONS	PRE-CRIT, POST NON CRIT STEAMING	PRIOR TO CRIT	TEAM OF SF AND SY PROJ TM MEMBERS, ENGINEERS, NUCLEAR INSPECTORS	SY ENGR	A,B,C,D,E,F,G,H,K,O,W	
NRRO PRE-EVENT/PRE- CRITICALITY WALKTHROUGHS	NONE	VISUAL ZONE INSPECTION	VALIDATE PROPULSION PLANT READY TO SUPPORT ASSOCIATED KEY EVENT	UPON PROJECT TEAM DETERMINATION THAT PROP PLANT IS READY FOR ASSOCIATED KEY EVENT	TYPICALLY 2 DAYS PRIOR TO KEY EVENT	NRRO REPS	NRRO/SY ENGR	A,B,C,D,E,F,G,H,K,O,W	A SY SENIOR MGMT WALKTHROUGH MAY BE SCHEDULED BETWEEN THE PRE-EVENT CERTIFICATION AND THE NRRO WALKTHROUGHS
AVAILABILITY PERIODIC ZONE ASSESSMENTS	O (3.7.4) K	VISUAL ZONE INSPECTION	ENSURE CONTINUOUS IDENTIFICATION AND CORRECTION OF PROP PLT DEFICIENCIES TO SUPPORT DOWNSTREAM KEY EVENTS	AT PERIODICITY TO BE DETERMINED BY THE PROJECT TEAM	COMMENCE AT AVAILABILITY START AND SCHEDULED PERIODICALLY UNTIL 2-3 WEEKS PRIOR TO PRODUCTION COMPLETION DATE (PCD)	TEAM OF SF AND SY PROJ TM MEMBERS, ENGINEERS, NUCLEAR INSPECTORS AS APPROPRIATE	SY ENGR	A,B,C,D,E,F,G,H,K,O,W	

References:

- | | |
|---|---|
| A) NAVSEA 0989-026-1000 | L) SSNN Code 1800 Tasking Letter, 4710 |
| B) Component Technical Manuals | M) OPNAVINST 3540.3 |
| C) NAVSEA 0989-043-0000 | N) INSURVINST 4730.1 |
| D) Various System Diagrams & Piping Plans | O) NAVSEA 0989-062-4000 |
| E) NAVSEA Instructions (9210.18, 9210.36, Etc.) | P) COMUSFLTFORCOMINST 4790.3, Volume VI, Chapter 42 |
| F) Military Standards (MIL-STD-767, MIL-STD-2041, Etc.) | Q) COMUSFLTFORCOMINST 4790.3, Volume IV, Chapter 26 |
| G) NAVSEA Manuals 389-0317, 250-1500-1, 389-0288, 0989-150-0000 | R) NAVSEA S9092-AC-ADM-010 |
| H) Off-Yard Correspondence | S) NAVSEAINST 4790.8/OPNAVINST 4790.4 |
| I) OPNAVINST C9210.2 | T) OPNAVINST 9080.3 |
| J) NAVSEA 0989-036-0000 | U) COMUSFLTFORCOMINST 4790.3, Volume II, Part I, Chapter 2, Paragraph 2.4.4 |
| K) NAVSEAINST 4730.2 | V) COMUSFLTFORCOMINST 4790.3, Volume II, Part I, Chapter 2, Paragraph 2.9.3.2.a |
| | W) COMUSFLTFORCOMINST 4790.3, Volume II, Part I, Chapter 2, Paragraph 2.9.5 |

** INCREMENTAL MAINTENANCE PLAN (IMP) MANUAL SHOWS RECOMMENDED GROOM TIMELINE
MCA COVERED BY PMS, e.g.: MIP 2550/003-76 FOR MAIN FEED PUMPS, SYSCOM MRC 84 C1ZQ N APPLIES

APPENDIX C

**SYSTEM CERTIFICATION CHECKLIST
FOR CNO AVAILABILITY KEY EVENTS
(AIRCRAFT CARRIERS ONLY)**

PURPOSE: This checklist is provided as a guide during CNO Availabilities when reference (r) is invoked for determination of system readiness to support execution of a Key Event. This checklist may also be used outside of availabilities to determine system readiness to support ship operations.

NOTE: THIS CHECKLIST IS FOR USE TO CERTIFY SYSTEMS/COMPONENTS LISTED IN REFERENCE (r) ENCLOSURES (1) THROUGH (3) WHERE SHIPYARD RESPONSIBLE WORK WAS NOT PERFORMED IN ORDER TO MAKE SIGNATURES ON KEY EVENT PREREQUISITE LISTS. SPECIFIC ATTRIBUTES ARE LISTED IN REFERENCE (r) ENCLOSURE (4) AS A GUIDE.

System _____

Attribute	Yes/No
AWP reviewed to ensure all authorized work has been performed and any incomplete work (adjudicated at the appropriate supervisory level) does not affect certification.	
EDL, CSMP, Nuc and Non-Nuc DR Logs and DFS Log reviewed for unresolved deficiencies.	
WAF Log reviewed to ensure all authorized work is completed, tested or ready for testing.	
CWPs and FWPs reviewed for accuracy and completeness.	
Preventive maintenance complete and up to date (i.e., SU maintenance complete, PMS within periodicity).	
All standing orders, including temporary standing orders in effect for system, have been reviewed and adjudicated by the JTG.	
<p>NOTE: THE INTENT OF THIS STEP IS FOR THE ZONE MANAGER AND PRINCIPAL ASSISTANT TO DETERMINE WHICH SYSTEM OR PORTIONS OF A SYSTEM/CIRCUIT REQUIRE AN INSPECTION USING HISTORICAL FAILURES AND TESTING TO BE PERFORMED.</p> <p>System inspection, based on history and deficiencies noted, completed and operating deficiencies resolved.</p>	
Instrument (i.e., gages, pressure/temperature switches, meters) calibration is within periodicity and will not expire within two months of ship delivery.	
Operating logs are updated and approved for configuration changes/modifications.	
System/component safety features are set, tested and operational and all automatic controls necessary to support the planned testing are calibrated, tested and operational.	

(This Page Intentionally Left Blank)

APPENDIX D

SCOPE OF VISUAL INSPECTIONS OF REACTOR PLANT FLUID SYSTEMS

INSULATION	<ul style="list-style-type: none"> - Wetted - Damaged - Missing
HANGERS	<ul style="list-style-type: none"> - Installed hangers are connected/welded and not damaged - Verify correct thread engagement on fasteners - Liners are acceptable
PIPING AND COMPONENTS	<ul style="list-style-type: none"> - Leakage - Arc strikes - Significant surface discontinuities - Corrosion/pitting - Dents, bends, visible cracks - Missing/damaged locking devices - Soundshorts (if applicable) - Missing/damaged/incorrect label plates - Proper clearance between vent and drain lines and associated funnels, funnel misalignment and clogged screens - Damaged or out of calibration gages and thermometers - Inadequate preservation - Foreign material on outside of piping/components
MECHANICAL CONNECTIONS	<ul style="list-style-type: none"> - Leaks - Missing or loose fasteners - Incorrect material (e.g., dissimilar materials) - Proper thread engagement - Misaligned flanged joints
VALVES	<ul style="list-style-type: none"> - Missing or damaged valve caps or vent plugs - Leaks - Loose, missing or non-functional handwheels - Damaged valve position indicators - Missing or damaged fasteners - Permanent identification of handwheels by system number and color coding (if required) - Bent stems - Packing glands with little or no remaining adjustment - Cocked packing glands - Corrosion
FOUNDATIONS	<ul style="list-style-type: none"> - Obvious damage - Corrosion/cracks - Integrity of attachment welds - Missing/loose fasteners and/or locking devices

II-1-2D-1

COMUSFLTFORCOMINST 4790.3 REV C

LOCKING DEVICES	<ul style="list-style-type: none">- Damaged, where installed- Serve intended function
SHIELDING	<ul style="list-style-type: none">- Damaged shielding- Damaged or missing radiation area exclusion barriers (if applicable)- Corrosion/leaking of canning plate materials- Damaged viewing windows or periscopes- Missing/loose fasteners

APPENDIX E

FIRST 100 HOURS FOR SURFACE FORCE SCHEDULED AVAILABILITY

Prior to 100 hrs	Transition day	24 hours	48 hours	72 hours	100 hours
Pre-Availability	A	A+1	A+2	A+3	A+4
<p>ISIC, TYCOM, NSA/LMA and Ship will coordinate 100 hour plan.</p> <p>CMAV - discuss 100 Hour Plan at WPER.</p> <p>CNO Avail - discuss 100 Hour Plan at WPER.</p> <p>Jobs requiring ship checks will be listed in the Availability Planning Message.</p> <p>Provide S/F with Executive Level IMA schedule.</p> <p>Establish Pre-arrival Tag-out, WAF & work control plan.</p> <p>Discuss "Early Start" work items at WPER (if applicable).</p> <p>Develop IEM plan (NSA&S/F).</p>	<p>Arrival Conference (100 Hour clock starts).</p> <p>Availability commences. Submit Availability Start Message</p> <p>Conduct Tag-out audit.</p> <p>Establish Plant Conditions.</p> <p>Establish working hours and implement work controls.</p> <p>Execute developed plan and place required equipment/ systems into IEM status.</p> <p>Brief all critical path jobs (jobs that may take entire avail to complete)</p> <p>Conduct S/F availability safety training.</p>	<p>Establish Plant Conditions (cont'd).</p> <p>Implement work controls (cont'd).</p> <p>Place required equipment/systems into IEM status.</p> <p>Test forms required for S/F retest of FMA work will be delivered to the ship for S/F review.</p> <p>Establish authorized S/F personnel to sign off equipment testing</p> <p>Confirm weekly progress meetings and times with S/F and contractor management</p>	<p>Establish Plant Conditions (cont'd).</p> <p>Implement work controls (cont'd).</p> <p>Place required equipment/ systems into IEM status.</p> <p>Test forms required for S/F retest of FMA work will be delivered to the ship for S/F review.</p>	<p>Establish Plant Conditions (cont'd).</p> <p>Implement work controls (cont'd).</p> <p>Place required equipment /systems into IEM status.</p> <p>Brief all critical path jobs - FINAL.</p>	<p>Availability continues.</p>

(This Page Intentionally Left Blank)

APPENDIX F

FINAL 100 HOURS FOR SURFACE FORCE SCHEDULED AVAILABILITY

Prior to 100 hrs	96 hours	72 hours	48 hours	24 hours	Transition day
Pre-Sea Trials	Sea Trials - 4	Sea Trials - 3	Sea Trials - 2	Sea Trials - 1	Sea Trials
Production work complete.	Pre-under ways.	Pre-under ways.	Commence Pre-under ways for all +48hr and sooner Pre-under ways.	Pre-under ways.	Pre-under ways complete.
Production work Testing complete.	MLOCs.	MLOCs.		MLOCs.	MLOCs complete.
Pre-under ways.	Tagout Log Audit.	Fast Cruise.	MLOCs.	Complete Fast Cruise.	
MLOCs.	Operational Systems Testing.	Complete Dock Trials.		Crew rest and final admin.	List of Operational Testing that requires Performance at Sea.
WAF closeout.	Crew watchbills and berthing bills complete.	WAF closeout and Final Audit.			
Production related temp services removed.					
Commence Dock Trials.					

(This Page Intentionally Left Blank)

VOLUME II

PART I

CHAPTER 3

CHIEF OF NAVAL OPERATIONS SCHEDULED MAINTENANCE AVAILABILITIES

REFERENCES.

- (a) Integrated Project Teams for Aircraft Carrier Maintenance Handbook
- (b) NAVSEA S9AA0-AB-GOS-030 - General Specifications for Overhaul of Surface Ships (GSO) AEGIS Supplement
- (c) NAVSEA 0989-LP-043-0000 - Commissioned Surface Ship General Reactor Plant Overhaul and Repair Specifications
- (d) NAVSEA 0989-LP-037-2000 - Commissioned Submarine General Reactor Plant Overhaul and Repair Specifications
- (e) OPNAVNOTE 4700 – Representative Intervals, Durations, Maintenance Cycles, and Repair Mandays for Depot Level Maintenance Availabilities of U.S. Navy Ships
- (f) OPNAVINST 4700.38 - Berthing and Messing During CNO Scheduled Maintenance Availabilities
- (g) OPNAVINST 3120.32 - Standard Organization and Regulations of the U.S. Navy
- (h) OPNAVINST C3000.5 - Operation of Naval Nuclear Powered Ships
- (i) COMSUBLANT/COMSUBPACNOTE C3120 - Submarine Operating Restrictions and Depth Authorizations
- (j) OPNAVINST 3120.33 - Submarine Extended Operating Cycle (SEOC) Program
- (k) NAVSEA S9086-7G-STM-010 - NSTM Chapter 997 (Docking Instructions and Routine Work in Dry Dock)
- (l) NAVSEAINST 4441.2 - Changes to Coordinated Shipboard Allowance List (COSAL); Procedures for
- (m) COMNAVAIRLANTINST 9090.2 - Conduct of Shipyard Trials and Inspections Incident to Service Life Extension Program (SLEP), Overhauls or Availabilities of Conventionally Powered Aircraft Carriers
- (n) COMNAVSURFLANT/COMNAVSURFPACINST 3502.2 - Surface Force Training Manual
- (o) COMNAVAIRLANT/COMNAVAIRPACINST 3500.20 - Aircraft Carrier Training and Readiness Manual
- (p) NAVSEA S9095-AD-TRQ-010/TSTP - Total Ship Test Program Manual
- (q) COMNAVAIRLANTINST 9080.2 - Conduct of Trials and Inspections Incident to Construction, Overhauls or Availabilities of Nuclear Powered Aircraft Carriers (CVN)
- (r) OPNAVINST 9080.3 - Procedures for Tests and Trials of Navy Nuclear Powered Ships Under Construction, Modernization, Conversion, Refueling and Overhaul
- (s) OPNAVINST 3540.3 - Naval Nuclear Propulsion Examining Boards
- (t) OPNAVINST C9210.2 - Engineering Department Manual for Naval Nuclear Propulsion Plants
- (u) COMNAVSUBFOR OPORD 2000
- (v) NAVSEA S9086-DA-STM-000 - NSTM Chapter 100 (Hull Structures)
- (w) NAVSEA S9086-C4-STM-000 - NSTM Chapter 094 (Trials)
- (x) NAVSEA 0924-062-0010 - Submarine Safety (SUBSAFE) Requirements Manual
- (y) COMNAVSUBFORINST 5400.25 - Standard Submarine Supply Department Organization and Regulations Manual
- (z) COMNAVSUBFORINST 5400.29 - Standard Submarine Navigation/Operations Department Organization and Regulations Manual
- (aa) COMNAVSUBFORINST 5400.40 - Standard Submarine Combat Systems Department Organization and Regulations Manual (SSN)
- (ab) COMNAVSUBFORINST 5400.41 - Standard Submarine SSBN 726 Class Weapons Department Organization and Regulations Manual
- (ac) COMNAVSUBFORINST 5400.47 - Standard Submarine Combat Systems Department Organization and Regulations Manual (SSGN)
- (ad) COMNAVSUBFORINST C3500.2 - Continuous Training Manual
- (ae) OPNAVINST 9110.1 - Submarine Test and Operating Depths; Policy Concerning
- (af) COMSUBLANTINST 5400.4 - Submarine Force, U.S. Atlantic Fleet Regulations

- (ag) COMSUBPACINST 5400.7 - Submarine Force, U.S. Pacific Fleet Regulations
- (ah) COMLANTFLT OPOD 2000/COMPACFLT OPOD 201
- (ai) NAVSEAINST C9094.2 - Submarine Valve Operation Requirements for Builders and Post Overhaul Sea Trial Test Dives
- (aj) NAVSEA T9044-AD-MAN-010 - Requirements Manual for Submarine Fly-By-Wire Ship Control Systems
- (ak) NAVSEAINST 4790.8/OPNAVINST 4790.4 - Ships' Maintenance and Material Management (3-M) Manual
- (al) NAVSEAINST C9210.30 - Procedures for Administration of Nuclear Reactor Plant Preventive Maintenance and Tender Nuclear Support Facilities Preventive Maintenance on Ships
- (am) SSPINST 5600.11 - Preventive Maintenance Management Program for Strategic Weapon Systems Equipments and Associated Material
- (an) NAVSEA S9AA0-AB-GOS-010 - General Specifications for Overhaul of Surface Ships (GSO) 2004 Edition
- (ao) NAVSEA S9086-TX-STM-010 - NSTM Chapter 583 (Boats and Small Craft)
- (ap) NAVSEA S9086-G9-STM-000 - NSTM Chapter 231 (Propulsion and SSTG Steam Turbines)
- (aq) NAVSEA S9086-GY-STM-010 - NSTM Chapter 221 (Boilers)
- (ar) NAVSEA S9086-HN-STM 010 - NSTM Chapter 244 (Propulsion Bearings and Seals)
- (as) NAVSEA S9086-HK-STM-010 - NSTM Chapter 241 (Propulsion Reduction Gears, Couplings, Clutches and Associated Components)
- (at) NAVSEA S9086-TV-STM-010 - NSTM Chapter 581 (Anchoring)
- (au) NAVSEA S9086-RK-STM-010 - NSTM Chapter 505 (Piping Systems)
- (av) NAVSEA S9086-TA-STM-010 - NSTM Chapter 562 (Surface Ship Steering)
- (aw) NAVSEA S9086-TD-STM-010 - NSTM Chapter 565 (Surface Ship Stabilizing Systems)
- (ax) CNAFINST 3500.71 - Flight Deck Certification
- (ay) NAVSEA 0989-064-3000 - Cleanliness Requirements for Nuclear Propulsion Plant Maintenance and Construction
- (az) OPNAVINST 4700.7 - Maintenance Policy for U.S. Naval Ships
- (aba) COMLANTFLTINST 5400.2 - U.S. Atlantic Fleet Regulations
- (bb) COMPACFLTINST 5400.3 - U.S. Pacific Fleet Regulations
- (bc) OPNAVINST 3540.4 - Propulsion Examining Boards for Conventionally Powered Ships
- (bd) OPNAVNOTE 5400 - DNS-33/10U229822 of 16 Sep 10
- (be) NAVSEAINST 5400.95 - Waterfront Engineering and Technical Authority Policy
- (bf) NAVSEAINST 5450.142 - Mission and Function of the Surface Ship Life Cycle Management Activity

LISTING OF APPENDICES.

- A Typical CNO Availability Planning Milestones (Submarines Only)
- B Typical CNO Availability Planning Milestones (Surface Force Only)
- C Typical CNO Availability Planning Milestones (Aircraft Carriers Only)
- D Suggested Guidelines for Forces Afloat Review of Availability Work Packages
- E Monitoring Procedures (Surface Force Ships and Aircraft Carriers)
- F₁ SITREP/Progress Report (Aircraft Carriers Only)
- F₂ SITREP/Progress Report (Surface Force Ships Only)
- G Sample New Work Forwarding Letter and Index
- H Suggested Message Format for a New Work Candidate
- I Minimum Dock Trials Requirements (Surface Force Ships and Aircraft Carriers)
- J Minimum Fast Cruise Requirements (Surface Force Ships and Aircraft Carriers)
- K Minimum Tests to be Performed During Sea Trials (Surface Force Ships and Aircraft Carriers)
- L Minimum Dock Trials Requirements (Submarines Only)
- M Minimum Fast Cruise Requirements (Submarines Only)
- N Minimum Sea Trials Requirements for Chief of Naval Operations Availabilities Less Than Six Months Duration (Submarines Only)
- O Minimum Sea Trials Requirements for Chief of Naval Operations Availabilities Greater Than Six Months Duration (Submarines Only)
- P Summary of Significant Post Repair Sea Trial Requirements (Submarines Only)

- Q Applicable RMC Availability Completion Certification Sheet (Surface Force Ships Only)
- R Availability Quality Management Plan (QMP) (Surface Force Ships Only)

SAMPLE MESSAGES FOR CNO SCHEDULED AVAILABILITIES (SURFACE SHIPS ONLY)

- AA Sample Ship's Request for Permission to Commence Fast Cruise (Surface Force Ships and Aircraft Carriers)
- AB Sample Ship's Report of Fast Cruise Completion (Surface Force Ships and Aircraft Carriers)
- AC Sample Supervising Authority Readiness for Sea Trial Message (Surface Force Ships and Aircraft Carriers)
- AD Sample Prime Contractor Availability Key Event Readiness Certification Memorandum (Surface Force Ships Only)
- AE Sample Fleet Maintenance Activity Availability Key Event Readiness Certification Memorandum (Surface Force Ships Only)
- AF Sample Naval Shipyard Availability Key Event Readiness Certification Memorandum (Surface Force Ships Only)
- AG Sample Alteration Installation Team Availability Key Event Readiness Certification Memorandum (Surface Force Ships Only)
- AH Sample Ship's Force Availability Key Event Readiness Certification Memorandum (Surface Force Ships Only)
- AI Sample Quality Assurance Availability Key Event Readiness Certification Memorandum (Surface Force Ships Only)
- AJ Sample Final Availability Key Event Readiness Certification Memorandum (Surface Force Ships Only)
- AK Branding Category (CAT) A Change Deferral Process (Surface Force Ships Only)
- AL BAWP Change Deferral Request (SAMPLE)
- AM Availability Planning Conference Agenda Sample (Surface Force Ships Only)
- AN BAWP Work Item Branding Categories (Surface Force Ships Only)
- AO BAWP to AWP Process (Surface Force Ships Only)

SAMPLE MESSAGES FOR CNO SCHEDULED AVAILABILITIES OF LESS THAN SIX MONTHS IN DURATION (SUBMARINES ONLY)

- BA Sample TYCOM Message Concerning Escort Services
- BB Sample ISIC Message to TYCOM Concerning Crew Certification and Material Condition for Fast Cruise and Sea Trials
- BC Major Trial and Inspection Milestones
- BD Sample TYCOM Message to Ship Concerning Sea Trials Depth Authorization
- BE Sample Ship Message to TYCOM Concerning Readiness for Follow-On Sea Trials
- BF Sample ISIC Message to TYCOM Concerning Material Certification for Follow-On Sea Trials
- BG Sample TYCOM Message to Ship Concerning Follow-On Sea Trials Depth Authorization
- BH Sample Ship Message to ISIC Concerning Readiness for Fast Cruise
- BI Sample ISIC Message to Ship Authorizing Commencement of Fast Cruise
- BJ Sample Ship Message to ISIC and TYCOM Concerning Readiness for Sea Trials
- BK Sample ISIC Message to TYCOM Concerning Final Material Certification Prior to Sea Trials
- BL Sample Ship Message to ISIC and TYCOM Concerning Material Certification Upon Completion of Sea Trials
- BM Submarine Sea Trial Situation Report (SITREP)
- BN Sample Message Concerning Mod Alert Notification
- BO Sample TYCOM Message to Ship Concerning URO for Industrial Activity Availabilities Less Than Six Months in Duration
- BP Message Scenario for CNO Availabilities of Less than Six Months in Duration
- BQ Sample ISIC Message to TYCOM Concerning Fly-By-Wire Crew Certification and Fly-By-Wire Material Condition for At-Sea Testing or Fast Cruise and Sea Trials
- BR Sample TYCOM Message to Ship Concerning Authorization to Use Fly-By-Wire Ship Control Systems
- BS Sample ISIC Message to TYCOM Concerning Fly-By-Wire Material Certification upon Completion of At-Sea Testing or Sea Trials
- BT Sample TYCOM Message to Ship Concerning URO for Fly-By-Wire Ship Control Systems

SAMPLE MESSAGES FOR CNO SCHEDULED AVAILABILITIES OF GREATER THAN SIX MONTHS IN DURATION (SUBMARINES ONLY)

- CA Sample SRDRS Support Services Message
- CB Sample ISIC Message to TYCOM Concerning Crew Certification
- CC Major Trial and Inspection Milestones
- CD Sample TYCOM Message to Ship Concerning Completion Prerequisites
- CE Sample TYCOM Message to NAVSEA Concerning Fast Cruise and Critical Reactor Operations
- CF Sample TYCOM Message to Ship Concerning Sea Trials Depth Authorization
- CG Sample TYCOM Message to Ship Concerning URO
- CH Sample ISIC Message to TYCOM Concerning Material Certification Prior to Sea Trials
- CI Sample ISIC Message to TYCOM Concerning Material Certification upon Completion of Sea Trials
- CJ Sample Ship Message to TYCOM Concerning Readiness for Fast Cruise
- CK Sample Ship Message to TYCOM Concerning Readiness for Sea Trials
- CL Sample TYCOM Message Concerning Resumption of Sea Trials Completion Prerequisites
- CM Sample ISIC Message to TYCOM Concerning Material Certification for Follow-On Sea Trials
- CN Sample Ship Message to TYCOM Concerning Readiness for Follow-On Sea Trials
- CO Sample TYCOM Message to Ship Concerning Follow-On Sea Trials Depth Authorization
- CP Submarine Sea Trial Situation Report (SITREP)
- CQ Sample Message Concerning Mod Alert Notification
- CR Message Scenario for CNO Availabilities of Greater than Six Months in Duration
- CS Sample NAVSEA Message to TYCOM Concerning Fly-By-Wire Ship Control Systems Material Condition Readiness for Sea Trials
- CT Sample TYCOM Message to Ship Concerning Authorization to Use Fly-By-Wire Ship Control Systems
- CU Sample ISIC Message to TYCOM Concerning Fly-By-Wire Material Certification Upon Completion of At-Sea Testing or Sea Trials
- CV Sample TYCOM Message to Ship Concerning URO for Fly-By-Wire Ship Control Systems

3.1 PURPOSE. This chapter provides guidance in support of advanced planning, pre planning, execution and close out of Chief of Naval Operations (CNO) Scheduled Maintenance Availabilities. The implementation of policies as set forth in references (a) through (bf) provide additional guidance as required. Requirements listed here apply unless otherwise approved by Naval Sea Systems Command (NAVSEA). Where differences may exist, NAVSEA requirements take precedence.

3.2 CHIEF OF NAVAL OPERATIONS SCHEDULED MAINTENANCE AVAILABILITIES.

- a. Chief of Naval Operations (CNO) scheduled maintenance availabilities greater than six months in duration are:
 - (1) Overhaul. An availability scheduled for accomplishment of industrial maintenance and modernization. Types of availabilities include:
 - (a) Regular Overhaul.
 - (b) Complex Overhaul.
 - (c) Engineered Overhaul.
 - (d) Refueling Overhaul.
 - (e) Refueling Complex Overhaul.
 - (f) Engineered Refueling Overhaul.
 - (2) Other availabilities. An availability scheduled primarily for industrial maintenance and installation of major, high priority alterations. Types of these availabilities include:
 - (a) Depot Modernization Period.
 - (b) Planned Incremental Availability.

- (c) Docking Planned Incremental Availability.
 - (d) Extended Drydocking Phase Maintenance Availability.
 - (e) Post Shakedown Availability.
 - (f) Carrier Incremental Availabilities.
- b. CNO scheduled maintenance availabilities less than six months in duration. Short, labor intensive availabilities scheduled for accomplishment of industrial maintenance and modernization. Types of these availabilities include:
- (1) Selected Restricted Availability (SRA).
 - (2) Docking SRA.
 - (3) Phased Maintenance Availability (PMA).
 - (4) Docking Phased Maintenance Availability.
 - (5) Service Craft Overhaul.
 - (6) Extended SRA.
 - (7) Extended Docking SRA.
 - (8) Incremental SRA.
 - (9) Extended Refit Period.
 - (10) Post Shakedown Availability.
 - (11) Pre-Inactivation Restricted Availability (PIRA)

3.2.1 Early Start. An “early start” is defined as that time when ships or submarines are made available by Type Commanders (TYCOM) for the execution of maintenance/modernization, including dry-docking, prior to a scheduled CNO availability start date.

3.2.2 Early Start Concurrence. The Naval Supervisory Authority (NSA) (e.g., Naval Shipyard, Ship Repair Facility, Regional Maintenance Center, Supervisor of Shipbuilding (SUPSHIP)) shall request an “early start” period via Naval Message no later than A-75 days, A-365 days or A-210 days from scheduled availability start for surface force ships, aircraft carriers and submarines, respectively. TYCOMs shall provide concurrence to execute an “early start” period. The cognizant maintenance activity will formally document each “early start” period using applicable availability management control tools (e.g., Navy Data Environment, Final Review Estimate provided to the TYCOM, etc.), and include NSA acknowledgement that the availability cost to the TYCOM will be the same, as if no “early start” period was utilized, within that documentation.

3.2.3 Readiness to Start Availability (Aircraft Carriers and Surface Force Ships Only). The Project will conduct a Readiness to Start brief in accordance with the appropriate milestones listed in Appendix C for Aircraft Carriers and Part II, Chapter 2, Appendix D of this volume for Surface Force Ships. The purpose of this briefing is for the Project Team to demonstrate its readiness to execute, test and certify the maintenance availability. The Project Team shall review the Availability Work Package (AWP) for risks that would threaten the Project Team’s ability to accomplish the work to the expected level of quality within the scheduled time and budget. The Project Team shall develop risk mitigation strategies that eliminate or minimize risks. These risk mitigation strategies shall be outlined in a letter provided to the TYCOM and the NSA’s Immediate Superior In Command (ISIC) (e.g., Commander, Navy Regional Maintenance Center (CNRMC), NAVSEA 04X, Program Executive Officer (PEO)).

3.2.3.1 Readiness to Start Brief.

- a. All required Technical Work Documents (TWD) are complete, reviewed and approved by the NSA Engineering Department. Any unfinished TWDs will be discussed.
- b. The Quality **Management** Plan (QMP) is complete and signed.

- c. The initial conditions can be established to support the work (e.g., drained, depressurized, de-energized, tag out and Work Authorization Form (WAF)).
- d. The required repair parts, materials (including pre-fabrication) and test equipment are available or will be available to support the work.
- e. Assigned project team personnel are knowledgeable, trained and qualified. The Executing Activity shall provide appropriate written documentation to support the qualifications or certifications prior to personnel performing any work.
- f. The milestones and key events schedule, critical path jobs and budget (including the overtime plan).
- g. All required MOAs are signed and a communications plan has been established between the key participants of the availability.
- h. A risk management plan is developed to mitigate or reduce risk. These mitigation or risk reduction options will be continuously evaluated throughout the availability.
- i. A Fast Start strategy shall be developed and monitored. A 100 hour beginning of the availability strategy will be part of this plan.
- j. Ship's Force availability related training plan.
- k. Readiness to receive Ship's Force. Items to be discussed shall include: adequacy of work space, computer and telephone connectivity, completion of training and Ship's Force watchbill qualifications.

3.3 MAINTENANCE POLICIES AND PROCEDURES.

3.3.1 Critical Path Jobs. Critical Path Jobs (CPJ) are those jobs or series of jobs that require special management attention and normally present the greatest risk to on time completion of the Key Event or availability. Industrial activities should be judicious in designating jobs as CPJs to prevent diverting management attention from those jobs which are, in fact, critical to on time completion of the availability. Consideration shall be given to, but not limited to, the following in determining the CPJs:

- a. Little or no room for delay exists.
- b. Establishing plant conditions.
- c. Long Lead Time Material (LLTM).
- d. Complexity of job or special skills or resources required.
- e. Significant test requirements.
- f. Not previously accomplished by a Fleet Maintenance Activity (FMA) (alterations, etc.).

3.3.2 Work Sequence Schedule. The Work Sequence Schedule is an integrated timeline (Pert Chart, Gantt Chart, etc.) that includes plant conditions, major work steps, tests and recertifications used to identify and progress CPJs. The Work Sequence Schedule should include:

- a. Staging.
- b. Establishing plant conditions.
- c. Issuing work procedures.
- d. Identifying major production steps.
- e. Testing/Recertifying.
- f. Closing out work procedures.

3.3.3 Milestones. Appendices A, B and C of this chapter are representative of Typical CNO Maintenance Availability milestones for ships.

- a. Appendix A of this chapter is applicable to submarines only. NAVSEA will issue specific advance planning milestones for each CNO Maintenance Availability.

- b. Appendix B of this chapter is applicable to the surface force only. It is a guide to aid the Commanding Officer (CO) in planning and executing the availability. Specific advance planning milestones are developed jointly by the ship, the TYCOM, and the planning and executing activities (if possible). A particular availability may require development of a complete off-load/storage/security plan or a tailored list of Inactive Equipment Maintenance (IEM) items, or may require office/training/flammable storage space, etc. These items should be added to the milestones through coordination with the responsible planning and engineering activity.
- c. Appendix C of this chapter is applicable to aircraft carriers only. For specific availabilities, a listing of milestones is included as an enclosure to Supervisor of Shipbuilding Newport News PMS 312C, as applicable, Maintenance Planning Tasking letter. Subsequent to this, the TYCOM sends out periodic revisions until availability completion. Various activities which have specific responsibilities for the maintenance of aircraft carriers, composite listings of milestones for the TYCOM, NAVSEA, PMS 312C, planning yard and the CO of the ship, imposed by the TYCOM and higher authority are found in reference (a). The milestones are arranged in order of occurrence through the planning, execution, and post-repair phases of CNO Maintenance Availabilities.

3.3.4 Production Completion Date. Engineering plant Production Completion Date (PCD) is an availability key event that provides sufficient time for the necessary steps to be taken by Ship's Force to shift from a maintenance environment back to operations. It is the intent that all major work and cold plant testing in all main propulsion and auxiliary spaces will be complete by all maintenance providers by the scheduled engineering plant PCD. The time reserved between PCD and propulsion plant light off is set aside to allow Ship's Force to complete pre-event certifications, clearance of tagouts, complete any remaining discrepancy corrections, continued deep cleaning, small valve maintenance, Ship's Force startup maintenance, valve lineups, temporary service removal, and, if required, any groom teams in areas requiring special emphasis. This time is necessary to allow Ship's Force to transition to an operational environment and focus necessary training and complete final preparations for the Light Off Assessment (LOA)/propulsion plant light off. For availabilities in excess of 120 days (140 days for forward deployed CVNs), PCD will be scheduled 14 days prior to the LOA. For availabilities 120 days or less (140 days for forward deployed CVNs), PCD will be scheduled between 3-14 days prior to propulsion plant light off. The ship's CO, Chief Engineer and maintenance provider's senior Project Manager will determine the number of days needed between PCD and propulsion plant light off for availabilities 120 days or less (140 days for forward deployed CVNs) based on the scope of work, length of availability and other pertinent factors. PCD will not be less than 3 days prior to propulsion plant light off regardless of whether a LOA is scheduled. Generally LOAs will be scheduled for availabilities greater than 120 days. For availabilities 120 days and less (140 days for forward deployed CVNs), the requirement for a LOA will be determined by the TYCOM. The following list contains examples of items to be considered when deciding whether or not the ship is ready to call engineering plant PCD and begin the shift from a maintenance environment back to operations:

- a. Temporary services removed, except for those required by Ship's Force or late emergency industrial activity work required for LOA.
- b. Access openings and ladders installed and clear for passage.
- c. All damage control/firefighting systems operational.
- d. Major lagging repairs completed. Some minor lagging repairs may remain.
- e. All machinery in-place and assembled with cold checks completed satisfactorily in accordance with current instructions.
- f. Missing deck plates and supports installed.
- g. Boiler work completed including hydrostatic testing, with boiler under appropriate lay-up.
- h. Loose industrial material and debris removed.
- i. All main propulsion and auxiliary piping, valves, and systems intact, hydrostatic tightness tests completed satisfactorily and remote valve operator and associated/indicator tests completed satisfactorily.

In the event that the decision is made to delay the scheduled PCD, careful consideration should be given to ensure that the above listed times allotted for Ship's Force between PCD and the LOA/propulsion plant light off are preserved, even if the availability end date would be adversely affected. The ship's CO, Chief Engineer, and the availability senior Project Manager should carefully evaluate any and all work remaining within the engineering spaces that could impact Ship's Force ability to be successful in preparing for the LOA/propulsion plant light off. An exceptions list should be generated and agreed to by the ship's CO, Chief Engineer and the maintenance provider's senior Project Manager listing all outstanding engineering space work which will continue after PCD while the ship is preparing for the LOA/propulsion plant light off.

3.3.5 Combat Systems Production Completion Date (AEGIS Light Off for AEGIS ships) (Surface Force Ships Only). A Key Event to document all production work supporting uninterrupted Combat Systems testing is complete. Combat Systems Production Completion Date (CSPCD) is defined as met when production work in designated compartments and support systems is completed to the degree required to support uninterrupted testing, once started, and start of selected stage 3 Combat Systems tests. For compartments, the degree required includes final paint, completion of compartment air testing and final painting of supporting fan rooms. For support systems, which are ship-wide distributed in nature, the degree required includes complete installation of the branches supporting the Combat Systems and completion of support systems test procedures or applicable portions of the support system test procedures such that the support equipment is operating within design parameters.

- a. Compartments and support systems required for support of stage 3 testing.
 - (1) For non-AEGIS ships, the compartments and support systems required for support of stage 3 Combat Systems testing is class specific and shall be agreed upon by the government and contractor prior to the start of the availability.
 - (2) For AEGIS ships, the designated compartments and support systems are listed in reference (b), Section 092, Table I (for DDG-51 class ships) and Table II (for CG-47 class ships). The selected stage 3 or Operational Verification Tests to be conducted as part of AEGIS Light Off are to be identified in the Total Ship's Test Program along with the time phased sequence of AEGIS Modernization Team (if assigned) testing activities.
- b. The NSA must certify all related work and testing is completed for AEGIS Light Off/CSPCD, with any exceptions noted and approved by the appropriate technical authority and agreed to in writing by the Ship's CO, Project Manager, TYCOM and the NSA.
- c. To declare the CSPCD key event met, all heavy industrial work in given compartments must be complete including, but not limited to, hot work, cutting, grinding, deck work (Terazzo, NOMEX) and spray painting. Access routes need not be released but must be passable or alternate routes made to the Combat Systems Suite available at all times. Services, either ship or shore based, must be available on a reliable basis. These services may include (based on ship class): 60 HZ/400 HZ, Air Conditioning, Chilled Water, condensate drains, Firemain or AEGIS Salt Water Cooling pumps, Ventilation, Electronic Cooling Water (demineralized water), Dry Air, High Pressure Air, Low Pressure Air, Fwd and Aft AN/SPY skids, Sonar skid, AN/SPS 49 skid, Command and Decision skid, AN/SLQ 32 Cooling unit and Close-In Weapons System heat exchanger. In addition the Electric Plant Control Equipment console or equivalent remote 400 HZ control unit must be available. Cabling from 60 HZ Power panels, Chilled Water hoses and routes must be intact to 400 HZ power sources/converters. Electronic Cooling Water modifications must be completed and all contractor flushes accomplished. If in dock, overboard discharges for AC plants, Cooling skids and Firemain must be installed. Combat Systems testing shall not begin in a compartment which has not been formally turned over and accepted by the Supervisor without permission of the PEO Integrated Warfare System/SEA 21 Combat Systems Project Engineer (if assigned) and the Supervisor.

3.3.6 Memorandum of Agreement. The Memorandum of Agreement (MOA) shall be executed and jointly signed by the ship's CO, the NSA, the ISIC representative (if applicable) and the FMA representative (if applicable) prior to commencing authorized work. It is an agreement between the industrial activity and Ship's Force concerning the responsibilities of each party during the availability. It deals with a number of areas in which Ship's Force generally provides support to the industrial activity and vice versa. References (c) and (d) contain training requirements and additional guidance for MOAs involving aircraft carriers and submarines. As a minimum the MOA shall include:

- a. Purpose.
- b. Applicability.
- c. Responsibilities for control of plant conditions and work area isolation.
- d. Responsibilities for accomplishment of work.
- e. Responsibilities for Quality Assurance (QA).
- f. Responsibilities for support services/equipment.
- g. Responsibilities for testing requirements.
- h. Responsibilities for waivers, deviations, or Departure from Specifications.
- i. Precise delineation of the Submarine Safety (SUBSAFE), **Deep Submergence Systems/Scope of Certification (DSS/SOC) and Fly-By-Wire (FBW) work** responsibility of each activity for all phases of SUBSAFE, **DSS/SOC and FBW** work prior to issuing Re-Entry Controls/**Controlled** work.
- j. Responsibilities for training.
- k. Miscellaneous responsibilities (as required) (i.e., Radiological Control, Hazardous Material, etc.).
- l. Signatures of all activities (signifying agreement with the terms and responsibilities of the MOA).

3.3.7 Responsibilities. Responsibilities for the Maintenance Policies and Procedures for CNO scheduled availabilities are as follows:

3.3.7.1 Fleet Commander.

- a. Maintain the Availability Intervals and Cycles issued in reference (e) to the maximum extent practical within operational requirements.
- b. Inform the Chief of Naval Personnel of any significant changes which would affect ship manning requirements during an extended CNO Maintenance Availability.
- c. Coordinate with the Program Executive Office, Direct Reporting Program Manager or Ship Program Manager, as applicable, in the accomplishment of CNO Maintenance Availability planning.
- d. Implement Docking Officer Qualification and Certification requirements as issued in NAVSEA instructions.
- e. Plan for and monitor availability execution to achieve a balance of cost and schedule for the scope of work authorized. Ensure that any growth in the scope of work authorized is necessary to reasonably assure safe, reliable operation of the ship during the subsequent operating cycle.
- f. Plan for and provide berthing, messing, offices, classrooms, equipment stowage space, and Ship's Force repair shop in accordance with reference (f) when shipboard facilities are expected to become unusable or uninhabitable.

3.3.7.2 Type Commander.

- a. Coordinate the scheduling of availabilities at industrial activities with Fleet Commander, NAVSEA and CNO.
- b. Initiate the required budgetary actions for funding availabilities.
- c. Coordinate the work assignments between the FMA and the industrial activity.
- d. Seek resolution of all class and major technical problems and coordinate industrial requirements for modernization and repair.
- e. Authorize AWP's prepared by Submarine Maintenance Engineering, Planning and Procurement (SUBMEPP) Activity (Submarines only)/PMS 312C (Aircraft Carriers only) with recommendations from the ship's CO, Maintenance Manager and ISIC (if applicable). Exercise all work candidate

screening and follow up actions relating to the availability directly with the ship concerned. (Surface Force Ships only) Assume the lead role in managing the AWP from the Baseline Availability Work Package (BAWP) developed by Surface Maintenance Engineering Planning Program (SURFMEPP).

- f. (Submarines Only) Coordinate the interface of the Maintenance and Material Management (3-M) system with the Periodic Maintenance Requirement (PMR) scheduling and feedback reporting system.
- g. Designate a TYCOM representative for the Work Definition Conference (WDC)/Project Review Conference (PRC) and Pre-Arrival Conference (PAC) when such conferences are scheduled.
- h. Recommend to CNO any high priority fleet modernization desired to be accomplished.
- i. (Submarines Only) Send a Sea Trials Support Services message, if required, to specify Submarine Rescue Diving Recompression System (SRDRS) "modified-alert" requirements (see Appendices BA or CA of this chapter).
- j. (Submarines Only) For minor CNO Maintenance Availabilities send a Waiver of Escort Requirements Message to NAVSEA when requested by the ISIC in accordance with paragraph 3.6.8.3.9.b.(4) of this chapter.
- k. Conduct a QA audit of Ship's Force and FMA Controlled Work Packages in accordance with Volume V, Part I, Chapter 9 of this manual.
- l. (Submarines Only) For major CNO Maintenance Availabilities issue the required messages for Fast Cruise, Sea Trials and Unrestricted Operations (URO) Certification in accordance with paragraph 3.6.8.4 of this chapter.
- m. (Submarines Only) For CNO scheduled availabilities of less than six months in duration issue the required message for Sea Trials in accordance with paragraph 3.6.8.3 of this chapter.
- n. (Submarines Only) Verify that all Submarine Flight Critical Component (SFCC) - certified On Board Repair Parts are loaded out by Fast Cruise following any major or minor CNO availability.

3.3.7.3 Type Commander/Immediate Superior In Command (Group or Squadron).

- a. All Ships.
 - (1) Assist the TYCOM, SUBMEPP (Submarines)/PMS 312C (Aircraft Carriers) and SURFMEPP (Surface Force Ships) in the preparation of the AWP.
 - (2) Monitor corrective maintenance action taken by industrial activities and Regional Support Groups (RSG)/Regional Maintenance Centers (RMC).
 - (3) Schedule and conduct inspections of Forces Afloat.
 - (4) Monitor progress of CNO Maintenance Availabilities.
 - (5) Ensure that a MOA is executed prior to availability start in accordance with paragraph 3.3.6 of this chapter.
- b. Submarines Only.
 - (1) Ensure timely accomplishment and reporting of PMR maintenance actions on assigned ships. This should include the use of the PMR scheduling system and the SUBMEPP scheduling tape for automatic interface between the Master Job Catalog, the Current Ship's Maintenance Project (CSMP), and the Automated Material Requisitioning system.
 - (2) Ensure industrial activities and ships maintain current copies of Maintenance Standards, PMR schedules and PMR inventories.
 - (3) Review Ship's Force submitted deferrals for industrial activity assistance to determine if restoration in accordance with Maintenance Standard criteria is warranted in lieu of, or in addition to, requested industrial activity corrective maintenance.
 - (4) Ensure industrial activities provide the 3-M and Maintenance Standards feedback necessary for analysis by SUBMEPP.

- (5) Request assistance from SUBMEPP as necessary in resolving problems with PMR scheduling and software.
 - (6) Report to SUBMEPP the inability to perform PMRs due to software technical inadequacy, non-availability of overhauling spares, insufficient manpower or inadequate industrial activity facilities.
 - (7) Designate an Availability Coordinator to coordinate industrial activity, FMA drydock and Ship's Force work to meet the availability completion date.
 - (8) Provide updated Sea Trials status by telephone to Commander, Submarine Squadron (COMSUBRON) ELEVEN if SRDRS "modified-alert" support services are in use.
 - (9) For minor CNO Maintenance Availabilities issue the required messages for Sea Trials escort requirements/waiver of escort requirements as applicable, Fast Cruise, Sea Trials and URO Certification in accordance with paragraph 3.6.8.3 of this chapter.
 - (10) Report that all SFCC-certified On Board Repair Parts are loaded out by Fast Cruise following any major or minor CNO availability (Appendix BQ or Appendix CS).
- c. Surface Force Ships Only.
- (1) In coordination with the RMC Chief Engineer (CHENG), submit Change Deferral Requests and Change Notifications to SURFMEPP per Appendices AK and AL. These documents will provide adequate information to support a technical analysis, including the date the maintenance was last accomplished, the proposed timeframe for accomplishment, reason for non-accomplishment using the deferral codes provided and a mitigation strategy with impact statement for non-accomplishment. In addition, TYCOM will maintain mandatory BAWP requirements proposed for non-accomplishment in an active planning status until adjudicated.
 - (2) Coordinate with SURFMEPP to update the AWP when Class Maintenance Plan (CMP) changes drive a change to the BAWP after A-360.
 - (3) Coordinate meetings as required at key milestones and as required to support resolution of major issues, such as those associated with large budget reductions or shipyard resource shortfalls due to scheduling conflicts.

3.3.7.4 Submarine Maintenance Engineering, Planning and Procurement Activity/Planning Engineering Repairs and Alterations.

- a. Develop plans for accomplishing periodic maintenance or equipment replacement.
- b. Maintain Baseline AWP's configured to each ship class and type availability and include the standard 3-M data elements controlled by the TYCOM.
- c. Prepare and issue all phases of AWP's and AWP Supplements (if applicable).
- d. Maintain custody of shore based spares under the direction of NAVSEA and the TYCOM.
- e. (Submarines Only) Prepare, issue and maintain PMR computerized inventories and scheduling reports and associated Master Job Catalog/PMR computer tapes.
- f. (Submarines Only) Prepare, issue and maintain Maintenance Standards under the guidance of NAVSEA and the TYCOM.

3.3.7.5 (Surface Force Ships Only) Surface Maintenance Engineering Planning Program (SURFMEPP).

- a. Act as the surface force ship CMP development and management activity.
- b. Build Technical Foundation Papers for each ship class and Ship Sheets by hull.
- c. Identify, track and process all mandatory CMP requirements.
- d. Develop, track and process the BAWP to reflect changes in the CMP.

- e. Capture all mandatory maintenance close-out/return costs at the Job Control Number and Ship's Work List Item Number (SWLIN) levels.
- f. Review Change Deferral Letters and Cancellation Deferral Notification System (CDNS) requests for sufficient supporting documentation, mitigating actions and to determine the impact of reprogramming work or reducing scope in accordance with the change deferral process located in Appendix AK of this chapter.
- g. Develop a response in conjunction with applicable Technical Authorities and Engineering Authorities such as Naval Air Systems Command, Space and Naval Warfare Systems Command, Naval Surface Warfare Centers and other stakeholders. If required, coordinate the revision of the mitigation strategy with Commander, Naval Surface Atlantic (CNSL)/Commander, Naval Surface Pacific (CNSP) N43.
- h. Review and forward recommended action for CDNS requests to NAVSEA 05D with justification/recommendation for approval or disapproval within fourteen (14) calendar days of receipt.
- i. **SURFMEPP will provide recommendations to Deferral Letters and forward to NAVSEA 05 for Surface Ship Engineering Operation Cycle designators and provide final determination for all other tasks to the TYCOM with information copy to SEA 05.**
- j. Ensure the CMP configuration data, Last Maintenance Accomplished dates as designated in the Maintenance and Ship Work Planning program, next Due Dates and associated periodicities remain current using historical technical data to correct deficiencies when necessary.
- k. Review NAVSEA 05D responses to Change Deferral Requests and send the Final Disposition Letter to TYCOM within ten (10) calendar days of receipt.
- l. Coordinate the **Corrosion Planning Conference**, Life Cycle Planning Conference (LCPC), CSMP/Departure From Specifications (DFS)/BAWP Mid-Cycle Review and the BAWP Close-Out Verification and Assessment Meeting and summarize all Deferral Letters, Change Notifications and resulting actions for the current Fleet Readiness Plan (FRP) Maintenance Cycle.
- m. Brand tasks residing in the CMP and CSMP, as applicable.
- n. Issue the CNO Availability Advance planning schedule.
- o. Integrate Modernization tasks into the BAWP prior to A-360 in accordance with an issued Advance Planning Letter. After BAWP/AWP turnover, enter authorized Modernization tasks into the CSMP in accordance with the Navy Modernization Process and brand **in accordance with Appendix AN**.
- p. Attend TYCOM, RMC, and Private Sector Industrial Activity (PSIA) planning conferences for each ship.

3.3.7.6 Ship's Commanding Officer. The CO is the TYCOM representative for monitoring the progress and quality of industrial work. As such he should review availability progress during weekly conferences with Department Heads and others as necessary. The Supervising Authority meets weekly with the CO and other industrial activity officials as described in paragraph 3.6.3.1 of this chapter. The CO should be prepared to discuss and assist in the resolution of scheduling, design, material, and production problems. The CO's responsibilities are defined in reference (e). Additionally, COs shall:

- a. All Ships.
 - (1) Review AWP and provide comments to the TYCOM, ISIC and SUBMEPP/PMS 312C during the WDC/PRC.
 - (2) Assign a Ship Selected Records (SSR) Coordinator to perform the functions of paragraph 3.6.6.b. of this chapter.
 - (3) Publish policy concerning the number of duty sections, liberty, ship cleanliness, tagout procedures, tank closeout and blanking of otherwise exposed fluid systems, waveguides and air systems before availability start.

- (4) Ensure non-conformances (Waivers/Deviations or Departures from Specification) submitted during the availability by any activity are approved prior to trials at sea (if held) and not later than the completion of the availability.
- b. Submarines Only.
 - (1) Review the status of PMR maintenance schedules and CSMP reports with parent ISIC prior to CNO Maintenance Availabilities in order to assist in planning for accomplishment of the required planned maintenance and corrective maintenance. Additional information and requirements concerning PMR are discussed in detail in Volume VI, Chapter 24 of this manual.
 - (2) Maintain a current SUBMEPP PMR inventory of maintenance requirements and Maintenance Standards applicable to the ship class.

3.3.7.7 Maintenance Team (Surface Force Ships Only).

- a. BAWP requirements uploaded to the CSMP with a due date prior to the ship's Mid Cycle Review must be screened and brokered within ten (10) calendar days after receipt of task.
- b. Screen and broker 100 percent of the BAWP's mandatory requirement 2-kilos by **Mid Cycle Review**.
- c. Meet with TYCOM Representatives and SURFMEPP by **Mid Cycle Review** to review the ship's BAWP, CSMP, Availability Duration Estimate, active DFSs, Class Advisories and routines/services. The CSMP will be reviewed and evaluated for branding per Appendix AN. The ship will assign a Job Control Number (JCN) to active temporary DFSs with no open JCN in the CSMP (the ship shall update the DFS to reflect the new JCN as appropriate and the Port Engineer will ensure the "Job Closure Method" is set to "Both" as referred in Part II, Chapter 3 of this volume).
- d. Screen and broker any mandatory CMP requirement uploaded to the CSMP by Mid Cycle Review within ten (10) days of receipt into the Information Technology (IT) screening and brokering system.

NOTE: MAINTENANCE TEAM (MT) WILL SCREEN ALL REQUIREMENTS TO A SCHEDULED OR FUTURE MAINTENANCE PERIOD TOTAL SHIP READINESS ASSESSMENT (TSRA) EVENT WITHIN THE CURRENT FRP MAINTENANCE CYCLE.

- e. Provide timely close-out information for completed requirements.
- f. When required, provide CMP configuration data corrections to SURFMEPP.

3.3.7.8 Technical Warrant Holders and In-Service Engineering Agents (Surface Force Ships Only).

- a. Evaluate Deferral Letters requested by NAVSEA 05D (Ship Design Manager).
- b. Evaluate CDNS deferral requests as requested by NAVSEA 05D.
- c. Provide approval or disapproval recommendations to NAVSEA 05D in support of Deferral Letters and CDNS Deferral Requests.

3.3.7.9 NAVSEA 05D (Surface Force Ships Only).

- a. Review, adjudicate and provide a response for all Change Deferral Requests to SURFMEPP within ten (10) business days of receipt.
- b. For Deferral Letters requiring other agency approvals (e.g., Naval Air Systems Command, Naval Ship Systems Engineering Station, etc.), NAVSEA 05D will coordinate with the appropriate Technical Authority for adjudication.
- c. Review, adjudicate and provide a response for all CDNS requests within ten (10) business days.
- d. NAVSEA 05D (Ship Design Manager) shall provide a representative to all BAWP Process Milestone Meetings when practical.

3.4 AVAILABILITY WORK PACKAGE PLANNING.

3.4.1 Forces Afloat Planning Sources. The majority of the Forces Afloat Work Package can be identified in advance from the following sources:

- a. Ship's CSMP Integrated with the Life Cycle Maintenance Plan. This document contains work items deferred during the previous maintenance availabilities, outstanding Departures from Specifications, dry dock requirements, etc. To ensure the CSMP accurately reflects the required ships maintenance, the ISIC Material Officer/TYCOM will review each ship's CSMP in detail with the ship prior to the WDC/PRC for CNO Maintenance Availabilities. The ISIC/TYCOM 3-M Coordinator and Maintenance Document Control Office (MDCO) should provide the necessary technical assistance and training to facilitate CSMP updates.
 - (1) (Submarines Only) PMR/URO. The ISIC will load scheduled PMRs into each ship's CSMP for a specific availability.
 - (2) Alterations.
 - (a) (Aircraft Carriers and Submarines only) The ISIC MDCO/TYCOM will enter alterations on the ship's CSMP which the TYCOM has authorized for accomplishment. The ISIC/TYCOM calls out alterations for a specific availability based on material availability as identified by the industrial activity. Within funding constraints and TYCOM guidance, all alterations authorized on the TYCOM Alteration Management System/Navy Modernization Process are candidates for accomplishment during each availability.
 - (b) (Surface Force Ships only) SURFMEPP enters alterations on the ship's CSMP as discussed in section 3.3 of this chapter.
 - (3) Condition Based Maintenance. (Machinery Condition Analysis/Technical Assessment, Repair, Groom and Evaluation Team/Performance Monitoring Team (PMT), Combat System Readiness Review, etc.). The ISIC/TYCOM Material Officer and Ship's Force shall ensure that all material deficiencies identified by Condition Based Maintenance programs as identified in Part I, Chapter 2, section 2.4 of this volume are loaded into the CSMP for a specific availability.
 - (4) Life Cycle Planning Conference (Surface Force Ships Only). Representatives from SURFMEPP, TYCOM and the ship's Port Engineer (PE) will convene for a LCPC. SURFMEPP will be responsible for planning and conducting the conference. TYCOM, RMC Assessment Directors, Program Manager Representatives, representatives from NAVSEA 05, NAVSEA 21 Modernization, Planning Activity and the ship's MT should attend the LCPC. Appendix AO illustrates the entire process timeline.
- b. Work Routines. A set of Master Job Catalog standard work routines should be developed for every availability. The MDCO/TYCOM tailors each work routine package to the needs of the ship by calling out additional work routines to document periodic, interim drydocking, URO maintenance and calibration recall requirements, as applicable.
- c. Pre-Availability Tests and Inspections. Ship's Force, PMTs and industrial activity inspectors perform and submit the results of these pre-availability tests and inspections to the industrial activity/SUBMEPP (Submarines)/PMS 312C (Aircraft Carriers)/applicable TYCOM (Surface Force Ships) for evaluation and inclusion in the AWP, as applicable. NAVSEA 07T provides results and recommendations for pre-availability tests performed by PMTs and Ship's Force.
- d. Additional requirements for nuclear powered ships are contained in reference (b).

3.4.2 Forces Afloat Planning Actions. Ship's Force shall take the following maintenance availability planning actions, as applicable:

3.4.2.1 Forces Afloat Work Package Preparations.

- a. Develop a Ship's Force concurrent Work Package that includes all major maintenance actions such as Planned Maintenance System (PMS), Reactor Plant PMS, repairs, PMRs, alterations, and testing to be conducted by Ship's Force during the availability, as applicable.
- b. Identify CPJs in accordance with paragraph 3.3.1 of this chapter, and submit to the planning/industrial activity for integration into the availability schedule.
- c. Establish a strategy for calibration of gages, instruments, and tools based on the Calibration Recall List and Calibration Support Plan.
- d. Identify all industrial activity provided production and testing support equipment needed to accomplish Ship's Force work, or to recertify systems following Ship's Force work. Identify this equipment to the industrial activity prior to the start of the availability. This support equipment includes the following, as applicable:
 - (1) Reactor Plant PMS support equipment.
 - (2) System hydrostatic test equipment.
 - (3) Calibration equipment.
 - (4) Special tools.
- e. Ship's Force should use Appendices A, B or C of this chapter as guidance to prepare for availabilities, as applicable. These appendices provide Typical CNO Maintenance Availability Planning Milestones for submarines, surface ships and aircraft carriers respectively.

3.4.3 Availability Work Packages.

3.4.3.1 Availability Work Package Content. The AWP includes all nuclear and non-nuclear authorized industrial work and associated Forces Afloat work for modernization, maintenance and repair during the availability. The work described is developed from NAVSEA and TYCOM instructions. Forces Afloat actions in the AWP scheduled to complete prior to availability start are critical in defining additional work candidates in accordance with Appendix D.

3.4.3.2 Availability Work Package Sources.

- a. CMP.
- b. NAVSEA authorized alterations.
- c. TYCOM authorized alterations, repairs, PMRs, Engineering for Reduced Maintenance Costs items and baseline AWP.
- d. Results of pre-availability tests and inspections.
- e. CSMP.

3.4.3.3 Availability Work Package Development. The five stages of AWP development include Baseline, Preliminary, Proposed, Approved, and Completed.

- a. SUBMEPP (Submarines)/PMS 312C (Aircraft Carriers)/SURFMEPP (all other Surface Ships) develop and maintain Baseline AWP for each ship class and type of availability.
- b. SURFMEPP (Surface Force Ships only) is responsible for BAWP development. The BAWP is comprised of mandatory assessment and corrective maintenance requirements from the CMP. Additional mandatory life cycle critical work (i.e., CSMP repairs that have been branded as mandatory by SURFMEPP) as well as non-mandatory CMP items (i.e., TYCOM requested assessments, approved and authorized modernization jobs and CNO availability services) will be combined with the BAWP to develop the AWP as the maintenance cycle progresses. Mandatory life cycle critical work (identified by having an "A" brand in the category of work field), regardless of its origin (e.g., SURFMEPP, Ship's Force or RMC), will be tracked and/or adjudicated using processes described in this section.

- c. SUBMEPP (Submarines)/PMS 312C (Aircraft Carriers)/applicable TYCOM (all other Surface Force Ships) consolidate the Baseline AWP, NAVSEA authorized alterations and TYCOM authorized alterations, repairs, PMRs and Engineering for Reduced Maintenance Costs items to produce the Preliminary AWP. This Preliminary AWP is issued approximately 12 to 14 months prior to the start of the availability.
- d. Systems Command (SYSCOM), TYCOM, and the ship's CO should review the Preliminary AWP to ensure that it includes known work candidates and authorized alterations that will not be accomplished prior to availability start and for proposed work candidates, which in their opinion, are unnecessary. Appendix D of this chapter provides suggested guidelines for review of the AWP. Following the initial review of the Preliminary AWP, Ship's Force shall host a meeting with the TYCOM and SUBMEPP/PMS 312C, as applicable to consolidate comments and recommendations for the WDC/PRC. This meeting is normally held early in the same week as the WDC/PRC.
- e. SUBMEPP (Submarines only)/PMS 312C (Aircraft Carriers only)/TYCOM (Other Surface Force ships only) will host a WDC/PRC attended by NAVSEA, the Supervising Authority, FMA (if applicable), TYCOM, ISIC, PMT (Submarines Only), Strategic Systems Project Officer (SSBN/SSGN 726 Class submarines only) and Ship's Force when practical. During this meeting the Preliminary AWP is carefully reviewed and the SYSCOM and the TYCOM authorize the work. When actions are required before a decision is made, those actions are identified and subsequently monitored. The goal is to issue the Proposed AWP (one which represents all SYSCOM/TYCOM authorized work integrated and specifically tailored to the ship involved) within two months following this meeting. At this meeting, the SYSCOM/TYCOM authorizes the industrial activity to continue with planning on the basis of the work identified in the AWP. During this meeting any activity may submit new work candidates for consideration by the SYSCOM/TYCOM. The SYSCOM/TYCOM will authorize or reject each new work candidate submitted. A reason for rejecting a work candidate will be provided. For Surface Force Ships only, the NSA Chief Engineer will review requested growth and new work items for technical compliance.
- f. SURFMEPP (Surface Force Ships only) will host **four** scheduled meetings over the course of the ship's FRP Maintenance Cycle: **Corrosion Planning Conference**, the LCPC Mid-Cycle Review and the BAWP Close-Out Verification and Assessment Meeting. When possible, SURFMEPP conferences will be held in conjunction with other MT scheduled meetings, such as monthly Availability Advanced Planning Meetings and Planning Board for Maintenance (PB4M).
- g. SYSCOM/TYCOM and the ship's CO should review the Proposed AWP to ensure that it contains all agreements made at the WDC/PRC. Appendix D of this chapter also provides suggested guidelines for review of this AWP.
- h. The Supervising Authority will host a PAC attended by NAVSEA, FMA (if applicable), TYCOM, ISIC, SUBMEPP (Submarines)/PMS 312C (Aircraft Carriers), and Ship's Force when practical. During this meeting the Proposed AWP, with results of the pre-availability tests and inspections incorporated where possible, will be carefully reviewed and the SYSCOM/TYCOM will approve the work. The goal is to issue the Approved AWP at the conclusion of this meeting. During this meeting any activity may submit new work candidates for consideration by the SYSCOM/TYCOM and NSA Chief Engineer. The SYSCOM/TYCOM will authorize or reject each new work candidate submitted. A reason for rejecting a work candidate will be provided. For Surface Force Ships only, the NSA Chief Engineer will review requested growth and new work items for technical compliance.
- i. Within six months after the completion of the availability, SUBMEPP (Submarines)/PMS 312C (Aircraft Carriers)/applicable TYCOM (all other Surface Ships) will issue the Completed AWP.

3.5 AVAILABILITY PLANNING.

3.5.1 Ship's Force Pre-Planning.

- a. To effectively complete the Ship's Force and Maintenance Support Team (MST) (if assigned) responsibilities during the months preceding the start of the availability, it is necessary to assign an Officer/Chief Petty Officer as the Availability Coordinator, responsible for coordinating the completion of the milestones. The quality of the availability will be reflected in the preparations done by Ship's Force and MST (if assigned).
- b. Prior to commencement of the availability, the industrial activity will request the ship to provide personnel Temporary Assigned Duty to the activity (approximately one month prior to the start date). The industrial activity will identify the personnel requirements of this pre-arrival team based on the type of availability and ship class.

3.5.1.1 **Industrial Activity Visit.** The ship's CO, Executive Officer, MST Officer In Charge (OIC) (if applicable) and department heads will visit the industrial activity as soon as practical prior to the start of the availability. The CO shall meet key industrial activity managers involved in the availability, other COs of ships in availabilities at the same industrial activity and if applicable, the local Naval Reactors Representative. The Executive Officer, MST OIC (if applicable) and department heads shall meet their counterparts within the industrial activity Project Team and counterparts assigned to other ships in an availability at the same industrial activity. The Executive Officer shall also check available crew quarters and barge accommodations, if applicable. Ship's Force shall:

- a. Coordinate with the industrial activity to conduct pre-availability training and indoctrination. The following are suggested topics for training:
 - (1) Industrial activity organization and Ship's Force/MST (if assigned) interface.
 - (2) Industrial activity procedures and practices, including:
 - (a) Operational Control Transfer.
 - (b) Tagout/Rip-Out/Work Authorization Form. This training shall address the WAF/tagout process described in Volume IV, Chapter 10, paragraph 10.4.1.2 of this manual.
 - (c) SUBSAFE REC Procedures **and, if applicable, SOC and FBW Procedures.**
 - (d) Deficiency Reporting and Correcting.
 - (e) Radiological Controls Agreement.
 - (f) General Testing Requirements.
 - (g) Defueling/Fueling Requirements (Nuclear Reactor and Fossil Fuel).
 - (h) Industrial Activity Procedures for Accomplishing PMS of Equipment Under Their Cognizance.
 - (i) Nuclear Reactor/Radiological Accident Plan.
 - (j) Maintenance of Ship's Cleanliness.
 - (k) QA Interface with the Industrial Activity.
 - (3) General schedule of Key Events and phases of work and testing.
 - (4) Safety requirements including Ship's Force/MST (if assigned) industrial activity responsibilities for:
 - (a) Dry Dock Safety.
 - (b) Fire Watches.
 - (c) Watertight Integrity.
 - (d) Reactor Plant Safety.
 - (e) Personal Protective Equipment.
 - (5) Relationship with industrial activity management including responsibility regarding weekly management meetings.

- (6) Functions and responsibilities of the joint test groups (Nuclear/Hull, Mechanical and Electrical/Combat Systems) and the Ship's Safety Council including the designation of Ship's Force group and council members.
 - (7) Control mechanism for work and tests affecting ship's conditions.
 - (8) Special evolutions and procedures to be conducted early in the availability such as dry docking and establishing plant conditions.
 - (9) QA.
 - (10) IEM.
 - (11) Hazardous Material Requirements.
 - (12) Special Environmental Requirements.
 - (13) Support of Trials and Inspections.
 - (14) System Experts.
 - (15) Space Turnover.
- b. Develop training plan and watchstation requalification program in accordance with TYCOM directives.
 - c. Develop Plan of Action and Milestones for Ship's Force/MST (if assigned) responsibilities during the availability.
 - d. Review and prepare SSRs for turnover to the planning yard/industrial activity at the start of the availability (see paragraph 3.6.6 of this chapter).
 - e. Support the industrial activity's pre-availability shipchecks, tests and inspections.

3.5.1.2 BAWP Milestones for Surface Force Ships. Specific milestone timeline is located in Part II, Chapter 2, Appendix D of this volume.

3.5.1.2.1 Corrosion Planning Conference. SURFMEPP, TYCOM representatives, RMC, CNRMC, Ship Repair Facility (SRF) (Japan only) and ship's Project Team will review current FRP cycle corrosion requirements for: tank/void conditions, tank/void assessments, tank/void preservation (includes boundary tank review), tank/void repairs, tank/void mitigation strategies, long range tank planning, structural assessments, intake/uptake assessments, bilge well assessments, structural repairs/preservation, CMP preservation requirements, deferred corrosion related maintenance, corrosion related modernization, corrosion related DFS and shipboard habitability improvements.

3.5.1.2.2 Life Cycle Planning Conference. SURFMEPP will conduct an LCPC and issue a BAWP for ships at the beginning of each ship's FRP maintenance cycle. The purpose of the LCPC is to review contents of the preliminary BAWP and planning timeline schedules with TYCOM, RMC Assessment Directors, Program Manager Representatives, representatives from NAVSEA 05, NAVSEA 21 Modernization, Planning Activity and the MT. Feedback from the meeting will be folded into the issued BAWP as applicable.

3.5.1.2.3 Baseline Availability Work Package. SURFMEPP will send a list of the FRP Maintenance Cycle CMP requirements and a list of recommended availability services to the ship's PE for review. This list is a preview of the initial BAWP and will be discussed in detail at the LCPC. SURFMEPP will provide a list of CMP-required assessments to TYCOM, Navy Regional Maintenance Center (NRMC) and RMC as requested in support of the TSRA process.

- a. SURFMEPP will upload a data file (MM0001 file) with all mandatory requirements and expected CNO Availability services into the ship's CSMP in support of ship-specific MT screening and brokering requirements.
- b. SURFMEPP will issue formal correspondence detailing the BAWP planning schedule and outstanding action items from the LCPC.
- c. Requirements uploaded to the IT screening and brokering system with a due date prior to the ship's Mid-Cycle Review milestone must be screened within ten (10) calendar days after receipt of task.

- d. The PE shall screen 100 percent of the BAWP requirements in IT screening and brokering system no later than Mid-Cycle Review and will only utilize the IT screening and brokering system or the Maintenance Support Tool to accomplish this task. These requirements shall be screened by the PE to a scheduled or future maintenance period/availability (other than Unfunded) within the current FRP Maintenance Cycle.

3.5.1.2.4 Fleet Readiness Plan Mid-Cycle Review. SURFMEPP will conduct a mid-cycle review of the ship's BAWP and CSMP to ensure inclusion of all mandatory requirements, services/routines and lifecycle impacting Class Advisories, active DFSs and Avail Duration. Navy Data Environment (NDE) modernization forecasts are addresses as applicable. TYCOM, RMC Assessment Directors, Program Manager Representatives, representatives from NAVSEA 05, NAVSEA 21 Modernization, Planning Activity and the MT should attend this meeting.

- a. 100 percent of the BAWP requirements in the IT screening and brokering system are required to be screened by the ship's PE. These requirements shall be screened by the PE to a scheduled or future maintenance period/availability (other than Unfunded) within the current FRP Maintenance Cycle.
- b. Any mandatory CMP requirement pushed after LCPC (initial BAWP push) is required to be screened within ten (10) calendar days of receipt into the appropriate IT system.

3.5.1.2.5 Mid-Cycle Review.

- a. Following the Mid-Cycle Review, SURFMEPP will update the BAWP with lifecycle critical tasks.
- b. Further TYCOM deferrals or deletions to the BAWP must be submitted using a Deferral Letter or the CMP CDNS.
- c. CMP work completion, configuration updates and new CMP additions will require SURFMEPP to upload more CMP requirements into a ship's CSMP following the Mid-Cycle Review. These updates will be coordinated with the ship's PE prior to initiation. If the ship is beyond the BAWP turnover to TYCOM, updates shall be coordinated with the respective TYCOM AWP Manager in addition to the ship's PE.
- d. Mandatory CMP requirements pushed after LCPC (initial BAWP push) are required to be screened within ten (10) calendar days of receipt into the IT screening and brokering system.

3.5.1.2.6 Review of BAWP and CSMP.

- a. SURFMEPP, TYCOM representatives, RMC and the ship's MT will meet to review the ship's BAWP and CSMP to ensure inclusion of all required services/routines and lifecycle impacting Class Advisories and active DFSs. NDE modernization forecasts are addressed as applicable. RMC Assessment Directors, RMC and TYCOM TSRA Planners, NRMC, Program Manager Representatives and representatives from NAVSEA 05D, NAVSEA 21 Modernization, CNSL/CNSP N43, PSIA Contractor (or Planning Activity), ISIC, and the ship's MT shall attend this meeting.
- b. 100 percent of the BAWP requirements in the maintenance screening and brokering system (i.e., RMAIS) are required to be screened by the ship's PE. These requirements shall be screened by the PE to a scheduled or future maintenance period/availability (other than Unfunded) within the current FRP Maintenance Cycle.
- c. Any mandatory CMP requirement pushed after **LCPC** is required to be screened within 60 days of the maintenance screening and brokering system import date.

3.5.1.2.7 Updating the BAWP.

- a. SURFMEPP will update the BAWP with lifecycle critical repair tasks resulting from assessment requirements in addition to the results (i.e., deferral or technical challenges) from the CSMP/DFS/BAWP Mid-Cycle review.
- b. Further changes to the BAWP must be submitted using a Change Request Deferral Letter or the maintenance screening and brokering system.

- c. CMP work completion, configuration updates and new CMP additions will require SURFMEPP to upload more CMP requirements into the BAWP whose next due date falls within the current FRP Maintenance Cycle through C+120. These updates will be coordinated with the ship's PE prior to calldown. If the ship is beyond A-360, updates shall be coordinated with the respective TYCOM AWP Manager in addition to the ship's PE.
- d. Mandatory CMP requirements pushed after **LCPC** are required to be also screened within 60 days of their maintenance screening and brokering system import date.
- e. Ship Design Manager authorization via SURFMEPP Platform Engineering will be obtained if stakeholders desire to withhold or delay CMP requirements generated by configuration updates and new CMP additions if these requirements will be due prior to the end of the current FRP Maintenance Cycle.
- f. Updates will cease after 100 percent D-level maintenance lock.

NOTE: IF BAWP TURNOVER TO TYCOM OCCURS WITHIN 30 CALENDAR DAYS OF LCPC, THE PE MAY FORGO THE 50 PERCENT SCREENING MILESTONE AND INSTEAD HAVE 100 PERCENT OF THE BAWP REQUIREMENTS SCREENED BY MID-CYCLE REVIEW.

3.5.1.2.8 BAWP Turnover to TYCOM. The TYCOM's AWP Manager will review the BAWP and assume responsibility for planning and developing the AWP as described in paragraph 3.5.4 of this chapter.

3.5.1.3 Availability Coordinator (Submarines Only). A submarine served, nuclear trained Limited Duty Officer will be assigned to augment the normal ship's complement during Depot Modernization Periods, Engineered Refueling Overhauls, or Engineered Overhauls and will act as the Availability Coordinator for the ship. Availability Coordinator responsibilities are specified in Volume V, Part I, Chapter 1, paragraph 1.5.6 of this manual.

3.5.2 Docking Conference. For availabilities involving a ship's dry docking, the industrial activity will conduct a Docking Conference prior to the ship entering the activity if scheduled to go directly into dry dock.

3.5.3 Ship's Force Administrative Preparations. Ship's Force administrative preparations for availabilities will include:

- a. Necessary revisions to ship and department organization manuals to ensure compliance with established requirements.
- b. Preparation of necessary ship and department directives to ensure that administration is formally supported in accordance with current requirements.
- c. Formulation of procedures for qualification of underway/steaming watchstanders and maintenance of proficiency of inport watchstanders, including:
 - (1) Implementation of formal provisional qualification procedures.
 - (2) Establishment of qualification goals for Key Events, such as undocking, operational testing of ship and propulsion plant systems, steam testing, initial criticality, space turnover, etc.
 - (3) Incorporation of qualification requirements necessitated by alterations to ship or propulsion plant systems.
- d. Procedures for maintenance and security of Ship's Force/MST (if assigned) barge or office spaces.
- e. General overhaul plan for Ship's Force/MST (if assigned) responsible actions including provisions for:
 - (1) Ship off-load.
 - (2) Establishment of barge, berthing and messing facilities.
 - (3) Establishment of routine ship and barge watch bills.
 - (4) Scheduling of required shore based schools and leave for personnel.
 - (5) Provision for accomplishment of known Ship's Force/MST (if assigned) corrective maintenance.
 - (6) Establishment of Ship's Force PMS routines.

- (7) Establishment of Integrated Logistics Overhaul (ILO) procedures.
 - (8) Provisions for shift work during known periods of intensive testing (e.g., Engine Room Steaming Operations, Hot Operations, Power Range Testing).
 - (9) Ship load-out.
 - (10) Target dates for completion of key ship and department directives and procedures.
- f. Assignment of ship system experts, or QA Inspectors, capable of monitoring industrial activity work on assigned systems.

3.5.4 TYCOM AWP Schedule and Documentation Requirements (Surface Force Ships Only).

- a. Assume lead responsibility for AWP management at A-360.
- b. TYCOM will conduct Availability Planning Conferences periodically throughout the availability planning timeline in accordance with the milestones listed in Part II, Chapter 2, Appendix D of this volume. Further details concerning Availability Planning Conferences can be found in Appendix AM.

3.5.4.1 Resource Allocation.

- a. Identify and evaluate the links between the technically mandated life cycle/service life requirements contained in the CMP, the known repair tasks mandated in the BAWP and the current readiness/corrective maintenance requirements identified in the ship's CSMP.
- b. Across this mutually supportive prioritization and resource allocation process, TYCOM will function as the representative for making resource allocation recommendations in direct support of the AWP.
- c. Submit Change Deferral Requests at any time to expedite reallocation of resources.

3.5.4.2 Technical Resolution. To resolve technical issues in a timely manner, there **is one** major milestone for processing Deferral Letters and Change Notifications by the TYCOM.

- a. TYCOM will submit a Deferral Letter to SURFMEPP in accordance with the milestone chart located in Part II, Chapter 2, Appendix D of this volume, which will include a list of mandatory tasks in the current FRP Maintenance Cycle being requested for deferral. The information provided in the Deferral Letter should have a sufficient level of detail to enable a complete evaluation by the Technical Warrant Holder and the Ship Design Manager. SURFMEPP will review the requested deferrals and forward the recommendation to NAVSEA 05D for technical resolution.
- b. Subsequent Deferral Letter submissions occurring after TYCOM delivery of the Deferral Letter shall be individually submitted. It is incumbent upon MTs and TYCOMs to discuss Deferral Letters as early as possible to enable a technical evaluation and an approval/disapproval granted prior to A-35/**Award**.

3.5.4.3 Change Notifications. Subsequent submissions occurring after delivery of the **Deferral Letter** will be provided to SURFMEPP by TYCOM at the BAWP Close-Out Verification and Assessment Meeting using Appendix AL format and will include the same information provided **in any Deferral Letter submitted during the current cycle.**

NOTE: THIS SECTION DOES NOT GOVERN NOR MODIFY THE POST-AVAILABILITY TESTING AND CERTIFICATION OR CLOSE-OUT PROCESS.

3.5.4.4 Technical Deferral and Adjudication Process for Post-AWP Definitization (for Cost Contracts and Award Firm Fixed Price Contracts) Through the End of the Execution Period).

- a. The local RMC/SRF SEA 05 Chief Engineer is empowered as prescribed in reference (b) to provide final technical deferral authority of mandatory ("A" branded) tasks from **Definitization/Award** through the end of availability execution **period**.
- b. In the event the RMC/SRF Chief Engineer exercises this deferral authority, a signed letter with the following information must be provided to both TYCOM and SURFMEPP no later than **the** Availability closeout meeting.

- (1) JCN, Job Summary.
 - (2) Reason for Non-Accomplishment.
 - (3) DFS number if required.
 - (4) Any further information that may help future completion or scheduling integration.
- c. The TYCOM will provide a letter documenting all technically adjudicated and deferred work. This letter will be forwarded to SEA 21 and SEA 05, via SURFMEPP, prior to either Hull, Mechanical and Electrical or Combat Systems Production Completion date, whichever is later.

3.5.5 BAWP/AWP Change Management Process (Surface Force Ships Only).

3.5.5.1 Branding. To support work prioritization and authorization decisions, BAWP work items must be branded using the branding category codes in Appendix AN. Change Requests to “A” branded items require adjudication through the BAWP Change Management process per Appendix AK. Deferral Letters and CDNS Requests are adjudicated by NAVSEA 05D via SURFMEPP. Work Item Branding Categories will be entered in the “Category of Work” block of the Automated Work Request (AWR) by SURFMEPP.

3.5.5.2 CMP Cancellation Deferral Notification System. The CDNS is imbedded in the maintenance screening and brokering system and is used to track the status of all CMP mandatory maintenance in a ship’s shore file CSMP. If a particular maintenance requirement is screened to a maintenance period that starts greater than 90 days before or after the requirement’s due date, if the requirement is screened by the ship’s PE to an “unfunded availability”, a series of e-mails are automatically sent from CDNS to key maintenance plan stakeholders. The stakeholders then communicate with the MT to provide technically sound adjudication for the situation surrounding that specific requirement. Deferrals using this system will be routed through SURFMEPP and NAVSEA 05 as appropriate. This system provides an automated, auditable process for monitoring each ship’s accomplishment of CMP requirements. MTs will use this system to request deferral or cancellation of mandatory CMP requirements as follows:

- a. CDNS will only be used to request deferral of CMP tasks within the FRP. Requests for deferrals outside the FRP shall be submitted using the Deferral Letter process.
- b. Once SURFMEPP has entered the ship’s CMP requirements into IT screening and brokering system, the MT will screen each requirement to an appropriate maintenance period or TSRA event. CMP requirements may be identified by the MT as requiring deferral or correction based on errant configuration data, substitution JCNs or an inability to accomplish the requirement by the due date.
- c. When the MT identifies such a condition, it shall contact the local SURFMEPP Detachment to review the situation.
- d. If both parties agree this item should be addressed by higher technical authority, the MT will screen the item to an “Unfunded” availability to initiate the CDNS process.
- e. The CDNS adjudication process will be followed to resolve the request.
- f. The PE will provide all approved deferrals to the TYCOM AWP Manager, who will list them on the BAWP Deferral letter.
- g. This process is authorized for use from LCPC to Definition.

3.5.5.3 BAWP Work Item Branding Categories.

- a. Branding Category A (Mandatory - Technical). An approved Deferral Letter or positive CDNS adjudication is required to defer the maintenance requirement (see Appendix AK). Only SURFMEPP or an authorized Technical Warrant Holder is authorized to brand items in this category. BAWP requirements in this branding category include maintenance actions which have high-level technical requirements and have been subdivided into branding categories as detailed in Appendix AN. Any “A” branded item whose deferral violates a technical requirement (e.g., CMP mandatory requirement) requires NAVSEA 05 adjudication via the CDNS or a Deferral Letter. Late, cancelled or deferred execution of a technical requirement may require a QA form 12 through the e-DFS system. See Volume V of this manual for guidance regarding DFS requirements.

- b. Branding Category B (Required - Non-Technical). Items in this branding category include tasks significant to TYCOM; however, non-accomplishment does not require adjudication via the technical chain of command. Work items in this branding category have been subdivided into branding categories as detailed in Appendix AN.

3.5.5.4 Branding Responsibility.

- a. SURFMEPP brands all technically-required, mandatory maintenance requirements residing in the CMP and any other tasks meeting branding Category “A” criteria. In addition, SURFMEPP will brand all Category “B” CMP issued tasks per Appendix AN.
- b. The Assessment Director is responsible for ensuring CSMP-ready repair AWRs are provided following assessment completion. In all cases, these AWRs will start the Block 35 narrative AWR with the words “Per (JCN)”, where ‘(JCN)’ is the Assessment JCN that generated the repair 2-Kilo followed by the characters “XXX” (e.g., “Per YYYYYEM01ZA56 “XXX”, where “YYYYY” is the ship’s Unit Identification Code and “XXX” signifies a break between the JCN and the beginning of the 2-Kilo’s text description). This methodology allows maintenance personnel to connect each repair job to its initiating assessment.

3.5.5.5 Change Request Types. Change Requests and Change Notifications will be identified in one of the following three ways:

- a. Reprogram. Requirements due during the current FRP Maintenance Cycle, but will be moved to a future FRP Maintenance Cycle. These requests shall be requested through the Deferral Letter Process.
- b. Cancel. Requirements neither applicable nor due during the current FRP Maintenance Cycle and therefore should not be included in the BAWP, including items for which the configuration or requirement has changed and requirements with periodicities extending to a future FRP Maintenance Cycle beyond C+120 of the current cycle.
- c. De-scope. Requirements that experienced a reduction in the original scope of work, where the portion of work not accomplished is reprogrammed.

3.5.5.6 Deferral Process for an “A” Branded Mandatory Requirement (Surface Force Ships Only).

- a. Deferral of an “A” branded mandatory task within the current FRP shall be requested from the Ship’s Design Manager and NAVSEA 05 by the Maintenance Team using the CDNS if it cannot be accomplished within 90 days of its due date.
- b. Deferral of an “A” branded mandatory task outside the current FRP shall be requested from the Ship’s Design Manager and NAVSEA 05 by the Maintenance Team using the deferral letter process if it cannot be accomplished within the current FRP.
- c. On approval of deferral of the task by NAVSEA 05 within the current maintenance cycle SURFMEPP will change the branding of the task from “A1” or “AR” to “AH”. SEA 05 will send the deferral recommendation to the TYCOM via SEA 21.
- d. On approval of the deferral and at the end of the current cycle, SURFMEPP shall change the brand from “AH” to “A6”. If the task cannot be accomplished in the second FRP, then the ship should initiate a request for a Major DFS in accordance with Volume V, Part I, Chapter 8 of this manual and request a technical review by SEA 05 and a programmatic review by SEA 21. If the review results in a recommendation to not defer, then a 2 Flag Panel review will be conducted between the TYCOM and either SEA 05 or SEA 21. The 2 Flag Panel will make the final adjudication. If disapproved by the 2 Flag Panel, then the task will be completed in the current FRP.
- e. On approval of deferral of the task to the third FRP, SURFMEPP shall change the branding from “A6” to “AD”.
- f. If the task cannot be accomplished in the third FRP and is requested for deferral to the fourth FRP, then a 3 Flag Panel review (TYCOM, SEA 05, SEA 21) is required. Flag level approval is required to defer the task to the fourth FRP. If disapproved by the 3 Flag Panel, then the task will be completed in the current FRP. The AD brand will remain until the task is executed or superseded.

3.5.6 Modernization (Surface Force Ships Only). NAVSEA and TYCOM Letters of Authorization (LOA) are issued identifying all modernizations scheduled for the CNO Availability.

3.5.6.1 Modernization List. Forecasted ship changes may be viewed through the NDE database at LCPC and continuing throughout the BAWP to AWP development process. This list will be reviewed at each BAWP Milestone Meeting. Items from this list will not be entered into the ship's CSMP until they have been reconciled with an issued Advance Planning Letter/LOA. After this reconciliation, SURFMEPP is responsible for entering the modernization work into the ship's CSMP. Category A and Category B BAWP-branded assessment tasks that may be affected by forecasted Ship Change Documents shall be planned and executed, despite discussion of removal or upgrade of equipment due to pending ship changes. Since the majority of "approved and authorized" modernization alterations are completed during the CNO availability, executing the assessments throughout the cycle as scheduled in the BAWP is required to ensure operational readiness throughout the FRP Maintenance Cycle. For example, NDE indicates CG-XX is scheduled for the electric modification SHIPALT 588K, which, among other changes, removes the waste heat boilers. The 18-month and five (5) year mandatory boiler inspections were entered in the BAWP at LCPC for completion during the SRA. The MT, in this case, cannot cancel the scheduled assessment without following the established deferral/adjudication process.

3.5.6.2 BAWP/AWP Update. The BAWP/AWP will be updated as subsequent LOAs are issued by NAVSEA and TYCOM as ship changes mature. This process will continue through the advanced planning and execution phases of the availability to capture late and newly authorized alterations.

3.6 AVAILABILITY EXECUTION.

3.6.1 Responsibilities. Responsibilities for CNO scheduled Maintenance Availabilities are as follows:

3.6.1.1 Fleet Commander.

- a. Monitor availability execution to achieve a balance of cost and schedule for the scope of work authorized. Ensure that any growth in the scope of work authorized is necessary to ensure safe, reliable operation of the ship during the subsequent operating cycle.
- b. Ensure that testing of all systems and equipment installed or repaired during the availability, which require at sea testing, is conducted prior to availability completion.
- c. Provide berthing, messing, offices, classrooms, equipment stowage space, and Ship's Force repair shops in accordance with reference (f), when shipboard facilities are unusable or uninhabitable.

3.6.1.2 Type Commander/Immediate Superior In Command (Group or Squadron).

- a. Authorize new items and growth industrial work items.
- b. Monitor and approve all changes in established milestones, not internal to industrial activity, including LOA and completion dates.
- c. Issue direction when the quality or completeness of industrial activity work is in question.
- d. Monitor off-ship crew messing and berthing arrangements when required.
- e. Notify the TYCOM when essential Ship's Force work cannot be completed on the scheduled contract or Key Event completion date. Make recommendations for assistance where appropriate.
- f. (Surface Ships Only). Periodically assess and monitor shipboard conditions using Appendix E of this chapter for guidance.
- g. (Submarines Only). Periodically assess and monitor shipboard conditions in accordance with paragraph 3.6.8.4.4 of this chapter.
- h. Monitor Ship's Force/MST (if assigned) preparation for LOA (if applicable).
- i. (Nuclear Powered Ships Only). Conduct a Pre-Critical Inspection of the Engineering Department to determine the ship's readiness for either the Reactor Safeguards Examination (RSE) or the Fleet Commander Post-Overhaul Reactor Safeguards Examination (PORSE) as applicable.

- j. (Submarines Only). Schedule a salvage inspection by Forces Afloat in time to have discrepancies corrected prior to the start of Fast Cruise. Normally, the salvage inspection should be completed not less than one week prior to the scheduled start of the Fast Cruise.
- k. Conduct formal Phase I crew certification inspection(s) of the Ship's Force in accordance with the TYCOM Training Manual (when required). The purpose of this inspection shall be to audit the readiness and training of the Ship's Force, particularly in the areas of watchstander qualifications, damage control readiness, status of operational and emergency bills, presence on board of essential technical manuals, and general operational knowledge. This inspection shall be scheduled about one month prior to Fast Cruise and should include written examinations and personal interviews with officers and key enlisted personnel to determine their readiness and status of training as outlined for Phase I. A comparison of personnel allowance (including Navy Enlisted Classification requirements) versus onboard count shall be made to ensure that the ship is adequately manned.
- l. (Submarines Only). Prior to Fast Cruise, the ISIC QA Officer shall conduct a formal audit of Ship's Force REC, Departure from Specification Records and CSMP. Using the SUBMEPP PMR and URO Maintenance Requirement Card (MRC) scheduling reports and current industrial activity/Ship's Force updates to the latest report, ensure all required "D"-Level PMR and URO MRC accomplishment is current. The ISIC shall forward the audit results to the TYCOM via the cognizant Commander, Submarine Group. The ISIC will then report to the TYCOM by message in accordance with message sample format of Appendix BB or CB of this chapter the status of the crew/material certification. An update of this certification is needed prior to Sea Trial and following the rescinding of certification noted in paragraph 3.6.8.4.1.c. of this chapter.
- m. Conduct Phase II crew certification. Witness and certify to the TYCOM that the state of crew training is satisfactory for at sea operations in accordance with the TYCOM Training Manual. This will be done during a two day period subsequent to Dock Trials and Phase I crew certification, and prior to Fast Cruise. This two day period shall be scheduled so that there is normally a 48 hour period between the end of this event and the beginning of Fast Cruise. This two day Phase II crew certification period is divided into a 40 hour crew work-up and rest period and an eight hour modified dockside Operational Readiness Inspection. The entire period should be scheduled to minimize interference with industrial activity work. However, since the certification must be conducted carefully to be meaningful, the officer scheduling the certification should coordinate industrial activity interference during the eight hour modified Operational Readiness Inspection. This certification should be thorough and meticulous. Pressure from the industrial activity or any other source to compromise ship safety must not be permitted to influence the judgment of the certifying officers. The desired overall sequence of these events is shown in Volume I, Chapter 2, Appendix B of this manual.
- n. Conduct a material inspection of the ship.
- o. Satisfactory completion of the inspections of paragraphs 3.6.1.2.k. through 3.6.1.2.m. of this chapter should be reported to the TYCOM in one "PRIORITY" crew certification message in accordance with sample message format of Appendix BB or CB of this chapter paralleled by a telephone call to the TYCOM Watch Officer reporting the date-time group of the message. If significant deficiencies exist or it appears that an extension of time is required to correct training/material deficiencies, the TYCOM shall be immediately advised by telephone and by message. The Supervising Authority will be included as an information addressee.
- p. Receive from the ship's CO/Supervising Authority the scope, schedule and agenda of tests for Sea Trials for review and approval. When approved, forward copies of the agenda to the TYCOM. The concurrence of NAVSEA is required for the sequencing and scheduling of nuclear propulsion plant Sea Trials for CNO Maintenance Availabilities.
- q. (Submarines only) Prior to Sea Trials, report material certification of the ship by message in accordance with message sample format of Appendix BB or CB of this chapter, to the TYCOM.
- r. Monitor the progress of the availability.
- s. (Submarines Only) If required, initiate Operating Cycle Extension Assessment in accordance with references (i) and (j).

3.6.1.2.1 Extended Operating Cycles. (Submarines only) An extended operating cycle is the period of time from the end of the current operating cycle to the anticipated start of the next major depot availability (Depot Modernization Period, Engineered Overhaul, Engineered Refueling Overhaul, Inactivation). The Interim Drydocking (IDD)/PIRA AWP is comprised of minimum maintenance requirements that are required to support the specific operating cycle extension, as well as necessary repairs based on the submarine's material condition.

- a. For extended operating cycles less than 24 months performed by naval shipyards, the TYCOM shall certify completion of IDD/PIRA availabilities. For extended operating cycles less than 24 months performed by private shipyards, the SUPSHIP, with assistance from NAVSEA, will certify completion of IDD/PIRA availabilities.
- b. For extended operating cycles of 24 months and greater, NAVSEA shall certify completion of IDD/PIRA availabilities.

3.6.1.3 Fleet Maintenance Activity. A scheduled CNO Maintenance availability may involve concurrent FMA repairs. During such availabilities, it is imperative that the industrial activity and the FMA involved maintain a close working relationship, both between themselves and Ship's Force, to ensure a successful, on-time availability completion. As a minimum, the FMA must:

- a. Carry out all FMA work consistent with the procedures described in Part I, Chapter 4 of this volume.
- b. Participate in all Weekly Management Meetings. (See paragraph 3.6.3.1 of this chapter.)
- c. Provide information on FMA Job Status for ship's Weekly Situation Report (SITREP). (See Appendices F₁ or F₂, as applicable, of this chapter.)
- d. Closely coordinate all jobs affecting Key Event/Milestone completion dates with the industrial activity and Ship's Force.
- e. Assist the industrial activity and Ship's Force by maintaining good housekeeping on all job sites.

3.6.1.4 Ship's Force and MST (if assigned).

- a. Support work authorization, tagout and REC programs.
- b. (Submarines Only) Ensure no work is conducted within the certified SUBSAFE boundaries without proper authorization.
- c. Monitor the quality of the industrial activity's performance.
- d. Support industrial activity test programs and witness equipment testing.
- e. Perform IEM.
- f. Ensure Ship's Force work is integrated into the industrial activities schedule.

NOTE: FLEET POLICY DOES NOT PROHIBIT SHIP'S FORCE FROM ACCOMPLISHING WORK ON EQUIPMENT, COMPONENTS OR SYSTEMS NOT OTHERWISE ASSIGNED TO THE INDUSTRIAL ACTIVITY AS LONG AS SUCH WORK DOES NOT IMPEDE THE INDUSTRIAL ACTIVITY SCHEDULE OR IMPACT PRIMARY SHIP'S FORCE RESPONSIBILITIES. THE MAJORITY OF PERSONNEL LEAVE, PARTICULARLY FOR THE WEAPONS AND ENGINEERING DEPARTMENTS, SHOULD BE PROGRAMMED EARLY IN THE AVAILABILITY SO THAT NECESSARY PERSONNEL WILL BE AVAILABLE FOR SUCH THINGS AS COMBAT SYSTEM TESTING, HOT OPERATIONS, ENGINE ROOM STEAMING, POWER RANGE TESTING AND FAST CRUISE.

- g. Train and qualify personnel to support the Key Event schedule.
- h. Perform site visits where contractor services are being used for equipment refurbishment.
- i. Ensure LOA preparations are progressing on schedule.
- j. Attend weekly progress meetings.
- k. Ensure that equipment returned to the ship has passed required shop tests.
- l. (Surface Ships Only) For dry docking availabilities:

- (1) Make sure that bilges are properly preserved. To avoid moisture from condensation, plan to complete bilge painting before the ship undocks.
- (2) Make sure that air testing scheduled for tanks below the water line is completed before the ship undocks.
- (3) Make sure that all hull valves are reinstalled and tested before the ship undocks.
- (4) Make sure that underwater preservation is completed, that water line boot is painted evenly and draft marks restored before the ship undocks.
- m. Arrange for a post repair boiler inspection by Naval Surface Warfare Center Carderock Division (NSWCCD), and ISIC representatives. Detailed information concerning this inspection can be found in Volume IV, Chapter 3 of this manual.
- n. Schedule Combat Systems Mobile Training Team visit with the ISIC.
- o. Develop a Plan of Action and Milestones for LOA.

3.6.2 Arrival Conference.

3.6.2.1 Scheduling and Conducting. The arrival conference is scheduled shortly after the start of an availability and conducted by the industrial activity and attended by the CO, Executive Officer, MST OIC (if applicable), heads of department and their principal assistants, key shipboard personnel and a TYCOM representative. This meeting also provides an excellent opportunity for Ship's Force to meet key industrial activity personnel.

- a. The conference agenda should include, as a minimum, the following topics:
 - (1) Resolve problems not completed at the WDC/PRC/PAC.
 - (2) A discussion of work scheduling and production planning requiring close cooperation between Ship's Force and industrial activity personnel. Changes to dates for Key Events such as dry docking, Dock Trials, Fast Cruise, and Sea Trials shall be made known and agreed upon at this time.
 - (3) Dissemination of planning information, such as job orders that have resulted from the deferral actions approved for industrial activity accomplishment.
 - (4) Resolution of any problems regarding work to be undertaken or material or scheduling problems.
 - (5) Reporting of plans and material status on Key Events or CPJs.
 - (6) Discussion of industrial activity regulations and other pertinent requirements affecting the ship.
 - (7) Dissemination of general administrative information of interest to Ship's Force, such as industrial activity and local facilities for training, recreation, housing accommodation, parking, etc.
- b. Activities may submit new work items for consideration.
- c. Industrial activity schedule daily/weekly meetings.
- d. Submit an Availability Start Message to cognizant Fleet Commander at the start of an industrial availability.

3.6.3 Routine Meetings and Conferences.

3.6.3.1 Weekly Management Meetings. Senior industrial activity management officials should meet weekly with the CO of the ship during the availability.

- a. Purpose. These meetings provide a formal means by which attendees can address important specific issues with the senior industrial activity official to obtain appropriate resolution. Questions not answered relative to the conduct of this meeting should be addressed by the CO through the ISIC (if applicable) to the TYCOM.
- b. Execution.

- (1) The industrial activity Senior Officer/Manager will designate the time and day of the week for the meeting.
 - (2) Attendees will submit agenda items normally within 24 hours before the meeting. The industrial activity will collect, collate, and prepare all agenda items in writing and distribute them to attendees at the meeting.
 - (3) Attendees will discuss agenda items at the meeting.
- c. Attendees. The industrial activity chairs the meeting. The following personnel shall attend and participate:
- (1) The CO of the ship being repaired. The Executive Officer should attend if the CO cannot be personally present for any meeting.
 - (2) At some industrial activities, the TYCOM may designate a representative to attend. If so, he may submit agenda items in addition to those submitted by CO's that may be broadly applicable to all ships in specific availabilities. In the record, there shouldn't be any "TYCOM Position" on any items. The CO has the responsibility to deal with the senior industrial activity official on problems relating to his ship.
 - (3) The industrial activity Project Manager or equivalent.
 - (4) (Nuclear Powered Ships Only). The Naval Reactor Representative at industrial activities authorized to conduct naval nuclear work.
 - (5) Industrial Activity Senior Management (e.g., Engineering Department Head, QA Head, Production Officer).
 - (6) Any industrial activity personnel as required to support specific agenda items.
 - (7) MST OIC (if applicable).
- d. General Guidelines.
- (1) Before submitting an agenda item, the ship CO should have made an attempt to resolve the problem at an appropriate level within the industrial activities organization.
 - (2) When agenda items are general subjects such as overall schedule adherence, overall industrial activity manning of ships, overall ship cleanliness, performance of workers and overall ship safety, sufficient factual data should be included to substantiate them.
 - (3) (Nuclear Powered Ships Only). Ship COs should not routinely submit their agenda items to the Naval Reactors Representative Office (NRRO) for review prior to giving them to the industrial activity's Senior Manager. This does not mean that specific questions related to agenda items cannot be discussed with the NRRO. They should be. Ship COs should not expect the NRRO to be a screen for checking the appropriateness of the item.
 - (4) Ship COs in private activities must be extremely careful in wording their agenda items, in the discussions at the meeting and in agreeing to words in the minutes to assure that they do not introduce or give tacit agreement to contractual matters.
 - (5) Ship COs should not submit items for the management meeting as a means to merely determine the status of a job.
 - (6) If required by the TYCOM, ship COs shall provide a copy of the minutes of each meeting to their ISIC/TYCOM.
- e. The Weekly Management Meeting is used as a forum to produce a Progress Report, which is intended to form a brief word picture of the availability progress and identify problems that may require action/resolution. (Paragraphs 1 and 2 in Appendices F₁ or F₂, as applicable, of this chapter should not exceed one typewritten page.)

- (1) If required by the TYCOM, COs will submit weekly Progress Reports by message of the overall status of work. As a minimum, quality of work, progress, significant problem areas, and action taken towards their resolution shall be addressed. In addition, if the availability completion or readiness-for-sea dates appear to be in jeopardy, the estimated period and reasons for delay will be reported and identified. The Progress Reports will be routed via the industrial activity and FMA (if applicable) for comments and transmitted in time to reach the TYCOM by the first workday of each week. Appendices F1 and F2, as applicable, of this chapter are the desired format for the report.
 - (2) If, as a result of his inspections, the CO considers that the progress or the quality of work is unsatisfactory, he will promptly bring the matter to the attention of the industrial activity. If satisfactory corrective measures are not taken, he will report by letter, or if time is critical, by message, to the TYCOM with a copy to the industrial activity stating specifically in what respects the work is unsatisfactory. If the condition reported is not corrected to the CO's satisfaction, a report will be made to CNO via the TYCOM in accordance with reference (g). Copies of this report will be sent to the industrial activity and appropriate Fleet Commander.
 - (3) During the course of the availability, periodic progress reviews are conducted at the 25/50/75 percent points of elapsed time of the availability. As a minimum, discussion should include the actions towards resolution of previously reported significant problem areas not yet resolved, upcoming Key Events that may be in jeopardy, any significant changes that may be required to meet availability milestones, status of new work and any other issues deemed necessary. The report of the periodic review will be annotated in the weekly SITREP.
- f. Cost Performance Index/Schedule Performance Index (Surface Force Ships Only). In accordance with Volume VII, Chapter 7 of this manual, the RMC shall report Cost Performance Index and Schedule Performance Index.

3.6.3.2 Docking/Undocking Conferences. For availabilities involving a ship's dry docking, the industrial activity will conduct both a Docking and Undocking Conference, normally within one week prior to the expected evolution. These conferences will be conducted by the assigned industrial activity Docking Officer. Requirements for the conference agenda, attendees, and Ship's Force support are found in reference (k).

3.6.3.3 Interim Completion Conferences (Surface Force Ships Only). The NSA and the Lead Maintenance Activity (LMA) shall conduct 25/50/75 percent completion conferences. These conferences will review all completed work, testing and certification. All open and remaining work shall be discussed to include: schedule, upcoming key events, milestones, planned production manning versus actual production manning, integrated test plan, certification and Departures From Specification. All open and inspect work shall be completed in the first 20 percent of the maintenance availability. Two days prior to the 25 percent review conference, the LMA shall provide the status of all open and inspect results so final adjudication on any growth or new work items may be completed.

3.6.4 Assist Ship's Force Funds. The TYCOM may set aside a portion of the maintenance funds for CNO availabilities as an Assist Ship's Force (ASF) fund. This fund is controlled by the CO and is used to obtain minor industrial activity assistance in the nature of services and/or labor, to assist in completing assigned Ship's Force work. The following restrictions apply to the use of ASF funds:

- a. No work in the nature of an alteration will be undertaken, unless authorized by the TYCOM.
- b. No work using ASF funding will be undertaken in which Ship's Force is not the main participant.
- c. Only incidental material will be purchased with ASF funds. "Incidental Material" cost, when measured against the cost of labor on each specific ASF work item, will not exceed ten percent of the total job cost without TYCOM permission.
- d. A detailed account of ASF expenditures will be maintained. This account may be audited periodically by the TYCOM to ensure compliance with the restrictions in paragraphs 3.6.4.a. through c of this chapter.

3.6.5 Integrated Logistics Overhaul.

- a. The ILO concept was developed to provide improved maintenance support to the Fleet in response to the need for complete on board logistics support. An ILO focuses on both maintenance and supply requirements by ensuring that technical documentation and repair parts support the equipment which is actually on board. During an ILO, both maintenance and supply personnel are trained in the use and maintenance of shipboard logistics support documentation and systems to enable them to sustain the effects of the ILO during the operating cycle. The objective of an ILO is to improve readiness by providing a ship completing a specified availability with logistics support that accurately reflects the ship's configuration. A secondary objective is to train Ship's Force in the use of on board support documents and in recognizing and correcting support deficiencies.
- b. An ILO is a process which improves ship's readiness and equipment availability through verification of configuration status accounting data, ordering of proper logistics support, and training of Ship's Force in the use and maintenance of its logistics support documentation. An ILO is comprised of five functional elements:
 - (1) Configuration Analysis and Coordinated Shipboard Allowance List (COSAL) QA consists of verification of start of availability configuration data (including planned changes) with Weapons System File data and other documentation to ensure that the Start of Overhaul COSAL fully supports the projected end of availability equipment configuration. In addition, changes in configuration reported by the accomplishing activity are verified to ensure final COSAL documents include required support.
 - (2) PMS Analysis. Includes verification of applicable Maintenance Index Pages (MIP) with ship's existing configuration and all changes to this configuration reported by the accomplishing activity. Resolution of discrepancies with PMS managers is accomplished as required. Analysis of individual MRCs is performed to ensure that required PMS repair parts and special tools are identified, included in the applicable documents, and ordered.
 - (3) Technical Manual Analysis. Ensures that the technical manuals required to support the end of availability configuration are identified and requisitioned. Technical manuals, both those off-loaded and those received during the availability, are inventoried and reviewed for applicability, correct change level, and status of changes. Technical manuals applicable to final configuration are retained. Discrepancies are resolved with the Naval Sea Data Support Activity. Technical manuals missing from the required inventory are requisitioned as are any changes needed to upgrade manuals already held. The ship's Index of Technical Publications is updated to reflect the final configuration and is provided to the ship at the end of availability by the Naval Sea Data Support Activity. Also provided are the Technical Manual requisitions still outstanding. Finally, to ensure minimum deterioration of stock after the availability, selected ship personnel are trained in technical manual maintenance procedures.
 - (4) Repair Parts Analysis. Ensures the accuracy of the repair parts inventory to be back loaded to the ship at the conclusion of the availability. This analysis includes a complete inventory of all parts aboard and identification of any parts for which there is incomplete data. It also includes recomputation of allowances based on usage or new equipment installation, turn-in of parts no longer allowed and numerous location/quality checks prior to backloading.
 - (5) Training. Focuses on proper accomplishment of the first four functional elements of the ILO to ensure that correct logistics support is identified and delivered for shipboard equipment. Efforts are made to ensure that shipboard personnel are fully able to utilize and maintain the ship's logistics support and configuration documentation, both for ILO purposes and for ongoing operating cycle requirements. COSAL use and maintenance training provides shipboard personnel with a working knowledge of the COSAL, its relationship to other maintenance documents and the procedures to ensure that logistics support remains current, (e.g., use of OPNAV 4790/CK Forms).
- c. The Ship's Force team will develop an off-load schedule of all ship's spare parts. The ship's spare part stowage plan will be updated to reflect changes in the desired location of individual spare parts. Additionally, provisions must be made for the Aviation Consolidated Allowance List to support the embarking air wing.

- d. A ship load-out schedule, including stores, repair parts, yellow gear, and removal of industrial activity equipment, will be prepared by the ship with the assistance of the industrial activity.
- e. During a CNO maintenance availability, the ship will ensure that new/removed equipment is reflected in the COSAL and that the required spare parts are added/subtracted as applicable. Allowance changes are to be requested in accordance with reference (I).
- f. Spare parts, test equipment, and special tools are the hardware portion of new and old equipment. The other portions are software: drawings, technical manuals, allowance lists, operating instructions, and any other technical documentation. Prior to commencement of an availability, NAVSEA will task the industrial activity with providing a listing and schedule, for installation on board the ship, of all technical documentation for new equipment, including changes to SSR drawings and data. The ship is responsible for the installation and maintenance of technical documentation for all existing equipment.
- g. The status of the installation of technical documentation will be reported in the Material Condition/Crew Readiness Status Report.

3.6.6 Ship's Selected Records.

- a. The SSRs include various tables, charts, drawings, damage control books and plates, technical manuals and other data selected for their reference value and kept current throughout the life of the ship. Accurate SSRs are necessary for configuration control, maintenance support and troubleshooting. SSR items are:
 - (1) Ship's Information Books.
 - (2) Technical Manuals.
 - (3) Damage Control Books and Plates.
 - (4) Propulsion Operating Guides/Engineering Operational Sequencing System.
 - (5) Ship's Drawing Index (SDI).
 - (6) Index of Technical Publications.
 - (7) Docking Drawings (plan showing each of the docking positions).
 - (8) Booklet of General Drawings.
 - (9) Tank Capacity and Vehicle Center of Gravity Curves.
 - (10) Tank Sounding Tables.
 - (11) Other tables, charts, allowance lists, etc.
 - (12) Docking Reports (most recent two industrial availability dockings, and any interim reports).
- b. The ship should appoint a SSR Coordinator for the availability. The Coordinator should review the SSRs in paragraph 3.6.6 of this chapter, determine which items will be affected by work candidates listed in the approved work package, and send copies of these SSRs to the industrial activity responsible for executing the availability. The copies sent must include markups showing any changes accomplished during previous availabilities since last update. The ship must retain a master copy of each SSR item and keep it current. If SSR is on microfilm/electronic media, mark up hard copy prints.
- c. The SSR Coordinator will serve as the ship point of contact for dispatch, receipt and monitoring status of SSR items during the availability.

3.6.7 New Work.

- a. New work is any maintenance requiring industrial level assistance which is not authorized until after contract award or definitization.

- b. New work must be requested by message or letter to the appropriate TYCOM (information copy to the Supervising Authority, ISIC, SUBMEPP (Submarines), or PMS 312C (Aircraft Carriers), as applicable). Sample letter/message formats are provided in Appendices G and H of this chapter for requesting new work authorization. Work not currently in ship's CSMP must be added to CSMP prior to requesting new work approval.
- c. All new work candidates must be reviewed by and agreed to by the assigned Ashore Ships Maintenance Manager, Project Manager or Program Manager. Ashore Ships Maintenance Manager and Program Manager recommendations regarding requirement to perform repairs, risk assessment, and schedule impact are mandatory. The TYCOM, or the formally designated TYCOM representative, shall be the final approving authority for all new work. For Surface Force Ships only, the NSA Chief Engineer will review requested new work items and determine whether or not they are technically required and/or required to achieve minimum material readiness requirements. In the case of private industrial activity availabilities, the TYCOM will certify that, in accordance with Federal Acquisition Regulations, the accomplishment of the new work is of such unusual and compelling urgency so as to require waiving of Competition In Contracting Act public law regulations.

3.6.8 Trials, Inspections and Crew Certification.

3.6.8.1 Surface Force Ship.

- a. Crew Certification. Crews in ships undergoing major CNO Maintenance Availabilities must be effectively trained in standard operating procedures, emergency bills, casualty drills, etc., and be thoroughly cognizant of equipment either newly installed or relocated during the availability. Based on the length and type of availability, Crew Certifications will be conducted in accordance with references (m), (n) and (o), as applicable.
- b. LOA. LOA will be conducted, if the availability exceeds 120 days or as deemed necessary by the TYCOM. The ISIC, assisted by an assessment team provided by Fleet Commander N7, will conduct the LOA. LOAs will be scheduled by means of the ISICs input into the normal scheduling process.
- c. Steam Testing. All steam systems/equipment worked by the industrial activity shall be tested in accordance with the Testing Plan developed by the industrial activity. Ship's Force shall work closely with the industrial activity, providing necessary assistance and support, to carry out the Test Plan.
- d. Dock Trials. During an industrial activity availability and prior to conducting post-repair trials, the engineering plant shall be tested to ensure its readiness for sea. All special sea details and required general quarters will be manned throughout the trials. Ordinarily, dock trials can be completed in one day or less. The minimum requirements for Dock Trials are listed in Appendix I of this chapter.
- e. Fast Cruise.
 - (1) All ships completing a CNO Maintenance Availability shall conduct a Fast Cruise where the ship assumes, insofar as practical, an "at sea" posture while inport with all equipment/systems used to the maximum extent possible. The primary purpose of the Fast Cruise is to determine and certify the state of training of ship's company as adequate to conduct at-sea operations. The progress toward this goal is a critical evolution ongoing throughout the availability requiring the TYCOM and ship's CO attention. The training program must be designed to have completed all training necessary to safely operate the ship at sea prior to Fast Cruise. The Fast Cruise provides the opportunity to measure ship's preparedness; it is not a basic training period. Commencement of Fast Cruise requires TYCOM permission. Appendix AA of this chapter provides a sample message format for Ship's Request for Permission to Commence Fast Cruise.
 - (2) The following procedures pertain to the conduct of Fast Cruise:
 - (a) Fast Cruise will be included as a major event and scheduled for at least two days duration by the industrial activity in the case of ships undergoing a CNO maintenance availability greater than six months in duration or at least one day for ships undergoing a CNO maintenance availability less than six months in duration. The Fast Cruise shall follow Dock Trials and precede Sea Trials.

- (b) A schedule of proposed events shall be promulgated by the ship to all activities concerned and shall be concurred with by the industrial activity.
 - (c) Limited numbers of industrial activity personnel may be permitted to be aboard as necessary to continue testing and production work on systems as required. Shop and technical personnel shall be permitted on board as instructors, troubleshooters and QA representatives of the industrial activity. Equipment that is not complete shall not be included in the Fast Cruise. Settlement of the foregoing provisions shall be reached by mutual agreement between the CO and the industrial activity, as warranted.
 - (d) As a minimum standard, system operation tests and drills described in Appendix J of this chapter shall be conducted in all Fast Cruises. It is intended that the necessary prerequisite training shall have already been accomplished.
- (3) The Ship's CO will report completion of Fast Cruise to the TYCOM. Appendix AB of this chapter provides a sample message format.
- f. Rest and Repair Period. All ships completing a CNO Maintenance Availability shall normally conduct a 48 Hour Rest and Repair Period to ensure Ship's Force is mentally and physically prepared after completing Fast Cruise and before the start of Sea Trials. The primary purposes of the Rest and Repair Period are to evaluate the results of Fast Cruise; to consider ship condition; to conduct necessary repairs on ship's equipment and systems; and to evaluate and conduct additional training for Ship's Company to ensure the ship is prepared to the highest possible standard.
- g. Sea Trials.
- (1) Sea Trials (or Post Repair Trials) constitute the final determination of a ship's material readiness and ability to rejoin the Fleet as a fully operational unit. Each Sea Trial will be conducted in accordance with an agenda prepared by the industrial activity, concurred with by the ship's CO, and approved by the TYCOM. The Sea Trial Agenda will be prepared in four phases and will contain the minimum requirements of Appendix K of this chapter, a time-oriented sequence of events in Gantt chart form, and a matrix of fleet services required to support the trial. The requesting ship/industrial activity will arrange for these Fleet services in accordance with Fleet Commander Instructions. Since the purpose of the trial is to determine the material readiness of the ship, all systems/equipment overhauled by the industrial activity will be tested in accordance with an industrial activity prepared test procedure which will document the results of the test and require operation of the system/equipment in all modes. A Ship's Force Trial Officer will be appointed to coordinate with the industrial activity Trial Coordinator throughout the Sea Trial. The Trial Officer will accept the results of all tests for the ship. Ship's Force personnel will operate all equipment during the Sea Trial in accordance with standard operating instructions or Sea Trial test procedures, as appropriate. Commencement of Sea Trials requires TYCOM permission. Appendix AC of this chapter provides a sample message format for the Supervising Activity to report all work necessary for Sea Trials has been satisfactorily completed.
 - (2) During Sea Trials the ship's CO will advise the TYCOM of major events accomplished and/or significant problems encountered/outstanding on a daily basis. Appendices F₁ or F₂ as applicable, of this chapter provide the desired format for this report.

3.6.8.1.1 Availability Work Certification and Completion Requirements (Surface Force Ship Only). Timely and technically correct planning and execution of availabilities demands a rigorous approach to certifying major Key Events leading to availability completion. A NSA certification plan verifies that work is completed and technically correct and must include Executing Activity qualifications, NSA approval of mandatory technical requirements, an integrated test plan and adequate NSA oversight of all availability work. These elements provide the NSA with maximum reasonable assurance that availability work is complete and technically correct. Executing Activity work completion starts with assurance that each Executing Activity has an approved and current Quality Management System. Each Executing Activity must provide certification of technically correct work completion and Objective Quality Evidence (OQE) as required in NAVSEA Standard Items or other technical requirements. NSA work oversight must include a minimum level of supervision to provide assurance that all mandatory technical requirements have been met and sufficient review of work specifications, integrated test plan, technical work

documents, audit of work items, in-process surveillance (Planning Review (PR), Procedures Evaluation, Product Verification Inspection (PVI)) and review of OQE. The NSA shall utilize a risk-based availability QMP as discussed in Volume VII, Chapter 11 and Appendix R. NSA certification includes assurance that technical review/approval has been conducted on all OQE for work items requiring mandatory technical review. NSA certification includes technical review and approval of all waivers and deviations by the NSA CHENG. This includes assurance that any exceptions to completion have been approved as to not adversely impact Key Event completion.

3.6.8.1.2 Key Event/Milestone Readiness (Surface Force Ship Only). Minimum Key Events/Milestones that require certification and prerequisite lists to assure proper completion are listed below. These Key Events constitute the critical availability completion events for the crew to transition from the maintenance phase to an operational phase. Certification of required work and testing supporting each Key Event/Milestone shall be accomplished using a detailed prerequisite list. Appendix Q will be tailored for each Key Event/Milestone and be used to certify work required for each specific Key Event/Milestone. In addition to giving the NSA reasonable assurance that work accomplished is technically correct to support the specific Key Event/Milestone, certification of Key Events/Milestone assures that certification for Fast Cruise/Sea Trial is properly completed to certify the availability. The NSA will normally designate the LMA to develop and track an Event Readiness List utilizing NAVSEA Standard Items 009-60 and 009-67. The Event Readiness List will consist of all prerequisites including work items and actions to be completed by the NSA and all executing activities that have been associated with the Key Event/Milestone. These associations shall include technical connections (technically required to support follow-on training/testing) and strategic ties (work deemed relevant by the maintenance team as required to meet the Key Event). Appendix Q will be tailored to the Key Event and utilized by the NSA for Undocking, Propulsion Plant PCD/Combat Systems PCD, Dock Trials and work completion and certification by all maintenance activities. In lieu of Naval Message, a signed letter/memorandum or centrally managed exception list may be utilized to document completion of all prerequisites for the Key Event/Milestone. If there are exceptions to completion, exceptions will be clearly identified and concurred with by Technical Authority. The Project Manager, Ship's CO, TYCOM, Port Engineer and the NSA will sign the letter/memorandum or centrally managed list for the record noting agreement with Key Event/Milestone completion, including listed exceptions. When memoranda are used as an exception list, sample letters/memorandums (Appendix AD through AJ) shall be tailored to each Key Event and used to certify that work and testing is complete.

- a. Interim Completion Conferences. Milestone to document the availability completion percentage. For these Milestones, the maintenance team shall review and document work listed as complete and verify against OQE and proof of work certification. The emphasis for the maintenance team shall be to certify all work as soon as possible after completion. For any work listed as complete, there shall be follow-on status entries to document OQE on file and completion of Work Certification. If OQE and Work Certification have not been completed, there shall be follow-on status entries to document when it is scheduled to be performed.
- b. Undocking. Key Event to document that the ship is ready in all aspects for Undocking. The NSA Chief Engineer must certify all related work and testing is completed prior to commencing the ship's Undocking, with any exceptions noted and approved by the appropriate technical authority and agreed to in writing by the Ship's CO, TYCOM and the NSA.
- c. Engineering Plant Production Completion Date. Key Event scheduled prior to Propulsion Plant Hot Operations to document that all production work effecting the minimum equipment requirements for LOA is completed and certified up through Stage 2 testing per reference (p). Stage 2 testing is accomplished prior to operation of installed or relocated equipment, cabling, piping, ventilation etc., to ensure that each installation has been accomplished in accordance with established plans and specifications. PCD includes all required reports and OQE have been submitted to, reviewed and approved by the NSA Chief Engineer. The NSA and LMA are responsible for thorough and rigorous management of this Key Event and minimizing exceptions. In the event of incomplete work, an evaluation by the Ship's CO, NSA and TYCOM must be performed to determine if the incomplete work will impede uninterrupted preparations and accomplishment of LOA. Exceptions must be approved by the NSA Chief Engineer and agreed with in writing by the Ship's CO. PCD is scheduled to provide the crew sufficient time to prepare and train for LOA, and to shift from a maintenance to an operations environment.

- d. Combat Systems Production Completion Date (AEGIS Light Off for AEGIS Ships). CSPCD and AEGIS Light Off are Key Events to validate and document the completion of all non-Ship's Force work (which includes testing and inspections) required before returning Combat Systems to Ship's Force for testing, training and operations. This includes that all required reports and OQE have been submitted to, reviewed and approved by the NSA Chief Engineer. Exceptions must be approved by the appropriate NSA technical authority and agreed with in writing by the Ship's CO. This ensures that Combat Systems equipment and associated spaces are turned over to the crew by a pre-designated date that allows them sufficient time to shift from a maintenance environment back to operations. It allows for training in preparation for required Combat Systems Readiness Assessments and Certifications.
- e. Dock Trials. Key Event conducted during an industrial activity availability prior to Fast Cruise to determine the ability of a ship's readiness for sea and capability to safely conduct Sea Trials. The NSA and LMA are responsible for conducting integrated dockside system testing, with special sea and anchor detail and general quarters manning to ensure system readiness for sea. The NSA Chief Engineer must certify all required work and testing is completed prior to commencing Dock Trials, with any exceptions noted and approved by the appropriate technical authority and agreed to in writing by the Ship's CO, Project Manager, TYCOM and the NSA. The minimum requirements for Dock Trials are listed in Appendix I.
- f. Fast Cruise. Key Event conducted after Dock Trials and prior to Sea Trials during which Ship's Force operates the ship and all equipment and systems as if underway for in port training. The primary purpose of the Fast Cruise is to ensure that Ship's Force operational proficiency is adequate prior to conducting at-sea operations. The Ship's CO is responsible for conducting Fast Cruise prior to Sea Trials where the ship assumes an "at-sea" posture to exercise all equipment and systems to the maximum extent possible. The NSA Chief Engineer must ensure that all work is completed and certified prior to commencing Fast Cruise, with any exceptions noted and approved by the appropriate technical authority and agreed to in writing by the Ship's CO, TYCOM and the NSA. The minimum requirements for Fast Cruise are listed in Appendix J. Commencement of Fast Cruise requires TYCOM permission. Appendix AA provides a sample message format for ship's request for permission to commence Fast Cruise. Appendix AB provides a sample message format for ships to report Fast Cruise completion.
- g. Sea Trials. Key Event following Fast Cruise that constitutes the final determination of a ship's material readiness and ability to rejoin the Fleet as a fully operational unit. The Ship's CO is responsible for conducting Sea Trials in accordance with an agenda developed by the NSA, concurred on by the Ship's CO and approved by the ISIC. The NSA Chief Engineer must certify that all required work and testing is completed prior to commencing Sea Trials, with any exceptions noted and approved by the appropriate technical authority and agreed to in writing by the Ship's CO, TYCOM and the NSA. The minimum requirements for Sea Trials are listed in Appendix K. Commencement of Sea Trials requires TYCOM permission. The NSA Chief Engineer must certify to the TYCOM that all work and testing is complete and readiness to start Sea Trials (with exceptions noted) via the Readiness for Sea Trials message. Appendix AC provides a sample message format for the Supervising Activity to report all work necessary for Sea Trials has been satisfactorily completed. Completion of Sea Trials requires a formal report from the Ship's CO to the TYCOM via the ISIC.
- h. Availability Completion. Key Event to document all work, testing and inspections planned for and executed during the availability are complete and that all required reports and OQE have been submitted to, reviewed and approved by the NSA Chief Engineer. Availability Completion signifies that the availability is complete and the ship has successfully determined that all maintenance and modernization work performed by the NSA is fully operational. The NSA Chief Engineer must certify all work tied to the Key Event is completed per the Availability Work Certification process or technically adjudicated in writing prior to reporting Availability Completion.

- i. End of Maintenance Phase. Milestone to document the end of the Maintenance Phase and entrance into the Basic Training Phase. The Maintenance Phase exit criteria for equipment shall include, but not be limited to: successful passing of Readiness Assessments and Certifications for non-Engineering systems (i.e. AEGIS Light-Off, Aviation Certification, TSRA, etc.), and a Light-Off Assessment for Engineering systems, and successful completion of comprehensive post-Availability Sea Trials that tests all systems. Minimum Equipment (Redlines) must be met and maintained for all Mission Areas.

3.6.8.1.3 Availability/Key Event/Milestone Certification Procedures (Surface Force Ship Only).

- a. The procedures outlined in the following sections provide the minimum requirements to (RMCs/NSA) to utilize during execution of CNO Availabilities and major Continuous Maintenance Availabilities (as directed by the Fleet or TYCOM) for Availability Certification and Key Event/Milestone Management. This process is developed to provide the RMC Commander, via the RMC Project Manager and RMC CHENG, the maximum reasonable assurance that all availability work has been properly completed and that the ship is materially ready for the next Key Event or Sea Trial. This process provides assurance that all technical waivers/deviations have been reviewed and approved, any work exceptions (incomplete work) have been approved to not impact the Key Event/Sea Trials and work was planned, executed and tested technically correct.
- b. The following process defines the steps to be taken by the NSA and all Executing Activities when certifying work to support readiness for Key Event/Milestone. When Key Events/Milestones are accomplished sequentially and in conjunction with a tailored availability QMP, (Appendix R), this process will support incremental certification of Readiness for Fast Cruise/Sea Trials and Availability Completion and avoid late gathering of data and certifications to ensure readiness for Fast Cruise/Sea Trials. Certification may be tracked via a centralized signature sheet and central exceptions list or through each Executing Activity providing memoranda documenting work certification and exceptions. When memoranda are used, the Appendix Q signature sheet and Appendix AD through AJ certification letters/memorandums shall be collected in an Availability Certification Book maintained by the Project Support Engineer on the Project Team. Normally, the Project Support Engineer works closely with the Integrated Test Engineer to manage the availability certification process for the Project Manager. The paragraphs below describe minimum requirements associated with each action leading to certification.

3.6.8.1.4 Availability Certification Requirements and Procedures (Surface Force Ship Only).

- a. Work Authorization. This step is required for Fast Cruise/Sea Trial Certification and Availability Completion Certification, but is not normally required for Key Event/Milestone Certification. TYCOM work authorization is screened and brokered by availability vice by availability Key Event. TYCOM certification of work authorization may be completed prior to Fast Cruise/Sea Trial and does not need to be repeated prior to availability completion unless new/growth work is identified during Sea Trials which is required to be added to the AWP as a condition of availability completion.
 - (1) The TYCOM's agent (Port Engineer) or Business Agent SRF-Japan Regional Maintenance Center (JRMC) will certify that all authorized CNO Availability or Continuous Maintenance Availability work identified in the AWP has been tasked to the Prime Contractor (PSIA or Firm Fixed Price), Naval Shipyard (NSY), FMA, Alteration Installation Team (AIT) or Ship's Force.
 - (2) The TYCOM's agent (Port Engineer) or Business Agent (SRF-JRMC) will certify that all work identified after work package definition (new/growth work) has been branded and authorized for accomplishment or deferred. If work branded as "A" or technically mandated as required to be deferred, it must be concurred on by the waterfront Technical Warrant Holder (NSA CHENG).
 - (3) The TYCOM's agent (Port Engineer) or Business Agent (SRF-JRMC) will certify that a review has been accomplished on all existing deviations, waivers, and records of out-of-commission equipment. This review shall include all conditions resulting in Temporary Standing Orders (TSO), DFSs and Casualty Reports (CASREP). Deviations have either been

- included in the AWP or an extension of the technical deviation has been submitted to the NSA CHENG for approval and concurred on by the TYCOM. If the condition resulting in a TSO or CASREP does not require technical concurrence for extension, the TYCOM must concur with not correcting the condition that resulted in the TSO or CASREP.
- (4) Prior to Fast Cruise/Sea Trial, the TYCOM will certify to the NSA via signature on central signature sheet or serialized letter/memorandum that the above conditions have been met. Exceptions will be noted and provided for approval by the NSA.
 - (5) The NSA/RMC certification signature will be provided by the Project Manager with the TYCOM signature or letter/memorandum and serial number noted, verifying receipt of TYCOM certification or proper work authorization accomplished.
- b. Work Documents Issued/Prime Contractor. (This step shall be completed by Key Event/Milestone for work tied to each Key Event/Milestone.)
- (1) Code 200 & 130 Review of Work Specifications and Test Procedures. The RMC/NSA Code 200 Project Support Engineer or Test Engineering (SRF-JRMC) and RMC/NSA Code 130 Quality Assurance Supervisor (QAS) will validate that Work Specifications and Test Procedures issued by the Master Ship Repair Contractor have received a technical review in accordance with RMC attributes checklist. At a minimum, work specifications will receive technical review in accordance with approved Availability QMP requirements and as outlined in Volume VII, Chapter 11, paragraph 11.2.3 of this manual.
 - (2) Code 300 Review of Work Specifications and Test Procedures. The RMC/NSA Project Manager shall validate that all work specifications and test procedures issued by the prime contractor have received a government review for compliance with contractual requirements in accordance with Volume VII, Chapter 4, Appendix E of this manual and approved in the appropriate maintenance database.
 - (3) Contractor Furnished Reports (CFR). The RMC/NSA Project Manager will verify that all required CFRs have been received as required by NAVSEA Standard Item 009-01, paragraph 3.2.
 - (4) CFRs. The RMC/NSA Project Support Engineer will verify that all CFRs requiring Code 200 action have been reviewed and answered, all deferred maintenance action and/or test result CFRs have been technically adjudicated, and all CFRs screened to Code 200 for action have been documented via Engineering Service Request (ESR).
- c. Key Event/Availability Completion/Prime Contractor. (This step shall be completed by Key Event/Milestone for work tied to each Key Event/Milestone.) The prime contractor will provide to the NSA a signed letter/memorandum (Appendix AD) or sign a centrally managed list certifying all authorized work is completed satisfactorily, with any exceptions noted. Exceptions must be itemized and technically approved by the RMC/NSA CHENG as to not impact Key Event/Milestone completion or Readiness for Sea Trials. Exceptions must include a plan for accomplishment. Testing scheduled to be conducted on Sea Trials does not need to be itemized on this letter/memorandum or centrally managed list, but can be referred to as “except testing included on Sea Trials agenda.” Signature of the centrally managed signature sheet or a letter/memorandum will be received prior to Key Event/Sea Trials. The RMC/NSA Project Manager will sign the signature sheet acknowledging receipt of letter/memorandum and noting serial number or signed list as noted above.
- d. Key Event/Availability Completion/FMA (I-Level). (This step shall be completed by Key Event/Milestone for work tied to each Key Event/Milestone.) The FMA/RMC Code 900 will provide to the NSA assigned letter/memorandum (Appendix AE) or sign a centrally managed list certifying that all Formal Work Packages/Controlled Work Packages (FWP/CWP) and test procedures planned and accomplished by the FMA are technically correct and completed. Exceptions will be noted and technically approved by the RMC/NSA CHENG as to not impact Key Event/Milestone completion or Readiness for Sea Trials. Exceptions must include a plan for accomplishment. Testing scheduled to be conducted on Sea Trials does not need to be itemized on this letter/memorandum or centrally managed

- list, but can be referred to as “except testing included on Sea Trials agenda.” The RMC/NSA Project Manager will sign the signature sheet acknowledging receipt of letter/memorandum and noting serial number or signed list as noted above.
- e. Key Event/Availability Completion/NSY. (This step shall be completed by Key Event/Milestone for work tied to each Key Event/Milestone.) The NSY Project Superintendent will provide to the NSA a signed letter/memorandum (Appendix AF) or sign a centrally managed list certifying that all TWDs and test procedures planned and accomplished by the NSY are technically correct and completed. Exceptions will be noted and technically approved by the RMC/NSA CHENG as to not impact Key Event/Milestone completion or Readiness for Sea Trials. Exceptions must include a plan for accomplishment. Testing scheduled to be conducted on Sea Trials does not need to be itemized on this letter/memorandum or centrally managed list, but can be referred to as “except testing included on Sea Trials agenda.” The RMC/NSA Project Manager will sign the signature sheet acknowledging receipt of letter/memorandum and noting serial number or signed list as noted above.
 - f. Key Event/Availability Completion/AIT. (This step shall be completed by Key Event/Milestone for work tied to each Key Event/Milestone.) Each AIT On-Site Installation Coordinator will provide to the NSA a signed letter/memorandum (Appendix AG) or sign a centrally managed list certifying that respective AIT work and test procedures are technically correct and complete, with exceptions noted. Exceptions must be itemized and technically approved by the RMC/NSA CHENG as to not impact Key Event/Milestone completion or Readiness for Sea Trials. Exceptions must include a plan for accomplishment. Testing scheduled to be conducted on Sea Trials does not need to be itemized on this letter/memorandum or centrally managed list, but can be referred to as “except testing included on Sea Trials agenda”. Signature of the centrally managed signature sheet or a letter/memorandum will be received prior to Key Event/Milestone. The Project Manager or AIT Manager (if assigned) will sign the signature sheet acknowledging receipt of letter/memorandum and noting serial number or signed list as noted above.
 - g. Key Event/Availability Completion/Ship’s Force (SF). (This step shall be completed by Key Event/Milestone for work tied to each Key Event/Milestone.) Ship’s Force CO will submit to the NSA a signed letter/memorandum (Appendix AH) or sign a centrally managed list certifying all Ship’s Force FWPs and CWPs are technically correct and complete to support Key Event/Milestone completion or readiness for Fast Cruise/Sea Trials. At a minimum, this certification shall include a review of:
 - (1) Ship’s Force Work Package derived from the CSMP.
 - (2) Inactive Equipment Maintenance is properly performed.
 - (3) TSO review.
 - (4) PMS review, including all checks to remove equipment/systems from IEM.
 - (5) Pre-underway or Pre-Event check-off list checks are complete.
 - (6) The RMC/NSA Project Manager will sign the signature sheet acknowledging receipt of Ship’s Force CO letter/memorandum and noting serial number or signed list as noted above.
 - h. Key Event/Availability Completion/RMC Engineering. (This step shall be completed by Key Event/Milestone for work tied to each Key Event/Milestone.)
 - (1) RMC/NSA CHENG to certify that all work assigned has been tasked and properly executed prior to Fast Cruise/Sea Trials and at the end of an availability where RMC is the NSA. This process also ensures that there are no outstanding technical waivers/deviations or QA deficiencies that have not been properly adjudicated and identifies any exceptions to completion, including work or testing that will occur after Sea Trials completes and assures these work items have been technically adjudicated to prevent adverse impact on availability completion.
 - (2) RMC/NSA CHENG shall certify that all assigned assessments (TSRA) or Fleet Technical Assists (FTA) tied to Key Event/Milestone or Fast Cruise/Sea Trial are completed. If TSRA assessments or FTA are ongoing, the RMC/NSA CHENG will certify that they do not impact the Key Event or Fast Cruise/Sea Trial.

- (3) All “A” branded requirements in the current FRP maintenance cycle shall be reviewed for their completion status during the work certification and close out process. If an “A” branded requirement was screened for completion and was not fully **accomplished** as delineated in the task’s Block 35/work item **by the executing activity**, its status shall be reported during the departure conference **to the RMC/Ship Repair Facility Commanding Officer or designated representative** and **in the** follow-on departure report by JCN and work item as applicable. **If the executing activity is an In-Service Engineering Activity (ISEA), the Project Manager or his/her designated representative shall make this report.**
- i. Testing. (This step shall be completed by Key Event/Milestone, utilizing the approved Test and Inspection Plan required under NAVSEA Standard Item 009-67 for the Integrated Test Plan.
- (1) The LMA Test Engineer shall certify that all Hull, Mechanical and Electrical and C51 test procedures identified in NAVSEA Standard Item 009-67 Integrated Test Plan were completed with OQE documentation or added to the exceptions list and that all tests required to be completed at sea have been identified for inclusion on the Sea Trial agenda. The LMA Test Engineer will provide to the NSA this certification via signature of a centrally managed signature sheet or letter/memorandum. The RMC/NSA Integrated Test Engineer (or Project Support Engineer) will verify compliance and sign the signature sheet, noting the LMA Test Coordinator memorandum/serial number or signed list as noted above.
 - (2) The LMA WAF/Coordinator and Ship’s CO will verify that all WAFs and Tag Outs required for Key Event/Milestone have been closed and cleared in accordance with NAVSEA Standard Item 009-106. Signature of a centrally managed signature sheet or a supporting memorandum documenting WAF and Tag Out clearance will be provided to the RMC/NSA Integrated Test Lead. The RMC/NSA Integrated Test Coordinator will verify and sign the signature sheet acknowledging WAF/Tag Out completion to support Key Event of Sea Trials.
- j. Waivers and Deviations. (This step shall be completed for work tied to each Key Event/Milestone.) The RMC/NSA CHENG will certify that all technical non-conformances have been satisfactorily resolved in order to support Key Event/Milestone to include availability completion. This includes certifying that all:
- (1) DFSs have been properly adjudicated and DFSs expiring during the availability have been corrected or extended.
 - (2) AIT/PMR Liaison Action Request (LAR)/Reverse Liaison Action Requests (RLAR) have been incorporated and all RMC Design Service Requests/LARs/RLARs have been answered and incorporated.
- k. Quality Assurance. (This step shall be completed by Key Event/Milestone for work tied to each Key Event/Milestone.)
- (1) The RMC/NSA Code 130 QA Manager will submit to the Project Manager a signed letter/memorandum (Appendix AI) or sign a centrally managed list certifying that all QA Office actions regarding resolution of QA Audits and Surveillances necessary to support Key Events/Milestones are completed.
 - (2) All Contractor Corrective Action Requests (CAR – Method B-D) issued during the availability are either closed or at an acceptable level of completion to support work certification. Include a letter/memorandum (Appendix AI) describing outstanding items, remaining actions, and Estimated Completion Dates, if applicable.
- l. Final Key Event/Readiness for Sea Trials Completion Certificate. (Sub-paragraphs (1), (2), and (3) below shall be completed for work tied to each Key Event/Milestone and before Fast Cruise/Sea Trial. Sub-paragraph (4) below is only required prior to Fast Cruise/Sea Trial.)

- (1) The NSA Project Manager shall verify that availability work required to commence Key Event/Readiness for Sea Trials is complete. NSA oversight (PR, Procedures Evaluation, PVI) and G points have been completed in accordance with the Availability QMP (Appendix R). Non-conformances identified have been corrected or provided to NSA Technical Authority for adjudication. Any exceptions to completion have been reviewed and do not impact Key Event/Sea Trials completion.
- (2) The NSA CHENG will verify that availability work required to support Sea Trials has been completed in a technically correct manner and that all exceptions listed have been reviewed and authorized. NSA technical review of work items has been conducted in accordance with the Availability QMP (Appendix R).
- (3) The RMC/NSA Project Manager and RMC/NSA CHENG will sign a letter/memorandum (Appendix AJ) or centrally managed list for the record acknowledging completion of all actions required for Key Event/Milestone. Any exceptions will be listed and concurred with by the RMC, TYCOM and Ship's CO.

NOTE: THIS STEP (SUB-PARAGRAPH (4)) REQUIRED PRIOR TO FAST CRUISE/SEA TRIAL ONLY.

- (4) When the signature sheet (Appendix Q) is complete and any exceptions have been concurred on by Technical Authority, the NSA will release a message utilizing the format provided in Appendix AC. Sea Trials will commence after Ship's satisfactory report of Fast Cruise is completed by Ship's CO to the TYCOM per Appendix AB, mandatory 48 hour rest period, and NSA report of readiness for Sea Trials to the TYCOM. TYCOM authorization of Sea Trials commencement will reference Ship's Fast Cruise completion message and NSA Readiness for Sea Trials message.
- m. Final Availability Certification. Upon completion of Sea Trials, a final certification will be accomplished utilizing test results from Sea Trials. If Sea Trials testing resulted in new/growth work that does not support completion of the availability (after consultation with TYCOM), this new/growth work and re-testing must be completed prior to final availability certification. If all availability testing completed satisfactorily, or identified new/growth work does not impact availability completion, the NSA will certify availability completion.
- (1) RMC/NSA Project Manager. Verify all testing required for availability completion has been completed on Sea Trials. Exceptions to completion (including any new/growth identified on Sea Trials) have been adjudicated via Technical Authority and agreed by TYCOM as to not impact availability completion. These exceptions will be tracked to completion by the Project Manager via the Availability Closeout process.
 - (2) RMC/NSA CHENG. Verify that all testing required for availability completion has been completed on Sea Trials. Any exceptions to completion (including new/growth work identified on Sea Trials) have been reviewed and do not impact availability completion.
 - (3) Availability Completion. The NSA will utilize Appendix Q to track signatures required to document Sea Trial testing completion and adjudication of any availability completion exception items. After gaining concurrence from TYCOM and the Ship's CO, the NSA will report availability completion to TYCOM utilizing Appendix F2 via CNRMC.
- n. End of Maintenance Phase. This documents the end of the Maintenance Phase and entrance into the Basic Training Phase for the ship.
- (1) RMC/NSA Project Manager. Coordinate with Ship's Force to verify those systems and equipment not worked during the maintenance availability and operationally tested to ensure the ship is ready to transition from the maintenance phase to the training phase. Adjudicate all found deficiencies.
 - (2) Ship's Force. Operate all equipment and systems not worked during the maintenance availability. Identify and document any deficiencies. Coordinate with the RMC/NSA Project Manager to adjudicate all deficiencies that were found.

3.6.8.2 Aircraft Carriers.

- a. Crew Certification. Crews in ships undergoing major CNO Maintenance Availabilities must be effectively trained in standard operating procedures, emergency bills, casualty drills, etc., and are thoroughly cognizant of equipment either newly installed or relocated during the availability. Based on the length and type of availability, Crew Certifications will be conducted in accordance with references (n), (o), (q) and (r), as applicable.
- b. Steam Testing. All steam systems/equipment worked by the industrial activity shall be tested in accordance with the Testing Plan developed by the industrial activity. Ship's Force shall work closely with the industrial activity, providing necessary assistance and support, to carry out the Test Plan.
- c. PORSE/RSE. Based on the length of the availability, crew turnover and cold iron time, a PORSE/RSE will be scheduled and conducted in accordance with reference (s).
- d. Dock Trials. During an industrial availability and prior to conducting post-repair trials, the engineering plant shall be tested to ensure its readiness for sea. All special sea details and required general quarters will be manned throughout the trials. Ordinarily, dock trials can be completed in one day or less. The minimum requirements for Dock Trials are listed in Appendix I of this chapter.
- e. Fast Cruise.
 - (1) All ships completing a CNO maintenance availability shall conduct a Fast Cruise where the ship assumes, insofar as practical, an "at-sea" posture while inport with all equipment/systems utilized to the maximum extent possible. The primary purpose of the Fast Cruise is to determine and certify the state of training of ship's company as adequate to conduct at-sea operations. The progress toward this goal is a critical evolution ongoing throughout the availability requiring TYCOM and ship's CO attention. The training program must be designed to have completed all training necessary to safely operate the ship at sea prior to Fast Cruise. The Fast Cruise provides the opportunity to measure ship's preparedness; it is not a basic training period. Commencement of Fast Cruise requires TYCOM permission. Appendix AA of this chapter provides a sample message format for Ship's Request for Permission to Commence Fast Cruise. For ships completing Complex Overhaul or Complex Refueling Overhaul, additional requirements for obtaining permission to commence Fast Cruise are contained in reference (r).
 - (2) The following procedures pertain to the conduct of Fast Cruise:
 - (a) Fast Cruise will be included as a major event and scheduled for at least two days duration by the industrial activity in the case of ships undergoing a CNO maintenance availability greater than six months in duration or at least one day for ships undergoing a CNO maintenance availability less than six months in duration. The Fast Cruise shall follow Dock Trials and precede Sea Trials.
 - (b) A schedule of proposed events shall be promulgated by the ship to all activities concerned and shall be concurred with by the industrial activity.
 - (c) Limited numbers of industrial activity personnel may be permitted to be aboard as necessary to continue testing and production work on systems as required. Shop and technical personnel shall be permitted on board as instructors, troubleshooters and QA representatives of the industrial activity. Equipment that is not complete shall not be included in the Fast Cruise. Settlement of the foregoing provisions shall be reached by mutual agreement between the ship's CO and industrial activity, as warranted.
 - (d) As a minimum standard, system operation tests and drills described in Appendix J of this chapter shall be conducted in all Fast Cruises. It is intended that the necessary prerequisite training shall have already been accomplished.
 - (e) Fast Cruise will be included as a major event and scheduled for at least four days (usually two days of operation, one day shutdown to allow shipyard and/or contractors to correct deficiencies, and two more days of operation) for CNO maintenance availabilities scheduled for greater than 9 months in duration. For ships undergoing a

CNO maintenance availability less than 9 months, but greater than 6 months, a two-day Fast Cruise is required. For ships undergoing a CNO maintenance availability less than 6 months, a one-day Fast Cruise is required. The Fast Cruise shall follow Dock Trials and precede Sea Trials. Additional requirements pertaining to nuclear powered ship Fast Cruises are contained in reference (t). (3) Ship's CO shall report completion of Fast Cruise to the TYCOM. Appendix AB of this chapter is a sample message format for Ship's Report of Fast Cruise Completion.

f. Sea Trials.

- (1) Sea Trials (or Post Repair Trials) constitute the final determination of a ship's material readiness and ability to rejoin the Fleet as a fully operational unit. Each Sea Trial will be conducted in accordance with an agenda prepared by the industrial activity, concurred with by the ship's CO, and approved by the TYCOM. The Sea Trial Agenda will contain the minimum requirements of Appendix K of this chapter, a time-oriented sequence of events required to support the trial. The requesting ship/industrial activity will arrange for these Fleet services in accordance with Fleet Commander Instructions. Since the purpose of the trial is to determine the material readiness of the ship, all systems/equipment overhauled by the industrial activity will be tested in accordance with an industrial activity prepared test procedure which will document the results of the test and require operation of the system/equipment in all modes. A Ship's Force Trial Officer will be appointed to coordinate with the industrial activity Trial Coordinator throughout the Sea Trial. The Trial Officer will accept the results of all tests for the ship. Ship's Force personnel will operate all equipment during the Sea Trial in accordance with standard operating instructions or Sea Trial test procedures as appropriate. Commencement of Sea Trials requires TYCOM permission. Appendix AC of this chapter is a sample message format.
- (2) During Sea Trials the ship's CO will advise the TYCOM of major events accomplished and/or significant problems encountered/outstanding on a daily basis. Appendix F₁ of this chapter provides the desired format for this report.

3.6.8.3 Trials, Inspections and Certification Minor Availabilities (Less Than Six Months) (Submarines Only).

- a. Duties and Responsibilities for Sea Trials and Inspections. Reference (u) as applicable delineates the TYCOM's responsibility for operational control of assigned submarines during trials and for assuring that the crew and ship have attained satisfactory state of training, administrative, operational and material readiness for at-sea operations during the trials. Appendix BC of this chapter provides a detailed summary of trial and inspection milestones required for minor submarine availabilities.
- b. General Instructions for Industrial Activity Availability Trials and Inspections.
 - (1) Fast Cruise may not commence until Dock Trials have been satisfactorily completed and a satisfactory state of crew training (if required) and material readiness (if required), as delineated by this manual, has been certified. The required inspections and tests and their associated time periods may be modified by the TYCOM upon request from the cognizant ISIC.
 - (2) Sea Trials involving escorts will not normally be scheduled to commence on a weekend. When circumstances are such that Sea Trials must be rescheduled or planned to commence on a weekend to avoid costly delays, TYCOM approval will be obtained by the ISIC.
 - (3) Critical operation of reactors while nuclear powered ships are in a naval or commercial industrial activity will be governed by reference (h). The CO may authorize critical operation of the reactor in support of tasks assigned the ship. However, as long as the ship remains in an industrial activity, the CO will notify the Supervising Authority well in advance of any critical operation of the ship's reactor. This notification shall include the nature and duration of such operations.
 - (4) In conducting the inspections required herein, inspectors should be guided by the concept that at the start of Fast Cruise, the ship should be, in all respects, ready for Sea Trials with the exception of the additional training the crew will receive during the Fast Cruise.

- (5) The requirement for TYCOM SUBSAFE certification of SUBSAFE boundaries not entered by the industrial activity and the material readiness upon completion of an industrial activity availability imposes additional responsibilities on the ISIC inspectors. Included in the material inspection will be a review of all outstanding Forces Afloat Departures from Specifications as defined in Volume V, Part I, Chapter 8 of this manual. A review of the Ship's Force REC Records is necessary for SUBSAFE work accomplished by Forces Afloat in accordance with Volume V, Part I, Chapter 5 of this manual, along with a review of the applicable URO MRC status. The ISIC certification message, in accordance with Appendix BB, will also provide a status report of any outstanding Re-Entries, Forces Afloat Departures from Specifications and delinquent URO MRCs. The scope and nature of this inspection will vary dependent upon the extent and length of the availability. In this regard:
- (a) Material certification may be made subject to the correction of specific deficiencies. (Deficiencies are such that they can be readily identified and listed.)
 - (b) Material certification should be postponed to a later date when deficiencies are so significant or so numerous as to preclude correction in the time remaining before the scheduled start of Fast Cruise.
 - (c) Deficiencies that could affect the safe operation of the ship during Sea Trials must be corrected, reinspected and reported to the TYCOM as having been corrected prior to the start of Fast Cruise.
 - (d) For ships with Fly-By-Wire Ship Control Systems (FBW SCS), if Upgrades/Alterations or Major Repair Work of the FBW SCS was performed, a 100% audit of the work performed by TYCOM managed activities, as defined in Volume V, Part I, Chapter 9 of this manual, will be performed by the ISIC. The ISIC shall report certification of work and recommend at-sea operations using the message format of Appendix BQ.
- (6) Inspectors must determine that all work/testing necessary to support Sea Trials has in fact been completed or identified for completion prior to the start of Fast Cruise including the following:
- (a) All ship's systems which affect safe operation during Sea Trials must be operable.
 - (b) All work necessary for safe operation of the ship during Sea Trials which was undertaken by the industrial activity, Ship's Force, FMA, or other outside activities must have been satisfactorily completed and tested. Included must be a check for any "special configuration or installations" ensuring that they have been authorized by the proper authority, that their impact has been fully assessed and that the Sea Trial Agenda includes these impacts or limitations.
 - (c) If Upgrades/Alterations or Major Repair Work of the FBW SCS was performed by TYCOM managed activities, a 100% audit of the work will be performed by the ISIC.
- (7) Following the completion of the required training and material readiness certification, COs must keep the cognizant ISIC fully informed of any changes in personnel, training and/or material status which could affect the validity of certification. Prompt TYCOM notification is required to permit revision or Operational Orders and services required.
- (8) Underway trials following an availability, particularly initial submerged and test depth trials, must be undertaken with the knowledge that the crew lacks recent experience operating as a unit and that the ship's structure and fittings have not been tested in an at-sea environment. All tests and procedures must be conducted carefully and methodically. Systems and components designed to operate at test depth should **not** be demonstrated at that depth for the sole purpose of proving the design, but instead should be operated at the deepest depth at which they might be used. For example, the hovering system should not be demonstrated at test depth. Trials and tests which are inherently hazardous should not be conducted.

- (9) A schedule is required for each underway, dockside or simulated trial. Prerequisites of the first underway period are: satisfactory ship's material condition as shown by the successful completion of alongside tests, salvage inspection, Ship's Force Dock Trial, and a satisfactory state of training as shown by the successful completion of crew certification inspection and Fast Cruise. Fast Cruise deficiencies affecting safe operations revealed in either material conditions or state of training must be corrected prior to getting underway for Sea Trials.
 - (10) Provide an operational order to be used incorporating the provisions of reference (u). Provide a copy to the TYCOM and, where appropriate, the local ISIC. Include within the operational orders pertaining to post-availability trials, instructions to send specific messages announcing the start and completion of initial deep dive with the TYCOM as an information addressee.
 - (11) The trial schedule shall include a minimum of six hours of Individual Ship Exercises (ISE) for Ship's Force training. This ISE should be sequenced as soon as practical after the initial tightness dive and should include the necessary evolutions to allow each watch section ship control party to familiarize themselves with their assigned stations and duties. The ship should be operated at moderate speed to develop proficiency prior to the deep dive and full power run. Testing may be scheduled during the ISE period on a not-to-interfere basis with training. The time spent in the initial tightness dive, if at moderate speed, may be included as one section's training. The requirement to provide each watch section ship control party with about two hours experience submerged at moderate speed prior to the deep dive and full power run is mandatory for ship's safety.
 - (12) All trial periods must be organized such that each member of the command has an opportunity to get six uninterrupted hours of rest during each 24 hour period encompassed by the trials. Sea Trial events which can be accomplished by normal watch sections may be conducted concurrently with crew rest periods.
 - (13) Prior to getting underway for Sea Trials, Shipyard, Ship's Force and Type Commander shall jointly agree that the required seven day supply of Oxygen (O₂) and seven day supply of Carbon Dioxide (CO₂) removal capacity will be available in each compartment, based upon the number of expected occupants of that compartment, independent of the supply and removal capacity in the other compartment(s).
 - (14) For industrial activity availabilities, a one to five day deficiency correction period will normally be scheduled subsequent to the Sea Trials and prior to the completion date. The requirement to return to the availability site to correct deficiencies may be waived on a case basis with TYCOM authorization and agreement of the ship's CO and the Supervising Authority if the material condition of the ship so warrants.
 - (15) After the conclusion of Sea Trials, the submarine shall not be operated at depths greater than 1/2 Test Depth plus 50 feet, unless specifically authorized by the TYCOM, and shall not be released for unrestricted operations until all RECs are closed and the TYCOM issues the unrestricted operations authorization message.
 - (16) After the conclusion of Sea Trials, and based upon a review of Sea Trial deficiencies and TYCOM authorization, the submarine may transit to a port other than the industrial activity.
- c. If equipment malfunctions (except for casualties affecting recoverability, salvage, watertight integrity, or operation of ship's control surfaces), or seawater leakage in excess of the specification is found during the conduct of the initial tightness dive or the controlled dive to test depth, the ship should continue to the required depth and execute the sea trial agenda unless the Commanding Officer determines it appropriate to abort the dive. The Commanding Officer and Trials Director should be particularly circumspect in the case of leakage locations not isolable by flood control/other closures (e.g., electrical hull penetrators, periscope hoist rods, etc.).
 - d. Following completion of the initial tightness dive and the controlled dive to test depth, SUBSAFE deficiencies which result in seawater leakage exceeding the specification for acceptance shall be reported to the TYCOM, NAVSEA and info to all concerned.

- e. If leakage is from an unisolable joint, ship's depth will be limited to 1/2 test depth plus 50 feet until approval from the TYCOM is received to continue trials at depths greater than 1/2 test depth plus 50 feet.

3.6.8.3.1 Operating Depth Policy. The TYCOM's policy with respect to maximum allowable operating depths during trials, evolutions to be performed at the various depths, and the prescribed maximum water depth applicable in each case is stated in Volume VI, Chapter 26 of this manual. In every instance where the maximum authorized operating depth is exceeded, a report shall be made in accordance with reference (v), paragraphs 3.10 and 3.26 through 3.28.

3.6.8.3.2 Propulsion Plant Tests (If Required). For full power trials provisions of reference (w), Section 6 apply. Submarine depth during the submerged full power trial should be consistent with the applicable Submerged Operating Envelope (SOE), based on the Emergency Main Ballast Tank (EMBT) blow from maximum authorized operating depth being previously accomplished. The full power submerged ahead test for commissioned nuclear powered submarines shall be terminated by a back emergency bell. The duration of the back emergency shall be limited to 45 seconds, to be followed immediately by an appropriate ahead bell. Caution must be exercised to avoid developing stern way.

3.6.8.3.3 Ocean Engineering Project Availability. Certain submarines have been assigned to provide dedicated support to NAVSEA Ocean Engineering Projects. Ships dedicated to these projects have been assigned to a parent industrial activity which provides Logistic support, performs the maintenance actions required by the Submarine Extended Operating Cycle program and other functions normally provided by an industrial activity. Routine and Submarine Extended Operating Cycle maintenance is factored into the Availability Work Package prepared by the cognizant technical activity in support of the Ocean Engineering Project. Certification of the work during these availabilities is governed by reference (x), Volume V of this manual and the applicable requirements of paragraph 3.6.8.3 of this chapter for availabilities less than six months duration or paragraph 3.6.8.4 of this chapter for availabilities greater than six months duration. Specific actions and reporting requirements which are mandatory prior to completion of an availability are summarized in Appendix BC or Appendix CC of this chapter, as applicable. The TYCOM will reiterate these requirements during the availability by a "Countdown Message" for availabilities greater than six months in duration. A sample format of this "Countdown Message" is shown in Appendix CD of this chapter.

3.6.8.3.4 Salvage Inspection (As Required). Conduct a Salvage Inspection in accordance with Volume IV, Chapter 18 of this manual. The Salvage Inspection should be conducted early enough in the availability to allow time to complete any mandatory corrective maintenance prior to Fast Cruise.

3.6.8.3.5 Phase II Crew/Material Condition Inspection. A Phase II Crew Certification Inspection is normally not required, but should be determined on a case basis by the parent ISIC. If there will be less than 15% personnel turnover, crew certification may be waived. Should the CO determine that alterations accomplished or the transfer of experienced personnel warrant a crew certification, a formal request shall be submitted to the ISIC. When required, crew certification will be performed in accordance with references (y) through (ad). The material certification consisting of an ISIC audit of all Ship's Force **controlled** work in accordance with Volume V, Part I, Chapter 9 of this manual will need to be conducted for all industrial activity availabilities since the extent of the availability is such that an independent evaluation by an organization other than Ship's Force is required.

3.6.8.3.6 Pre-Critical Inspections. For availabilities where the reactor will be shutdown for 16 weeks or more, it is considered prudent to use an inspection plan similar to that employed by NAVSEA. Normally, the crew's readiness can be assessed within two days using such a plan, which should encompass the following:

- a. An administrative review.
- b. Observation of basic drills and evolutions not requiring reactor operation.
- c. Personnel interviews.
- d. Material inspection.

3.6.8.3.6.1 Scheduling of Pre-Critical Inspections. The ISIC Pre-Critical Inspection should be scheduled by the responsible ISIC about four weeks prior to criticality. The TYCOM should be advised as soon as possible in advance of the tentative date for the ISIC Pre-Critical Inspection and confirmed dates should be established about one month in advance of the inspection.

3.6.8.3.6.2 Composition of the Inspection Team. The Pre-Critical Inspection Team should consist of:

- a. A nuclear trained member of the cognizant ISIC Staff, usually the Squadron Training Officer.
- b. A qualified nuclear trained officer with experience as an Engineer Officer.

3.6.8.3.6.3 Reports of Inspection.

- a. The Senior Inspector should provide the inspected unit with an informal report of findings by the inspection team, copy to the cognizant ISIC and TYCOM.
- b. The ship's CO shall review the findings of the inspection team and make necessary adjustments to his training program to ensure his crew's readiness for criticality. He shall keep the cognizant ISIC advised of his training plan and his assessment of his crew's progress.
- c. The cognizant ISIC shall review the inspection findings, the CO's training plan and progress evaluations and direct follow-up reviews and/or inspections necessary to verify the ship's readiness for criticality.

3.6.8.3.7 Dock Trials. Dock Trials must, as a minimum, test those systems/equipment repaired or altered during the availability. The CO should use Appendix L of this chapter as a guide in preparing the Dock Trial Agenda.

3.6.8.3.8 Fast Cruise. Fast Cruise may commence immediately upon completion of Dock Trials and shall consist of the minimum requirements as set forth in Appendix M. The requirement for a Fast Cruise may be less than or greater than 24 hours in length depending upon the length of the availability and the time since the crew last operated the ship at sea. The CO, with ISIC concurrence, will determine length of the Fast Cruise. Prior to the ship commencing Fast Cruise, the Supervising Authority shall report to the ship, by message, that all mandatory work approved for accomplishment during the availability is completed. When the ship is ready for sea with the exception of conducting Fast Cruise and after receipt of the SUBSAFE material certification report from the performing activity as required by references (w), (y) through (ad) and Volume V of this manual, the ship will request permission from the ISIC by priority message to commence Fast Cruise. The ISIC will then, if satisfied with the state of crew training and material readiness, authorize the ship to commence Fast Cruise by message, information copy to CNO, Fleet Commander, NAVSEA, and the TYCOM.

- a. A 24 hour rest and repair period will normally be scheduled following Fast Cruise and prior to the start of Sea Trials. This rest and repair period may be extended or reduced at the discretion of the ISIC.
- b. COs should consider the work and alterations accomplished during the availability when determining the extent of the Fast Cruise. The minimum requirements are listed and identified with an asterisk in Appendix M of this chapter.

3.6.8.3.9 Sea Trials. Upon receipt of the report of successful completion of Fast Cruise from the ship, the ISIC authorizes the ship to get underway for Sea Trials. For submarines, following completion of Fast Cruise the ISIC will notify the TYCOM of satisfactory completion of Fast Cruise and readiness for Sea Trials using the message format of Appendix BB. The submarine TYCOM will authorize the ISIC to allow the ship to get underway for Sea Trials using the message format of Appendices BD and BR if the ship had Upgrades/Alterations or Major Repair Work of the FBW SCS. The submarine CO will keep the TYCOM aware of the progress of the Sea Trial through periodic SITREPs using the message format of Appendix BM of this chapter. SITREPs will be submitted following completion of the initial tightness dive, following completion of the deep dive to test depth and daily at a minimum and as identified by the TYCOM or the Sea Trial Agenda. Sea Trials following availability are normally conducted with a significant number of "riders". These riders represent NAVSEA, TYCOM and Shipbuilder personnel onboard to observe various tests and trial evolutions. The ship's normal load out of Lithium Hydroxide canisters for Disabled Submarine (DISSUB) (granular or ExtendAir®, no mix), Lithium Hydroxide curtains (or ExtendAir® Deployment kits, if equipped), Emergency Air Breathing (EAB) masks, Submarine Escape Immersion Ensemble (SEIE) suits and oxygen candles is not sufficient to support this increase in personnel. Therefore, an additional four Lithium Hydroxide canisters (or three ExtendAir®, if equipped), four Lithium Hydroxide curtains (or one ExtendAir® Deployment kit for every multiple of 60 ExtendAir® canisters in the compartment, if equipped), one EAB mask, one SEIE suit and two Oxygen candles shall be carried for each rider exceeding normal crew manning. Stowage of this additional equipment for DISSUB shall be in the same escape compartment as the rider's designated General Emergency muster site assigned by the Commanding Officer. Lithium Hydroxide canisters, EABs, SEIE suits and Lithium Hydroxide curtains are to be obtained from the industrial activity. Sea Trials are required only as

necessary to test work completed during the availability but must include those mandatory requirements identified in Appendix N of this chapter. The industrial activity shall include at least four days in the availability for conduct of Sea Trials. The industrial activity shall prepare a Sea Trial Agenda for Sea Trials conducted after an availability. The submarine involved shall submit the Sea Trial Agenda to the ISIC for approval, with an information copy to the TYCOM. Extensions or reductions of the Sea Trial period may be granted where warranted by the scope of the work accomplished. Where extension of the Sea Trial period and a change in the availability schedule is required, requests for such extensions must be submitted by the industrial activity to the TYCOM as early as practical. All deficiencies resulting from Sea Trials will be satisfactorily resolved prior to the completion of the availability. If no Sea Trial deficiencies are found, the availability may be completed with TYCOM concurrence at the completion of Sea Trials.

- a. EMBT Blow: An EMBT blow is required for each Sea Trial following an industrial activity availability, availability docking, or availability of less than six months duration. EMBT blow shall be conducted in accordance with the applicable URO MRC and does **not** require an escort for EMBT blow at depths of 400 feet or less.
- b. Assignment of Escort Ship.
 - (1) In accordance with reference (ae), a surface escort shall be provided during deep dive submergence trials for ships completing an availability for repair of collision/grounding damage where deformation is observed to be in the hull integrity envelope and/or supporting structure.
 - (2) In accordance with reference (ae), the requirement for providing an escort during deep dive submergence trials upon completion of all other availabilities will be evaluated by Commander, NAVSEA on a case basis. Commander, NAVSEA will advise the applicable Submarine Force Commander in writing whether or **not** an escort will be required based on the scope of work in the availability. In general, an industrial activity availability of less than six months duration should **not** require an escort, since the work typically performed in these availabilities is limited in scope, is carefully controlled and, therefore, does not result in substantial risk of unidentified or incomplete work adversely affecting the SUBSAFE boundary.
 - (3) Escort requirements should be determined early so that an escort satisfying the requirements of paragraph 3.6.8.4.7.b.(6) of this chapter can be scheduled if required. The TYCOM will in turn request services from the Fleet Commander as applicable. As a general rule, pressure hull work which could not affect hull circularity will not require an escort.
 - (4) Waiver of escort requirements may be requested by message when necessary. The ISIC will request the waiver as soon as possible. The TYCOM will pass the request to Commander, NAVSEA for approval. An escort waiver request message is to include all of the following specific statements, as applicable:
 - (a) A () inch by () inch hull cut between frames () and () including a () inch section of frame () was the only major hull integrity work accomplished during the availability. If no hull frame cut was made, a positive statement to that effect is required.
 - (b) The hull cut weld satisfactorily passed RT and 7 day MT non-destructive tests.
 - (c) Post repair frame circularity check readings are within specifications.
- c. Assignment of SRDRS During Submarine Sea Trials.

NOTE: ASSIGNMENT OF AN SRDRS AND/OR PLACING AN SRDRS IN MOD ALERT IS NOT REQUIRED WHEN THE SCOPE OF WORK IN THE AVAILABILITY DOES NOT REQUIRE AN ESCORT, IN ACCORDANCE WITH REFERENCE (ae), AND THE ONLY REASON FOR ASSIGNMENT OF AN ESCORT IS PERFORMING AN EMBT BLOW FROM DEPTHS GREATER THAN 400 FEET AS A REQUIREMENT OF THE SEA TRIAL AGENDA.

- (1) A SRDRS will be placed in a modified alert status at the beginning of Sea Trials requiring an escort following an industrial availability or major maintenance availability for:

- (a) Ships initial tightness and deep dive events.
 - (b) Subsequent Sea Trials until the completion of the initial dive to design test depth.
 - (c) If, in the TYCOM's judgment, a Sea Trial requires an escort due to major hull cuts.
- (2) A modified alert message will be sent by the industrial activity with the required SRDRS support dates 6 weeks prior to the requested date. Any changes in this request date will require immediate notification to the Fleet commander, Commander Naval Sea Systems Command (COMNAVSEASYSCOM) and Commander, Submarine Squadron (COMSUBRON) ELEVEN. Sample messages in Appendices BN and CQ of this chapter.
- (3) The ship conducting Sea Trials will notify COMSUBRON ELEVEN and COMNAVSEASYSCOM when SRDRS services are no longer required due to completion of the events in paragraph 3.6.8.3.9.c.(1) of this chapter or due to delay in completing Sea Trials.
- (4) The SRDRS is not required to be placed in a modified alert status for those Sea Trials requiring an escort solely for the accomplishment of an EMBT blow from depths greater than 400 feet.

3.6.8.3.10 Interrupted Sea Trials. In the event a Sea Trial is interrupted, or an additional Sea Trial becomes necessary, the following requirements are to be met. These requirements shall be invoked if the ship returns to port for industrial activity repairs which affect SUBSAFE certification or which will require at-sea testing.

- a. The industrial activity will draft a revised Sea Trials agenda to support resumption of the trials. This agenda shall be provided to the ISIC for concurrence and TYCOM for information.
- b. The Ship will report by message (format of Appendix BE of this chapter) that Ship's Force is ready for follow-on sea trials.
- c. The ISIC shall report by message (format of Appendix BF of this chapter) to the TYCOM that the material condition of those SUBSAFE Certification boundaries that were installed, repaired and/or tested by Ship's Force is satisfactory for resuming Sea Trials.
- d. Upon completion of all of the requirements in paragraphs 3.6.8.3.10 a. and b. above, the TYCOM will provide a message (Appendix BG of this chapter) to the ISIC granting permission to proceed with the conduct of Sea Trials and authorize the ship to dive to the Sea Trial operating depth.
- e. The industrial activity will identify by message to COMNAVSEASYSCOM and COMSUBRON ELEVEN any additional SRDRS requirements to support the interrupted trials. Sample message in Appendices BN and CQ of this chapter.
- f. Submarine surface transits from industrial port in advance of completion of CNO availabilities (prior to certification for unrestricted operations) to a different or homeport can be executed without a sea trial, without an escort and without an SRDRS after obtaining NAVSEA concurrence and authorization from the TYCOM. The submarine shall not be authorized to dive and no testing is permitted during the transit. Operational need for transit and mitigating actions, if applicable, shall be determined by the TYCOM.

3.6.8.3.11 Availability Completion Prerequisites. Upon completion of Sea Trials and correction/resolution of deficiencies, the following requirements must be met prior to completion of an industrial availability less than six months duration:

- a. The Supervising Authority shall report by message (format similar to reference (x), Appendix B.3.8) to the TYCOM, satisfactory completion of all Sea Trials, completion of controlled dives, correction of all mandatory and Sea Trial deficiencies. Report that the SUBSAFE material condition of the ship installed, repaired, and/or tested by the industrial activity is satisfactory for URO to test depth. Identify any deferred SUBSAFE work and/or conditionally approved deviations and waivers.
- b. Following verification from the ship Commanding Officer and the Supervising Authority of satisfactory completion of all Sea Trials, completion of controlled dives, correction of all mandatory Sea Trial deficiencies, certification that the SUBSAFE material condition of those parts of the ship installed, repaired, and/or tested by the industrial activity is satisfactory, and upon confirmation of maintenance

of SUBSAFE certification of portions of ship not affected by the industrial activity, the TYCOM shall report by message (Appendix BO of this chapter) to the ship, with copies to CNO and NAVSEA, reporting status of SUBSAFE certification and authorizing URO to test depth.

- c. ISIC. Following verification from the ISEA/activity performing the work of satisfactory completion of all at-sea testing or trials, completion of controlled dives, correction of all mandatory sea trial deficiencies and resolution of all ISIC FBW SCS Certification Audit Deficiencies recommendations, certify to the TYCOM using Appendix BS, with information copies to CNO, the appropriate Fleet Commander and NAVSEA, the FBW SCS material condition of those parts of the ship installed, repaired and/or tested by the ISEA/activity performing the work is satisfactory, and recommend authorization for FBW SCS unrestricted use in support of submarine unrestricted operations, subject to ISIC verification that FBW SCS certification of areas outside ISEA/activity performing the work tasking has been sustained, or specifically identify any operating restrictions of the ship and/or system.
- d. TYCOM. Following verification from the ISIC of satisfactory completion of all at-sea testing, correction of all mandatory deficiencies, receipt of certification that the FBW SCS material condition of those parts of the ship installed, repaired and/or tested by the ISEA/activity performing the work is satisfactory, and upon confirmation that FBW SCS certification was not affected for those portions of ship FBW SCS not affected by the ISEA/activity performing the work, issue a message to the ship using Appendix BT, with copies to CNO, ISIC and NAVSEA, certifying the FBW SCS and authorizing FBW SCS unrestricted use in support of submarine unrestricted operations or specifically identify any operating restrictions of the ship and/or system.

3.6.8.4 Trials, Inspections and Certification Major Availabilities (Greater Than Six Months) (Submarines Only).

The following paragraphs summarize policies and responsibilities with respect to trials, tests and inspections incident to completion of major submarine availabilities. The TYCOM will maintain operational control of the submarine throughout the overhaul, conversion, refueling or post-conversion availability through the designated ISIC. For Atlantic/Pacific submarine units undergoing availabilities in West/East coast industrial activities, respectively, the TYCOM responsible for conducting all trials and inspections specified in this manual is the TYCOM with Operational Control of the unit.

- a. Policy. Major availabilities require a succession of inspections and tests which culminate in a series of underway trials. References (r), (w), (af) and (ag) set forth the philosophy and sequencing of the various categories of these tests and trials, the results of which determine the readiness of the ship at the completion of overhaul or repair. References (ah) and (u) delineate the Force Commander's responsibility for operational control of submarines assigned during trials and for assuring that the crew and ship have attained a satisfactory state of training, administrative, operational and material readiness for at-sea operations during the trials. ISICs and COs shall comply with the provisions of this volume in the conduct of trials incident to the conversion, overhaul and refueling of submarines assigned.
- b. General Information for Industrial Activity Availability Trials and Inspections.
 - (1) The normal sequence of events leading up to Sea Trials is described in paragraph 3.6.8.4.b.(2) of this chapter. Fast Cruise may not commence until Dock Trials have been satisfactorily completed and a satisfactory state of crew training and material readiness, has been certified. The required inspections and tests and their associated time periods may be modified by the TYCOM upon request from the cognizant ISIC.
 - (2) The following inspections and tests are required:
 - (a) Periodic Monitoring Inspections.
 - 1 Arrival Assist (on or about A+30) using the attributes of Volume I, Chapter 3, paragraph 3.3.1 of this manual.
 - 2 Engineering Readiness Review(s).
 - 3 Departmental Readiness Review(s).
 - (b) Pre-Critical Inspection (two days).
 - (c) Phase I Inspection (one day).

- (d) Salvage Inspection (one day).
 - (e) Dock Trials (one day).
 - (f) Phase II Crew/Material Certification (two days).
 - (g) Audit of Ship's Force REC and Departure from Specification records.
 - (h) Minimum of 48 hours for industrial activity work (following Phase II crew certification) (two days).
 - (i) Fast Cruise normally consists of two days of uninterrupted operation, one day to allow the industrial activity and Ship's Force personnel to correct deficiencies, followed by two more days of uninterrupted operation (five days).
 - (j) Rest and repair period (about one day).
 - (k) Underway for initial Sea Trials.
 - (l) Appendix CC of this chapter provides a detailed summary of major trial and inspection milestones required for industrial activity availabilities of six months or greater in duration.
- (3) When circumstances are such that Sea Trials must be rescheduled or planned for a weekend to avoid costly delays, Fleet Commander approval will be obtained by the Supervising Authority on a case basis.
 - (4) Critical operation of reactors while nuclear powered ships are in a naval or commercial industrial activity will be governed by reference (h). Until satisfactory completion of post repair propulsion plant trials (in the case of ships in industrial availabilities), permission to conduct critical reactor plant operations must be obtained from NAVSEA. Subsequent to completion of propulsion plant post repair trials, the CO may authorize critical operation of the reactor in support of tasks assigned the ship. However, so long as the ship remains in an industrial activity, the CO will notify the industrial activity, as appropriate, well in advance of any critical operations of the ship's reactor. This notification shall include the nature and duration of such operations. Crew certification inspections will not involve or require critical operation of the reactor.
 - (5) In conducting the inspections required herein, inspectors should be guided by the concept that at the start of Fast Cruise the ship should be, in all respects, ready for Sea Trials with the exception of the additional training the crew will receive during Fast Cruise.
 - (6) NAVSEA SUBSAFE Certification Audit (SSCA). During major CNO Maintenance Availabilities NAVSEA will conduct a SSCA as required by reference (x). A copy of the SSCA will be provided to the Supervising Authority, the ship's CO, the TYCOM and Fleet Commander. Prior to conducting Fast Cruise the Supervising Authority must report to NAVSEA and the TYCOM that those parts of the ship installed, repaired and/or tested by the industrial activity are certified satisfactory for post repair Sea Trials, including the resolution of NAVSEA SSCA Category I recommendations, status of all incomplete SSCA Category IA recommendations, and report that the ship is ready for commencement of Fast Cruise.
 - (7) The requirement for TYCOM certification of SUBSAFE boundaries not entered by the industrial activity and material readiness upon completion of an industrial activity imposes additional responsibilities on the ISIC inspectors. A formal audit of Ship's Force REC and Departure from Specification records shall be conducted by the ISIC QA Officer prior to Fast Cruise. Included in the audit and material inspection will be a review of ship procedures to ensure no unauthorized work was conducted within certified boundaries, and all outstanding Forces Afloat Departures from Specification, as defined in Volume V, Part I, Chapter 8 of this manual, granted prior to the availability which required corrective action. There may or may not have been restrictions involved with these departures. A review of the Ship's Force REC

Records and Procedures is necessary for SUBSAFE work accomplished by Forces Afloat in accordance with Volume V, Part I, Chapter 5 of this manual, along with a review of the applicable URO MRC status. The ISIC certification message will also provide a statement certifying that ship and industrial activity procedures ensured that no unauthorized work was conducted within the certified boundaries and, when required, will also provide a status report of any outstanding Re-Entries, Forces Afloat Departures from Specification and delinquent URO MRCs. The scope and nature of this inspection will vary dependent upon the extent and length of the availability. In this regard:

- (a) Material certification may be made subject to the correction of specific deficiencies. (Deficiencies are such that they can be readily identified and listed.)
 - (b) Material certification should be postponed to a later date when deficiencies are so significant or so numerous as to preclude correction in the time remaining before scheduled commencement of Fast Cruise.
 - (c) Deficiencies that could affect the safe operation of the ship during Sea Trials must be corrected, reinspected and reported to the TYCOM as having been corrected prior to the start of Fast Cruise.
- (8) Inspectors must determine that all work/testing necessary to support Sea Trials has in fact been completed or identified for completion prior to the commencement of Fast Cruise including the following.
- (a) All ship systems which effect safe operation of the ship during Sea Trials must be operable.
 - (b) All work necessary for safe operation during Sea Trials which was undertaken by the industrial activity, Ship's Force, FMA, or other outside activities must have been satisfactorily completed and tested. Included must be a check for any "special configuration or installations" ensuring that they have been authorized by proper authority, that their impact has been fully assessed and that the Sea Trial Agenda considers these impacts or limitations.
- (9) Following completion of the required training and material readiness certification, COs must keep the cognizant ISIC fully informed of any changes in personnel, training and/or material status which could affect the validity of certification. Prompt notification is required to permit revision of Operation Orders and services required.
- (10) Underway trials following major availabilities, particularly initial submerged and test depth trials, must be undertaken with the knowledge that the crew lacks recent experience operating as a unit and that the ship's structure and fittings have not been tested in an at-sea environment. All tests and procedures must be conducted carefully and methodically. Systems or components designed to operate at test depth should not be exercised at test depth for the sole purpose of proving the design. They should be operated at the deepest depth at which they might be used. Trials and tests which are inherently hazardous should not be conducted. For example, the automated hovering system should not be demonstrated at test depth. Reference (ai) provides pertinent information regarding the testing of seawater systems during underway trials.
- (11) An approved agenda is required for each underway period. The prerequisites for the first underway period are set forth in paragraphs 3.6.8.4.4 through 3.6.8.4.7 of this chapter.
- (12) The first underway tests will be of limited scope. The initial tightness dive will be a deliberate, planned, step-by-step evolution using conservative angles and moderate speed. The submarine shall be accompanied by an escort ship properly equipped with sonar communication equipment as described in paragraph 3.6.8.4.7 of this chapter. The maximum water depth for this dive shall be 400 feet, as prescribed by reference (u).

- (13) The initial trial schedule shall include a minimum of six hours of submerged ISE for Ship's Force training. This ISE should be sequenced as soon as practical after the initial tightness dive and should include the necessary evolutions to allow each watch section ship control party to familiarize themselves with their assigned stations and duties. The ship should be operated at moderate speed to develop proficiency prior to the deep dive and full power run. Testing may be scheduled during the ISE period on a not-to-interfere basis with training. The time spent in the initial tightness dive, if at moderate speed, may be included as one section's training. The requirement to provide each watch section ship control party with about two hour's experience submerged at moderate speeds prior to the deep dive and full power run is mandatory for ship safety.
 - (14) All trial periods must be organized such that each member of the command has an opportunity to get six uninterrupted hours of rest during each 24 hour period encompassed by the trials. Sea Trial events which can be accomplished by normal watch sections may be conducted concurrently with crew rest periods.
 - (15) Prior to getting underway for Sea Trials, Shipyard, Ship's Force and Type Commander shall jointly agree that the required seven day supply of Oxygen (O2) and seven day supply of Carbon Dioxide (CO2) removal capacity will be available in each compartment, based upon the number of expected occupants of that compartment, independent of the supply and removal capacity in the other compartment(s).
 - (16) A deficiency correction period will be scheduled subsequent to the last Sea Trial and prior to the completion date. The scheduled length and location of this deficiency correction period will be determined by the type and magnitude of the deficiencies to be corrected.
 - (17) After the conclusion of Sea Trials, the submarine shall not be operated at depths greater than 1/2 Test Depth plus 50 feet, unless specifically authorized by the TYCOM, and shall not be released for unrestricted operations until all RECs are closed and the TYCOM issues the unrestricted operations authorization message.
 - (18) After the conclusion of Sea Trials, and based upon a review of Sea Trial deficiencies and TYCOM authorization, the submarine may transit to a port other than the industrial activity.
- c. If equipment malfunctions (except for casualties affecting recoverability, salvage, watertight integrity, or operation of ship's control surfaces), or seawater leakage in excess of the specification is found during the conduct of the initial tightness dive or the controlled dive to test depth, the ship should continue to the required depth and execute the sea trial agenda unless the Commanding Officer determines it appropriate to abort the dive. The Commanding Officer and Trials Director should be particularly circumspect in the case of leakage locations not isolable by flood control/other closures (e.g., electrical hull penetrators, periscope hoist rods, etc.).
 - d. Following completion of the initial tightness dive and the controlled dive to test depth, SUBSAFE deficiencies which result in seawater leakage exceeding the specification for acceptance shall be reported to the TYCOM, NAVSEA and info to all concerned.
 - e. If leakage is from an unisolable joint, ship's depth will be limited to 1/2 test depth plus 50 feet until approval from the TYCOM is received to continue trials at depths greater than 1/2 test depth plus 50 feet.

3.6.8.4.1 Responsibilities. The responsibilities for trials and inspections are as follows:

- a. NAVSEA.
 - (1) Provide approved procedures for tests of the reactor plant required for nuclear refueling and for reactor plant repairs and alterations accomplished in the availability.
 - (2) Authorize critical operation of the reactor as outlined in paragraph 3.6.8.4.b.(4) of this chapter.
 - (3) Approve the scheduling and the sequencing of nuclear propulsion plant tests and concur in the schedule and sequence for nuclear propulsion plant trials.
 - (4) Arrange for technical assistance from the U.S. Department of Energy as required.

- (5) Conduct SSCAs and provide to the Supervising Authority, the ship's CO and the TYCOM and Fleet Commander a copy of the SSCA report.
 - (6) Review and concur with the Sea Trial Agenda submitted by the Supervising Authority.
 - (7) Certify (reference (x), Appendix B.3.2) to the TYCOM, information copies to CNO and Fleet Commander, that the material SUBSAFE condition of those parts of the ship installed, repaired and/or tested by the industrial activity are certified as satisfactory for Sea Trials and controlled dives to a specified depth (usually test depth).
 - (8) Following verification from the Supervising Authority of satisfactory completion of all Sea Trials, completion of controlled dives, correction of all mandatory Sea Trial deficiencies, and resolution of all NAVSEA SSCA Category IA recommendations, certify to the TYCOM, with information copies to CNO and the appropriate Fleet Commander, the SUBSAFE material condition of those parts of the ship installed, repaired, and/or tested by the industrial activity is satisfactory, and recommend authorization for URO to design test depth subject to TYCOM verification that SUBSAFE certification of areas outside the industrial activity AWP has been sustained.
- b. Supervising Authority.
- (1) Accept custody of and responsibility for special nuclear material upon delivery from the U.S. Department of Energy.
 - (2) Accept custody of and responsibility for spent nuclear fuel and other special nuclear material removed from the submarine incident to refueling until transferred to the U.S. Department of Energy.
 - (3) Transfer custody of and responsibility for nuclear fuel and other special nuclear material to the CO of the submarine undergoing refueling when it has been installed in the submarine.
 - (4) Provide sufficient time for crew training during the major availability period to permit the Ship's Force to attain a state of training adequate to ensure proper operation and safety of the ship and its personnel during Fast Cruise and Sea Trials.

NOTE: THE SCHEDULING AND SEQUENCING OF TRIALS INVOLVING TESTS OF A REACTOR PLANT PROPULSION PLANT MUST BE APPROVED BY THE FLEET COMMANDER AND CONCURRED TO BY NAVSEA.

- (5) For FBW-SCS equipped ships, in order to maintain certification of the FBW-SCS and SFCC Boundaries, the Supervising Authority shall:
 - (a) Execute the Lifecycle Certification requirements of reference (aj), Section 5.4.
 - (b) Identify the pertinent information for inclusion in ship certification correspondence.
 - (c) Ensure that any required submarine FBW-SCS testing evolutions are included in the at-sea test/Sea Trial Agenda submitted to the ISIC for approval.
- (6) Prior to Fast Cruise, submit the Sea Trial Agenda to NAVSEA for concurrence and to the TYCOM for approval. Resolve any differences between NAVSEA and the TYCOM. Submit the Deep Dive Test Form and EMBT Blow Test Procedures to NAVSEA for approval. The Sea Trial Agenda shall provide the detailed sequence of events for conducting the Sea Trials required to be performed.
- (7) Schedule the ship salvage inspection to ensure sufficient time for the TYCOM to conduct the inspection and for correction of deficiencies.
- (8) Report the status of the material condition of those parts of the ship installed, repaired and/or tested by the industrial activity prior to each Sea Trial.
 - (a) Report by message (reference (x), Appendix B.3.1) to NAVSEA and TYCOM, in advance of the scheduled start of Fast Cruise, that those parts of the ship installed, repaired and/or tested by the industrial activity are certified satisfactory for post repair

Sea Trials, including resolution of NAVSEA SSCA Category I recommendations and status of all incomplete NAVSEA SSCA Category IA recommendations, and report that the ship is ready for commencement of Fast Cruise. The message shall also state that there are no conditional SUBSAFE Deviations or Waivers which have not been satisfied or cite those that exist, and that, subject to satisfactory completion of Fast Cruise and resolution of mandatory deficiencies, the material condition of the ship is satisfactory for commencement of Sea Trials.

NOTE: SUBSEQUENT TO THE MESSAGE IN PARAGRAPH 3.6.8.4.1.b. (7)(a) OF THIS CHAPTER, ANY DEFICIENCY DISCOVERED AND THE CORRECTIVE ACTION TAKEN WHICH AFFECTS THE WATERTIGHT INTEGRITY, THE RECOVERABILITY OF THE SHIP, THE OPERATION OF THE SHIP'S CONTROL SURFACES, OR THE SHIP'S SALVAGE CAPABILITY SHALL BE REPORTED TO NAVSEA AND THE APPROPRIATE FLEET COMMANDER AND TYCOM BY MESSAGE CITED IN PARAGRAPH 3.6.8.4.1.b. (7)(a) OF THIS CHAPTER. PREVIOUS CERTIFICATION OF MATERIAL CONDITION SHALL BE SUSPENDED UNTIL NAVSEA AND TYCOM REVIEW THE REPORT AND NAVSEA CERTIFIES TO THE TYCOM BY MESSAGE THAT THE MATERIAL CONDITION OF THE PARTS OF THE SHIP COVERED BY THE INDUSTRIAL ACTIVITY AWP IS SATISFACTORY FOR SEA TRIALS TO A SPECIFIED DEPTH, AND THE TYCOM IN TURN CERTIFIES TO THE SHIP THAT THE SHIP'S SUBSAFE CERTIFICATION BOUNDARY IS SATISFACTORY FOR SEA TRIALS TO A SPECIFIED DEPTH.

- (b) Report by message (reference (x), Appendix B.3.3) to NAVSEA and TYCOM, with the concurrence of the CO, the successful completion of Fast Cruise and SUBSAFE material condition readiness as a prerequisite to start of Sea Trials.
- (c) Where a previous Sea Trial was aborted, or corrective actions for Sea Trial deficiencies require an additional deep dive, report by message (reference (x), Appendix B.3.5) to NAVSEA that the SUBSAFE material condition of those parts of the ship installed, repaired, and/or tested by the industrial activity is satisfactory for Follow-On Sea Trials to test depth.
- (9) Report by message (reference (x), Appendix B.3.8) to NAVSEA, satisfactory completion of all Sea Trials, completion of controlled dives, correction of all mandatory Sea Trial deficiencies, and resolution of all NAVSEA SSCA Category IA recommendations. Report that the SUBSAFE material condition of those parts of the ship installed, repaired, and/or tested by the industrial activity is satisfactory for URO to test depth. Identify any deferred SUBSAFE work and/or conditionally approved deviations and waivers.
- (10) Coordinate the schedule for Fast Cruise and post repair trials with the TYCOM/ISIC representative.
- (11) Recommend to the President, Board of Inspection and Survey and the TYCOM, information to NAVSEA, Fleet Commander and TYCOM/ISIC representative, when post availability Material Inspection and Underway Trials by the Board of Inspection and Survey are required.
- c. TYCOM.
 - (1) Schedule the Fleet Commander PORSE as recommended by the industrial activity in the Key Events Schedule and confirmed by the parent TYCOM/ISIC representative upon completion of the ISIC Pre-Critical Inspection.
 - (2) Provide Fast Cruise, Sea Trial and completion prerequisites message (Appendix CD of this chapter) to the ship approximately 90 days prior to the start of Sea Trials.
 - (3) Assign material representatives to be embarked during trials as required by paragraph 3.6.8.4.2 of this chapter.
 - (4) Inform the CNO and Fleet Commander of the scope and schedule of the trials. This is normally done by copy of the TYCOM/ISIC representative Operation Order to the CNO and Fleet Commander.

- (5) Provide escorts as required. Send a Sea Trials Support Services message (Appendix CA of this chapter) to specify SRDRS “modified alert” requirements.
- (6) Approve Sea Trial Agenda.
- (7) Report, by message (Appendix CE of this chapter), to NAVSEA crew readiness for Sea Trials and request NAVSEA Nuclear Propulsion Directorate (08) authorization for critical operations.
- (8) Prior to each Sea Trial, following certification from the Supervising Authority and NAVSEA that the material condition of those parts of the ship installed, repaired and/or tested by the industrial activity is satisfactory for Sea Trials and TYCOM verification that the SUBSAFE certification of those parts of the ship not affected by the industrial activity AWP has been sustained, report by message (Appendix CF of this chapter) to the ship, with copies to CNO and NAVSEA, reporting that the status of the SUBSAFE Certification Boundary is satisfactory and authorizing the conduct of Sea Trials and dives to specified depth. If the ship had Upgrades/Alterations or Major Repair Work of the FBW SCS, and following a recommendation from NAVSEA and/or the ISIC, authorize underway operation of the FBW SCS using Appendix CT.
- (9) Following verification from NAVSEA of satisfactory completion of all Sea Trials, completion of controlled dives, correction of all mandatory Sea Trial deficiencies, certification that the SUBSAFE material condition of those parts of the ship installed, repaired and/or tested by the industrial activity is satisfactory, and upon confirmation of maintenance of SUBSAFE certification of portions of ship not affected by the industrial activity, report by message (Appendix CG of this chapter) to the ship, with copies to CNO and NAVSEA, reporting status of SUBSAFE certification and authorizing URO to test depth. If the ship had Upgrades/Alterations or Major Repair Work of the FBW SCS, following verification from NAVSEA of satisfactory completion of all at-sea testing, correction of all mandatory deficiencies, receipt of certification that the FBW SCS material condition of those parts of the ship installed, repaired and/or tested by the ISEA/activity performing the work is satisfactory, and upon confirmation that FBW SCS certification was not affected for those portions of ship FBW SCS not affected by the ISEA/activity performing the work, issue a message to the ship using Appendix CV, with copies to CNO, ISIC and NAVSEA, certifying the FBW SCS and authorizing FBW SCS unrestricted use in support of submarine unrestricted operations or specifically identify any operating restrictions of the ship and/or system.

NOTE: SUBSEQUENT TO THE MESSAGES, APPENDICES CB AND CE OF THIS CHAPTER, AND REFERENCE (x), APPENDICES B.3.1 AND B.3.2, ANY DEFICIENCY DISCOVERED AND THE CORRECTIVE ACTION TAKEN WHICH AFFECTS THE WATERTIGHT INTEGRITY, THE RECOVERABILITY OF THE SHIP, THE OPERATION OF THE SHIP’S CONTROL SURFACES OR THE SHIP’S SALVAGE CAPABILITY SHALL BE REPORTED TO NAVSEA, TYCOM AND FLEET COMMANDER BY THE SUPERVISING AUTHORITY (INDUSTRIAL ACTIVITY DEFICIENCY) OR SHIP CO (FORCES AFLOAT DEFICIENCY) IN MESSAGE FORMAT. PREVIOUS CERTIFICATION SHALL BE CONSIDERED RESCINDED. WHEN A REVIEW OF THE DEFICIENCY IS COMPLETED BY NAVSEA FOR INDUSTRIAL ACTIVITY ITEMS AND TYCOM FOR SHIP’S FORCE ITEMS, NAVSEA WILL CERTIFY TO THE TYCOM THAT THE MATERIAL CONDITION OF THE PARTS OF THE SHIP COVERED BY THE INDUSTRIAL ACTIVITY AWP IS SATISFACTORY FOR SEA TRIALS TO A SPECIFIED DEPTH. THE TYCOM IN TURN CERTIFIES THAT THE SHIP’S SUBSAFE CERTIFICATION BOUNDARY IS SATISFACTORY FOR SEA TRIALS TO A SPECIFIED DEPTH.

- d. ISIC/TYCOM Representative.
 - (1) Conduct periodic monitoring of ships using paragraph 3.6.8.4.4 of this chapter as a guide to include:

- (a) Technical, administrative and training assistance visits directed toward improvements in management and conduct of maintenance during the availability and training tasks (Tech Assists).
 - (b) Evaluation visits to determine the state of administration and training (Work-Ups).
 - (c) Spot checks to monitor progress and effectiveness in specific material, training and administrative areas (Monitor Visits).
 - (d) Monitor Maintenance Reports that require post availability actions (Liaison Action Requests, Deficiency Management Tracking System items, Departure From Specifications, Deficiency Reports, etc.) for inclusion in the ship's CSMP, as required.
- (2) Conduct a Pre-Critical Inspection of the Engineering Department in accordance with paragraph 3.6.8.4.4 of this chapter to determine the ship's readiness for either the RSE or the Fleet Commander PORSE (as applicable).
 - (3) Schedule a salvage inspection by the operating forces in time to have discrepancies corrected prior to the start of Fast Cruise.
 - (4) Conduct a formal Phase I certification inspection of the ship's company in accordance with references (y) through (ad). The purpose of this inspection shall be to audit the readiness and training of the Ship's Force, particularly in the areas of watchstander qualifications, damage control readiness, status of operational and emergency bills, present on board of essential technical manuals, and general operational knowledge. This inspection shall be scheduled about one month prior to Fast Cruise and should include written examinations and personal interviews with officers and key enlisted men to determine their readiness and status of training as outlined for Phase I. A comparison of personnel allowance (including Navy Enlisted Classification requirements) versus onboard count shall be made to ensure that the ship is adequately manned.
 - (5) Prior to Fast Cruise, the ISIC QA Officer shall conduct a formal audit of Ship's Force REC and Departure from Specification Records and CSMP. Using the SUBMEPP PMR and URO MRC scheduling reports and current industrial activity/Ship's Force updates to the latest report, ensure all "D"-Level PMR and URO MRC accomplishment is current. The ISIC shall forward the audit results to the TYCOM via the cognizant Commander, Submarine Group. The ISIC will then report to the TYCOM by message (Appendix CB of this chapter) the status of the crew/material certification. An update of this certification is needed prior to Sea Trials and following the rescinding of certification noted in the NOTE following paragraph 3.6.8.4.1.c. (9) of this chapter. If Upgrades/Alterations or Major Repair Work of the FBW SCS was performed by TYCOM managed activities, a 100% audit of the work, as defined in Volume V, Part I, Chapter 9 of this manual, will be performed by the ISIC. The ISIC shall report certification of work and recommend at-sea operations using the message format of Appendix BQ.
 - (6) Witness and certify to the TYCOM that the state of crew training is satisfactory for at-sea operations in accordance with references (y) through (ad). This will be done during a two day period subsequent to Dock Trials and prior to Fast Cruise as outlined in paragraph 3.6.8.4.4.e. of this chapter. This two day period shall be scheduled so that there is normally a 48 hour period between the end of this event and the beginning of Fast Cruise. This two day Phase II crew certification period is divided into a 40 hour crew work-up and rest period and an eight hour modified dockside Operational Readiness Inspection. The entire period should be scheduled to minimize interference with industrial activity work. However, since the certification must be conducted most carefully to be meaningful, the officer scheduling the certification should coordinate industrial activity interference during the eight hour modified Operational Readiness Inspection. This certification should be thorough and meticulous. Pressure from the industrial activity or any other source to compromise the submarine's safety must not be permitted to influence the judgment of the certifying officers. The desired overall sequence of these events is shown in Appendix CC of this chapter.

- (7) Conduct a material inspection of the ship concurrent with the inspection of paragraph 3.6.8.4.1.d.(5) of this chapter. This inspection should be conducted using the guidelines contained in paragraphs 3.6.8.4.b.(5) and 3.6.8.4.b.(7) of this chapter.
- (8) Satisfactory completion of the inspections of paragraphs 3.6.8.4.1.d.(5) through 3.6.8.4.1.d.(7) of this chapter should be reported to the TYCOM in one "PRIORITY" crew certification message in accordance with sample message format of Appendix CB of this chapter paralleled by a telephone call to the TYCOM Watch Officer reporting the date-time group of the message. If significant deficiencies exist or it appears that extension of time is required to correct training/material deficiencies, the TYCOM shall be immediately advised by telephone and by message. The Supervising Authority will be included as an information addressee.
- (9) Receive from the CO/Supervising Authority the scope, schedule and agenda of tests for Sea Trials for review. The concurrence of NAVSEA is required for the sequencing and scheduling of propulsion plant Sea Trials for industrial activity availabilities.
- (10) Prior to Sea Trials, report by message (Appendix CH of this chapter) to the TYCOM the material certification of the ship.
- (11) Advise the TYCOM by message of escort requirements and ensure that an escort is provided during the initial tightness dive, during the deep dive and during emergency blow tests as required by paragraph 3.6.8.4.7.a. of this chapter.
- (12) Arrange for a SRDRS to be on "modified alert" during the Sea Trials via message (Appendix CA of this chapter) to COMSUBRON ELEVEN.
- (13) Provide updated sea trials status by telephone to COMSUBRON ELEVEN if SRDRS "mod-alert" support services are in use in accordance with paragraph 3.6.8.4.7.b.(6) of this chapter.
- (14) Provide an operation order to be used incorporating the provisions of reference (u). Provide a copy to the TYCOM and, where appropriate, the local ISIC, information to CNO and Fleet Commander. Include within operation orders pertaining to post-availability trials, instructions to send specific messages announcing the start and completion of initial deep dive with the TYCOM as an information addressee.
- (15) Arrange for the embarkation of technical personnel who may be assigned by NAVSEA to observe tests or trials.
- (16) Arrange for the assignment of operating areas and communications frequencies.
- (17) Assign a submarine qualified officer to act as TYCOM representative embarked during Sea Trials as required by paragraph 3.6.8.4.2 of this chapter. When necessary, provide a gold dolphin wearer to ride the escort vessel.
- (18) When authorized by the TYCOM, grant permission for the ship's CO to commence Sea Trials in accordance with the approved Sea Trials Agenda.
- (19) Upon completion of Sea Trials, report by message (Appendix CI of this chapter) to the TYCOM the status of any work performed by Forces Afloat within the SUBSAFE boundary, status of Departures from Specification and status of URO MRCs. If Upgrades/Alterations or Major Repair Work of the FBW SCS was performed by TYCOM managed activities, following verification from the ISEA/activity performing the work of satisfactory completion of all at-sea testing or trials, completion of controlled dives, correction of all mandatory sea trial deficiencies, and resolution of all ISIC FBW SCS Certification Audit Deficiencies recommendations, certify to the TYCOM using Appendix BS, with information copies to CNO, the appropriate Fleet Commander and NAVSEA, the FBW SCS material condition of those parts of the ship installed, repaired, and/or tested by the ISEA/activity performing the work is satisfactory, and recommend authorization for FBW SCS unrestricted use in support of submarine unrestricted operations, subject to ISIC verification that FBW SCS certification of areas outside ISEA/activity performing the work tasking has been sustained, or specifically identify any operating restrictions of the ship and/or system.

e. Ship CO.

- (1) Carry out his command responsibilities in accordance with reference (g).

NOTE: SUBMARINES UNDERGOING INDUSTRIAL ACTIVITY AVAILABILITIES NORMALLY REMAIN IN COMMISSION WITH A CREW ASSIGNED. THE CO REMAINS FULLY RESPONSIBLE FOR THE NUCLEAR PROPULSION PLANT DURING ALL PHASES OF THE AVAILABILITY, INCLUDING ALL POST REPAIR TESTS AND TRIALS.

- (2) Develop and execute training plans and documents in order to maintain the state of training of the crew adequate to support post repair tests, inspections and trials. The nature and scope of the training required will depend to a great extent on the length of the availability. Care shall be taken to ensure that these plans and documents are in conformance with instructions and procedures approved by NAVSEA.
- (3) Supervise operation of the nuclear propulsion plant. Critical operations will be conducted as set forth in paragraph 3.6.8.4.b.(4) of this chapter.
- (4) Prepare the ship's engineering personnel and propulsion plant and spaces for examination by the Director, Division of Naval Reactors, U.S. Department of Energy or the Fleet Commander Nuclear Propulsion Examining Board. For PORSE conducted by the Nuclear Propulsion Examining Board, direct liaison is authorized with the industrial activity to ensure estimated dates are included in the Key Events schedule.
- (5) Maintain PMS in accordance with reference (ak), SUBSAFE REC in accordance with Volume V, Part I, Chapter 5 of this manual to ensure no unauthorized Ship's Force work is conducted within the certified SUBSAFE boundaries, Reactor Plant PMS in accordance with reference (al) and Planned Maintenance Management Program in accordance with reference (am), for work performed by Forces Afloat. Ensure records are ready for ISIC audit conducted prior to Fast Cruise.
- (6) Participate in at-sea periods prior to the first Sea Trials as follows:
 - (a) If possible accompany the preceding ship in overhaul on the first Sea Trial to learn how the propulsion trial is run.
 - (b) For ships in availabilities 18 months or longer, the CO shall participate in an underway period of sufficient duration about six months before Phase II Crew Certification. The purpose of this ride is to refresh him on what is important to ensure the safe conduct of his own Sea Trials and to insure his crews training program is emphasizing those matters. This underway should be on a ship, preferably of the same class, which is concentrating on basic submarine operations, such as Selected Refresher Training or ISE, in order for the CO to see evolutions such as coming to periscope depth, snorkeling, ventilating, casualty training, etc. If the availability schedule has 10-12 weeks between Power Range Testing and Phase II Crew Certification, the CO should go to sea about two months before Power Range Testing. The intent is for the CO to go to sea after having been in the industrial activity for a fair amount of time (normally one year or more), but with sufficient time remaining to improve his own training program if necessary. During these underways, the CO should have time on the bridge and also observe piloting and navigation.
- (7) Determine, in conjunction with the Supervising Authority, the nature and extent of the post-repair Sea Trials. Review the Sea Trial Agenda, including the sequence and duration of each test. The CO will concur with the trial agenda, then the Supervising Authority will submit it to NAVSEA for concurrence and the TYCOM for approval. Provide copies of the approved detailed schedule and agenda for underway trials to the local ISIC, if appropriate, the escort ship and embarked TYCOM representative, if assigned. This schedule and agenda shall include:
 - (a) The minimum requirements in paragraph 3.6.8.4.7 of this chapter.

- (b) A firm time scheduled for the conduct of all tests and trials showing their sequence and duration.
 - (c) General prerequisites for the conduct of each test. Detailed prerequisites should be itemized as part of individual test requirements.
 - (d) Responsibility for the conduct of each test (industrial activity or ship).
 - (e) Support required from the operating forces for the conduct of each test.
 - (f) Provision for adequate crew rest time during Sea Trials. Opportunity for six uninterrupted hours of rest in each twenty-four hour period is a minimum for each member of the command.
 - (g) Provision for a minimum of six hours of uninterrupted independent ship exercises for crew training following the initial tightness dive and prior to the deep dive.
 - (h) Underway tests may be run during ISE and rest periods on a not-to-interfere basis. Specifically, tests which can be conducted underway under normal operating conditions without manning of special watch stations that require extra military personnel, may be scheduled during rest periods. Tests which will not interfere with Ship's Force drills and training exercises may be conducted during ISE periods.
- (8) Undergo a salvage inspection in accordance with Volume IV, Chapter 18 of this manual.
 - (9) Conduct one day Ship's Force Dock Trials in accordance with paragraph 3.6.8.4.5 of this chapter.
 - (10) Demonstrate the state of training of the crew in accordance with references (y) through (ad).
 - (11) Ensure that all pertinent alongside tests, inspections, and trials are conducted.
 - (12) Certify to the designated ISIC/TYCOM representative that all salvage inspection discrepancies affecting safe conduct of Sea Trials have been corrected. Deliver a copy of the salvage plan to the escort ship, if required, and confer with the escort ship to coordinate communications and operational procedures, ensuring that the escort is fully informed as to the submarine's condition and intentions.
 - (13) Concur with Supervising Authority message (reference (x), Appendix B.3.1) concerning Fast Cruise/Sea Trial readiness.
 - (14) Report by message (Appendix CJ of this chapter) to the TYCOM that crew and ship are ready for Sea Trials. List exceptions such as completion of Fast Cruise, removal of shore power connections, etc.
 - (15) When authorized by the TYCOM and, when permission has been granted by NAVSEA 08 for critical reactor operations, conduct a Fast Cruise in accordance with paragraph 3.6.8.4.6 of this chapter.
 - (16) Concur with Supervising Authority message (reference (x), Appendix B.3.3) that Fast Cruise was successfully completed, all mandatory deficiencies for Sea Trials have been corrected and recommend commencement of Sea Trials.
 - (17) Report completion of Fast Cruise to the TYCOM by message (Appendix CK of this chapter) and request permission to commence Sea Trials.
 - (18) When all the requirements of this instruction are completed and permission has been received from the TYCOM, proceed to sea in accordance with operation order. At sea, carry out the approved Sea Trial Agenda and Schedule.

NOTE: SUBSEQUENT TO THE MESSAGES, APPENDICES CF AND CH OF THIS CHAPTER, ANY DEFICIENCY DISCOVERED AND THE CORRECTIVE ACTION TAKEN WHICH AFFECTS THE WATERTIGHT INTEGRITY, THE RECOVERABILITY OF THE SHIP, THE OPERATIONS OF THE SHIP'S CONTROL SURFACES OR THE SHIP'S SALVAGE

CAPABILITY SHALL BE REPORTED TO NAVSEA, TYCOM AND FLEET COMMANDER BY THE SUPERVISING AUTHORITY/ISIC/TYCOM REPRESENTATIVE BY MESSAGE. PREVIOUS CERTIFICATION MESSAGES SHALL BE SUSPENDED. WHEN A REVIEW OF THE DEFICIENCY IS COMPLETED BY NAVSEA FOR INDUSTRIAL ACTIVITY ITEMS AND TYCOM FOR SHIP'S FORCE ITEMS, NAVSEA WILL CERTIFY TO THE TYCOM THAT THE MATERIAL CONDITION OF THE PARTS OF THE SHIP COVERED BY THE INDUSTRIAL ACTIVITY AWP IS SATISFACTORY FOR SEA TRIALS TO A SPECIFIED DEPTH. THE TYCOM IN TURN CERTIFIES THAT THE SHIP'S SUBSAFE CERTIFICATION BOUNDARY IS SATISFACTORY FOR SEA TRIALS TO A SPECIFIED DEPTH.

3.6.8.4.2 Type Commander Embarked Representative. For the first Sea Trial after a major industrial activity availability of a nuclear powered submarine, an unrestricted line officer (a former CO senior to the CO) normally provided by the ISIC/TYCOM will be the TYCOM embarked representative. This officer has the authority to act for the TYCOM in making on the spot changes to the approved Sea Trial Agenda. A TYCOM material representative may also be assigned. When assigned, he will serve as a technical advisor to the TYCOM embarked representative on matters pertaining to Sea Trial Agenda changes, compliance with this manual and disposition of emergent material deficiencies.

- a. During Sea Trials, assume the duties of Officer In Tactical Command unless otherwise designated by the ISIC. As Officer In Tactical Command, this officer must comply with direction found in Annex C of reference (u).
- b. When no officer senior to the CO is embarked for sea trials, the following officers shall act for the TYCOM in approving on-the-spot changes to the Sea Trial Agenda in the order of precedence listed:
 - (1) TYCOM material representative if embarked.
 - (2) Designated ISIC representative if embarked.
 - (3) Ship's CO.

NOTE: SEA TRIAL AGENDAS ARE DEVELOPED AS A RESULT OF LESSONS LEARNED OVER A LONG PERIOD OF TIME. EVENTS AND SEQUENCES OF EVENTS ARE IMPORTANT AND SHOULD BE CHANGED ONLY AFTER THOROUGH DELIBERATION.

3.6.8.4.3 Availability Completion Prerequisites. The following requirements will be included in the TYCOM "Countdown Message" outlined in paragraph 3.6.8.4.8 of this chapter:

- a. The Supervising Authority will report by message (reference (x), Appendix B.3.8) to NAVSEA, satisfactory completion of all Sea Trials, completion of controlled dives, correction of all mandatory Sea Trial deficiencies, and resolution of all NAVSEA SSCA Category IA recommendations. Report that the SUBSAFE material condition of those parts of the ship installed, repaired, and/or tested by the industrial activity is satisfactory for URO to test depth. Identify any deferred SUBSAFE work and/or conditionally approved deviations and waivers.
- b. Following verification from the Supervising Authority of satisfactory completion of all Sea Trials, completion of controlled dives, correction of all mandatory Sea Trial deficiencies, and resolution of all NAVSEA SSCA Category IA recommendations, NAVSEA shall certify by message (reference (x), Appendix B.3.9) to the TYCOM, with information copies to CNO and the appropriate Fleet Commander, the SUBSAFE material condition of those parts of the ship installed, repaired, and/or tested by the industrial activity is satisfactory, and recommend authorization for URO to design test depth subject to TYCOM verification that SUBSAFE certification of areas outside industrial activity AWP has been sustained.
- c. Following verification from NAVSEA of satisfactory completion of all Sea Trials, completion of controlled dives, correction of all mandatory Sea Trial deficiencies, certification that the SUBSAFE material condition of those parts of the ship installed, repaired and/or tested by the industrial activity is satisfactory, and upon confirmation of maintenance of SUBSAFE certification of portions of the ship

not affected by the industrial activity, the TYCOM shall report by message (Appendix CG of this chapter) to ship, with copies to CNO and NAVSEA, reporting status of SUBSAFE certification and authorizing URO to test depth.

3.6.8.4.4 Inspection Procedures.

- a. Periodic Monitoring, Inspections, and Visits.
 - (1) Purpose.
 - (a) To provide to ships in availability such administrative and training assistance as is necessary to improve the Ship's Force conduct of the availability, maintenance and training tasks. Visits of this nature are termed Tech Assists.
 - (b) To evaluate the effectiveness of administration and training. Inspections of this nature are termed Work-Ups.
 - (c) To conduct spot checks to monitor progress in specific material, administrative and training areas. Visits of this nature are termed Monitor Visits.
 - (2) Discussion. The extent, type and frequency of periodic monitoring, inspections, and visits should be determined on a case basis by the responsible ISIC or TYCOM representative. The initial inspection should be broad in scope in order to appraise the responsible ISIC of the adequacy of the ship's performance and progress. Normally, the initial visit will indicate the necessary frequency and scope of subsequent Tech Assists and Monitor Visits. In general, any required Work-Ups should be scheduled in advance of Key Events during the availability.
 - (3) Areas of Inspection Coverage. Initial inspections normally examine the effectiveness of Ship's Force preparations for an availability. Subsequent inspections and visits should review the following areas as appropriate for the purpose of the specific inspection.
 - (a) Review procedures and administrative steps for provisional watch station qualifications.
 - (b) Review department organization manuals.
 - (c) Review department instructions and administrative procedures.
 - (d) Review ship's instructions and administrative procedures.
 - (e) Review department logs, operating instructions and casualty procedures.
 - (f) Review ship's standard operating procedures and the ship's organization and regulations manual.
 - (g) Review training conducted and planned to support the goal of requalifying or reestablishing proficiency of watchstanders.
 - (h) Monitor performance of watchstanding.
 - (i) Conduct spot check of ship's records and logs in use.
 - (j) Review Ship's Force controlled work (SUBSAFE, SOC, FBW, Level I and Nuclear) and procedures to ensure proper controls and documentation in accordance with this manual and no unauthorized work is conducted within the SUBSAFE, SOC and FBW boundaries.
 - (k) Review status of Ship's Force responsible PMS/IEM.
 - (l) Inspect installed equipment for cleanliness and adequate protection from damage.
 - (m) Review Tag-Out and Work Authorization Logs. Spot check for compliance in accordance with current directives.
 - (n) Inspect ship for hazards.
 - (o) Inspect provisions for casualty control including watertight integrity.

- (p) Verify that all COSAL material including operating space items, have been off-loaded to processing areas which provide appropriate security.
 - (q) Inspect the processing area to verify provisions and procedures for careful ILO inventory.
 - (r) Review response of supply system to requisitions in support of Ship's Force work.
 - (s) Verify that items are withdrawn from the ship's COSAL stock undergoing inventory/ILO only on an emergency basis and that such issues are well documented with appropriate adjustments to the inventory records.
 - (t) Evaluate general safety practices.
- (4) Scheduling of Periodic Monitoring, Inspection and Visits. Periodic Monitoring, Inspections, and Visits should be scheduled by the responsible ISIC as appropriate for the purposes of the inspection concerned. Some monitoring visits should be conducted on an unannounced basis. These inspections should be given so as to minimize interference with industrial activity and Ship's Force work.
- (5) Reports of Inspection. Formal reports of the results of periodic monitoring, inspection and visits are not required by the TYCOM. However, the responsible ISIC should advise the TYCOM in situations when the attainment of required progress toward completion of Key Events is in jeopardy.
- b. Pre-Critical Inspection.
- (1) Purpose. To evaluate the readiness of the engineering department to undergo a PORSE by the Fleet Commander Nuclear Propulsion Examining Board or a RSE by representatives from NAVSEA 08.
 - (2) Discussion. The conduct of the Pre-Critical Examination by the ISIC is not intended to duplicate the inspections for which readiness is being evaluated. It is considered prudent, however, to use an inspection plan similar to that employed by NAVSEA. Normally, the crew's readiness can be assessed within two days using such a plan, which should encompass the following:
 - (a) An administrative review.
 - (b) Observation of basic drills and evolutions not requiring reactor operation.
 - (c) Personnel interviews.
 - (d) Material inspection.

NOTE: FOR SSBN/SSGN PRE-CRITICAL INSPECTIONS, THE CREW TO BE INSPECTED IS THE COMPOSITE CREW SELECTED FOR INITIAL CRITICALITY AND POWER RANGE TESTING.

- (3) Scheduling of Pre-Critical Inspections. The ISIC shall conduct a Pre-Critical Inspection within six weeks of intended criticality. The Pre-Critical Inspection shall be scheduled such that the qualification program and material condition of the ship are sufficiently complete to allow for a thorough inspection, but early enough to allow time for the correction of identified deficiencies prior to criticality. The TYCOM should be advised as soon as possible in advance of the tentative date for the ISIC Pre-Critical Inspection and confirmed dates should be established about one month in advance of the inspection.
- (4) Composition of the Inspection Team. The Pre-Critical Inspection Team should consist of:
 - (a) A nuclear trained member of the cognizant ISIC Staff, usually the Squadron Training Officer.
 - (b) A nuclear trained officer with experience as an Engineer Officer.

- (c) When available, a nuclear trained officer from the TYCOM's Staff will participate in ISIC Pre-Critical Inspections involving refueling. Arrangements for participation of the TYCOM Staff member should be initiated by the responsible ISIC at least one month in advance of the anticipated ISIC Pre-Critical Inspection.
- (5) Reports of Inspection.
 - (a) The Senior Inspector should provide the inspected unit with an informal report of findings by the inspection team, copy to the cognizant ISIC and TYCOM.
 - (b) The ship's CO shall review the findings of the inspection team and make necessary adjustments to the training program to ensure the crew's readiness for the examination. The ship's CO shall keep the cognizant ISIC advised of the training plan and the assessment of the crew's progress.
 - (c) The cognizant ISIC shall review the inspection findings, the CO's training plan and progress evaluations, and direct follow-up reviews and/or inspections necessary to verify the ship's readiness for the examination.
- c. Phase I Certification Inspection.
 - (1) Purpose. To determine the state of readiness and training of the Ship's Force, particularly in the areas of watchstander qualification, damage control readiness, status of operational and emergency bills, present onboard supply of essential technical manuals and general operational knowledge.
 - (2) Discussion. The guidelines for the Phase I inspection are provided in references (y) through (ad). The intent of the inspection is to provide a preliminary estimate of readiness and to identify areas requiring action prior to final certification (Phase II).
 - (3) Scheduling of Phase I Certification Inspection. Phase I Inspections should be scheduled by the responsible ISIC about 35 days before scheduled initial Sea Trials.
 - (a) Chief Inspector - ISIC representative of appropriate seniority.
 - (b) Assistant Chief Inspector - a submarine CO.
 - (c) Assistant inspectors for the following departments/areas - overall training, executive, operations, navigation, communications, weapons, first lieutenant, engineering and material.
 - (d) The inspector for the engineering areas of nuclear powered submarines will be a nuclear trained officer qualified as an Engineer Officer.
 - (4) Reports of Inspection.
 - (a) The Chief Inspector shall provide the inspected ship with an informal report of findings by the inspection team.
 - (b) In the event that inspection results indicate the readiness for final (Phase II) certification in the required time cannot be assured, the responsible ISIC should advise the TYCOM of the circumstances.
- d. Material Inspection. Prior to certifying commissioned ships' readiness for at-sea operations, conduct a material inspection to determine that the ship is materially ready for at-sea operations in accordance with Volume V of this manual. In addition, on all ships conduct a Salvage Inspection in accordance with Volume IV, Chapter 18 of this manual. Results of material inspections should be reported with Phase II crew certification reports.
- e. Phase II Certification Inspection.
 - (1) Purpose. To certify that the state of training of the crew is satisfactory for at-sea operations.
 - (2) Discussion. The requirements for Phase II certification inspection are provided in references (y) through (ad).

- (3) Scheduling of Phase II Certification Inspections. Phase II inspections should be scheduled by the responsible ISIC about nine days prior to Sea Trials.
- (4) Composition of the Inspection Team. The requirements for Phase II Certification Team composition are the same as those for Phase I.
- (5) Reports of Certification. The Phase II Certification and Material Certification Reports are combined and submitted in accordance with Appendix CB of this chapter.

3.6.8.4.5 Dock Trials. Ship's Force Dock Trials provide the opportunity to test and check out systems, components and portable equipment prior to the Fast Cruise training period simulating underway conditions. Although normally a period of one day is assigned for integrated Ship's Force Dock Trials, tests and evolutions performed in the one to two weeks prior to the Dock Trial date may be accepted by the CO as fulfilling the requirements of this paragraph. The purpose of Dock Trials is to afford the ship an opportunity to demonstrate that major systems and equipment is in fact ready to support Sea Trials. It is expected that individual equipment will have been satisfactorily tested prior to commencement of the integrated operational tests afforded by Ship's Force Dock Trials. Appendix L of this chapter lists the minimum requirements for Dock Trials and will be used by the ship's CO in preparing for and conducting Dock Trials.

3.6.8.4.6 Fast Cruise. The overall objective of the Fast Cruise is to train the crew and determine the crew's ability to take the ship to sea safely. In addition to the normal underway routine, the CO shall have all equipment operated to check for proper operation and to determine the state of training of the crew. Fast Cruise shall, as far as is practicable, simulate at sea operating conditions. It is to be conducted by the Ship's Force and is to be unhampered by repair work or by movement of industrial activity personnel through the ship. The Supervising Authority shall **not** schedule any trials, tests or other work to be performed on the ship during this period. The Fast Cruise should be four days in duration for nuclear ships and two days for non-nuclear submarines. It should be completed within a five-day period. It should end not more than three days prior to underway trials. Normally, the ship will go to sea for underway trial within a day after completion of Fast Cruise. Should the 72 hour period be exceeded, the TYCOM may direct an additional Fast Cruise. The parent ISIC will make formal recommendations to the TYCOM as to the desired period of Fast Cruise. Appendix M of this chapter lists the minimum requirements for Fast Cruise and will be used by the ship's CO in preparing for and conducting Fast Cruise. Additional drills and operations are at the discretion of the ship's CO. The ship shall be operated as if underway, simulating the various evolutions required for safe operation of the ship. Each underway section shall be exercised in the evolutions which are normally performed on a section basis. During each evolution, check out all communication systems. Ensure that each is in proper working order and that, where duplicate systems exist, a priority system is designated.

3.6.8.4.7 Sea Trials. Appendix O of this chapter delineates the minimum requirements incident to Sea Trials following industrial activity availabilities. For submarines, following completion of Fast Cruise the ISIC will notify the TYCOM of satisfactory completion of Fast Cruise and readiness for Sea Trials using the message format of Appendix CH. The submarine TYCOM will authorize the ISIC to allow the ship to get underway for Sea Trials using the message format of Appendix CF. The submarine CO will keep the TYCOM aware of the progress of the Sea Trial through periodic SITREPs using the message format of Appendix CP of this chapter. SITREPs will be submitted following completion of the initial tightness dive, following completion of the deep dive to test depth and daily at a minimum and as identified by the TYCOM or the Sea Trial Agenda. Sea Trials following availability are normally conducted with a significant number of "riders". These riders represent NAVSEA, TYCOM and Shipbuilder personnel onboard to observe various tests and trial evolutions. The ship's normal load out of Lithium Hydroxide canisters for DISSUB (granular or ExtendAir®, no mix), Lithium Hydroxide curtains (or ExtendAir® Deployment kits, if equipped), EAB masks, SEIE suits and oxygen candles is not sufficient to support this increase in personnel. Therefore, an additional four Lithium Hydroxide canisters (or three ExtendAir®, if equipped), four Lithium Hydroxide curtains (or one ExtendAir® Deployment kit for every multiple of 60 ExtendAir® canisters in the compartment, if equipped), one EAB mask, one SEIE suit and two oxygen candles shall be carried for each rider exceeding normal crew manning. Stowage of this additional equipment for DISSUB shall be in the same escape compartment as the rider's designated General Emergency muster site assigned by the Commanding Officer. Lithium Hydroxide canisters, EABs, SEIE suits and Lithium Hydroxide curtains are to be obtained from the industrial activity. The Supervising Authority and ship's CO will use Appendix O of this chapter in preparing for and conducting Sea Trials.

- a. Assignment of Escort Ship. An escort is required for:

- (1) Initial tightness and deep dives after a major industrial activity availability, including EMBT blow at the completion of each of these dives.
- (2) Any EMBT blow from greater than 400 feet. Rationale is to give the submarine added protection to prevent interference from any surface contact.

NOTE: IN ALL CASES, HULL STRENGTH/TIGHTNESS AND VALVE OPERATIONS WILL HAVE BEEN TESTED TO A DEPTH EQUAL TO OR GREATER THAN EMBT BLOW DEPTH BEFORE TESTING EMBT.

- (3) For second and subsequent underway periods if major hull or sea connected system work has been accomplished since last Sea Trials.

b. Escort Ship Capability Requirements. The surface escort ship must have the following capabilities with the necessary equipment in an operating condition:

- (1) Radio Communication:
 - (a) Ability to transmit and receive on two UHF and on HF circuits simultaneously including 243.0 MHz or equivalent system capabilities (Very High Frequency (VHF) and INMARSAT-C).
 - (b) Equipped to tape record all non-secure radio transmissions between the submarine and the escort.
 - (c) Capability to communicate on the submarine HF/UHF or equivalent system capabilities (VHF/INMARSAT-C) circuits.
- (2) Sonar and Sonar Communications:
 - (a) Equipped with underwater telephone capable of communicating to the submarine's test depth or equivalent system capabilities.
 - (b) Sufficient operators to man underwater telephone on a continuous basis, including CW capable operator on call if the requirement for CW communications develops.
 - (c) Equipped to tape record (installed or portable) all transmissions between the submarine and the escort by underwater telephone.
 - (d) Explosive charge signals or active sonar called for by AXP-1.
- (3) Navigation:
 - (a) Equipped with an operable LORAN C, Global Positioning System (GPS) or the latest accurate off-the-shelf navigational equipment.
 - (b) Equipped with an operable Dead Reckoning Tracers or equivalent system capability.
 - (c) Possess navigational capability to fix his position to two mile average accuracy.
 - (d) Fathometer.
 - (e) Gyrocompass.
 - (f) Underwater log or equivalent system capability.
- (4) Sea Keeping and Speed:
 - (a) Ability to remain at sea for one week in State 6 seas.
 - (b) Be capable of making 10 knots. Escorts will keep the submarine informed of any speed/sea state limitations. In addition, if the escort has an unfaired WQC hydrophone, it shall notify the submarine of the maximum sea state and speed which will not restrict WQC communications. If the submarine requires a speed above this limit, the submarine should run a track about the escort within WQC range.

- (5) When an escort ship is other than another submarine, the ISIC will designate a minimum of one officer qualified in submarines (Gold Dolphins) and ensure a sufficient number of officers qualified in submarines (Gold Dolphins) will be embarked during the escort duty. An escort is not required on Board of Inspection and Survey (INSURV) trials since the EMBT blow is done in accordance with applicable URO MRC vice from maximum authorized operating depth.
- (6) Assignment of SRDRS During Submarine Sea Trials.
 - (a) A SRDRS will be placed in a modified-alert status at the beginning of Sea Trials requiring an escort following an industrial activity availability or major maintenance period for:
 - 1 The ship's initial tightness and deep dive event.
 - 2 Subsequent Sea Trials until the completion of the initial dive to design test depth.
 - 3 If, in the TYCOM's judgment, a Sea Trial requires an escort due to major hull cuts, etc. The TYCOM shall obtain NAVSEA concurrence when determining the need for escort/SRDRS services.
 - (b) The ship conducting Sea Trials will notify COMSUBRON ELEVEN and COMNAVSEASYSCOM when SRDRS services are no longer required due to completion of the events in paragraph 3.6.8.4.7(6)(a) of this chapter or due to delay in completing Sea Trials.
 - (c) The SRDRS is not required to be placed in a modified alert status for those Sea Trials requiring an escort solely for the accomplishment of an EMBT blow from depths greater than 400 feet.
- (7) A modified alert message will be sent by the industrial activity with the required SRDRS support dates 6 weeks prior to the requested date. Any changes in this request date will require immediate notification to the Fleet Commander, COMNAVSEASYSCOM and COMSUBRON ELEVEN. Sample messages in Appendix BN and CQ of this chapter.

3.6.8.4.8 Interrupted/Additional Sea Trials. In the event a Sea Trial is interrupted, or an additional Sea Trial becomes necessary, the following requirements are to be met. These requirements shall be invoked if the ship returns to port for industrial activity repairs which affect SUBSAFE certification or which will require at-sea testing. These requirements will be reiterated by the TYCOM via a special "Countdown Message" Appendix CL of this chapter when the need arises:

- a. The industrial activity will draft a revised Sea Trials Agenda to support resumption of the trials. This Agenda shall be provided to NAVSEA for concurrence and TYCOM for approval.
- b. The ISIC shall report by message (format of Appendix CM of this chapter) to the TYCOM that the material condition of those SUBSAFE Certification boundaries that were installed, repaired and/or tested by Ship's Force is satisfactory for resuming Sea Trials.
- c. The Supervising Authority shall provide a report, by message (reference (x), Appendix B.3.5), to NAVSEA (information copy to the TYCOM) that the material condition of the systems installed, repaired and/or tested by the industrial activity is satisfactory for resumption of Sea Trials. As a minimum, the report should state the status of all incomplete Category IA Audit Items resulting from the NAVSEA SSCA and that all SUBSAFE work has been performed in accordance with the requirements of reference (x).
- d. The CO of the ship shall provide a report by message (format of Appendix CN of this chapter) to the TYCOM stating that the crew and ship are ready for Sea Trials. Any exceptions are to be listed in this message.
- e. NAVSEA (PMS 392), upon receipt of the Supervising Authority report, shall recertify the material condition of the ship for operation to a specific operating depth for Sea Trials and report recertification by message (reference (x), Appendix B.3.6) to the TYCOM.

- f. Upon completion of all of the requirements in paragraphs 3.6.8.4.8.a. through e above, the TYCOM will provide a message (Appendix CO of this chapter) to the ship granting permission to proceed with the conduct of Sea Trials and authorize the ship to dive to the Sea Trial operating depth recommended by NAVSEA.
- g. Submarine surface transits from industrial port in advance of completion of CNO availabilities (prior to certification for unrestricted operations) to a different or homeport can be executed without a sea trial, without an escort and without an SRDRS after obtaining NAVSEA concurrence and authorization from the TYCOM. The submarine shall not be authorized to dive and no testing is permitted during the transit. Operational need for transit and mitigating actions, if applicable, shall be determined by the TYCOM.

3.6.8.4.9 Availability Completion Prerequisites. Upon completion of Sea Trials and correction/resolution of deficiencies, the following requirements must be met prior to completion of an industrial availability greater than six months duration. These requirements will be reiterated in the TYCOM "Countdown Message" Appendix CD or CL of this chapter:

- a. The Supervising Authority shall report by message (reference (x), Appendix B.3.8) to NAVSEA, satisfactory completion of all Sea Trials, completion of controlled dives, correction of all mandatory sea trial deficiencies, and resolution of all NAVSEA SSCA Category IA recommendations. Report that the SUBSAFE material condition of the ship installed, repaired, and/or tested by the industrial activity is satisfactory for URO to test depth. Identify any deferred SUBSAFE work and/or conditionally approved deviations and waivers.
- b. Following verification from the Supervising Authority of satisfactory completion of all Sea Trials, completion of controlled dives, correction of all mandatory Sea Trial deficiencies, and resolution of all NAVSEA SSCA Category IA recommendations, NAVSEA shall certify by message (reference (x) Appendix B.3.9) to the TYCOM, with information copies to CNO and the appropriate Fleet Commander, the SUBSAFE material condition of those parts of the ship installed, repaired, and/or tested by the industrial activity is satisfactory, and recommend authorization for URO to design test depth subject to TYCOM verification that SUBSAFE certification of areas outside the industrial activity AWP has been sustained.
- c. Following verification from NAVSEA of satisfactory completion of all sea trials, completion of controlled dives, correction of all mandatory sea trial deficiencies, certification that the SUBSAFE material condition of those parts of the ship installed, repaired, and/or tested by the industrial activity is satisfactory, and upon confirmation of maintenance of SUBSAFE certification of portions of ship not affected by the industrial activity, the TYCOM shall report by message (Appendix CG of this chapter) to the ship, with copies to CNO and NAVSEA, reporting status of SUBSAFE certification and authorizing URO to test depth.

3.7 COMPLETION OF AVAILABILITY.

- a. (Surface Force Ships/Aircraft Carriers) In order to standardize reporting practices, the official end of a CNO Availability will be upon Certification of work in accordance with "Availability Work Certification" dictated in this chapter and completion of the TYCOM approved Sea Trials Agenda. Ships shall report Sea Trial Agenda Completion in the form of Appendix F1 or Appendix F2 of this chapter. Availability Certification Completion can occur with agreed to exceptions as discussed in Volume VII, Chapters 7 and 8 of this manual. The TYCOM, Contractor, FMA and NSA should consider Work Certification Requirements and the definition of "Availability Completion" when adjudicating New or Growth work in any availability. If scope, time and cost are impacted by New or Growth work, the impact should be addressed and documented in writing (by the RMC Project Manager) to the TYCOM/ISIC.
- b. (Submarines only) CNO availabilities are complete when the TYCOM transmits one of the two following messages:
 - (1) Appendix BO of this chapter. (SAMPLE TYCOM MESSAGE TO SHIP CONCERNING URO FOR INDUSTRIAL ACTIVITY AVAILABILITIES LESS THAN SIX MONTHS IN DURATION (SUBMARINES ONLY)).

- (2) Appendix CG of this chapter. (SAMPLE TYCOM MESSAGE TO SHIP CONCERNING URO FOR INDUSTRIAL ACTIVITY AVAILABILITIES GREATER THAN SIX MONTHS IN DURATION (SUBMARINES ONLY)).

3.8 AVAILABILITY COMPLETION DEPARTURE CONFERENCE.

3.8.1 Departure Conference and Availability Completion Message. At the end of the availability, the Supervising Authority, FMA (if applicable), and Ship's Force will conduct a Departure Conference to finalize the status of all work performed during the availability. The conduct of this conference is similar to that of the Progress Reviews conducted in accordance with paragraph 3.6.3.1.b. of this chapter, and should be used to gather all necessary information to draft and send the Availability Completion Message. Further policy on availability completion can be found in Volume VII, Chapter 7, paragraph 7.12 and Chapter 8, paragraph 8.5 of this manual. As a minimum, the Availability Completion Message should address all areas addressed in the Weekly Progress Message, Appendices F1 or F2 of this chapter as applicable, as well as the following:

- a. Unresolved maintenance issues and guarantee work items.
- b. Report of configuration changes resulting from alterations installed during the availability.
- c. Summarize the NAVSEA waivers issued during the availability.
- d. Identify those work candidates that will be deferred until the next industrial availability.

3.9 POST AVAILABILITY.

3.9.1 Completed Availability Work Package. Within six months after the completion of the availability, SUBMEPP (Submarines)/PMS 312C (Aircraft Carriers)/SURFMEPP (Surface Ships) will issue the Completed Work Package.

3.9.2 End-of-Cycle Analysis (Surface Force Ships Only). Provide inputs to support the SURFMEPP End-of-Cycle Analysis. These inputs will include DFSs approved during the availability and work that was accomplished, but not in the approved AWP.

3.9.3 Post-Availability Analysis (Surface Force Ships Only). TYCOM will participate in the post-availability analysis process and attend CNO Availability completion Maintenance and Modernization Performance Reviews in accordance with Volume VI, Chapter 44 of this manual.

3.10 BASELINE AVAILABILITY WORK PACKAGE CLOSE-OUT (Surface Force Ships Only).

3.10.1 Fleet Readiness Plan Maintenance Cycle BAWP Close-Out. The following procedures will be utilized to close-out and complete the FRP Maintenance Cycle and associated BAWP.

3.10.2 BAWP Close-Out Verification and Assessment Meeting. No later than 45 days after CNO Availability completion, SURFMEPP will conduct a BAWP Close-Out Verification and Assessment Meeting. This meeting will determine the status of all "A" branded BAWP items. A list of all BAWP work items that were not accomplished and the reason(s) for non-accomplishment will be compiled for inclusion in the BAWP Close-Out Report.

3.10.2.1 Attendees. The BAWP Close-Out Verification and Assessment Meeting will be chaired by a SURFMEPP representative. The following personnel are encouraged to attend this meeting:

- a. Ship's CO (or designated representative).
- b. Engineer Officer and Availability Coordinator.
- c. Project Engineer and Combat Systems Project Engineer.
- d. Project Manager and/or Class Team Lead.
- e. PSIA/LMA/Planning Activity Representative.
- f. TYCOM Representative.
- g. ISIC Representative.
- h. Planning Yard Representative.
- i. Program Manager's Representative.

- j. Navy Regional Maintenance Center Representative.
- k. NRMCA Assessment Director.
- l. NAVSEA 05D Representative.

3.10.2.2 BAWP Close-Out Letter. This letter is a deliverable due at the BAWP Close-Out Verification Meeting in accordance with Part II, Chapter 2, Appendix D of this volume. This meeting is used to ascertain the final disposition of each BAWP mandatory requirement ("A" branded JCN in the FRP maintenance cycle) and a BAWP Close-Out Report to summarize all changes for SURFMEPP, Technical Warrant Holders, Ship Design Managers, engineering authorities and other stakeholders as applicable. Maintenance requirement status will be reviewed at the meeting for deferred, accomplished or non-accomplished-no deferral authorized status. At the conclusion of the meeting, all non-accomplished-not authorized for deferral JCNs will require adjudication via the deferral letter process. The NSA/RMC and TYCOM will coordinate this effort as described in paragraph 3.5.4.5 of this chapter, which discusses the technical deferral and adjudication process for post-AWP definitization.

(This Page Intentionally Left Blank)

APPENDIX A
TYPICAL CNO AVAILABILITY PLANNING MILESTONES
(SUBMARINES ONLY)

MILESTONES	RESPONSIBLE ACTIVITY	TIMELINE (Months)
1. Identify Non-Nuclear Title "K" SHIPALTs, fund and authorize planning and procurement.	NAVSEA	A-24
2. Identify Non-Nuclear Title "D" and "F" SHIPALTs, fund and authorize SUBMEPP to accomplish planning.	TYCOM	A-24
3. Issue Advance Planning Letter for NAVSEA funded Alterations and Selected Restricted Availability Advance Planning Milestones.	NAVSEA	A-18
4. Update CSMP. Submit to SUBMEPP via ISIC	Ship	A-16
5. Issue Preliminary AWP.	SUBMEPP	A-15
6. Issue AWP Supplement (replaces inventory of PMRs/URO).	SUBMEPP	A-12 to -14
7. Issue SHIPALT drawings.	Design Agent	A-12
8. Issue Final Planning Letter for NAVSEA funded Non-Nuclear Title "K" SHIPALTs.	NAVSEA	A-12
9. Issue Initial LLTM Report for Centrally Procured LLTM.	LLTM Agent	A-12
10. Issue Preliminary Work Sequence Schedules, provide estimates for NAVSEA funded Non-Nuclear Alterations.	Industrial Activity	A-11
11. Conduct Ship's Force Meeting.	SUBMEPP	A-10
12. Conduct initial Shipcheck.	Industrial Activity	A-10
13. Conduct site Logistics and Facilities Check (for Selected Restricted Availability at FMA only).	Industrial Activity	A-10
14. Issue message providing centrally procured LLTM and FMPMIS material availability status and best estimated delivery dates for Non-Nuclear Title "K" SHIPALTs.	NAVSEA	A-10
15. Host WDC with customers and Industrial Activity.	SUBMEPP	A-10
16. Response to NAVSEA's Material Message issued.	Industrial Activity	A-9
17. Issue Interchangeability Data Sheets for Advance Equipment Repair Program components.	SUBMEPP	A-9
18. Provide Pre-Availability Test Procedures to users on the Standardized Test Procedures CD-ROM and on the SUBMEPP ePortal web site. For ePortal access, go to https://www.submepp.csd.disa.mil , select "Products/Services" then "Secure Web Site" and follow the instructions.	SUBMEPP	A-9
19. Issue SHIPALT Authorization (240 day) letter for NAVSEA funded SHIPALTs.	NAVSEA	A-8

MILESTONES	RESPONSIBLE ACTIVITY	TIMELINE (Months)
20. Issue Proposed AWP.	SUBMEPP	A-8
21. Confirm ability to accomplish all authorized Alterations during Availability.	Industrial Activity	A-7
22. Submit PAT results and Proposed changes to the AWP.	Industrial Activity/Ship	A-5
23. Submit Valve Lists and Sonar Testing, Assessment and Grooming Report for the AWP.	Ship/ISIC	A-5
24. Provide screening action on Pre-Arrival Test results and proposed changes to AWP.	TYCOM	A-4
25. Confirm AWP manday estimate vs. availability duration for compatibility.	Industrial Activity	A-3
26. Convene PAC.	Industrial Activity	A-3
27. Provide preliminary review estimates (90 day estimates) for NAVSEA funded Non-Nuclear Alterations.	Industrial Activity	A-3
28. Confirm receipt of centrally procured LLTM, Fleet Modernization Program Management Information System (FMPMIS) material and Advanced Equipment Repair Program (AERP) components.	Industrial Activity	A-2
29. Issue PAC Report.	Industrial Activity	A-2
30. Promulgate Availability schedule.	Industrial Activity	A-2
31. Deliver centrally procured LLTM.	LLTM Agent	A-2
32. Deliver AERP components.	SUBMEPP	A-2
33. Provide final review estimates (45 day estimates) for NAVSEA funded Non-Nuclear Alterations.	Industrial Activity	A-1.5
34. Issued Approved AWP.	SUBMEPP	A-1
35. Start Availability.	Industrial Activity	A-0
36. Conduct Arrival Conference	Industrial Activity	A-0
37. Issue monthly Availability Status messages.	Industrial Activity/ Supervisor of Shipbuilding (SUPSHIP)	Monthly
38. Submit Reactor Plant Configuration Change Reports (RPCCR) or OPNAV 4790/CK forms for completed Alterations to ship's CO.	Industrial Activity	Monthly
39. Update material history records, manual changes, onboard repair parts for complete alterations. Endorse and forward RPCCRs/OPNAV 4790/CK forms.	Ship	Monthly
40. Complete Availability.	Industrial Activity	C

MILESTONES	RESPONSIBLE ACTIVITY	TIMELINE (Months)
41. Issue Availability Completion Message.	Industrial Activity	C+1

NOTE: "A" AND "C" IN THE "TIMELINE" COLUMN REPRESENT THE START AND COMPLETION DATES, RESPECTIVELY. THE DATES SHOWN ARE FOR ILLUSTRATION ONLY, SINCE ACTUAL MILESTONES VARY DEPENDING ON SHIP OPERATING SCHEDULES, START DATE CHANGES, AND OTHER CONSIDERATIONS.

(This Page Intentionally Left Blank)

APPENDIX B
TYPICAL CNO AVAILABILITY PLANNING MILESTONES
(SURFACE FORCE SHIPS ONLY)

- * 1 - Both Naval and Private Industrial Activities
 2 - Naval Activities

MILESTONES	*CODE	RESPONSIBLE ACTIVITY	TIMELINE (Days)
1. Review CSMP and make sure that all ship deferred maintenance actions desired for accomplishment are documented.	1	Maintenance Team (MT)	Continuous
2. Update BAWP with new requirements.	2	SURFMEPP	A-410
3. Pre-Availability Test and Inspection or Work Package Definition Conference, including combat systems and inspection of boilers (if possible).	1	TYCOM/Industrial Activity/MT	A-360 to A-304
4. Issue Pre-Availability Test and Inspections or Work Package Definition Conference Meeting report (within 10 days after conference).	1	TYCOM/Industrial Activity	A-334 to A-274
5. Order material for Ship's Force work.	1	Ship	A-90 to A-45
6. Cancel all outstanding Casualty Reports (CASREP) which are scheduled to be corrected during the industrial availability per CNSP/CNSL INST. 3040.2.	1	Ship	A to A+3
7. Arrival Conference.	1	Industrial Activity/ISIC/Ship	A to A-0

NOTE: "A" IN THE "TIMELINE" COLUMN REPRESENTS THE START DATES. THE DATE SHOWN IS FOR ILLUSTRATION ONLY, SINCE ACTUAL MILESTONES VARY DEPENDING ON SHIP OPERATING SCHEDULES, START DATE CHANGES, AND OTHER CONSIDERATIONS.

(This Page Intentionally Left Blank)

APPENDIX C
TYPICAL CNO AVAILABILITY PLANNING MILESTONES
(AIRCRAFT CARRIERS ONLY)

MILESTONE	RESPONSIBILITY		
		PIA/DPIA	FDNF
1. RECEIVE/DETERMINE BUDGET CONTROL FOR CNO AVAILABILITIES		C+0	
2. PROVIDE COMP RPT TO PMS 312C/RPPY	TYCOM MPM	C+1	
3. ISSUE BAWP FDR	PMS 312C	C+1	
4. ISSUE AVAILABILITY DEPARTURE REPORT	NAVSHIPYARD	C+1	
5. CONDUCT CAMPR	PMS 312C	C+2	A-19
6. ISSUE ADVANCED PLANNING LETTER GUIDANCE/LETTER OF AUTHORIZATION	PMS 312C	C+3	A-18
7. DELIVER DRAFT BAWP	PMS 312C	C+4	
8. CONDUCT PRE-RELEASE BAWP REVIEW	PMS 312C TYCOM MPM NAVSHIPYD	C+4.5	
9. 312C DELIVERS BAWP	PMS 312C	C+5	A-16
10. INITIAL MAINT PLANNING MEETING	TYCOM MPM	A-17	A-15
11. TASK CORE WORK; RECEIVE CORE WORK (PUBLIC SHIPYARD AND PSIA)	TYCOM MPM	A-17	A-15
12. INITIAL BAWP CHANGE REQUEST SUBMITTAL	TYCOM MPM	A-15	A-13*
13. A-12 CONFERENCE	TYCOM MPM NAVSHIPYD	A-12	(NR13)A-12
14. START CAPS PROCESS/MCA	TYCOM MPM NAVSHIPYD	A-12	(NR14)A-7
15. ESTIMATES BACK FROM SHIPYARD	TYCOM MPM NAVSHIPYD	A-12	(NR14)A-7
16. SCREEN ALL KNOWN WORK	TYCOM MPM NAVSHIPYD	A-9	A-7
17. COMPLETE CAPS PROCESS	TYCOM MPM NAVSHIPYD	A-9	A-7
18. CONDUCT PRC 1	TYCOM MPM NAVSHIPYD	A-9	A-7
19. INTERMEDIATE BAWP CHG REQUEST SUBMITTAL	TYCOM MPM	A-8	A-7*

MILESTONE	RESPONSIBILITY		
		PIA/DPIA	FDNF
20. AT 50%, REVIEW PICKLIST	TYCOM MPM PROJECT TEAM PMS 312	A-7	A-5
21. MRA 1	TYCOM MPM PROJECT TEAM PMS 312	A-7	A-5
22. CONVENE PRC 2	TYCOM MPM PROJECT TEAM	A-5.5	A-3
23. SCREEN ALL KNOWN WORK		A-4	A-3*
24. CLASS C ESTIMATES BACK FROM SY			
25. FINAL BAWP CHANGE REQUEST SUBMITTAL			
26. MRA 2	TYCOM MPM PROJECT TEAM PMS 312C	A-3	A-2
27. AUTHORIZE FINAL AWP	TYCOM MPM NAVSHIPYD RMC	A-2	A-2
28. POETS/MCAI COMPLETE	TYCOM MPM NAVSHIPYD RMC	A-2	A-2
29. PSIA WORK CONTRACTED	TYCOM MPM NAVSHIPYD RMC	A-2	A-2
30. INCORPORATE RESULTS OF POET/MCAI INTO AWP	TYCOM MPM NAVSHIPYD RMC	A-2	A-2
31. FINAL REVIEW ESTIMATE (FRE) ESTABLISHED	TYCOM MPM NAVSHIPYD	*A-1	A-1
32. START AVAILABILITY		A-0	A-0

* THE FINAL REVIEW ESTIMATE (FRE) IS DELIVERED 30 DAYS PRIOR TO EXECUTION OF INDUSTRIAL WORK, BUT NO LATER THAN 30 DAYS PRIOR TO THE CNO AVAILABILITY START DATE.

APPENDIX D

**SUGGESTED GUIDELINES FOR FORCES AFLOAT
REVIEW OF AVAILABILITY WORK PACKAGES**

a. The preliminary AWP includes information which SUBMEPP (Submarines)/PMS 312C (Aircraft Carriers)/applicable TYCOM (Surface Force Ships)/Ashore Ships Maintenance Manager extracts from the CSMP prior to the availability. SUBMEPP/PMS 312C/TYCOM (as applicable) and Ashore Ships Maintenance Manager only reviews items in the CSMP which are coded 1 under the type availability column. SUBMEPP/PMS 312C/TYCOM (as applicable) and Ashore Ships Maintenance Manager continues to monitor the CSMP until submission of the first Supplementary Work List. It is essential that the CSMP be up-to-date and reflect what work the ship requires the industrial activity to accomplish. The CSMP is the primary means of communicating unique work items not already covered by the AWP until submission of the first Supplementary Work List.

b. Ship's Force should review each maintenance item on the CSMP deferred for accomplishment to ensure that the deficiency reported and the work involved to correct it are complete and accurate.

c. To the maximum extent possible, work items that are within the capability of an FMA to accomplish should be accomplished as T/A-2 work prior to the CNO Maintenance Availability.

d. Ship's Force will identify CSMP repair items previously deferred for other than industrial activity action which Forces Afloat will not likely accomplish prior to the availability and change the type availability code to T/A-1, with ISIC concurrence, on these items.

e. Ship's Force will review each outstanding alteration for applicability and ensure that the record of completed alterations is correct. Alterations erroneously reported complete result in plans and tests which do not fit the ship. Completed alterations not reported as complete will cause unnecessary expenditure of shipcheck funds and/or duplication of effort during the availability.

f. During AWP review meetings, Ship's Force should mark up both the index and applicable SWLIN as an aid in recalling information.

g. Ship's Force will review the AWP to see if any component/equipment requiring attention of any kind has been omitted. Note that the Advanced Equipment Repair Program and TRIDENT Planned Equipment Replacement (TRIPER) Program (SSBN/SSGN 726 Class), SEAWOLF Rotatable Pool Program and Aircraft Carrier Planned Equipment Replacement Program replace many components with refurbished units. Repair work on components that will be replaced by AERP can be canceled or noted as covered by the replacement SWLIN.

h. On receipt of the Proposed AWP, Ship's Force should review each Ship System Work Description. Ship's Force should prepare comments as to whether the extent of planned restoration, maintenance or repairs is sufficient or excessive. Additional comments regarding abnormal operation or configuration will be of interest to the industrial activity even if the AWP covers the particular component for repair because the scope of the job can be exactly defined early, avoiding "growth within scope" and schedule slippage later in the availability.

i. Ship's Force should review the General Information Section, "zero" series SWLINs and the glossary for a definition of terms used in the AWP to obtain a general understanding of availability procedures, philosophy and the pre-availability planning requirements.

j. Ship's Force should review all outstanding Departures from Specification to ensure they identify, for correction during the availability, all known non-standard repairs or installations not in accordance with class plans.

k. Ship's Force should identify any recently completed repair actions on components assigned to industrial activities and alterations that may negate the need for, or reduce the extent of, industrial activity refurbishment.

l. Ship's Force should identify any equipment not presently addressed in the AWP. SUBMEPP/PMS 312C/TYCOM (as applicable) and Ashore Ships Maintenance Manager are interested in identifying special or temporary equipment installations which may need maintenance during the availability.

m. Ship's Force should identify any equipment listed for restoration, that is in exceptionally good material condition.

n. Ship's Force should review, "Forces Afloat Actions to be Accomplished Prior To or At Arrival" index in the AWP to ensure these actions are understood.

o. (Submarines only) Ship's Force should review the AWP Part 4.14 NAVSEA 07T/PMT Actions (Non-Nuclear) to ensure SF/PMT actions are completed when required.

APPENDIX E
MONITORING PROCEDURES
(SURFACE FORCE SHIPS AND AIRCRAFT CARRIERS)

1.1 Periodic Monitoring.

- a. Purpose. To provide to ships in availability such administrative and training assistance as is necessary to improve the Ship's Force conduct of the overhaul, maintenance and training tasks. Visits of this nature are termed Tech Assists.
- b. To evaluate the effectiveness of administration and training. Visits of this nature are termed Work-Ups.
- c. To conduct spot checks to monitor progress in specific material, administrative and training areas. Visits of this nature are termed Monitor Visits.
- d. The extent, type and frequency of periodic monitoring and visits should be determined on a case basis by the responsible ISIC or TYCOM Representative. The initial inspection should be broad in scope in order to apprise the responsible ISIC of the adequacy of the ship's performance and progress. Normally, the initial visit will indicate the necessary frequency and scope of subsequent Tech Assists and Monitor Visits. In general, any required Work-Ups should be scheduled in advance of key events during the availability.
- e. Examine the effectiveness of Ship's Force preparations for overhaul during initial inspections. Subsequent visits should review the following areas as appropriate for the purpose of the specific inspection.
 - (1) Review procedures and administrative steps for provisional watch station qualifications.
 - (2) Review department organization manuals.
 - (3) Review department instructions and administrative procedures.
 - (4) Review ship's instructions and administrative procedures.
 - (5) Review department logs, operating instructions and casualty procedures.
 - (6) Review ship's standard operating procedures and the ship's organization and regulations manual.
 - (7) Review training conducted and planned to support the goal of requalifying or reestablishing proficiency of watchstanders.
 - (8) Monitor performance of watchstanding.
 - (9) Conduct spot check of ship's records and logs in use.
 - (10) Review Ship's Force controlled work (Level I and Nuclear) and procedures to ensure proper controls and documentation are in accordance with Volume V, Part I, Chapter 2 of this manual.
 - (11) Review status of Ship's Force responsible PMS/IEM.
 - (12) Inspect installed equipment for cleanliness and adequate protection from damage.
 - (13) Review Tagout and Work Authorization Logs. Spot check for compliance in accordance with current directives.
 - (14) Inspect ship for hazards.
 - (15) Inspect provisions for casualty control including watertight integrity.
 - (16) Verify that all COSAL material including operating space items, have been off-loaded to processing areas which provide appropriate security.
 - (17) Inspect the processing area to verify provisions and procedures for careful ILO inventory.

- (18) Review response of supply system to requisitions in support of Ship's Force work.
 - (19) Verify that items are withdrawn from the ship's COSAL stock undergoing inventory/ILO only on an emergency basis and that such issues are well documented with appropriate adjustments to the inventory records.
 - (20) Evaluate general safety practices.
- f. Scheduling of Periodic Monitoring Visits. Periodic Monitoring Visits should be scheduled by the responsible ISIC/TYCOM as appropriate. Some monitoring visits should be conducted on an unannounced basis. These visits should be given so as to minimize interference with industrial activity and Ship's Force work.
- g. Reports of Visits. Formal reports of the results of periodic monitoring visits are not required by the TYCOM. However, the responsible ISIC should advise the TYCOM in situations when the attainment of required progress toward completion of Key Events is in jeopardy.

APPENDIX F₁
SITREP/PROGRESS REPORT
(Aircraft Carriers Only)

FM USS (SHIP NAME)//
 TO (APPLICABLE TYCOM)//
 INFO (APPLICABLE FLEET COMMANDER)//
 COMNAVSEASYSYSCOM (AS APPLICABLE)//
 COMNAVAIRSYSCOM (AS APPLICABLE)//
 CNO WASHINGTON DC//
 ISIC (IF APPLICABLE)//
 SUPERVISING AUTHORITY//
 PMS//
 Local RSG/RMC (IF APPLICABLE)//
 FMA//
 (OTHER UNITS IN AREA IF APPLICABLE)//
 (OTHER UNITS OF CLASS OF APPLICABLE)//
 BT
 UNCLAS //N04790//
 MSGID/GENADMIN/USS _____//
 SUBJ/(TYPE AVAILABILITY) SITREP (SEQUENTIAL NUMBER)//
 REF/A/DOC/COMUSFLTFORCOM/(DATE)//
 AMPN/REF A IS COMUSFLTFORCOMINST 4790.3, JOINT FLEET MAINTENANCE MANUAL, VOL II//
 RMKS/1. THE FOLLOWING PROGRESS REPORT IS SUBMITTED IAW REF A. CO'S SUMMARY:

- A.
- B.
- C.
2. CRITICAL PATH WORK, INDUST, FMA, AND OTHER AREAS OF CONCERN:
 - A.
 - B.
 - C.
3. STATUS OF WORK (FOR THE WEEK OF DDMMYY-DDMMYY)

	(MAN-DAYS)	FOR WEEK	FOR AVAILABILITY
A. INDUSTRIAL ACTIVITY 1			
SCHEDULED			
PROGRESSED			
EXPENDITURES			
B. INDUSTRIAL ACTIVITY 2			
SCHEDULED			
PROGRESSED			
EXPENDITURES			
C. SHIP'S FORCE	(MAN-DAYS)	FOR WEEK	FOR AVAILABILITY
SCHEDULED			
PROGRESSED			
D. IMF	(MAN-DAYS)		
SCHEDULED			
PROGRESSED			
EXPENDITURES			
4. STATUS OF TESTING
 - A. TOTAL TESTS (NUC/Non-NUC)
 - TESTS STARTED
 - TESTS SCHEDULED TO COMPLETE
 - TESTS COMPLETE
5. STATUS OF KEY EVENTS

6. REACTOR DEPARTMENT TRAINING ASSESSMENT (READINESS TO SUPPORT KEY EVENTS AND READINESS TO CONDUCT AT-SEA OPERATIONS)
 7. SUPERVISING AUTHORITY COMMENTS.//
- BT

NOTE: ENSURE MESSAGES ARE IN ACCORDANCE WITH CURRENT MESSAGE FORMAT AND CURRENT PLAIN LANGUAGE ADDRESS DIRECTORY (PLAD) IS UTILIZED.

APPENDIX F₂
SITREP/PROGRESS REPORT
(Surface Force Ships Only)

FM USS (SHIP NAME)//
 TO (APPLICABLE TYCOM)//
 INFO (APPLICABLE FLEET COMMANDER)//
 COMNAVSEASYSKOM//
 COMNAVAIRSYSKOM (AS APPLICABLE)//
 ISIC (IF APPLICABLE)//
 SUPERVISING AUTHORITY//
 Local RSG/RMC (IF APPLICABLE)//
 FMA//
 PEO THEATER SURFACE COMBATANTS (AS APPLICABLE FOR COMBATANTS)//
 PEO EXW (AS APPLICABLE FOR AUXILIARIES, LITTORALS AND PATROL CRAFT)//
 PEO MUW (AS APPLICABLE FOR MINE WARFARE)//
 NRMK//
 SURFMEPP PORTSMOUTH VA//
 (OTHER UNITS IN AREA IF APPLICABLE)//
 (OTHER UNITS OF CLASS IF APPLICABLE)//
 BT
 UNCLAS //N04790//
 MSGID/GENADMIN/USS _____//
 SUBJ/(TYPE AVAILABILITY) SITREP (SEQUENTIAL NUMBER)//
 REF/A/DOC/COMUSFLTFORCOM/(DATE)//
 AMPN/REF A IS COMUSFLTFORCOMINST 4790.3, JOINT FLEET MAINTENANCE MANUAL, VOL II//
 RMKS/1. THE FOLLOWING PROGRESS REPORT IS SUBMITTED IAW REF A. CO'S SUMMARY:

- A.
- B.
- C.
- 2. CRITICAL PATH WORK, INDUST, FMA, AND OTHER AREAS OF CONCERN:
 - A.
 - B.
 - C.
- 3. STATUS OF PLANNING
 - A.
 - B.
 - C.
- 4. STATUS OF WORK

	FOR WEEK	FOR AVAILABILITY	
A. INDUSTRIAL ACT			
PLANNED	(MAN-DAYS)		
EXPENDED	(MAN-DAYS)		
B. FMA			
ASSIGNED JOBS	N/A	()	
SCHEDULED COMPL	(#)	()	
ACTUAL COMPL	(#)	()	
C. SHIP'S FORCE			
SCHEDULED	(MAN-DAYS)	()	
EXPENDED	(MAN-DAYS)	()	
(45)	(45)	(20)	(95)
- 5. PROGRESS

	INDUST ACT	FMA	SHIP'S FORCE
A. AVAILABILITY	PROGRESS(%)	PROGRESS(%)	PROGRESS(%)
(45)	(45)	(20)	(95)

- 6. STATUS OF TESTING
 - A. INDUSTRIAL ACTIVITY
 - TOTAL TESTS AUTHORIZED ()
 - TESTS STARTED ()
 - TESTS COML ()
 - TESTS CANCELLED ()
 - B. FMA
 - TESTS SCHED TO START (100)
 - TESTS STARTED ()
 - TESTS SCHED TO COMPL ()
 - TESTS COMPL ()

7. STATUS OF KEY EVENTS

	ORIG SCHED	REV DATE	ACT COMP
COMMENCE AVAIL	2/1	2/11	2/12
DRY-DOCKING (IF APPLICABLE)	2/1	2/11	3/20
ELEX REMOVALS COMP	4/11		
UNDOCK		6/2	
SPACE TURNOVER			
#1MMR	6/23		
#2MMR	7/1		
LOA		7/20	
CREW CERT			
COMPLETE AVAIL	9/15		
HOT WASH	MM/DD/YYYY		

(THIS IS NOT AN ALL INCLUSIVE LISTING. SUPERVISING AUTHORITY WILL ISSUE THEIR LIST OF KEY EVENTS)

- 8. STATUS OF SELECTED RECORDS. (SHORT NARRATIVE HIGHLIGHTING ANY PROBLEM AREAS).

- 9. FOL IS STATUS OF USS XXXXXX BLUE AND GREEN (IF NECESSARY)
 COMMAND, CONTROL, COMMUNICATIONS, COMPUTERS, COMBAT SYSTEMS,
 INTELLIGENCE, SURVEILLANCE, AND RECONNAISSANCE (C5ISR), INFORMATION
 TECHNOLOGY FOR THE 21ST CENTURY (IT-21) AND CNSL/SPAWAR ALTERATION INSTALL
 TEAM (AIT) HARDWARE AND SOFTWARE INSTALLS/UPGRADES FOR THE WEEK ENDING
 DDMMYY: (READ IN FIVE COLUMNS)

SYSTEM/EQUIP/ALT	START DATE	ESTIMATED	ESTIMATE	TCD BUST
	COMPLETION	PERCENTAGE	(Y/N)	
	DATE	COMPLETED		

- 10. THE FOLLOWING C5ISR, IT-21 AND AITs ARE SCHEDULED FOR INSTALLATION: (READ IN FIVE COLUMNS)

SYSTEM/EQUIP/ALT	SPONSOR	STATUS	ESD	ECD
------------------	---------	--------	-----	-----

STATUS NOTES

- NOTE 1 - WAITING RMMCO CHECK-IN
- NOTE 2 - RMMCO CHECK-IN COMPLETE
- NOTE 3 - AWAITING SHIP IN-BRIEF
- NOTE 4 - WORK STARTED (TAGOUT/WAF SUBMITTED)
- NOTE 5 - PLANNED, BUT NOT YET AUTHORIZED

- 11. FOL C5ISR, IT-21 AND AIT INSTALLS ARE COMPLETE:
 SYSTEM ALT SOVT (Y/N) SOVT COMP MSG (Y/N)

- 12. POSSIBLE HOT WASH ITEMS

- 13. SUPERVISING AUTHORITY COMMENTS.//

BT

NOTE: ENSURE MESSAGES ARE IN ACCORDANCE WITH CURRENT MESSAGE FORMAT AND CURRENT PLAD IS UTILIZED.

APPENDIX G

SAMPLE NEW WORK FORWARDING LETTER AND INDEX

From: Commanding Officer, USS (Ship Name and Hull No.)

To: (TYCOM)

Via: (ISIC) (See Note 1)

Info: NRMC//
SURFMEPP//

Subj: NEW WORK AUTHORIZATION REQUEST NO. (1) (See Note 2)

Ref: (a) COMUSFLTFORCOMINST 4790.3, Joint Fleet Maintenance Manual

Encl: (1) Index of New Work Requests

(2) Supplementary Work Requests (IPN 002-064) (See Notes 3 and 4)

1. Enclosures (1) and (2) are submitted in accordance with reference (a) as the (first) supplementary work request (See Note 2).

Commanding Officer

Copy to:

SUBMEPP (Submarines only)/PMS 312C (Aircraft Carriers only)

ISIC (See Note 1)

Supervising Authority (See Note 5)

- NOTES:**
- 1. SUBMIT VIA ISIC BEFORE AVAILABILITY START, SUBMIT DIRECTLY TO TYCOM AFTER AVAILABILITY START. PROVIDE COPY TO ADMINISTRATIVE COMMANDER (GROUP/SQUADRON) AFTER AVAILABILITY START.**
 - 2. SUPPLEMENTARY WORK LISTS ARE NUMBERED CONSECUTIVELY THROUGH AVAILABILITY COMPLETION.**
 - 3. ONLY THE ORIGINAL OPNAV 2K (AND 2L IF REQUIRED) SHALL BE ATTACHED TO THE INDEX. MULTIPLE COPIES ARE NOT REQUIRED.**
 - 4. THE FIRST SUPPLEMENTAL IS INTEGRATED PRIORITY NUMBER (IPN)-002. AWP IS CONSIDERED IPN-001. IPNS SHALL BE SEQUENTIALLY NUMBERED AND RECORDED ON INDEX FROM FINAL SUBMISSION TO AVAILABILITY COMPLETION.**
 - 5. COPY TO SUPERVISING AUTHORITY OFFICE.**

USS _____ (Hull No.) Index of New Work Requests

IPN	PRI	JSN From CSMP	Brief Title	ISIC Comment	TYCOM Action	Remarks
(Ex) 002	03	EA01-5493	VH-5 hard to operate		Assign to Industrial Activity	Authorized for Industrial Activity
N U M B E R E D S E Q U E N T I A L L Y						

II-I-3G-2

See Note 4

COMUSFLTFORCOMINST 4790.3 REV C

APPENDIX H

SUGGESTED MESSAGE FORMAT FOR A NEW WORK CANDIDATE

FROM USS (SHIP NAME)//
TO (APPLICABLE TYCOM)//
INFO (APPLICABLE INDUSTRIAL ACTIVITY/SUPERVISING AUTHORITY)//
(ISIC, IF APPLICABLE)//
(SUBMEPP, AS APPLICABLE)//
NRMC//
SURFMEPP//
BT
UNCLAS//N04700
MSGID/GENADMIN/(SHIP NAME)//
SUBJ/NEW WORK REQUEST NR. (000)//
RMKS/1. REQ AUTH TO ACCOMPLISH FOLLOWING REPAIRS:
A. CATEGORY OF REPAIR (BASED ON 1 THRU 5 BELOW).
(1) (WORK THAT MUST BE PERFORMED WHILE IN DRY DOCK)
(2) (WORK THAT WILL RESULT IN A C-3 OR C-4 CASREP IF DEFERRED)
(3) (WORK REQUIRING EXTENSIVE INTERFERENCE/REMOVALS AND WHICH HAVE ALREADY BEEN
MADE INCIDENT TO OTHER AUTHORIZED WORK)
(4) (WORK THAT WILL RESULT IN A C-2 CASREP IF DEFERRED)
(5) (ALL OTHER WORK)
B. DESCRIPTION OF REPAIRS REQUESTED:
(1) EQUIPMENT/SYSTEM
(2) REPAIRS REQUESTED
(3) EIC
(4) JCN
(5) REPAIR BEYOND SF/FMA CAPABILITIES: (EXPLAIN IF NOT OBVIOUS)
2. MISSION CAPABILITY DEGRADED: (EXPLAIN)
3. ADDITIONAL INFORMATION AS NECESSARY.//
BT

**NOTE: ENSURE MESSAGES ARE IN ACCORDANCE WITH CURRENT MESSAGE FORMAT AND
CURRENT PLAD IS UTILIZED.**

(This Page Intentionally Left Blank)

APPENDIX I
MINIMUM DOCK TRIALS REQUIREMENTS
(SURFACE FORCE SHIPS AND AIRCRAFT CARRIERS)

REQUIREMENT	AIRCRAFT CARRIERS	SURFACE FORCE SHIPS
1. Check all Telephone, Announcing and Interior Communications circuits between all stations.	X	X
2. Test all alarms, i.e., General Quarters, Collision, etc.	X	X
3. Check all operational status readout interior communications circuits.	X	X
4. Test whistle.	X	X
5. Check adequacy of interior lighting and emergency lighting.	X	X
6. Operate all hydraulic systems using each installed pump.	X	X
7. Test operation of all radio transmitters and receivers using all antennas.	X	X
8. Operate all radar equipment.	X	X
9. Operate all sonar equipment.	X	X
10. Take and plot fixes using all navigation equipment and each antenna.	X	X
11. Test operation of trim/ballast control/list control system and pump (from all operating locations) in accordance with local instructions.	X	X
12. Test operation of portable submersible pump from each installed outlet.	X	X
13. Test engine order telegraphs.	X	X
14. Test magazine/pyro flooding systems.	X	X
15. Operate each lube oil system, including pumps, controllers, purifiers and indicators.	X	X
16. Energize the Navigation System and gyrocompass; determine that they settle out; take azimuth; check all repeaters.	X	X
17. Check potable water system, have water samples analyzed.	X	X
18. Test capstans and winches.	X	X
19. Operate steering system in all modes. Test normal and emergency rudder angle indicators.	X	X

REQUIREMENT	AIRCRAFT CARRIERS	SURFACE FORCE SHIPS
20. Remove all brows.	X	X
21. Test Automatic Bus Transfer devices.	X	X
22. Operate each watertight door and hatch.	X	X
23. Check operation of escape hatches/scuttle fittings.	X	X
24. Check navigation/running lights for brightness and proper lenses (to be done at night). Includes Flight Deck lighting. (if applicable)	X	X
25. Check air conditioning, chill water, ventilation, and heating systems.	X	X
26. Test underwater log and dummy log if water depth permits.	X	X
27. Check operation of all 400 cycle generating equipment.	X	X
28. Check all galley, messing, and ship's service equipment.	X	X
29. Check fathometer.	X	X
30. Check that mooring lines are doubled and taut and that camels are secured to the pier not the ship.	X	X
31. Check bilge flooding alarm.	X	X
32. Check all High Pressure and Low Pressure air systems/components.	X	X
33. Operate distilling units.	X	X
34. Check anchor windlass and brake operation.	X	X
35. Check atmosphere monitoring equipment, both installed and portable.	X	
36. If possible, operate Secondary Propulsion Motor(s) (SPM), auxiliary propulsion units and thrusters.		X
37. Operate the emergency diesel generator(s).	X	X
38. Engage and disengage propulsion shaft clutch(es).	X	X
39. Test Main Engines; Nuclear Powered ships jack main engines.	X	X
40. Check all TV monitoring systems.	X	X
41. Check small arms lockers and security devices.	X	X
42. Operate all Identification Friend or Foe (IFF) Equipment.	X	X
43. Check degaussing equipment.	X	X

REQUIREMENT	AIRCRAFT CARRIERS	SURFACE FORCE SHIPS
44. Check hangar bay doors.	X	X
45. Inventory and check all damage control equipment.	X	X
46. Inspect and operate oxygen and nitrogen systems.	X	
47. Check out all Tank Level Indicating systems.	X	X
48. Check out Flight Deck communications. (if applicable)	X	X
49. Check meteorological equipment.	X	X
50. Check graphics preparation/display equipment.	X	X
51. Check weapon systems. Check to include loading of dummy missile at each launch station, transmission of fire control signals and operation of launchers in all modes.	X	X
52. Operate all electrical/mechanical medical equipment.	X	X
53. Inspect all compartments for proper stowage and cleanliness and operability of equipment.	X	X
54. Test operation of all data processing equipment.	X	X
55. Test and inspect jet blast deflectors.	X	X
56. Test and inspect JP-5 fuel systems.	X	X
57. Test and inspect all aircraft starting, handling and launching equipment including catapults.	X	X
58. Test and inspect aircraft landing equipment including land signal officer equipment, arresting gear, barricades, as applicable.	X	X
59. Operate all Refueling at Sea equipment.	X	X
60. Check bridge window wiper system.	X	X
61. Operate all accommodation ladders.	X	X
62. Operate all conveyors.	X	X
63. Launch and raise motor whaleboat.	X	X
64. Operate all Boats.	X	X
65. Test and inspect Lifeboat/Life Raft stowage and launch equipment.	X	X
66. Test and inspect all elevators in all modes of operation.	X	X
67. Test and inspect all fire fighting systems.	X	X

REQUIREMENT	AIRCRAFT CARRIERS	SURFACE FORCE SHIPS
68. Test and inspect refrigeration system.	X	X
69. Test and inspect all sea water cooling systems.	X	X
70. Operate stern gate doors.		X
71. Operate cranes.	X	X
72. Operate all ship's service generators.	X	X
73. Check all photographic processing and recording equipment.	X	X

APPENDIX J
MINIMUM FAST CRUISE REQUIREMENTS
(SURFACE FORCE SHIPS AND AIRCRAFT CARRIERS)

REQUIREMENT	AIRCRAFT CARRIERS	SURFACE FORCE SHIPS
1. Make all preparations for getting underway.	X	X
2. Station the maneuvering watch/sea and anchor detail.	X	X
3. Station the normal underway watch (section watches).	X	X
4. Simulate getting underway and return to port. (Day and Night)	X	X
5. Walk through all major Sea Trial evolutions.	X	X
6. Exercise the reduced visibility detail.	X	X
7. Spot check storage and availability of spare parts and tools. Verify adequacy of stores and provisions.	X	X
8. Conduct the following emergency drills:		
a. Fire	X	X
b. Collision	X	X
c. Flooding	X	X
d. Abandon Ship	X	X
e. Man Overboard	X	X
f. Loss of AC Power	X	X
g. Loss of Air Conditioning/ACW	X	X
h. Loss of Lighting	X	X
i. Loss of Interior Communications	X	X
j. Steering Casualty	X	X
k. Engine Casualty Control	X	X
9. Set General Quarters. Exercise the crew at battle stations.	X	X
10. Conduct communication and Electronic Counter Measures (ECM) drills.	X	X
11. Anchor (walk-through).	X	X
12. Exercise damage control party with emergency and damage control equipment during conduct of item 12.	X	X
13. Perform the minimum Fast Cruise requirements for nuclear propulsion plants contained in reference (t).	X	

REQUIREMENT	AIRCRAFT CARRIERS	SURFACE FORCE SHIPS
14. Operate air conditioning plants to demonstrate ability to carry the maximum existing ships air conditioning load or 100% capacity.	X	X
15. Operate fresh water/seawater heat exchangers at sufficient load to demonstrate proper operation.	X	X
16. Simulate underway conditions, performing all evolutions and operating equipment normally.	X	X
17. Simulate boat transfer at sea.	X	X
18. Conduct competitive and non-competitive drills and exercises such as aircraft tracking, and aircraft control.	X	X
19. Man Towing/Salvage/Fueling Stations.	X	X
20. Set Flight Quarters as applicable.	X	X
21. Check all interior communications circuits.	X	X

APPENDIX K**MINIMUM TESTS TO BE PERFORMED DURING SEA TRIALS
(SURFACE FORCE SHIPS AND AIRCRAFT CARRIERS)****I. RESPONSIBILITIES** (reference (an), Chapter 094).

The Ship's Force or Ship Trial Coordinator is responsible for:

1. The scheduling of the various trials and for conducting tests during trials while underway. A schedule of equipment tests should be available so all personnel are prepared for the evolutions.
2. Equipment operation during testing and for conducting the trials in accordance with reference (w) and TYCOM directives.
3. Verifying necessary trial documentation and technical data is on board.
4. Review of Personnel Qualification Standard (PQS) programs to identify new equipment and systems requiring PQS coverage, to implement PQS standards for new personnel, and to determine required watch station qualification in preparation for propulsion plant light-off and Sea Trials.
5. Providing a Sea Trial watch organization to accomplish the trial agenda.
6. Preparing and providing fire and abandon ship bills and holding emergency underway drills (can be completed and certified as part of Dock Trials or Fast Cruise).

II. PREPARATION FOR SEA TRIALS (reference (an), Chapter 094c).

Prior to Sea Trials, every reasonable effort shall be made to complete all prerequisites:

1. Dockside tests shall be satisfactorily completed and all safety requirements met. Incomplete non-safety items shall be documented, including plans for timely resolution and completion. Should it be impractical to conduct any of these prerequisite tests dockside, the Naval Supervisory Authority (NSA) may permit the test to be conducted while underway.
2. All equipment, furniture and systems necessary to the conduct of the trials shall be installed and in operating condition. All labeling, painting, sheathing, insulation and deck covering shall be completed.
3. An inclining experiment, if required, shall be performed and the results certified in writing to the NSA that the ship meets stability requirements and is safe for sea.
4. All temporary rigging and equipment, except that necessary for collection of Sea Trial test data, and all debris shall be removed from the ship.
5. Painting that will not be dry at time of trials shall be avoided.
6. Messing, sanitary and berthing facilities shall be operational and available for use during Sea Trials.
7. The ship shall be prepared for possible emergencies at sea. The NSA shall certify in writing that equipment or systems listed that have been installed, overhauled or disturbed during the overhaul have been restored to their normal operating status. The minimum readiness includes:
 - a. Power boats to be utilized in an emergency shall be fully operational, fitted-out and provisioned as prescribed by reference (ao).
 - b. All davits shall be operational.
 - c. Air inflatable lifeboats shall be onboard and properly installed and within PMS certification requirements.

- d. Emergency radios shall be onboard and operable.
- e. Life rings and float lights shall be rigged in stowage brackets.
- f. Life jackets for all personnel embarked plus 5 percent spares shall be onboard and distributed in readily accessible areas.
- g. Adequate first aid kits and emergency medical equipment shall be onboard.
- h. Fire fighting and damage control equipment shall be returned to the ship (if removed), verified to be fully operational/ready for use and properly stowed.
- i. All navigation devices and equipment shall be tested to ensure proper operation.
- j. Work on all compartments whose water tight integrity is essential to the safety of the ship shall be completed and, where authorized, satisfactorily tested.

III. PRIOR TO GETTING UNDERWAY.

- 1. Prior to Sea Trials following extended in-port or lay-up time, the following preliminary inspections should be conducted (reference (w), section 1.3.2):
 - a. Inspect the underwater sea chests.
 - b. Clean the sea chests of marine growth and debris if required.
 - c. Inspect underwater hull for foreign material or objects.
 - d. Inspect and clean as necessary condenser sea water sides.

NOTE: CVNS IN JAPAN HAVE THEIR HULLS INSPECTED PER QUARTERLY REQUIREMENTS SET BY NAVSEA.

 - e. Ensure correct hoses for blowing sea chests are available on board and can be made up to hose connections provided for this purpose.
 - f. Establish operability of each item of machinery to be used during the trial.
 - (1) Test equipment to validate minimal equipment available to conduct operations in accordance with technical specifications.
 - (2) Specific emphasis should be placed on fire pumps, anchor equipment and steering systems.
- 2. Ensure instrumentation to be used for obtaining trial data is properly installed, calibrated and certified.
 - a. The NSA shall determine, in conjunction with the Commanding Officer, any special instrumentation required such as flow meters, torsion meters and calorimeters. Government Loaned Equipment may be made available with NAVSEA approval. The NSA will ensure the installation of any other temporary test instrumentation and equipment necessary for the trials except as otherwise stated herein or as indicated on the list of Government Furnished Equipment.
 - b. Unless otherwise specified, the NSA shall ensure the installation of all temporary instrumentation and equipment regardless of who furnished it. All temporary instrumentation and equipment shall be removed from the ship by the NSA upon conclusion of the trial. It shall be the NSA's responsibility to maintain Government Loaned Equipment in proper working order. The NSA shall calibrate, test and otherwise ensure both temporary and permanent instrumentation utilized to collect data for trials is reliable. Government furnished flow meters on loan from Naval Ship Systems

Engineering Station Philadelphia will be calibrated by Naval Ship Systems Engineering Station.

- c. Verify proper installation, adjustment and operability of torsion meter, if installed (reference (w), section 1.4.1.f).
- d. Care shall be taken that proper draft and trim of the ship are maintained throughout the duration of the trial (reference (w), section 1.4.1.g).
 - (1) Firefighting systems shall be completely installed, tested and placed in operating condition before the ship is fueled.
 - (2) Fuel ship and adjust draft and trim to attain trial requirements.
- e. Prior to departure, check all communications equipment, including radio, interior communications circuits, telephones and special signal circuits that may be used during the trial.
- f. Zero set EM log.
- g. Settle Navigation System and gyrocompass.
- h. Test arresting gear systems, including barricade (as applicable).
- i. Test Visual Landing Aid systems (as applicable).
- j. Conduct static JP-5 System Certification. Test Control Console functions and conduct system stripping, transferring and purifying operations, as necessary, in preparation for underway systems dynamic operations.

IV. UNDERWAY ENGINEERING AND OTHER MAJOR TESTS.

- 1. The following systems shall be tested to the extent authorized in the NSA's Work Package and test procedures identified in the trial agenda and be in an operating condition at the time of Sea Trial (reference (an), Chapter 094c). Table 1 summarizes general items. Procedural precedence is current PMS, equipment technical manuals and NAVSEA technical manuals procedures:
 - a. Newly installed, modified or overhauled ventilating, heating and air conditioning systems.
 - b. Newly installed, modified or overhauled firefighting systems and damage control equipment.
 - c. Newly installed, modified or overhauled alarms and safety devices.
 - (1) All alarm systems shall be operative.
 - (2) Gages and safety devices shall be checked and all final adjustments completed in accordance with technical specifications.
 - (3) SSTG Resistance Temperature Element settings may be made according to reference (ap), Table 231-3-2 during dockside testing at 0 to 100 percent load or during Sea Trials, whichever gives the highest temperature reading (reference (p), section 3.10.3.4.1-.3).
 - d. Newly installed, modified or overhauled interior communication systems.
 - e. Newly installed, modified or overhauled radio and navigation systems.
- 2. Propulsion systems.
 - a. Particular attention shall be paid to boiler water treatment levels during Dock and Sea Trials. Additional tests of water chemistry and increased bottom blowdown frequency shall be planned (reference (aq), section 2.4.12).

- b. A full power run shall be scheduled following each regular maintenance availability to ascertain the propulsion plant is capable of full power operation. The following general rules shall be observed during all full power trials and during other machinery trials to which they may be applicable, consistent with conditions imposed (reference (w), section 1.4.1.e):
 - (1) In diesel powered ships not required to be fitted with torsion meters, brake horsepower developed by the main propulsion engines may be closely approximated by careful observations of fuel injection rack positions and compared with data taken during shop tests, where output has been previously measured directly on a dynamometer, or equivalent.
 - (2) Fuel used for the trials should be comparable to that used during shop tests.
 - (3) Average power developed by diesel-electric plants may be computed from kilowatt output from each propulsion generator set. Such observations shall be taken at intervals of not greater than 15 minutes for the duration of the run.
 - (4) In ships required to be fitted with torsion meters, readings of torque and RPM should be taken at sufficiently frequent intervals to produce an essentially continuous record. The record should be averaged at 15-minute intervals, for the duration of the run.
- 3. Main lube oil systems: Post-availability Sea Trial operations will normally jar and vibrate the lube oil system enough to break loose foreign material hidden in the system, even after flushing. To contain this foreign material, muslin or nylon bags shall be kept in the lube oil strainers from initial operation through final Sea Trials (reference (ap), section 3.10.3.4.3). Filter bags and disposable filters shall remain in propulsion machinery lubricating oil systems until Sea Trials are completed, except where 25 or 40 micron filter elements are required for the propulsion lubricating oil system, remove the disposable filter elements and install the applicable cleanable filter elements upon completion of Sea Trials (reference (ar), section 3.7.3.5.2).
- 4. Reduction gear systems for new and overhauled gears: At the first Sea Trial, determine proper tooth contact of main pinions and gears and conduct operational tests. After trials, in addition to inspections that may be directed by the proper authority, remove the inspection plates and examine the tooth contact and the condition of the teeth to note changes that occurred during the trial (reference (as), section 5.3.9).
- 5. Turbine casing joints: Experience has shown when new bolting is installed, particularly steam chest bolting exposed to temperatures above 900°F, the bolting shall be rechecked and retightened after initial dockside steaming and again after Sea Trials following the overhaul (reference (ap), section 8.7.6).
- 6. Turbine bearing Resistance Temperature Element Settings: Make the initial settings before initially operating the bearing. Make the final settings before the Inspection Survey (INSURV) Trial or final Post Overhaul Trial if an INSURV Trial is not run. Base these settings on the highest values observed from the ship Sea Trials or shipbuilder test form data taken during all previous trials (reference (ap), section 3.10.3.4.2).
- 7. Propulsion demonstrations (reference (an), Chapter 200f).
 - a. Runs ahead at various power levels, using all main propulsion unit combinations, including cruising speed and maximum full-power ahead.
 - b. Runs astern, using all main propulsion unit combinations, including maximum full-power astern.
 - c. For Builder's Sea Trials only: Emergency reversals and crash stops, including maximum design full-power ahead to maximum design full power astern and vice versa.
 - d. Maximum speed steering gear tests ahead, limited speed steering tests astern and such other ship maneuvering tests as the specifications may require.

- e. Twenty percent boiler overload test on one boiler (as applicable).
 - f. Boiler flexibility tests (as applicable).
 - g. Locked-shaft tests (as applicable).
8. Anchor gear demonstration (including towing winch demonstration, if installed) (reference (at), section 3.8.1).
- a. Complete all inspections, repairs and adjustments prior to conducting drop tests.
 - b. Conduct drop tests by or under the direction of experienced personnel from the repair activity.
 - c. Conduct drop test in accordance with the test agenda based on type of repairs conducted. Do not allow more than 15 fathoms (90 ft) of chain to run free without stopping. Observe the 65 fathom (390 ft) maximum depth for the drop test.
- NOTE: 65 FATHOM DROP TEST IS ONLY REQUIRED FOR NEW INSTALLATIONS AND TYPICALLY CONDUCTED AT ORIGINAL SHIP DELIVERY BUILDERS'S SEA TRIALS.**
- d. Conduct anchor retrieval rate test to determine adequacy of power units.
9. Distilling plant test: Conduct twenty-four-hour production capacity check. A shorter test period is permissible with concurrence of the NSA and so indicated in the trials agenda (reference (au), section 7.7.6.3.5).
10. Steering gears: Ensure limits are determined (or have been determined) during current or previous Sea Trials and are posted on the ship control console and in the steering gear room (reference (au), section 2.2.3).
- a. Reference (av), Table 562-2-1 lists the astern limits for several (but not all) ship classes and may be used as a reference. Any limits posted on the ship control console or in the steering gear room shall be strictly followed.
 - b. Conduct an analysis of the hydraulic fluid contamination by a naval test facility as required in accordance with PMS or whenever one of the following conditions exists:
 - (1) Immediately before the first Sea Trials following a maintenance availability.
 - (2) Immediately after Sea Trials following a maintenance availability.
11. Auxiliary propulsion units/Thruster engines: Conduct testing in accordance with the trial agenda based on scope of repairs conducted in accordance with the NSA's contract specifications (reference (w), section 1.4).
12. Electrical ship service generating and distribution system: Conduct testing in accordance with the trial agenda based on scope of repairs conducted in accordance with the NSA's contract specifications (reference (w), section 1.4).
13. Surface ship stabilizing devices: Conduct testing in accordance with the trial agenda based on scope of repairs conducted in accordance with the NSA's contract specifications (reference (aw), section 7.9.4.4).

- a. Conduct an analysis of the hydraulic fluid contamination by a naval test facility as required in accordance with PMS or whenever one of the following conditions exists:
 - (1) Immediately before the first Sea Trials following a maintenance availability.
 - (2) Immediately after Sea Trials following a maintenance availability.
14. Washdown countermeasures and miscellaneous topside demonstrations: Conduct testing in accordance with the trial agenda based on scope of repairs conducted in accordance with the NSA's contract specifications (reference (w), section 1.4).
15. Ballast or deballast ship (when applicable): Conduct testing in accordance with the trial agenda based on scope of repairs conducted in accordance with the NSA's contract specifications (reference (w), section 1.4).
16. Sonar, radar and navigation system demonstrations. Conduct testing in accordance with the trial agenda based on scope of repairs conducted in accordance with the NSA's contract specifications.
17. Underway replenishment demonstrations: Conduct testing (including special winch tests, as applicable) in accordance with the trial agenda based on scope of repairs conducted in accordance with the NSA's contract specifications.
18. Other demonstrations and tests: Conduct testing in accordance with the trial agenda based on scope of repairs conducted in accordance with the NSA's contract specifications. Consideration should also be given to the equipment repaired or overhauled by Ship's Force and subsequent testing is required to validate operability. These items may be tested or demonstrated during Sea Trials providing:
 - a. Such tests do not significantly extend the duration of Sea Trials.
 - b. Such tests are within the capability of Ship's Force.
 - c. Such tests have a prescribed PMS MRC procedure or an equivalent procedure provided by Ship's Force or in service engineering agent which has technical authority concurrence.

V. AIRCRAFT OPERATIONS (IF APPLICABLE).

1. Certify Aircraft Launch and Recovery Equipment (as required).
2. Conduct flight deck certification (as applicable) in accordance with applicable TYCOM instructions (reference (ax)).

TABLE 1.
UNDERWAY TESTS

	Light off distilling plants and conduct 24 hour capacity test
	Test fathometer
	Test Countermeasure Washdown system
	Test navigation radar comparing fixes with visual fixes
	Test Electronic Warfare Support Measures and Identification Friend or Foe
	Conduct infrared communications device checks (Nancy lights)
	Test fire fighting systems, to include Flight Deck and Hangar Bay for aviation capable units
	Test aircraft support systems
	Test steering systems in all modes ahead and astern at optimum design speed for the steering systems in accordance with ship steering technical manuals or ship information book
	Operationally test JP-5 system and components as required for JP-5 System Certification
	Warm up catapults and shoot no loads
	Operate emergency diesel generators carrying ship's load
	Run in shaft seals shifting to forward and after seals
	Test all Aircraft Control and Tracking functions
	Test air conditioning, ventilation and refrigeration systems
	Demonstrate Prairie/Masker Air operation
	Demonstrate Darken Ship
	Operate both forward and after Oxygen-Nitrogen plants
	Test Jet Blast Deflector cooling water systems

NOTE: IF THESE TESTS WERE PERFORMED AND CERTIFIED BY THE INDUSTRIAL ACTIVITY WITHIN TWO (2) MONTHS OF SEA TRIALS AND THE TEST RESULTS WERE SATISFACTORY, THE ITEM MAY BE REDUCED IN SCOPE OR OMITTED.

(This Page Intentionally Left Blank)

APPENDIX L
MINIMUM DOCK TRIALS REQUIREMENTS
(SUBMARINES ONLY)

1. Dock Trials. Ship's Force Dock Trials provide the opportunity to test and check out systems, components and portable equipment prior to the Fast Cruise training period simulating underway conditions. Although normally a period of one day is assigned for integrated Ship's Force Dock Trials, tests and evolutions performed in the one to two weeks prior to the Dock Trial date may be accepted by the CO as fulfilling the requirements of this paragraph. The purpose of Dock Trials is to afford the ship an opportunity to demonstrate that major systems and equipment is in fact ready to support Sea Trials. It is expected that individual equipment will have been satisfactorily tested prior to commencement of the integrated operational tests afforded by Ship's Force Dock Trials.

1.1 Supervising Authority. The industrial activity may desire to conduct "machinery checkouts" or system checks prior to the Ship's Force Dock Trials in order to test the propulsion plant or other ship's systems. In order to support these evolutions, close liaison between the ship's CO and the industrial activity will be required. For these evolutions, completion of repairs or modifications to all ship's systems are not required except for those systems which directly support the proposed tests.

1.2 Scheduling of Tests. The scheduling of Ship's Force Dock Trials is flexible. Ship's Force Dock Trials may be scheduled by mutual agreement between the ship and the supervising authority but must take place prior to certification of crew/material readiness with adequate time allowed for collection of deficiencies discovered during the Ship's Force Dock Trials. Preparation of the agenda and schedule for the Dock Trials is the CO's responsibility.

1.3 Extent of Trials. Ship's Force Dock Trials are conducted by the Ship's Force and are normally unhampered by repair work. This applies to the entire ship not just the propulsion plant. The trials may be witnessed by the industrial activity.

1.3.1 Tests. The term "test" shall include, where applicable:

- a. The review and use of a procedure for correct line-up, starting, operation and securing of systems or equipment.
- b. Rigging, connecting and using all hoses, fittings and devices required for the test evolution.
- c. Operation of systems in all modes, such as emergency, hand, override, cross-connected, normal, local, etc.
- d. Checking all electrical and mechanical, local and remote indicators for proper readings.
- e. Testing communications between normal control station and other locations involved in operating the system or performing the evolution.
- f. Calibration and adjustment of equipment, systems and devices where required.
- g. Inventory consumables, fittings, devices and portable test equipment to ensure that sufficient amounts are on board for proper operation throughout the trials.

1.3.2 Specific Test Areas. There are specific tests which relate to both systems and ship safety which must be conducted in preparation for Sea Trials.

- a. The following are specific alongside tests which shall be conducted during Dock Trials:
 - (1) Check the sound powered phone system between all stations.
 - (2) Check the announcing system between all stations.
 - (3) Test collision alarm and diving alarm.
 - (4) Test general alarm.
 - (5) Test each light on Ballast Control Panel (BCP).

- (6) Test whistle.
- (7) Check emergency lights.
- (8) Operate all hydraulic plants using each installed pump.
- (9) Conduct a complete air charge using only ship's compressors.
- (10) Conduct a normal battery charge using ship's motor generator on shore power.
- (11) Conduct low pressure blow of all Main Ballast Tanks (MBT). Thereafter conduct the dockside portions of URO 022 (remote static blow and local static blow).
- (12) Fill sanitary tanks and then blow/pump them.
- (13) Operate each main vent in hand and power. Following operation, with valves shut, conduct a controlled removal of MBT vent covers, one at a time, to check MBT vents for leaks.
- (14) Operate the outboard induction in hand and power.
- (15) Operate the diesel engine exhaust valve in hand and power.
- (16) Operate inboard induction valve.
- (17) Raise, train and lower periscopes, snorkel, radar and antenna masts and fairings as applicable.
- (18) Test operation of radio transmitters and receivers on all antennas.
- (19) Operate all sonar and radar equipment at rated conditions.
- (20) Take and plot Global Positioning System fixes using each antenna.
- (21) Test operation of drain pump using each bilge suction.
- (22) Test operation of trim system and pump by pumping to and from each tank and by pumping to and from sea (if applicable).
- (23) Review and enter the diving trim calculation provided by the shipyard Naval Architects (or equivalent).
- (24) Test operation of portable submersible pump from each installed outlet.
- (25) Fire inboard slugs from torpedo room.
- (26) Fire inboard slugs from weapons launch console.
- (27) Test magazine flooding system.
- (28) Operate each lube oil system including pumps, controllers, purifiers and indicators.
- (29) Energize the Navigation System and gyrocompasses; determine that they settle out and take an azimuth; check all repeaters.
- (30) Check fresh water system, have water samples analyzed.
- (31) Test the capstans.
- (32) Test bow plane rigging (where applicable).
- (33) Test bow/sail and stern plane tilting in hand, normal power and emergency. Test normal and emergency plane angle indicators.
- (34) Test rudder in hand, normal and emergency power. Test normal and emergency rudder angle indicators.
- (35) Check alignment of periscopes, TBTs and all bearing and range repeaters.
- (36) Test the engine order telegraphs.

- (37) Test Automatic Bus Transfer Devices.
- (38) Operate each watertight door and hatch, each bulkhead flapper and each intercompartment air salvage valve.
- (39) Check operation of escape hatch fittings.
- (40) Operate signal ejectors by impulse and hand using dummy signal. Fire water slugs from all launchers, both locally and remotely.
- (41) Turn on and check running lights for brightness and proper lenses (to be done at night).
- (42) Check freon air conditioning system.
- (43) Check underwater log.
- (44) Check 400 Hz MG sets.
- (45) Check out galley equipment.
- (46) Check fathometer.
- (47) Check bilge flooding alarms.
- (48) Check dummy log.
- (49) Check ship service air system.
- (50) Check out vapor compressor distilling units.
- (51) Check anchor windlass and brake operation.
- (52) Check battery water system. (NA for SVRLA-equipped ships)
- (53) Check out atmosphere monitoring equipment, both installed and portable.
- (54) Operate oxygen generator, CO₂ scrubbers, CO burners and emergency air breathing system.
- (55) If possible, lower, train, operate and raise the SPM.
- (56) Ensure that all required PMS to ship depth detectors is complete.
- (57) Verify that the PMS for this diesel engine high vacuum cutout is current.
- (58) Check main propulsion. (Should be done during the propulsion plant test program)
- (59) Ensure seven-day supply of oxygen onboard, test operate the Electrolytic Oxygen Generator(s) (EOG)

(This Page Intentionally Left Blank)

APPENDIX M
MINIMUM FAST CRUISE REQUIREMENTS
(SUBMARINES ONLY)

1. Fast Cruise Requirements. Asterisk items are the minimum requirements for an industrial activity availability of less than six months duration. All listed items are the minimum requirements for an industrial activity availability of greater than six months duration.

a. All Ships (as applicable):

- * (1) Station the maneuvering watch and check each system and piece of equipment for proper operation. (For availability less than six months duration, system/equipment checks are **not** required).
- * (2) Station the normal underway watch (section watches).
- (3) Simulate getting underway and return to port (day and night).
- * (4) Walk through all major Sea Trial evolutions, including cycling of hull and back-up valves to be tested during the deep dive.
- * (5) Exercise the reduced visibility detail.
- * (6) Emergency ventilate a compartment.
- (7) Spot check storage and availability of spare parts and tools. Verify adequacy of stores and provisions.
- * (8) Rig for dive and rig for surface.
- * (9) Simulate diving and surfacing.
- * (10) Rig for deep submergence.
- (11) Rig for various quiet conditions.
- (12) Drill at loss of power to various circuits including lighting, communications, 400 Hz power, etc.
- (13) Battery charge - Normal or equalizer as required. (NA for SVRLA-equipped ships)
- * (14) Conduct the following emergency drills:
 - * (a) Fire.
 - * (b) Collision.
 - * (c) Flooding.
 - * (d) Toxic Gas.
 - (e) Abandon Ship.
 - * (f) Man Overboard.
 - (g) Submarine Escape.
 - (h) Loss of AC Power.
 - (i) Emergency Ventilation.
 - (j) Loss of Air Conditioning.
 - (k) Loss of Lighting.
 - (l) Loss of Interior Communications.

- (15) Exercise the crew at battle stations.
 - (16) Conduct communications and ESM drills.
 - *(17) Conduct an air charge to all air banks. (For availabilities less than six months duration "Conduct an air charge").
 - *(18) Bleed oxygen and ventilate ship. Ensure a seven day supply of oxygen is onboard and EOG(s)/Integrated Low Pressure Electrolyzer are fully operational. Ships without EOG(s) may provide a seven day supply of oxygen in O2 candle form and have oxygen banks inerted until after availability completion.
 - (19) Simulate anchoring.
 - (20) Operate atmosphere control equipment and take air samples.
 - *(21) Check out all interior communications circuits, including battle telephones.
 - (22) Simulate submerged patrol, performing all evolutions and operating equipment normally used.
 - *(23) Operate freshwater/seawater heat exchangers at sufficient load to verify proper operation (not fouled with marine growth).
 - (24) Submarines shall meet all requirements of reference (t), Appendix D, Part 3.
- b. Additional requirements for SSBN/SSGNs. SSBN/SSGNs shall conduct exercises in casualties to missile tube breather valves which would result in:
- (1) Flooding.
 - (2) Introducing toxic gases into the missile compartment from gas generators.

APPENDIX N

**MINIMUM SEA TRIALS REQUIREMENTS FOR CHIEF OF NAVAL OPERATIONS
AVAILABILITIES LESS THAN SIX MONTHS DURATION**

(SUBMARINES ONLY)

1. Sea Trial Agenda. This Appendix delineates the minimum requirements incident to Sea Trials following a Chief of Naval Operations availability of less than six months duration. Additional events listed in Appendix O, Minimum Sea Trials Requirements for Chief of Naval Operations Availabilities Greater Than Six Months Duration (Submarines only), may be included by the shipyard based on the scope of the work accomplished and/or as desired by the CO.
2. Sea Trial Policy. The following policies apply to conduct of trials and tests associated with industrial activity availabilities, NAVSEA or Naval Surface Warfare Center, Carderock Division sponsored Trials/Tests or any other situation where the ship is requested to conduct trials or tests:
 - a. No test or trial event shall be conducted that requires crew intervention to avoid exceeding normal operating limits. Trial agendas will be based on the expectation that the ship will remain within normal operating limits of the SOE and at angles less than 30 degrees.
 - b. The trial director(s) must be prepared to project whether the next event might exceed normal operating limits based on the empirical results of the previous event. A run that is predicted to exceed normal operating limits should be deleted along with the more demanding runs of that sequence.
 - c. Any run which will result in exceeding normal operating limits of the SOE or 30 degree angles but which is essential to provide adequate test data must be specifically approved by the TYCOM. The test/trial sponsor will obtain this permission.
 - d. A violation of the SOE limit or exceeding a 30 degree angle, not previously approved, should be reported by unit SITREP. The TYCOM will resolve the situation.
 - e. Specific written approval by the TYCOM is not required to operate outside the upper limits of the SOE (i.e., shallow and fast) while conducting the following operations during Sea Trials or tests in accordance with an agenda approved by the ISIC, NAVSEA or higher authority:
 - (1) Conducting full power runs or cavitation curves.
 - (2) NAVSEA sponsored acoustic trials in accordance with Naval Surface Warfare Center, Carderock Division acoustic trial agenda.
 - f. In cases where troubleshooting is required, it must meet the following criteria or a formally approved change to the agenda is mandatory.
 - (1) The troubleshooting does not violate any policy listed in paragraphs 2.a. through 2.e. of this Appendix or any other requirement of the trials agenda.
 - (2) The troubleshooting will not result in the ship being in a certain condition before that condition is reached during the normal testing sequence. For example, troubleshooting requiring the ship to be deeper than 200 feet cannot be done until after the deep dive. Likewise, troubleshooting requiring large angles or turn rates cannot be done until after the completion of the steering and diving operational tests and the large angle tests.
 - g. Each person involved in Sea Trials should be allowed to obtain a minimum of six hours of continuous, uninterrupted sleep during any 24-hour period.
3. Test Phasing. The Sea Trials should be scheduled and phased to support actions enroute to the test dive area, in the test dive area, prior to the deep dive, etc., subject to the amplifying notes.
 - a. The following tests and evolutions shall be carried out on the surface enroute to the test dive area and prior to the initial tightness dive:

- (1) Underway. Rig for dive.
 - (2) Ship's Force instruct Sea Trials riders on the proper use of Emergency Air Breathing System.
 - (3) At slow speed, conduct operational test of rudder in all modes (local and remote) in accordance with applicable class operating procedures.
 - (4) Navigation system check. Take fixes by all means available and compare.
 - (5) Test underwater log(s) using the base course/reciprocal course method (i.e., inertial reference method) or other approved functional procedures to determine accuracy.
 - (6) Test accuracy of all bearing transmitters and indicators. Compare sonar, visual and radar bearings.
 - (7) Check operation of all radars. Demonstrate accuracy by conducting simultaneous radar and visual plot.
 - (8) Inspect stern tube packing gland/seals and circulating water flow for excessive heating, leakage and audible noise.
 - (9) Test fathometer(s) and compare with charted soundings.
 - (10) Run ahead at maximum allowable surface speed long enough for temperatures to reach a stable value. After readings have stabilized, at maximum allowable surface speed, operate the rudder through full throw in each direction, in all remote modes of operation.
 - (11) Ahead, at maximum allowable surface speed, to back emergency.
For SSBN/SSGN 726 Class only - Answer ahead standard. Once ship speed has stabilized, perform back emergency for 5 minutes.
 - (12) Run astern up to a back full bell. Full power run astern to be within the main engine limits of the applicable Steam and Electric Plant Manual. For SSBN/SSGN 726 Class only - Run astern up to a back full bell for 5 minutes, followed by 60 SRPM for 5 minutes. (See Note 1.)
 - (13) Check operation and accuracy of ship's gyro compass.
 - (14) Rendezvous with escort, if an escort is required. Conduct radio and sonar communications checks (See Note 2).
 - (15) Rig out bow planes, if applicable. Test bow/fairwater and stern planes in all modes.
 - (16) Flood variable tanks to computed compensation less a safety factor.
 - (17) Operate trim and drain pumps.
 - (18) Test variable ballast system for proper operation.
 - (19) Perform both a low pressure blow and an EMBT blow for as long as necessary to verify system operability. A static blow shall not be used to test the EMBT blow system. For SSN 23 only: Additionally, perform an MBT 6 normal blow from the BCP for a minimum duration of 2 seconds to verify that air flows into MBT 6 as indicated by a reduction in air bank pressure. For SSBN/SSGN 726 Class submarines only: Additionally, perform a high pressure blow for as long as necessary to verify system operability.
 - (20) Check that initial EMBT Blow system actuating air pressure and air bank pressure is within +0 PSIG, -200 PSIG of nominal operating air pressure.
 - (21) Ensure all MBT blow systems are in a normal line up configuration.
 - (22) Additional requirements may be imposed at the discretion of the CO.
- b. The following tests and evolutions shall be carried out immediately prior to or during the initial tightness dive:
- (1) Obtain navigational fix and take sounding. Maximum depth of water is 400 feet as specified in reference (u).

- (2) Rig ship for deep submergence. Line up propulsion plant for maximum reliability. All systems shall be in the maximum secure condition with unnecessary sea systems isolated (See Note 3).
- (3) Station additional personnel throughout the ship to inspect for leaks.
- (4) Transmit commencing initial tightness dive message. Submerge the ship per the Ship Systems Manual Operating Procedures. If desired to conduct periscope depth tests, the ship may be submerged to periscope depth.
- (5) Check operation of ship control systems, including depth indication (See Note 4).
- (6) When escort is required, communicate with escort on RAC/WQC at each depth increment or at 10 minute intervals, whichever is sooner. If communications are lost, return to depth at which communications can be established before continuing (See Note 2).
- (7) All hands inspect for leaks and report them.
- (8) Inspect the discharge of all automatic drains in each EMBT Blow quadrant for sea water leakage prior to the first dive when the ballast tanks are flooded (e.g., at periscope depth).
- (9) At periscope depth, operate all masts checking optics and leakage. Observe speed and depth restrictions for masts without violation of the SOE (See Note 5). Event may be performed following initial dive, if sea state prevents operation at periscope depth.
- (10) Test operation of trim and drain system discharging to sea.
- (11) If not at 150 feet for SSN 688 Class submarines (155 feet for SSN 774 Class submarines), (160 feet for SSBN/SSGN 726 and SSN 21 Class submarines), proceed to 150 feet for SSN 688 Class submarines (155 feet for SSN 774 Class submarines), (160 feet for SSBN/SSGN 726 and SSN 21 Class submarines) and obtain SAT 1/3 trim in accordance with the Ship's Operating Manual. Take readings as required to make a check of ballasting.
- (12) At 200 feet:
 - (a) Adjust trim (See Note 6).
 - (b) Inspect for leaks.
 - (c) Communicate with escort at each depth increment or at 10-minute intervals, whichever is sooner. If communications are lost, return to depth at which communications can be re-established before continuing (See Note 2).
- (13) At 200 feet, in accordance with reference (ai):
 - (a) Check accuracy of gauges and repeaters (See Note 4).
 - (b) Evaluate signal ejectors or launchers. Conduct operational test of each by hand and impulse methods, as applicable (See Note 7).
 - (c) Check shafting bearings and stern tubes for excessive heating, leakage and noise. Main shaft seals must be tested at each depth specified in reference (ai) testing one seal for 20 minutes, and shifting to the other seal. Test the second seal for 20 minutes or until the boat is ready to go to the next depth, whichever comes first.
 - (d) Cycle rudder and planes through full throw at slow speed to check for binding.
 - (e) Operate all Main and Auxiliary Sea Water hull and back-up valves and those other seawater system valves worked during the availability (using remote closures, as applicable, from flooding control stations) that are required to maintain propulsion and other functions vital to the ship's operation.

NOTE: REQUIRED SYSTEMS ARE LISTED IN PARAGRAPH 4b OF REFERENCE (ai). OBSERVE RESTRICTIONS ON OPERATION OF SYSTEMS LISTED IN PARAGRAPH 4d OF REFERENCE (ai).

- (f) Test operation of trim and drain system discharging to sea.
 - (g) Cycle main ballast tank vents hydraulically to check for binding.
 - (14) Test the SPM (see Note 13 in Appendix O of this chapter).
 - (15) Additional requirements may be imposed at the discretion of the CO.
- c. The following tests and evolutions shall be carried out following the initial tightness dive and prior to the deep dive:
- (1) Transmit initial tightness dive complete message.
 - (2) A minimum of six hours of Individual Ship Exercises submerged for crew training.
 - (3) Charge air banks and battery as necessary. The ship may be submerged while charging air banks provided the depth of the ship does not exceed other guidelines in this instruction, or those of the flooding bill or ship's operating procedure.
 - (4) If escort is required, detach escort after initial tightness dive. Escort will then proceed to station for deep dive. Ensure that deep dive rendezvous time and location are clearly established before escort is released. The escort may be retained for additional testing during the transit as described in Appendix P. Transit depths shall not exceed depth as described in Appendix P.
 - (5) Additional requirements may be imposed at the discretion of the CO.
- d. The following tests and evolutions shall be carried out immediately prior to or during the deep dive:
- (1) Check that initial EMBT Blow system actuating air pressure and air bank pressure is within +0 PSIG, -200 PSIG of nominal operating air pressure.
 - (2) Verify MBT systems lined up for normal operation.
 - (3) Take sounding. Accurately fix ship's position within the specified dive area in accordance with reference (u). Transmit the commencing deep dive message.
 - (4) Proceed to normal submergence depth and obtain 1/3 speed trim. Use conservative angles and speed on initial dive.
 - (5) Trim ship to maintain neutral buoyancy (See Note 6).
 - (6) Rig ship for deep submergence. Line up propulsion plant for maximum reliability. All systems shall be in the maximum secure condition with unnecessary sea systems isolated (See Note 3).
 - (7) Station additional personnel throughout the ship to inspect for leaks.
 - (8) At 400 feet and then in increments of 100 feet descending to one-half the maximum operating depth and every 100 feet or other lesser specified increments thereafter down to the maximum authorized operating depth:
 - (a) Adjust trim (See Note 6).
 - (b) Inspect for leaks.
 - (c) Communicate with escort (if escort required) at each 100 foot depth increment or at 10 minute intervals, whichever is sooner. If communications are lost, return to a depth at which communications can be re-established before continuing (See Note 2).

NOTE: REQUIRED SYSTEMS ARE LISTED IN PARAGRAPH 4b OF REFERENCE (ai). OBSERVE RESTRICTIONS ON OPERATION OF SYSTEMS LISTED IN PARAGRAPH 4d OF REFERENCE (ai).

- (9) At depths listed for hull valve cycling in reference (ai) including the maximum authorized operation depth:

- (a) Check accuracy of gauges and repeaters (See Note 4).
- (b) Evaluate signal ejectors or launchers. Conduct operational test of each by hand and impulse methods, as applicable (See Note 7).
- (c) Check shafting bearings and stern tubes for excessive heating, leakage and noise. Main shaft seals must be tested at each depth specified in reference (ai) testing one seal for 20 minutes, and shifting to the other seal. Test the second seal for 20 minutes or until the boat is ready to go to the next depth, whichever comes first.
- (d) Cycle rudder and planes through full throw **at slow speeds** to check for binding. Cycling of rudder and planes through full throw **shall** be limited to 90% of test depth. **For SSN 21 Class follow the specific Sea Trial Agenda.**
- (e) Operate all Main and Auxiliary Sea Water hull and back-up valves and those other seawater system valves worked during the availability (using remote closures, as applicable, from flooding control stations) that are required to maintain propulsion and other functions vital to the ship's operation at increments of depth specified in reference (ai).

NOTE: TRASH DISPOSAL UNITS (TDU) WITH BALL VALVES WILL NOT BE OPERATED BELOW 200 FEET. TDUs WITH FLAPPER VALVES WILL NOT BE OPERATED BELOW 150 FEET.

- (f) Operate trim and drain pumps, discharging to sea.
- (g) Cycle main ballast tank vents to check for binding. Main ballast tank vents will be cycled hydraulically except at test depth where they will be cycled manually.
- (10) Surface fully with EMBT blow in accordance with applicable URO MRC. Check air bank pressures before and after blow. For SSN 23 only: Perform an MBT 6 normal blow from the BCP until MBTs 6A and 6B are blown to residual water levels.
- (11) Transmit completion of deep dive message.
- (12) Additional requirements may be imposed at the discretion of the Commanding Officer.
- e. The following tests and evolutions shall be carried out submerged following the deep dive:
 - (1) Full power run (See Notes 8, 9 and 10).
 - (2) Emergency stop (See Notes 9 and 10).
 - (3) Steering and diving operation at full speed (See Note 11).
 - (4) Steep angles - operate ship through several depth changes using large up and down angles. Check operation of ship machinery (See Note 9).
 - (5) Time raising each periscope and mast at maximum depth and speed for which they are designed. Check training feature where applicable.
 - (6) Run and observe air conditioning plants throughout trials noting deficiencies. Operate the Lithium Bromide air conditioning plant (if installed) to demonstrate ability to carry entire maximum existing ship's air conditioning load or 100 percent capacity.
 - (7) Additional requirements may be imposed at the discretion of the Commanding Officer.

4. Sea Trial Conclusion. At the conclusion of Sea Trials, and based on a review of Sea Trial deficiencies and TYCOM concurrence, the submarine may transit to a port other than the overhauling activity. During this transit the submarine shall not operate at depths greater than one-half test depth plus fifty feet, unless specifically authorized by NAVSEA, and shall not be released for unrestricted operations until final certification is received via message from the TYCOM (Appendix BO).

NOTES

1. For SSBN/SSGN 726 Class submarines only - This surface evolution, full power run astern, shall be conducted only if maintenance was accomplished on the reduction gears, the astern throttle(s) or the main shaft thrust bearing.
2. In the execution of any Sea Trial, whether escorted or not, submarine COs are reminded of their responsibility to communicate with escorts and/or shore authorities within the prescribed previously agreed upon time limits to avoid initiation of lost submarine procedures.
3. Reference (ai) (C9094.2 (Series)) prescribes procedures for system operation during the deep dive.
4. Compare all depth and pressure gauges. Depth and pressure gauges should be checked as soon as each next specified depth is reached.
5. Any evolutions (e.g., mast testing, propeller cavitation data collection, etc.) required by the Sea Trials Agenda which violate the ship's SOE must be approved by the TYCOM prior to Sea Trials in accordance with paragraph 2 of this Appendix.
6. Deep dive should be conducted using moderate speed and constantly adjusting trim, at depths indicated in paragraphs 3.b.(12)(a) and 3.d.(8)(a) of this Appendix, to maintain neutral buoyancy. Moderate speed shall be defined as that range of speed that allows the ship to recover from a loss of stern plane control or flooding casualty.
7. Integrity of launchers or signal ejectors shall be established by admitting sea pressure through equalizing lines or flooding connection and the muzzle valve/door operated before conducting operational tests. Shoot water slugs from specified launchers or signal ejectors, at depths specified by reference (ai). Shoot pyrotechnics on initial dive and at test depth on deep dive only if work was accomplished on the launchers or signal ejectors or if an escort vessel is required for the trial.
8. Run full power submerged for at least two hours. Operate at minimum non-cavitating depth but not to exceed 400 feet, in accordance with reference (u); water depth is not limited for this event.
9. Note that the required sequence of events is initial dive, deep dive, full power run submerged, back emergency, then high speed maneuverability and steep angle tests. Initial high speed ship control tests, steep angle tests and exercises at major casualties shall be conducted in water that does not exceed one and one-half times design test depth.
10. The submerged full power run with an ahead flank bell is to be terminated with a back emergency bell, consistent with current Main Propulsion Operating Limits (shaft torque is not a limiting factor in this test). The duration of the back emergency bell will be limited to 45 seconds, to be followed immediately by an appropriate ahead bell. The 45 second limit will:
 - a. Standardize the crashback requirements throughout the submarine force.
 - b. Provide a backing transient similar to that experienced in response to a stern plane jam.
 - c. Be short enough that no ship will gather sternway.
11. At maximum safe speed, operate the rudder and planes through full throw in both directions, in all remote modes of operation.

APPENDIX O

**MINIMUM SEA TRIALS REQUIREMENTS FOR CHIEF OF NAVAL OPERATIONS
AVAILABILITIES GREATER THAN SIX MONTHS DURATION**

(SUBMARINES ONLY)

1. Sea Trial Agenda. This Appendix provides the minimum requirements following a major Depot availability of greater than six months duration. Due to unique ship configuration, work performed or operational area requirements, these events may be re-sequenced as they are integrated with the testing required to certify shipyard and Ship's Force work, and the additional events required by the Commanding Officer of the submarine. TYCOM approval and NAVSEA concurrence with these changes is obtained when NAVSEA concurs and the cognizant TYCOM approves the agenda.

2. Sea Trial Policy. The following applies to the conduct of trials and tests associated with ships following major industrial activity availabilities, NAVSEA or Naval Surface Warfare Center, Carderock Division sponsored Trials/Tests or any other situation where the ship is requested to conduct trials or tests:

- a. No test or trial event shall be conducted that requires crew intervention to avoid exceeding normal operating limits. Trial agendas will be based on the expectation that the ship will remain within the normal operating limits of the SOE and at angles less than 30 degrees.
- b. The trial director(s) must be prepared to project whether the next event might exceed normal operating limits based on the empirical results of the previous event. A run that is predicted to exceed normal operating limits should be deleted along with the more demanding runs of that sequence.
- c. Any run which will result in exceeding normal operating limits of the SOE or 30 degree angles but which is essential to provide adequate test data must be specifically approved by the TYCOM. The test/trial sponsor will obtain this permission.
- d. A violation of the SOE limit or exceeding a 30 degree angle, not previously approved, should be reported by unit SITREP. The TYCOM will resolve the situation.
- e. Specific written approval by the TYCOM is not required to operate outside the upper limits of the SOE (i.e., shallow and fast) while conducting the following operations during Sea Trials or tests in accordance with an agenda approved by the ISIC, NAVSEA or higher authority:
 - (1) Conducting full power runs or cavitation curves.
 - (2) Conducting NAVSEA sponsored acoustic trials in accordance with Naval Surface Warfare Center, Carderock Division acoustic trial agenda.
 - (3) The 200 foot EMBT blow conducted at the conclusion of the initial tightness dive.
- f. In cases where troubleshooting is required, it must meet the following criteria or a formally approved change to the agenda is mandatory.
 - (1) The troubleshooting does not violate any policy listed in paragraphs 2.a. through 2.e. of this Appendix or any other requirement of the trials agenda.
 - (2) The troubleshooting will not result in the ship being in a certain condition before that condition is reached during the normal testing sequence. For example, troubleshooting requiring the ship to be deeper than 200 feet cannot be done until after the deep dive. Likewise, troubleshooting requiring large angles or turn rates cannot be done until after the completion of the steering and diving operational tests and the large angle tests.
 - (3) The depth authorization for sea trials is automatically suspended upon re-entry to the SUBSAFE certification boundary or casualty affecting recoverability, salvage, watertight integrity or operation of the ship's control surfaces. The ship shall not operate at a depth greater than 200 feet until re-entry is certified to the TYCOM and the TYCOM grants approval to operate (resume sea trials) to test depth.

- (4) In the instance of SUBSAFE REC conducted only to adjust Flood Control hydraulic valve/hull closure timing (discovered during individual valve/hull closure cycling or during Flood Control System Operation), the ship is authorized to continue with Sea Trials without specific message correspondence from TYCOM and the most recent depth message is considered valid, provided that:
 - (a) The ship initiates a REC to correct the identified valve/hull closure timing deficiency and the ship operates no deeper than 200 feet while valve/hull closure timing adjustments are in progress.
 - (b) Valve/hull closure timing, as well as applicable flood control system timing, is verified to be within specification prior to resumption of the deep dive or proceeding to depths greater than 200 feet.
 - (c) The REC is closed and a report is made to TYCOM on material deficiencies and corrective actions taken related to Flood Control valve/hull closure timing adjustments prior to resumption of the deep dive or proceeding to depths greater than 200 feet.
- g. Each person involved in Sea Trials should be allowed to obtain a minimum of six hours of continuous, uninterrupted sleep during any 24 hour period.

3. Test Phasing. The Sea Trials should be scheduled and phased to support actions en route to the test dive area, in the test dive area, prior to the deep dive, etc., subject to amplifying notes as follows:

- a. The following tests and evolutions may be carried out at any time during Sea Trials.
 - (1) Test operation of fresh water production (distilling plants or reverse osmosis systems) noting deficiencies.
 - (2) Test operation of high pressure and low pressure air compressors.
 - (3) Run and observe air conditioning plants throughout trials noting deficiencies. Operate air conditioning plant to demonstrate ability to carry the maximum existing ship's air conditioning load, or 100 percent capacity.
 - (4) Run and observe refrigeration plant throughout trials, noting deficiencies.
 - (5) Operate IFF and ESM equipment. If possible, use aircraft.
 - (6) Test all radio transmitters, receivers, and electronic equipment. Test on all possible antenna combinations including emergency antennas and emergency radio equipment.
 - (7) Fire control system operation. Check target designation system, alignment of sensors to bench marks and transmissions to receivers. Compute fire control solutions on available contacts. Conduct transmission checks to tubes.
 - (8) Check operation of magazine flooding if not tested in industrial activity.
 - (9) Additional requirements may be imposed at the discretion of the CO.
- b. The following tests and evolutions, summarized in Appendix P, shall be carried out on the surface en route to the test dive area and prior to the initial tightness dive:
 - (1) Underway. Rig for dive.
 - (2) Ship's Force instruct Sea Trial riders on the proper use of Emergency Air Breathing system.
 - (3) At slow speed, conduct operational tests of rudder in all modes (local and remote) in accordance with applicable class operating procedures.
 - (4) Navigation system check. Take fixes by all means available and compare.
 - (5) Test underwater log(s) using the base course/reciprocal course method (i.e., inertial reference method) or other approved functional procedures to determine accuracy.
 - (6) Test accuracy of all bearing transmitters and indicators. Compare sonar, visual and radar bearings.

- (7) Check operation of all radars. Determine accuracy by conducting simultaneous radar and visual plot.
 - (8) Inspect stern tube packing gland/seals and circulating water flow for excessive heating, leakage and audible noise.
 - (9) Test Dead Reckoning Analyzer Indicator (if installed) or Dead Reckoning Analyzer (if installed), Dead Reckoning Tracers (if installed) and Revolution Per Minute (RPM) indication.
 - (10) Test fathometer(s) and compare with charted soundings.
 - (11) Run ahead at maximum allowable surface shaft RPM long enough for temperatures to reach a stable value. After readings have stabilized, at maximum allowable surface shaft RPM, operate the rudder through full throw in each direction, in all remote modes of operation. Time evolution and compare with design values. (See Note 1).
 - (12) Ahead, at maximum allowed surface shaft RPM, to back emergency.
For SSBN/SSGN 726 Class **only** - Answer ahead standard. Once ship speed has stabilized, perform back emergency for 5 minutes. This event may be conducted after the submerged full power run.
 - (13) Run astern up to a back full bell for 10 minutes or to meet the intent of a more restrictive industrial activity test. Full power run astern to be within the main engine limits of the applicable Steam and Electric Plant Manual.
For SSBN/SSGN 726 Class **only** - Run astern up to a back full bell for 5 minutes, followed by 60 SRPM for 5 minutes. (See Note 3.)
 - (14) Check operation and accuracy of ship's gyrocompass.
 - (15) Rendezvous with escort. Conduct radio and sonar communications checks (See Note 4).
 - (16) Test all bottomside sonars.
 - (17) Rig out bow planes, if applicable. Test bow/fairwater and stern planes in all modes.
 - (18) Flood variable tanks to computed compensation less a safety factor.
 - (19) Perform resistance measurement checks on all antennas, as appropriate.
 - (20) Operate trim and drain pumps (See Note 5).
 - (21) Test variable ballast system for proper operation.
 - (22) Perform both a low pressure blow and an EMBT blow for as long as necessary to verify system operability. A static blow shall not be used to test the EMBT blow system. For SSN 23 only: Additionally, perform an MBT 6 normal blow from the BCP for a minimum duration of 2 seconds to verify that air flows into MBT 6 as indicated by a reduction in air bank pressure. For SSBN/SSGN 726 Class submarines only: Additionally, perform a high pressure blow for as long as necessary to verify system operability.
 - (23) Operate the Emergency Propulsion Motor for 10 minutes.
 - (24) Surface ventilate ship.
 - (25) Check that initial EMBT Blow system actuating air pressure and air bank pressure is within +0 PSIG, -200 PSIG of nominal operating air pressure.
 - (26) Ensure all MBT blow systems are in a normal line up.
 - (27) Start atmosphere control equipment.
 - (28) Additional requirements may be imposed at the discretion of the CO.
- c. The following tests and evolutions, summarized in Appendix P, shall be carried out immediately prior to or during the initial tightness dive:

- (1) Obtain navigational fix and take soundings. Maximum depth of water is 400 feet as specified in reference (u).
- (2) Rig ship for Deep Submergence. Line up propulsion plant for maximum reliability. All systems shall be in the maximum secure condition with unnecessary sea systems isolated (See Note 6).
- (3) Station additional personnel throughout the ship to inspect for leaks.
- (4) Transmit commencing initial tightness dive message. Submerge the ship per the Ship Systems Manual Operating Procedures. If desired to conduct periscope depth tests, the ship may be submerged to periscope depth.
- (5) Check operation of ship control systems, including depth indication (See Note 7).
- (6) Equalize signal ejectors or launchers. Shoot pyrotechnics from each by hand and impulse methods (See Note 8).
- (7) Communicate with escort on RAC/WQC at each depth increment or at 10 minute intervals, whichever is sooner. If communications are lost, return to depth at which communications can be established before continuing (See Note 4).
- (8) All hands inspect for leaks and report them.
- (9) Inspect the discharge of all automatic drains in each EMBT Blow quadrant for sea water leakage prior to the first dive when the ballast tanks are flooded (e.g., at periscope depth).
- (10) Operate all periscopes checking optics and leakage. Operate all masts.
- (11) Test full throw of rudder and planes at slow speeds.
- (12) Test operation of trim and drain system discharging to sea.
- (13) If not at 150 feet for SSN 688 Class submarines (155 feet for SSN 774 Class submarines), (160 feet for SSBN/SSGN 726 Class and SSN 21 Class submarines), proceed to 150 feet for SSN 688 Class submarines (155 feet for SSN 774 Class submarines), (160 feet for SSBN/SSGN 726 Class and SSN 21 Class submarines) and obtain SAT 1/3 trim in accordance with the Ship's Operating Manual. Take readings as required to make a check of ballasting.
- (14) Test all sonar equipment on each hydrophone. In addition, for SSBN/SSGN 726 Class submarines, test the Emergency Underwater Telephone (BQC) on each hydrophone.
- (15) At 200 feet:
 - (a) Adjust trim (See Note 10).
 - (b) Inspect for leaks.
 - (c) Communicate with escort at each depth increment or at 10 minute intervals, whichever is sooner. If communications are lost, return to depth at which communications can be re-established before continuing (See Note 4).
- (16) At 200 feet as specified in reference (ai):
 - (a) Check accuracy of depth gauges and repeater (See Note 7).
 - (b) Equalize signal ejectors or launchers and conduct operational tests (See Note 8).
 - (c) Check shaft bearings and stern tubes for excessive heating, leakage and noise. Test one seal for 20 minutes and shift to the other seal. Test the second seal for 20 minutes or until the boat is ready to go to the next depth, whichever comes first.
 - (d) Cycle rudder and planes through full throw, at slow speeds, to check for binding (See Note 11).

- (e) Operate all hull and back-up valves (using remote closures, as applicable, from flooding control stations) of seawater systems required to maintain propulsion and other functions vital to the ship's operation.

NOTE: REQUIRED SYSTEMS ARE LISTED IN PARAGRAPH 4.b. OF REFERENCE (ai). OBSERVE RESTRICTION ON OPERATION OF SYSTEMS LISTED IN PARAGRAPH 4.d. OF REFERENCE (ai).

- (f) Check operation of bulkhead ventilation valves and watertight doors for binding (excluding lower escape hatches).
 - (g) Operate trim and drain pumps, discharging to sea.
 - (h) Cycle components of each torpedo tube. Check for leakage. Establish integrity of torpedo tubes by admitting sea pressure through equalizing lines or flooding connection before cycling components (See Note 2).
 - (i) Cycle main ballast tank vents hydraulically to check for binding.
 - (j) Equalize TDU with sea pressure through trim line, then cycle the muzzle valve.
 - (k) Where installed, demonstrate ability of sanitary pump to discharge overboard.
- (17) Conduct an EMBT blow from 200 feet keel depth. Check bank pressure before and after surfacing. **Additionally, for SSN 23 only, perform a MBT 6 normal blow from the BCP until MBT 6A and 6B are blown to residual water levels.** Surfacing with EMBT blow may be delayed to accommodate additional testing or transit as explained in Appendix P.
- (18) Additional requirements may be imposed at the discretion of the CO.
- d. The following tests and evolutions, summarized in Appendix P, shall be carried out following the initial tightness dive and prior to the deep dive:
- (1) Transmit initial tightness dive completion message. (See Note 19.)
 - (2) A minimum of six hours of Individual Ship Exercises submerged for crew training.
 - (3) Charge air banks and battery as necessary. The ship may be submerged while charging air banks provided the depth of the ship does not exceed other guidelines in this instruction or those of the flooding bill or ship's operating procedures.
 - (4) Detach escort after initial tightness dive. Escort will then proceed to station for deep dive. Ensure that deep dive rendezvous time and location are clearly established before escort is released. The escort may be retained for additional testing during the transit as described in Appendix P. Transit depth shall not exceed depth as described in Appendix P.
 - (5) Additional requirements may be imposed at the discretion of the CO.
- e. The following tests and evolutions, may be carried out following the initial tightness dive but are not required to be completed prior to the deep dive:
- (1) Snorkel on each engine designed for snorkeling. (See Notes 9 and 12).
 - (2) Test the SPM (see Note 13).
 - (3) Check hovering system (See Note 9).
 - (4) Additional requirements may be imposed at the discretion of the CO.
- f. The following tests and evolutions, summarized in Appendix P, shall be carried out immediately prior to or during the deep dive:
- (1) Check that initial EMBT Blow system actuating air pressure and air bank pressure is within +0 PSIG, -200 PSIG of nominal operating air pressure.
 - (2) Verify MBT system lined up for normal operation.

- (3) Take soundings. Maximum water depth is given in reference (u). Accurately fix the ship's position within the specified dive area, in accordance with reference (u). Transmit commencing deep dive message.
- (4) Proceed to normal submergence depth and obtain slow speed trim. Use conservative angles and speed.
- (5) Trim ship to maintain neutral buoyancy (See Note 10).
- (6) Rig ship for deep submergence. Line up propulsion plant for maximum reliability. All systems should be in the maximum secure condition with unnecessary sea systems isolated (See Note 6).
- (7) Station additional personnel throughout the ship to inspect for leaks.
- (8) At 400 feet and then in increments of 100 feet descending to one-half the maximum operating depth and every 100 feet or other lesser specified increments thereafter down to the maximum authorized operating depth:
 - (a) Adjust trim (See Note 10).
 - (b) Inspect for leaks.
 - (c) Communicate with escort at each depth increment or at 10 minute intervals, whichever is sooner. If communications are lost, return to depth at which communications can be re-established before continuing (See Note 4).
- (9) At depths listed for hull valve cycling in reference (ai) (as applicable), except maximum authorized operating depth:
 - (a) Check accuracy of depth gauges and repeater (See Note 7).
 - (b) Equalize signal ejectors or launchers and conduct operational tests (See Note 8).
 - (c) Check shaft bearings and stern tubes for excessive heating, leakage and noise. Main shaft seals must be tested at each depth specified in reference (ai), testing one seal for 20 minutes and shifting to the other seal. Test the second seal for 20 minutes or until the boat is ready to go to the next depth, whichever comes first.
 - (d) Cycle rudder and planes through full throw, at slow speeds, to check for binding (See Note 11).
 - (e) Operate all hull and back-up valves (using remote closures, as applicable, from flooding control stations) of seawater systems required to maintain propulsion and other functions vital to the ship's operation at increments of depth specified in reference (ai).

NOTE: REQUIRED SYSTEMS ARE LISTED IN PARAGRAPH 4.b. OF REFERENCE (ai). OBSERVE RESTRICTION ON OPERATION OF SYSTEMS LISTED IN PARAGRAPH 4.d. OF REFERENCE (ai).

- (f) Check operation of bulkhead ventilation valves and watertight doors for binding (excluding lower escape hatches).
- (g) Operate trim and drain pumps, discharging to sea.
- (h) Cycle components of each torpedo tube. Check for leakage. Establish integrity of torpedo tubes by admitting sea pressure through equalizing lines or flooding connection before cycling components (See Notes 2 and 9).
- (i) Cycle main ballast tank vents to check for binding. Main ballast tank vents will be cycled hydraulically except at test depth where they will be cycled manually.
- (j) Equalize TDU with sea pressure through trim line.
- (k) Where installed, demonstrate ability of sanitary pump to discharge overboard.

NOTE: DURING SEA TRIALS DO NOT OPERATE TDUs WITH BALL VALVES BELOW 200 FEET OR TDUs WITH FLAPPER VALVES BELOW 150 FEET.

- (10) At maximum authorized operating depth:
- (a) Repeat item (9) (a) - Depth gauges and repeaters. (See Note 7)
 - (b) Equalize signal ejectors or launchers. Shoot pyrotechnics from each by hand and impulse methods, as applicable (See Note 8).
 - (c) Repeat item (9) (c) - Shafting and bearings.
 - (d) Repeat item (9) (e) - Cycle hull and back-up valves as specified in reference (ai).
 - (e) Repeat item (9) (f) - Bulkhead ventilation valves and watertight doors.
 - (f) Repeat item (9) (g) - Trim and drain pumps.
 - (g) Repeat item (9) (h) - Torpedo tubes. (See Notes 2 and 9)
 - (h) Repeat item (9) (i) - Cycle main ballast tank vents, manually only, and check for binding.
 - (i) Repeat item (9) (j) - Equalize TDU with sea pressure through trim line.
 - (j) Repeat item (9) (k) - Sanitary pump.
- (11) Prior to blow, visually inspect discharge of automatic drains in each EMBT quadrant for seawater leakage. Surface fully with EMBT blow from maximum authorized operating depth (not to exceed maximum depth permitted by the SOE at the initial speed required for the test). Check air bank pressures before and after blow. For SSN 23 only: Perform an MBT 6 normal blow from the BCP until MBTs 6A and 6B are blown to residual water levels.
- (12) Additional requirements may be imposed at the discretion of the CO.
- g. The following tests and evolutions shall be carried out on the surface following the deep dive:
- (1) Transmit completion of deep dive message. (See Note 19.)
 - (2) Note condition of periscope optics.
 - (3) Measure resistance to ground of all external electrical cables (may be accomplished upon return to dockside port).
 - (4) Take radio antenna resistance measurement readings (as appropriate) immediately after surfacing, if there are UNSAT readings again in one-half hour, and compare with readings obtained in item 3.b.(19) of this appendix.
 - (5) Measure resistance across and to ground from each side of all sonar hydrophones, projectors, and transducers or run applicable sonar hydrophone and transducer fault localization test (See Notes 14 and 20).
 - (6) Measure rodmeter coil and button resistance and coil insulation resistance to ground.
 - (7) Open all lower hatches. Check the upper hatch seals, Logistics Escape Trunks/Logistics Plug Trunks inter-seals and penetrations for leakage. Open the sonar sphere access door, where applicable, and check sonar sphere for leakage.
- h. The following tests and evolutions shall be carried out submerged following the deep dive:
- (1) Full power run (See Notes 15, 16 and 17).
 - (2) Emergency stop (See Notes 15 and 16).
 - (3) Steering and diving operation at full speed (See Notes 16 and 18).
 - (4) Steep angles - operate ship through several depth changes using large up and down angles to check operation of ship machinery (See Note 16).

- (5) Time raising each periscope and mast at maximum depth and speed for which they are designed. Check training feature where applicable.
- (6) Comply with CS/CCS test program with regard to firing of water slugs and testing of torpedo tubes (See Note 2).
- (7) Run ahead at maximum speed allowed by SOE. Operate torpedo tube shutters and ejection pump shutters. If shutters do not open, gradually reduce speed until shutters open. This establishes "stall speed" for each shutter.
- (8) Additional requirements may be imposed at the discretion of the CO.

4. Sea Trial Conclusion. At the conclusion of Sea Trials, and based on a review of Sea Trial deficiencies and TYCOM concurrence, the submarine may transit to a port other than the overhauling activity. During this transit the submarine shall not operate at depths greater than one-half test depth plus fifty feet, unless specifically authorized by NAVSEA, and shall not be released for unrestricted operations until all RECs are closed and final URO certification is received, per the Submarine Safety (SUBSAFE) Requirements Manual.

NOTES

1. **Temporary condensate strainers that cannot be monitored for differential pressure shall be inspected and cleaned during sea trials following at least one hour of operation at between 45 and 55 percent reactor power, and prior to operation at higher power levels, in accordance with reference (ay).**
2. **Fire water slugs from torpedo tubes at the depths and speeds required by the CS/CCS test program (or Combat Systems Assessment or Non-Propulsion Electronic System Operability, Verification and Evaluation, as applicable).**
3. **For SSBN/SSGN 726 Class only - This surface evolution, full power run astern, shall be conducted only if maintenance was accomplished on the reduction gears, the astern throttle(s) or the main shaft thrust bearing.**
4. **In the execution of any Sea Trial, whether escorted or not, submarine COs are reminded of their responsibility to communicate with escorts and/or shore authorities within prescribed, previously agreed upon, time limits to avoid initiation of inadvertent lost contact or submarine disaster procedures.**
5. **Pumps should be tested in the industrial activity, prior to Sea Trials, to determine that they can pump against a test depth head.**
6. **Reference (ai) prescribes procedures for system operation during deep dive.**
7. **Compare all depth and pressure gauges. Depth and pressure gauges should be checked as soon as the next specified depth is reached.**
8. **Integrity of launchers or signal ejectors shall be established by admitting sea pressure through equalizing lines or flooding connection and the muzzle valve/door operated before conducting operational tests. Shoot water slugs from specified launchers or signal ejectors, at depths specified by reference (ai). Shoot pyrotechnics on initial dive and at test depth on deep dive. Shooting of pyrotechnics during the initial dive shall be accomplished in conjunction with the 200 foot EMBT Blow. Shooting of pyrotechnics at test depth during the deep dive shall be accomplished in conjunction with the test depth EMBT Blow.**
9. **If major structural modifications were accomplished, those seawater systems which are not required for normal safe operation of the ship at test depth, but which have been designed for and may be subjected to test depth pressure, should not be subjected to submergence pressure during the initial dive to any specified depth (e.g., blown sanitary tanks). If major structural modifications were not accomplished, those sea water systems which are not required for normal safe operation of the ship at test depth, but which have been designed for and may be subjected to test depth pressure, may be equalized and operated on the initial dive to test depth (See reference (ai)).**

10. Deep dive should be conducted using moderate speed and constantly adjusting trim, at depths indicated in paragraph 3.c.(15)(a) and 3.f.(8)(a) of this Appendix, to maintain neutral buoyancy. Moderate speed shall be defined as that range of speed that allows the ship to recover from a loss of stern plane control or flooding casualty or as otherwise directed by NAVSEA.
11. Cycling of rudder and planes through full throw shall be limited to 90% of test depth. **For SSN 21 Class follow the specific Sea Trial Agenda.**
12. Check operation of electrodes, head valve and each snorkel safety circuit.
13. The following table summarizes SPM/SPU limitations:

TABLE 1. SPM/SPU Limitation Table (all classes)

Operational Cycle	Extend	Retract	Train	*Operate	*Drag
Sea Trials (Post Overhaul, New Construction)	200 Ft 5 Kts	200 Ft 5 Kts	200 Ft 5 Kts	200 Ft 5 Kts	200 Ft 10 Kts

* Do not violate the SOE of the ship.

14. The spherical array need not be done if an array purge or power into the array measurements are scheduled at a later date.
15. The submerged full power run with an ahead flank bell is to be terminated with a back emergency bell, consistent with current Main Propulsion Operating Limits (shaft torque is not a limiting factor in this test). The duration of the back emergency bell will be limited to 45 seconds, to be followed immediately by an appropriate ahead bell. The 45 second limit will:
 - a. Standardize the crashback requirements throughout the submarine force.
 - b. Provide a backing transient similar to that experienced during a stern plane jam.
 - c. Be short enough that no ship will gather sternway.
16. Note that the required sequence of events is initial dive, deep dive, full power run submerged, back emergency, then high speed maneuverability and steep angle tests. Initial high speed ship control tests, steep angle tests and exercises at major casualties shall be conducted in water that does not exceed one and one-half times design test depth.
17. Run full power submerged for at least two hours. CO may schedule full power run for four hours if he deems it necessary. Submarine depth during the submerged full power run should be in accordance with reference (u), based on the EMBT blow from maximum authorized operating depth being previously accomplished.
18. At maximum safe speed, operate the rudder and planes through full throw in both directions in all remote modes of operation. Time evolutions and check against design values.
19. Perform resistance measurement checks on communication antennas in accordance with Volume IV, Chapter 22, paragraph 22.4 of this manual.
20. Electrical or fault localization testing of sonar sensors located above the waterline should be tested while the sonar sensor is submerged following the deep dive.

(This Page Intentionally Left Blank)

APPENDIX P
SUMMARY OF SIGNIFICANT POST REPAIR SEA TRIAL REQUIREMENTS
(SUBMARINES ONLY)

SEA TRIALS	TRANSIT TO	INITIAL TIGHTNESS DIVE	TRANSIT BETWEEN DIVES	DEEP DIVE	TRANSIT BACK
Policy Reference	Appendix O Paragraph 3.b.	Appendix O Paragraph 3.c.	Appendix O Paragraph 3.d.	Appendix O Paragraph 3.f.	Appendix O Paragraph 3.g.
Start Depth	Surface	Surface	Surface to 400 Ft	Surface to 400 Ft	Surface
Conduct Depth	Surface	Periscope depth or about 150 ft for SSN 688 Class (155 ft for SSN 774 Class), (160 ft SSN 21 and SSBN/SSGN 726 Class) if sea state dictates for trim. Remaining events of Appendix O, Paragraph 3.c. no deeper than 200 ft.	Surface to 400 Ft but not to exceed deepest depth previously escorted or valve cycling accomplished. Additional trials and testing permitted within the ISE, crew rest and other requirements of this instruction.	200 Ft increments to ½ max Op depth, then 100 ft increments to max Op depth in accordance with Appendix O, Paragraph 3.f.	½ Test depth plus 50 ft.
Maximum Keel Depth	Surface	200 Ft	400 Ft	Maximum Authorized Operating Depth.	½ Test depth plus 50 ft.
Finish Event	Rendezvous with escort.	Surface from 200 Ft with EMBT blow.*	Rendezvous with escort	Deep dive will be terminated with an EMBT blow from max authorized Op depth.	TYCOM issue URO authorization message.
Escort Required	No	Yes**	No	Yes	No
SRDRS Required	No***	Yes	No***	Yes	No
Water Depth	Surface	400 Ft in accordance with reference (u).	Unlimited.	Reference (u).	

- * - **May be delayed to permit additional testing, commencing pre-transit valve cycling or transit submerged. However, first surface after initial tightness dive must be by EMBT blow from 200 feet and must be conducted prior to deep dive.**
- ** - **An escort is required on the initial tightness dive and on subsequent first dives to any deeper depths, i.e., the first dive to any depth requires an escort. EMBT blow escort requirements given in paragraph 3.6.8.4.7 of this chapter.**
- *** - **SRDRS required during tightness dives. For ease of scheduling SRDRS modified alert time, SRDRS will be placed on modified alert from start of Sea Trial until completion of deep dive, including final EMBT blow from maximum operating depth, in accordance with paragraph 3.6.8.3.9.c or 3.6.8.4.7.b of this chapter.**

(This Page Intentionally Left Blank)

APPENDIX Q

**APPLICABLE RMC AVAILABILITY COMPLETION CERTIFICATION SHEET
(SURFACE FORCE SHIPS ONLY)**

CATEGORY/ITEM	REQUIREMENT	MILESTONE	SIGNATURE/DATE
PRIOR TO KEY EVENT/SEA TRIALS			
<p>I. Work Authorization</p>	<p>TYCOM will certify via letter/memo:</p> <p>a. All authorized CNO availability/CMAV work identified in the Availability Work Package (AWP) has been tasked to the Master Ship Repair Contractor, Naval Shipyard (NSY), Fleet Maintenance Activity (FMA), Alteration Installation Team (AIT), or Ship's Force for accomplishment.</p> <p>b. All deferred new/growth branded "A" (mandatory) has been concurred on by Technical Authority.</p> <p>c. All Temporary Standing Orders (TSO), Departures from Specifications (DFS) and CASREPs have been included in AWP or have Technical Authority approval, if deferred.</p>	<p>Prior to Sea Trials</p>	<p>Business Agent/ Project Manager/date _____/_____ TYCOM memorandum/Ser #/date _____/____/_____</p>
<p>II. Work Documents Issued/Prime Contractor</p>	<p>a. The Project Support Engineer and QAS shall validate that Work Specifications and Test Procedures issued by the prime contractor have received a government technical review in accordance with Availability Quality Management Plan (QMP) and Local Attribute Checklist.</p>	<p>a. Prior to Key Event/Sea Trials</p>	<p>a.. Project Support Engineer/date _____/_____ Code 130 QAS/date _____/_____</p>

II-13Q-1

COMUSFLTFORCOMINST 4790.3 REV C CH-2

CATEGORY/ITEM	REQUIREMENT	MILESTONE	SIGNATURE/DATE
PRIOR TO KEY EVENT/SEA TRIALS			
<p>II. Work Documents Issued/Prime Contractor (Cont'd)</p>	<p>b. Project Manager shall validate that all work specifications and test procedures issued by the prime contractor have received a government review in accordance with Volume VII, Chapter 4, Appendix E of this manual.</p> <p>c. Project Manager will verify that all required CFRs have been received as required by NAVSEA Standard Item 009-01 paragraph 3.2.</p> <p>d. Project Support Engineer will verify that all C 200 CFRs have been reviewed and answered. Deferred maintenance action and/or test result CFRs have been technically adjudicated. All CFRs screened to C 200 for action shall be documented via Engineering Service Request (ESR).</p>	<p>b. Prior to Key Event/Sea Trials</p> <p>c. Prior to Key Event/Sea Trials</p> <p>d. Prior to Key Event/Sea Trials</p>	<p>b. Project Manager/date _____ / _____</p> <p>c. Project Manager/ date _____ / _____</p> <p>d. Project Support Engineer/ date _____ / _____</p>
<p>III. Work Completion/Prime Contractor</p>	<p>Verify that all prime contractor work (including sub-contractors) has been certified as complete by prime contractor (include letter/memo Ser/date). All Sea Trials testing is included on Sea Trials Agenda. Verify that any incomplete work (exception items) have been provided to RMC/NSA CHENG for technical concurrence to not impact key Event/Sea Trials.</p>	<p>Prior to Key Event/Sea Trials</p>	<p>Project Manager/date _____ / _____</p> <p>Prime Contractor Memorandum/Ser _____ / _____</p>

CATEGORY/ITEM	REQUIREMENT	MILESTONE	SIGNATURE/DATE
PRIOR TO KEY EVENT/SEA TRIALS (Cont'd)			
IV. Work Completion/FMA	Verify that all FMA FWP/CWPs have been certified as complete and technically correct by FMA (include letter/memo Ser/date). All Sea Trials testing is included on Sea Trials Agenda. Verify that any incomplete work (exception items) have been provided to RMC/NSA CHENG for technical concurrence to not impact Key Event/Sea Trials.	Prior to Key Event/Sea Trials	Project Manager/date _____/_____ FMA Memorandum/Ser _____/_____
V. Work Completion/NSY	Verify that all NSY work has been certified as complete and technically correct by NSY(include letter/memo Ser/date). All Sea Trials testing is included on Sea Trials Agenda. Verify that any incomplete work (exception items) have been provided to RMC/NSA CHENG for technical concurrence to not impact Key Event/Sea Trials.	Prior to Key Event/Sea Trials	Project Manager/date _____/_____ NSY Memorandum/Ser _____/_____
VI. Work Completion/AIT	Verify that all AIT work and test procedures have been certified as technically correct and complete by each AIT On-Site Installation Coordinator (include each letter/memo Ser/date). All Sea Trials testing is included on Sea Trials Agenda. Verify that any incomplete	Prior to Key Event/Sea Trials	Project Manager or AIT Coordinator/date _____/_____ AIT On-Site Installation Coordinator Memorandum/Ser. _____/_____

CATEGORY/ITEM	REQUIREMENT	MILESTONE	SIGNATURE/DATE
PRIOR TO KEY EVENT/SEA TRIALS (Cont'd)			
VI. Work Completion/AIT (Cont'd)	work (exception items) have been provided to RMC/NSA CHENG for technical concurrence to not impact Key Event/Sea Trials	Prior to Key Event/Sea Trials (Cont'd)	
VII. Work Completion/SF	Verify that all SF FWP/CWPs have been certified as technically correct and complete by Ship's CO (include letter/memo Ser/date). All Sea Trials testing is included on Sea Trials Agenda. Verify that any incomplete work (exception items) have been provided to RMC/NSA CHENG for technical concurrence to not impact Key Event/Sea Trials.	Prior to Key Event/Sea Trials	Project Manager/date _____/_____ SF Memorandum/Ser _____/_____
VIII. Work Completion/RMC Engineering	Certify that all assigned assessments (TSRA) or Fleet Tech Assists (FTA) tied to Key Event or Fast Cruise/Sea Trial are completed. For ongoing TSRA assessments or FTA, the RMC/NSA CHENG will certify that these assessments/FTA do not impact the Key Event or Fast Cruise/Sea Trial.	Prior to Key Event/Sea Trials	RMC/NSA CHENG/date _____/_____

CATEGORY/ITEM	REQUIREMENT	MILESTONE	SIGNATURE/DATE
PRIOR TO KEY EVENT/SEA TRIALS (Cont'd)			
X. Waivers and Deviations (Cont'd)	Service Requests/LARs/RLARs have been answered and incorporated. The NSA CHENG will also certify that all conditionally approved technical non-conformances that expire during the availability have been resolved.		
XI. Quality Assurance	Certify that all QA Office actions are satisfactory regarding resolution of QA Audits and Surveillances necessary to support Key Event/Sea Trials. All contractor Corrective Action Requests (CAR - Method B-D) issued during the availability are either closed or at an acceptable level of completion to support work certification. Include a memo describing outstanding items, remaining actions and Estimated Completion Dates, if applicable.	Prior to Key Event/Sea Trials	Quality Assurance Manager/date _____/_____ C130 Memorandum/Ser _____/_____

(This Page Intentionally Left Blank)

APPENDIX R

AVAILABILITY QUALITY MANAGEMENT PLAN (QMP) (SURFACE FORCE SHIPS ONLY)

1. NSA Certification Requirements. Naval Supervisory Authority (NSA) certification of readiness for major Key Events, Fast Cruise/Sea Trials and availability completion is required. NSA certification of readiness for events must include a basis for certification. For surface force ship availabilities, this basis includes:
 - a. Approved QMS. The Executing Activity performing the work has a NAVSEA approved QMS. The QMS is audited periodically and includes ongoing in-process surveillance and follow-up to assure that recurring, systemic problem areas are identified and corrective action is taken. The QMS is further defined in NAVSEA Standard Item 009-04, Quality Management System.
 - b. Mandatory Oversight. The NSA or Government activity performing the oversight of contract execution provides mandatory oversight to include “G” point observation and mandatory review of test data when required by the contract for critical work as required by Volume VII, Chapter 11, Section 11.5 of this manual and other higher level documentation.
 - c. Non-Mandatory Oversight. The NSA or Government activity performing oversight of contract execution must also perform adequate oversight of contract work not identified as mandatory. Although not specified, frequency or degree of oversight is often described as “random.” There should be a systematic approach taken to defining where government oversight should be applied in order to provide the NSA with the maximum reasonable level of assurance that work is planned, executed and tested correctly.
2. QMP Requirement. The Availability Quality Management Plan (QMP) provides a risk-based methodology for the NSA to utilize and provide this maximum reasonable level of assurance in work planning, execution and testing without requiring 100 percent oversight or review of contractor work products. An Availability QMP is required by Volume VII, Chapter 11 of this manual (Contract Administration Quality Assurance Program).
3. QMP Methodology. The Availability QMP then is a product of review(s) conducted on the Availability Work Package (AWP) that evaluates each work item based on probability of failure and criticality of failure. The evaluation of the work items for these two attributes, discussed below, should result in a plan which dictates which work items will have increased levels of Procedure Evaluations (PE)/Process Quality Audits (PQA) and Product Verification Inspections (PVI) by Engineering, QA and Waterfront Operations Departments. In addition, the Availability QMP should determine which work items will receive Quality Audits by QA Department.
 - a. Probability of Failure. Contractor’s past performance history in different work areas, as captured in Code 130 Quality Data Evaluation, is utilized to evaluate work items that will require additional oversight based on contractor’s past performance. If a contractor does not have any previous experience in a work area, probability of failure should be evaluated as high, unless there is work experience in a related area sufficient to build confidence in expectation of good contractor performance.
 - b. Criticality of Failure. A consistent approach needs to be utilized by the NSA when developing Availability QMPs to identify work items which have higher criticality of failure. Simply put, equipment/systems that, by their failure alone, will result in the inability of the ship to get underway or meet primary mission requirements, (C4 CASREP) would equate to highest criticality of failure impact. Those systems/equipment that, by their failure alone, would result in a major degradation to ship’s ability to meet mission requirements, (C3 CASREP) would have next highest criticality of failure consideration. Systems/equipment that, by their failure alone, would result in minor degradation to ship’s ability to meet mission requirements, (C2 CASREP) would have the lowest criticality of failure

consideration. There is no single source of input to determine criticality of failure. CNSP/CNSLINST 3504.1 identified “Redlines” requirements for surface force ships and should be utilized when identifying criticality of failure of systems/equipment being worked in the availability. Additional discussion on these requirements is provided below:

- (1) Redlines Systems. CNSP/CNSLINST 3504.1 includes matrices which identify minimum equipment lists by ship class. The NSA should utilize the redlines instruction as a guideline for determining “criticality of failure” when evaluating work items that may require additional oversight. Consideration should be given to redundancy, for example: On a DDG, relative level of oversight on a boat davit (1 of 1 required) would likely dictate more oversight than work on an air conditioning plant (2 of 5 required). For all redlines systems/equipment, contractor past performance discussed in paragraph 3.a. above should be considered.
- (2) Non-Redlines Systems. Systems/equipment that is not addressed by CNSP/CNSLINST 3504.1 normally require less oversight. An exception would be if there is a record of poor past performance such as poor performance on critical coating systems application in tanks/voids. While Volume VII, Chapter 11 of this manual requires increased RMC inspection requirements for these systems, additional PE, PR, PVI or QA audit may also be required by the RMC due to a contractor’s past performance.
- (3) QMP Applicability to FMA (I-Level), Ship’s Force (SF), Naval Shipyards (NSY) and Alteration Installation Teams (AIT). While the QA Plan described herein generally refers to work contracted through the RMC, the NSA availability certification includes all work accomplished in the availability to include I-Level (FMA), SF, NSY and AIT. Each of these executing activities is also required to maintain an approved QMS. The NSA may not have direct oversight responsibility for these executing activities or provide auditing of their QMS. Oversight for NSY, FMA and SF work is provided organic to those organizations and does not normally require additional oversight by the NSA. The AWP review conducted concurrent with development of the QMP should, however, include a determination of high risk jobs being conducted that may require additional NSA oversight. This oversight, if required, should be part of the Availability QMP. For AIT work, NAVSEA Technical Specification 9090-310 requires that AIT contractors maintain a QMS approved by NAVSEA 04XQ and audited by respective government sponsor. NAVSEA Technical Specification 9090-310 also requires that respective AIT government sponsors provide on-site oversight of AIT contractors, including specification review and approval, G point checks, and in-process surveillance of work. The NSA should include AIT work in the QMP development and make a determination on what additional oversight may be required to include in the QMP for AIT work.

APPENDIX AA

**SAMPLE SHIP'S REQUEST FOR PERMISSION TO COMMENCE FAST CRUISE
(SURFACE FORCE SHIPS AND AIRCRAFT CARRIERS)**

FM USS (SHIP NAME)//
TO(APPLICABLE TYCOM)//
INFO CNO WASHINGTON DC//
SUPERVISING AUTHORITY//
COMNAVSEASYS COM WASHINGTON DC//
COMCARGRU (GROUP NO.)//
PEO CARRIERS (AS APPLICABLE FOR CARRIERS)//
PEO THEATER SURFACE COMBATANTS//PMS400F// (AS APPLICABLE FOR COMBATANTS)//
PEO EXW (AS APPLICABLE FOR AUXILIARIES, LITTORALS AND PATROL CRAFT)//
PEO MUW (AS APPLICABLE FOR MINE WARFARE)//
OTHER UNITS (IF APPLICABLE)//
BT
UNCLAS//N09080//
MSGID/GENADMIN/(ORIG)//
SUBJ/(SHIP NAME AND HULL NO.) FAST CRUISE//
REF/A//
AMPN/REF A IS //
RMKS/1. ALL FORCES AFLOAT WORK ITEMS AND TRAINING NECESSARY FOR SEA TRIALS
INCLUDING THOSE DEFICIENCIES LIST REF A HAVE BEEN SATISFACTORILY COMPLETED.
2. USS _____ READY FOR SEA WITH EXCEPTION OF REMOVING SHORE SERVICES. ALL
REQUIRED STORES AND SPARE PARTS ON BOARD.
TECHNICAL DOCUMENTATION ON BOARD.
A.
B.
C.
D.
3. REQUEST PERMISSION TO COMMENCE FAST CRUISE//
BT

**NOTE: ENSURE MESSAGES ARE IN ACCORDANCE WITH CURRENT MESSAGE FORMAT AND
CURRENT PLAD IS UTILIZED.**

(This Page Intentionally Left Blank)

APPENDIX AB

SAMPLE SHIP'S REPORT OF FAST CRUISE COMPLETION

(SURFACE FORCE SHIPS AND AIRCRAFT CARRIERS)

FM USS (SHIP NAME)//
TO (APPLICABLE TYCOM)//
INFO CNO WASHINGTON DC//
COMNAVSEASYS COM WASHINGTON DC//
SUPERVISING AUTHORITY//
(APPLICABLE FLEET COMMANDER)//
COMCARGRU (GROUP NO.)//
PEO CARRIERS (AS APPLICABLE FOR CARRIERS)//
PEO THEATER SURFACE COMBATANTS (AS APPLICABLE FOR COMBATANTS)//
PEO EXW (AS APPLICABLE FOR AUXILIARIES, LITTORALS AND PATROL CRAFT)//
PEO MUW (AS APPLICABLE FOR MINE WARFARE)//
BT
UNCLAS //N09080//
MSGID/GENADMIN/(orig)//
SUBJ/(SHIP NAME AND HULL NO.) FAST CRUISE//
REF/A/RMG/(orig)/(dtg)//
REF/B/DOC/COMUSFLTFORCOM/(DATE)//
NARR/REF A IS TYCOM MSG AUTHORIZING COMMENCEMENT OF FAST CRUISE. REF B IS
COMUSFLTFORCOMINST 4790.3, JOINT FLEET MAINTENANCE MANUAL, VOL II//
RMKS/1. FAST CRUISE AUTHORIZED BY REF A COMPLETED AT (DATE/TIME). NO MAJOR
DEFICIENCIES NOTED IN CREW OR EQUIPMENT. REQUEST PERMISSION TO COMMENCE SEA
TRIAL IN ACCORDANCE WITH REF B AT (DATE/TIME).//
BT

**NOTE: ENSURE MESSAGES ARE IN ACCORDANCE WITH CURRENT MESSAGE FORMAT AND
CURRENT PLAD IS UTILIZED.**

(This Page Intentionally Left Blank)

APPENDIX AC

**SAMPLE SUPERVISING AUTHORITY READINESS FOR SEA TRIAL MESSAGE
(SURFACE FORCE SHIPS AND AIRCRAFT CARRIERS)**

FM (SUPERVISING AUTHORITY)//
TO USS (SHIP'S NAME)//
INFO CNO WASHINGTON DC//
COMNAVSEASYS COM WASHINGTON DC//
(APPLICABLE FLEET COMMANDER)//
(APPLICABLE TYCOM)//
(ISIC)//
PEO CARRIERS (AS APPLICABLE FOR CARRIERS)//
PEO THEATER SURFACE COMBATANTS (AS APPLICABLE FOR COMBATANTS)//
PEO EXW (AS APPLICABLE FOR AUXILIARIES, LITTORALS AND PATROL CRAFT)//
PEO MUW (AS APPLICABLE FOR MINE WARFARE)//
BT
UNCLAS //N09080//
MSGID/GENADMIN/(SUPERVISING AUTHORITY NAME)//
SUBJ/USS (SHIP NAME AND HULL NO.) READINESS FOR SEA TRIALS//
REF/A/DOC/COMUSFLTFORCOM (DATE)//
AMPN/REF A IS COMUSFLTFORCOMINST 4790.3, JOINT FLEET MAINTENANCE MANUAL, VOLUME II//
RMKS/1. IAW REF A (SUPERVISING AUTHORITY) REPORTS THAT ALL WORK NECESSARY FOR SEA TRIALS, HAVE BEEN SATISFACTORILY COMPLETED.
2. SEA TRIALS TO COMMENCE AT (TIME AND DATE) CONTINGENT UPON (APPLICABLE TYCOM) APPROVAL//
BT

NOTE: ENSURE MESSAGES ARE IN ACCORDANCE WITH CURRENT MESSAGE FORMAT AND CURRENT PLAD IS UTILIZED.

(This Page Intentionally Left Blank)

APPENDIX AD
SAMPLE PRIME CONTRACTOR AVAILABILITY KEY EVENT READINESS CERTIFICATION
MEMORANDUM
(SURFACE FORCE SHIPS ONLY)

XXXX
Ser ____
DD MMM YY

MEMORANDUM

From: Project Manager, _____ Regional Maintenance Center

To: Chief Engineer, _____ Regional Maintenance Center

Subj: PRIME CONTRACTOR READINESS FOR UNDOCKING CERTIFICATION FOR USS PILOT SHIP
(XXX XX)

Ref: (a) COMUSFLTFORCOMINST 4790.3 Joint Fleet Maintenance Manual (JFMM)

Encl: (1) Prime Contractor Undocking Exception List, USS Pilot Ship (XXX XX) DSRA

1. In accordance with reference (a), this memorandum is to certify that all Prime Contractor contracted work for subject DSRA is complete in support of Undocking and unless listed as an exception, none of the remaining Prime Contractor contracted work meets the following definition of "Dry Dock Critical":

Dry Dock Critical Items:

- a. All work/work items that require the ship to be in dry dock in order to perform the work.
- b. Work could be performed after undocking but would require additional costs, create an impact to schedule, or require the need for additional equipment and specialized personnel to perform the task that is not already covered by the original basic work package.
- c. This includes associated checkpoints, required OQE, and equipment testing required by the work/work item.

2. Exceptions listed in the attached enclosure were not completely accomplished and have been technically adjudicated in support of Undocking.

F M LAST

Project Manager

COPY TO:

RMC Integrated Test Coordinator, Code XXX

Commanding Officer, USS Pilot Ship (XXX XX)

Commander, Navy Regional Maintenance Center

Enclosure (1)

PRIME CONTRACTOR UNDOCKING EXCEPTION LIST, USS PILOT SHIP (XXX XX) DSRA

Work Item Number	Equipment	Remarks

APPENDIX AE

**SAMPLE FLEET MAINTENANCE ACTIVITY AVAILABILITY KEY EVENT READINESS
CERTIFICATION MEMORANDUM**

(SURFACE FORCE SHIPS ONLY)

XXXX

Ser ____

DD MMM YY

MEMORANDUM

From: Project Manager, _____ Regional Maintenance Center

To: Chief Engineer, _____ Regional Maintenance Center

Subj: FLEET MAINTENANCE ACTIVITY READINESS FOR DOCK TRIALS CERTIFICATION FOR USS PILOT SHIP (XXX XX)

Ref: (a) COMUSFLTFORCOMINST 4790.3 Joint Fleet Maintenance Manual (JFMM)

Encl: (1) Fleet Maintenance Activity Dock Trials Exception List, USS Pilot Ship (XXX XX) PMA

1. In accordance with reference (a), this memorandum is to certify that all major propulsion plant work and cold plant testing assigned to XXRMC for subject PMA is complete and supports Propulsion Plant Operation and unless listed as an exception, none of the remaining FMA work will interfere with propulsion plant operation.

2. Exceptions listed in the attached enclosure were not completely accomplished and are subject to agreement upon by the Ship's Commanding Officer (CO), appropriate technical authority, and the XXRMC before proceeding with scheduled Propulsion Plant Operations.

F M LAST

Project Manager

COPY TO:

RMC Integrated Test Coordinator, Code XXX

Commanding Officer, USS Pilot Ship (XXX XX)

Commander, Navy Regional Maintenance Center

Enclosure (1)

FLEET MAINTENANCE ACTIVITY DOCK TRIALS EXCEPTION LIST, USS PILOT SHIP (XXX XX) PMA

Work Item Number	Equipment	Remarks

APPENDIX AF
SAMPLE NAVAL SHIPYARD AVAILABILITY KEY EVENT READINESS CERTIFICATION
MEMORANDUM
(SURFACE FORCE SHIPS ONLY)

XXXX
Ser ____
DD MMM YY

MEMORANDUM

From: Project Manager, _____ Regional Maintenance Center
To: Chief Engineer, _____ Regional Maintenance Center
Subj: NAVAL SHIPYARD READINESS FOR FAST CRUISE CERTIFICATION FOR USS PILOT SHIP
(XXX XX)
Ref: (a) COMUSFLTFORCOMINST 4790.3 Joint Fleet Maintenance Manual (JFMM)
Encl: (1) Naval Shipyard Fast Cruise Exception List, USS Pilot Ship (XXX XX) DSRA

1. In accordance with reference (a), this memorandum is to certify that all major propulsion plant work and cold plant testing assigned to the Naval Shipyard (NSY) for subject DSRA is complete and supports Propulsion Plant Operation and unless listed as an exception, none of the remaining NSY work will interfere with propulsion plant operation.
2. Exceptions listed in the attached enclosure were not completely accomplished and are subject to agreement upon by the Ship's Commanding Officer (CO), appropriate technical authority, and the XXRMC before proceeding with scheduled Propulsion Plant Operations.

F M LAST
Project Manager

COPY TO:
RMC Integrated Test Coordinator, Code XXX
Commanding Officer, USS Pilot Ship (XXX XX)
Commander, Navy Regional Maintenance Center

Enclosure (1)

NAVAL SHIPYARD FAST CRUISE EXCEPTION LIST, USS PILOT SHIP (XXX XX) DSRA

Work Item Number	Equipment	Remarks

APPENDIX AG
SAMPLE ALTERATION INSTALLATION TEAM AVAILABILITY KEY EVENT READINESS
CERTIFICATION MEMORANDUM
(SURFACE FORCE SHIPS ONLY)

XXXX

Ser ____

DD MMM YY

MEMORANDUM

From: AIT Government Sponsor

To: Chief Engineer, _____ Regional Maintenance Center

Subj: ALTERATION INSTALLATION TEAM READINESS FOR PRODUCTION COMPLETION DATE
CERTIFICATION FOR USS PILOT SHIP (XXX XX)

Ref: (a) COMUSFLTFORCOMINST 4790.3 Joint Fleet Maintenance Manual (JFMM)

Encl: (1) Alteration Installation Team Production Completion Date Exception List, USS Pilot Ship (XXX XX)
DSRA

1. In accordance with reference (a), this memorandum is to certify that all work and testing assigned to the Alteration Installation Team and installed during the subject DSRA are complete and supports Production Completion Date (PCD) and unless listed as an exception, none of the remaining work will interfere with PCD.
2. Alterations installed:
3. Exceptions listed in the attached enclosure were not completely accomplished and are subject to agreement upon by the Ship's Commanding Officer (CO), appropriate technical authority, and the XXRMC before proceeding with scheduled Propulsion Plant Operations.

F M LAST

AIT Government Sponsor

COPY TO:

RMC Integrated Test Coordinator, Code XXX

Commanding Officer USS Pilot Ship XXX XX

Commander, Navy Regional Maintenance Center

Enclosure (1)

ALTERATION INSTALLATION TEAM PRODUCTION COMPLETION DATE EXCEPTION LIST, USS
PILOT SHIP (XXX XX) DSRA

Work Item Number	Equipment	Remarks

APPENDIX AH
SAMPLE SHIP'S FORCE AVAILABILITY KEY EVENT READINESS CERTIFICATION
MEMORANDUM
(SURFACE FORCE SHIPS ONLY)

XXXX

Ser ____

DD MMM YY

MEMORANDUM

From: Commanding Officer USS _____

To: Chief Engineer, _____ Regional Maintenance Center

Subj: USS PILOT SHIP (XXX XX) READINESS FOR SEA TRIALS CERTIFICATION

Ref: (a) COMUSFLTFORCOMINST 4790.3 Joint Fleet Maintenance Manual (JFMM)

Encl: (1) Ship's Force Sea Trials Exception List, USS Pilot Ship (XXX XX) DSRA

1. In accordance with reference (a), this memorandum is to certify that all major propulsion plant work and cold plant testing conducted by Ship's Force during subject DSRA is complete and supports Propulsion Plant Operation and unless listed as an exception, none of the remaining Ship's Force work will interfere with propulsion plant operation. A review of the Ship's Current Ship's Maintenance Project (CSMP), WAF Log, and Tagout Log has been conducted and there are no outstanding work items that would impact Propulsion Plant Operation.

2. Exceptions listed in the attached enclosure were not completely accomplished and are subject to agreement upon by the Ship's Commanding Officer (CO), appropriate technical authority, and the XXRMC before proceeding with scheduled Propulsion Plant Operations.

F M LAST

Project Manager

COPY TO:

RMC Integrated Test Coordinator, Code XXX

Commanding Officer USS Pilot Ship XXX XX

Commander, Navy Regional Maintenance Center

Enclosure (1)

SHIP'S FORCE SEA TRIAL EXCEPTION LIST, USS PILOT SHIP (XXX XX) DSRA

Work Item Number	Equipment	Remarks

APPENDIX AI
SAMPLE QUALITY ASSURANCE AVAILABILITY KEY EVENT READINESS CERTIFICATION
MEMORANDUM
(SURFACE FORCE SHIPS ONLY)

XXXX
Ser ____
DD MMM YY

MEMORANDUM

From: Project Manager, _____ Regional Maintenance Center

To: Chief Engineer, _____ Regional Maintenance Center

Subj: QUALITY ASSURANCE READINESS FOR SEA TRIALS CERTIFICATION FOR USS PILOT SHIP
(XXX XX)

Ref: (a) COMUSFLTFORCOMINST 4790.3 Joint Fleet Maintenance Manual (JFMM)

Encl: (1) Quality Assurance Sea Trials Exception List, USS Pilot Ship (XXX XX) DSRA

1. In accordance with reference (a), this memorandum is to certify that all Quality Assurance (QA) office actions for subject availability are satisfactory regarding resolution of QA audits and surveillances necessary to support Sea Trials.

2. Exceptions listed in the attached enclosure were not completely accomplished and are subject to agreement upon by the Ship's Commanding Officer (CO), appropriate technical authority, and the XXRMC before proceeding with scheduled Propulsion Plant Operations.

F M LAST
Quality Assurance Manager

COPY TO:

RMC Integrated Test Coordinator, Code XXX

Commanding Officer, USS Pilot Ship (XXX XX)

Commander, Navy Regional Maintenance Center

Enclosure (1)

QUALITY ASSURANCE SEA TRIALS EXCEPTION LIST, USS PILOT SHIP (XXX XX) DSRA

Work Item Number	Equipment	Remarks

APPENDIX AJ

**SAMPLE FINAL AVAILABILITY KEY EVENT READINESS CERTIFICATION MEMORANDUM
(SURFACE FORCE SHIPS ONLY)**

XXXX

Ser ____

DD MMM YY

MEMORANDUM

From: Chief Engineer, _____ Regional Maintenance Center

To: Commanding Officer, _____ Regional Maintenance Center

Subj: FINAL READINESS FOR UNDOCKING CERTIFICATION FOR USS PILOT SHIP (XXX XX)

Ref: (a) COMUSFLTFORCOMINST 4790.3 Joint Fleet Maintenance Manual (JFMM)

(b) Prime Contractor readiness for Undocking Certification Memorandum / Ser XXX

(c) Fleet Maintenance Activity readiness for Undocking Certification Memorandum / Ser XXX

(d) Naval Shipyard readiness for Undocking Certification Memorandum / Ser XXX

(e) Alteration Installation Team readiness for Undocking Certification Memorandum / Ser XXX

(f) USS Pilot Ship (XXX XX) readiness for Undocking Certification Memorandum / Ser XXX

(g) XXRMC Code 130 Quality Assurance readiness for Undocking Certification Memorandum / Ser XXX

1. In accordance with references (a) through (g), this memorandum acknowledges that all executing activities have certified completion of all work and testing required to support readiness for Undocking.

2. Exception items provided in references (b) through (g) have been reviewed and do not impact readiness for Undocking.

AA FIRST

Commanding Officer, USS Pilot Ship (XXX XX)

BB NEXT

Project Manager, ____ Regional Maintenance Center

CC MIDDLE

Port Engineer/TYCOM

DD LAST

NSA CHENG

COPY TO:

Commanding Officer, USS Pilot Ship (XXX XX)

Project Manager, ____ Ashore Ships Maintenance
Manager/TYCOM

NSA CHENG

RMC Integrated Test Coordinator, Code XXX

Commander, Navy Regional Maintenance Center

(This Page Intentionally Left Blank)

APPENDIX AK
BRANDING CATEGORY (CAT) A CHANGE DEFERRAL PROCESS
(SURFACE FORCE SHIPS ONLY)

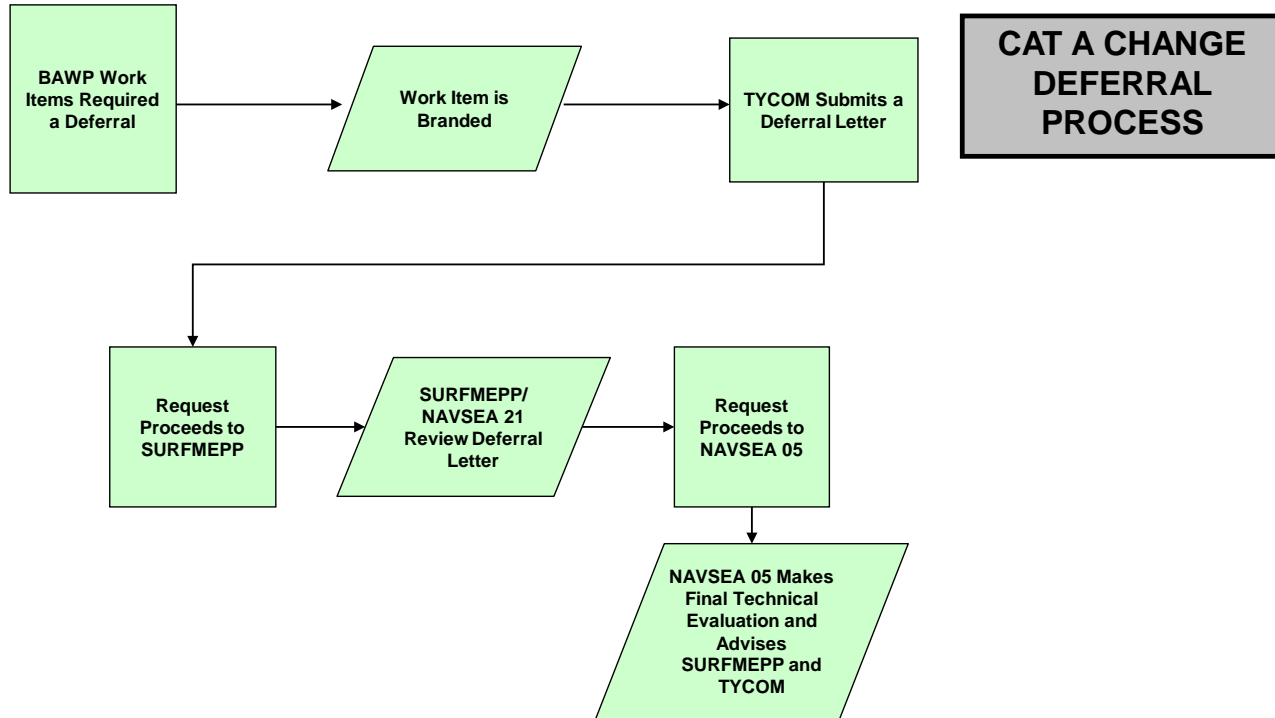

II-I-3AK-1

(This Page Intentionally Left Blank)

APPENDIX AL
BAWP CHANGE DEFERRAL REQUEST (SAMPLE)

4700
 XX/XXXX
 DD MMM YY

From: Commander, U.S. Atlantic/Pacific Fleet

To: Commanding Officer, Surface Maintenance Engineering Planning Program

Subj: USS SHIP (HULL NUMBER) FYXX-FYXX FLEET READINESS
 PLAN MAINTENANCE CYCLE BASELINE/AVAILABILITY WORK
 PACKAGE CHANGE DEFERRAL REQUEST/NOTIFICATION

Ref: (a) COMUSFLTFORCOMINST 4790.3 (SERIES), Joint Fleet Maintenance Manual (JFMM)
 (b) USS SHIP (HULL NUMBER) FYXX-FYXX Baseline Availability Work Package (BAWP)

Encl: (1) USS SHIP (HULL NUMBER) FYXX-FYXX BAWP Change Request Sheet
 (2) List of Previously Deferred CMP Requirements

1. USS SHIP (HULL NUMBER) FYXX XXX/SRA is scheduled to commence DD MMM YYYY. This letter confirms completion of **“Submit Deferral Letter”** in reference (a).

2. Enclosure (1) lists BAWP maintenance requirements recommended for non-accomplishment which require technical adjudication. Request adjudication of branding category “A” items identified in enclosure (1).

3. Operational Risk Summary: USS SHIP (HULL NUMBER) is/is not at risk of attaining a clear path to light-off at LOA. Additionally, the ship will/will not be materially ready to begin Unit-Level Training in one or more mission areas.

4. In accordance with reference (a), the list below contains the remaining planning milestones and dates (tasks are based on the “CNO PSIA Entitled Process”):

TASK	DATE
PSIA CONTRACTOR COMPLETE PLANNING & ESTIMATING OF WORK ASSIGNED BY A-240	DDMMYY
80% D-LEVEL WORK PACKAGE LOCKED BASED ON \$	DDMMYY
PSIA CONTRACTOR COMPLETE PLANNING & ESTIMATING OF WORK ASSIGNED BY A-120 DATE	DDMMYY
100% D-LEVEL WORK PACKAGE LOCKED BASED ON \$	DDMMYY
100% D-LEVEL WORK PACKAGE PLANNED/ESTIMATED	DDMMYY

5. A list of CMP and repair items already approved for deferral is included in enclosure (2).

6. Point of Contact: NAME, COMMAND, PHONE NUMBER.

X.X.XXXXXXXXXX
 RANK, USN

Copy to:

NAVSEA 05D

COMNAVSURFLANT/COMNAVSURFPAC (N43)

RMC

USS SHIP (HULL NUMBER)

USS SHIP NAME (HULL NUMBER)			
List of Previously Deferred CMP Items			
JCN	Task Description	Date Authorized	Method Authorized
EX01 ZA00	G1N6 Assessment of Store Room	15 Nov 2009	CMP Electronic Notification System
EM01 ZA55	G1E8 Assessment of GTM 2A	10 Dec 2009	SDM/SURFMEPP E-Mail

APPENDIX AM
AVAILABILITY PLANNING CONFERENCE AGENDA SAMPLE
(SURFACE FORCE SHIPS ONLY)

1. Introduction of Attendees. (Chair)
 - a. TYCOM Type Desk. (TDO/Availability Work Package Manager (AWPM)/PE) (Chair)
 - b. Ship's Force.
 - c. Maintenance Team.
 - d. SURFMEPP.
 - e. TSRA.
 - f. Program Office Management Representative.
 - g. Planning Yard Representative.
 - h. Space and Naval Warfare Systems Command (SPAWAR) Representative.
 - i. Government Planners.
 - j. PSIA Contractor Representatives.
2. Meeting Overview - Agenda Topics. (Chair)
3. Availability Overview. (Chair)
 - a. Type.
 - b. Location.
 - c. Start Date/End Date/Duration.
 - d. Notional Mandays/Dollars/AP Dollars.
 - e. Expected Control Mandays/Dollars/AP Dollars.
4. Availability Budget. (TYCOM Type Desk)
 - a. Expected Control Breakdown.
 - (1) Fees.
 - (2) Reservations.
 - (3) Farm-Out.
 - b. Cost of work screened to date.
 - c. Budget Assessment.
5. Review ship's schedule. (Chair)
 - a. Home port.
 - b. Deployments and Underway periods.
 - c. Scheduled Availabilities. (CMAV and TSRA)
 - d. Inspections and Assessment Visits.
 - e. Alteration Installation Teams.
 - f. Special evolutions that affect ship access.
6. Review remaining advance planning milestones highlighting key dates and deadlines. (TYCOM (AWPM/PE))

7. Brief BAWP contents including status of all mandatory repair and assessment tasks due during the cycle, showing those completed, scheduled and overdue. (SURFMEPP)
8. SURFMEPP Turnover BAWP to TYCOM. (SURFMEPP)
9. Brief CSMP showing the screening of all off-ship jobs. Highlight potential technical issues, including Departures from Specifications (DFS) and other jobs that may later be deemed mandatory. Discuss any other concerns. (TYCOM (PE))
10. Brief status of all mandatory repair and assessment tasks due during the cycle, showing remaining tasks scheduled and overdue and discuss concerns. (SURFMEPP)
11. Brief status of all mandatory CMP task Change Deferral Requests, showing those approved, approval pending and disapproved. (SURFMEPP)
12. Assess impact of disapproved CMP task Change Deferral Requests. (TYCOM (PE))
13. Brief schedule of remaining TSRA availabilities and mitigation strategy to accomplish those mandatory CMP assessments that were not executed as scheduled. (TSRA)
14. Assess impact of remaining inspections and assessments. (TYCOM (PE))
15. Brief Program/Fleet Alteration changes since last briefed. (TYCOM (AWPM) (SEA21 briefs Program Alterations changes, if present, else AWPM briefs both))
16. Assess impact of modernization changes on other work. (TYCOM (AWPM)/TYCOM (PE)/Planner)
17. Assess impact of AWP on habitability. (TYCOM (PE))
18. Review and assess Ship's Force planned work that may impact other work. (TYCOM (PE))
19. Review and assess Ship's Force deferred work that may need to be included in the AWP. (TYCOM (PE))
20. New Issues.
21. Ship Commanding Officer Concerns.
22. Action Required after the Meeting:
 - a. TYCOM (AWPM) distributes meeting minutes with action items.
 - b. TYCOM Type Desk briefs chain of command of the Commanding Officer Concerns.
 - c. SURFMEPP negotiates the uploading of all new CMP tasks identified after this point with the TYCOM. (AWPM/PE)

APPENDIX AN
BAWP WORK ITEM BRANDING CATEGORIES
(SURFACE FORCE SHIPS ONLY)

Mandatory (Technical): Requires an approved Change Request prior to non-accomplishment. Only SURFMEPP is authorized to brand items in this category. BAWP work items in this branding category include maintenance actions, which have high-level technical requirements and/or are NAVSEA-mandated. Resolution is managed by the applicable Technical Warrant Holder.		
Type Sequence Number	Brand Code	
811	A1	Mandatory maintenance by direction of higher authority.
816	A6	Reprogrammed BAWP items from previous maintenance cycles.
831	AD	Mandatory items deferred at least two FRP cycles.
833	AH	Mandatory maintenance approved for deferral in the current maintenance cycle.
832	AR	Repair task that must be accomplished within the current FRP Maintenance Cycle.
	AS	Mandatory Safety-Related Modernization.
Required (Non-Technical): Requires TYCOM approval and subsequent notification to SURFMEPP prior to non-accomplishment.		
	B2	MTA/MILR and legacy as failed alterations.
843	B3	All other modernization not included as categories B1 or B2. (Note: "B1" N/A to Surface Ships)
846	B6	Availability Services. (Temp/Routine)
847	B7	Repair work related to an active CASREP or DFS.
849	B9	Non-Mandatory Technical Requirement/Non-Service/Routine CMP task.

(This Page Intentionally Left Blank)

APPENDIX AO
BAWP TO AWP PROCESS
(SURFACE FORCE SHIPS ONLY)

NOTE: SURFMEPP WILL HOST FOUR (4) SCHEDULED MEETINGS OVER THE COURSE OF THE SHIP'S FRP MAINTENANCE CYCLE: THE CORROSION PLANNING CONFERENCE (C+115), THE LCPC (C+140), THE MID-CYCLE REVIEW AND THE BAWP CLOSE-OUT VERIFICATION AND ASSESSMENT MEETING (C+70). DUE TO A COMPRESSED FRP MAINTENANCE CYCLE, TWO MAINTENANCE CYCLES ARE PLANNED CONCURRENTLY. THE FOLLOW-ON CYCLE'S LCPC OCCURS AFTER TYCOM'S CURRENT CYCLE DEFERRAL LETTER SUBMISSION AND PRIOR TO THE START OF THE CURRENT CYCLE'S CNO AVAILABILITY. WHEN POSSIBLE, SURFMEPP CONFERENCES WILL BE HELD IN CONJUNCTION WITH OTHER MT SCHEDULED MEETINGS, SUCH AS MONTHLY AVAILABILITY ADVANCED PLANNING MEETINGS AND PLANNING BOARD FOR MAINTENANCE (PB4M).

1. The Life Cycle Planning Conference will be controlled in accordance with paragraph 3.4.1a.(4) of this chapter.
2. **C+100.** SURFMEPP will **issue LCPC Announcement Letter** to establish the date, location and agenda for the LCPC.
3. **C+130.** SURFMEPP will send a list of the FRP Maintenance Cycle CMP requirements and a list of recommended availability services to the ship's PE for review and correction. This list is a preview of initial BAWP and will be discussed in detail at the LCPC. Upon request SURFMEPP will provide a list of CMP-required assessments to TYCOM, NRMC and RMC in support of the TSRA process.
4. **C+140.** The LCPC agenda will include a review of the planning schedule, required CMP assessments, Navy Data Environment (NDE) modernization forecasts, CNO Availability services/routines as applicable, organizational responsibilities, and DFSs.
5. **C+150.**
 - a. SURFMEPP will upload a data file (MM0001 file) with all mandatory maintenance actions and expected CNO Availability services into the ship's CSMP in support of ship-specific MT screening and brokering requirements. The data file will span approximately six (6) calendar quarters.
 - b. SURFMEPP will issue formal correspondence detailing the planning schedule and outstanding action items from the LCPC.
6. All other requirements listed in the body of this manual are germane (refer to Volume II, Part I, Chapter 3).

APPENDIX AO
BAWP TO AWP PROCESS - ALL NON-FDNF SHIPS
(SURFACE FORCE SHIPS ONLY)

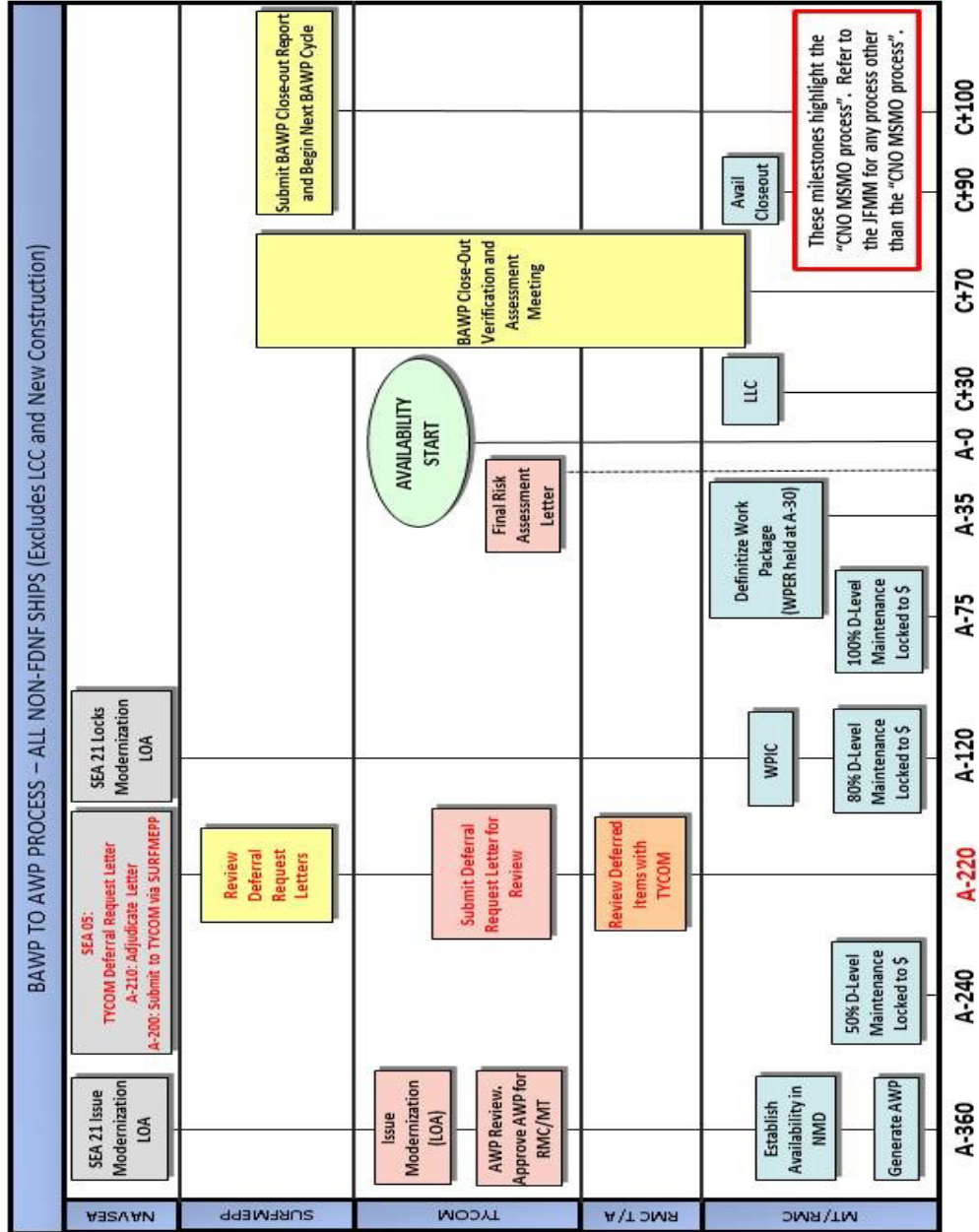

APPENDIX AO

BAWP TO AWP PROCESS - FDNF
(SURFACE FORCE SHIPS ONLY)

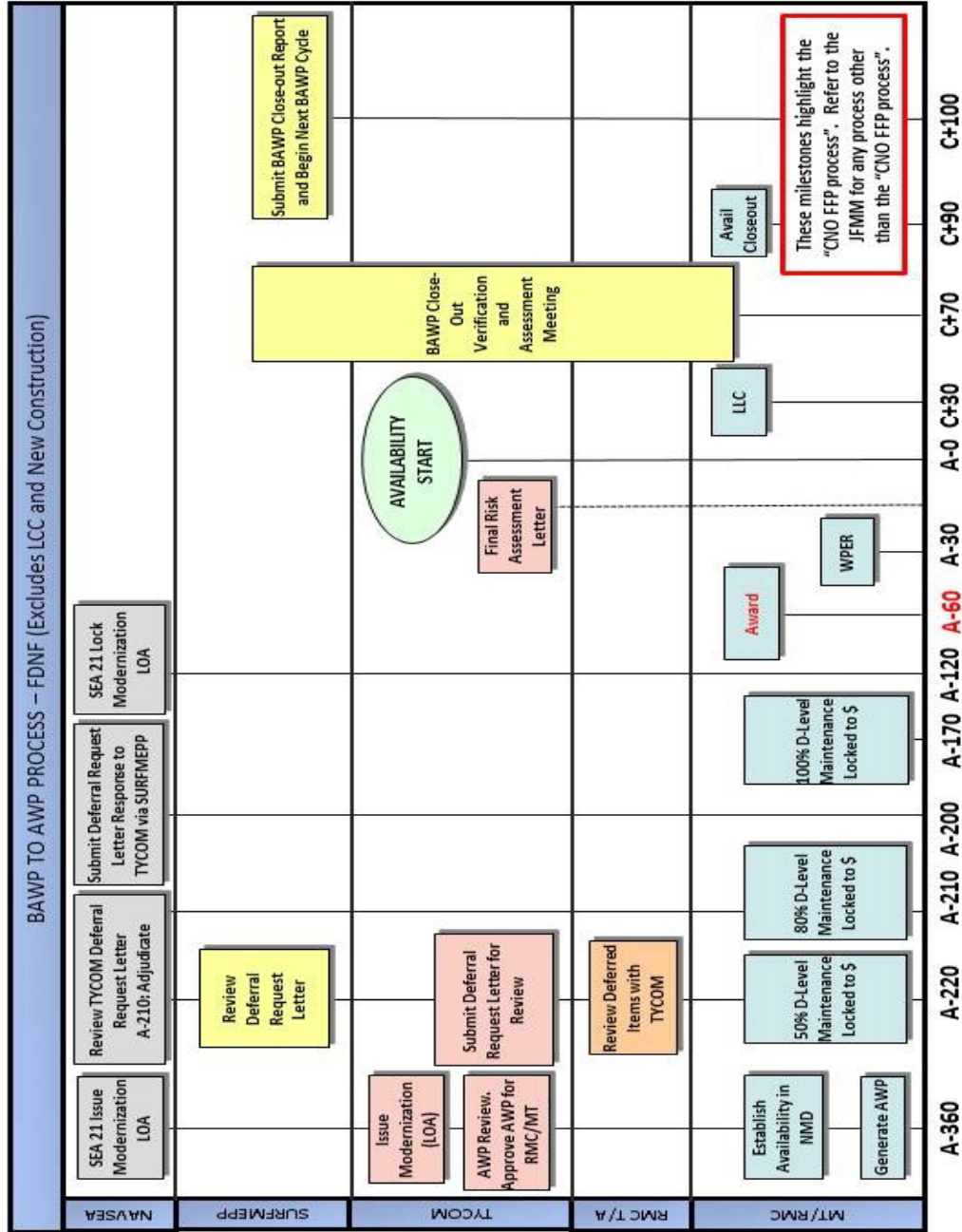

(This Page Intentionally Left Blank)

APPENDIX BA

SAMPLE TYCOM MESSAGE CONCERNING ESCORT SERVICES FOR INDUSTRIAL
ACTIVITY AVAILABILITIES OF LESS THAN SIX MONTHS DURATION

(SUBMARINES ONLY)

FM COMSUB <LANT/PAC><NORFOLK VA/PEARL HARBOR HI>//
 TO COMSUB<RON/GRU NO.>/{ISIC of Escort Ship}
 USS <ESCORT SHIP NAME>//
 INFO CNO WASHINGTON DC//
 COM<LANT/PAC>FLT <NORFOLK VA/PEARL HARBOR HI>//
 COMNAVSEASYS COM WASHINGTON DC (AS APPLICABLE) //
 DIRSSP WASHINGTON DC // {For SSBN/SSGN only}
 <SUPERVISING AUTHORITY>/{CODES}
 <SUBOPAUTH> // {If other than parent TYCOM}
 COMSUBRON ELEVEN//
 COMSUB<RON/GRU NO.>/{ISIC of Sea Trial Ship}
 CTF TWO SIX//
 CTG TWO SIX PT ONE//
 NSCES NORFOLK VA//
 UNSEARESCOM SAN DIEGO CA//
 NAVUNSEAWARCENDIV NEWPORT RI//
 NAVUNSEAWARCENDET WEST PALM BEACH FL//
 NAVUNSEAWARCENDET AUTEC ANDROS ISLAND BAHAMAS//
 NAVSURFWARCEN CARDEROCKDIV BETHESDA MD//
 PEOSUBCBTWPNSYS WASHINGTON DC//
 NAVORDTESTU CAPE CANAVERAL FL// {For SSBN/SSGN only}
 COMSUBGRU <NINE/TEN> // {For SSBN/SSGN only}
 USS <SEA TRIAL SHIP NAME> //
 BT
 UNCLAS //N03120//
 MSGID/GENADMIN/COMSUB<LANT/PAC>//
 SUBJ/(SUBS) SUBMARINE SEA TRIAL SUPPORT SERVICES//
 REF/A/<RMG/DOC>/<SUPERVISING AUTHORITY>/<DATE/DTG>//
 REF/B/DOC/COMUSFLTFORCOM/<DATE>//
 NARR/REF A IS SEA TRIAL SUPPORT REQUEST. REF B IS JOINT FLEET MAINTENANCE MANUAL//
 RMKS/1. REF A REQUESTED AND IAW REF B USS <NAME OF ESCORT SHIP> IS APPROVED AS ESCORT
 FOR USS <SEA TRIAL SHIP NAME> FOR SEA TRIALS OCCURRING <DDMMYY>.
 2. FOR COMSUB<RON/GRU NO.> PROVIDE GOLD DOLPHIN RIDER ONBOARD USS <NAME OF ESCORT SHIP>.
 3. DIRLAUTH ALCON FOR EVENT SCHEDULES AND SCHEDULE CHANGES.//
 BT

NOTE: ENSURE MESSAGES ARE IN ACCORDANCE WITH CURRENT MESSAGE FORMAT AND CURRENT PLAD IS UTILIZED.

(This Page Intentionally Left Blank)

APPENDIX BB

**SAMPLE ISIC MESSAGE TO TYCOM CONCERNING CREW CERTIFICATION AND MATERIAL
CONDITION FOR FAST CRUISE AND SEA TRIALS FOR INDUSTRIAL ACTIVITY AVAILABILITIES
LESS THAN SIX MONTHS IN DURATION**

(SUBMARINES ONLY)

FM COMSUB<RON/GRU NO.>//
 TO COMSUB<LANT/PAC> <NORFOLK VA/PEARL HARBOR HI>//
 INFO <SUPERVISING AUTHORITY>//<CODES>//
 USS <SHIP NAME>//
 COMSUBGRU<NO.>//
 BT
 UNCLAS//N09094//
 MSGID/GENADMIN/COMSUB<RON/GRU NO.>//
 SUBJ/(SUBS) USS <SHIP NAME/HULL NO.> CREW AND MATERIAL CERTIFICATION//
 REF/A/DOC/COMUSFLTFORCOM/<DATE>//
 REF/B/DOC/NAVSEA/<DATE>//
 REF/C/DOC/NAVSEA/<DATE>//
 NARR/REF A IS COMUSFLTFORCOMINST 4790.3, JOINT FLEET MAINTENANCE MANUAL. REF B IS
 SUBMARINE SAFETY (SUBSAFE) REQUIREMENTS MANUAL, NAVSEA 0924-062-0010. REF C IS
 NAVSEA URO MRC TECHNICAL MANUAL//
 RMKS/1. CREW CERTIFICATION CONDUCTED AND SATISFACTORILY COMPLETED IAW REF A.
 2. IAW REFS A AND B, COMSUB<RON/GRU NO.> CERTIFIES THE SUBSAFE CERTIFICATION BOUNDARY
 OF <SHIP NAME/HULL NO.> INSTALLED, REPAIRED AND/OR TESTED BY FORCES AFLOAT IS
 SATISFACTORY FOR SEA TRIALS TO TEST DEPTH. ALL SUBSAFE CONTROLLED WORK PACKAGES
 ARE CLOSED. CERTIFICATION REQUIREMENTS OF REF B HAVE BEEN SUSTAINED FOR THE
 REMAINDER OF THE SUBSAFE CERTIFICATION BOUNDARY. ALL OTHER CONTROLLED WORK
 PERFORMED BY SHIP'S FORCE HAS BEEN COMPLETED AND SATISFACTORILY RETESTED AND THE
 APPROPRIATE WORK PACKAGES CLOSED.
 3. MATERIAL/SALVAGE CONDITION CERTIFIED READY FOR SEA UPON COMPLETION OF THE
 FOLLOWING CORRECTIVE ACTIONS:
 A.
 B.
 4. THERE ARE NO OUTSTANDING RECS. THE FOLLOWING DEPARTURES FROM SPECIFICATION
 ARE CURRENTLY OUTSTANDING:
DEPARTURE NO. TYPE SYSTEM/COMPONENT RESTRICTION (IF ANY)
 A.
 B.
 5. ALL URO MRC AND MANDATORY TESTS/INSPECTIONS SPECIFIED IN REF C HAVE BEEN
 ACCOMPLISHED OR VERIFIED TO BE WITHIN THE REQUIRED PERIODICITY.
 6. COMSUB<RON/GRU NO.> REPORTS READINESS OF USS <SHIP NAME/HULL NO.> FOR COMMENCEMENT
 OF FAST CRUISE. CO USS <SHIP NAME/HULL NO.> CONCURS.//
 7. SUBJECT TO SATISFACTORY COMPLETION OF FAST CRUISE AND RESOLUTION OF MANDATORY
 DEFICIENCIES COMSUB<RON/GRU NO.> CONSIDERS USS <SHIP NAME/HULL NO.> MATERIAL CONDITION
 READINESS SATISFACTORY FOR COMMENCEMENT OF SEA TRIALS.//
 BT

**NOTE: ENSURE MESSAGES ARE IN ACCORDANCE WITH CURRENT MESSAGE FORMAT AND
CURRENT PLAD IS UTILIZED.**

(This Page Intentionally Left Blank)

APPENDIX BC

MAJOR TRIAL AND INSPECTION MILESTONES FOR INDUSTRIAL ACTIVITY AVAILABILITIES LESS THAN SIX MONTHS DURATION

(SUBMARINES ONLY)

EVENT	COGNIZANCE	APPROXIMATE SCHEDULE	CORRESPONDING APPENDIX
A. Periodic Monitoring Inspections	ISIC/TYCOM Representative	Start to completion	
B. Pre-Criticality Inspection (2 Days – Nuclear Powered Submarines Only)	ISIC (Only required when the reactor has been shutdown greater than 16 weeks)	Within 1 month of criticality	
C. Escort Recommendation (Message) or Waiver Request Message	TYCOM	Sea Trials -28 days	Appendix BA Para 3.6.8.3.9.b.(4) for Waivers
D. NAVSEA Approval of Escort Waiver	NAVSEA	Sea Trials -14 days	
E. Phase II Crew Certification/Material Inspection	ISIC/Crew Certification not required unless crew turnover greater than 15%. Material Inspection on a case by case basis	Prior to Fast Cruise	
F. Approve Sea Trials Agenda	ISIC	Prior to Fast Cruise (-7 to -14 days)	
G. Salvage Inspection	ISIC	Sea Trials -10 days	
H. Dock Trials (1 day or less)	CO of Ship	Sea Trials -10 days	
I. Audit Re-Entry Control, Departure from Specifications, URO MRCs (Formal Report Required)	ISIC	Sea Trials -4 days	
J. Crew and Material Certification Message	ISIC	Sea Trials -4 days	Appendix BB, BQ
K. Supervising Authority SUBSAFE Certification Continuity Report	Supervising Authority	Sea Trials -4 days	Reference (x), Paragraph 6.3.2.3.1
L. Readiness for Fast Cruise	CO of Ship	Sea Trials -4 days	Appendix BH
M. Grant Permission to Conduct Fast Cruise	ISIC	Sea Trials -4 days	Appendix BI
N. Commence Fast Cruise	CO of Ship	Sea Trials -3 days (1 to 2 days in duration)	

EVENT	COGNIZANCE	APPROXIMATE SCHEDULE	CORRESPONDING APPENDIX
O. Report Ship Readiness for Sea Trials	CO of Ship	Sea Trials -1 day	Appendix BJ
P. Message Update of Material Certification Status and Readiness for Sea Trials	ISIC	Sea Trials -1 day	Appendix BK
Q. Authorization to Commence Sea Trials and Depth Authorization Message	TYCOM	Sea Trials -1 day	Appendix BD, BR
R. Commence Sea Trials	CO of Ship	0	
S. Daily Sea Trials SITREP/Status Report	CO of Ship	At Least Daily During Sea Trials	Appendix BM
T. Supervising Authority SUBSAFE Certification Continuity Report	Supervising Authority	Follow-On Sea Trials-1 day	Reference (x), Paragraph 6.3.2.3.1
U. Report Ship Readiness for Follow-On Sea Trials	CO of Ship	Follow-On Sea Trials -1 day	Appendix BE
V. Update of Material Status prior to Follow-on Sea Trials.	ISIC	Follow-On Sea Trials-1 day	Appendix BF, BQ
W. TYCOM Authorization to Commence Follow-On Sea Trials and Depth Authorization	TYCOM	Follow-On Sea Trials-1 day	Appendix BG, BR
X. Sea Trials Completion Message	CO of Ship to ISIC and TYCOM	+1 day After Sea Trials	Appendix BL
Y. Sea Trials Completion Message	Supervising Authority	+1 day After Sea Trials	Format similar to Reference (x) Appendix B3.8
YA.	ISIC	+1 day After Sea Trials	Appendix BS
Z. URO Message	TYCOM	+1 day After Sea Trials	Appendix BO, BT

NOTE: UNLESS OTHERWISE INDICATED, SCHEDULE DATES ARE REFERENCED TO SEA TRIALS UNDERWAY DATE.

APPENDIX BD

SAMPLE TYCOM MESSAGE TO SHIP CONCERNING SEA TRIALS DEPTH AUTHORIZATION
FOR INDUSTRIAL ACTIVITY AVAILABILITIES LESS THAN SIX MONTHS IN DURATION

(SUBMARINES ONLY)

FM COMSUB<LANT/PAC> <NORFOLK VA/PEARL HARBOR HI>//
 TO USS <SHIP NAME>//
 INFO CNO WASHINGTON DC//
 COMNAVSEASYS COM WASHINGTON DC//
 COM<LANT/PAC>FLT <NORFOLK VA/PEARL HARBOR HI>//
 DIRSSP WASHINGTON DC//{For SSBN/SSGN only}
 COMSUBGRU <NO.>//
 COMSUBRON< NO.>//
 <SUPERVISING AUTHORITY>//<CODES>//
 BT
 UNCLAS //N09094//
 MSGID/GENADMIN/COMSUB<LANT/PAC>//
 SUBJ/(SUBS) USS <SHIP NAME/HULL NO.> SEA TRIALS DEPTH AUTHORIZATION//
 REF/A/DOC/<SUPERVISING AUTHORITY>/<DATE>//
 REF/B/RMG/ COMSUB<RON/GRU NO.>/<DTG>//{ APPENDIX BK }
 REF/C/RMG/ USS <SHIP NAME>/<DTG>//{ APPENDIX BJ }
 NARR/ REF A IS <SUPERVISING AUTHORITY> SUBSAFE CERTIFICATION CONTINUITY REPORT FOR <SHIP NAME/HULL NO.>. REF B IS COMSUB<RON/GRU NO.> REPORT OF MATERIAL CONDITION OF SHIP NOT WORKED BY THE SHIPYARD. REF C IS SHIP REPORT OF SATISFACTORY COMPLETION OF FAST CRUISE

RMKS/1. REF A CERTIFIED THE SUBSAFE MATERIAL CONDITION OF THOSE PARTS OF USS <SHIP NAME/HULL NO.> INSTALLED, REPAIRED AND/OR TESTED BY THE SHIPYARD IS SATISFACTORY FOR SEA TRIALS TO TEST DEPTH.

2. REF B CONFIRMS THAT THE CERTIFICATION OF THE REMAINDER OF ITEMS WITHIN THE SUBSAFE CERTIFICATION BOUNDARY OF USS <SHIP NAME/HULL NO.> HAS BEEN SUSTAINED. ACCORDINGLY, THE STATUS OF THE SUBSAFE CERTIFICATION BOUNDARY OF USS <SHIP NAME/HULL NO.> IS SATISFACTORY FOR SEA TRIALS TO TEST DEPTH.

3. REF B AND C REPORTED COMPLETION OF FAST CRUISE AND READINESS TO PROCEED ON SEA TRIALS.

4. USS <SHIP NAME/HULL NO.> IS AUTHORIZED TO DIVE UNDER DELIBERATE AND CONTROLLED CONDITIONS TO <SPECIFIED DEPTH>.

NOTE: IF AN UNSATISFACTORY CONDITION OR SEAWATER LEAKAGE IN EXCESS OF THE SPECIFICATION IS FOUND DURING THE CONDUCT OF THE CONTROLLED DIVE TO TEST DEPTH, AT THE DISCRETION OF THE COMMANDING OFFICER THE SHIP MAY CONTINUE TO TEST DEPTH UNLESS THE COMMANDING OFFICER DETERMINES IT APPROPRIATE TO ABORT THE DIVE.

5. EXCEPT AS LISTED IN 6. BELOW, THIS DEPTH AUTHORIZATION IS AUTOMATICALLY SUSPENDED UPON RE-ENTRY TO THE SUBSAFE CERTIFICATION BOUNDARY OR CASUALTY AFFECTING RECOVERABILITY, SALVAGE, WATERTIGHT INTEGRITY, OR OPERATION OF SHIP'S CONTROL SURFACES. THE SHIP SHALL NOT OPERATE AT A DEPTH GREATER THAN 200 FEET UNTIL RE-ENTRY IS CERTIFIED. TYCOM APPROVAL IS REQUIRED PRIOR TO COMMENCING A SUBSEQUENT DEEP DIVE TO CERTIFY WORK ACCOMPLISHED TO CORRECT SUBSAFE DEFICIENCIES DISCOVERED DURING THE SEA TRIAL.

6. RE-ENTRY CONTROL TO ADJUST FLOOD CONTROL HYDRAULIC VALVE TIMING WILL BE CERTIFIED BY THE COMMANDING OFFICER. TYCOM CERTIFICATION IS NOT REQUIRED, AND A SITREP WILL BE TRANSMITTED PRIOR TO RESUMPTION OF OPERATION BELOW 200 FEET.

7. FOLLOWING COMPLETION OF THE SEA TRIALS AGENDA, THE SHIP IS RESTRICTED TO ONE HALF OF TEST DEPTH PLUS FIFTY FEET UNTIL RECEIPT OF AN UNRESTRICTED OPERATIONS MESSAGE FROM <TYPE COMMANDER>. THE MESSAGE WILL BE SENT FROM <TYPE COMMANDER> FOLLOWING REVIEW AND ACCEPTANCE OF SEA TRIALS DATA BY <SUPERVISING AUTHORITY>. THE MESSAGE IS SENT WITHIN 24 HOURS FOLLOWING SHIPYARD RECEIPT OF SEA TRIAL DATA.

8. ALL SEA TRIALS SITREPS ARE TO BE SENT USING IMMEDIATE PRECEDENCE.//

BT

NOTE: ENSURE MESSAGES ARE IN ACCORDANCE WITH CURRENT MESSAGE FORMAT AND CURRENT PLAD IS UTILIZED.

APPENDIX BE

SAMPLE SHIP MESSAGE TO TYCOM CONCERNING READINESS FOR FOLLOW-ON SEA TRIALS
FOR INDUSTRIAL ACTIVITY AVAILABILITIES LESS THAN SIX MONTHS IN DURATION

(SUBMARINES ONLY)

FM USS <SHIP NAME>//
 TO COMSUB<LANT/PAC> <NORFOLK VA/PEARL HARBOR HI>//
 INFO COMSUBRON ELEVEN//
 COMSUBGRU <NO.>//
 COMSUB<RON/GRU NO.>//
 <SUPERVISING AUTHORITY>//<CODES>//
 BT
 UNCLAS //N09094//
 MSGID/GENADMIN//USS <SHIP'S NAME>//
 SUBJ/(SUBS) USS <SHIP NAME/HULL NO.>READINESS FOR <FOLLOW-ON ^(NOTE 1)>SEA TRIALS//
 REF/A/DOC/<SUPERVISING AUTHORITY>/<DATE>//
 REF/B/DOC/COMUSFLTFORCOM/<DATE>//
 REF/ REF A IS <SUPERVISING AUTHORITY> SUBSAFE CERTIFICATION CONTINUITY REPORT FOR <SHIP
 NAME/HULL NO.>. REF B IS COMUSFLTFORCOMINST 4790.3, JOINT FLEET MAINTENANCE MANUAL,
 VOLUME II.//
 RMKS/1. REF A CERTIFIED THE SUBSAFE MATERIAL CONDITION OF THOSE PARTS OF USS <SHIP
 NAME/HULL NO.> INSTALLED, REPAIRED AND/OR TESTED BY THE SHIPYARD IS SATISFACTORY FOR
 SEA TRIALS TO TEST DEPTH.
 2. USS <SHIP NAME/HULL NO.> AND CREW REPORTED READY TO PROCEED IAW REF B, ON <FOLLOW-ON
^(NOTE 1)> SEA TRIALS WITH THE FOLLOWING EXCEPTIONS:
 A. REMOVAL OF SHORE SERVICE CONNECTIONS.
 B.
 3. MATERIAL CONDITION SUPPORTS ADEQUATE CREW REST FOR UNDERWAY AT <TIME AND DATE>.
 4. REQUEST PERMISSION TO COMMENCE <FOLLOW-ON ^(NOTE 1)> SEA TRIALS.//
 BT

NOTE: UPCOMING TRIAL WHICH IS SUBJECT OF THIS CERTIFICATION (E.G., SECOND SEA TRIAL, ETC.).

NOTE: ENSURE MESSAGES ARE IN ACCORDANCE WITH CURRENT MESSAGE FORMAT AND CURRENT PLAD IS UTILIZED.

(This Page Intentionally Left Blank)

APPENDIX BF

**SAMPLE ISIC MESSAGE TO TYCOM CONCERNING
MATERIAL CERTIFICATION FOR FOLLOW-ON SEA TRIALS IN CASES WHERE A PREVIOUS SEA
TRIAL WAS ABORTED OR CORRECTIVE ACTIONS FOR SEA TRIAL DEFICIENCIES REQUIRE AN
ADDITIONAL DEEP DIVE FOR INDUSTRIAL ACTIVITY AVAILABILITIES LESS THAN SIX
MONTHS IN DURATION**

(SUBMARINES ONLY)

FM COMSUB<RON/GRU NO.>//
TO COMSUB<LANT/PAC> <NORFOLK VA/PEARL HARBOR HI>//
INFO COMSUBRON ELEVEN//
COMSUBGRU <NO.>//
USS <SHIP NAME>//
<SUPERVISING AUTHORITY>//<CODES>//
BT
UNCLAS //N09094//
MSGID//GENADMIN/COMSUB<RON/GRU NO.>//
SUBJ/(SUBS) USS <SHIP NAME/HULL NO.>MATERIAL CERTIFICATION/ READINESS FOR <FOLLOW-ON ^(NOTE 1)>
SEA TRIALS//
REF/A/DOC/ COMUSFLTFORCOM/<DATE>//
REF/B/RMG/COMSUB<RON/GRU NO.>/<DTG>//{ APPENDIX BK }
REF/C/DOC/NAVSEA /<DATE>//
REF/D/RMG/USS <SHIP NAME>/<DTG>//{ APPENDIX BE }
NARR/REF A IS COMUSFLTFORCOMINST 4790.3, JOINT FLEET MAINTENANCE MANUAL, VOLUME II.
REF B IS COMSUB<RON/GRU NO.> MSG TO TYCOM ON MATERIAL STATUS PRIOR TO INITIAL SEA
TRIALS. REF C IS NAVSEA 0924-062-0010, SUBMARINE SAFETY (SUBSAFE) REQUIREMENTS
MANUAL. REF D IS USS <SHIP NAME/HULL NO.> REPORT OF READINESS FOR FOLLOW-ON SEA
TRIALS.//
RMKS/1. IAW REF A AND C, THIS MSG CERTIFIES THAT NO MANDATORY DEFICIENCIES FOR
<FOLLOW-ON ^(NOTE 1)> SEA TRIALS HAVE BEEN IDENTIFIED. THERE HAVE BEEN NO RECS OPENED AND
NO FORCES AFLOAT SUBSAFE DEPARTURES FROM SPECIFICATION PROCESSED SINCE THE START
OF THE INITIAL SEA TRIALS <OR, SUBSEQUENT TO REF B, REPORT ANY MANDATORY DEFICIENCIES DISCOVERED
WITH CORRECTIVE ACTION, AND IF RECS AND/OR DEPARTURES FROM SPECIFICATIONS WERE PROCESSED SINCE THE
START OF THE INITIAL SEA TRIALS, REPORT ALL RECS OPENED SINCE THE START OF INITIAL SEA TRIALS ARE CLOSED
AND/OR ALL SUBSAFE DEPARTURES FROM SPECIFICATIONS PROCESSED SINCE THE START OF SEA TRIALS ARE RESOLVED
^{NOTE 2}>.
2. THERE ARE NO SUBSAFE DEPARTURES FROM SPECIFICATIONS WITH CONDITIONS WHICH
HAVE NOT BEEN SATISFIED. THE FOLLOWING DEPARTURES FROM SPECIFICATIONS ARE
CURRENTLY OUTSTANDING:
DEPARTURE NO. TYPE SYSTEM/COMPONENT RESTRICTION (IF ANY)
A.
B.
3. SHIP REPORTED READINESS FOR FOLLOW-ON SEA TRIALS IN REF D.//
BT

NOTE 1: UPCOMING TRIAL WHICH IS SUBJECT OF THIS CERTIFICATION (E.G., SECOND SEA TRIAL, ETC.).

NOTE 2: LIST ALL RE-ENTRIES TO MATERIAL CERTIFICATION BOUNDARY AND ALL WORK ON SYSTEMS AFFECTING RECOVERABILITY, SALVAGE, WATERTIGHT INTEGRITY, OR OPERATION OF SHIP'S CONTROL SURFACES WITH CORRECTIVE ACTION SINCE RELEASE FOR FAST CRUISE MESSAGE.

NOTE: ENSURE MESSAGES ARE IN ACCORDANCE WITH CURRENT MESSAGE FORMAT AND CURRENT PLAD IS UTILIZED.

(This Page Intentionally Left Blank)

APPENDIX BG

**SAMPLE TYCOM MESSAGE TO SHIP CONCERNING FOLLOW-ON
SEA TRIALS DEPTH AUTHORIZATION FOR INDUSTRIAL ACTIVITY AVAILABILITIES LESS
THAN SIX MONTHS IN DURATION**

(SUBMARINES ONLY)

FM COMSUB<LANT/PAC> <NORFOLK VA/PEARL HARBOR HI>//

TO USS <SHIP NAME>//

INFO CNO WASHINGTON DC//

COMNAVSEASYS COM WASHINGTON DC//

COM<LANT/PAC>FLT <NORFOLK VA/PEARL HARBOR HI>//

DIRSSP WASHINGTON DC//{FOR SSBN/SSGN}

COMSUBGRU <NO.>//

COMSUB<RON/GRU NO.>//

<SUPERVISING AUTHORITY>//<CODES>//

BT

UNCLAS //N09094//o

MSGID/GENADMIN/COMSUB<LANT/PAC>//

SUBJ/(SUBS) USS <SHIP NAME/HULL NO.> <FOLLOW-ON ^(NOTE 1)> SEA TRIALS DEPTH AUTHORIZATION//

REF/A/DOC/<SUPERVISING AUTHORITY>/<DATE>//

REF/B/RMG/ COMSUB<RON/GRU NO.>/<DTG>//{APPENDIX BF}

REF/C/RMG/ USS <SHIP NAME>/<DTG>//{APPENDIX BE}

NARR/ REF A IS <SUPERVISING AUTHORITY> SUBSAFE CERTIFICATION CONTINUITY REPORT FOR <SHIP NAME/HULL NO.>. REF B IS COMSUB<RON/GRU NO.> IS REPORT OF MATERIAL CONDITION OF SHIP NOT WORKED BY THE SHIPYARD. REF C IS SHIP REPORT OF READINESS FOR <FOLLOW-ON ^(NOTE 1)> SEA TRIALS

RMKS/1. REF A CERTIFIED THE SUBSAFE MATERIAL CONDITION OF THOSE PARTS OF USS <SHIP NAME/HULL NO.> INSTALLED, REPAIRED, AND/OR TESTED BY THE SHIPYARD IS SATISFACTORY FOR <FOLLOW-ON ^(NOTE 1)> SEA TRIALS TO TEST DEPTH.

2. REF B AND C CONFIRM THAT CREW IS READY FOR <FOLLOW-ON ^(NOTE 1)> SEA TRIALS AND REPORT THE CERTIFICATION OF THE REMAINDER OF ITEMS WITHIN SUBSAFE CERTIFICATION BOUNDARY OF USS <SHIP NAME/HULL NO.> HAS BEEN SUSTAINED. ACCORDINGLY, THE STATUS OF THE SUBSAFE CERTIFICATION BOUNDARY OF USS <SHIP NAME/HULL NO.> IS SATISFACTORY FOR <FOLLOW-ON ^(NOTE 1)> SEA TRIALS TO TEST DEPTH.

3. USS <SHIP NAME/HULL NO.> IS AUTHORIZED TO DIVE UNDER DELIBERATE AND CONTROLLED CONDITIONS TO <SPECIFIED> DEPTH IAW THE <FOLLOW-ON ^(NOTE 1)> SEA TRIALS AGENDA CONCURRED IN BY REF B AND APPROVED BY REF C.

NOTE: IF AN UNSATISFACTORY CONDITION OR SEAWATER LEAKAGE IN EXCESS OF THE SPECIFICATION IS FOUND DURING THE CONDUCT OF THE CONTROLLED DIVE TO TEST DEPTH, AT THE DISCRETION OF THE COMMANDING OFFICER THE SHIP MAY CONTINUE TO TEST DEPTH UNLESS THE COMMANDING OFFICER DETERMINES IT APPROPRIATE TO ABORT THE DIVE.

4. EXCEPT AS LISTED IN 5. BELOW, THIS DEPTH AUTHORIZATION IS AUTOMATICALLY SUSPENDED UPON RE-ENTRY TO THE SUBSAFE CERTIFICATION BOUNDARY OR CASUALTY AFFECTING RECOVERABILITY, SALVAGE, WATERTIGHT INTEGRITY, OR OPERATION OF SHIP'S CONTROL SURFACES. THE SHIP SHALL NOT OPERATE AT A DEPTH GREATER THAN 200 FEET UNTIL RE-ENTRY IS CERTIFIED. TYCOM APPROVAL IS REQUIRED PRIOR TO COMMENCING A SUBSEQUENT DEEP DIVE TO CERTIFY WORK ACCOMPLISHED TO CORRECT SUBSAFE DEFICIENCIES DISCOVERED DURING THE SEA TRIAL.

5. RE-ENTRY CONTROL TO ADJUST FLOOD CONTROL HYDRAULIC VALVE TIMING WILL BE CERTIFIED BY THE COMMANDING OFFICER, TYCOM CERTIFICATION IS NOT REQUIRED, AND A SITREP WILL BE TRANSMITTED PRIOR TO RESUMPTION OF OPERATION BELOW 200 FEET.

6. FOLLOWING COMPLETION OF THE SEA TRIALS AGENDA, THE SHIP IS RESTRICTED TO ONE HALF OF TEST DEPTH PLUS FIFTY FEET UNTIL RECEIPT OF AN UNRESTRICTED OPERATIONS MESSAGE FROM <TYPE COMMANDER>. THE MESSAGE WILL BE SENT FROM <TYPE COMMANDER> FOLLOWING REVIEW AND ACCEPTANCE OF SEA TRIALS DATA BY <SUPERVISING AUTHORITY>. THE MESSAGE IS SENT WITHIN 24 HOURS FOLLOWING SHIPYARD RECEIPT OF SEA TRIAL DATA.

7. ALL SEA TRIALS SITREPS ARE TO BE SENT USING IMMEDIATE PRECEDENCE.//

NOTE 1: UPCOMING TRIALS WHICH ARE SUBJECT OF THIS CERTIFICATION (E.G., SECOND SEA TRIALS, ETC.).

NOTE: ENSURE MESSAGES ARE IN ACCORDANCE WITH CURRENT MESSAGE FORMAT AND CURRENT PLAD IS UTILIZED.

APPENDIX BH**SAMPLE SHIP MESSAGE TO ISIC CONCERNING READINESS FOR FAST CRUISE FOR INDUSTRIAL ACTIVITY AVAILABILITIES LESS THAN SIX MONTHS IN DURATION****(SUBMARINES ONLY)**

FM USS <SHIP NAME>//
 TO COMSUB<RON/GRU NO.>//
 INFO COMSUBRON ELEVEN//
 COMSUBGRU <NO.>//
 <SUPERVISING AUTHORITY>/<CODES>//
 BT
 UNCLAS //N09094//
 MSGID/GENADMIN/USS <SHIP NAME>//
 SUBJ/(SUBS) USS <SHIP NAME/HULL NO.> READINESS FOR FAST CRUISE//
 REF/A/DOC/<SUPERVISING AUTHORITY>/<DATE>//
 REF/B/RMG/COMSUB<RON/GRU NO.>/<DTG>/{ APPENDIX BB }
 REF/C/DOC/COMUSFLTFORCOM/<DATE>//
 NARR/ REF A IS <SUPERVISING AUTHORITY> SUBSAFE CERTIFICATION CONTINUITY REPORT. REF B IS
 COMSUB<RON/GRU NO.> REPORT OF READINESS FOR FAST CRUISE AND SEA TRIALS. REF C IS
 COMUSFLTFORCOMINST 4790.3, JOINT FLEET MAINTENANCE MANUAL, VOLUME II.//
 1. REFS A AND B REPORTED READINESS OF SHIP FOR FAST CRUISE AND SEA TRIALS. USS <SHIP
 NAME/HULL NO.> AND CREW ARE READY FOR SEA TRIALS IAW REF C WITH THE FOLLOWING
 EXCEPTIONS:
 A. COMPLETION OF FAST CRUISE.
 B. REMOVAL OF SHORE SERVICE CONNECTIONS.
 2. REQUEST PERMISSION TO START FAST CRUISE.//
 BT

NOTE: ENSURE MESSAGES ARE IN ACCORDANCE WITH CURRENT MESSAGE FORMAT AND CURRENT PLAD IS UTILIZED.

(This Page Intentionally Left Blank)

APPENDIX BI

SAMPLE ISIC MESSAGE TO SHIP AUTHORIZING COMMENCEMENT OF FAST CRUISE FOR INDUSTRIAL ACTIVITY AVAILABILITIES LESS THAN SIX MONTHS IN DURATION

(SUBMARINES ONLY)

FM COMSUB<RON/GRU NO.>//
 TO USS <SHIP NAME>//
 INFO CNO WASHINGTON DC//
 COM<LANT/PAC>FLT <NORFOLK VA/PEARL HARBOR HI>//
 COMNAVSEASYS COM WASHINGTON DC//
 COMSUB<LANT/PAC> <NORFOLK VA/PEARL HARBOR HI>//
 DIRSSP WASHINGTON DC//{For SSBN/SSGN only}
 <SUBOPAUTH>// {If other than parent TYCOM}
 COMSUBRON ELEVEN//
 COMSUBGRU <NO.>//
 <SUPERVISING AUTHORITY>/<CODES>//
 BT
 UNCLAS //N09094//
 MSGID/GENADMIN/USS <SHIP NAME>//
 SUBJ/(SUBS) USS <SHIP NAME/HULL NO.> READINESS FOR FAST CRUISE//
 REF/A/DOC/<SUPERVISING AUTHORITY>/<DATE>//
 REF/B/RMG/COMSUB<RON/GRU NO.>/<DTG>//{ APPENDIX BB }
 REF/C/RMG/ USS <SHIP NAME>/<DTG>//{ APPENDIX BH }
 REF/D/DOC/ COMUSFLTFORCOM/<DATE>//
 NARR/ REF A IS <SUPERVISING AUTHORITY> SUBSAFE CERTIFICATION CONTINUITY REPORT. REF B IS
 COMSUB<RON/GRU NO.> REPORT OF READINESS FOR FAST CRUISE AND SEA TRIALS. REF C USS <SHIP
 NAME> IS REPORT OF READINESS FOR FAST CRUISE AND SEA TRIALS. REF D IS
 COMUSFLTFORCOMINST 4790.3, JOINT FLEET MAINTENANCE MANUAL, VOLUME II.//
 1. REF A REPORTED <SUPERVISING AUTHORITY> ASSIGNED WORK COMPLETE AND READINESS FOR
 FAST CRUISE AND SEA TRIALS.
 2. REF B REPORTED REMAINING PORTIONS OF SUBSAFE BOUNDARY NOT WORKED BY
 <SUPERVISING AUTHORITY> MAINTAINED CERTIFIED AND READINESS FOR FAST CRUISE AND SEA
 TRIALS.
 3. REF C REPORTED SHIP'S FORCE READINESS FOR FAST CRUISE AND SEA TRIALS AND
 REQUESTED PERMISSION TO COMMENCE FAST CRUISE.
 4. IAW WITH REF D USS <SHIP NAME> IS AUTHORIZED TO COMMENCE FAST CRUISE. <SHIP NAME> IS
 DIRECTED TO REPORT COMPLETION OF FAST CRUISE AND ALL SUBSAFE DEFICIENCIES
 IDENTIFIED DURING FAST CRUISE TO COMSUB<RON/GRU NO.>, COMSUB<LANT/PAC> AND <SUPERVISING
 AUTHORITY>./.
 BT

NOTE: ENSURE MESSAGES ARE IN ACCORDANCE WITH CURRENT MESSAGE FORMAT AND CURRENT PLAD IS UTILIZED.

(This Page Intentionally Left Blank)

APPENDIX BJ

SAMPLE SHIP MESSAGE TO ISIC AND TYCOM CONCERNING READINESS FOR SEA TRIALS FOR INDUSTRIAL ACTIVITY AVAILABILITIES LESS THAN SIX MONTHS IN DURATION

(SUBMARINES ONLY)

FM USS <SHIP NAME>//
TO COMSUB<LANT/PAC> <NORFOLK VA/PEARL HARBOR HI>//
COMSUB<RON/GRU NO.>//
INFO COMSUBRON ELEVEN//
COMSUBGRU <NO.>//
<SUPERVISING AUTHORITY>//<CODES>//
BT
UNCLAS //N09094//
MSGID/GENADMIN//USS <SHIP'S NAME>//
SUBJ/(SUBS) USS <SHIP NAME/HULL NO.>READINESS FOR SEA TRIALS//
REF/A/DOC/ COMUSFLTFORCOM/<DATE>//
NARR/REF A IS COMUSFLTFORCOMINST 4790.3, JOINT FLEET MAINTENANCE MANUAL, VOLUME II//
RMKS/1. FAST CRUISE COMPLETED <TIME AND DATE>.
2. IAW REF A, USS <SHIP NAME/HULL NO.> AND CREW REPORTED READY TO PROCEED ON SEA TRIALS WITH THE FOLLOWING EXCEPTIONS:
 A. REMOVAL OF SHORE SERVICE CONNECTIONS.
 B.
3. MATERIAL CONDITION SUPPORTS ADEQUATE CREW REST FOR UNDERWAY AT <TIME AND DATE>.
4. REQUEST PERMISSION TO COMMENCE SEA TRIALS.//
BT

NOTE: ENSURE MESSAGES ARE IN ACCORDANCE WITH CURRENT MESSAGE FORMAT AND CURRENT PLAD IS UTILIZED.

(This Page Intentionally Left Blank)

APPENDIX BK

**SAMPLE ISIC MESSAGE TO TYCOM CONCERNING FINAL MATERIAL CERTIFICATION PRIOR
TO SEA TRIALS FOR INDUSTRIAL ACTIVITY AVAILABILITIES LESS THAN SIX MONTHS IN
DURATION**

(SUBMARINES ONLY)

FM COMSUB<RON/GRU NO.>//
 TO COMSUB<LANT/PAC> <NORFOLK VA/PEARL HARBOR HI>//
 INFO COMSUBRON ELEVEN//
 COMSUBGRU <NO.>//
 USS <SHIP NAME>//
 <SUPERVISING AUTHORITY>//<CODES>//
 BT
 UNCLAS //N09094//
 GENADMIN/COMSUB<RON/GRU NO.>//
 SUBJ/(SUBS) USS <SHIP NAME/HULL NO.> MATERIAL CERTIFICATION/ READINESS FOR SEA TRIALS//
 REF/A/DOC/ COMUSFLTFORCOM/<DATE>//
 REF/B/RMG/COMSUB<RON/GRU NO.><DTG>//{ APPENDIX BB }
 REF/C/RMG/USS<SHIP NAME>/<DTG>//{ APPENDIX BJ }
 REF/D/DOC/NAVSEA /<DATE>//
 NARR/REF A IS COMUSFLTFORCOMINST 4790.3, JOINT FLEET MAINTENANCE MANUAL, VOLUME II.
 REF B IS COMSUB<RON/GRU NO.> MSG TO TYCOM ON CREW CERT. REF C IS SHIP REPORT OF
 COMPLETION OF FAST CRUISE AND READINESS FOR SEA TRIALS. REF D IS NAVSEA 0924-062-0010,
 SUBMARINE SAFETY (SUBSAFE) REQUIREMENTS MANUAL.
 RMKS/1. IAW REFS A AND D, THIS MSG CERTIFIES THAT NO MANDATORY DEFICIENCIES FOR SEA
 TRIALS HAVE BEEN IDENTIFIED AS REPORTED IN REF B AND C. THERE HAVE BEEN NO RECS
 OPENED AND NO SUBSAFE DEPARTURES FROM SPECIFICATION PROCESSED SINCE THE START OF
 FAST CRUISE. <OR, REPORT ANY MANDATORY DEFICIENCIES DISCOVERED WITH CORRECTIVE ACTION, AND IF RECS
 AND/OR DEPARTURES FROM SPECIFICATIONS WERE PROCESSED SINCE THE START OF FAST CRUISE, REPORT ALL RECS
 OPENED SINCE THE START OF FAST CRUISE ARE CLOSED AND/OR ALL SUBSAFE DEPARTURES FROM SPECIFICATIONS
 PROCESSED SINCE THE START OF FAST CRUISE ARE RESOLVED.> ^(NOTE 1.)
 2. THERE ARE NO SUBSAFE DEPARTURES FROM SPECIFICATIONS WITH CONDITIONS WHICH
 HAVE NOT BEEN SATISFIED. THE FOLLOWING ADDITIONAL DEPARTURES FROM SPECIFICATIONS
 WERE GENERATED SUBSEQUENT TO REF B. <If None, indicate NONE>
DEPARTURE NO. TYPE SYSTEM/COMPONENT RESTRICTION (IF ANY)
 A.
 B.
 3. REQUEST PERMISSION TO COMMENCE SEA TRIALS. CO <SHIP NAME/HULL NO.> CONCURS.//
 BT

**NOTE 1: LIST ALL RE-ENTRIES TO MATERIAL CERTIFICATION BOUNDARY AND ALL WORK
ON SYSTEMS AFFECTING RECOVERABILITY, SALVAGE, WATERTIGHT INTEGRITY,
OR OPERATION OF SHIP'S CONTROL SURFACES WITH CORRECTIVE ACTION SINCE
RELEASE FOR FAST CRUISE MESSAGE.**

**NOTE: ENSURE MESSAGES ARE IN ACCORDANCE WITH CURRENT MESSAGE FORMAT AND
CURRENT PLAD IS UTILIZED.**

(This Page Intentionally Left Blank)

APPENDIX BL

**SAMPLE SHIP MESSAGE TO ISIC AND TYCOM CONCERNING MATERIAL CERTIFICATION
UPON COMPLETION OF SEA TRIALS FOR INDUSTRIAL ACTIVITY AVAILABILITIES LESS THAN
SIX MONTHS IN DURATION**

(SUBMARINES ONLY)

FM USS <SHIP NAME>//
TO COMSUB<LANT/PAC> <NORFOLK VA/PEARL HARBOR HI>//
COMSUB<RON/GRU NO.>//
<SUPERVISING AUTHORITY>//<CODES>//
INFO CNO WASHINGTON DC//
COMNAVSEASYS COM WASHINGTON DC//
COM<LANT/PAC>FLT <NORFOLK VA/PEARL HARBOR HI>//
DIRSSP WASHINGTON DC//{FOR SSBN/SSGN}
COMSUBRON ELEVEN//
COMSUBGRU<NO.>//
BT
UNCLAS //N09094//
GENADMIN/COMSUB<RON/GRU NO.>//
SUBJ/(SUBS) USS <SHIP NAME/HULL NO.> SATISFACTORY COMPLETION OF SEA TRIALS//
REF/A/DOC/ COMUSFLTFORCOM/<DATE>//
NARR/REF A IS COMUSFLTFORCOMINST 4790.3, JOINT FLEET MAINTENANCE MANUAL, VOLUME II.
RMKS/1. USS <SHIP NAME> REPORTS SATISFACTORY COMPLETION OF SEA TRIALS. ALL TESTING
REQUIRED BY THE SEA TRIALS TEST AGENDA AND REF (A) HAVE BEEN COMPLETED. <OR REPORT
ALL TESTING NOT COMPLETED PER NOTE 1>.
2. THERE WERE NO SUBSAFE DEFICIENCIES IDENTIFIED. <OR REPORT ALL SUBSAFE DEFICIENCIES>.
3. THE <SUPERVISING AUTHORITY> TEST DIRECTOR CONCURS WITH THIS REPORT.
BT

**NOTE 1: LIST ALL RE-ENTRIES TO MATERIAL CERTIFICATION BOUNDARY AND ALL WORK
ON SYSTEMS AFFECTING RECOVERABILITY, SALVAGE, WATERTIGHT INTEGRITY,
OR OPERATION OF SHIP'S CONTROL SURFACES WITH CORRECTIVE ACTION SINCE
RELEASE FOR FAST CRUISE MESSAGE.**

**NOTE: ENSURE MESSAGES ARE IN ACCORDANCE WITH CURRENT MESSAGE FORMAT AND
CURRENT PLAD IS UTILIZED.**

(This Page Intentionally Left Blank)

APPENDIX BM
SUBMARINE SEA TRIAL SITUATION REPORT
(SITREP LESS THAN SIX MONTHS)

FM USS <SHIP NAME>//
 TO COMSUB<LANT/PAC> <NORFOLK VA/PEARL HARBOR HI>//
 INFO CNO WASHINGTON DC//
 COM<LANT/PAC>FLT <NORFOLK VA/PEARL HARBOR HI> //
 COMNAVSEASYS COM WASHINGTON DC//
 DIRSSP WASHINGTON DC// {For SSBN/SSGN Only}
 <SUBOPAUTH>// {IF OTHER THAN PARENT TYCOM}
 COMSUBRON ELEVEN//
 COMSUBGRU <NO.>//
 COMSUB<RON/GRU NO.>//
 <SUPERVISING AUTHORITY>//<CODES>//
 (OTHER UNITS IN AREA IF APPLICABLE)//
 BT
 UNCLAS //N09094//
 MSGID/GENADMIN/USS <SHIP NAME>//
 SUBJ/(TYPE AVAILABILITY) SITREP (SEQUENTIAL NUMBER)//
 REF/A/DOC/COMUSFLTFORCOM/<DATE>//
 REF/B/DOC/AS APPLICABLE/<DATE>//
 NARR/ REF A IS COMUSFLTFORCOMINST 4790.3, JOINT FLEET MAINTENANCE MANUAL, VOLUME II.
 RMKS/1. CO'S SUMMARY, EVENTS 1-9 COMPLETED WITH THE FOLLOWING DEFICIENCIES NOTED:
 A. SUBSAFE/URO DEFICIENCIES.
 1) NON-ISOLABLE SEAWATER LEAKS
 (A) #1 SCOPE HULL GLAND LEAK 1 DPM AT 20% TD
 (B) SSW-30 (BODY-BONNET LEAK)
 (C) DE-7 (STEM SEAL LEAK)
 (D) RUDDER RAM
 (E) EHP P46-3P
 (F) TD-89 (FWD ESCAPE TRUNK DRAIN)
 (G) #2 SCOPE INBOARD HOIST CYLINDER FITTING
 (H) #1 SCOPE INBOARD HOIST CYLINDER FITTING
 (I) STERN PLANES RAM PACKING
 (J) STBD RETRACTABLE BOW PLANE EXTEND RETRACT CYLINDER
 (K) AHP-525 (PARKER CHECK VALVE SEAT LEAK)
 (L) SSW-20 UPSTREAM FLANGE
 (M) EHP P025-01S (WHIP ANTENNA)
 (N) INNER STERN PLANES RAM PACKING
 2) ISOLABLE SEAWATER LEAK
 (A) TDU VENT, TD-104 LEAKS 3 DPM AT 65% TD
 (B) ASW-5 BODY-BONNET LEAK
 OTHER DEFICIENCIES
 (A) STERN PLANES AUX ANGLE INDICATOR ON BCP DOES NOT ILLUMINATE, URO-16
 (B) MSW-2 CYCLE TIME SHUT IS 10.1 SEC
 (C) MBT 3A WILL NOT OPEN
 B. NON-SUBSAFE/URO DEFICIENCIES.
 1) SCULLERY DRAIN LEAKING AT FITTING F-18, 27 DPM
 2) 3 FLOOR TILES IN CREWS MESS LIFTED AFFECTING SANITATION
 3) CO HOT WATER SHOWER RECIRC PUMP FAILED
 2. PREVIOUS DEFICIENCIES REPORTED AND STATUS.

(LIST ALL PREVIOUS DEFICIENCIES AND CURRENT STATUS-THE GOAL IS TO CAPTURE THE COMPLETE MATERIAL CONDITION IN EACH MESSAGE) STATUS = REPAIRED (REP), CORRECTIVE ACTION REQUIRED (CAR), NOT APPLICABLE (NA)

EXAMPLE –

- 1) SCULLERY DRAIN LEAKING AT FITTING F-18, 27 DPM -REP
 - 2) 3 FLOOR TILES IN CREWS MESS LIFTED AFFECTING SANITATION - CAR
 - 3) CO HOT WATER SHOWER RECIRC PUMP FAILED - CAR
 - 4) #1 SCOPE HULL GLAND LEAK 1 DPM AT 20% TD - CAR
 - 5) TDU VENT, TD-104 LEAKS 3 DPM AT 65% TD - CAR
 - 6) STERN PLANES AUX ANGLE INDICATOR ON BCP DOES NOT ILLUMINATE, URO-16 - REP
3. ADDITIONAL INFO.
- 1) DESCRIBE ANY ADDITIONAL INFO DESIRED OR LIST "NONE".
 4. TYCOM, NAVSHIPYD, AND NAVSEA REPS CONCUR-DO NOT CONCUR (AS APPROPRIATE).//
- BT

NOTE: ENSURE MESSAGES ARE IN ACCORDANCE WITH CURRENT MESSAGE FORMAT AND CURRENT PLAD IS UTILIZED.

APPENDIX BN
SAMPLE MESSAGE CONCERNING
MOD ALERT NOTIFICATION
(SUBMARINES ONLY)

FM <INDUSTRIAL ACTIVITY>
 TO COMSUB<RON/GRU NO.>/{ISIC of Escort Ship}
 COMSUBLANT
 COMSUBPAC
 COMSUBRON ELEVEN//
 UNSEARESCOM SAN DIEGO CA//
 USS <ESCORT SHIP NAME>//
 INFO CNO WASHINGTON DC//
 COM<LANT/PAC>FLT <NORFOLK VA/PEARL HARBOR HI>//
 COMNAVSEASYSYSCOM WASHINGTON DC//
 DIRSSP WASHINGTON DC // {For SSBN/SSGN only}
 <SUPERVISING AUTHORITY> // <CODES> //
 <SUBOPAUTH> // {If other than parent TYCOM}
 COMSUB<RON/GRU NO.>/{ISIC of Sea Trial Ship}
 CTF TWO SIX//
 CTG TWO SIX PT ONE//
 NSCSES NORFOLK VA//
 COMSUBGRU <NINE/TEN> // {For SSBN/SSGN only}
 USS <SHIP NAME/HULL NO.>{SEA TRIAL UNIT} //
 BT
 UNCLAS //N03120//
 MSGID/GENADMIN/<INDUSTRIAL ACTIVITY> //
 SUBJ/(SUBS) SUBMARINE SEA TRIAL SUPPORT SERVICES/ MOD ALERT NOTIFICATION//
 REF/A/DOC/COMUSFLTFORCOM/<DATE> //
 NARR/REF A IS JOINT FLEET MAINTENANCE MANUAL//
 RMKS/1. IAW REF A REQUIREMENTS, USS <SHIP NAME/HULL NO.> IS SCHEDULED FOR
 SEA TRIALS OCCURRING <DDMMYY>. REQUEST SRDRS MOD ALERT BE SCHEDULED
 TO COVER SEA TRIAL PERIOD.
 2. ANY CHANGES IN ALERT POSTURE REQUIREMENTS WILL BE FORWARDED.//
 BT

**NOTE: ENSURE MESSAGES ARE IN ACCORDANCE WITH CURRENT MESSAGE FORMAT AND
 CURRENT PLAD IS UTILIZED.**

(This Page Intentionally Left Blank)

APPENDIX BO

SAMPLE TYCOM MESSAGE TO SHIP CONCERNING URO FOR INDUSTRIAL ACTIVITY
AVAILABILITIES LESS THAN SIX MONTHS IN DURATION

(SUBMARINES ONLY)

FM COMSUB<LANT/PAC> <NORFOLK VA/PEARL HARBOR HI>//
 TO USS <SHIP NAME>//
 INFO CNO WASHINGTON DC//
 COMNAVSEASYS COM WASHINGTON DC//
 COM<LANT/PAC>FLT <NORFOLK VA/PEARL HARBOR HI>//
 DIRSSP WASHINGTON DC//{FOR SSBN/SSGN}
 COMSUBGRU <NO.>//
 COMSUB<RON/GRU NO.>//
 <SUPERVISING AUTHORITY>//
 SUBMEPP PORTSMOUTH NH//
 BT
 UNCLAS //N09094//
 MSGID/GENADMIN/COMSUB<LANT/PAC>//
 SUBJ/(SUBS) UNRESTRICTED OPERATION OF USS <SHIP NAME/HULL NO.>//
 REF/A/RMG/ USS <SHIP NAME>/<DTG>//
 REF/B/RMG/<SUPERVISING AUTHORITY>/<DTG>//
 REF/C/DOC/COMUSFLTFORCOMINST 4790.3//
 REF/D/DOC/ NAVSEA 0924-062-0010//
 REF/E/DOC/ COMSUB<PAC/FOR>/<DATE>//
 NARR/REF A IS USS <SHIP NAME> MSG CONCERNING COMPLETION OF SEA TRIALS. REF B IS THE
 <SUPERVISING AUTHORITY> REPORT OF SATISFACTORY REVIEW OF SEA TRIALS TEST DATA AND
 SATISFACTORY MATERIAL CONDITION FOLLOWING DEPOT AVAILABILITY. REF C IS THE JOINT
 FLEET MAINTENANCE MANUAL. REF D IS THE SUBMARINE SAFETY (SUBSAFE) REQUIREMENTS
 MANUAL. REF E IS THE COM<LANT/PAC>NOTE C3120 CONCERNING SUBMARINE DEPTH
 AUTHORIZATIONS AND RESTRICTIONS//
 RMKS/1. REF A REPORTED THE SATISFACTORY COMPLETION OF SEA TRIALS WITH NO SUBSAFE
 DEFICIENCIES IDENTIFIED. (IF SPECIFIC SUBSAFE DEFICIENCIES WERE IDENTIFIED BUT WERE
 NOT DEEP DIVE RETEST FAILURES LIST SPECIFICS – DEEP DIVE TEST FAILURES WILL REQUIRE A
 FOLLOW-ON SEA TRIAL).
 2. REF B REPORTED SATISFACTORY REVIEW OF SEA TRIAL AGENDA BY <SUPERVISING
 AUTHORITY> AND SATISFACTORY MATERIAL CONDITION OF THE SHIP FOLLOWING SEA TRIALS.
 3. TYCOM AUTHORIZES, USS <SHIP NAME/HULL NO.> TO CONDUCT OPERATIONS TO <SPECIFIED>
 DEPTH, SUBJECT TO THE FOLLOWING RESTRICTIONS: <LIST RESTRICTIONS IF THEY EXIST OR
 STATE "NONE">.
 4. CONTINUED CERTIFICATION FOR OPERATIONS TO TEST DEPTH IS SUBJECT TO COMPLIANCE
 WITH REF C AND REF D.
 5. URO/MRC PERIODICITIES FOLLOWING THE MINOR DEPOT AVAILABILITY COMMENCE ON
 <DATE> IN ACCORDANCE WITH VOLUME VI, SECTION 25.2.3.1.B OF REF C.
 6. THIS MSG REMAINS IN EFFECT UNTIL INCLUDED IN A FUTURE REVISION OF REF E.//
 BT

**NOTE: ENSURE MESSAGES ARE IN ACCORDANCE WITH CURRENT MESSAGE FORMAT AND
 CURRENT PLAD IS UTILIZED.**

(This Page Intentionally Left Blank)

APPENDIX BP

Message Scenario for CNO Availabilities of Less than Six Months in Duration

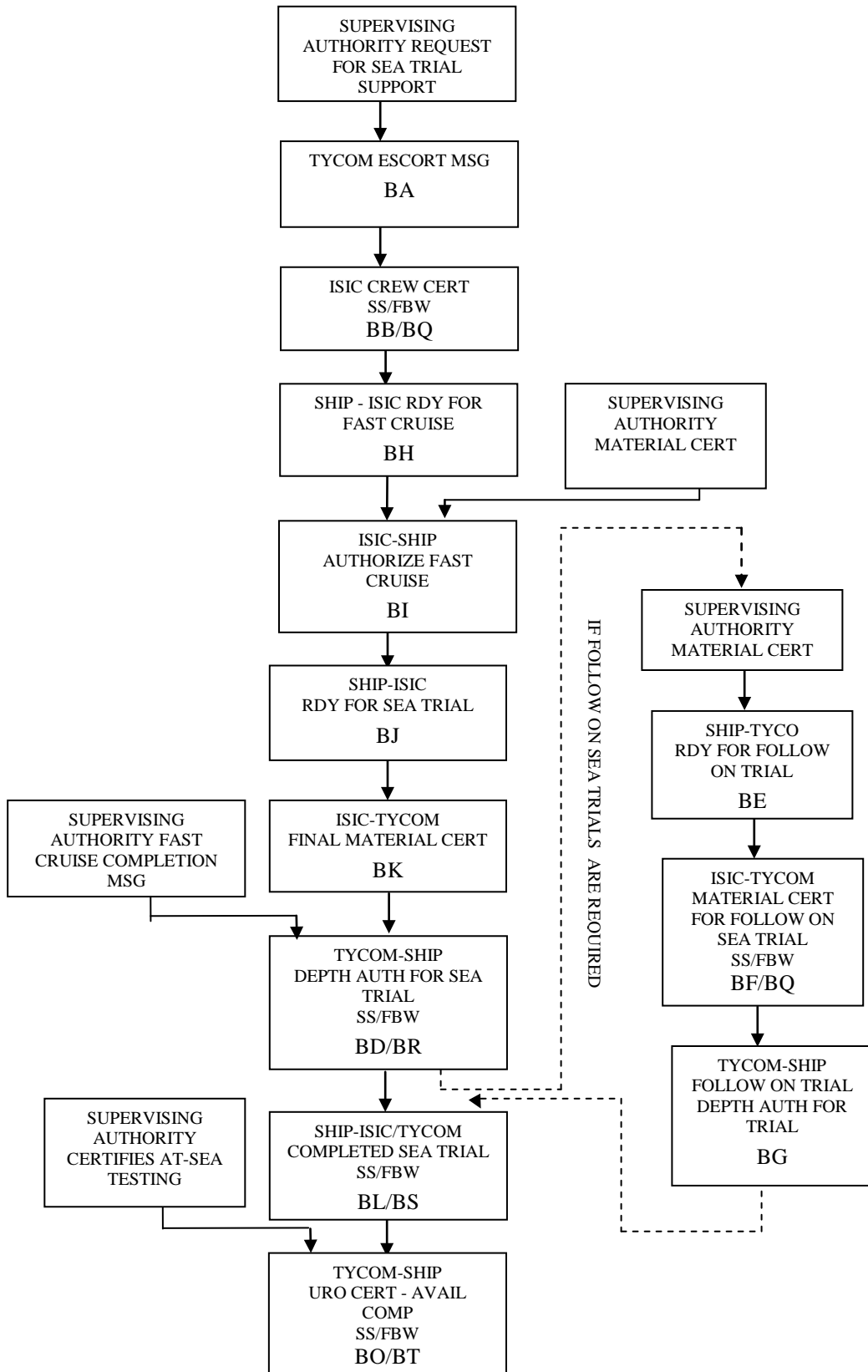

(This Page Intentionally Left Blank)

APPENDIX BQ

**SAMPLE ISIC MESSAGE TO TYCOM CONCERNING FLY-BY-WIRE CREW CERTIFICATION
AND FLY-BY-WIRE MATERIAL CONDITION FOR AT-SEA TESTING OR FAST CRUISE AND SEA
TRIALS**

(SUBMARINES ONLY)

FM COMSUB<RON/GRU NO.>//
 TO COMSUB<LANT/PAC> <NORFOLK VA/PEARL HARBOR HI>//
 INFO CNO WASHINGTON DC//
 COMNAVSEASYS COM WASHINGTON DC//
 PEO SUB WASHINGTON DC//
 COMSUBGRU <NO.>//
 COM<LANT/PAC>FLT<NORFOLK VA/PEARL HARBOR HI> //
 NAVSURFWAR CEN CARDEROCK DIV BETHESDA MD//
 COMREGSUPPGRU <CITY ST>//
 <SUPERVISING AUTHORITY>//<CODES>//(IF APPLICABLE)
 USS <SHIP NAME/HULL NO.>//
 BT
 UNCLAS //N04790//
 MSGID/GENADMIN/COMSUB<RON/GRU NO.>//
 SUBJ/(SUBS) USS <SHIP NAME/HULL NO.> FLY-BY-WIRE SHIP CONTROL SYSTEMS/(FBW SCS)
 MATERIAL CERTIFICATION//
 REF/A/DOC/COMUSFLTFORCOM/<DATE>//
 REF/B/DOC/NAVSEA/<DATE>//
 REF/C/DOC/NAVSEA/<DATE>//
 NARR/REF A IS COMUSFLTFORCOMINST 4790.3, JOINT FLEET MAINTENANCE MANUAL. REF B IS
 REQUIREMENTS MANUAL FOR SUBMARINE FLY-BY-WIRE SHIP CONTROL SYSTEMS, NAVSEA
 T9044-AD-MAN-010. REF C IS NAVSEA URO MRC TECHNICAL MANUAL//
 RMKS/1. PER REF A THE ISIC CERTIFIES USS <SHIP NAME/HULL NO.> FBW
 SCS MAINTENANCE AND RECOMMENDS THE MATERIAL CONDITION OF
 USS <SHIP NAME/HULL NO.> FBW SCS IS SATISFACTORY FOR AT-SEA TESTING.
 2. THE ISIC COMPLETED AN FBW SCS CERTIFICATION AUDIT WITH <LIST NUMBER OR WRITE
 "NO"> IMMEDIATE CORRECTIVE ACTION/S AND <LIST NUMBER OR WRITE "NO"> REPORT OF
 CORRECTIVE ACTION. PER REF A ALL CORRECTIVE ACTIONS ARE COMPLETED AND REPORTED
 TO ISIC.
 3. THE CREW IS KNOWLEDGEABLE AND PROFICIENT AND HAS PROPER NUMBER OF TRAINED
 OPERATORS.
 4. THERE ARE NO CONDITIONAL FBW SCS DEPARTURE FROM SPECIFICATIONS OR DEVIATIONS
 AND WAIVERS THAT HAVE NOT BEEN SATISFIED.
 5. ALL DOCKSIDE TESTING IS COMPLETE. PER REF A ALL AT-SEA TESTING TO BE COMPLETED
 PER THE SHIPS CONTROL SYSTEMS TRIAL AGENDA OR AS STATED IN DEPARTURE FROM
 SPECIFICATIONS/DEVIATIONS/WAIVERS. PRIOR TO THE COMPLETION OF THE SHIPS CONTROL
 SYSTEMS AT-SEA TESTING THE FOLLOWING RESTRICTIONS ARE IN EFFECT:
 A.<TYPICAL RESTRICTIONS, HOWEVER LIST ONLY THOSE REQUIRED BASED UPON WORK
 ACCOMPLISHED, IF NONE - WRITE "NONE".
 B. AUTOMATIC MODE MAY BE USED FOR COURSE KEEPING (SURFACED AND SUBMERGED),
 COURSE CHANGING (SURFACE AND SUBMERGED), AND DEPTH KEEPING.
 C. DEPTH CHANGES SHALL BE CONDUCTED IN MANUAL MODE.>
 6. THE FBW SCS MATERIAL CONDITION OF THOSE PARTS OF THE SHIP INSTALLED, REPAIRED AND
 TESTED BY THE ISEA AND ACTIVITIES PERFORMING WORK IS SATISFACTORY.

7. REQUEST TYCOM APPROVAL FOR FBW SCS USE IN SUPPORT OF AT-SEA TESTING <IAW THE RESTRICTIONS CITED IN PARA 5 *IF APPLICABLE*>.
BT

NOTE: ENSURE MESSAGES ARE IN ACCORDANCE WITH CURRENT MESSAGE FORMAT AND CURRENT PLAD IS UTILIZED.

APPENDIX BR

SAMPLE TYCOM MESSAGE TO SHIP CONCERNING AUTHORIZATION TO USE FLY-BY-WIRE SHIP CONTROL SYSTEMS

(SUBMARINES ONLY)

FM COMSUB<LANT/PAC> <NORFOLK VA/PEARL HARBOR HI>//
 TO USS <SHIP NAME>//
 INFO CNO WASHINGTON DC//
 COMNAVSEASYS COM WASHINGTON DC//
 COM<LANT/PAC>FLT <NORFOLK VA/PEARL HARBOR> //
 <DIRSSP WASHINGTON DC FOR SSBN>
 COMSUBGRU <NO.>//
 COMSUBBRON <NO.>//
 <SUPERVISING AUTHORITY>//
 BT
 UNCLAS //N09094//
 MSGID/ADMIN/COMSUB<LANT/PAC>//
 SUBJ/(SUBS) USS <SHIP NAME/HULL NO.> AUTHORIZATION TO USE THE FLY-BY-WIRE SHIP CONTROL SYSTEMS IN SUPPORT OF SEA TRIALS//
 REF/A/MSG/<CERTIFICATION ACTIVITY>/<DTG>//
 REF/B/MSG/SUPERVISING AUTHORITY/<DTG>//
 REF/C/LTR/NAVSEA <SER NO./DATE>//
 REF/D/LTR/COMSUB<LANT/PAC>/<SER NO./DATE>//
 REF<OTHER REFERENCES AS APPROPRIATE>
 NARR/<REF A IS <CERTIFICATION ACTIVITY> CREW, FBW SCS MATERIAL CERTIFICATION AND READINESS FOR AT-SEA OPERATION. REF B IS <SUPERVISING AUTHORITY> REPORT OF USS <SHIP NAME/HULL NO.> FAST CRUISE COMPLETION AND READINESS OF THE FLY-BY-WIRE SHIP CONTROL SYSTEMS FOR SEA TRIALS. REF C CONCURRED IN THE SEA TRIAL AGENDA FOR USS <SHIP NAME/HULL NO.>. REF D APPROVED THE SEA TRIAL AGENDA FOR USS <SHIP NAME/HULL NO.>////
 RMKS/1. REF A CERTIFIED THE MATERIAL CONDITION OF THOSE PARTS OF THE FLY-BY-WIRE SHIP CONTROL SYSTEMS FOR THE USS <SHIP NAME/HULL NO.> INSTALLED, REPAIRED AND/OR TESTED BY THE SHIPYARD IS SATISFACTORY FOR SEA TRIALS.
 2. THIS MESSAGE CONFIRMS THAT THE CERTIFICATION OF THE REMAINDER OF ITEMS WITHIN THE FLY-BY-WIRE SHIP CONTROL SYSTEMS CERTIFICATION BOUNDARY OF USS <SHIP NAME/HULL NO.> HAS BEEN SUSTAINED. ACCORDINGLY, THE STATUS OF THE FLY-BY-WIRE SHIP CONTROL SYSTEMS CERTIFICATION BOUNDARY OF USS <SHIP NAME/HULL NO.> IS SATISFACTORY FOR SEA TRIALS. <SUBJECT TO ANY RESTRICTIONS IN PARA 3 OF REF A if any are identified>.
 3. REF B REPORTED SUCCESSFUL COMPLETION OF FAST CRUISE AND READINESS OF THE FLY-BY-WIRE SHIP CONTROL SYSTEMS FOR SEA TRIALS.
 4. USS <SHIP NAME/HULL NO.> FLY-BY-WIRE SHIP CONTROL SYSTEMS USE IS AUTHORIZED IN SUPPORT OF SEA TRIALS IN ACCORDANCE WITH THE SEA TRIAL AGENDA CONCURRED IN BY REF C AND APPROVED BY REF D. THERE ARE NO FLY-BY-WIRE SHIP CONTROL SYSTEMS or SHIP RELATED OPERATING RESTRICTIONS/LIMITS WHICH HAVE NOT BEEN SATISFIED. <or identify operating restrictions/limits>//
 5. THIS CERTIFICATION IS VALID THROUGHOUT TRIALS UNLESS A DEFICIENCY HAS BEEN DISCOVERED. SHIP SPEED IS RESTRICTED TO 20 KNOTS OR LESS WHEN AN FBW SCS FAULT CONDITION RESULTS IN A MAJOR NON-CONFORMANCE AFFECTING CONTROL OF SHIPS PITCH, HEADING, DEPTH OR CONTROL SURFACES. THESE DEFICIENCIES SHALL BE REPORTED TO NAVSEA AND THE APPROPRIATE FLEET AND TYPE COMMANDERS. PREVIOUS NAVSEA CERTIFICATION OF THE FBW SCS MATERIAL CONDITION SHALL BE SUSPENDED UNTIL NAVSEA REVIEWS THE REPORT AND CERTIFIES TO THE TYCOM THAT THE FBW SCS MATERIAL CONDITION IS SATISFACTORY FOR SEA TRIALS IN ACCORDANCE WITH THE SEA TRIAL AGENDA APPROVED BY REF D. THE SHIP'S SPEED IS RESTRICTED TO 20 KNOTS OR LESS UNTIL SATISFACTORY

RESOLUTION OF THE MAJOR NON-CONFORMANCE AND TYCOM APPROVAL TO OPERATE THE FBW SCS TO PREVIOUSLY AUTHORIZED CONDITIONS IS GRANTED, UNLESS SPECIFICALLY ADDRESSED IN THE SEA TRIAL AGENDA..//
BT

NOTE: ENSURE MESSAGES ARE IN ACCORDANCE WITH CURRENT MESSAGE FORMAT AND CURRENT PLAD IS UTILIZED.

APPENDIX BS

SAMPLE ISIC MESSAGE TO TYCOM CONCERNING FLY-BY-WIRE MATERIAL CERTIFICATION
UPON COMPLETION OF AT-SEA TESTING OR SEA TRIALS

(SUBMARINES ONLY)

FM COMSUB<RON/GRU NO.>//
 TO COMSUB<LANT/PAC> <NORFOLK VA/PEARL HARBOR HI>//
 INFO CNO WASHINGTON DC//
 COMNAVSEASYS COM WASHINGTON DC//
 PEO SUB WASHINGTON DC//
 COMSUBGRU <NO.>//
 COM<LANT/PAC>FLT <NORFOLK VA/PEARL HARBOR HI> //
 NAVSURFWARCEN CARDEROCKDIV BETHESDA MD//
 COMREGSUPPGRU <CITY ST>//
 <SUPERVISING AUTHORITY>//<CODES>// (IF APPLICABLE)
 USS < SHIP NAME/HULL NO>//
 BT
 UNCLAS //N04790//
 MSGID/GENADMIN/COMSUB<RON/GRU NO.>//
 SUBJ/ USS < SHIP NAME/HULL NO> FLY-BY-WIRE SHIP CONTROL SYSTEMS/(FBW SCS) AT-SEA
 TESTING COMPLETION//
 REF/A/MSG/COMSUB<RON/GRU NO.>/<DTG>//
 REF/B/MSG/ USS < SHIP NAME/HULL NO>/<DTG>//
 REF/C/DOC/NAVSEA/-//
 NARR/REF A IS COMSUB<RON/GRU NO.> MESSAGE ADDRESSING FBW SCS
 MATERIAL CERTIFICATION AND READINESS FOR AT-SEA OPERATION. REF B IS USS < SHIP
 NAME/HULL NO> MESSAGE ADDRESSING COMPLETION OF AT-SEA TESTING FOR FBW SCS. REF C
 IS FBW MANUAL T9044-AD-MAN-010.//
 RMKS/1. PER REF B ISIC CERTIFIES USS < SHIP NAME/HULL NO> FBW SCS
 AT-SEA TESTING IS COMPLETED SATISFACTORILY.
 2. THERE ARE NO CONDITIONAL FBW SCS DEPARTURE FROM SPECIFICATIONS OR DEVIATIONS
 AND WAIVERS THAT HAVE NOT BEEN SATISFIED.
 3. THE FOLLOWING SEA TRIALS DEFICIENCIES WERE NOTED AND REQUIRE CORRECTION OR
 HAVE BEEN CORRECTED:
 <NONE OR LIST DEFICIENCIES AND INDICATE IF CORRECTIVE ACTION IS REQUIRED>.
 4. THE FOLLOWING RESTRICTIONS ARE IN EFFECT:
 <NONE OR LIST DEFICIENCIES>.
 5. THE FBW SCS MATERIAL CONDITION OF THOSE PARTS OF THE SHIP INSTALLED, REPAIRED AND
 TESTED BY THE ISEA AND ACTIVITIES PERFORMING WORK IS SATISFACTORY. ISIC CONCURS
 WITH ISEA'S RECOMMENDATION THAT THE MATERIAL CONDITION IS SATISFACTORY FOR
 UNRESTRICTED OPERATION.
 6. REQUEST TYCOM APPROVAL FOR FBW SCS USE IN SUPPORT OF UNRESTRICTED
 OPERATION.//
 BT

**NOTE: ENSURE MESSAGES ARE IN ACCORDANCE WITH CURRENT MESSAGE FORMAT AND
CURRENT PLAD IS UTILIZED.**

(This Page Intentionally Left Blank)

APPENDIX BT

SAMPLE TYCOM MESSAGE TO SHIP CONCERNING URO FOR FLY-BY-WIRE SHIP CONTROL SYSTEMS

(SUBMARINES ONLY)

NOTE: IF NAVSEA DID NOT PERFORM A CERTIFICATION AUDIT, REF A WILL BE FROM COMSUB<RON/GRU> NO. AND REF C WILL BE DELETED.

FM COMSUB<LANT/PAC> <NORFOLK VA/PEARL HARBOR HI>//
 TO USS <SHIP NAME>//
 INFO CNO WASHINGTON DC//
 COMNAVSEASYS COM WASHINGTON DC//
 COM<LANT/PAC>FLT <NORFOLK VA/PEARL HARBOR HI>//
 <DIRSSP WASHINGTON DC FOR SSBN>//
 COMSUBGRU <NO.>//
 COMSUBRON <NO.>//
 <SUPERVISING AUTHORITY>//

BT

UNCLAS //N09094//

MSGID/GENADMIN/COMSUB<LANT/PAC>//

SUBJ/ (SUBS) UNRESTRICTED USE OF USS < SHIP NAME/HULL NO> FLY-BY-WIRE SHIP CONTROL SYSTEMS IN SUPPORT OF SUBMARINE UNRESTRICTED OPERATION//

REF/A/MSG/COMNAVSEASYS COM/<DTG>//

REF/B/DOC/NAVSEA T9044-AD-MAN-010/-//

[IF APPLICABLE] REF/C/MSG/COMSUB<RON/GRU> NO./<DTG>//

NARR/REF A IS NAVSEA MSG FOR UNRESTRICTED USE OF USS <SHIP NAME/HULL NO.> FLY-BY-WIRE SHIP CONTROL SYSTEMS IN SUPPORT OF SUBMARINE UNRESTRICTED OPERATIONS. REF B IS THE REQUIREMENTS MANUAL FOR SUBMARINE FLY-BY-WIRE SHIP CONTROL SYSTEMS. REF C IS ISIC FLY-BY-WIRE MATERIAL CERTIFICATION UPON COMPLETION OF AT-SEA TESTING OR SEA TRIALS//

RMKS/1. REF A CERTIFIED THE MATERIAL CONDITION OF THOSE PARTS OF USS < SHIP NAME/HULL NO> FLY-BY-WIRE SHIP CONTROL SYSTEMS INSTALLED, REPAIRED AND/OR TESTED BY THE SHIPYARD IS SATISFACTORY AND RECOMMENDED UNRESTRICTED USE OF USS <SHIP NAME/HULL NO.> FLY-BY-WIRE SHIP CONTROL SYSTEMS IN SUPPORT OF SUBMARINE UNRESTRICTED OPERATIONS.

2. <TYCOM> CONFIRMS THAT CERTIFICATION OF THE REMAINDER OF ITEMS NOT COVERED BY REF A WITHIN THE FLY-BY-WIRE SHIP CONTROL SYSTEMS CERTIFICATION BOUNDARY HAS BEEN SUSTAINED. ACCORDINGLY, USS <SHIP NAME/HULL NO.> IS AUTHORIZED UNRESTRICTED USE OF THEIR FLY-BY-WIRE SHIP CONTROL SYSTEMS IN SUPPORT OF SUBMARINE UNRESTRICTED OPERATIONS, SUBJECT TO THE FOLLOWING RESTRICTIONS: <list restrictions if they exist or state "NONE">.

3. CONTINUED CERTIFICATION FOR UNRESTRICTED USE OF THE FLY-BY-WIRE SHIP CONTROL SYSTEMS IN SUPPORT OF SUBMARINE UNRESTRICTED OPERATION IS SUBJECT TO COMPLIANCE WITH REF B.//.//

4. RECOMMENDATION FOR SHIP'S UNRESTRICTED OPERATION TO TEST DEPTH WILL BE ADDRESSED BY SEPARATE CORRESPONDENCE.

BT

NOTE: ENSURE MESSAGES ARE IN ACCORDANCE WITH CURRENT MESSAGE FORMAT AND CURRENT PLAD IS UTILIZED.

(This Page Intentionally Left Blank)

APPENDIX CA
SAMPLE SRDRS SUPPORT SERVICES MESSAGE
FOR INDUSTRIAL ACTIVITY AVAILABILITIES GREATER THAN
SIX MONTHS DURATION
(SUBMARINES ONLY)

FM COMSUB<LANT/PAC> <NORFOLK VA/PEARL HARBOR HI>//
 TO COMSUBRON ELEVEN//
 (COMSUB SQD/GRP (ISIC))//
 USS (Sea Trial Unit)//
 USNS <SRDRS SUPPORT SHIP>
 USS (SHIP NAME)/(ESCORT)
 USS <BACKUP ESCORT SHIP>
 USS <MOORING SUPPORT SHIP>
 INFO CNO WASHINGTON DC//
 COMNAVSEASYS COM WASHINGTON DC (as applicable)//
 COM<LANT/PAC>FLT <NORFOLK VA/PEARL HARBOR HI>//
 COMSUBPAC PEARL HARBOR HI//
 COMSUBLANT NORFOLK VA//
 COMSECOND/THIRD>FLT//
 COMNAVSURF<LANT/PAC> NORFOLK VA/SAN DIEGO CA//
 COMSEALOG<LANT/PAC> <NORFOLK VA/SAN DIEGO CA>
 (SUPERVISING AUTHORITY)//
 CTF TWO SIX/THREE FOUR//
 CTF <26.1/34.1/34.2/34.3 (as applicable)>//
 UNSEARESCOM SAN DIEGO CA//
 COMSUBGRU<NINE/TEN> {For SSBN/SSGN only}
 DIRSSP WASHINGTON DC// {For SSBN/SSGN only}
 <MOORING SUPPORT SHIP ISIC>
 <ESCORT SHIP ISIC>
 BT
 UNCLAS //N03120//
 MSGID/GENADMIN/COMSUB<LANT/PAC>//
 SUBJ/(SUBS) SUBMARINE SEA TRIAL SUPPORT SERVICES//
 REF/A/DOC/COMUSFLTFORCOM/<DATE>//
 AMPN/REF A IS COMUSFLTFORCOMINST 4790.3, JOINT FLEET MAINTENANCE MANUAL.//
 RMKS/1. IAW REF A THE FOLLOWING ASSIGNMENTS APPLY FOR (STRL UNIT NAME AND HULL NO.) SEA
 TRIALS OCCURRING DD-DDMMMSHIP ASSIGNMENTS BELOW ARE FOR PLANNING AND
 COORDINATION PURPOSES AND WILL BE IN EFFECT PENDING ISIC APPROVAL.

- A. SRDRS SUPPORT SHIP - USNS <NAME>
- B. RESCUE PORT - <PORT FROM WHICH CONDUCTING SEA TRIALS>
- C. RESCUE PORT REPRESENTATIVE - COMSUBRON <ISIC of Sea Trial Unit>
- D. RESCUE AIRFIELD - <NAME OF AIRFIELD NEAR SEA TRIAL PORT>
- E. MOORING SUPPORT SHIP - USS <NAME> (ASSIGNED BY NUMBERED FLEET SEPCOR)
- F. GOLD DOLPHIN OBSERVER - (ASSIGNED BY ISIC)
- G. ESCORT VESSEL - USS <NAME> (ASSIGNED BY NUMBERED FLEET SEPCOR)
- H. BACKUP ESCORT VESSEL - USS <NAME> (ASSIGNED BY NUMBERED FLEET SEPCOR FOR
 NEW CONSTRUCTION TRIALS)
- I. TYCOM EMBARKED REP -

2. FOR COMSUBRON ELEVEN:

REQUEST SRDRS BE PLACED IN MOD-ALERT STATUS TO SUPPORT SEA TRIALS FOR USS <NAME> ON DD-DDMMM. IT IS ANTICIPATED ESCORT SERVICES AND SRDRS MOD-ALERT STATUS WILL BE REQUIRED THROUGH DD-MON.

3. FOR (STRL UNIT),

A. INCLUDE THE FOLLOWING INFO ADDEES ON FINAL TEST DEPTH DEEP DIVE CHECK REPORT/SITREP; COMSUBLANT NORFOLK VA, COMSUBPAC PEARL HARBOR HI, COMSUBRON ELEVEN, USNS <SRDRS SUPPORT SHIP>, USS <ESCORT SHIP>, USS <BACKUP ESCORT SHIP>, USS <MOORING SUPPORT SHIP>, UNSEARESCOM SAN DIEGO CA AND NSSC PEARL HARBOR HI (as applicable).

B. ONCE ESCORT, SRDRS SERVICES ARE NO LONGER REQUIRED, RELEASE IAW ISIC OPS DIRECTIVE.

4. DIRLAUTH ALCON FOR EVENT SCHEDULES AND SCHEDULE CHANGES//

BT

NOTE: ENSURE MESSAGES ARE IN ACCORDANCE WITH CURRENT MESSAGE FORMAT AND CURRENT PLAD IS UTILIZED.

APPENDIX CB

SAMPLE ISIC MESSAGE TO TYCOM CONCERNING CREW CERTIFICATION FOR INDUSTRIAL
ACTIVITY AVAILABILITIES GREATER THAN SIX MONTHS IN DURATION

(SUBMARINES ONLY)

FM COMSUB<RON/GRU NO.>
 TO COMSUB<LANT/PAC> <NORFOLK VA/PEARL HARBOR HI>//
 INFO <SUPERVISING AUTHORITY>//<CODES>//
 USS <SHIP NAME>
 COMSUBGRU <NO.>//
 COMNAVSEASYS COM WASHINGTON DC//
 BT
 UNCLAS//N09094//
 MSGID/GENADMIN/COMSUB<RON/GRU NO.>//
 SUBJ/(SUBS) USS <SHIP NAME/HULL NO.> CREW AND MATERIAL CERTIFICATION//
 REF/A/DOC/COMUSFLTFORCOM/<DATE>//
 REF/B/DOC/NAVSEA 0924-062-0010/<DATE>//
 REF/C/DOC/NAVSEA/<DATE>//
 REF/D/DOC/COMNAVSUBFORINST 8500.2/<DATE>//
 NARR/REF A IS COMUSFLTFORCOMINST 4790.3, JOINT FLEET MAINTENANCE MANUAL. REF B IS
 SUBMARINE SAFETY (SUBSAFE) REQUIREMENTS MANUAL. REF C IS NAVSEA URO MRC
 TECHNICAL MANUAL. REF D IS TACTICAL WEAPONS CERTIFICATION, PROFICIENCY AND
 MODERNIZATION.//
 RMKS/1. CREW CERTIFICATION CONDUCTED AND SATISFACTORILY COMPLETED IAW REF A.
 2. IAW REFS A AND B, COMSUB<RON/GRU NO.> CERTIFIES THE MATERIAL CONDITION SUBSAFE
 CERTIFICATION BOUNDARY OF <SHIP NAME/HULL NO.> INSTALLED, REPAIRED AND/OR TESTED BY
 FORCES AFLOAT IS SATISFACTORY FOR SEA TRIALS TO TEST DEPTH. ALL SUBSAFE
 CONTROLLED WORK PACKAGES ARE CLOSED. CERTIFICATION REQUIREMENTS OF REF B HAVE
 BEEN SUSTAINED FOR THE REMAINDER OF THE SUBSAFE CERTIFICATION BOUNDARY. ALL
 OTHER CONTROLLED WORK PERFORMED BY SHIP'S FORCE HAS BEEN COMPLETED AND
 SATISFACTORILY RETESTED AND THE APPROPRIATE WORK PACKAGES CLOSED.
 3. MATERIAL/SALVAGE CONDITION CERTIFIED READY FOR SEA UPON COMPLETION OF THE
 FOLLOWING CORRECTIVE ACTIONS:
 A.
 B.
 4. THERE ARE NO OUTSTANDING REC'S. THE FOLLOWING DEPARTURES FROM SPECIFICATION
 ARE CURRENTLY OUTSTANDING:
DEPARTURE NO. TYPE SYSTEM/COMPONENT RESTRICTION (IF ANY)
 A.
 B.
 5. ALL URO MRC AND MANDATORY TESTS/INSPECTIONS SPECIFIED IN REF B AND C HAVE BEEN
 ACCOMPLISHED OR VERIFIED TO BE WITHIN THE REQUIRED PERIODICITY.
 6. USS <SHIP NAME/HULL NO.> IS PROVISIONALLY CERTIFIED TO LOAD, HANDLE, STOW AND
 MAINTAIN EXERCISE WEAPONS IAW REF D.
 7. COMSUB<RON/GRU NO.> REPORTS READINESS OF USS <SHIP NAME/HULL NO.> FOR COMMENCEMENT
 OF FAST CRUISE. CO USS <SHIP NAME/HULL NO.> CONCURS.//
 8. SUBJECT TO SATISFACTORY COMPLETION OF FAST CRUISE AND RESOLUTION OF MANDATORY
 DEFICIENCIES COMSUB<RON/GRU NO.> CONSIDERS USS <SHIP NAME/HULL NO.> MATERIAL CONDITION
 READINESS SATISFACTORY FOR COMMENCEMENT OF SEA TRIALS.//
 BT

**NOTE: ENSURE MESSAGES ARE IN ACCORDANCE WITH CURRENT MESSAGE FORMAT AND
 CURRENT PLAD IS UTILIZED.**

(This Page Intentionally Left Blank)

APPENDIX CC
MAJOR TRIAL AND INSPECTION MILESTONES
FOR INDUSTRIAL ACTIVITY AVAILABILITIES GREATER THAN SIX MONTHS
DURATION

(SUBMARINES ONLY)

EVENT	COGNIZANCE	APPROXIMATE SCHEDULE	CORRESPONDING APPENDIX
A. Periodic Monitoring Inspections	ISIC/TYCOM Representative	Start to completion	
B. Pre-Criticality Inspection	ISIC/TYCOM Representative	Criticality/Integrated Propulsion Plant Test Program -6 weeks for NAVSEA 08 RSE (Pre-Crit) and -4 weeks for PORSE	
C. Pre-Criticality Examination in accordance with reference (s)	NAVSEA/Fleet Commander	Criticality/Integrated Propulsion Plant Test Program -4 weeks for NAVSEA 08 RSE (Pre-Crit) and -2 weeks for PORSE	
D. Fast Cruise, Sea Trials and Completion Prerequisites ("Countdown Message")	TYCOM	Sea Trials -90 days	Appendix CD
E. Approve Sea Trials Agenda	ISIC/TYCOM Representative NAVSEA for Propulsion Trials; Director Strategic Systems Project Office for Poseidon/TRIDENT Weapons Trials	Sea Trials -60 days	
F. SRDRS Support Message	ISIC	Sea Trials -45 days	Appendix CA
G. Phase I Crew Certification	ISIC/TYCOM Representative	Sea Trials -35 days	
H. Salvage Inspection	ISIC/TYCOM Representative	Sea Trials -28 days	
I. Escort Recommendation (Message)	ISIC/TYCOM Representative	Sea Trials -28 days	
J. Dock Trials	CO of Ship	Sea Trials -21 days	
K. Phase II Crew Certification and Material Inspection	ISIC/TYCOM Representative	Sea Trials -9 days	

EVENT	COGNIZANCE	APPROXIMATE SCHEDULE	CORRESPONDING APPENDIX
L. Audit Re-Entry Control, Departure from Specifications, URO MRCs (Formal Report Required)	ISIC/TYCOM Representative	Sea Trials -9 days	
M. Crew and Material Certification Message	ISIC/TYCOM Representative (Includes Events J & K)	Sea Trials -9 days	Appendix CB
N. Supervising Authority Message Verifying Material Condition Satisfactory for Fast Cruise	Supervising Authority	Sea Trials -9 days	Reference (x), Appendix B.3.1
O. Readiness for Fast Cruise	CO of Ship	Sea Trials -9 days	Appendix CJ
P. NAVSEA Message Certifying Systems Satisfactory for Sea Trials and Depth Authorization	NAVSEA	Sea Trials -9 days	Reference (x), Appendix B.3.2
Q. Message Certifying Crew and Material Readiness to NAVSEA/Authorize Ship to Commence Fast Cruise Upon Receipt of NAVSEA Permission to Conduct Critical Operations	TYCOM	Sea Trials -8 days	Appendix CE
R. Grant Permission to Conduct Critical Operations Message	NAVSEA	Sea Trials -7 days	
S. Commence Fast Cruise	CO of Ship	Sea Trials -7 days (2 days on, 1 off, 2 on)	
T. Report Completion of Fast Cruise and Ready for Sea Trials Message, CO concurs	Supervising Authority to TYCOM	Sea Trials -1 day	Reference (x), Appendix B.3.3
U. Report Ship Readiness for Sea Trials	CO of Ship	Sea Trials -1 day	Appendix CK
V. Update of material certification status for Sea Trials	ISIC	Sea Trials -1 day	Appendix CH
W. Authorization to Commence Sea Trials and Depth Authorization Message	TYCOM	Sea Trials -1 day	Appendix CF
X. Commence Sea Trials	CO of Ship	0	
Y. Daily Sea Trials SITREP/Status Report	Supervising Authority, TYCOM, CO of Ship	At Least Daily During Sea Trials	Appendix F
Z. Follow-on Sea Trials Completion Prerequisites	TYCOM	Initial Sea Trial Interruption Date day	Appendix CL
AA. Report of Readiness for Follow-On Sea Trials	Supervising Authority to NAVSEA	Follow-On Sea Trials - 1 day	Reference (x), Appendix B.3.5

EVENT	COGNIZANCE	APPROXIMATE SCHEDULE	CORRESPONDING APPENDIX
AB. NAVSEA SUBSAFE Material Condition and Depth Authorization for Follow-on Sea Trials	NAVSEA	Follow-On Sea Trials -1 day	Reference (x), Appendix B.3.6
AC Report Ship Readiness for Follow-On Sea Trials	CO of Ship	Follow-On Sea Trials -1 day	Appendix CN
AD. Update of Material Status prior to Follow-on Sea Trials.	ISIC	Follow-On Sea Trials -1 day	Appendix CM
AE. TYCOM Authorization to Commence Follow-On Sea Trials and Depth Authorization	TYCOM	Follow-On Sea Trials -1 day	Appendix CO
AF. Sea Trials Completion Message	Supervising Authority	+1 day After Sea Trials	Reference (x), Appendix B.3.8
AG. NAVSEA Message Certifying Ship satisfactory for URO	NAVSEA	+1 day After Sea Trials	Reference (x), Appendix B.3.9
AH. Report Material Condition of Ship Subsequent to Sea Trials	ISIC	+1 day After Sea Trials	Appendix CI
AI. URO Message	TYCOM	+1 day After Sea Trials	Appendix CG

- NOTES:**
1. **SEE PARAGRAPH 3.6.8.4.5 OF THIS CHAPTER FOR ADDITIONAL GUIDANCE CONCERNING ISIC/TYCOM REPRESENTATIVE CONDUCTED INSPECTIONS.**
 2. **IN THE EVENT THAT SEA TRIALS ARE ABORTED AND/OR AN ADDITIONAL SEA TRIAL BECOMES NECESSARY, A SPECIAL "COUNTDOWN MESSAGE" (APPENDIX CL OF THIS CHAPTER) SHALL BE INITIATED BY THE TYCOM.**
 3. **UNLESS OTHERWISE INDICATED, SCHEDULE DATES ARE REFERENCED TO SEA TRIALS UNDERWAY DATE.**

(This Page Intentionally Left Blank)

APPENDIX CD

**SAMPLE TYCOM MESSAGE TO SHIP CONCERNING COMPLETION
PREREQUISITES FOR AVAILABILITIES OF GREATER THAN
SIX MONTHS DURATION**

(SUBMARINES ONLY)

FM COMSUB<LANT/PAC> <NORFOLK VA/PEARL HARBOR HI>//
 TO USS <SHIP NAME>//
 COMSUB<RON/GRU NO.>//
 <SUPERVISING AUTHORITY>//<CODES>//
 INFO CNO WASHINGTON DC//
 COM<LANT/PAC>FLT <NORFOLK VA/PEARL HARBOR HI>//
 COMNAVSEASYSKOM WASHINGTON DC//
 DIRSSP WASHINGTON DC //{FOR SSBN/SSGN}
 <SUBOPAUTH>//{IF OTHER THAN PARENT TYCOM}
 COMSUBGRU <NO.>//
 COMSUBRON ELEVEN//
 BT
 UNCLAS//N09094//
 MSGID/GENADMIN/TYCOM//
 SUBJ/(SUBS) USS <SHIP NAME/HULL NO.> <TYPE AVAILABILITY> FAST CRUISE, SEA TRIAL AND
 COMPLETION PREREQUISITES//
 REF/A/DOC/COMUSFLTFORCOM/<DATE>//
 REF/B/DOC/NAVSEA/<DATE>//
 NARR/REF A IS COMUSFLTFORCOMINST 4790.3, JOINT FLEET MAINTENANCE MANUAL, VOLUME II.
 REF B IS NAVSEA 0924-062-0010, SUBMARINE SAFETY (SUBSAFE) REQUIREMENTS MANUAL//
 RMKS/1. REFS A AND B PRESCRIBE TYCOM AND NAVSEA REQUIREMENTS FOR INDUSTRIAL
 AVAILABILITY FAST CRUISE, SEA TRIAL AND COMPLETION.
 2. FOLLOWING REPORTS AND AUTHORIZATIONS ARE PREREQUISITES TO START OF FAST CRUISE:
 A. COMSUB<RON/GRU NO.> MSG TO TYCOM IAW REF A THAT CREW CERTIFICATION AND
 MATERIAL CONDITION IS SATISFACTORY FOR FAST CRUISE AND SEA TRIALS. {APPENDIX CB}.
 B. <SUPERVISING AUTHORITY> MSG TO NAVSEA AND TYCOM IAW REF B THAT MATERIAL CONDITION
 OF THOSE PARTS OF <SHIP NAME/HULL NO.> INSTALLED, REPAIRED AND/OR TESTED BY THE
 SHIPYARD ARE SATISFACTORY FOR POST <TYPE AVAILABILITY> TRIALS, INCLUDING CORRECTION
 OF ALL CAT I AUDIT RECOMMENDATIONS HAVE BEEN SATISFACTORILY RESOLVED.
 {REFERENCE B, APPENDIX B.3.1}
 C. CO, USS <SHIP NAME/HULL NO.> MSG TO TYCOM IAW REF A STATING THAT CREW AND SHIP ARE
 READY FOR SEA TRIALS, LISTING EXCEPTIONS SUCH AS COMPLETION OF FAST CRUISE.
 {APPENDIX CJ}
 D. NAVSEA (PMS 392) MSG TO TYCOM IAW REF B CERTIFYING MATERIAL CONDITION OF USS
 <SHIP NAME/HULL NO.> FOR SPECIFIC TRIAL OPERATING DEPTH. {REFERENCE B, APPENDIX B.3.2}
 E. TYCOM MSG TO NAVSEA 08 AND CO, USS <SHIP NAME/HULL NO.> IAW REF A REQUESTING NAVSEA
 AUTHORIZATION FOR CRITICAL REACTOR OPERATIONS AND GRANTING SHIP PERMISSION TO
 START FAST CRUISE UPON RECEIPT OF THIS AUTHORIZATION. {APPENDIX CE}
 F. NAVSEA 08 MSG AUTHORIZING CRITICAL REACTOR OPERATIONS FOR FAST CRUISE AND SEA
 TRIALS
 3. FOLLOWING REPORTS AND AUTHORIZATIONS ARE PREREQUISITES TO START OF SEA TRIALS:
 A. <SUPERVISING AUTHORITY> MSG TO TYCOM IAW REF B REPORTING COMPLETION OF FAST CRUISE
 AND READINESS FOR SEA TRIALS. {REFERENCE B, APPENDIX B.3.3}
 B. CO, USS <SHIP NAME/HULL NO.> MSG TO TYCOM IAW REF A AFTER COMPLETION OF FAST CRUISE
 REPORTING READINESS FOR SEA TRIALS. {APPENDIX CK}
 C. COMSUB<RON/GRU NO.> MSG TO TYCOM IAW REF A PROVIDING STATUS OF MATERIAL
 CONDITION CERTIFICATION SUBSEQUENT TO FAST CRUISE. {APPENDIX CH}

D. COMSUB<LANT/PAC> MSG TO CO, USS <SHIP NAME/HULL NO.> IAW REF A GRANTING PERMISSION TO PROCEED ON SEA TRIALS LISTING ANY OPERATIONAL RESTRICTIONS. {APPENDIX CF}

4. USS <SHIP NAME/HULL NO.> SEA TRIALS WILL BE UNDER OPCON OF <SUBOPAUTH>.

5. CO, USS <SHIP NAME/HULL NO.> IS REQUESTED TO PROVIDE SEA TRIAL SITREPS DAILY AND IDENTIFY ITEMS MANDATORY FOR CORRECTION PRIOR TO COMPLETION OF <TYPE AVAILABILITY>. {APPENDIX F}

6. IN THE EVENT SEA TRIALS ARE ABORTED OR CORRECTIVE ACTIONS FOR SEA TRIAL DEFICIENCIES REQUIRE AN ADDITIONAL DEEP DIVE, TYCOM WILL RELEASE ANOTHER PREREQUISITES COMPLETION MESSAGE PRIOR TO THE FOLLOW-ON SEA TRIALS. {APPENDIX CL}

7. FOLLOWING REPORTS AND AUTHORIZATIONS ARE PREREQUISITES TO CONDUCT OF SUBMERGED OPERATIONS AFTER <TYPE AVAILABILITY> COMPLETION:

A. <SUPERVISING AUTHORITY> MSG TO NAVSEA IAW REF B REPORTING SUBSAFE MATERIAL CONDITION TO SUPPORT URO. {REFERENCE B, APPENDIX B.3.8}

B. NAVSEA TO TYCOM MSG IAW REF B CERTIFYING MATERIAL CONDITION OF USS <SHIP NAME/HULL NO.> SATISFACTORY FOR UNRESTRICTED OPERATIONS TO DESIGN TEST DEPTH. {REFERENCE B, APPENDIX B.3.9}

C. COMSUB<RON/GRU NO.> MSG TO TYCOM IAW REF A REPORTING MATERIAL CONDITION OF SHIP AND URO MRC STATUS SUBSEQUENT TO SEA TRIALS. {APPENDIX CI}

D. TYCOM MSG TO CO, USS <SHIP NAME/HULL NO.> IAW REF B AUTHORIZING CONDUCT OF UNRESTRICTED OPERATIONS TO DESIGN TEST DEPTH. {APPENDIX CG}//

BT

NOTE: MESSAGES LISTED IN PARAGRAPHS 2 THROUGH 6 OF THIS APPENDIX SHOULD BE ASSIGNED APPROPRIATE PRECEDENCE AND PARALLELED BY TELEPHONE TO ACTION ADDEES CITING DATE-LINE GROUP OF FORTHCOMING MESSAGES. ALL ADDEES OF THIS MESSAGE ARE TO BE INCLUDED AS ADDEES ON THE MESSAGES LISTED IN PARAGRAPHS 2 THROUGH 6 OF THIS APPENDIX.

NOTE: ENSURE MESSAGES ARE IN ACCORDANCE WITH CURRENT MESSAGE FORMAT AND CURRENT PLAD IS UTILIZED.

APPENDIX CE

**SAMPLE TYCOM MESSAGE TO NAVSEA CONCERNING
FAST CRUISE AND CRITICAL REACTOR OPERATIONS FOR INDUSTRIAL ACTIVITY
AVAILABILITIES GREATER THAN SIX MONTHS IN DURATION**

(SUBMARINES ONLY)

FM COMSUB<LANT/PAC> <NORFOLK VA/PEARL HARBOR HI>//
 TO COMNAVSEASYS COM WASHINGTON DC//
 USS <SHIP NAME>//
 INFO CNO WASHINGTON DC//
 COM<LANT/PAC>FLT <NORFOLK VA/PEARL HARBOR HI>//
 DIRSSP WASHINGTON DC// {For SSBN/SSGN Only}
 COMSUBRON ELEVEN//
 COMSUBGRU <NO.>//
 COMSUB<RON/GRU NO.>//
 <SUPERVISING AUTHORITY>//<CODES>//
 BT
 UNCLAS //N09094//
 MSGID/GENADMIN/<TYCOM>//
 SUBJ/(SUBS) FAST CRUISE FOR USS <SHIP NAME/HULL NO.>//
 REF/A/RMG/COMSUB<RON/GRU NO.>/<DTG>/NOTAL//{APPENDIX CB}
 REF/B/RMG/<SUPERVISING AUTHORITY>/<DTG>//
 REF/C/RMG/NAVSEA/<DTG>//
 REF/D/RMG/USS <SHIP>/<DTG>//{APPENDIX CJ}
 NARR/REF A IS ISIC MSG TO TYCOM ON CREW CERT. REF B IS <SUPERVISING AUTHORITY> TO NAVSEA
 AND TYCOM ON SUBSAFE AND MATERIAL CONDITION READINESS. REF C IS NAVSEA MSG TO
 TYCOM ON SUBSAFE MATERIAL CONDITION READINESS AND DEPTH RECOMMENDATION FOR
 SEA TRIALS. REF D IS USS <SHIP'S NAME/HULL NO.> MSG TO COMMENCE FAST CRUISE.
 RMKS/1. REFS A, B AND C REPORTED SATISFACTORY COMPLETION OF CREW/MATERIAL
 CERTIFICATION TO SUPPORT FAST CRUISE AND SEA TRIALS. REF D REPORTED SHIP AND CREW
 READY TO PROCEED ON SEA TRIALS WITH EXCEPTIONS NOTED AND REQUESTED PERMISSION TO
 COMMENCE FAST CRUISE.
 2. FOR NAVSEA 08: REQUEST AUTHORIZATION FOR USS <SHIP NAME/HULL NO.> TO CONDUCT
 CRITICAL REACTOR OPERATIONS FOR FAST CRUISE AND SEA TRIALS.
 3. FOR CO USS <SHIP NAME.>: PERMISSION GRANTED TO START FAST CRUISE UPON RECEIPT OF
 NAVSEA AUTHORIZATION TO TAKE REACTOR CRITICAL//

BT

**NOTE: ENSURE MESSAGES ARE IN ACCORDANCE WITH CURRENT MESSAGE FORMAT AND
CURRENT PLAD IS UTILIZED.**

(This Page Intentionally Left Blank)

APPENDIX CF

SAMPLE TYCOM MESSAGE TO SHIP CONCERNING SEA TRIALS DEPTH AUTHORIZATION
FOR INDUSTRIAL ACTIVITY AVAILABILITIES GREATER THAN SIX MONTHS IN DURATION

(SUBMARINES ONLY)

FM COMSUB<LANT/PAC> <NORFOLK VA/PEARL HARBOR HI>//
 TO USS <SHIP NAME>//
 INFO CNO WASHINGTON DC//
 COMNAVSEASYS COM WASHINGTON DC//
 <LANT/PAC>FLT <NORFOLK VA/PEARL HARBOR HI>//
 <DIRSSP WASHINGTON DC FOR SSBN>//
 COMSUBGRU <NO.>//
 COMSUBRON <NO.>//
 <SUPERVISING AUTHORITY>//
 BT
 UNCLAS //N09094//
 MSGID/GENADMIN/COMSUB<LANT/PAC>//
 SUBJ/(SUBS) USS <SHIP NAME/HULL NO.> SEA TRIALS DEPTH AUTHORIZATION//
 REF/A/MSG/COMNAVSEASYS COM/<DTG>/{B.3.2}
 REF/B/MSG/SUPERVISING AUTHORITY/<DTG>/{B.3.3}
 REF/C/LTR/NAVSEA <SER NO./DATE>//
 REF/D/LTR/COMSUB<LANT/PAC>/<SER NO./DATE>//
 NARR/REF A IS NAVSEA SUBSAFE MATERIAL CONDITION READINESS REPORT AND SEA TRIALS
 DEPTH RECOMMENDATION FOR USS <SHIP NAME/HULL NO.>. REF B IS <SUPERVISING AUTHORITY>
 REPORT OF USS <SHIP NAME/HULL NO.> FAST CRUISE COMPLETION AND READINESS FOR SEA
 TRIALS. REF C CONCURRED IN THE SEA TRIAL AGENDA FOR USS <SHIP NAME/HULL NO.>. REF D
 APPROVED THE SEA TRIAL AGENDA FOR USS <SHIP NAME/HULL NO.>./.
 RMKS/1. REF A CERTIFIED THE SUBSAFE MATERIAL CONDITION OF THOSE PARTS OF USS <SHIP
 NAME/HULL NO.> INSTALLED, REPAIRED AND/OR TESTED BY THE SHIPYARD IS SATISFACTORY FOR
 SEA TRIALS TO TEST DEPTH.
 2. THIS MESSAGE CONFIRMS THAT THE CERTIFICATION OF THE REMAINDER OF ITEMS WITHIN
 THE SUBSAFE CERTIFICATION BOUNDARY OF USS <SHIP NAME/HULL NO.> HAS BEEN SUSTAINED.
 ACCORDINGLY, THE STATUS OF THE SUBSAFE CERTIFICATION BOUNDARY OF USS <SHIP NAME/HULL
 NO.> IS SATISFACTORY FOR SEA TRIALS TO TEST DEPTH <SUBJECT TO ANY RESTRICTIONS IN PARA 2
 OF REF A if any are identified>.
 3. REF B REPORTED COMPLETION OF FAST CRUISE AND READINESS TO PROCEED ON SEA TRIALS.
 4. USS <SHIP NAME/HULL NO.> IS AUTHORIZED TO DIVE UNDER DELIBERATE AND CONTROLLED
 CONDITIONS TO <SPECIFIED> DEPTH IAW THE SEA TRIAL AGENDA CONCURRED IN BY REF C AND
 APPROVED BY REF D./.
 5. EXCEPT AS LISTED IN 6. BELOW, THIS DEPTH AUTHORIZATION IS AUTOMATICALLY
 SUSPENDED UPON RE-ENTRY TO THE SUBSAFE CERTIFICATION BOUNDARY OR CASUALTY
 AFFECTING RECOVERABILITY, SALVAGE, WATERTIGHT INTEGRITY OR OPERATION OF SHIP'S
 CONTROL SURFACES. THE SHIP SHALL NOT OPERATE AT A DEPTH GREATER THAN 200 FEET
 UNTIL RE-ENTRY IS CERTIFIED TO TYCOM AND TYCOM GRANTS APPROVAL TO OPERATE TO
 PREVIOUSLY AUTHORIZED DEPTH.
 6. RE-ENTRY CONTROL TO ADJUST FLOOD CONTROL HYDRAULIC VALVE TIMING WILL BE
 CERTIFIED BY THE COMMANDING OFFICER, TYCOM CERTIFICATION IS NOT REQUIRED, AND A
 SITREP WILL BE TRANSMITTED PRIOR TO RESUMPTION OF OPERATION BELOW 200 FEET.
 7. AT THE CONCLUSION OF SEA TRIALS, THE SHIP SHALL NOT OPERATE AT DEPTHS GREATER
 THAN ONE-HALF TEST DEPTH PLUS FIFTY FEET UNTIL RECEIPT OF THE URO AUTHORIZATION
 MESSAGE FROM THE TYCOM.

8. ALL SEA TRIALS SITREPS ARE TO BE SENT USING IMMEDIATE PRECEDENCE.//
BT

**NOTE: ENSURE MESSAGES ARE IN ACCORDANCE WITH CURRENT MESSAGE FORMAT AND
CURRENT PLAD IS UTILIZED.**

APPENDIX CG

SAMPLE TYCOM MESSAGE TO SHIP CONCERNING URO FOR INDUSTRIAL ACTIVITY
AVAILABILITIES GREATER THAN SIX MONTHS IN DURATION

(SUBMARINES ONLY)

FM COMSUB<LANT/PAC> <NORFOLK VA/PEARL HARBOR HI>//
 TO USS <SHIP NAME>//
 INFO CNO WASHINGTON DC//
 COMNAVSEASYS COM WASHINGTON DC//
 <LANT/PAC>FLT<NORFOLK VA/PEARL HARBOR HI>//
 <DIRSSP WASHINGTON DC FOR SSBN>//
 COMSUBGRU <NO.>//
 COMSUBBRON <NO.>//
 <SUPERVISING AUTHORITY>//
 BT
 UNCLAS //N09094//
 MSGID/GENADMIN/COMSUB<LANT/PAC>//
 SUBJ/(SUBS) UNRESTRICTED OPERATION OF USS <SHIP NAME/HULL NO.>//
 REF/A/MSG/COMNAVSEASYS COM/<DTG>// {B.3.9}
 REF/B/MSG/ISIC/<DTG>//
 REF/C/DOC/NAVSEA 0924-062-0010//
 REF/D/DOC/COMSUB<LANT/PAC>NOTE C3120//
 NARR/REF A IS NAVSEA URO MSG FOR USS <SHIP NAME/HULL NO.>. REF B IS ISIC SEA TRIAL
 MATERIAL CERTIFICATION MSG FOR USS <SHIP NAME/HULL NO.>. REF C IS THE SUBSAFE
 REQUIREMENTS MANUAL. REF D CONTAINS TYCOM AUTHORIZED SUBMARINE OPERATING AND
 TEST DEPTHS.//
 RMKS/1. REF A CERTIFIED THE SUBSAFE MATERIAL CONDITION OF THOSE PARTS OF USS <SHIP
 NAME/HULL NO.> INSTALLED, REPAIRED, AND/OR TESTED BY THE SHIPYARD IS SATISFACTORY AND
 RECOMMENDED THAT USS <SHIP NAME/HULL NO.> BE AUTHORIZED TO CONDUCT UNRESTRICTED
 OPERATIONS TO TEST DEPTH.
 2. IAW REF B <TYCOM> CONFIRMS THAT CERTIFICATION OF THE REMAINDER OF ITEMS NOT
 COVERED BY REF A WITHIN THE SUBSAFE CERTIFICATION BOUNDARY HAS BEEN SUSTAINED.
 ACCORDINGLY, USS <SHIP NAME/HULL NO.> IS AUTHORIZED TO CONDUCT OPERATIONS TO
 <SPECIFIED> DEPTH, SUBJECT TO THE FOLLOWING RESTRICTIONS: <list restrictions if they exist or state
 "NONE">.
 3. CONTINUED CERTIFICATION FOR OPERATIONS TO TEST DEPTH IS SUBJECT TO COMPLIANCE
 WITH REF C. URO MRC PERIODICITIES COMMENCE ON <DATE>.
 4. THIS MESSAGE REMAINS IN EFFECT UNTIL INCLUDED IN A FUTURE REVISION OF REF D.//
 BT

**NOTE: ENSURE MESSAGES ARE IN ACCORDANCE WITH CURRENT MESSAGE FORMAT AND
CURRENT PLAD IS UTILIZED.**

(This Page Intentionally Left Blank)

APPENDIX CH

**SAMPLE ISIC MESSAGE TO TYCOM CONCERNING
MATERIAL CERTIFICATION PRIOR TO SEA TRIALS FOR INDUSTRIAL ACTIVITY
AVAILABILITIES GREATER THAN SIX MONTHS IN DURATION**

(SUBMARINES ONLY)

FM COMSUB<RON/GRU NO.>//
 TO COMSUB<LANT/PAC> <NORFOLK VA/PEARL HARBOR HI>//
 INFO COMSUBRON ELEVEN//
 COMSUBGRU <NO.>//
 USS <SHIP NAME>//
 BT
 UNCLAS //N09094//
 GENADMIN/COMSUB<RON/GRU NO.>//
 SUBJ/(SUBS) USS <SHIP NAME/HULL NO.> MATERIAL CERTIFICATION/ READINESS FOR SEA TRIALS//
 REF/A/RMG/COMSUB<LANT/PAC><DTG>// {APPENDIX CD}
 REF/B/DOC/COMUSFLTFORCOM/<DATE>//
 REF/C/RMG/COMSUB<RON/GRU NO.><DTG>/NOTAL// {APPENDIX CB}
 REF/D/DOC/NAVSEA /<DATE>//
 NARR/REF A IS TYCOM MSG TO USS <SHIP'S NAME/HULL NO.> ON COMPLETION PREREQUISITES FOR
 AVAILABILITIES GREATER THAN SIX MONTHS. REF B IS COMUSFLTFORCOMINST 4790.3, JOINT
 FLEET MAINTENANCE MANUAL, VOLUME II. REF C IS COMSUB<RON/GRU NO.> MSG TO TYCOM ON
 CREW CERT. REF D IS NAVSEA 0924-062-0010, SUBMARINE SAFETY (SUBSAFE) REQUIREMENTS
 MANUAL.
 RMKS/1. IAW REFS A AND B, THIS MSG CERTIFIES THAT NO MANDATORY DEFICIENCIES FOR SEA
 TRIALS HAVE BEEN IDENTIFIED. THERE HAVE BEEN NO RECS OPENED AND NO SUBSAFE
 DEPARTURES FROM SPECIFICATION PROCESSED SINCE THE START OF FAST CRUISE. <OR, REPORT
 ANY MANDATORY DEFICIENCIES DISCOVERED WITH CORRECTIVE ACTION, AND IF RECS AND/OR DEPARTURES FROM
 SPECIFICATIONS WERE PROCESSED SINCE THE START OF FAST CRUISE, REPORT ALL RECS OPENED SINCE THE START OF
 FAST CRUISE ARE CLOSED AND/OR ALL SUBSAFE DEPARTURES FROM SPECIFICATIONS PROCESSED SINCE THE START OF
 FAST CRUISE ARE RESOLVED ^(NOTE 1.)>
 2. THERE ARE NO SUBSAFE DEPARTURES FROM SPECIFICATIONS WITH CONDITIONS WHICH
 HAVE NOT BEEN SATISFIED. THE FOLLOWING ADDITIONAL DEPARTURES FROM SPECIFICATIONS
 WERE GENERATED SUBSEQUENT TO REF C.
DEPARTURE NO. TYPE SYSTEM/COMPONENT RESTRICTION (IF ANY)
 A.
 B.
 3. REQUEST PERMISSION TO COMMENCE SEA TRIALS. CO <SHIP NAME> CONCURS.//
 BT

**NOTE 1: LIST ALL RE-ENTRIES TO MATERIAL CERTIFICATION BOUNDARY AND ALL WORK
ON SYSTEMS AFFECTING RECOVERABILITY, SALVAGE, WATERTIGHT INTEGRITY,
OR OPERATION OF SHIP'S CONTROL SURFACES WITH CORRECTIVE ACTION SINCE
RELEASE FOR FAST CRUISE MESSAGE.**

**NOTE: ENSURE MESSAGES ARE IN ACCORDANCE WITH CURRENT MESSAGE FORMAT AND
CURRENT PLAD IS UTILIZED.**

(This Page Intentionally Left Blank)

APPENDIX CI

**SAMPLE ISIC MESSAGE TO TYCOM CONCERNING MATERIAL CERTIFICATION UPON
COMPLETION OF SEA TRIALS FOR INDUSTRIAL ACTIVITY AVAILABILITIES GREATER THAN
SIX MONTHS IN DURATION**

(SUBMARINES ONLY)

FM COMSUB<RON/GRU NO.>//
 TO COMSUB<LANT/PAC> <NORFOLK VA/PEARL HARBOR HI>//
 INFO COMSUBRON ELEVEN//
 COMSUBGRU<NO.>//
 USS <SHIP NAME>//
 BT
 UNCLAS //N09094//
 GENADMIN/COMSUB<RON/GRU NO.>//
 SUBJ/(SUBS) USS <SHIP NAME/HULL NO.>MATERIAL CERTIFICATION//
 REF/A/MSG/<SUPERVISING AUTHORITY>//
 REF/B/MSG/<TYCOM>/<DTG>/{APPENDIX CD}
 REF/C/DOC/COMUSFLTFORCOM/<DATE>//
 REF/D/DOC/NAVSEA/<DATE>//
 REF/E/DOC/NAVSEA/<DATE OF CURRENT REVISION>//
 NARR/REF A IS <SUPERVISING AUTHORITY> REPORT CONCERNING SUBSAFE MATERIAL CONDITION TO
 SUPPORT URO. REF B IS THE TYCOM MSG TO USS <SHIP'S NAME/HULL NO.> ON COMPLETION
 PREREQUISITES FOR AVAILABILITIES GREATER THAN SIX MONTHS. REF C IS
 COMUSFLTFORCOMINST 4790.3, JOINT FLEET MAINTENANCE MANUAL, VOLUME II. REF D IS
 NAVSEA 0924-062-0010, SUBMARINE SAFETY (SUBSAFE) REQUIREMENTS MANUAL. REF E IS
 NAVSEA, URO REQUIREMENTS MANUAL.
 RMKS/1. IAW REF A THE <SUPERVISING AUTHORITY> REPORTED THE SATISFACTORY COMPLETION OF
 ALL SEA TRIALS, COMPLETION OF CONTROLLED DIVES, AND THE RESOLUTION OF MANDATORY
 SEA TRIAL DEFICIENCIES. IAW WITH REFS B AND C THERE IS NO DEFERRED SUBSAFE WORK AND
 THERE ARE NO SUBSAFE DEPARTURES FROM SPECIFICATIONS WITH CONDITIONS WHICH HAVE
 NOT BEEN SATISFIED. <OR, REPORT ANY FORCES AFLOAT ASSIGNED DEFERRED SUBSAFE WORK AND/OR
 OUTSTANDING CONDITIONAL DEPARTURES FORM SPECIFICATIONS INCLUDING DEPARTURE NUMBER, SHORT TITLE AND
 CALCULATED COMPLETION DATE.>
 2. THIS MESSAGE CERTIFIES THAT ALL WORK ACCOMPLISHED BY FORCES AFLOAT WITHIN THE
 SUBSAFE CERTIFICATION BOUNDARY SINCE CERTIFICATION FOR SEA TRIALS HAS BEEN
 SATISFACTORILY COMPLETED AND RETESTED IAW REF C. CERTIFICATION REQUIREMENTS OF
 REF D HAVE BEEN SUSTAINED FOR THE REMAINDER OF THE SUBSAFE CERTIFICATION
 BOUNDARY. <LIST ALL RE-ENTRIES TO MATERIAL CERTIFICATION BOUNDARY AND ALL WORK ON SYSTEMS
 AFFECTING RECOVERABILITY, SALVAGE, WATERTIGHT INTEGRITY, OR OPERATION OF SHIP'S CONTROL SURFACES WITH
 CORRECTIVE ACTION SINCE RELEASE FOR FAST CRUISE MESSAGE.>
 3. ALL URO MRC MANDATORY TESTS/INSPECTIONS SPECIFIED IN REF E HAVE BEEN
 ACCOMPLISHED OR VERIFIED TO BE WITHIN THE REQUIRED PERIODICITY.//
 BT

NOTE: LIST ALL RE-ENTRIES TO MATERIAL CERTIFICATION BOUNDARY AND ALL WORK ON SYSTEMS AFFECTING RECOVERABILITY, SALVAGE, WATERTIGHT INTEGRITY, OR OPERATION OF SHIP'S CONTROL SURFACES WITH CORRECTIVE ACTION SINCE RELEASE FOR FAST CRUISE MESSAGE.

NOTE: ENSURE MESSAGES ARE IN ACCORDANCE WITH CURRENT MESSAGE FORMAT AND CURRENT PLAD IS UTILIZED.

(This Page Intentionally Left Blank)

APPENDIX CJ

SAMPLE SHIP MESSAGE TO TYCOM CONCERNING READINESS FOR FAST CRUISE FOR INDUSTRIAL ACTIVITY AVAILABILITIES GREATER THAN SIX MONTHS IN DURATION

(SUBMARINES ONLY)

FM USS <SHIP NAME>//
 TO COMSUB<LANT/PAC> <NORFOLK VA/PEARL HARBOR HI>//
 INFO CNO WASHINGTON DC//
 COM<LANT/PAC>FLT <NORFOLK VA/PEARL HARBOR HI>//
 COMNAVSEASYS COM WASHINGTON DC//
 DIRSSP WASHINGTON DC// {For SSBN/SSGN Only}
 <SUBOPAUTH>// {IF OTHER THAN PARENT TYCOM}
 COMSUBRON ELEVEN//
 COMSUBGRU <NO.>//
 COMSUB<RON/GRU NO.>//
 <SUPERVISING AUTHORITY>//<CODES>//
 BT
 UNCLAS //N09094//
 MSGID/GENADMIN/USS <SHIP NAME>//
 SUBJ/(SUBS) USS <SHIP NAME/HULL NO.> READINESS FOR FAST CRUISE//
 REF/A/RMG/<SUPERVISING AUTHORITY>/<DTG>//
 REF/B/RMG/COMSUB<RON/GRU NO.>/<DTG>//{ APPENDIX CB }
 REF/C/DOC/COMUSFLTFORCOM/<DATE>//
 REF/D/RMG/<TYCOM>/<DTG>//{ APPENDIX CD }
 NARR/ REF A IS <SUPERVISING AUTHORITY> REPORT OF READINESS FOR FAST CRUISE AND SEA TRIALS. REF B IS COMSUB<RON/GRU NO.> REPORT OF READINESS FOR FAST CRUISE AND SEA TRIALS. REF C IS COMUSFLTFORCOMINST 4790.3, JOINT FLEET MAINTENANCE MANUAL, VOLUME II. REF D IS TYCOM MSG TO USS <SHIP'S NAME/HULL NO.> ON COMPLETION PREREQUISITES FOR AVAILABILITIES GREATER THAN SIX MONTHS.
 1. REFS A AND B REPORTED READINESS OF SHIP FOR FAST CRUISE AND SEA TRIALS. IAW REFS C AND D, USS <SHIP NAME/HULL NO.> AND CREW ARE READY FOR SEA TRIALS WITH THE FOLLOWING EXCEPTIONS:
 A. COMPLETION OF FAST CRUISE.
 B. REMOVAL OF SHORE SERVICE CONNECTIONS.
 2. REQUEST PERMISSION TO START FAST CRUISE.//
 BT
NOTE: ENSURE MESSAGES ARE IN ACCORDANCE WITH CURRENT MESSAGE FORMAT AND CURRENT PLAD IS UTILIZED.

(This Page Intentionally Left Blank)

APPENDIX CK

SAMPLE SHIP MESSAGE TO TYCOM CONCERNING READINESS FOR SEA TRIALS FOR INDUSTRIAL ACTIVITY AVAILABILITIES GREATER THAN SIX MONTHS IN DURATION

(SUBMARINES ONLY)

FM USS <SHIP NAME>
TO COMSUB<LANT/PAC> <NORFOLK VA/PEARL HARBOR HI>//
INFO COMSUBRON ELEVEN//
COMSUBGRU <NO.>//
COMSUB<RON/GRU NO.>//
BT
UNCLAS //N09094//
MSGID/GENADMIN//USS <SHIP'S NAME>//
SUBJ/(SUBS) USS <SHIP NAME/HULL NO.>READINESS FOR SEA TRIALS//
REF/A/DOC/COMUSFLTFORCOM/<DATE>//
NARR/REF A IS COMUSFLTFORCOMINST 4790.3, JOINT FLEET MAINTENANCE MANUAL, VOLUME II//
RMKS/1. FAST CRUISE COMPLETED <TIME AND DATE>.
2. IAW REF A, USS <SHIP NAME/HULL NO.> AND CREW READY TO PROCEED ON SEA TRIALS WITH THE FOLLOWING EXCEPTIONS:
 A. REMOVAL OF SHORE SERVICE CONNECTIONS.
 B.
3. MATERIAL CONDITION SUPPORTS ADEQUATE CREW REST FOR UNDERWAY AT <TIME AND DATE>.
4. REQUEST PERMISSION TO COMMENCE SEA TRIALS.//
BT
NOTE: ENSURE MESSAGES ARE IN ACCORDANCE WITH CURRENT MESSAGE FORMAT AND CURRENT PLAD IS UTILIZED.

(This Page Intentionally Left Blank)

APPENDIX CL

**SAMPLE TYCOM MESSAGE CONCERNING RESUMPTION OF
SEA TRIALS COMPLETION PREREQUISITES FOR INDUSTRIAL ACTIVITY AVAILABILITIES
GREATER THAN SIX MONTHS DURATION**

(SUBMARINES ONLY)

FM COMSUB<LANT/PAC> <NORFOLK VA/PEARL HARBOR HI>//
 TO COMNAVSEASYS COM WASHINGTON DC// {for SSN21 only}
 COMSUB<RON/GRU NO.>//
 <SUPERVISING AUTHORITY>//<CODES>//
 USS <SHIP NAME>//
 INFO CNO WASHINGTON DC//
 COM<LANT/PAC>FLT <NORFOLK VA/PEARL HARBOR HI>//
 DIRSSP WASHINGTON DC// {SSBN/SSGN Only}
 <SUBOPAUTH>//<CODES>//
 COMSUBRON ELEVEN//
 COMSUBGRU <NO.>//
 BT
 UNCLAS //N09094
 MSGID/GENADMIN/<TYCOM>//
 SUBJ/(SUBS) USS <SHIP NAME/HULL NO.> SEA TRIAL RESUMPTION AND INDUSTRIAL ACTIVITY
 AVAILABILITY COMPLETION PREREQUISITES//
 REF/A/RMG/COMSUB<LANT/PAC> /<DTG>/{APPENDIX CD}
 REF/B/DOC/COMUSFLTFORCOM/<DATE>//
 REF/C/DOC/NAVSEA /<DATE>//
 NARR/REF A IS TYCOM MSG TO USS <SHIP'S NAME/HULL NO.> ON COMPLETION PREREQUISITES FOR
 AVAILABILITIES GREATER THAN SIX MONTHS. REF B IS COMUSFLTFORCOMINST 4790.3, JOINT
 FLEET MAINTENANCE MANUAL, VOLUME II. REF C IS NAVSEA 0924-062-0010, SUBMARINE SAFETY
 (SUBSAFE) REQUIREMENTS MANUAL.
 RMKS/1. REF A SPECIFIED PREREQUISITES IN SUPPORT OF USS <SHIP NAME/HULL NO.>FAST CRUISE,
 INITIAL INDUSTRIAL ACTIVITY AVAILABILITY SEA TRIALS AND COMPLETION. THESE TRIALS
 WERE ACCOMPLISHED AND <INDUSTRIAL ACTIVITY NAME> HAS CONDUCTED REPAIRS TO USS <SHIP
 NAME> REQUIRING ADDITIONAL SEA TRIALS. THIS MSG PROVIDES TO ALCON REPORTS AND
 AUTHORIZATIONS PREREQUISITE TO COMMENCING ADDITIONAL SEA TRIALS:
 A. SUPERVISING AUTHORITY SHALL DRAFT REVISED SEA TRIAL AGENDA TO SUPPORT
 THE FOLLOW-ON TRIALS. THIS AGENDA SHALL BE FORMALLY APPROVED BY COMSUB<RON/GRU
 NO.> (ACTING FOR TYCOM) AND CONCURRED IN BY NAVSEA PRIOR TO CONDUCT OF SEA TRIALS.
 B. SUPERVISING AUTHORITY MSG TO NAVSEA, INFO TYCOM, THAT MATERIAL CONDI-
 TION OF SYSTEMS AND EQUIPMENTS INSTALLED, REPAIRED AND/OR TESTED BY <INDUSTRIAL
 ACTIVITY> IS SATISFACTORY FOR CONDUCT OF FOLLOW-ON SEA TRIALS. AS A MINIMUM, REPORT
 SHOULD STATE STATUS OF ALL INCOMPLETE CAT 1A AUDIT ITEMS AND THAT ALL WORK HAS
 BEEN PERFORMED IAW REF C. {REFERENCE C, APPENDIX B.3.5}
 C. USS <SHIP NAME/HULL NO.> MSG TO TYCOM STATING THAT CREW AND SHIP ARE READY
 FOR FOLLOW-ON SEA TRIALS LISTING EXCEPTIONS. {APPENDIX CN}
 D. ISIC MSG TO TYCOM THAT THE MATERIAL CONDITION OF THOSE SUBSAFE
 CERTIFICATION BOUNDARY PARTS OF USS <SHIP NAME> INSTALLED, REPAIRED AND/OR TESTED BY
 FORCES AFLOAT {Ship's Force and/or FMA} ARE SATISFACTORY IAW REF B FOR FOLLOW-ON SEA
 TRIALS. {APPENDIX CM}
 E. NAVSEA MSG TO TYCOM RECERTIFYING MATERIAL CONDITION OF USS <SHIP NAME/HULL
 NO.> FOR SPECIFIC TRIAL OPERATING DEPTH. {REFERENCE B, APPENDIX B.3.6}
 F. TYCOM MSG TO USS <SHIP NAME/HULL NO.> GRANTING PERMISSION TO CONDUCT
 FOLLOW-ON SEA TRIALS. {APPENDIX CO}
 2. USS <SHIP NAME/HULL NO.>SEA TRIALS WILL BE UNDER OPCON OF (_____).

3. CO, USS <SHIP NAME/HULL NO.> IS REQUESTED TO PROVIDE SEA TRIAL SITREPS DAILY AND IDENTIFY ITEMS MANDATORY FOR CORRECTION PRIOR TO COMPLETION OF INDUSTRIAL AVAILABILITY.

4. FOLLOWING REPORTS AND AUTHORIZATIONS ARE PREREQUISITES TO INDUSTRIAL AVAILABILITY COMPLETION:

A. SUPERVISING AUTHORITY MSG TO NAVSEA AND TYCOM IAW REF C REPORTING COMPLETION OF AUTHORIZED WORK AND CAT 1A AUDIT ITEMS LISTING EXCEPTIONS. MSG SHOULD RECOMMEND <TYPE OF AVAILABILITY> COMPLETION AND LIST PROPOSED GUARANTEE WORK ITEMS.

B. NAVSEA MSG TO TYCOM IAW REF C CERTIFYING MATERIAL CONDITION OF USS <SHIP NAME/HULL NO.> IS SATISFACTORY FOR UNRESTRICTED OPERATIONS TO DESIGN TEST DEPTH.

C. ISIC MSG TO TYCOM AND USS <SHIP NAME/HULL NO.> REPORTING MATERIAL CONDITION OF SHIP AND URO MRC STATUS SUBSEQUENT TO SEA TRIALS. {APPENDIX CI}

D. TYCOM MSG TO CO, USS <SHIP NAME/HULL NO.> IAW REF C AUTHORIZING CONDUCT OF UNRESTRICTED OPERATIONS TO DESIGN TEST DEPTH. {APPENDIX CG}

5. MSGS LISTED IN PARA 1 THROUGH 4 ABOVE SHOULD BE ASSIGNED APPROPRIATE PRECEDENCE AND PARALLELED BY PHONCON TO ACTION ADDEES CITING DTG OF FORTHCOMING MSG. ALL ADDEES OF THIS MSG TO BE INCLUDED AS ADDEES ON MSG LISTED IN PARA 1 THROUGH 4 ABOVE.//

BT

NOTE: ENSURE MESSAGES ARE IN ACCORDANCE WITH CURRENT MESSAGE FORMAT AND CURRENT PLAD IS UTILIZED.

APPENDIX CM

**SAMPLE ISIC MESSAGE TO TYCOM CONCERNING
MATERIAL CERTIFICATION FOR FOLLOW-ON SEA TRIALS IN CASES WHERE A PREVIOUS SEA
TRIAL WAS ABORTED OR CORRECTIVE ACTIONS FOR SEA TRIAL DEFICIENCIES REQUIRE AN
ADDITIONAL DEEP DIVE FOR INDUSTRIAL ACTIVITY AVAILABILITIES GREATER THAN SIX
MONTHS IN DURATION**

(SUBMARINES ONLY)

FM COMSUB<RON/GRU NO.>//
TO COMSUB<LANT/PAC> <NORFOLK VA/PEARL HARBOR HI>//
INFO COMSUBRON ELEVEN//
COMSUBGRU <NO.>//
USS <SHIP NAME>//
BT
UNCLAS //N09094//
MSGID//GENADMIN/COMSUB<RON/GRU NO.>//
SUBJ/(SUBS) USS <SHIP NAME/HULL NO.>MATERIAL CERTIFICATION/ READINESS FOR <FOLLOW-ON ^(NOTE 1)>
SEA TRIALS//
REF/A/RMG/TYCOM/<DTG>/{APPENDIX CL}
REF/B/DOC/COMUSFLTFORCOM/<DATE>//
REF/C/RMG/COMSUB<RON/GRU NO.>/<DTG>/NOTAL/{APPENDIX CH}
REF/D/DOC/NAVSEA /<DATE>//
REF/E/DOC/NAVSEA/<DATE OF CURRENT REVISION>//
NARR/REF A IS TYCOM MSG TO USS <SHIP'S NAME/HULL NO.> ON RESUMPTION OF SEA TRIAL
PREREQUISITES FOR AVAILABILITIES GREATER THAN SIX MONTHS. REF B IS
COMUSFLTFORCOMINST 4790.3, JOINT FLEET MAINTENANCE MANUAL, VOLUME II. REF C IS
COMSUB<RON/GRU NO.> MSG TO TYCOM ON MATERIAL STATUS PRIOR TO INITIAL SEA TRIALS. REF
D IS NAVSEA 0924-062-0010, SUBMARINE SAFETY (SUBSAFE) REQUIREMENTS MANUAL. REF E IS
NAVSEA URO REQUIREMENTS MANUAL.//
RMKS/1. IAW REFS A AND B, THIS MSG CERTIFIES THAT NO MANDATORY DEFICIENCIES FOR
<FOLLOW-ON ^(NOTE 1)> SEA TRIALS HAVE BEEN IDENTIFIED. THERE HAVE BEEN NO RECS OPENED AND
NO SUBSAFE DEPARTURES FROM SPECIFICATIONS PROCESSED SINCE THE START OF THE INITIAL
SEA TRIALS <OR, REPORT ANY MANDATORY DEFICIENCIES DISCOVERED WITH CORRECTIVE ACTION, AND IF RECS
AND/OR DEPARTURES FROM SPECIFICATIONS WERE PROCESSED SINCE THE START OF THE INITIAL SEA TRIALS, REPORT
ALL RECS OPENED SINCE THE START OF INITIAL SEA TRIALS ARE CLOSED AND/OR ALL SUBSAFE DEPARTURES FROM
SPECIFICATIONS PROCESSED SINCE THE START OF SEA TRIALS ARE RESOLVED ^{NOTE 2}>.
2. THERE ARE NO SUBSAFE DEPARTURES FROM SPECIFICATIONS WITH CONDITIONS WHICH
HAVE NOT BEEN SATISFIED. THE FOLLOWING DEPARTURES FROM SPECIFICATIONS ARE
CURRENTLY OUTSTANDING:
DEPARTURE NO. TYPE SYSTEM/COMPONENT RESTRICTION (IF ANY)
A.
B.
3. ALL URO MRC MANDATORY TESTS/INSPECTIONS SPECIFIED IN REF E HAVE BEEN
ACCOMPLISHED OR VERIFIED TO BE WITHIN THE REQUIRED PERIODICITY.//
BT

NOTE 1: UPCOMING TRIAL WHICH IS SUBJECT OF THIS CERTIFICATION (E.G., SECOND SEA TRIAL, ETC.).

NOTE 2: LIST ALL RE-ENTRIES TO MATERIAL CERTIFICATION BOUNDARY AND ALL WORK ON SYSTEMS AFFECTING RECOVERABILITY, SALVAGE, WATERTIGHT INTEGRITY, OR OPERATION OF SHIP'S CONTROL SURFACES WITH CORRECTIVE ACTION SINCE RELEASE FOR FAST CRUISE MESSAGE.

NOTE: ENSURE MESSAGES ARE IN ACCORDANCE WITH CURRENT MESSAGE FORMAT AND CURRENT PLAD IS UTILIZED.

APPENDIX CN

**SAMPLE SHIP MESSAGE TO TYCOM CONCERNING READINESS FOR FOLLOW-ON SEA TRIALS
FOR INDUSTRIAL ACTIVITY AVAILABILITIES GREATER THAN SIX MONTHS IN DURATION**

(SUBMARINES ONLY)

FM USS <SHIP NAME>//
TO COMSUB<LANT/PAC> <NORFOLK VA/PEARL HARBOR HI>//
INFO COMSUBRON ELEVEN//
COMSUBGRU <NO.>//
COMSUB<RON/GRU NO.>//
BT
UNCLAS //N09094//
MSGID/GENADMIN//USS <SHIP'S NAME>//
SUBJ/(SUBS) USS <SHIP NAME/HULL NO.>READINESS FOR SEA TRIALS//
REF/A/DOC/COMUSFLTFORCOM/<DATE>//
NARR/REF A IS COMUSFLTFORCOMINST 4790.3, JOINT FLEET MAINTENANCE MANUAL, VOLUME
II//
RMKS/1. IAW REF A, USS <SHIP NAME/HULL NO.>AND CREW REPORTED READY TO PROCEED ON
FOLLOW-ON ^(NOTE 1)SEA TRIALS WITH THE FOLLOWING EXCEPTIONS:
 A. REMOVAL OF SHORE SERVICE CONNECTIONS.
 B.
2. MATERIAL CONDITION SUPPORTS ADEQUATE CREW REST FOR UNDERWAY AT <TIME AND DATE>.
3. REQUEST PERMISSION TO COMMENCE FOLLOW-ON SEA TRIALS.//
BT

NOTE 1: UPCOMING TRIAL WHICH IS SUBJECT OF THIS CERTIFICATION (E.G., SECOND SEA TRIAL, ETC.).

NOTE: ENSURE MESSAGES ARE IN ACCORDANCE WITH CURRENT MESSAGE FORMAT AND CURRENT PLAD IS UTILIZED.

(This Page Intentionally Left Blank)

APPENDIX CO

**SAMPLE TYCOM MESSAGE TO SHIP CONCERNING FOLLOW-ON
SEA TRIALS DEPTH AUTHORIZATION FOR INDUSTRIAL ACTIVITY AVAILABILITIES GREATER
THAN SIX MONTHS IN DURATION**

(SUBMARINES ONLY)

FM COMSUB<LANT/PAC> <NORFOLK VA/PEARL HARBOR HI>//
 TO USS <SHIP NAME>//
 INFO CNO WASHINGTON DC//
 COMNAVSEASYS COM WASHINGTON DC//
 <LANT/PAC>FLT<NORFOLK VA/PEARL HARBOR HI>//
 <DIRSSP WASHINGTON DC FOR SSBN>//
 COMSUBGRU <NO.>//
 COMSUBRON <NO.>//
 <SUPERVISING AUTHORITY>//
 BT
 UNCLAS //N09094//
 MSGID/GENADMIN/COMSUB<LANT/PAC>//
 SUBJ/(SUBS) USS <SHIP NAME/HULL NO.> <FOLLOW-ON⁽¹⁾> SEA TRIALS DEPTH AUTHORIZATION//
 REF/A/MSG/COMNAVSEASYS COM/<DTG>/{B.3.6}
 REF/B/LTR/NAVSEA/<SER NO./DATE>//
 REF/C/LTR/COMSUB<LANT/PAC><SER NO./DATE>//
 NARR/REF A IS NAVSEA SUBSAFE MATERIAL CONDITION READINESS REPORT AND <FOLLOW-ON⁽¹⁾>
 SEA TRIALS DEPTH RECOMMENDATION FOR USS <SHIP NAME/HULL NO.>. REF B CONCURRED IN THE
 <FOLLOW-ON⁽¹⁾> SEA TRIALS AGENDA FOR USS <SHIP NAME/HULL NO.>. REF C APPROVED THE <FOLLOW-
 ON⁽¹⁾> SEA TRIALS AGENDA FOR USS <SHIP NAME/HULL NO.>. //
 RMKS/1. REF A CERTIFIED THE SUBSAFE MATERIAL CONDITION OF THOSE PARTS OF USS <SHIP
 NAME/HULL NO.> INSTALLED, REPAIRED AND/OR TESTED BY THE SHIPYARD IS SATISFACTORY FOR
 <FOLLOW-ON⁽¹⁾> SEA TRIALS TO TEST DEPTH.
 2. THIS MSG CONFIRMS THAT THE CERTIFICATION OF THE REMAINDER OF ITEMS WITHIN
 SUBSAFE CERTIFICATION BOUNDARY OF USS <SHIP NAME/HULL NO.> HAS BEEN SUSTAINED.
 ACCORDINGLY, THE STATUS OF THE SUBSAFE CERTIFICATION BOUNDARY OF USS <SHIP NAME/HULL
 NO.> IS SATISFACTORY FOR <FOLLOW-ON⁽¹⁾> SEA TRIALS TO TEST DEPTH <SUBJECT TO
 RESTRICTIONS IN PARA 2 OF REF A *if any are identified*>.
 3. USS <SHIP NAME/HULL NO.> IS AUTHORIZED TO DIVE UNDER DELIBERATE AND CONTROLLED
 CONDITIONS TO <SPECIFIED> DEPTH IAW THE <FOLLOW-ON⁽¹⁾> SEA TRIALS AGENDA CONCURRED IN
 BY REF B AND APPROVED BY REF C.
 4. EXCEPT AS LISTED IN 5. BELOW, THIS DEPTH AUTHORIZATION IS AUTOMATICALLY
 SUSPENDED UPON RE-ENTRY TO THE SUBSAFE CERTIFICATION BOUNDARY OR CASUALTY
 AFFECTING RECOVERABILITY, SALVAGE, WATERTIGHT INTEGRITY, OR OPERATION OF SHIP'S
 CONTROL SURFACES, THE SHIP SHALL NOT OPERATE AT A DEPTH GREATER THAN 200 FEET
 UNTIL RE-ENTRY IS CERTIFIED TO TYCOM AND TYCOM GRANTS APPROVAL TO OPERATE TO
 PREVIOUSLY AUTHORIZED DEPTH.
 5. RE-ENTRY CONTROL TO ADJUST FLOOD CONTROL HYDRAULIC VALVE TIMING WILL BE
 CERTIFIED BY THE COMMANDING OFFICER, TYCOM CERTIFICATION IS NOT REQUIRED, AND A
 SITREP WILL BE TRANSMITTED PRIOR TO RESUMPTION OF OPERATION BELOW 200 FEET.//
 BT

⁽¹⁾: **UPCOMING TRIALS WHICH ARE SUBJECT OF THIS CERTIFICATION (E.G., SECOND SEA TRIALS, ETC.).**

NOTE: ENSURE MESSAGES ARE IN ACCORDANCE WITH CURRENT MESSAGE FORMAT AND CURRENT PLAD IS UTILIZED.

(This Page Intentionally Left Blank)

APPENDIX CP

SUBMARINE SEA TRIAL SITUATION REPORT
(SITREP GREATER THAN SIX MONTHS)

FM USS <SHIP NAME>//
 TO COMSUB<LANT/PAC> <NORFOLK VA/PEARL HARBOR HI>//
 INFO CNO WASHINGTON DC//
 COM<LANT/PAC>FLT <NORFOLK VA/PEARL HARBOR HI>//
 COMNAVSEASYS COM WASHINGTON DC//
 DIRSSP WASHINGTON DC// {For SSBN/SSGN Only}
 <SUBOPAUTH>// {IF OTHER THAN PARENT TYCOM}
 COMSUBRON ELEVEN//
 COMSUBGRU <NO.>//
 COMSUB<RON/GRU NO.>//
 <SUPERVISING AUTHORITY>//<CODES>//
 (OTHER UNITS IN AREA IF APPLICABLE)//
 BT
 UNCLAS //N09094//
 MSGID/GENADMIN/USS <SHIP NAME>//
 SUBJ/(TYPE AVAILABILITY) SITREP (SEQUENTIAL NUMBER)//
 REF/A/DOC/COMUSFLTFORCOM/<DATE>//
 REF/B/DOC/AS APPLICABLE/<DATE>//
 NARR/ REF A IS COMUSFLTFORCOMINST 4790.3, JOINT FLEET MAINTENANCE MANUAL, VOLUME II.
 RMKS/1. CO'S SUMMARY, EVENTS 1-9 COMPLETED WITH THE FOLLOWING DEFICIENCIES NOTED:
 A. SUBSAFE/URO DEFICIENCIES.
 1) NON-ISOLABLE SEAWATER LEAKS
 (A) #1 SCOPE HULL GLAND LEAK 1 DPM AT 20% TD
 (B) SSW-30 (BODY-BONNET LEAK)
 (C) DE-7 (STEM SEAL LEAK)
 (D) RUDDER RAM
 (E) EHP P46-3P
 (F) TD-89 (FWD ESCAPE TRUNK DRAIN)
 (G) #2 SCOPE INBOARD HOIST CYLINDER FITTING
 (H) #1 SCOPE INBOARD HOIST CYLINDER FITTING
 (I) STERN PLANES RAM PACKING
 (J) STBD RETRACTABLE BOW PLANE EXTEND RETRACT CYLINDER
 (K) AHP-525 (PARKER CHECK VALVE SEAT LEAK)
 (L) SSW-20 UPSTREAM FLANGE
 (M) EHP P025-01S (WHIP ANTENNA)
 (N) INNER STERN PLANES RAM PACKING
 2) ISOLABLE SEAWATER LEAK
 (A) TDU VENT, TD-104 LEAKS 3 DPM AT 65% TD.
 (B) ASW-5 BODY-BONNET LEAK
 OTHER DEFICIENCIES
 (A) STERN PLANES AUX ANGLE INDICATOR ON BCP DOES NOT ILLUMINATE, URO-16
 (B) MSW-2 CYCLE TIME SHUT IS 10.1 SEC
 (C) MBT 3A WILL NOT OPEN
 B. NON-SUBSAFE/URO DEFICIENCIES.
 1) SCULLERY DRAIN LEAKING AT FITTING F-18, 27 DPM
 2) 3 FLOOR TILES IN CREWS MESS LIFTED AFFECTING SANITATION
 3) CO HOT WATER SHOWER RECIRC PUMP FAILED
 2. PREVIOUS DEFICIENCIES REPORTED AND STATUS.

(LIST ALL PREVIOUS DEFICIENCIES AND CURRENT STATUS-THE GOAL IS TO CAPTURE THE COMPLETE MATERIAL CONDITION IN EACH MESSAGE) STATUS = REPAIRED (REP), CORRECTIVE ACTION REQUIRED (CAR), NOT APPLICABLE (NA)

EXAMPLE –

- 1) SCULLERY DRAIN LEAKING AT FITTING F-18, 27 DPM -REP
 - 2) 3 FLOOR TILES IN CREWS MESS LIFTED AFFECTING SANITATION - CAR
 - 3) CO HOT WATER SHOWER RECIRC PUMP FAILED - CAR
 - 4) #1 SCOPE HULL GLAND LEAK 1 DPM AT 20% TD - CAR
 - 5) TDU VENT, TD-104 LEAKS 3 DPM AT 65% TD - CAR
 - 6) STERN PLANES AUX ANGLE INDICATOR ON BCP DOES NOT ILLUMINATE, URO-16 - REP
3. ADDITIONAL INFO.
- 1) DESCRIBE ANY ADDITIONAL INFO DESIRED OR LIST "NONE".
 4. **TYCOM, NAVSHIPYD, AND NAVSEA REPS CONCUR-DO NOT CONCUR (AS APPROPRIATE).//**
- BT

NOTE: ENSURE MESSAGES ARE IN ACCORDANCE WITH CURRENT MESSAGE FORMAT AND CURRENT PLAD IS UTILIZED.

APPENDIX CQ
SAMPLE MESSAGE CONCERNING
MOD ALERT NOTIFICATION

(SUBMARINES ONLY)

FM <INDUSTRIAL ACTIVITY>
 TO COMSUB<RON/GRU NO.>/{ISIC of Escort Ship}
 COMSUBLANT
 COMSUBPAC
 COMSUBBRON ELEVEN//
 UNSEARESCOM SAN DIEGO CA//
 USS <ESCORT SHIP NAME>//
 INFO CNO WASHINGTON DC//
 COM<LANT/PAC>FLT <NORFOLK VA/PEARL HARBOR HI>//
 COMNAVSEASYSYSCOM WASHINGTON DC (AS APPLICABLE) //
 DIRSSP WASHINGTON DC // {For SSBN/SSGN only}
 <SUPERVISING AUTHORITY>/{CODES}</>
 <SUBOPAUTH>// {If other than parent TYCOM}
 COMSUB<RON/GRU NO.>/{ISIC of Sea Trial Ship}
 CTF TWO SIX//
 CTG TWO SIX PT ONE//
 NSCSES NORFOLK VA//
 COMSUBGRU <NINE/TEN> // {For SSBN/SSGN only}
 USS <SHIP NAME/HULL NO.>{SEA TRIAL UNIT}//
 BT
 UNCLAS //N03120//
 MSGID/GENADMIN/<INDUSTRIAL ACTIVITY>//
 SUBJ/(SUBS) SUBMARINE SEA TRIAL SUPPORT SERVICES/ MOD ALERT NOTIFICATION//
 REF/A/DOC/COMUSFLTFORCOM/<DATE>//
 NARR/REF A IS JOINT FLEET MAINTENANCE MANUAL//
 RMKS/1. IAW REF A REQUIREMENTS, USS <SHIP NAME/HULL NO.> IS SCHEDULED FOR
 SEA TRIALS OCCURRING <DDMMYY>. REQUEST SRDRS MOD ALERT BE SCHEDULED
 TO COVER SEA TRIAL PERIOD.
 2. ANY CHANGES IN ALERT POSTURE REQUIREMENTS WILL BE FORWARDED.//
 BT

**NOTE: ENSURE MESSAGES ARE IN ACCORDANCE WITH CURRENT MESSAGE FORMAT AND
 CURRENT PLAD IS UTILIZED.**

(This Page Intentionally Left Blank)

(This Page Intentionally Left Blank)

APPENDIX CS

SAMPLE NAVSEA MESSAGE TO TYCOM CONCERNING FLY-BY-WIRE SHIP CONTROL SYSTEMS
MATERIAL CONDITION READINESS FOR SEA TRIALS

(SUBMARINES ONLY)

FM COMNAVSEASYS COM WASHINGTON DC//
 TO COMSUB<LANT/PAC> <NORFOLK VA/PEARL HARBOR HI>//
 INFO CNO WASHINGTON DC//
 COM<LANT/PAC>FLT <NORFOLK VA/PEARL HARBOR HI>//
 <DIRSSP WASHINGTON DC FOR SSBN>//
 COMSUBGRU <NO.>//
 COMSUBRON <NO.>//
 USS <SHIP NAME>//
 <SUPERVISING AUTHORITY>//
 BT
 UNCLAS //N09094//
 MSGID/GENADMIN/COMNAVSEASYS COM//
 SUBJ/(SUBS) FLY-BY-WIRE SHIP CONTROL SYSTEMS MATERIAL CONDITION READINESS FOR SEA
 TRIALS OF USS <SHIP NAME/HULL NO.>//
 REF/A/DOC/NAVSEA T9044-AD-MAN-010//
 REF/B/MSG/<SUPERVISING AUTHORITY>/<DTG>/{G.3.1}
 REF/C/LTR/NAVSEA <SER NO./DATE>//
 REF/D/LTR/COMSUB<LANT/PAC><SER NO./DATE>//
 NARR/REF A IS THE REQUIREMENTS MANUAL FOR SUBMARINE FLY-BY-WIRE SHIP CONTROL
 SYSTEMS. REF B IS <SUPERVISING AUTHORITY> REPORT OF READINESS OF <SHIP NAME/HULL
 NO.> FLY-BY-WIRE SHIP CONTROL SYSTEMS FOR FAST CRUISE AND SEA TRIALS. REF C
 CONCURRED IN SEA TRIAL AGENDA FOR USS <SHIP NAME/HULL NO.>. REF D APPROVED THE SEA
 TRIAL AGENDA FOR USS <SHIP NAME/HULL NO.>//
 RMKS/1. IN ACCORDANCE WITH REF A, AND AS REPORTED BY REF B, THE MATERIAL CONDITION
 OF THOSE PARTS OF THE FLY-BY-WIRE SHIP CONTROL SYSTEM FOR USS <SHIP NAME/HULL NO.>
 INSTALLED, REPAIRED AND/OR TESTED BY THE SHIPYARD IS CERTIFIED SATISFACTORY FOR USE
 DURING SEA TRIALS.
 2. SUBJECT TO CONFIRMATION BY TYCOM THAT CERTIFICATION REQUIREMENTS OF REF A HAVE
 BEEN SUSTAINED FOR THE REMAINDER OF THE FLY-BY-WIRE SHIP CONTROL SYSTEMS
 CERTIFICATION BOUNDARY, RECOMMEND AUTHORIZED USE OF THE FLY-BY-WIRE SHIP
 CONTROL SYSTEMS IN ACCORDANCE WITH THE SEA TRIAL AGENDA CONCURRED IN BY REF C
 AND APPROVED BY REF D.
 3. THERE ARE NO FLY-BY-WIRE SHIP CONTROL SYSTEMS DEVIATIONS AND WAIVERS WITH
 CONDITIONS THAT HAVE NOT BEEN SATISFIED OR FLY-BY-WIRE SHIP CONTROL SYSTEMS OR
 RELATED SHIP OPERATING RESTRICTIONS/LIMITS <or identify operating restrictions/limits and list
 conditional Deviations and Waivers including Deviation Number, Short Title and Expected Clearance Date/Key
 Event(1)>.
 4. THIS CERTIFICATION IS VALID THROUGHOUT TRIALS UNLESS A DEFICIENCY HAS BEEN
 DISCOVERED. SHIP SPEED IS RESTRICTED TO 20 KNOTS OR LESS WHEN AN FBW SCS FAULT
 CONDITION RESULTS IN A MAJOR NON-CONFORMANCE AFFECTING CONTROL OF SHIPS PITCH,
 HEADING, DEPTH OR CONTROL SURFACES. THESE DEFICIENCIES SHALL BE REPORTED TO
 NAVSEA AND THE APPROPRIATE FLEET AND TYPE COMMANDERS. PREVIOUS NAVSEA
 CERTIFICATION OF THE FBW SCS MATERIAL CONDITION SHALL BE SUSPENDED UNTIL NAVSEA
 REVIEWS THE REPORT AND CERTIFIES TO THE TYCOM THAT THE FBW SCS MATERIAL CONDITION
 IS SATISFACTORY FOR SEA TRIALS IN ACCORDANCE WITH THE SEA TRIAL AGENDA APPROVED
 BY REF D. THE SHIP'S SPEED IS RESTRICTED TO 20 KNOTS OR LESS UNTIL SATISFACTORY
 RESOLUTION OF THE MAJOR NON-CONFORMANCE AND TYCOM APPROVAL TO OPERATE THE
 FBW SCS TO PREVIOUSLY AUTHORIZED CONDITIONS IS GRANTED, UNLESS SPECIFICALLY
 ADDRESSED IN THE SEA TRIAL AGENDA.

5. ALL DOCKSIDE TESTING IS COMPLETE. PER REF A ALL AT-SEA TESTING TO BE COMPLETED PER THE SHIP'S CONTROL SYSTEM TRIAL AGENDA OR AS STATED IN DEPARTURE FROM SPECIFICATIONS/DEVIATIONS/WAIVERS. PRIOR TO THE COMPLETION OF THE SHIP'S CONTROL SYSTEM AT-SEA TESTING THE FOLLOWING RESTRICTIONS ARE IN EFFECT:

A.<TYPICAL RESTRICTIONS, HOWEVER LIST ONLY THOSE REQUIRED BASED UPON WORK ACCOMPLISHED, IF NONE – WRITE "NONE".

B. AUTOMATIC MODE MAY BE USED FOR COURSE KEEPING (SURFACED AND SUBMERGED), COURSE CHANGING (SURFACED AND SUBMERGED), AND DEPTH KEEPING.

C. DEPTH CHANGES SHALL BE CONDUCTED IN MANUAL MODE.>

6. REQUEST NAVSEA PMS <->, NAVSEA 08 AND NAVSEA 07Q BE INFO ADDEE ON ALL SEA TRIAL SITREPS.

7. RECOMMENDATION TO AUTHORIZE DIVING WILL BE ADDRESSED BY SEPCOR. //

BT

NOTE: ENSURE MESSAGES ARE IN ACCORDANCE WITH CURRENT MESSAGE FORMAT AND CURRENT PLAD IS UTILIZED.

APPENDIX CT

SAMPLE TYCOM MESSAGE TO SHIP CONCERNING AUTHORIZATION TO USE FLY-BY-WIRE
SHIP CONTROL SYSTEMS

(SUBMARINES ONLY)

FM COMSUB<LANT/PAC> <NORFOLK VA/PEARL HARBOR HI>//
 TO USS <SHIP NAME>//
 INFO CNO WASHINGTON DC//
 COMNAVSEASYS COM WASHINGTON DC//
 COM<LANT/PAC>FLT <NORFOLK VA/PEARL HARBOR>//
 <DIRSSP WASHINGTON DC FOR SSBN>//
 COMSUBGRU <NO.>//
 COMSUBRON/<NO.>//
 <SUPERVISING AUTHORITY>//
 BT
 UNCLAS//N09094//
 MSGID/ADMIN/COMSUB<LANT/PAC>//
 SUBJ/(SUBS) USS <SHIP NAME/HULL NO.> AUTHORIZATION TO USE FLY-BY-WIRE SHIP CONTROL
 SYSTEMS IN SUPPORT OF SEA TRIALS//
 REF/A/MSG/COMNAVSEASYS COM/<DTG>/{G.3.2}
 REF/B/MSG/SUPERVISING AUTHORITY/<DTG>/{G.3.3}
 REF/C/LTR/NAVSEA <SER NO./DATE>//
 REF/D/LTR/COMSUB<LANT/PAC>/<SER NO./DATE>//
 [IF APPLICABLE] REF/E/MSG/COMSUB<RON/GRU> NO.//
 NARR/<REF A <AND E> IS NAVSEA FLY-BY-WIRE SHIP CONTROL SYSTEMS MATERIAL CONDITION
 READINESS REPORT AND SEA TRIALS RECOMMENDATION FOR USS <SHIP NAME/HULL NO.>. REF B IS
 <SUPERVISING AUTHORITY> REPORT OF USS <SHIP NAME/HULL NO.> FAST CRUISE COMPLETION AND
 READINESS OF THE FLY-BY-WIRE SHIP CONTROL SYSTEMS FOR SEA TRIALS. REF C CONCURRED
 IN THE SEA TRIAL AGENDA FOR USS <SHIP NAME/HULL NO.>. REF D APPROVED THE SEA TRIAL
 AGENDA FOR USS <SHIP NAME/HULL NO.>.///
 RMKS/1. REF A CERTIFIED THE MATERIAL CONDITION OF THOSE PARTS OF THE FLY-BY-WIRE
 SHIP CONTROL SYSTEMS FOR THE USS <SHIP NAME/HULL NO.> INSTALLED, REPAIRED AND/OR
 TESTED BY THE SHIPARD IS SATISFACTORY FOR SEA TRIALS.
 2. THIS MESSAGE CONFIRMS THAT THE CERTIFICATION OF THE REMAINDER OF ITEMS WITHIN
 THE FLY-BY-WIRE SHIP CONTROL SYSTEMS CERTIFICATION BOUNDARY OF USS <SHIP NAME/HULL
 NO.> HAS BEEN SUSTAINED. ACCORDINGLY, THE STATUS OF THE FLY-BY-WIRE SHIP CONTROL
 SYSTEMS CERTIFICATION BOUNDARY OF USS <SHIP NAME/HULL NO.> IS SATISFACTORY FOR SEA
 TRIALS. <SUBJECT TO ANY RESTRICTIONS IN PARA 3 OF REF A if any are identified>.
 3. REF B REPORTED SUCCESSFUL COMPLETION OF FAST CRUISE AND READINESS OF THE FLY-BY-
 WIRE SHIP CONTROL SYSTEMS FOR SEA TRIALS.
 4. USS <SHIP NAME/HULL NO.> FLY-BY-WIRE SHIP CONTROL SYSTEMS USE IS AUTHORIZED IN
 SUPPORT OF SEA TRIALS IN ACCORDANCE WITH THE SEA TRIAL AGENDA CONCURRED IN BY REF
 C AND APPROVED BY REF D. THERE ARE NO FLY-BY-WIRE SHIP CONTROL SYSTEMS or SHIP
 RELATED OPERATING RESTRICTIONS/LIMITS WHICH HAVE NOT BEEN SATISFIED. <or identify
 operating restrictions/limits//
 5. THIS CERTIFICATION IS VALID THROUGHOUT TRIALS UNLESS A DEFICIENCY HAS BEEN
 DISCOVERED. SHIP SPEED IS RESTRICTED TO 20 KNOTS OR LESS WHEN A FBW SCS FAULT
 CONDITION RESULTS IN A MAJOR NON-CONFORMANCE AFFECTING CONTROL OF SHIPS PITCH,
 HEADING, DEPTH OR CONTROL SURFACES. THESE DEFICIENCIES SHALL BE REPORTED TO
 NAVSEA AND THE APPROPRIATE FLEET AND TYPE COMMANDERS. PREVIOUS NAVSEA
 CERTIFICATION OF THE FBW SCS MATERIAL CONDITION SHALL BE SUSPENDED UNTIL NAVSEA
 REVIEWS THE REPORT AND CERTIFIES TO THE TYCOM THAT THE FBW SCS MATERIAL CONDITION
 IS SATISFACTORY FOR SEA TRIALS IN ACCORDANCE WITH THE SEA TRIAL AGENDA APPROVED
 BY REF D. THE SHIP'S SPEED IS RESTRICTED TO 20 KNOTS OR LESS UNTIL SATISFACTORY

RESOLUTION OF THE MAJOR NON-CONFORMANCE AND TYCOM APPROVAL TO OPERATE THE FBW SCS TO PREVIOUSLY AUTHORIZED CONDITIONS IS GRANTED, UNLESS SPECIFICALLY ADDRESSED IN THE SEA TRIAL AGENDA.//
BT

NOTE: ENSURE MESSAGES ARE IN ACCORDANCE WITH CURRENT MESSAGE FORMAT AND CURRENT PLAD IS UTILIZED.

APPENDIX CU

SAMPLE ISIC MESSAGE TO TYCOM CONCERNING FLY-BY-WIRE MATERIAL CERTIFICATION
UPON COMPLETION OF AT-SEA TESTING OR SEA TRIALS

(SUBMARINES ONLY)

FM COMSUB<RON/GRU NO.>//
 TO COMSUB<LANT/PAC> <NORFOLK VA/PEARL HARBOR HI>//
 INFO CNO WASHINGTON DC//
 COMNAVSEASYS COM WASHINGTON DC//
 PEO SUB WASHINGTON DC//
 COMSUBGRU <NO.>//
 COM<LANT/PAC>FLT <NORFOLK VA/PEARL HARBOR HI>//
 NAVSURFWARCEN CARDEROCKDIV BETHESDA MD//
 COMREGSUPPGRU <CITY ST>//
 <SUPERVISING AUTHORITY>//<CODES>// (IF APPLICABLE)
 USS < SHIP NAME/HULL NO>//
 BT
 UNCLAS //N04790//
 MSGID/GENADMIN/COMSUB<RON/GRU NO.>//
 SUBJ/ USS < SHIP NAME/HULL NO> FLY-BY-WIRE SHIP CONTROL SYSTEMS
 /(FBW SCS) AT-SEA TESTING COMPLETION//
 REF/A/MSG/NAVSURFWARCEN CARDEROCK/<DTG>//
 REF/B/MSG/ USS < SHIP NAME/HULL NO>/<DTG>//
 REF/C/DOC/NAVSEA/-//
 NARR/REF A IS NSWC CARDEROCK DIVISION MESSAGE ADDRESSING FBW SCS
 MATERIAL CERTIFICATION AND READINESS FOR AT-SEA OPERATION. REF B IS
 USS < SHIP NAME/HULL NO> MESSAGE ADDRESSING COMPLETION OF AT-SEA TESTING
 FOR FBW SCS. REF C IS FBW MANUAL T9044-AD-MAN-010.//
 RMKS/1. PER REF B ISIC CERTIFIES USS < SHIP NAME/HULL NO> FBW SCS
 AT-SEA TESTING IS COMPLETED SATISFACTORILY.
 2. THERE ARE NO CONDITIONAL FBW SCS DEPARTURE FROM SPECIFICATIONS
 OR DEVIATIONS AND WAIVERS THAT HAVE NOT BEEN SATISFIED.
 3. THE FOLLOWING SEA TRIALS DEFICIENCIES WERE NOTED AND REQUIRE
 CORRECTION OR HAVE BEEN CORRECTED:
 <NONE OR LIST DEFICIENCIES AND INDICATE IF CORRECTIVE ACTION IS REQUIRED>.
 4. THE FOLLOWING RESTRICTIONS ARE IN EFFECT:
 <NONE OR LIST DEFICIENCIES>.
 5. THE FBW SCS MATERIAL CONDITION OF THOSE PARTS OF THE SHIP
 INSTALLED, REPAIRED AND TESTED BY THE ISEA AND ACTIVITIES PERFORMING
 WORK IS SATISFACTORY. ISIC CONCURS WITH ISEA'S RECOMMENDATION THAT
 THE MATERIAL CONDITION IS SATISFACTORY FOR UNRESTRICTED OPERATION.
 6. REQUEST TYCOM APPROVAL FOR FBW SCS USE IN SUPPORT OF UNRESTRICTED
 OPERATION.//
 BT

**NOTE: ENSURE MESSAGES ARE IN ACCORDANCE WITH CURRENT MESSAGE FORMAT AND
 CURRENT PLAD IS UTILIZED.**

(This Page Intentionally Left Blank)

APPENDIX CV

SAMPLE TYCOM MESSAGE TO SHIP CONCERNING URO FOR FLY-BY-WIRE SHIP CONTROL SYSTEMS

(SUBMARINES ONLY)

FM COMSUB<LANT/PAC> <NORFOLK VA/PEARL HARBOR HI>//
 TO USS <SHIP NAME>//
 INFO CNO WASHINGTON DC//
 COMNAVSEASYS COM WASHINGTON DC//
 COM<LANT/PAC>FLT <NORFOLK VA/PEARL HARBOR HI>//
 <DIRSSP WASHINGTON DC FOR SSBN>
 COMSUBGRU <NO.>//
 COMSUBRON NO.>//
 <SUPERVISING AUTHORITY>//
 BT
 UNCLAS //N09094//
 MSGID/GENADMIN/COMSUB<LANT/PAC>//
 SUBJ/(SUBS) UNRESTRICTED USE OF USS < SHIP NAME/HULL NO> FLY-BY-WIRE SHIP CONTROL SYSTEMS IN SUPPORT OF SUBMARINE UNRESTRICTED OPERATION//
 REF/A/MSG/COMNAVSEASYS COM/<DTG>/{G.3.9}
 REF/B/DOC/NAVSEA T9044-AD-MAN-010//
 [IF APPLICABLE] REF/C/MSG/COMSUB<RON/GRU> NO./<DTG>//
 NARR/REF A <AND OR C> IS NAVSEA</ISIC> MSG FOR UNRESTRICTED USE OF USS <SHIP NAME/HULL NO.> FLY-BY-WIRE SHIP CONTROL SYSTEMS IN SUPPORT OF SUBMARINE UNRESTRICTED OPERATIONS. REF B IS THE REQUIREMENTS MANUAL FOR SUBMARINE FLY-BY-WIRE SHIP CONTROL SYSTEMS. REF C IS ISIC FLY-BY-WIRE MATERIAL CERTIFICATION UPON COMPLETION OF AT-SEA TESTING OR SEA TRIALS.//
 RMKS/1. REF A CERTIFIED THE MATERIAL CONDITION OF THOSE PARTS OF USS < SHIP NAME/HULL NO> FLY-BY-WIRE SHIP CONTROL SYSTEMS INSTALLED, REPAIRED AND/OR TESTED BY THE SHIPYARD IS SATISFACTORY AND RECOMMENDED UNRESTRICTED USE OF USS <SHIP NAME/HULL NO.> FLY-BY-WIRE SHIP CONTROL SYSTEMS IN SUPPORT OF SUBMARINE UNRESTRICTED OPERATIONS.
 2. <TYCOM> CONFIRMS THAT CERTIFICATION OF THE REMAINDER OF ITEMS NOT COVERED BY REF A WITHIN THE FLY-BY-WIRE SHIP CONTROL SYSTEMS CERTIFICATION BOUNDARY HAS BEEN SUSTAINED. ACCORDINGLY, USS <SHIP NAME/HULL NO.> IS AUTHORIZED UNRESTRICTED USE OF THEIR FLY-BY-WIRE SHIP CONTROL SYSTEMS IN SUPPORT OF SUBMARINE UNRESTRICTED OPERATIONS, SUBJECT TO THE FOLLOWING RESTRICTIONS: <list restrictions if they exist or state "NONE">.
 3. CONTINUED CERTIFICATION FOR UNRESTRICTED USE OF FLY-BY-WIRE SHIP CONTROL SYSTEMS IN SUPPORT OF SUBMARINE UNRESTRICTED OPERATIONS IS SUBJECT TO COMPLIANCE WITH REF B.
 4. RECOMMENDATION FOR SHIP'S UNRESTRICTED OPERATION TO TEST DEPTH WILL BE ADDRESSED BY SEPARATE CORRESPONDENCE.//
 BT

NOTE: ENSURE MESSAGES ARE IN ACCORDANCE WITH CURRENT MESSAGE FORMAT AND CURRENT PLAD IS UTILIZED.

(This Page Intentionally Left Blank)

VOLUME II**PART I****CHAPTER 4****FLEET MAINTENANCE AVAILABILITIES**REFERENCES.

- (a) COMSUBLANT/COMSUBPAC C3500.21 (Ser) - SSN Fleet Response Training Plan (FRTP) Management
- (b) COMSUBFORINST 3500.22 - SSGN Operational Cycle, Training and Certification Management
- (c) NAVSEAINST 4790.8/OPNAVINST 4790.4 - Ships' Maintenance and Material Management (3-M) Manual
- (d) NAVSEA S9213-33-MMA-000 - Radiological Controls for Ships
- (e) NAVSEAINST C9210.30 - Procedure for Administration of Nuclear Reactor Plant Preventive Maintenance and Tender Nuclear Support Facilities Preventive Maintenance on Ships
- (f) OPNAVINST 3120.33 - Submarine Extended Operating Cycle (SEOC) Program
- (g) COMNAVSUBFOR OPORD 2000
- (h) OPNAVINST C3000.5 - Operation of Naval Nuclear Powered Ships
- (i) NAVSEA S9086-DA-STM-000 - NSTM Chapter 100 (Hull Structures)
- (j) NAVSEA S9086-C4-STM-000 - NSTM Chapter 094 (Trials)
- (k) COMNAVSUBFORINST 5400.25 - Standard Submarine Supply Department Organization and Regulations Manual
- (l) COMNAVSUBFORINST 5400.29 - Standard Submarine Navigation/Operations Department Organization and Regulations Manual
- (m) COMNAVSUBFORINST 5400.40 - Standard Submarine Combat Systems Department Organization and Regulations Manual (SSN)
- (n) COMNAVSUBFORINST 5400.41 - Standard Submarine SSBN 726 Class Weapons Department Organization and Regulations Manual
- (o) COMNAVSUBFORINST 5400.47 - Standard Submarine Combat Systems Department Organization and Regulations Manual (SSGN)
- (p) NAVSEA 0924-062-0010 - Submarine Safety (SUBSAFE) Requirements Manual
- (q) OPNAVINST 9110.1 - Policy Concerning Submarine Test and Operating Depths
- (r) OPNAVINST C9210.2 - Engineering Department Manual for Naval Nuclear Propulsion Plants
- (s) NAVSEAINST C9094.2 - Submarine Valve Operation Requirements for Builders and Post-Overhaul Sea Trial Test Dives
- (t) NAVSEA 0989-LP-043-0000 - Commissioned Surface Ship General Reactor Plant Overhaul and Repair Specification
- (u) OPNAVINST 4700.7 - Maintenance Policy for U.S. Naval Ships
- (v) COMLANTFLTINST 5400.2 - U.S. Atlantic Fleet Regulations
- (w) COMPACFLTINST 5400.3 - U.S. Pacific Fleet Regulations
- (x) NAVSEAINST C9210.4 - Changes, Repairs and Maintenance to Nuclear Powered Ships

LISTING OF APPENDICES.

- A Sample Message to TYCOM from ISIC Requesting Concurrence to Defer, Delete or Shorten a Scheduled CMAV
- B Sample TYCOM Message Concerning Escort Services for IDD or PIRA Availabilities
- C Suggested Format for a Message Work Candidate
- D Business Case Analysis Tool
- E1 Availability Key Event List
- E2 CMAV Key Event Codes
- F Availability Planning Message (Submarines Only)

G	Final 100 Hours for Scheduled CMAV
H ₁	Availability Milestone Schedule (SSNs and SSGNs Only)
H ₂	Availability Milestone Schedule (SSBNs Only)
I	Availability Planning Response Message (Submarines Only)
J	Major Trial and Inspection Milestones for IDD and PIRA Availabilities
K	Sample ISIC Message to TYCOM Concerning Crew Certification and Material Condition for Fast Cruise and Sea Trials for IDD or PIRA Availabilities
L	Sample Ship Message to ISIC and TYCOM Concerning Material Certification Upon Completion of Sea Trials for IDD or PIRA Availabilities
M	Dock Trials Guidelines for IDD or PIRA Availabilities
N	Fast Cruise Requirements for IDD or PIRA Availabilities
O	Sample ISIC Message to TYCOM Concerning Final Material Certification Prior to Sea Trials for IDD or PIRA Availabilities
P	Sample TYCOM Message to Ship Concerning Sea Trials Depth Authorization for IDD or PIRA Availabilities
Q	Minimum Sea Trials Requirements for IDD or PIRA Availabilities
R	Submarine Sea Trial Situation Report (SITREP)
S	Sample TYCOM Message To Ship Concerning URO for IDD or PIRA Availabilities
T	Sample Ship Message to TYCOM Concerning Readiness for Follow-On Sea Trials for IDD or PIRA Availabilities
U	Sample ISIC Message to TYCOM Concerning Material Certification for Follow-On Sea Trials in Cases Where a Previous Sea Trial was Aborted or Corrective Actions for Sea Trial Deficiencies Require an Additional Deep Dive for IDD or PIRA Availabilities
V	Sample TYCOM Message to Ship Concerning Follow-On Sea Trials Depth Authorization for IDD or PIRA Availabilities
W	Sample Ship Message to ISIC Concerning Readiness for Fast Cruise for IDD or PIRA Availabilities
X	Sample ISIC Message to Ship Authorizing Commencement of Fast Cruise for IDD or PIRA Availabilities
Y	Sample Ship Message to ISIC and TYCOM Concerning Readiness for Sea Trials for IDD or PIRA Availabilities

4.1 PURPOSE. Provide guidance for the implementation of policies set forth in references (a) through (x) for Fleet Maintenance Availability planning, scheduling, and execution. Policy, procedures and guidance regarding utilization of Fleet Technical Assistance (FTA) program resources are contained in Volume VI, Chapter 2 of this manual.

4.2 DEFINITIONS.

4.2.1 Fleet Maintenance Activity. All government waterfront ship maintenance and modernization, activities, e.g., Regional Maintenance Centers, Naval Ship Repair Facilities, Naval Submarine Support Facilities, Naval Intermediate Maintenance Facilities, TRIDENT Refit Facilities, Weapons Repair Facilities, Naval Shipyards, tenders and other activities of that type responsible for the processing, screening and brokering, and execution of work candidates.

4.2.2 Lead Maintenance Activity. The single activity responsible for integrating all maintenance and modernization on US Naval ships during any type availability. The Lead Maintenance Activity (LMA) is the activity responsible for planning and coordinating the work of the Executing Activities in Continuous Maintenance (CM). The LMA may also be an Executing Activity.

4.2.3 Executing Activity. The public or private enterprise that is assigned or awarded the responsibility for accomplishing the actual production work to effect repairs or modernization to ships.

4.2.4 Business Case Analysis. A critical evaluation of late identified work, new work or growth work, based on the benefit of completing the work, the cost of the work to be performed including premiums, available work capacity and material resources, the risk to other work and schedule impact.

4.2.5 Planning Board for Maintenance. The regularly scheduled meeting of the ship's Maintenance Team, as required by Chapter II-II-1 and defined in Chapter VI-41 of this manual, to discuss ship wide maintenance issues. Chaired by the Ashore Ship's Maintenance Manager, this forum provides a review of current planned off-ship and organizational maintenance, Current Ship's Maintenance Project (CSMP) quality and accuracy, future maintenance and modernization planning, and fiscal concerns. The objective is to ensure clarity of intent for both the ship's efforts and the shore infrastructure with respect to total ship maintenance, operational schedules, and other concerns affecting ship material readiness.

4.2.6 Maintenance and Modernization Business Plan. The Maintenance and Modernization Business Plan (MMBP), located in Volume VI, Chapter 33 of this manual, prepared six to eight months in advance of the fiscal year, is the ship's plan for maintenance and modernization effort for a fiscal year. The ship's maintenance team prepares the plan. The Maintenance Team applies its knowledge of the ship's material condition and Type Commander (TYCOM) scheduled modernization and Chief of Naval Operations (CNO) availabilities in the prospective operating cycle to develop the budget recommendation for funding maintenance requirements. The plan is based on an assessment of the ship's anticipated material condition, the validated CSMP including Class Maintenance Plan (CMP) applicable tasks, planned fleet alterations, outstanding Departures from Specifications (DFS), Casualty Reports (CASREP) and Board of Inspection and Survey material discrepancies. The MMBP shall address funding required for CNO availabilities advanced planning and CM opportunities.

4.2.7 Immediate Superior In Command. In the context of this chapter the TYCOM may act in support of or in the place of the Immediate Superior In Command (ISIC) for maintenance.

4.3 FLEET MAINTENANCE AVAILABILITIES. Fleet maintenance availabilities consist of the following:

4.3.1 Ship's Force Upkeep. A Ship's Force Upkeep is a scheduled period in which the ship is principally engaged in self-maintenance.

4.3.2 Scheduled Continuous Maintenance Availability. A Scheduled Continuous Maintenance Availability (CMAV) is a scheduled availability normally 2 to 6 weeks in duration and normally scheduled once per non-deployed quarter during a period when the ship will be in port.

NOTE: **SUBMARINE MAINTENANCE MODERNIZATION AVAILABILITIES MAY BE 2 TO 6 MONTHS LONG. THESE AVAILABILITIES CAN BE MANAGED SEPARATE FROM THE REQUIRED MAINTENANCE AVAILABILITIES OR INCORPORATED IN THE REQUIRED MAINTENANCE PERIODS AT THE DISCRETION OF THE PLANNING BOARD FOR MAINTENANCE (PB4M) AND ISIC. MODERNIZATION AVAILABILITIES WILL INCLUDE KEY EVENTS AND CERTIFICATION MILESTONES PRIOR TO AT-SEA OPERATIONS AND MAY REQUIRE SEA TRIALS AS APPROVED BY THE PB4M AND ISIC IN ACCORDANCE WITH THIS CHAPTER.**

- a. Submarines - The Scheduled Continuous Availability requirement is mandatory. It cannot be deferred, deleted or shortened without TYCOM (N43) concurrence. Appendix A of this chapter contains a sample message to TYCOM from ISIC requesting concurrence to defer, delete or shorten a scheduled CMAV.
 - (1) For SSNs one regular CMAV every 3 to 4 months, of which a minimum of 21 days are dedicated to production work. SSN maintenance availabilities required to support the Fleet Response Plan will be scheduled in accordance with reference (a). SSN CMAV milestones are outlined in Appendix H1 of this chapter.
 - (2) For SSGNs the maintenance schedule for a 20-24 month operating cycle will be scheduled in accordance with reference (b) to include three to five forward deployed 21 day CMAVs. SSGN CMAV milestones are outlined in Appendix H1 of this chapter.
 - (3) For SSBNs, one 35 day CMAV will be conducted per patrol cycle. Docking CMAVs will be scheduled periodically by the TYCOM to meet URO MRC requirements. SSBN CMAV milestones are outlined in Appendix H2 of this chapter.

- b. Carriers - As Scheduled.
- c. Surface Ships - At a minimum, one 3-week CMAV per non-deployed quarter. Surface Force Ship CMAV milestones are outlined in Part II, Chapter 2, Appendix D of this volume.

4.3.3 Unscheduled Continuous Maintenance Availability. The Unscheduled CM Availability is a single yearlong availability, for the period 01 October through 30 September, scheduled for each ship every fiscal year. The Year Long Unscheduled CM Availability is for the scheduling and completion of non-emergent work items that are not accomplished during any other schedule availability.

4.3.4 Emergent Availability. The Emergent Availability (EM) is designed for work of such an urgent nature that the heightened risk of disruption and paying of premiums is accepted and planning horizons are shortened.

4.4 COMMON ELEMENTS.

4.4.1 Responsibilities. Responsibilities regarding maintenance policies and procedures for Fleet maintenance availabilities are as follows:

4.4.1.1 Immediate Superior In Command.

- a. Coordinate scheduling of availabilities at LMAs with TYCOMs.
 - (1) Monitor corrective maintenance action taken by LMA/Executing Activities.
 - (2) Schedule and conduct inspections of Forces Afloat.
 - (3) Monitor progress of availabilities.
- b. Initiate the required budgetary actions for funding availabilities.
- c. Ensure all authorized alterations are identified by priority based on material availability.
- d. Identify the routine package to be accomplished based on Master Specification Catalog/Master Job Catalog (MJC) review (as appropriate).
- e. Review results of scheduled monitoring inspections and testing that could result in significant new work or could impact scheduled work.
- f. Identify required special evolutions associated with availabilities in support of Pre-Overseas Movement preparations and pre-availability test and inspection requirements.
- g. Issue availability planning message.
- h. (Submarines only) Ensure all Periodic Maintenance Requirement (PMR) and Unrestricted Operation Maintenance Requirement Card maintenance actions intended for accomplishment during availability are identified.
- i. (Submarines only) Send a Sea Trials Support Services message to specify Deep Submergence Rescue System "modified-alert" requirements in accordance with Appendix B of this chapter.
- j. (Submarines only) Provide updated Sea Trials status by telephone to Commander, Submarine Squadron (COMSUBRON) ELEVEN if Deep Submergence Rescue System "modified-alert" support services are in use.
- k. (Submarines only) Identify key events for each CMAV during the pre-arrival conference. Determine if Fast Cruise and/or Sea Trails is/are required based on the scope of the availability work, alterations and modernization. The ISIC will task the PB4M/Regional Maintenance Center (RMC) to submit the Fast Cruise and/or Sea Trials agendas for ISIC approval in accordance with paragraph 4.6.3.3 of this chapter.
- l. (Submarines only) Monitor Ship and Executing Activity preparations to transition to a CMAV period and make final report that the ship has transitioned to the CMAV period after the completion of the arrival conference to the Group and TYCOM.

4.4.1.2 Regional Maintenance Center/Lead Maintenance Activity. (As appropriate)

- a. Develop recommended Key Event schedule and present to the ISIC/Ship's Force.

- b. Conduct ship checks, plan work candidates and order required material.
- c. Recommend returned work candidates to the RMC ISIC, as applicable.
- d. Develop strategy using the guidance found in Volume VI, Chapter 9 of this manual to accomplish calibration of systems, gages, instruments and tools in support of Ship's Force requested work and the availability milestones.
- e. Identify and order Long Lead Time Material (LLTM).
- f. Review the Availability Work Package, write Formal Work Package (FWP)/Technical Work Documents (TWD), identify critical jobs and develop an Integrated Work Schedule (IWS) to aid in tracking and coordination of all work.
- g. Conduct the Work Package Execution Review (WPER).
- h. Conduct arrival conference.
- i. Conduct daily and weekly meetings.
- j. Issue Departure and Assessment report in accordance with paragraph 4.6.3.2.e of this chapter.

4.4.1.3 Ship's Maintenance Team. (Commanding Officer (CO))

- a. Validate, broker, schedule, and track through execution all maintenance candidates.
- b. Manage Ship's MMBP.
- c. Maintain a current and valid CSMP that serves as the single authoritative source for all maintenance requirements.
- d. Develop, plan and coordinate Ship's Force Upkeeps, CMAVs, CMs, and EMs and repairs within the resources provided.
- e. Prioritize all deferred maintenance actions intended for accomplishment during an availability.
- f. Develop a strategy for calibration of gages, instruments and tools.
- g. Publish a policy concerning number of duty sections, liberty, ship cleanliness, tagout procedures, tank closeout and installation of blank flanges of otherwise exposed fluid systems, waveguide and air systems before the availability starts.
- h. Assign an Officer/Chief Petty Officer to serve as the Availability Coordinator, responsible for coordinating the completion of all pre-availability and availability milestones.

4.4.1.4 Assigning Lead Maintenance Activity/Ship's Force Maintenance Responsibility. The RMC/ISIC assigns work responsibility for each maintenance item in an availability work package. The assignment of work responsibility will be such that split responsibility between two organizations does not occur for the same unit task on a maintenance action. The following guidelines apply:

- a. The Fleet Maintenance Activity (FMA) will remove all controlled system interference as defined in Volume V, Part I, Chapter 2 of this manual and Ship's Force will remove all other interference.
- b. The following are examples of maintenance actions requiring Intermediate Level shop work that will be assigned as "ship-to-shop":
 - (1) Calibration and repair of portable equipment, removable gages, and rack-out electronic equipment/meters.
 - (2) Manufacture of components which do not require fit-up in a larger assembly, or that are fabricated with a sample provided by Ship's Force.
 - (3) Small flanged or bolted valves and operators sized 2.5 IPS and below.
 - (4) Small components such as pumps, motors, controllers, deck plates, access covers and lockers.

4.4.1.5 Fleet Maintenance Activity/Nuclear Regional Maintenance Department Radiological Controls Support. In order to fully use the FMA radiological controls resources, Ship's Force shall request FMA/Nuclear Regional Maintenance Department (NRMD) radiological support for their jobs that involve significant radiological controls. The following guidelines apply:

- a. FMA/NRMD will provide full radiological control support including material, surveys, supervision and instructions for radiological aspects of the job.
- b. FMA/NRMD will provide mock-up training, when necessary, for Ship's Force personnel performing the actual work.
- c. Ship's Force jobs which fall into this category include, but are not limited to, retention tank (or equivalent) inspection, nuclear instrument detector replacement, and primary plant venting or draining evolutions.
- d. As an example, during a retention tank inspection, an FMA/NRMD would:
 - (1) Construct and certify the containment tent.
 - (2) Conduct the necessary pre-job, in process and post-job surveys.
 - (3) Train Ship's Force personnel in the use of air fed hoods.
 - (4) Provide radiological monitoring.
 - (5) Review and comment on the Ship's Force work procedure.
- e. The FMA/NRMD should develop standard radiological work procedures to be used in developing FWP/TWDs in support of Ship's Force jobs. The service of the Fleet Maintenance Support Branch should be used by FMAs, when necessary, to formulate these work procedures.

4.4.2 Submission of Work Candidates.

4.4.2.1 Documenting Requests. Requests by Ship's Force for corrective maintenance assistance or support equipment from outside activities will be appropriately documented on an Automated Work Request form 4790-2K or form 4790-2L of reference (c) or message work candidate in accordance with paragraph 4.4.2.2 of this chapter, and prioritized in accordance with reference (c). The work candidate will be promptly forwarded for processing. The description of the deficiency or support requested and the action desired shall be complete and clear. This description must be in sufficient detail to allow LMA personnel to plan, obtain parts and assemble the correct tools.

4.4.2.2 Message Work Candidates. Messages may be used to notify the FMA as early as possible when data systems up-lines are not available. This is particularly applicable to ships in transit between FMAs, and ships scheduled to return to port shortly before starting an availability. Accordingly, ships should submit message work candidate requests to the parent RMC/ISIC, with an information copy to the tending LMA and tending Squadron/RMC (if different), for items of this type. Where the change of LMA occurs coincident with a change in Operational Control, the (new) tending Squadron/RMC should be action addressee for the message, with both the parent RMC/ISIC and (new) LMA as information addresses. Appendix C of this chapter provides the format for a message work candidate.

4.4.3 Critical Jobs. Critical Jobs (CJ) are those jobs or series of jobs that require special management attention and normally present the greatest risk to on-time completion of the key event or availability. The Executing Activity should be judicious in designating jobs as CJs to prevent diverting management attention from those jobs which are, in fact, critical to on time completion of the availability. Consideration shall be given to, but not limited to, the following in determining the CJs:

- a. Little or no room for delay exists.
- b. Establishing plant conditions.
- c. LLTM.
- d. Complexity of job or special skills or resources required.
- e. Significant test requirements.

- f. Not previously accomplished by the Executing Activity (alterations, etc.).

4.4.4 Integrated Work Schedule. The IWS is an integrated timeline that includes plant conditions, major work steps, tests and recertification used to progress all jobs as determined by the Naval Supervisory Authority (NSA)/LMA. The IWS should include:

- a. Establishing plant conditions.
- b. Major production steps.
- c. Testing/Recertification.
- d. Closing out work procedures.

4.4.5 Technical Assistance and Assessment. Technical assistance and assessments are to be assigned as work candidates within any of the following Fleet maintenance availabilities:

- a. CMAV.
- b. CM.
- c. EM Availabilities.

4.4.6 Late Work and Scope Control.

- a. The complete LMA Availability work package is defined and agreed upon at the WPER. To provide for adequate time to plan the work and acquire the necessary materials in an efficient manner, the work submission cut-off date should not exceed the milestones listed in Appendix H1 and H2 of this chapter for submarines or Part II, Chapter 2, Appendix D of this volume for Surface Force Ships. A minimum of 30 days will be allotted for known work to be brokered to I-Level activities. This will allow a WPER to take place in accordance with the platform specific milestones. If these minimum thresholds cannot be complied with, the Maintenance Team will complete a Business Case Analysis in accordance with paragraph 4.4.6.b. of this chapter.
- b. The Maintenance Team will perform a Business Case Analysis as a method of identifying risks associated with adding late work after the submission cut-off date identified in Appendix H1 and H2 of this chapter for Submarines and Part II, Chapter 2, Appendix D of this volume for Surface Force Ships. The Business Case Analysis is described in Appendix D of this chapter. Late work identified after the submission cut-off date should not extend the availability completion date. The RMC/ISIC will take appropriate actions to make job tradeoffs, defer jobs to a subsequent availability or seek outside assistance to conduct the work.
- c. Non-mission essential late work may be accepted on a case by case basis. The ISIC will provide approval authority for all late work after establishing that the LMA can support the additional work load and the scope of work does not impact the ship's operational schedule or schedule of other operational units.

4.4.7 Memorandum of Agreement. For all Surface Force Ship and Aircraft Carrier availabilities not assigned to an FMA, a Memorandum of Agreement (MOA) will be issued. The purpose of the MOA is to define areas of responsibility for all activities involved with the availability. For all submarine availabilities involving maintenance within the Submarine Safety (SUBSAFE) boundary, **Scope of Certification (SOC) boundary and Fly-By-Wire (FBW) boundary**, a MOA will be issued.

4.4.8 Radiological Controls. Nuclear powered vessels are responsible to implement and ensure adherence to radiological controls in accordance with reference (d). Industrial activities authorized to perform nuclear maintenance are responsible to engineer appropriate radiological controls into assigned work.

4.4.9 Ship to Shop Material Control. Positive identification and control of ship to shop transfer of equipment and components is maintained through the use of a Ship to Shop tag. The Ship to Shop tag may also be used in conjunction with other methods specified by the Executing Activity or the LMA. Each Executing Activity shall make sure that positive control exists for those subcomponents of equipment and components received with a Ship to Shop tag attached. The procedure for using the Ship to Shop tag is provided in Volume V, Part I, Chapter 11 of this manual.

4.4.10 Shipchecks. The LMA or Executing Activity shall conduct ship checks, when the tended ship is available in order to support process milestones, to verify the scope of work, identify interference, obtain equipment technical data, identify shipping (rigging) paths, verify system/equipment configuration and obtain additional problem identification data from Ship's Force. Shipchecks shall be conducted as early in the planning phase as possible.

4.4.11 Lead Maintenance Activity Daily Production Meeting. This meeting is for the coordination of ongoing work for all availabilities. The LMA Repair Officer/Production Officer, or their designated representatives, will conduct a Daily Production Meeting for all ships in availabilities.

- a. Purpose. The primary purpose of the LMA Daily Production Meeting is to establish a joint Executing Activity/Ship's Force production plan and eliminate schedule conflicts that impact work for at least the next seven shifts (56 hours). It further tracks the current status of CJs. The results of this meeting are used to assess overall progress of the work, develop recovery plans when necessary and to ensure all the activities understand the production plan and support requirements during a minimum of the next seven shifts (56 hours).
- b. Execution. The Daily Production Meeting will be held as early in the day as practicable.
- c. Attendees. Representatives of the LMA Waterfront Operations, the Executing Activities, the tended ship, and LMA Supply or Fleet Logistics Center, as appropriate, shall attend this daily production meeting and participate in its agenda. Others may attend as requested by the LMA.
- d. Agenda. The following agenda will be used for the LMA Daily Production Meeting. Additional items may be added at the discretion of the Waterfront Operations Officer, Repair Officer or Production Officer.
 - (1) Discuss specific work scheduled to be accomplished and support required over the next seven shifts.
 - (2) Discuss projected site evolutions (ship moves, weapons moves, pier maintenance, or changes of command, etc.) which could impact production work.
 - (3) Discuss respective ship evolutions such as stores load or Fast Cruise that could impact production work.
 - (4) The Executing Activity brief on the current status of CJs on each ship.
 - (5) Review Safety of Ship Maintenance Item List, necessary safety precautions and their status.

4.4.12 Lead Maintenance Activity Progress Review. This review will be conducted weekly for surface force ships and submarines in CMAVs.

- a. Purpose. The primary purpose of the LMA progress review is to ascertain that CJs and Key Events are progressing satisfactorily for on time completion of the availability. The meeting shall also identify and resolve any issues, conflicts or differences since availability start or last review. These meetings may be conducted in conjunction with a ship's PB4M.
- b. Execution. This review shall be conducted by the Waterfront Operations, Repair Officer, Production Officer, or their representatives and be scheduled so as not to conflict with daily production meetings.
- c. Attendees. As a minimum the following shall attend this review.
 - (1) Waterfront Operations Officer, Repair Officer, or Production Officer.
 - (2) Ship Superintendent and designated Executing Activity representatives.
 - (3) Tended ship CO.
 - (4) Availability Coordinator and designated Ship representatives.
 - (5) ISIC/RMC designated representatives.
 - (6) Maintenance Support Team (MST) Officer In Charge (OIC) (if applicable).

- d. Agenda. As a minimum the following agenda shall be used for LMA progress review. Additional items may be added at the discretion of the Waterfront Operations Officer, Repair Officer, Production Officer, ship CO, or ISIC. Attendees shall be prepared to discuss their respective portions of the agenda.
- (1) Specific work scheduled for accomplishment during the availability.
 - (2) Projected Executing Activity and ship evolutions which could impact production work on ship(s).
 - (3) Discuss current status of CJs and Key Events listed in Appendix E1 (Submarines Appendix E2).
 - (4) Heavily loaded Executing Activity work centers and impact on the availability.
 - (5) Status of funds, supplies and equipage funding.
 - (6) Status of outstanding DFS scheduled for correction during the availability.
 - (7) Outstanding high priority repair material status.
 - (8) Provide Automated Work Requests (AWR) or a list of completed work with applicable 3-M final action taken codes in accordance with reference (c).
 - (9) For ships with work in the Year Long CM or EM Availability no separate formal meeting is required. Rather, issues with these availabilities should be a part of the routine PB4M held by the ship's maintenance team or special meetings as needed to properly monitor and manage the ongoing maintenance.
 - (10) (Submarines Only) Ship's Force will brief the status of all scheduled K-MRCs to include time critical K-MRC status, completion percentage and schedule to complete outstanding K-MRCs in the availability.

4.4.13 100 Hour Transition Periods (Submarines only). The 100 hours at the beginning and at the end of a CMAV are critical times for availability execution. The ISIC, LMA and ship are responsible for coordinating the 100 hour plan. Any job or event that is viewed as hindering the start of the availability shall be included in the 100 hour plan. Communication is vital to ensuring a full understanding of all work and associated requirements. The 100 hour transition plans will be outlined in the Availability Planning Message in accordance with Appendix F. Details for the first and final 100 hours shall be as follows.

4.4.13.1 First 100 Hour Plan (Submarines only). The First 100 Hour Plan will notionally start the first full work day of the availability. The items listed below are the focus of the first 100 hours and will be discussed at the Arrival Conference.

- a. Establishing plant conditions/work controls.
- b. Working hours.
- c. Jobs still requiring ship checks will be listed in the availability planning message.
- d. Test forms required for Ship's Force retest of FMA work will be delivered to the ship within the first 100 hours for Ship's Force to review, plan and write procedures as necessary.
- e. Time critical jobs that will start during the first 100 hours. Completion of all time critical K-MRCs as determined at the A-21 meeting with the maintenance team. Time critical K-MRCs are those that:
 - (1) Would result in long repair times if failed.
 - (2) Require unique plant conditions which conflict with required plant conditions for other scheduled work (e.g., seawater hull and backup valve cycling when seawater systems must be secured for maintenance or trim and drain pump performance test when trim and drain systems are to be secured).
 - (3) K-MRCs that have a poor historical performance based on review of the RMC curve at A-21.

4.4.13.2 Final 100 Hour Plan (Submarines only). The Final 100 Hour Plan will notionally begin four days prior to the last day of the ship's scheduled CMAV. Items listed below must be completed prior to the 100 hour point. Appendix G will provide an outline of the final 100 hours.

- a. Production work complete - it is vital all production work is completed by the 100 hour point to allow for the remaining event to occur without delay.
- b. Weapons handling.
- c. Testing associated with production work is completed.
- d. Sail closeout.

4.5 SHIP'S FORCE UPKEEP. Ship's Force Upkeep availability is a scheduled period in which the ship is conducting self-maintenance in accordance with reference (c), training, supporting inspections by outside activities, and performing routine shipboard evolutions. Ship's Force Upkeep availability can be accomplished at sea when the ability of the ship to perform its assigned missions and tasks is not affected and the work is accomplished onboard the ship. Scheduled Ship's Force Upkeep periods shall not be interrupted for other than emergency reasons.

4.5.1 Upkeep Work Planning.

4.5.1.1 Planning Sources. The upkeep work package shall be developed using three sources:

- a. Planned Maintenance System (PMS) shall be scheduled in accordance with reference (c).
- b. Reactor Plant PMS shall be scheduled in accordance with reference (e).
- c. CSMP will be reviewed to ensure scheduling and accomplishment of all work which is within Ship's Force capability.

4.5.1.2 Ship's Force Planning Actions.

- a. Preparation for Ship's Force Upkeep should be the normal activity of the maintenance team and be discussed at PB4M meetings.
- b. Review all Ship's Force screened CSMP work candidates and identify those items to be accomplished within the scheduled Ship's Force Upkeep period.
- c. Identify CJs.
- d. Develop an IWS in accordance with paragraph 4.4.4 of this chapter to aid in tracking and sequencing CJs.
- e. Establish strategy for Ship's Force calibration of gages, instruments, and tools based on the onboard Calibration Recall List.
- f. Develop FWPs, Controlled Work Packages, and TWDs, as required, in accordance with Volume V, Part I, Chapter 2 of this manual.
- g. (Submarines only) Identify operational Unrestricted Operation (URO) Maintenance Requirement Cards (MRC) to be accomplished during the availability. The ship shall identify the plan to accomplish PMRs called down by the ISIC and identify any conflicts affecting the PMR execution.

4.5.2 Ship's Force Upkeep Work Execution. Duty section, division meetings, and/or shift briefings will be conducted as necessary to discuss current status of work and projected work progress expected for the period covered. The status and projections will be based on CJs and the IWS and should be reviewed at the regular ship's PB4M Maintenance Team meetings.

4.5.3 Ship's Force Upkeep Work Completion.

4.5.3.1 Management Closeout Procedures. Upon completion of repairs, FWPs, Controlled Work Packages, and TWDs will be closed out in accordance with Volume V, Part I, Chapter 2 of this manual. Update the CSMP. Ensure non-conformances (Waivers/Deviations or Departures from Specification) submitted during the availability by any activity are approved prior to trials at sea (if held) and not later than the completion of the availability.

4.5.3.2 Dock Trials/Fast Cruise/Sea Trials. Dock Trials, Fast Cruise and Sea Trials shall be conducted as required. Sample agendas in Part I, Chapter 3 of this volume may be modified, as necessary, to ensure the equipment which was worked during the upkeep is exercised prior to at sea operation.

4.5.4 Ship Certification Prior to Underway (Submarines only). Ship and Executing Activity provide the ISIC a written report of ship's certification continuity prior to underway in accordance with Volume V, Part I, Chapter 5 of this manual. If Upgrades/Alterations or Major Repair Work of the FBW SCS was performed by TYCOM managed activities, the ISIC will accomplish a 100% audit, as defined in Volume V, Part I, Chapter 9 of this manual of the work. ISIC and TYCOM will use the FBW message reporting process for certification specified in Part I, Chapter 3 of this volume for availabilities of less than six months duration.

4.6 SCHEDULED CONTINUOUS MAINTENANCE AVAILABILITY.

4.6.1 Scheduled Continuous Maintenance Availability Planning. Thorough, detailed planning is an absolute prerequisite to effective CMAV execution. Effective CMAV management begins well before the ship arrives with material procurement and job planning. Appendices H₁ and H₂ of this chapter are typical submarine CMAV Milestone Schedules to be used by all activities involved in planning and executing the submarine availability. The Surface Force Maintenance and Modernization Milestones are located in Part II, Chapter 2, Appendix D of this volume.

4.6.1.1 Scheduled Continuous Maintenance Availabilities Planning Sources. A significant portion of the CMAV Work Package can be identified in advance from five basic sources. Submarines, will also execute a planning availability as described in sub-paragraph f. below.

- a. Ship's CSMP. This document contains work items deferred during previous maintenance availabilities as the result of inadequate material support, outstanding DFS, drydock requirements, etc. To ensure the CSMP accurately reflects the required ship's maintenance, the Maintenance Team and ISIC will review each ship's CSMP in detail with Ship's Force during routine PB4Ms and prior to every maintenance availability.
- b. Ship's Force Planned Maintenance. Ship's Force shall conduct a review of PMS and Reactor Plant PMS requirements (where applicable) and ensure all maintenance actions are identified. In particular, an in-depth review of scheduled K-MRCs is required so that they are properly integrated into the planning process.
- c. PMR/URO electronic files (Submarines only). Submarine Maintenance Engineering, Planning and Procurement (SUBMEPP) Activity provides electronic files of PMR/URO maintenance requirements for each ship, as applicable. The ISIC will load these requirements into each ship's CSMP for a specific CMAV.
- d. Alterations (Fleet Alterations, Program Alterations, Ship Changes and Strategic Systems Program Alterations, etc.). The RMC/ISIC will enter alterations on the ship's CSMP that the TYCOM has authorized for accomplishment. The Ship Maintenance Team/RMC/ISIC calls out alterations for a specific CMAV based on material availability and Executing Activity capacity as identified by the Executing Activity. Within funding constraints and TYCOM guidance, all alterations authorized on the TYCOM Alteration Management System (Submarine Force only)/Navy Modernization Process (NMP) are candidates for accomplishment during each CMAV.
- e. Work Routines. A set of standard routines from the MJC should be planned for every CMAV. The ISIC/RMC tailors each CMAV routine package to the needs of the ship by calling out additional routines to document periodic, interim dry docking, URO maintenance (as applicable), and calibration recall requirements, as appropriate.
- f. Planning availability. (SSNs only) A scheduled one week planning availability will normally be scheduled approximately four weeks prior to a scheduled regular CMAV. The purpose of the planning availability is to allow the LMA and other activities scheduled to perform maintenance during the regular CMAV to conduct ship checks and job scoping and inspections (e.g., PMT time critical KMRCs) early enough to write required FWPs/TWDs, order material and develop a cohesive plan for the regular

availability. Only underway limiting repairs should be accomplished during a planning availability. Paragraphs of 4.6.1 and all A-30 items from Appendix H₁ of this chapter shall be addressed and focused on during the planning availability. The results of the planning availability directly feed into the WPER.

4.6.1.2 Scheduled Continuous Maintenance Availability Planning Functions. The Maintenance Team/RMC/ISIC will take the following actions in planning a CMAV. Surface Force Ships see Part II, Chapter 1 of this volume for maintenance validation, screening and brokering.

- a. **Work Package Submission.** Ensure that ships submit a CMAV work packages as scheduled in accordance with Appendix H₁ or H₂ of this chapter for submarines. The Surface Force Maintenance and Modernization Milestones are located in Part II, Chapter 2, Appendix D of this volume. Message work packages may be sent if the ship is not in port. This singular action has significant impact on the ability of both the RMC/ISIC and Executing Activity to properly plan for the CMAV, and determine potential impacts on other planned work.
- b. **PMR/URO Review (Submarines only).** Review PMR/URO requirements and ensure all maintenance actions intended for accomplishment during the CMAV are identified and entered in the CSMP. Using the PMR scheduling system as described in Volume VI, Chapter 24 of this manual, the ISIC will request that all applicable PMR work be added to the ship's CSMP when the SUBMEPP CD-ROM is received. This work is applicable if it is prescribed for the ship and is due in accordance with the associated schedule. PMR and URO work is mandatory. PMR requirements are to be accomplished on or before the scheduled due date listed in the SUBMEPP provided report as contained in the TYCOM PMR scheduling system. PMR requirements which are not accomplished by their scheduled completion date will be rescheduled and identified to the TYCOM in accordance with Volume VI, Chapter 24, paragraph 24.7.3.g of this manual. UROs are to be accomplished by the scheduled due dates or appropriate waivers or DFS must be requested.
- c. **NMP Review.** Review NMP and ensure all authorized alterations intended for accomplishment during the CMAV are identified by priority based on material availability as identified by the Executing Activity. Ensure they are properly entered into the CSMP.
- d. **MJC Review.** Review the MJC and identify the routine package to be accomplished during the CMAV. Ensure it is properly entered into the CSMP.
- e. Review work candidates for applicability of Master Specification Catalog task lists.
- f. Draft Key Event Schedule.
- g. **Work Package Screening.** Screen and forward the assigned prioritized work package to the Executing Activity. Maintenance Team/RMC/ISIC responsibilities for work package screening are established in reference (c). Additional specific requirements are:
 - (1) Ensure work candidates meet the criteria for the level of work and are correctly prioritized in accordance with reference (c).
 - (2) If the assistance requested is for use of the Executing Activity facilities or technical guidance in order for Ship's Force to accomplish planned or corrective maintenance, the submitting ship and TYCOM should be advised to use MJC Routine N0000EXCNA740, (Facilities for Ship's Force Work).
 - (3) If a work candidate is received in message format, the RMC/ISIC shall input the message work candidate into the Maintenance Data System (MDS). For a ship in transit, the parent RMC/ISIC must advise the RMC/ISIC to which the ship is reporting of the desired disposition of the message work candidate.
 - (4) Designate controlled work as defined in Volume V, Part I, Chapter 5 of this manual. Indicate the appropriate governing Key Event.

- (5) (Submarines only) If the equipment is contained in the PMR program and the repair can possibly satisfy the PMR requirement, the ISIC will designate the work as Special Interest in Block 10, note the PMR MJC Job Control Number (JCN) in Block 49, and instruct to call out the MJC item. Enter remarks as necessary in Block 49 preceded by "SQ-", and sign in Block C.
- h. From the Key Event schedule, develop an IWS in accordance with paragraph 4.4.4 of this chapter to aid in tracking and sequencing CJs.
- i. CMAV Funding. CMAV funding targets are developed as a part of each ship's MMBP. RMC/ISIC will establish CMAV funding targets in order to properly and responsibly administer funds, and gain optimum readiness return on each dollar invested.
- j. Submarine Engineering Management, Monitoring and Fleet Support Program Office Performance Monitoring Team (PMT)/Supervisor of Shipbuilding Newport News PMS 312C Material Condition Assessment (MCA) Review. Review scheduled Submarine Engineering Management, Monitoring and Fleet Support Program Office/PMT/PMS 312C MCA inspections, monitoring and testing that may result in significant new work for the Executing Activity or Ship's Force; or that may impact scheduled Ship's Force or Executing Activity work.
- k. Outside Activity Support. Identify outside activities (e.g., Naval Surface Warfare Center, Carderock Division (NSWCCD), Alteration Installation Team, Naval Undersea Warfare Center, Supervising Authority, RMC, Industrial Activity Tiger Team, etc.) participating in the CMAV and their associated support requirements.
- l. Special Evolutions. Identify required special evolutions associated with pre-availability tests and inspections.
- m. WPER. The WPER is conducted with the Executing Activity, ISIC/TYCOM, (and Ship's Force if available) as scheduled in accordance with Appendix H₁ or H₂ of this chapter. The purpose is to finalize the CMAV work package and required evolutions. This is accomplished as noted below. This meeting may be conducted in conjunction with the ship's PB4M.
- (1) Attendees will include the Maintenance Team/ISIC Material Officer/TYCOM Ship's Coordinator, Maintenance Planning Manager, RMC, Ashore Ships Maintenance Manager, Production Officer representative, Executing Activity, Ship's Engineer Officer, MST OIC, Availability Coordinator and the Ship Superintendent (as applicable).
 - (2) Assemble the proposed CMAV work package from the CSMP, PMR/UROs, NMP and MJC, as applicable.
 - (3) Screen the proposed work package to designate the work to be accomplished during the CMAV.
 - (4) Prioritize the proposed work package.
 - (5) (Submarines only) Identify Safety of Ship Maintenance Items List evolutions in Volume IV, Chapter 10, paragraph 10.4.8 of this manual.
 - (6) Designate the CJs.
 - (7) Integrate Executing Activity recommended CMAV Key Event schedule with other ISIC/Ship planned events for the ship, such as weapons moves, fueling, and training events.
 - (8) Review scheduled PMT/MCA testing that may result in significant new work after the CMAV starts.
 - (9) Establish the CMAV berth for pre-staging material and support equipment.
 - (10) Review adequacy of available testing and support equipment needed for the CMAV.
 - (11) Identify other outside activities participating in the CMAV and associated support requirements.

- (12) Identify required special evolutions associated with pre-availability tests and inspections. The result of the CMAV WPER should be an executable work package within the CMAV time frame, budget, and Executing Activity capacity.
- (13) (Submarines Only) Review the plan developed by the ship for the K-MRC completion and ensure it is part of the integrated schedule per paragraph 4.4.13.1.e. of this chapter. Prior to this meeting, Ship's Force engineer and 3M Coordinator will meet with the PMT, TYCOM 3M representative and ISIC together (typically at A-40) to review current K-MRC status, ensure the ship's records match that of PMT and develop a K-MRC execution plan. Any discrepancies will be adjudicated prior to A-21 and provided to the RMC for inclusion in the integrated work schedule. Additionally, PMT will provide RMC curves to Ship's Force in order to help Ship's Force develop a plan to conduct all required K-MRCs during the availability. ISIC will concur with Ship's Force plan for K-MRC completion. All time critical K-MRCs (see paragraph 4.4.1.13.e. of this chapter) should be completed as soon as possible, preferably on the in port transit with PMT aboard (when possible) but no later than the end of the first 100 hours.
- n. Re-screen Work Candidates. Re-screen and assign returned work candidates (in accordance with Part II, Chapter 1 of this volume). Notify ship of final disposition of each item.
- o. Issue Availability Planning Message (Submarines only). No later than two weeks prior to start of the CMAV, send the Availability Planning Message prepared in accordance with Appendix F of this chapter and reviewed during the CMAV WPER, to the ship. It should describe the major work scheduled, controlling Executing Activity and Ship's Force Key Events, PMT/MCA testing, PMR jobs scheduled, alterations to be accomplished by the Executing Activity and Ship's Force, any other scheduled evolutions and 100 hour transition plans. This message should identify the current numbers of components due or overdue from the Calibration/Weight Test Recall Program.

4.6.1.3 Issue Availability Planning Response Message (Submarines only). No later than one week prior to the start of the CMAV, the ship shall certify readiness to transition to a CMAV period, and address any concerns with the Availability Planning Message to TYCOM/ISIC in accordance with Appendix I of this chapter. The following items shall be addressed in the ship's report:

- a. Schedule requirements such as action items from Availability Planning Message, schedule of key events, ability to conduct 100 hour transition plans.
- b. Ship material preparation such as a report status of parts for Ship's Force work and desires for ISIC/TYCOM assistance in procurement and ensuring all outstanding CASREPs, SUBS, ZOZZS and TDENTS are identified in availability planning message.
- c. Ship's Force integrated schedule such as miscellaneous programs (calibration, small valve maintenance, etc.), drills and trainers that will affect Ship's Force ability to support production work, preservation zones and planned maintenance (to include PMS, Reactor Plant PMS, and PMT/KMRCs).
- d. CO's report of readiness or concerns: CO review above items and availability planning message and report readiness and exceptions to transition to CMAV period.

4.6.1.4 Arrival Conference. This conference is conducted by the LMA. The Arrival Conference purpose is to provide an executive level brief to the RMC/ISIC, Executing Activity, MST OIC (if applicable) and ship's CO on the total scope of the CMAV effort and shall be conducted as discussed below. Note that the Arrival Conference may be conducted in conjunction with the PB4M.

- a. Attendees. The Arrival Conference is hosted by the responsible FMA and attended by the following personnel:
 - (1) RMC/ISIC Material representative(s).
 - (2) Executing Activity representative(s).
 - (3) Tended ship, (recommended, as applicable, are the CO, Department Heads, and Availability Coordinator).
 - (4) Site PMT/MCA Officer.

- (5) MST OIC (if applicable).
- b. Agenda. The following items comprise the agenda to be covered during the Arrival Conference:
- (1) Introduction of key FMA, Executing Activity and ship personnel.
 - (2) CMAV material and funding status.
 - (3) Review the CMAV Key Event schedule for potential conflicts.
 - (4) Special evolutions scheduled during the availability.
 - (5) Validate that critical jobs to be accomplished by the Executing Activities and Ship's Force are properly sequenced in the IWS.
 - (6) Introduce the LMA representative as the single point of contact for all elements of the CMAV, including responsibility for coordination of all Executing Activities and Ship's Force. This point of contact may be the Port Engineer, Project Manager, or Ship Superintendent, as applicable.
 - (7) Alterations to be accomplished.
 - (8) Significant material issues.
 - (9) Review status of outstanding DFS, as applicable.
 - (10) Results of arrival inspections and PMT/MCA testing.
 - (11) Issue meeting schedule for the CMAV.
- c. Tended Ship Actions. The ship takes the following actions at this conference:
- (1) Submit a list of key Ship's Force personnel, including officers, Leading Petty Officers/Work Center Supervisors, Quality Assurance Inspectors, Calibration Coordinator and Availability Coordinator.
 - (2) Verify that all known work candidates requiring outside assistance have been identified and work candidates submitted to the LMA/TYCOM or submit known late work candidates for immediate screening.
 - (3) Discuss potential Executing Activity/Ship's Force work interface concerns.
 - (4) Identify Ship's Force/MST (if assigned) planned evolutions that could impact scheduled work and verify that they are properly sequenced in the IWS.
 - (5) (Submarines Only) Ship's Force brief the plan developed by the ship, with help from PMT, for the K-MRC completion and ensure it is part of the integrated schedule per paragraph 4.4.13.1.e. of this chapter.
- d. RMC/ISIC Actions. During this conference, the RMC/ISIC staff will take the following actions (if not already done):
- (1) Review any late work candidates submitted by the ship in accordance with paragraph 4.4.6 of this chapter. Should the late work presented require that other work be deferred, that work to be deferred shall be clearly understood. A Business Case Analysis described in Appendix D of this chapter should be conducted.
 - (2) (Submarines and Aircraft Carriers only). Brief the Key Events schedule for the availability. The ship's Key Events should normally be scheduled in the Pre-CMAV/Availability Planning Message, concurred with by the ship's CO on arrival and input to the MDS by the RMC/ISIC prior to the Arrival Conference. CJs controlling the CMAV completion shall be identified for special management attention by the ISIC, LMA, Executing Activity and Ship's Force.

4.6.2 Continuous Maintenance Availability Execution. CMAVs are complex evolutions characterized by detailed management, closely coordinated RMC/ISIC, Executing Activity and Ship's Force work, systems testing, and other sequenced evolutions such as weapons movements, diver operations and training. Successful CMAV execution requires the closest possible communication and coordinated efforts by the RMC/ISIC, Executing Activity and Ship's Force.

4.6.3 Continuous Maintenance Availability Completion Procedures. The following procedures will be utilized for completing a CMAV. Exceptions are provided for those CMAVs of less than four weeks, or are of a minor scope where the PB4M may be an appropriate forum.

4.6.3.1 Management Reports Close-out Procedures. Upon completion of a scheduled availability, the MDS files must be updated to reflect the current status of work. To accomplish this goal and to ensure that all activities understand the status of all work, the following procedures will be followed:

- a. Upon completion of the assigned work, the LMA or Executing Activity will present a copy of the work candidate or a list of completed JCNs with the applicable final action codes to the ship to obtain concurrence that the described work was completed. Ship's Force will complete all AWRs in accordance with reference (c). Within 2 weeks of completion, the Executing Activities who have performed any configuration change shall submit the form 4790 CK of reference (c) to Ship's Force for submission to Configuration Data Managers Database - Open Architecture.
- b. Within two working days after the completion of an availability, all work centers will ensure that final man-hours have been entered. The ship's superintendent may sign off all Executing Activity routines for the ship. Completed work candidates and AWRs will be a product of the CMAV Departure and Assessment Conference of paragraph 4.6.3.2 of this chapter.
- c. On the third working day after the completion of an availability, the Maintenance Team will ensure that the CSMP ship and shore files reflects the current status of the ship's JCNs and request a Selected Job Management Report by priority for the ship.
- d. On the fourth working day after the completion of an availability, the ship's superintendent will annotate each incomplete JCN on the final Selected Job Management Report by JCN as to its present status and actions required in order to complete the item. Lead work centers must update this status into the MDS.
- e. Within seven working days after the completion of an availability, the Executing Activity will forward copies of the annotated Selected Job Management Report to the ship and ISIC.
- f. Review status of outstanding DFSSs.

4.6.3.2 End of Scheduled Continuous Maintenance Availability Departure and Assessment Conference. This comprehensive review and critique of the availability is another cornerstone of the continuous improvement policy regarding Fleet maintenance.

- a. Purpose. The CMAV Departure and Assessment Conference is held to:
 - (1) Review the conduct of the availability and identify those improvements necessary to increase the effectiveness of Fleet maintenance.
 - (2) Identify the work that was completed during this CMAV and complete the appropriate documents (e.g., work candidates, AWRs, etc.) or produce the list necessary to update the ship's CSMP to reflect the completed work.
 - (3) Identify and reschedule to a future CMAV, the work deferred during this CMAV.
 - (4) Identify any incomplete work candidates and plan of action to complete items.
 - (5) Establish the basic requirements (i.e., initial work package, sequence number and tentative dates) for the next CMAV.
 - (6) Review status of outstanding DFSSs.

- b. Execution. The Departure and Assessment Conference will be held during the last week of the CMAV at a time agreed upon by the Executing Activity Repair Officer/Production Officer and the ship. This meeting may be held in conjunction with the final weekly Management Conference or Progress Review.
- c. Attendees. The Departure and Assessment Conference is arranged, coordinated and chaired by the LMA Repair/Production Officer. Where the LMA is a contractor, the LMA Project Manager may co-chair these meetings with the NSA Project Manager. However, lack of participation by the contractor does not alleviate the NSA Project Manager of this responsibility. The following personnel shall attend this meeting and participate in its agenda:
- (1) ISIC Supply Materials, Weapons/Combat Systems, Electronics Material Officer, and Submarine Engineering Management, Monitoring and Fleet Maintenance Support Program Office/PMT Staff personnel (as applicable).
 - (2) LMA Repair Officer, Production Officer, and Ship Superintendent, or their designated representatives.
 - (3) Tended ship CO, MST OIC (if applicable), Engineer and Availability Coordinator.
 - (4) Others as directed by the TYCOM, ISIC or Executing Activity CO.
 - (5) Executing Activity representatives.
- d. Agenda. The following agenda shall be used for reviewing and assessing the CMAV. Additional items may be added at the discretion of the TYCOM, ISIC, Executing Activity or ship. Attendees will be prepared to address their respective portions of the agenda.
- (1) Review of the CMAV work package to establish status of each item and, for items completed satisfactorily, complete the work candidate/AWR.
 - (2) Review incomplete work candidates that will remain open from this CMAV and identify plan of action to complete these items.
 - (3) Identify and reschedule to a future CMAV the work deferred during this CMAV.
 - (4) Assess the scheduling, execution and quality of work accomplished by each activity during the CMAV.
 - (5) Assess the quality of general services provided by the Executing Activity site.
 - (6) Review recommendations for process improvements and possible LEAN initiatives.
 - (7) Assess lost time that prevented or delayed execution of scheduled work. (Lost time internal to the Executing Activity, e.g., waiting for transportation, assist work center, etc. and lost time caused by the ship such as waiting access, tagout, other Ship's Force support.)
 - (8) (Submarines only) At the end of the first normally scheduled CMAV after a CNO availability, the LMA, via letter, informs the appropriate Naval Shipyard, with copies to the TYCOM, PMS392 and SEA04X, of any identified lessons learned, rework and quality concerns related to Naval Shipyard work.
- e. Results. The LMA shall consolidate the minutes of this meeting into the Departure and Assessment Report to the ISIC and provide a copy to the TYCOM and appropriate planning activity (and NAVSEA 07 for NAVSEA Submarine Repair Activities only). The report shall include:
- (1) List of completed work and/or completed work candidates/AWRs for direct input into MDS to update the ship's CSMP and Configuration Data Managers Database - Open Architecture.
 - (2) Preliminary establishment of the next CMAV.
 - (3) List of policies and processes identified as requiring review for improvement. Proposed process improvements and corrective actions suggested to improve the effectiveness of future CMAVs.
 - (4) Lessons learned from the availability.

4.6.3.3 Fast Cruise/Sea Trials. The ISIC may schedule a one to two day Fast Cruise as part of the CMAV Key Event schedule. This is normally the last major Key Event prior to CMAV completion. As a minimum, the Fast Cruise agenda will include specified drills and evolutions necessary to re-establish proficiency in basic ship operations. It will also include sufficient formal testing to certify that the equipment and systems are fully ready to operate at sea in an operational environment. For CMAVs less than four weeks, the requirement for a Fast Cruise shall be at the ISIC discretion. The necessity of Sea Trials is a function of work performed during a CMAV and may not be required. If the duration or complexity of the CMAV is determined to be sufficient to warrant Sea Trials, the Ship/ISIC/TYCOM (as required by specific Force policy) shall determine if a formal Sea Trial Agenda is necessary, and if required, task the RMC/ship to prepare a formal Sea Trial Agenda for ISIC/TYCOM approval.

4.6.4 Hot Wash/Lessons Learned. For long duration or complex CMAVs, or in cases where there are significant lessons to be learned, Hot Wash/Lessons Learned will be conducted. The Hot Wash/Lessons Learned Conference should be within 30 days of completion of the availability. The Lessons Learned process is described in Volume VI Chapter 39 of this Manual. All key NSA, RMC, LMA, TYCOM or his representative, Executing Activity and Maintenance Team personnel shall attend it. The agenda and details of the meeting shall be determined by the RMC and Maintenance Team and shall be of appropriate length to evaluate the overall scope of the work accomplished. The Hot Wash/Lessons Learned process provides the maintenance and modernization community with a process to identify, resolve, and provide feedback communication on barriers causing inefficiencies or waste within business processes. While there are several milestone meetings within the availability planning and execution process, the feedback process exists to continually collect information to improve processes.

4.6.5 Maintenance Management Performance Goals (Submarine Tenders only). Except for section 4.6.5.1 of this chapter, which is also applicable for RMC I-Level Production Shops, the following maintenance management performance goals are established for Submarine Tender Repair and Weapons Repair Departments. COs and Repair Officers are responsible for making every effort to attain these goals.

4.6.5.1 Activity Performance Summary. The Activity Performance Summary is a compilation of manpower statistics and production indices that are cumulative on a monthly basis. The following information summarizes the content and use of this report:

- a. This report is produced weekly on a cumulative basis for the current month and analyzed by the Production Officer and Repair Officer. This analysis should help determine the relative accuracy and adequacy of the manhour accounting for each work center. The data reflects how each work center is loaded with production work.
- b. On the last day of the month, a complete monthly cumulative report is produced. A thorough review and analysis is conducted by the Repair Officer and Production Officer, similar to the weekly review.
- c. Following review and analysis, the Repair Officer approves the data and the required reports are submitted to the TYCOM (for Submarine Tenders)/Commander, Navy Regional Maintenance Center (for RMC I-Level Production Shops). The TYCOM/Commander, Navy Regional Maintenance Center in turn forwards the data to higher authority.
- d. The Performance Summary provides management with data to determine the capacity of the activity for CMAV maintenance, and subsequent monitoring of the activity maintenance effort conducted on ships. The determination of activity capacity for ship maintenance is the gauge by which managers can evaluate activity productivity while reviewing the report of manhour expenditures.
- e. Activity capacity is a function of both total manpower and the distribution of personnel within the activity. A comparison of Repair Department manning to the manpower authorization should be conducted periodically to ensure activity work centers are not undermanned with respect to rate, Navy Enlisted Classification, and/or number of personnel. This review may determine that local action is required to schedule formal schools leading to the Navy Enlisted Classification acquisition where shortages exist, or may dictate a temporary or permanent reassignment of resources from one work center to another.

NOTE: FOR RMC I-LEVEL PRODUCTION PERFORMANCE SUMMARY, RMCs ARE NOT REQUIRED TO COUNT TRANSIENT PERSONNEL AND OTHERS THAT ARE NOT ABLE TO TRULY ACCOMPLISH OR SUPPORT PRODUCTION WORK, YET ARE ASSIGNED TO I-LEVEL PRODUCTION SHOPS FOR SUPERVISION.

- f. Part One of the activity Performance Summary shows the manpower distribution within the Activity. The Analyst Records and Report Section is responsible for collecting manning information from the activity departments and divisions as a basic input to the Performance Summary. The manning level of the Repair Department is monitored to ensure that this department is properly manned across its work centers.
- g. Part Two of the activity Performance Summary provides departmental manpower usage indicators and statistics. The Productivity Index is a key indicator of activity employment. Each Productivity Index is a ratio of production manhours expended to the production manhours available. Available manhours are computed from the number of production personnel assigned each day, assuming an eight hour work day and no more than five working days per week.
- h. Part Three of the activity Performance Summary is a breakdown of activity manhours expended aboard each tended ship.
- i. Part Four of the activity Performance Summary shows the status of work screened for activity accomplishment.
- j. Part Five of the activity Performance Summary provides the same manhour usage information as Part Two, but broken down by work center.

4.6.5.2 Available Production Hours. The standard workday consists of eight hours of available production work each work day, five days a week. Weekends and national holidays are not considered to have available production work hours. It further requires that TYCOMs will establish policies that maximize available production hours within the context of the total activity mission profile. The activity CO shall implement the eight hour production work day for activity personnel. Reduction in this available effort will be for requisite industrial training, skill qualification, facilities maintenance, and capability certification efforts needed to meet the activity's Mission Profile requirements.

4.6.5.3 Performance Indices.

- a. All factors relative to the following indices must be accurately reflected in the baseline of the FMA computer management system. These factors are:
 - (1) Assigned Manhours. The number of personnel assigned to the activity as production and production support, over the normal eight hour work day and the number of days tending (exclusive of weekends, holidays and days underway), comprise the "Assigned (Gross Available) Manhours".
 - (2) Production Manhours. The manhours actually expended in the progress and completion of work requests authorized for activity accomplishment are those expended by personnel assigned to the activity work centers. The expended manhours by personnel from other departments are not included in the activity's indices, but are credited to other special work centers on the Performance Summaries.
 - (3) Productive Support Ratio for the Department is defined as:

$$\frac{\text{Total Assigned Support Personnel}}{\text{Total Assigned Production Personnel}}$$
- b. A Productive Support Ratio of between 0.65 and 0.85 shall be maintained. A ratio of greater than 0.85 is indicative of an excessive number of FMA personnel assigned to non-FMA tasks. A ratio of less than 0.65 is indicative of a shortage of personnel in Quality Assurance, Planning and other critical production support work centers. For AS-39, local specification is 65% \pm 10%.
- c. Supervisory Ratio. The Supervisory Ratio, production personnel to permanent support personnel, must be a minimum ratio of 7:1.
- d. Supply Production Support. Production work centers shall not have supply function production support personnel assigned such as Repair Parts Petty Officers. The supply support function is assigned to the Planning and Estimating and Repair Other Vehicle work centers. When the production work centers must provide technical details for Repair Other Vehicle supply requests, such research time shall be

reported as production time against the applicable work request. Production managers must ensure the Automated Material Requisitioning system is fully utilized to preclude wasted labor by activity personnel in copying supply data already available from the computer.

e. Department Productivity Index.

(1) The Productivity Index for the Department is defined as:

$$\frac{\text{Total Production Manhours Expended by Department Personnel for the Reported Period}}{\text{Total Production Personnel} \times 8 \text{ hours per day} \times \text{Total Number of Days Tending for the Reported Period}}$$

(2) A Productivity Index for the department should average between 0.55 and 0.75. An index of greater than 0.75 indicates (AS-39 local specification is 55% to 90%):

- (a) Insufficient assignment of production personnel resulting in significant overtime work or deferral of requisite technical skill training and qualification, and proficiency or general military training.
- (b) An excessive amount of overtime work caused by improper workloading of an activity by the ISIC.
- (c) Inaccurate reporting of manhours.
- (d) Inaccurate accounting of assigned personnel (e.g., 340 assigned personnel working and reporting production hours but only 310 shown in the computer as assigned).

f. Work Center Productivity Index. A Productivity Index for individual production work centers for the month could range from 0.25 to 1.35 with a norm of 0.85. However, if the quarterly average for a production work center is less than 0.40, the number of personnel should be reduced.

g. Repair Utilization Index. Repair Utilization Index for the Department is:

$$\frac{\text{Total Support Manhours} + \text{Expended Production Manhours}}{\text{Total Production and Support Manhours Assigned}}$$

The Department Repair Utilization Index requires 45% to 90% for the month.

h. Long-Term Non-FMA Duty Index. There are two special work center codes established to monitor the total Repair Department (10J) and Weapons Repair Department (10K), if assigned, personnel detailed to non-activity duties for greater than 30 continuous days. These numbers should not exceed ten percent of the total assigned activity personnel averaged for the calendar quarter.

4.7 YEAR LONG CONTINUOUS MAINTENANCE. The CM is a single yearlong availability, for the period 01 October through 30 September, scheduled for each ship every fiscal year. The Year Long Continuous Maintenance (YLCM) availability is for the scheduling and completion of non-emergent work items that are not accomplished during any other scheduled availability.

4.7.1 YEAR LONG CONTINUOUS MAINTENANCE PLANNING. Planning sources and actions are similar to those for the CMAV and are included above. Since the continuous availability is a year long, it has no specific arrival date as a reference for the planning milestones. As a result, the milestone dates for the yearlong availability are consistent with those for the scheduled availability but are referenced to the planned execution date(s) of the work item(s). This approach for non-emergent work is intended to reduce premiums and waste for most work candidates by allowing the work to be planned, resourced with manpower and materials in a routine way. The submarine planning Milestones are included in Appendix H₁ or H₂ of this chapter. The Surface Force Planning Milestones are included in Part II, Chapter 2, Appendix D of this volume. The definition of Executing Activity scope that takes place in the WPER of a CMAV does not occur in the YLCM availability as a discrete signal point. Rather LMAs should continuously define scope and schedule across the LMA and assigned Executing Activities at the times described in Appendix H₁ or H₂ of this chapter and Part II, Chapter 2, Appendix D of this volume.

4.7.2 Year Long Continuous Maintenance Work Execution. During the execution period of work items in the YLCM availability, measures should be taken to ensure that Ship's Force, LMA and Executing Activities remain appraised of:

- a. Status of work to be accomplished.
- b. Identities of designated contact personnel.
- c. Status of material and other resources.
- d. Current schedule status.
- e. Special Evolutions that may impact completion of the work items.

4.7.3 Continuous Maintenance Completion. At the end of the fiscal year the availability should be entered as complete and a new availability established for the new fiscal year.

4.8 EMERGENT AVAILABILITY. The EM availability is designed for work of such an urgent nature that the heightened risk of paying premiums is accepted and planning horizons are shortened. This type of availability is for C3/C4 CASREPs, or a C2 CASREP with reasonable potential to become a C3/C4 CASREP. These CASREPs are identified as emergent maintenance and ordinarily funded from emergent funds. The RMC Commander may, with the respective TYCOM's approval, convert Emergent Maintenance funds to execute CNO availability or CM in this regard. Emergent work will be scheduled to minimize premiums in as much as the operational schedule will permit. Generally, C2 CASREPs will be corrected using the CM Process where work is scheduled in the unscheduled Continuous Maintenance availability, a Window of Opportunity or a CMAV, which supports the ship schedule, need and policy objectives minimizing premiums paid and operational schedule impacts.

4.8.1 Emergent Availability Planning. Planning sources and actions are similar to those for the CMAV and are included above. In the case of the EM availability, the milestone dates for the availability are not consistent with those for the scheduled availability and produce added risk of disruptions and payment of premiums. This risk is acceptable only because of the affect of the work on the mission capability of the tended ship. The definition of scope and schedule for emergent work occurs after the definition for both scheduled CMAV and unscheduled CM availabilities when Executing Activities may already be fully loaded and material may need extra effort to be expedited. Additionally, it may result in already scheduled work being deferred.

4.8.2 Work Execution. During the execution period of work items in the EM Availability measures should be taken to ensure that Ship's Force, LMA and Executing Activities remain appraised of:

- a. Status of work to be accomplished.
- b. Identities of designated contact personnel.
- c. Status of material and other resources.
- d. Current schedule status.
- e. Special evolutions that may impact completion of the work items.

4.8.3 Availability Completion. At the end of the fiscal year the availability should be entered as complete and a new availability established for the new fiscal year.

4.9 INTERIM DRYDOCKING/PRE-INACTIVATION RESTRICTED AVAILABILITIES. (Submarines Only.) A scheduled availability for repair activity accomplishment of specific maintenance items, such as URO MRCs. The availability, together with a Material Condition Assessment in accordance with reference (f), can request that the CNO extend the ship's operating interval and/or operating cycle. A Pre-Inactivation Restricted Availability (PIRA) is specifically used to extend the operating interval and/or operating cycle to the inactivation availability for the submarine. An Interim Drydocking (IDD) is specifically used to extend the submarine's operating interval and/or operating cycle to the next CNO scheduled availability other than an inactivation availability. Appendix J of this chapter contains a list of Major Trial and Inspection Milestones for IDD and PIRA availabilities.

4.9.1 Type Commander/Immediate Superior In Command (Group or Squadron) Responsibilities.

- a. Authorize new items and growth industrial work items.

- b. Monitor and approve all changes in established milestones, not internal to industrial activity completion dates.
- c. Issue direction when the quality or completeness of industrial activity work is in question.
- d. Notify the TYCOM when essential Ship's Force work cannot be completed on the scheduled contract or Key Event completion date. Make recommendations for assistance where appropriate.
- e. Periodically assess and monitor shipboard conditions during the availability.
- f. Prior to Fast Cruise, the ISIC Quality Assurance Officer shall conduct a formal audit of Ship's Force Re-Entry Control (REC) and DFS Records. Using the SUBMEPP PMR and URO MRC scheduling reports and current industrial activity/Ship's Force updates to the latest report, ensure all required "D"-Level PMR and URO MRC accomplishment is current. The ISIC shall forward the audit results to the TYCOM via the cognizant Commander, Submarine Group. The ISIC will then report to the TYCOM by message in accordance with message sample format of Appendix K of this chapter the status of the crew/material certification. An update of this certification is needed prior to Sea Trial and following the rescinding of certification noted in paragraph 4.9.9 of this chapter.
- g. Conduct a material inspection of the ship prior to Fast Cruise.

4.9.2 Certification Availabilities (Less Than Six Months) (Submarines Only).

- a. Duties and Responsibilities for Sea Trials and Inspections. Reference (g), as applicable, delineates the TYCOM's responsibility for operational control of assigned submarines during trials and for assuring that the crew and ship have attained satisfactory state of training, administrative, operational and material readiness for at-sea operations during the trials. Appendix L of this chapter provides a Sample Ship Message to ISIC and TYCOM Concerning Material Certification Upon Completion of Sea Trials.
- b. General Instructions for Industrial Activity Availability Trials and Inspections.
 - (1) Fast Cruise may not commence until Dock Trials have been satisfactorily completed and a satisfactory state of crew training (if required) and material readiness (if required), as delineated by this manual, has been certified. The required inspections and tests and their associated time periods may be modified by the TYCOM upon request from the cognizant ISIC.
 - (2) Sea Trials involving escorts will not normally be scheduled to commence on a weekend. When circumstances are such that Sea Trials must be rescheduled or planned to commence on a weekend to avoid costly delays, TYCOM approval will be obtained by the ISIC.
 - (3) Critical operation of reactors while nuclear powered ships are in a naval or commercial industrial activity will be governed by reference (h). The CO may authorize critical operation of the reactor in support of tasks assigned the ship. However, as long as the ship remains in an industrial activity, the CO will notify the Supervising Authority well in advance of any critical operation of the ship's reactor. This notification shall include the nature and duration of such operations.
 - (4) In conducting the inspections required herein, inspectors should be guided by the concept that at the start of Fast Cruise, the ship should be, in all respects, ready for Sea Trials with the exception of the additional training the crew will receive during the Fast Cruise.
 - (5) The requirement for TYCOM SUBSAFE certification of SUBSAFE, **SOC and FBW certification of work** not **performed** by the industrial activity and the material readiness upon completion of an industrial activity availability imposes additional responsibilities on the ISIC inspectors. Included in the material inspection will be a review of all outstanding Forces Afloat DFS as defined in Volume V, Part I, Chapter 8 of this manual. A review of the Ship's Force REC/**Controlled Work Package** Records is necessary for SUBSAFE, **SOC and FBW** work accomplished by Forces Afloat in accordance with Volume V, Part I, Chapter 5 of this manual, along with a review of the applicable URO MRC status.

- (6) The ISIC certification message, in accordance with Appendix K, will also provide a status report of any outstanding Re-Entries, Forces Afloat DFS and delinquent URO MRCs. The scope and nature of this inspection will vary dependent upon the extent and length of the availability. In this regard:
- (a) Material certification may be made subject to the correction of specific deficiencies. (Deficiencies are such that they can be readily identified and listed).
 - (b) Material certification should be postponed to a later date when deficiencies are so significant or so numerous as to preclude correction in the time remaining before the scheduled start of Fast Cruise.
 - (c) Deficiencies that could affect the safe operation of the ship during Sea Trials must be corrected, reinspected and reported to the TYCOM as having been corrected prior to the start of Fast Cruise.
- (7) Inspectors must determine that all work/testing necessary to support Sea Trials has in fact been completed or identified for completion prior to the start of Fast Cruise including the following:
- (a) All ship's systems which affect safe operation during Sea Trials must be operable.
 - (b) All work necessary for safe operation of the ship during Sea Trials which was undertaken by the industrial activity, Ship's Force, FMA, or other outside activities must have been satisfactorily completed and tested. Included must be a check for any special configuration or installations ensuring that they have been authorized by the proper authority, that their impact has been fully assessed and that the Sea Trial Agenda includes these impacts or limitations.
- (8) Following the completion of the required training and material readiness certification, COs must keep the cognizant ISIC fully informed of any changes in personnel, training and/or material status which could affect the validity of certification. Prompt TYCOM notification is required to permit revision or Operational Orders and services required.
- (9) Underway trials following IDD/PIRAs, particularly initial submerged and test depth trials, must be undertaken with the knowledge that the crew lacks recent experience operating as a unit and that the ship's structure and fittings have not been tested in an at-sea environment. All tests and procedures must be conducted carefully and methodically. Systems and components designed to operate at test depth should not be demonstrated at that depth for the sole purpose of proving the design, but instead should be operated at the deepest depth at which they might be used. For example, the hovering system should not be demonstrated at test depth. Trials and tests which are inherently hazardous should not be conducted.
- (10) A schedule is required for each underway, dockside or simulated trial. Prerequisites of the first underway period are: satisfactory ship's material condition as shown by the successful completion of alongside tests, salvage inspection, Ship's Force Dock Trial, and a satisfactory state of training as shown by the successful completion of crew certification inspection and Fast Cruise. Fast Cruise deficiencies affecting safe operations revealed in either material conditions or state of training must be corrected prior to getting underway for Sea Trials.
- (11) The trial schedule shall include a minimum of six hours of Individual Ship Exercises (ISE) for Ship's Force training. This ISE should be sequenced as soon as practical after the initial tightness dive and should include the necessary evolutions to allow each watch section ship control party to familiarize themselves with their assigned stations and duties. The ship should be operated at moderate speed to develop proficiency prior to the deep dive and full power run. Testing may be scheduled during the ISE period on a not-to-interfere basis with training. The time spent in the initial tightness dive, if at moderate speed, may be included as one section's training. The requirement to provide each watch section ship control party with about two hours experience submerged at moderate speed prior to the deep dive and full power run is mandatory for ship's safety.

- (12) All trial periods must be organized such that each member of the command has an opportunity to get six uninterrupted hours of rest during each 24 hour period encompassed by the trials. Sea Trial events which can be accomplished by normal watch sections may be conducted concurrently with crew rest periods.
- (13) Prior to getting underway for Sea Trials, Shipyard, Ship's Force and Type Commander shall jointly agree that the required seven day supply of Oxygen (O₂) and seven day supply of Carbon Dioxide (CO₂) removal capacity will be available in each compartment, based upon the number of expected occupants of that compartment, independent of the supply and removal capacity in the other compartment(s).
- (14) After the conclusion of Sea Trials, the submarine shall not be operated at depths greater than 1/2 Test Depth plus 50 feet, unless specifically authorized by the TYCOM, and shall not be released for unrestricted operations until all RECs are closed and the TYCOM issues the unrestricted operations authorization message.
- (15) After the conclusion of Sea Trials, and based upon a review of Sea Trial deficiencies and TYCOM authorization, the submarine may transit to a port other than the industrial activity.

4.9.3 Operating Depth Policy. The TYCOM's policy with respect to maximum allowable operating depths during trials, evolutions to be performed at the various depths, and the prescribed maximum water depth applicable in each case is stated in Volume VI, Chapter 26 of this manual. In every instance where the maximum authorized operating depth is exceeded, a report shall be made in accordance with reference (i), section 3.3.5.c.

4.9.4 Propulsion Plant Tests (If Required). For full power trials provisions of reference (j), Section 6 applies. Submarine depth during the submerged full power trial should be consistent with the applicable Submerged Operating Envelope (SOE), based on the Emergency Main Ballast Tank (EMBT) blow from maximum authorized operating depth being previously accomplished. The full power submerged ahead test for commissioned nuclear powered submarines shall be terminated by a back emergency bell. The duration of the back emergency shall be limited to 45 seconds, to be followed immediately by an appropriate ahead bell. Caution must be exercised to avoid developing stern way.

4.9.5 Phase II Crew/Material Condition Inspection. A Phase II Crew Certification Inspection is normally not required, but should be determined on a case basis by the parent ISIC. If there will be less than 15% personnel turnover, crew certification may be waived. Should the CO determine that alterations accomplished or the transfer of experienced personnel warrant a crew certification, a formal request shall be submitted to the ISIC. When required, crew certification will be performed in accordance with references (k) through (o). The material certification consisting of an ISIC audit of all Ship's Force SUBSAFE work in accordance with Volume V, Part I, Chapter 9 of this manual will need to be conducted for all industrial activity availabilities since the extent of the availability is such that an independent evaluation by an organization other than Ship's Force is required.

4.9.6 Pre-Critical Inspections. For availabilities where the reactor will be shutdown for 16 weeks or more, it is considered prudent to use an inspection plan similar to that employed by NAVSEA. Normally, the crew's readiness can be assessed within two days using such a plan, which should encompass the following:

- a. An administrative review.
- b. Observation of basic drills and evolutions not requiring reactor operation.
- c. Personnel interviews.
- d. Material inspection.

4.9.6.1 Scheduling of Pre-Critical Inspections. The ISIC Pre-Critical Inspection should be scheduled by the responsible ISIC about four weeks prior to criticality. The TYCOM should be advised as soon as possible in advance of the tentative date for the ISIC Pre-Critical Inspection and confirmed dates should be established about one month in advance of the inspection.

4.9.6.2 Composition of the Inspection Team. The Pre-Critical Inspection Team should consist of:

- a. A nuclear trained member of the cognizant ISIC Staff, usually the Squadron Training Officer.
- b. A qualified nuclear trained officer with experience as an Engineer Officer.

4.9.6.3 Reports of Inspection.

- a. The Senior Inspector should provide the inspected unit with an informal report of findings by the inspection team, copy to the cognizant ISIC and TYCOM.
- b. The ship's CO shall review the findings of the inspection team and make necessary adjustments to his training program to ensure his crew's readiness for criticality. He shall keep the cognizant ISIC advised of his training plan and his assessment of his crew's progress.
- c. The cognizant ISIC shall review the inspection findings, the CO's training plan and progress evaluations and direct follow-up reviews and/or inspections necessary to verify the ship's readiness for criticality.

4.9.7 Dock Trials. Dock Trials must, as a minimum, test those systems/equipment repaired or altered during the availability. The CO should use Appendix M of this chapter as a guide in preparing the Dock Trial Agenda.

4.9.8 Fast Cruise. Fast Cruise may commence immediately upon completion of Dock Trials and shall consist of the minimum requirements as set forth in Appendix N. The requirement for a Fast Cruise may be less than or greater than 24 hours in length depending upon the length of the availability and the time since the crew last operated the ship at sea. The CO, with ISIC concurrence, will determine length of the Fast Cruise. Prior to the ship commencing Fast Cruise, the Supervising Authority shall report to the ship, by message, that all mandatory work approved for accomplishment during the availability is completed. When the ship is ready for sea, with the exception of conducting Fast Cruise and after receipt of the SUBSAFE material certification report from the performing activity as required by reference (p) and Volume V of this manual, the ship will request permission from the ISIC by priority message to commence Fast Cruise. The ISIC will then, if satisfied with the state of crew training and material readiness, authorize the ship to commence Fast Cruise by message, information copy to CNO, Fleet Commander, NAVSEA, and the TYCOM.

- a. A 24 hour rest and repair period will normally be scheduled following Fast Cruise and prior to the start of Sea Trials. This rest and repair period may be extended or reduced at the discretion of the ISIC.
- b. COs should consider the work and alterations accomplished during the availability when determining the extent of the Fast Cruise. The minimum requirements are listed and identified with an asterisk in Appendix N of this chapter.

4.9.9 Sea Trials. Following completion of Fast Cruise the ISIC will notify the TYCOM of satisfactory completion of Fast Cruise and readiness for Sea Trials using the message format of Appendix O. The submarine TYCOM will authorize the ISIC to allow the ship to get underway for Sea Trials using the message format of Appendix P. Sea Trials are required only as necessary to test work completed during the availability but must include those mandatory requirements identified in Appendix Q of this chapter. The industrial activity shall include at least two days in the availability for conduct of Sea Trials. The industrial activity shall prepare a Sea Trial Agenda for Sea Trials conducted after an availability at the industrial activity. For an availability at a FMA, the submarine shall prepare the Sea Trial Agenda, assisted by the industrial activity. The submarine involved shall submit the Sea Trial Agenda to the ISIC for approval, with an information copy to the TYCOM. During the Sea Trial the submarine CO will keep the TYCOM aware of the progress of the Sea Trial through periodic Situational Reports using the message format of Appendix R of this chapter. The frequency of these Situational Reports will be identified by the TYCOM or the Sea Trial Agenda. Extensions or reductions of the Sea Trial period may be granted where warranted by the scope of the work accomplished. Where extension of the Sea Trial period and a change in the availability schedule is required, requests for such extensions must be submitted by the industrial activity to the TYCOM as early as practical. All deficiencies resulting from Sea Trials will be satisfactorily resolved prior to the completion of the availability. If no Sea Trial deficiencies are found, the availability may be completed with TYCOM occurrence at the completion of Sea Trials.

NOTE: SUBSEQUENT TO THE MESSAGES, APPENDICES O AND S OF THIS CHAPTER, ANY DEFICIENCY DISCOVERED AND THE CORRECTIVE ACTION TAKEN WHICH AFFECTS THE WATERTIGHT INTEGRITY, THE RECOVERABILITY OF THE SHIP, THE OPERATIONS OF THE SHIP'S CONTROL SURFACES OR THE SHIP'S SALVAGE CAPABILITY SHALL BE REPORTED TO THE TYCOM BY THE SUPERVISING AUTHORITY/ISIC/TYCOM REPRESENTATIVE BY MESSAGE. PREVIOUS

CERTIFICATION MESSAGES SHALL BE SUSPENDED. WHEN A REVIEW OF THE DEFICIENCY IS COMPLETED BY THE TYCOM, THE TYCOM WILL CERTIFY THAT THE SHIP'S SUBSAFE CERTIFICATION BOUNDARY IS SATISFACTORY FOR SEA TRIALS TO A SPECIFIED DEPTH.

- a. Assignment of Escort Ship.
 - (1) In accordance with reference (q), an escort shall be provided during deep dive submergence trials for ships completing an availability for repair of collision/grounding damage where deformation is observed to be in the hull integrity envelope and/or supporting structure.
 - (2) In accordance with reference (q), the requirement for providing an escort during deep dive submergence trials upon completion of all other availabilities will be evaluated by Commander, NAVSEA on a case basis. Commander, NAVSEA will advise the applicable Submarine Force Commander in writing whether or not an escort will be required based on the scope of work in the availability. In general, an industrial activity availability of less than six months duration should not require an escort, since the work typically performed in these availabilities is limited in scope, is carefully controlled and, therefore, does not result in substantial risk of unidentified or incomplete work adversely affecting the SUBSAFE boundary.
 - (3) Escort requirements should be determined early so that an escort satisfying the requirements of Part I, Chapter 3, paragraph 3.6.8.4.7.b.(6), of this volume can be scheduled if required. The TYCOM will in turn request services from the Fleet Commander as applicable. As a general rule, pressure hull work which could not affect hull circularity will not require an escort.
 - (4) Waiver of escort requirements may be requested by message when necessary. The ISIC will request the waiver as soon as possible. The TYCOM will pass the request to Commander, NAVSEA for approval. An escort waiver request message is to include all of the following specific statements, as applicable:
 - (a) A () inch by () inch hull cut between frames () and () including a () inch section of frame () was the only major hull integrity work accomplished during the availability. If no hull frame cut was made, a positive statement to that effect is required.
 - (b) The hull cut weld satisfactorily passed Radiographic Testing and 7 day Magnetic Particle Testing nondestructive tests.
 - (c) Post repair frame circularity check readings are within specifications.
- b. Assignment of Deep Submergence Rescue System During Submarine Sea Trials.
 - (1) A Submarine Rescue Diving Recompression System will be placed in a modified alert status at the beginning of Sea Trials requiring an escort following an industrial availability or major maintenance availability for:
 - (a) Ships initial tightness and deep dive events.
 - (b) Subsequent Sea Trials until the completion of the initial dive to design test depth.
 - (c) If, in the TYCOM's judgment, a Sea Trial requires an escort due to major hull cuts.
 - (2) The ship conducting Sea Trials will notify COMSUBRON ELEVEN when Submarine Rescue Diving Recompression System services are no longer required due to completion of the events in paragraph 4.9.9 of this chapter or due to delay in completing Sea Trials.
- c. The ship's normal load out of Lithium Hydroxide canisters for Disabled Submarine (granular or ExtendAir®, no mix), Lithium Hydroxide curtains (or ExtendAir® Deployment kits, if equipped), Emergency Air Breathing masks, Submarine Escape Immersion Ensemble suits and oxygen candles is not sufficient to support this increase in personnel. Therefore, an additional four Lithium Hydroxide canisters (or three ExtendAir®, if equipped), four Lithium Hydroxide curtains (or one ExtendAir® Deployment kit for every multiple of 60 ExtendAir® canisters in the compartment, if equipped), one Emergency Air Breathing mask, one Submarine Escape Immersion Ensemble suit and two Oxygen

candles shall be carried for each rider exceeding normal crew manning. Stowage of this additional equipment for Disabled Submarine shall be in the same escape compartment as the rider's designated General Emergency muster site assigned by the Commanding Officer. Lithium Hydroxide canisters, Emergency Air Breathing masks, Submarine Escape Immersion Ensemble suits and Lithium Hydroxide curtains are to be obtained from the industrial activity.

4.9.10 Interrupted Sea Trials. In the event a Sea Trial is interrupted, or an additional Sea Trial becomes necessary, the following requirements are to be met. These requirements shall be invoked if the ship returns to port for industrial activity repairs which affect SUBSAFE certification or which will require at-sea testing.

- a. The submarine will draft a revised Sea Trials Agenda to support resumption of the trials. This agenda shall be provided to the ISIC for concurrence and TYCOM for information.
- b. Ship's Force will report by message (format of Appendix T of this chapter) that Ship's Force is ready for follow-on sea trials.
- c. The ISIC shall report by message (format of Appendix U of this chapter) to the TYCOM that the material condition of those SUBSAFE Certification boundaries that were installed, repaired and/or tested by Ship's Force is satisfactory for resuming Sea Trials.
- d. Upon completion of all of the requirements in paragraphs 4.9.10.a. and b. above, the TYCOM will provide a message (Appendix V of this chapter) to the ISIC granting permission to proceed with the conduct of Sea Trials and authorize the ship to dive to the Sea Trial operating depth.

(This Page Intentionally Left Blank)

APPENDIX A

SAMPLE MESSAGE TO TYCOM FROM ISIC REQUESTING CONCURRENCE TO DEFER, DELETE OR SHORTEN A SCHEDULED CMAV

(MESSAGE IS NOT REQUIRED FOR CMAV'S 32 DAYS OR LONGER IN DURATION)

FM COMSUB<RON NO.>//
 TO COMSUB<LANT/PAC> <NORFOLK VA/PEARL HARBOR HI>//
 INFO COMSUBGRU <NO.>//
 NSSC <LOCATION>//
 <SUPERVISING AUTHORITY>//<CODES>//
 BT
 UNCLAS//N09094//
 MSGID/GENADMIN//USS <SHIP'S NAME>//
 SUBJ/(SUBS) REQUEST TO <MISS/SHORTEN> USS <SHIP NAME/HULL NO.> CMAV//
 REF/A/DOC/COMUSFLTFORCOM/<DATE>//
 NARR/REF A IS COMUSFLTFORCOMINST 4790.3, JOINT FLEET MAINTENANCE MANUAL, VOLUME II//
 RMKS/1. DUE TO <CAUSE OF MISSING/SHORTENING AVAIL> THE USS<SHIP NAME> WILL NOT BE ABLE TO MEET THE SCHEDULED CMAV REQUIREMENTS PER REF A.
 2. THE FOLLOWING INFORMATION IS PROVIDED TO SUPPORT <SHORTENING/MISSING> THE SCHEDULED CMAV.
 A. CMAV NUMBER:
 B. CMAV DATES:
 C. CMAV DURATION: (NUMBER OF DAYS)
 D. ACTIVE CASREPS:
 <CASREP #, DESCRIPTION, REPAIR PLAN>
 E. ACTIVE SUBS:
 <SUBS DESCRIPTION, REPAIR PLAN>
 F. SCHEDULED CMAV DATES FOR THE NEXT TWELVE MONTHS:
 G. IMPACT ON FUTURE WORKLOAD TO I-LEVEL MAINTENANCE ACTIVITY:
 H. STATUS OF K-MRCS: (NUMBER OUTSTANDING, PLAN TO COMPLETE TIME CRITICAL K-MRCS) NUCLEAR PMS ISSUES:
 I. STATUS OF PATS/POTS IF CNO AVAILABILITY PENDING:
 3. <ADDITIONAL REMARKS>
 4. REQUEST CONCURRENCE TO <MISS/SHORTEN> SCHEDULED CMAV <FISCAL QUARTER, YEAR>.///
 BT

NOTE: ENSURE MESSAGES ARE IN ACCORDANCE WITH CURRENT MESSAGE FORMAT AND CURRENT PLAIN LANGUAGE ADDRESS DIRECTORY (PLAD) IS UTILIZED.

(This Page Intentionally Left Blank)

APPENDIX B

SAMPLE TYCOM MESSAGE CONCERNING ESCORT SERVICES
FOR IDD OR PIRA AVAILABILITIES

FM COMSUB <LANT/PAC><NORFOLK VA/PEARL HARBOR HI>//
 TO COMSUB<RON/GRU NO.>/{ISIC of Escort Ship}
 USS <ESCORT SHIP NAME>//
 INFO CNO WASHINGTON DC//
 COM<LANT/PAC>FLT <NORFOLK VA/PEARL HARBOR HI>//
 COMNAVSEASYSKOM WASHINGTON DC//
 DIRSSP WASHINGTON DC // {For SSBN/SSGN only}
 <SUPERVISING AUTHORITY>/{CODES}
 <SUBOPAUTH> // {If other than parent TYCOM}
 COMSUBRON ELEVEN//
 COMSUB<RON/GRU NO.>/{ISIC of Sea Trial Ship}
 CTF TWO SIX//
 CTG TWO SIX PT ONE//
 NSCSES NORFOLK VA//
 UNSEARESCOM SAN DIEGO CA//
 NAVUNSEAWARCENDIV NEWPORT RI//
 NAVUNSEAWARCENDET WEST PALM BEACH FL//
 NAVUNSEAWARCENDET AUTEC ANDROS ISLAND BAHAMAS//
 NAVSURFWARCEN CARDEROCKDIV BETHESDA MD//
 PEOSUBCBTWPNSYS WASHINGTON DC//
 NAVORDTESTU CAPE CANAVERAL FL// {For SSBN/SSGN only}
 COMSUBGRU <NINE/TEN> // {For SSBN/SSGN only}
 USS <SEA TRIAL SHIP NAME> //
 BT
 UNCLAS //N03120//
 MSGID/GENADMIN/COMSUB<LANT/PAC>//
 SUBJ/(SUBS) SUBMARINE SEA TRIAL SUPPORT SERVICES//
 REF/A/<RMG/DOC>/<SUPERVISING AUTHORITY>/<DATE/DTG>//
 REF/B/DOC/COMUSFLTFORCOM/<DATE>//
 NARR/REF A IS SEA TRIAL SUPPORT REQUEST. REF B IS JOINT FLEET MAINTENANCE MANUAL//
 RMKS/1. REF A REQUESTED AND IAW REF B USS <NAME OF ESCORT SHIP> IS APPROVED AS ESCORT
 FOR USS <SEA TRIAL SHIP NAME> FOR SEA TRIALS OCCURRING <DDMMYY>.
 2. FOR COMSUB<RON/GRU NO.> PROVIDE GOLD DOLPHIN RIDER ONBOARD USS <NAME OF ESCORT SHIP>.
 3. DIRLAUTH ALCON FOR EVENT SCHEDULES AND SCHEDULE CHANGES.//
 BT
**NOTE: ENSURE MESSAGES ARE IN ACCORDANCE WITH CURRENT MESSAGE FORMAT AND
 CURRENT PLAD IS UTILIZED.**

(This Page Intentionally Left Blank)

APPENDIX C

SUGGESTED FORMAT FOR A MESSAGE WORK CANDIDATE

FM: USS (SHIP NAME)//
TO: TYCOM/RSG/RMC/ISIC//
INFO: FMA TO PERFORM WORK//
ISIC OF FMA (IF DIFFERENT FROM REQUESTING SHIPS ISIC)//
TYCOM//
BT
(CLASSIFICATION)//NO4790//
MSGID/GENADMIN//SHIP//
SUBJ/MESSAGE WORK CANDIDATE//
REF/A/DOC/COMUSFLTFORCOM/(DATE)//
AMPN/REF A IS COMUSFLTFORCOMINST 4790.3,
JOINT FLEET MAINTENANCE MANUAL//
RMKS/1. UIC
2. WORK CENTER
3. JSN
4. APL/AEL
B. (SHIP'S HULL NO.)
5. EQUIP NAME
6. WHEN DISCOVERED
7. STATUS
8. CAUSE
9. DEFERRAL REASON
13. IDENTIFICATION/EQUIP SERIAL NUMBER
14. EIC
15. SAFETY HAZARD (LEAVE BLANK OR STATE SAFETY HAZARD AND EXPLAIN IN BLK 35)
16. LOCATION
17. WHEN DISCOVERED
25. SF MHRS EXPENDED (1 HR=0001)
26. DEFERRAL DATE
28. DEADLINE DATE
35. REMARKS/DESCRIPTION
37. CSMP SUMMARY
38. FIRST CONTACT
40. SECOND CONTACT/SUPERVISOR
41. PRIORITY
42. T/A
46. SPECIAL PURPOSE
47. BLUE PRINTS/TECH MANUAL/PLANS/ETC
BT

NOTE: ENSURE MESSAGES ARE IN ACCORDANCE WITH CURRENT MESSAGE FORMAT AND CURRENT PLAD IS UTILIZED.

(This Page Intentionally Left Blank)

**APPENDIX D
BUSINESS CASE ANALYSIS TOOL**

To use this tool, first analyze the safety and mission impact of the damage to be repaired using Table 1. Determine the Hazard-Mission Index. Then consider the impact on schedule and cost using Table 2 and obtain the Cost - Schedule Index. On the next sheet, select the appropriate CO Modifier and sum the indices to obtain the Risk Index. Determine indicated action from the Business Case Analysis Table.

Table 1 - Hazard Severity and Impact to Mission					Table 2 - Cost Severity and Impact to Schedule				
	Hazard Severity					Cost Severity			
Impact to Mission	Catastrophic	Critical	Major	Minor	Impact to Schedule	Extreme	Significant	Major	Minor
Frequent				5	Frequent			7	4
Probable		6	4	3	Probable			6	3
Occasional		5	3	2	Occasional		8	5	1
Remote	7	4	2	1	Remote	7	6	4	1
Improbable	6	3	1	1	Improbable	5	3	2	1

Impact to Mission Likelihood		Impact to Schedule Likelihood	
Description	Explanation	Description	Explanation
Frequent	Likely to adversely impact mission/operation of ship/ship's future schedule/critical systems regularly. Work to rectify this deficiency must be undertaken at the first opportunity.	Frequent	The undertaking of the work or combination of availability of Long Lead Time Material and Work Completion WILL delay the schedule greater than 5 working days.
Probable	Could adversely impact mission/operation of ship/ship's future schedule/critical system several times. Work to rectify this deficiency should be programmed in the current availability.	Probable	The undertaking of the work or combination of availability of Long Lead Time Material and Work Completion COULD delay the schedule greater than 2 working days.
Occasional	Unlikely, but could be reasonably expected to adversely impact mission/operation ship/ship's future schedule/critical system occasionally. Work to rectify this deficiency should be considered during the current availability depending upon schedule and cost.	Occasional	The undertaking of the work or combination of availability of Long Lead Time Material and Work Completion COULD BE REASONABLY expected to delay the schedule not greater than 2 working days.
Remote	Unlikely, but could possibly impact mission/operation of ship/ship's future schedule/critical system at some time. Work to rectify this deficiency should be considered and programmed to meet the ship's operational schedule.	Remote	The undertaking of the work or combination of availability of Long Lead Time Material and Work Completion is UNLIKELY BUT POSSIBLE to delay the schedule.
Improbable	So unlikely that there should be no adverse impact to mission/operation of ship/ship's future schedule/critical system. Work to rectify this deficiency should be programmed in due course.	Improbable	The undertaking of the work or combination of availability of Long Lead Time Material and Work Completion is SO UNLIKELY to delay the schedule it can be assumed it will not affect schedule.

Hazard Severity if Work Not Undertaken		Cost Severity Impact	
Description	Explanation	Description	Explanation
Catastrophic	Failure of System could result in total loss of ship or critical system. Resultant damage would be beyond economical repair.	Catastrophic	The increase in cost due to Growth & New Work, delay to start of work, cost or availability of material is so great that it either represents funding that would need to be sourced from another activity, or it constitutes a G&NW premium of 60% or higher.
Critical	Failure of System could result in significant damage to the ship or critical system. Resultant damage would require intervention of support agency. Usually damage to Primary structure/Water Tight Integrity.	Critical	The increase in cost due to Growth & New Work, delay to start of work, cost or availability of material, represents a very large increase that it either can be covered in the existing budget plan but would adversely impact the remaining financial plan or it constitutes a G&NW premium of 40% to 60%.
Major	Failure could result in the temporary loss or deterioration of the system requiring repair action.	Major	The increase in cost, while large, is either able to be covered inside the existing budget plan with little impact to the remaining financial plan or it constitutes a Growth & New Work premium of 20% to 40%.
Minor	Failure could result in the need for minor defect repair action, continued operation without significant loss of output is possible.	Minor	The increase in cost is very small and is either able to be covered inside the existing budget plan with no impact to the remaining financial plan or it constitutes a Growth & New Work premium of 0% to 20%.

Commanding Officer's Concern	CO's Top 5	add -2
Commanding Officer's Concern	Concerned	add -1
Commanding Officer's Concern	Not Concerned	add 0

Business Case Analysis (Table 1 + Table 2 + CO's Concerns) = Risk Index			
Risk Index	Relative Level of Risk	Decision	Amplifying Comments
1 to 9	Low	MT continue	Represents work that is either a safety concern or mission critical, or is relatively low cost and no impact to schedule.
10 to 17	Med	MT reschedule or conduct more rigorous BCA	Represents work that is either of reasonably high cost or a high risk to schedule impact, or of little to no safety or mission critical concern. This work should either be rescheduled, cancelled, or subject to a more comprehensive BCA.
18 to 20	High	MT reschedule or cancel	Represents work that is either of high cost or extreme schedule impact, or of little to no safety or mission critical concern.

APPENDIX E1
AVAILABILITY KEY EVENT LIST
(FOR SUBMARINES SEE APPENDIX E2)

KEY EVENT CODE	ABBREVIATION	SCHEDULING GUIDANCE
01	ARRIVAL	
02	ESTABLISH PLANT CONDITIONS	
03	DIESEL INSPECT	
04	PMT	
05	COMPLETE OPEN AND INSPECT WORK	
06	DRYDOCKING	
07	UNDOCKING	
08	PIER EVOLUTIONS	
09	ADJACENT SHIP EVOLUTIONS	
10	SYSTEM TESTING COMPLETE	
11	WEAPONS MOVEMENT	
12	SHIPS CEREMONY	
13	SHIPS TRAINING EVOLUTION	
14	STORES ON/OFF LOAD	
15	HAZARDOUS EVOLUTIONS	
16	BERTH SHIFT	
17	SAIL CLOSE-OUT	
18	FUEL MOVEMENT	
19	SHIP INSPECTION	
20	PROPULSION PLANT START UP	
21	FAST CRUISE	1-2 DAYS PRIOR TO SEA TRIALS
22	SEA TRIALS	1-2 DAYS AFTER FAST CRUISE
23	UNDERWAY	
24	TENDER UNDERWAY	

KEY EVENT CODE	ABBREVIATION	SCHEDULING GUIDANCE
25	TENDER REPLENISH	
26	FLIGHT DECK OPS	
27	ALL OTHER	
28	ALL WORK COMPLETE	3 DAYS PRIOR TO END OF AVAILABILITY
29	END OF AVAILABILITY	

APPENDIX E2**CMAV KEY EVENT CODES****(SUBMARINES ONLY BASED UPON TYPICAL MINIMUM 21 PRODUCTION DAY SCHEDULE)**

EVENT #	KEY EVENT	SCHEDULING GUIDANCE
1	ARRIVAL	
2	ESTABLISH PLANT CONDITIONS	PER 100 HOUR PLAN
3	DIESEL INSPECT	AS REQUIRED BY PMS PERIODICITY, COORDINATION WITH ISIC AND DIESEL INSPECTOR
4	FLEET TECH SUPPORT TROUBLESHOOTING COMPLETE	PER 100 HOUR PLAN
5	TEMP SERVICES INSTALLED	PER 100 HOUR PLAN
6	SAIL RACETRACK/STAGING INSTALLED	PER 100 HOUR PLAN
7	VLS PLATFORM INSTALLED	PER 100 HOUR PLAN
8	PMT MONITORING PERIOD COMMENCE - COMPLETE TIME CRITICAL K-MRCS	PER 100 HOUR PLAN
9	SALVAGE INSPECTION	AS REQUIRED
10	Rx PLANT COOL DOWN	AS REQUIRED
11	Rx PLANT HEAT-UP	AS REQUIRED
12	NON-AVAILABILITY EVENT, INSPECTION OR EVALUATION THAT MAY IMPACT SCHEDULE	AS REQUIRED
13	BERTH SHIFT	AS REQUIRED
14	FUEL MOVEMENT	AS REQUIRED
15	BALLASTING EVOLUTIONS	AS REQUIRED
16	WEAPONS MOVEMENT	AS REQUIRED
17	DIVER OPERATIONS	AS REQUIRED
18	SHIPS TRAINING EVOLUTION	AS REQUIRED
19	STORES ON/OFF LOAD	AS REQUIRED
20	SHIP TO SHOP WORK CUTOFF	AS REQUIRED
21	O2/N2 LOADING/UNLOADING	AS REQUIRED
22	HAZARDOUS EVOLUTIONS	AS REQUIRED
23	TEMP SERVICES REMOVAL	PRIOR TO FINAL 100 HOURS OF AVAIL

EVENT #	KEY EVENT	SCHEDULING GUIDANCE
24	VLS PLATFORM REMOVAL	COMPLETED PRIOR TO FINAL 100 HOURS OF AVAIL
25	TANK CLOSEOUTS	COMPLETED PRIOR TO FINAL 100 HOURS OF AVAIL
26	SAIL CLOSE-OUT	COMPLETED PRIOR TO FINAL 100 HOURS OF AVAIL
27	TD SYSTEM COMPLETE	COMPLETED PRIOR TO FINAL 100 HOURS OF AVAIL
28	ASW/MSW SYSTEM COMPLETE	COMPLETED PRIOR TO FINAL 100 HOURS OF AVAIL
29	HYDRAULIC SYSTEMS COMPLETE	COMPLETED PRIOR TO FINAL 100 HOURS OF AVAIL
30	ELECTRICAL SYSTEMS COMPLETE	COMPLETED PRIOR TO FINAL 100 HOURS OF AVAIL
31	A/C SYSTEM COMPLETE	COMPLETED PRIOR TO FINAL 100 HOURS OF AVAIL
32	VENTILATION SYSTEM COMPLETE	COMPLETED PRIOR TO FINAL 100 HOURS OF AVAIL
33	REFRIGERATION SYSTEM COMPLETE	COMPLETED PRIOR TO FINAL 100 HOURS OF AVAIL
34	AIR SYSTEMS COMPLETE	COMPLETED PRIOR TO FINAL 100 HOURS OF AVAIL
35	PROPULSION PLANT WORK COMPLETE	COMPLETED PRIOR TO FINAL 100 HOURS OF AVAIL (TYPICALLY 20TH PRODUCTION DAY)
36	ALL WORK COMPLETE (INCLUDES PRODUCTION, AIT AND PRIVATE CONTRACTOR WORK)	COMPLETED PRIOR TO FINAL 100 HOURS OF AVAIL (TYPICALLY 20TH PRODUCTION DAY)
37	PROPULSION PLANT TESTING COMPLETE	COMPLETED PRIOR TO FINAL 100 HOURS OF AVAIL (TYPICALLY 21ST PRODUCTION DAY)
38	PRODUCTION WORK SYSTEM TESTING COMPLETE	COMPLETED PRIOR TO FINAL 100 HOURS OF AVAIL (TYPICALLY 21ST PRODUCTION DAY)
39	FAST CRUISE PRE-UNDER WAYS	96 TO 4 HRS PRIOR TO FAST CRUISE
40	PRE-UNDER WAYS	96 TO 4 HRS PRIOR TO UNDERWAY
41	DOCK TRIALS COMPLETE	72 HOURS PRIOR TO END OF AVAIL
42	PROPULSION PLANT START UP	PER FINAL 100 HOURS

EVENT #	KEY EVENT	SCHEDULING GUIDANCE
43	FAST CRUISE	1-2 DAYS PRIOR TO SEA TRIALS/UNDERWAY PERIOD
44	SEA TRIALS	1-2 DAYS AFTER FAST CRUISE (AS DIRECTED BY ISIC)
45	END OF AVAILABILITY	
46	ALL OTHER	
47	SHIP'S UNDERWAY	POST KEY EVENT 43

(This Page Intentionally Left Blank)

APPENDIX F

AVAILABILITY PLANNING MESSAGE (SUBMARINES ONLY)

FM COMSUBRON (SQUADRON NO.)//

TO USS (SHIP NAME AND HULL NO.)//

TYCOM (COMSUBLANT/COMSUBPAC)//

INFO FMA (ACTIVITY)//

BT

(CLASSIFICATION) //N04790//

MSGID/GENADMIN/COMSUBRON// (AS APPROPRIATE)

SUBJ: (SUBS) AVAILABILITY PLANNING FOR USS (SHIP NAME AND HULL NO.)//

REF/ (AS APPROPRIATE)//

RMKS/1. FOL EVENTS PLANNED FOR NEXT AVAIL

A. MAJOR JOBS (ANNOTATE SHIPS FORCE OR FMA)

(1) ESD _____

(2) ESD _____

(3) ESD _____

B. CONTROLLING KEY EVENT/DATES:

(1)

(2)

(3)

C. MAJOR PMR JOBS:

(1)

(2)

(3)

D. ALTS FOR FMA ACCOMPLISHMENT:

(1)

(2)

(3)

E. ALTS FOR S/F ACCOMPLISHMENT:

(1)

(2)

(3)

F. ALTS FOR OUTSIDE ACTIVITY (INDUSTRIAL ACTIVITY, VENDOR, ALT)

G. DEPARTURES FROM SPECIFICATION TO BE CLEARED:

H. OTHER EVOLUTIONS/EVENTS://

I. FIRST 100 HOUR PLANNING ITEMS

a. Day 1 (date)

(1)

b. Day 2 (date)

(1)

c. Day 3 (date)

(1)

d. Day 4 (date)

(1)

J. FINAL 100 HOUR PLANNING ITEMS

a. Day 1 (date)

(1)

b. Day 2 (date)

(1)

c. Day 3 (date)

(1)

d. Day 4 (date)

(1)

COMUSFLTFORCOMINST 4790.3 REV C

BT

NOTE: ENSURE MESSAGES ARE IN ACCORDANCE WITH CURRENT MESSAGE FORMAT AND CURRENT PLAD IS UTILIZED.

**APPENDIX G
FINAL 100 HOURS FOR SCHEDULED CMAV**

Prior to 100 hrs	96 hours	72 hours	48 hours	24 hours	Transition day
Production days →	C-4	C-3	C-2	C-1	C-0
<ul style="list-style-type: none"> - Production work complete. - Production work Testing complete. - Sail closeout. Pre-under ways. - Fast Cruise. - WAF closeout. - Weapons load complete. - Departure Conference complete. - Production related temp services removed. - Commence Dock Trials. - NRMD Rx Plant Certification. 	<ul style="list-style-type: none"> - Pre-under ways. - Fast Cruise - FINAL WAF AUDIT. - Crew watch bills and berthing bills complete. - (Ships office/Exec Pre-under ways complete). - Rx Startup for Rx Testing. 	<ul style="list-style-type: none"> - Pre-under ways. - Fast Cruise - SUBSAFE /QA Certification complete. - Complete Dock Trials. 	<ul style="list-style-type: none"> - Rx Start-up to support Fast Cruise. - Fast Cruise. - Commence Pre-under ways for all +48hr and sooner Pre-under ways. 	<ul style="list-style-type: none"> - Pre-under ways. - Crew rest and final admin. 	<ul style="list-style-type: none"> - Rx Start-up. - Pre-under ways complete.

(This Page Intentionally Left Blank)

APPENDIX H₁
AVAILABILITY MILESTONE SCHEDULE
(SSNs and SSGNs ONLY)

* Times are in days

NO.	MILESTONE	Responsible Activity	Scheduled CMAV *	Year-Long CM *	Remarks
1	Identify drawing development assignments, including Class Drawings.	PARMs/TYCOM/NAVSEA	A-390	NA	Send to RMC and Planning Yard.
2	Assign drawing development responsibility.	PEO Ships	A-390	NA	
3	Issue Hull Modernization Plan (HMP)/Letter Of Authorization AITs.	SPM/NAVSEA/TYCOM	A-360	NA	HMPs to be issued in March each year to maintenance Teams to support MMBP. Letter of Authorizations will be posted at A-360.
4	Establish Availability in NMD/LDS/or other work control information system, as appropriate.	Maintenance Team	A-360	NA	Availabilities will be established in the applicable planning data base when known or work is ready to be screened.
5	Request Availability Funding for planning repair work.	NSA	A-345	NA	This provides funds for early executor planning.
6	Task/Fund SID Development.	SPM/NSA/AIT/TYCOM/RMC Manager	A-330	NA	
7	Ship checks completed for alterations.	Planning Yard	A-270	NA	No FFP considerations relate to this date.
8	Screen CMP and TYCOM routines.	TYCOM	A-270	NA	Push CMP work items to CSMP NOT LATER THAN A-270.
9	Provide Incremental Funds for ordering Long Lead Time Material for both repair and Alt/mod work to meet required dates.	SYSCOM/TYCOM	A-270	NA	
10	Issue/Deliver SIDs to NSA for contractor(s) and AITs.	Planning Yard	A-180	NA	This is a change from A-4. Including all SIDs for AITs. For FFP contracts, this milestone should occur at A-8 when possible and NOT LATER THAN A-180.
11	Request Availability Funding for both repair & modernization work.	NSA/RMC	A-180	NA	

NO.	MILESTONE	Responsible Activity	Scheduled CMAV *	Year-Long CM *	Remarks
12	All Modernization Risk Assessments (including waivers) submitted.	PARM SPM TYCOM	A-175	NA	
13	All Modernization Risk Assessments (including waivers) approved.	TYCOM	A-150	NA	
14	Identification of AIT Support/Schedule/Impact requirements.	AIT Manager	A-135	NA	A-168 for FFP/IDIQ. Need to develop a complete requirements list. Needs to be integrated with repair requirements by the contractor and presented at the WPER.
15	Identification of AIT support/schedule impact requirements.	AIT Manager	A-135	NA	A-168 for FFP/IDIQ.
16	Certification Plan(s) (e.g., ILS, software, etc.) approved. Final date for modernization Ship Change (SC) approval. LOA locked.	SPM PARM PM	A-120	NA	SPM approves Hull Certification. All unresolved planned not authorized PNA modernization Ship Changes (SCs) are removed from the authorization letter at this date. Please note: There is an interim policy covering the Fleet Commanders C51 MP policy for approving the Weapon System Baseline Certification at A-30.
17	Identify all outside activities (e.g., Naval Surface Warfare Center (NSWC), Alteration Installation Team, etc.) participating in the Availability and associated support requirements.	TYCOM	A-90	NA	
18	Award AIT contracts for work not being done by prime contractor.	AIT Sponsor	A-90	NA	

NO.	MILESTONE	Responsible Activity	Scheduled CMAV *	Year-Long CM *	Remarks
19	Solicit Bids.	RMC	NA	NA	A-50 for FFP/IDIQ. If CMAV is to be performed under an IDIQ contract and is over \$500k we may need to add 30 days for solicitation in accordance with Fair Value purchasing policy. This would reset the CMAV solicit bid milestone to A-70.
20	Review PMR/URO requirements and ensure all maintenance actions intended for accomplishment during the availability are identified.	ISIC	A-60	NA	
21	Review CSMP and ensure all deferred maintenance actions intended for accomplishment during the availability identified by priority and submit to the TYCOM/ISIC.	Maintenance Team	A-50	NA	
22	Provide Availability Funding for Modernization to the RMC/LMA.	SYSCOMS/PEO/TYCOM	A-45	NA	Includes funding for AITs support services.
23	Review PMS, Reactor Plant PMS, CSMP, and testing requirements and ensure all Ship's Force maintenance actions scheduled for accomplishment during the availability are identified. Ship's Force review K-MRC data with PMT, TYCOM 3M representative and ISIC to develop K-MRC Completion Plan for submission to integrated work schedule.	Maintenance Team	A-40	NA	See Paragraphs 4.4.13.1 and 4.6.1.2.m.(13) of this chapter.
24	Review TYCOM Alteration Management System/NMP and ensure all authorized alterations intended for accomplishment during the availability are identified by priority based on material availability as identified by the LMA.	TYCOM	A-40	NA	

NO.	MILESTONE	Responsible Activity	Scheduled CMAV *	Year-Long CM *	Remarks
25	Review the MJC and identify the routine package to be accomplished during the availability.	TYCOM	A-40	NA	
26	Review CSMP T/A 2 items. Identify and order LLTM.	FMA	A-40	NA	
27	I-Level work package fully brokered.	Maintenance Team/ Ship's Force	A-40	E-14	Intent is to fully broker all known work to I-Level by this date. This allows for routine procurement of materials and brokering of work candidates to other Executing Activities if necessary.
28	Establish funding targets for budgeting purposes for the availability.	Funding Activity	A-40	NA	
29	Review the availability work package, begin writing FWPs/TWDs, identify critical jobs and develop the integrated work schedule to aid in tracking and coordination of all work.	LMA	A-40	E-14	
30	100% of D-Level maintenance work package 2Ks planned, estimated.	Planning Activity	A-35	E-14	A-60 for FFP/IDIQ.
31	I-Level work package fully accepted.	Planning Activity	A-33	E-14	Intent is for I-Level to accept or reject all work brokered to it up to this point in time, work entering later in the process will be subject to normal Business Case Analysis. At this point the I-Level activity work has been locked. Any remaining work will be re-brokered to another Executing Activity, rescheduled or returned.
32	100% of maintenance work D-Level package 2Ks locked.	Maintenance Team	A-30	E-7	A-60 for FFP/IDIQ.
33	Submit I-Level work package and schedule to the LMA for integration.	RMC	A-30	E-14	A-15 for FFP/IDIQ.
34	Submit executing activity work package and schedules to the LMA for integration.	All Executing Activities	A-30	E-14	

NO.	MILESTONE	Responsible Activity	Scheduled CMAV *	Year-Long CM *	Remarks
35	Develop recommended Key Events schedule and present to ISIC/Ship's Force/TYCOM.	LMA	A-30	NA	
36	Begin to integrate executing activity schedules.	LMA	A-30	E-7	
37	Review scheduled Ship's Maintenance Monitoring Support Office, PMT, MCA inspections and testing that may result in significant new work for the FMA or Ship's Force or that may impact scheduled Ship's Force and/or FMA work.	TYCOM	A-30	NA	
38	100% of O-Level maintenance work package locked.	Maintenance Team	A-30	NA	A-60 for FFP/IDIQ Intent is to provide work to be accomplished so that an integrated execution schedule can be developed for the WPER.
39	Identify to RMC/ISIC /TYCOM returned work candidates.	LMA	A-30	NA	
40	Begin processing all new work as "late work". See Appendix D for Business Case Analysis.	RMC	A-30	E-30	The intent is that all work regardless of the intended Executing Activity or level (O, I, or D) will have been brokered and accepted. Hence additional work will be treated as "late work".
41	MOA SUBMITTED	AIT Manager/outside activity	A-30	NA	
42	Conduct Planning Availability	Maintenance Team/LMA	A-30	NA	Should be prior to the WPER.
43	Cutoff for bidders questions.	PCO	NA	NA	A-30 for FFP/IDIQ.
44	Perform risk assessments and verify deliverables O-Level, I-Level, and D-Level work items and AIT schedule requirements to LMA.	Maintenance Team	A-25	NA	This is to confirm that the LMA has all input for his development of the integrated availability schedule. Note that for FFP CMAV LMA will not be identified until A-15, verification with LMA will take place at WPER.

NO.	MILESTONE	Responsible Activity	Scheduled CMAV *	Year-Long CM *	Remarks
45	Complete ship checks and order all required material.	Executing Activities	A-25	NA	
46	Conduct Work Package Execution Review (WPER) - finalize funding.	Maintenance Team	A-21	NA	A-10 for FFP/IDIQ. LMA/executing activity presents fully planned execution schedule (could be a Gantt chart) to the full Maintenance Team.
47	Deliver Material (LLTM and Kitted Materials) to Executing Activity.	Planning Yards/PARM	A-20	NA	
48	Complete TAR.	RMC	A-20	NA	
49	Submit Bids.	Contractor	NA	NA	A-20 for FFP/IDIQ.
50	Definitize Work Packages.	Maintenance Team/RMC	A-18	E-7	
51	Award Contract.	RMC	NA	NA	A-15 for FFP/IDIQ.
52	Issue availability planning message prepared in accordance with Appendix F of this chapter.	ISIC	A-14	NA	
53	Work Specs Developed.	Executing Activity	NA	E-14	
54	Develop strategy for FMA/Ship's Force calibration of gages, instruments and tools.	Maintenance Team/LMA	A-10	NA	
55	Issue availability planning response message prepared in accordance with Appendix I of this chapter.	Ship's Force	A-7	NA	Send to ISIC and TYCOM
56	Commence First 100 Hours	Maintenance Team/LMA	A-0	NA	
57	Conduct Arrival Conference.	LMA	A-0	NA	
58	Report ships transition to CMAV period.	ISIC	A-0	NA	Send to ISIC and TYCOM
59	Conduct Progress Review.	LMA	Weekly	NA	
60	Commence Final 100 Hours	Maintenance Team/LMA	C-4	NA	
61	Complete Availability.	LMA	C+0	30 Sep	
62	Conduct Departure and Assessment Conference.	Maintenance Team/LMA	C+0	NA	
63	Issue Departure and Assessment Report.	LMA	C+21	NA	

APPENDIX H₂
AVAILABILITY MILESTONE SCHEDULE

(SSBNs ONLY)

NOTE: DUE TO SSBN PATROL CYCLES, THE WORK SUBMISSION CUT-OFF DATE FOR SSBNs IS AFTER THE WPER, BUT ALL KNOWN WORK SHOULD BE BROKERED NO LATER THAN A-30 AND ONLY WORK ASSOCIATED WITH EQUIPMENT DEFICIENCIES THAT OCCURRED SINCE LAST COMMUNICATIONS SHOULD BE SUBMITTED AFTER A-30. SSBNs SHOULD ATTEMPT TO UPLOAD WORK AS OFTEN AS POSSIBLE BEFORE THE WORK SUBMISSION CUT OFF DATE (A-10) TO MINIMIZE THE PLANNING EFFECT ON REFIT.

NO.	MILESTONE	Responsible Activity	SSBN CMAV	Remarks
1	Review CSMP and ensure all deferred maintenance actions intended for accomplishment during the CMAV identified by priority and submit to the TYCOM/ISIC.	Maintenance Team	A-50	
2	Review PMS, Reactor Plant PMS, CSMP, and testing requirements and ensure all Ship's Force maintenance actions scheduled for accomplishment during the CMAV are identified.	Maintenance Team	A-40	Include all required K-MRC.
3	Review PMR/URO requirements and ensure all maintenance actions intended for accomplishment during the CMAV are identified.	Maintenance Team	A-40	
4	Review TYCOM Alteration Management System/NMP and ensure all authorized alterations intended for accomplishment during the CMAV are identified by priority based on material availability as identified by the LMA.	TYCOM	A-40	
5	Review CSMP T/A 2 items. Identify and order LLTM.	FMA	A-40	
6	Work Package fully brokered.	Maintenance Team	A-40	This includes alterations, PMRs, UROs, deferred work, and known Ship's Force 2-Kilos.
7	Conduct meeting to review the CMAV work package. Begin writing FWPs/TWDs, identifying critical jobs and developing the integrated work schedule.	LMA	A-40	
8	Supporting activities submit work scope, testing requirements, and timelines to LMA for integration in to overall schedule.	Maintenance Team	A-35	Includes NRMD, AITs, KTR
9	Work Package fully accepted (minus Ship's Force submitted 2-Kilo between now and work submission cut-off).	LMA	A-33	

NO.	MILESTONE	Responsible Activity	SSBN CMAV	Remarks
10	MOAs submitted.	AIT Manager	A-30	
11	Review scheduled PMT inspections and testing that may result in significant new work or that may impact scheduled work.	ISIC	A-30	
12	TRF/IMF develop weapons/sail arrival inspection plan.	LMA	A-21	
13	Develop recommended Key Event schedule and present to ISIC/Ship's Force.	LMA	A-21	
14	Perform risk assessments and verify deliverables O-Level and I-Level work items and AIT schedule requirements to LMA.	LMA	A-21	
15	Conduct Work Package Execution Review (WPER).	LMA	A-21	
16	Issue CMAV planning message.	ISIC	A-14	In accordance with Appendix F.
17	Work Submission Cut-off established. Begin processing all new work as "late work".	LMA	A-10	Or first day after the ship can communicate following alert. See Appendix D for Business Case Analysis.
18	Develop strategy for FMA/Ship's Force calibration of gages, instruments and tools.	Maintenance Team	A-10	
19	Identify to RMC/ISIC/TYCOM rejected work candidates.	LMA	A-7	
20	Issue CMAV planning response message.	Ship's Force	A-7	In accordance with Appendix I.
21	Commence first 100 hour plan.	Maintenance Team	A-0	
22	Conduct Arrival Conference.	LMA	First Week	Conducted during first senior management meeting after A-0.
23	Complete first 100 hour plan.	Maintenance Team	A+5	
24	Conduct Progress Review.	Maintenance Team	Weekly	
25	All Production Work Complete.	Maintenance Team	C-4	
26	Complete Availability.	Maintenance Team	C+0	
27	Conduct Departure and Assessment Conference.	LMA	C+0	
28	Issue Departure and Assessment Report.	LMA	C+21	

APPENDIX I

AVAILABILITY PLANNING RESPONSE MESSAGE (SUBMARINES ONLY)

FM USS (SHIP NAME AND HULL NO.)//
TO COMSUBRON (SQUADRON NO.)//
TYCOM (COMSUBLANT/COMSUBPAC)//
INFO FMA (ACTIVITY)//
BT

(CLASSIFICATION)//N04790//

MSGID/GENADMIN/COMSUBRON// (AS APPROPRIATE)

SUBJ: (SUBS) AVAILABILITY PLANNING READINESS FOR USS (SHIP NAME AND HULL NO.)//
REF/ (AS APPROPRIATE)//

RMKS/1. SHIP CONCURS WITH REF A WITH THE FOLLOWING EXCEPTIONS: (NONE OR LIST EXCEPTIONS BELOW)

A. SCHEDULE REQUIREMENTS SUCH AS:

1. REVIEW ALL ACTION ITEMS FROM AVAILABILITY PLANNING MESSAGE.
2. REVIEW SCHEDULE OF KEY EVENTS.
3. ABILITY TO CONDUCT 100HR TRANSITION PLANS.

B. SHIP MATERIAL PREPARATION

1. REPORT STATUS OF PARTS FOR SHIP'S FORCE WORK AND DESIRES FOR ISIC/TYCOM ASSISTANCE IN PROCUREMENT.
2. ENSURE ALL OUTSTANDING CASREPS, SUBS, ZOZZS, AND TDENTS ARE IDENTIFIED IN AVAILABILITY PLANNING MESSAGE.

C. SHIP'S FORCE INTEGRATED SCHEDULE:

1. MISCELLANEOUS PROGRAMS (CAL, SMALL VALVE MAINTENANCE, ETC.).
2. DRILLS AND TRAINERS THAT WILL AFFECT SHIP'S FORCE ABILITY TO SUPPORT PRODUCTION WORK.
3. PRESERVATION ZONES.
4. PLANNED MAINTENANCE (TO INCLUDE PMS, RPPMS, AND PMT/KMRCS).

D. CO'S REPORT OF READINESS OR CONCERNS:

1. COMMANDING OFFICER REVIEW ABOVE ITEMS AND AVAILABILITY PLANNING MESSAGE AND REPORT READINESS AND EXCEPTIONS TO TRANSITION TO CMAV PERIOD.//

BT

NOTE: ENSURE MESSAGES ARE IN ACCORDANCE WITH CURRENT MESSAGE FORMAT AND CURRENT PLAD IS UTILIZED.

(This Page Intentionally Left Blank)

APPENDIX J**MAJOR TRIAL AND INSPECTION MILESTONES FOR IDD AND PIRA AVAILABILITIES**

EVENT	COGNIZANCE	APPROXIMATE SCHEDULE	CORRESPONDING APPENDIX
A. Periodic Monitoring Inspections	ISIC/TYCOM Representative	Start to completion	
B. Pre-Criticality Inspection (2 Days - Nuclear Powered Submarines Only)	ISIC (Only required when the reactor has been shutdown greater than 16 weeks)	Within 1 month of criticality	
C. Escort Recommendation (Message) or Waiver Request Message	TYCOM	Sea Trials - 28 days	Appendix B Para 4.9.9 for Waivers
D. NAVSEA Approval of Escort Waiver	NAVSEA	Sea Trials - 14 days	
E. Phase II Crew Certification/Material Inspection	ISIC/Crew Certification not required unless crew turnover greater than 15%. Material Inspection on a case by case basis	Prior to Fast Cruise	
F. Approve Sea Trials Agenda	ISIC	Prior to Fast Cruise (-7 to 14 days)	Guidelines in Appendix Q
G. Dock Trials (1 day or less)	CO of Ship	Sea Trials - 10 days	Guidelines in Appendix M
H. Audit REC, Departure from Specifications, URO MRCs (Formal Report Required)	ISIC	Sea Trials - 4 days	
I. Crew and Material Certification Message	ISIC	Sea Trials - 4 days	Appendix K
J. Supervising Authority SUBSAFE Certification Continuity Report	Supervising Authority	Sea Trials - 4 days	Reference (p), Paragraph 6.3.2.3.1
K. Readiness for Fast Cruise	CO of Ship	Sea Trials - 4 days	Appendix W
L. Grant Permission to Conduct Fast Cruise	ISIC	Sea Trials - 4 days	Appendix X

EVENT	COGNIZANCE	APPROXIMATE SCHEDULE	CORRESPONDING APPENDIX
M. Commence Fast Cruise	CO of Ship	Sea Trials - 3 days (1 to 2 days in duration)	Guidelines in Appendix N
N. Report Ship Readiness for Sea Trials	CO of Ship	Sea Trials - 1 day	Appendix Y
O. Message Update of Material Certification Status and Readiness for Sea Trials	ISIC	Sea Trials - 1 day	Appendix O
P. Authorization to Commence Sea Trials and Depth Authorization Message	TYCOM	Sea Trials - 1 day	Appendix P
Q. Commence Sea Trials	CO of Ship	0	Guidelines in Appendix Q
R. Daily Sea Trials Situation Report/Status Report	CO of Ship	At Least Daily During Sea Trials	Appendix F of Volume II, Part I, Chapter 3
S. Supervising Authority SUBSAFE Certification Continuity Report	Supervising Authority	Follow-On Sea Trials - 1 day	Reference (p), Paragraph 6.3.2.3.1
T. Report Ship Readiness for Follow-On Sea Trials	CO of Ship	Follow-On Sea Trials - 1 day	Appendix T
U. Update of Material Status prior to Follow-on Sea Trials.	ISIC	Follow-On Sea Trials - 1 day	Appendix U
V. TYCOM Authorization to Commence Follow-On Sea Trials and Depth Authorization	TYCOM	Follow-On Sea Trials - 1 day	Appendix V
W. Sea Trials Completion Message	CO of Ship to ISIC and TYCOM	+1 day After Sea Trials	Appendix L
X. URO Message	TYCOM	+1 day After Sea Trials	Appendix S

NOTE: UNLESS OTHERWISE INDICATED, SCHEDULE DATES ARE REFERENCED TO SEA TRIALS UNDERWAY DATE.

APPENDIX K

SAMPLE ISIC MESSAGE TO TYCOM CONCERNING CREW CERTIFICATION AND MATERIAL
CONDITION FOR FAST CRUISE AND SEA TRIALS FOR IDD OR PIRA AVAILABILITIES

FM COMSUB<RON/GRU NO.>//
 TO COMSUB<LANT/PAC> <NORFOLK VA/PEARL HARBOR HI>//
 INFO <SUPERVISING AUTHORITY>//<CODES>//
 USS <SHIP NAME>//
 COMSUBGRU<NO.>//
 BT
 UNCLAS//N09094//
 MSGID/GENADMIN/COMSUB<RON/GRU NO.>//
 SUBJ/(SUBS) USS <SHIP NAME/HULL NO.> CREW AND MATERIAL CERTIFICATION//
 REF/A/DOC/COMUSFLTFORCOM/<DATE>//
 REF/B/DOC/NAVSEA/<DATE>//
 REF/C/DOC/NAVSEA/<DATE>//
 NARR/REF A IS COMUSFLTFORCOMINST 4790.3, JOINT FLEET MAINTENANCE MANUAL. REF B IS
 SUBMARINE SAFETY (SUBSAFE) REQUIREMENTS MANUAL, NAVSEA 0924-062-0010. REF C IS
 NAVSEA URO MRC TECHNICAL MANUAL//
 RMKS/1. CREW CERTIFICATION CONDUCTED AND SATISFACTORILY COMPLETED IAW REF A.
 2. IAW REFS A AND B, COMSUB<RON/GRU NO.> CERTIFIES THE SUBSAFE CERTIFICATION BOUNDARY
 OF <SHIP NAME/HULL NO.> INSTALLED, REPAIRED AND/OR TESTED BY FORCES AFLOAT IS
 SATISFACTORY FOR SEA TRIALS TO TEST DEPTH. ALL SUBSAFE CONTROLLED WORK PACKAGES
 ARE CLOSED. CERTIFICATION REQUIREMENTS OF REF B HAVE BEEN SUSTAINED FOR THE
 REMAINDER OF THE SUBSAFE CERTIFICATION BOUNDARY. ALL OTHER CONTROLLED WORK
 PERFORMED BY SHIP'S FORCE HAS BEEN COMPLETED AND SATISFACTORILY RETESTED AND THE
 APPROPRIATE WORK PACKAGES CLOSED.
 3. MATERIAL/SALVAGE CONDITION CERTIFIED READY FOR SEA UPON COMPLETION OF THE
 FOLLOWING CORRECTIVE ACTIONS:
 A.
 B.
 4. THERE ARE NO OUTSTANDING RECS. THE FOLLOWING DEPARTURES FROM SPECIFICATION
 ARE CURRENTLY OUTSTANDING:
DEPARTURE NO. TYPE SYSTEM/COMPONENT RESTRICTION (IF ANY)
 A.
 B.
 5. ALL URO MRC AND MANDATORY TESTS/INSPECTIONS SPECIFIED IN REF C HAVE BEEN
 ACCOMPLISHED OR VERIFIED TO BE WITHIN THE REQUIRED PERIODICITY.
 6. COMSUB<RON/GRU NO.> REPORTS READINESS OF USS <SHIP NAME/HULL NO.> FOR COMMENCEMENT
 OF FAST CRUISE. CO USS <SHIP NAME/HULL NO.> CONCURS.//
 7. SUBJECT TO SATISFACTORY COMPLETION OF FAST CRUISE AND RESOLUTION OF MANDATORY
 DEFICIENCIES COMSUB<RON/GRU NO.> CONSIDERS USS <SHIP NAME/HULL NO.> MATERIAL CONDITION
 READINESS SATISFACTORY FOR COMMENCEMENT OF SEA TRIALS.//
 BT

**NOTE: ENSURE MESSAGES ARE IN ACCORDANCE WITH CURRENT MESSAGE FORMAT AND
 CURRENT PLAD IS UTILIZED.**

(This Page Intentionally Left Blank)

APPENDIX L

**SAMPLE SHIP MESSAGE TO ISIC AND TYCOM CONCERNING MATERIAL CERTIFICATION
UPON COMPLETION OF SEA TRIALS FOR IDD OR PIRA AVAILABILITIES**

FM USS <SHIP NAME>//
 TO COMSUB<LANT/PAC> <NORFOLK VA/PEARL HARBOR HI>//
 COMSUB<RON/GRU NO.>//
 <SUPERVISING AUTHORITY>//<CODES>//
 INFO CNO WASHINGTON DC//
 COMNAVSEASYS COM WASHINGTON DC//
 COM<LANT/PAC>FLT <NORFOLK VA/PEARL HARBOR HI>//
 DIRSSP WASHINGTON DC//{FOR SSBN/SSGN}
 COMSUBRON ELEVEN//
 COMSUBGRU<NO.>//
 BT
 UNCLAS //N09094//
 GENADMIN/COMSUB<RON/GRU NO.>//
 SUBJ/(SUBS) USS <SHIP NAME/HULL NO.> SATISFACTORY COMPLETION OF SEA TRIALS//
 REF/A/DOC/ COMUSFLTFORCOM/<DATE>//
 NARR/REF A IS COMUSFLTFORCOMINST 4790.3, JOINT FLEET MAINTENANCE MANUAL, VOLUME II.
 RMKS/1. USS <SHIP NAME> REPORTS SATISFACTORY COMPLETION OF SEA TRIALS. ALL TESTING
 REQUIRED BY THE SEA TRIALS TEST AGENDA AND REF (A) HAVE BEEN COMPLETED. <OR REPORT
 ALL TESTING NOT COMPLETED PER NOTE 1>.
 2. THERE WERE NO SUBSAFE DEFICIENCIES IDENTIFIED. <OR REPORT ALL SUBSAFE DEFICIENCIES>.
 3. THE <SUPERVISING AUTHORITY> TEST DIRECTOR CONCURS WITH THIS REPORT.
 BT

**NOTE 1: LIST ALL RE-ENTRIES TO MATERIAL CERTIFICATION BOUNDARY AND ALL WORK
ON SYSTEMS AFFECTING RECOVERABILITY, SALVAGE, WATERTIGHT INTEGRITY,
OR OPERATION OF SHIP'S CONTROL SURFACES WITH CORRECTIVE ACTION SINCE
RELEASE FOR FAST CRUISE MESSAGE.**

**NOTE: ENSURE MESSAGES ARE IN ACCORDANCE WITH CURRENT MESSAGE FORMAT AND
CURRENT PLAD IS UTILIZED.**

(This Page Intentionally Left Blank)

APPENDIX M

DOCK TRIALS GUIDELINES FOR IDD OR PIRA AVAILABILITIES

1. Dock Trials. Ship's Force Dock Trials provide the opportunity to test and check out systems, components and portable equipment prior to the Fast Cruise training period simulating underway conditions. Although normally a period of one day is assigned for integrated Ship's Force Dock Trials, tests and evolutions performed in the one to two weeks prior to the Dock Trial date may be accepted by the CO as fulfilling the requirements of this paragraph. The purpose of Dock Trials is to afford the ship an opportunity to demonstrate that major systems and equipment is in fact ready to support Sea Trials. It is expected that individual equipment will have been satisfactorily tested prior to commencement of the integrated operational tests afforded by Ship's Force Dock Trials.

1.1 Supervising Authority. The industrial activity may desire to conduct machinery checkouts, or system checks prior to the Ship's Force Dock Trials in order to test the propulsion plant or other ship's systems. In order to support these evolutions, close liaison between the ship's CO and the industrial activity will be required. For these evolutions, completion of repairs or modifications to all ship's systems are not required except for those systems which directly support the proposed tests.

1.2 Scheduling of Tests. The scheduling of Ship's Force Dock Trials is flexible. Ship's Force Dock Trials may be scheduled by mutual agreement between the ship and the supervising authority but must take place prior to certification of crew/material readiness with adequate time allowed for collection of deficiencies discovered during the Ship's Force Dock Trials. Preparation of the agenda and schedule for the Dock Trials is the CO's responsibility.

1.3 Extent of Trials. Ship's Force Dock Trials are conducted by the Ship's Force and are normally unhampered by repair work. This applies to the entire ship not just the propulsion plant. The trials may be witnessed by the industrial activity.

1.3.1 Tests. The term test shall include, where applicable:

- a. The review and use of a procedure for correct line-up, starting, operation and securing of systems or equipment.
- b. Rigging, connecting and using all hoses, fittings and devices required for the test evolution.
- c. Operation of systems in all modes, such as emergency, hand, override, cross-connected, normal, local, etc.
- d. Checking all electrical and mechanical, local and remote indicators for proper readings.
- e. Testing communications between normal control station and other locations involved in operating the system or performing the evolution.
- f. Calibration and adjustment of equipment, systems and devices where required.
- g. Inventory consumables, fittings, devices and portable test equipment to ensure that sufficient amounts are on board for proper operation throughout the trials.

1.3.2 Specific Test Areas. There are specific tests which relate to both systems and ship safety which must be conducted in preparation for Sea Trials.

- a. The following are specific alongside tests which shall be conducted during Dock Trials:
 - (1) Check the sound powered phone system between all stations.
 - (2) Check the announcing system between all stations.
 - (3) Test collision alarm and diving alarm.
 - (4) Test general alarm.
 - (5) Test each light on BCP.
 - (6) Test whistle.
 - (7) Check emergency lights.

- (8) Operate all hydraulic plants using each installed pump.
- (9) Conduct a complete air charge using only ship's compressors.
- (10) Conduct a normal battery charge using ship's motor generator on shore power.
- (11) Conduct low pressure blow of all Main Ballast Tanks (MBT). Thereafter conduct dockside operation portion of URO 022 (as appropriate).
- (12) Flood sanitary tanks and then blow/pump them.
- (13) Operate each main vent in hand and power. Following operation, with valves shut, conduct a controlled removal of MBT vent covers, one at a time, to check MBT vents for leaks.
- (14) Operate the outboard induction in hand and power.
- (15) Operate the diesel engine exhaust valve in hand and power.
- (16) Operate inboard induction valves.
- (17) Raise, train and lower periscopes, snorkel, radar and antenna masts and fairings as applicable.
- (18) Test operation of radio transmitters and receivers on all antennas.
- (19) Operate all sonar and radar equipment at rated conditions.
- (20) Take and plot LORAN/OMEGA/NAVSAT fixes using each antenna.
- (21) Test operation of drain pump using each bilge suction.
- (22) Test operation of trim system and pump by pumping to and from each tank and by pumping to and from sea (if applicable).
- (23) Calculate and enter the diving trim compensation.
- (24) Test operation of portable submersible pump from each installed outlet.
- (25) Fire inboard slugs from torpedo room.
- (26) Fire inboard slugs from weapons launch console.
- (27) Test magazine flooding system.
- (28) Operate each lube oil system including pumps, controllers, purifiers and indicators.
- (29) Start the Navigation System and gyrocompasses; determine that they settle out and take an azimuth; check all repeaters.
- (30) Check fresh water system, have water samples analyzed.
- (31) Test the capstans.
- (32) Test bow plane rigging (where applicable).
- (33) Test bow/sail and stern plane tilting in hand, normal power and emergency. Test normal and emergency plane angle indicators.
- (34) Test rudder in hand, normal and emergency power. Test normal and emergency rudder angle indicators.
- (35) Check alignment of periscopes, TBTs and all bearing and range repeaters.
- (36) Test the engine order telegraphs.
- (37) Test Automatic Bus Transfer Devices.
- (38) Operate each watertight door and hatch, each bulkhead flapper and each intercompartment air salvage valve.

- (39) Check operation of escape hatch fittings.
- (40) Operate signal ejectors by impulse and hand using dummy signal. Fire water slugs from all launchers, both locally and remotely.
- (41) Turn on and check running lights for brightness and proper lenses (to be done at night).
- (42) Check freon air conditioning system.
- (43) Check underwater log.
- (44) Check 400 Hz MG sets.
- (45) Check out galley equipment.
- (46) Check fathometer.
- (47) Check bilge flooding alarms.
- (48) Check dummy log.
- (49) Check ship service air system.
- (50) Check out vapor compressor distilling units.
- (51) Check anchor windlass and brake operation.
- (52) Check battery water system.
- (53) Check out atmosphere monitoring equipment, both installed and portable.
- (54) Operate oxygen generator, CO₂ scrubbers, CO burners and emergency air breathing system.
- (55) If possible, lower, train, operate and raise the SPM.
- (56) Ensure that all required PMS to ship depth detectors is complete.
- (57) Test diesel engine high vacuum cut-out. Take altimeter to engine room or diesel generator room for test.
- (58) Check main propulsion.
- (59) Ensure seven-day supply of oxygen onboard, test operate the Electrolytic Oxygen Generator(s) (EOG).

(This Page Intentionally Left Blank)

APPENDIX N**FAST CRUISE REQUIREMENTS FOR IDD OR PIRA AVAILABILITIES**

1. Fast Cruise Requirements. Asterisk items are the minimum requirements for an IDD or PIRA availability:

a. All Ships:

- * (1) Station the maneuvering watch and check each system and piece of equipment for proper operation. (For availability less than six months duration, system/equipment checks are not required.)
- * (2) Station the normal underway watch (section watches).
- (3) Simulate getting underway and return to port (day and night).
- * (4) Walk through all major Sea Trial evolutions, including cycling of hull and back-up valves to be tested during the deep dive.
- * (5) Exercise the reduced visibility detail.
- * (6) Rig for Emergency Ventilate.
- (7) Spot check storage and availability of spare parts and tools. Verify adequacy of stores and provisions.
- * (8) Rig for dive and rig for surface.
- * (9) Simulate diving and surfacing.
- * (10) Rig for deep submergence.
- (11) Rig for various quiet conditions.
- (12) Drill at loss of power to various circuits including lighting, communications, 400 Hz power, etc.
- (13) Battery charge - Normal or equalizer as required.
- * (14) Conduct the following emergency drills:
 - * (a) Fire.
 - * (b) Collision.
 - * (c) Flooding.
 - * (d) Toxic Gas.
 - (e) Abandon Ship.
 - * (f) Man Overboard.
 - (g) Submarine Escape.
 - (h) Loss of AC Power.
 - (i) Emergency Ventilation.
 - (j) Loss of Air Conditioning.
 - (k) Loss of Lighting.
 - (l) Loss of Interior Communications.
- (15) Exercise the crew at battle stations.
- (16) Conduct communications and ECM drills.

- * (17) Conduct an air charge to all air banks. (For availabilities less than six months duration, conduct an air charge.)
 - * (18) Bleed oxygen and ventilate ship. Ensure a seven day supply of oxygen is onboard and EOGs are fully operational. Ships without EOGs may provide a seven day supply of oxygen in O2 candle form and have oxygen banks inerted until after availability completion.
 - (19) Anchor.
 - (20) Operate atmosphere control equipment and take air samples.
 - * (21) Check out all interior communications circuits, including battle telephones.
 - (22) Simulate submerged patrol, performing all evolutions and operating equipment normally used.
 - * (23) Operate freshwater/seawater heat exchangers at sufficient load to verify proper operation (not fouled with marine growth).
 - (24) Nuclear powered submarines shall meet all requirements of reference (r), Appendix D, Part 3.
- b. Additional requirements for SSBN/SSGNs. SSBN/SSGNs shall conduct exercises in casualties to missile tube breather valves which would result in:
- (1) Flooding.
 - (2) Introducing toxic gases into the missile compartment from gas generators.

APPENDIX O

SAMPLE ISIC MESSAGE TO TYCOM CONCERNING FINAL MATERIAL CERTIFICATION PRIOR TO SEA TRIALS FOR IDD OR PIRA AVAILABILITIES

FM COMSUB<RON/GRU NO.>//
 TO COMSUB<LANT/PAC> <NORFOLK VA/PEARL HARBOR HI>//
 INFO COMSUBRON ELEVEN//
 COMSUBGRU <NO.>//
 USS <SHIP NAME>//
 <SUPERVISING AUTHORITY>//<CODES>//
 BT
 UNCLAS //N09094//
 GENADMIN/COMSUB<RON/GRU NO.>//
 SUBJ/(SUBS) USS <SHIP NAME/HULL NO.> MATERIAL CERTIFICATION/ READINESS FOR SEA TRIALS//
 REF/A/DOC/ COMUSFLTFORCOM/<DATE>//
 REF/B/RMG/COMSUB<RON/GRU NO.>/<DTG>//{ APPENDIX K }
 REF/C/RMG/USS<SHIP NAME>/<DTG>//{ APPENDIX Y }
 REF/D/DOC/NAVSEA /<DATE>//
 NARR/REF A IS COMUSFLTFORCOMINST 4790.3, JOINT FLEET MAINTENANCE MANUAL, VOLUME II.
 REF B IS COMSUB<RON/GRU NO.> REPORT OF CREW CERTIFICATION AND MATERIAL CONDITION
 FOR FAST CRUISE AND SEA TRIALS. REF C IS SHIP REPORT OF COMPLETION OF FAST CRUISE AND
 READINESS FOR SEA TRIALS. REF D IS NAVSEA 0924-062-0010, SUBMARINE SAFETY (SUBSAFE)
 REQUIREMENTS MANUAL.
 RMKS/1. IAW REFS A AND D, THIS MSG CERTIFIES THAT NO MANDATORY DEFICIENCIES FOR SEA
 TRIALS HAVE BEEN IDENTIFIED AS REPORTED IN REF B AND C. THERE HAVE BEEN NO RECS
 OPENED AND NO SUBSAFE DEPARTURES FROM SPECIFICATION PROCESSED SINCE THE START OF
 FAST CRUISE. <OR, REPORT ANY MANDATORY DEFICIENCIES DISCOVERED WITH CORRECTIVE ACTION, AND IF RECS
 AND/OR DEPARTURES FROM SPECIFICATIONS WERE PROCESSED SINCE THE START OF FAST CRUISE, REPORT ALL RECS
 OPENED SINCE THE START OF FAST CRUISE ARE CLOSED AND/OR ALL SUBSAFE DEPARTURES FROM SPECIFICATIONS
 PROCESSED SINCE THE START OF FAST CRUISE ARE RESOLVED.> ^(NOTE 1)
 2. THERE ARE NO SUBSAFE DEPARTURES FROM SPECIFICATIONS WITH CONDITIONS WHICH
 HAVE NOT BEEN SATISFIED. THE FOLLOWING ADDITIONAL DEPARTURES FROM SPECIFICATIONS
 WERE GENERATED SUBSEQUENT TO REF B. <If None, indicate NONE>
DEPARTURE NO. TYPE SYSTEM/COMPONENT RESTRICTION (IF ANY)
 A.
 B.
 3. REQUEST PERMISSION TO COMMENCE SEA TRIALS. CO <SHIP NAME/HULL NO.> CONCURS.//
 BT

NOTE 1: LIST ALL RE-ENTRIES TO MATERIAL CERTIFICATION BOUNDARY AND ALL WORK ON SYSTEMS AFFECTING RECOVERABILITY, SALVAGE, WATERTIGHT INTEGRITY, OR OPERATION OF SHIP'S CONTROL SURFACES WITH CORRECTIVE ACTION SINCE RELEASE FOR FAST CRUISE MESSAGE.

NOTE: ENSURE MESSAGES ARE IN ACCORDANCE WITH CURRENT MESSAGE FORMAT AND CURRENT PLAD IS UTILIZED.

(This Page Intentionally Left Blank)

APPENDIX P

SAMPLE TYCOM MESSAGE TO SHIP CONCERNING SEA TRIALS DEPTH AUTHORIZATION
FOR IDD OR PIRA AVAILABILITIES

FM COMSUB<LANT/PAC> <NORFOLK VA/PEARL HARBOR HI>//
 TO USS <SHIP NAME>//
 INFO CNO WASHINGTON DC//
 COMNAVSEASYS COM WASHINGTON DC//
 COM<LANT/PAC>FLT <NORFOLK VA/PEARL HARBOR HI>//
 DIRSSP WASHINGTON DC// {For SSBN/SSGN only}
 COMSUBGRU <NO.>//
 COMSUBRON< NO.>//
 <SUPERVISING AUTHORITY>//<CODES>//
 BT
 UNCLAS //N09094//
 MSGID/GENADMIN/COMSUB<LANT/PAC>//
 SUBJ/(SUBS) USS <SHIP NAME/HULL NO.> SEA TRIALS DEPTH AUTHORIZATION//
 REF/A/DOC/<SUPERVISING AUTHORITY>/<DATE>//
 REF/B/RMG/ COMSUB<RON/GRU NO.>/<DTG>//{ APPENDIX Y}
 REF/C/RMG/ USS <SHIP NAME>/<DTG>//{ APPENDIX X}
 NARR/ REF A IS <SUPERVISING AUTHORITY> SUBSAFE CERTIFICATION CONTINUITY REPORT FOR <SHIP
 NAME/HULL NO.>. REF B IS COMSUB<RON/GRU NO.> REPORT OF MATERIAL CONDITION OF SHIP NOT
 WORKED BY THE SHIPYARD. REF C IS SHIP REPORT OF SATISFACTORY COMPLETION OF FAST
 CRUISE
 RMKS/1. REF A CERTIFIED THE SUBSAFE MATERIAL CONDITION OF THOSE PARTS OF USS <SHIP
 NAME/HULL NO.> INSTALLED, REPAIRED AND/OR TESTED BY THE SHIPYARD IS SATISFACTORY FOR
 SEA TRIALS TO TEST DEPTH.
 2. REF B CONFIRMS THAT THE CERTIFICATION OF THE REMAINDER OF ITEMS WITHIN THE
 SUBSAFE CERTIFICATION BOUNDARY OF USS <SHIP NAME/HULL NO.> HAS BEEN SUSTAINED.
 ACCORDINGLY, THE STATUS OF THE SUBSAFE CERTIFICATION BOUNDARY OF USS <SHIP NAME/HULL
 NO.> IS SATISFACTORY FOR SEA TRIALS TO TEST DEPTH.
 3. REF B AND C REPORTED COMPLETION OF FAST CRUISE AND READINESS TO PROCEED ON SEA
 TRIALS.
 4. USS <SHIP NAME/HULL NO.> IS AUTHORIZED TO DIVE UNDER DELIBERATE AND CONTROLLED
 CONDITIONS TO <SPECIFIED DEPTH>.
**NOTE: IF AN UNSATISFACTORY CONDITION OR SEAWATER LEAKAGE IN EXCESS OF THE
 SPECIFICATION IS FOUND DURING THE CONDUCT OF THE CONTROLLED DIVE TO
 TEST DEPTH, AT THE DISCRETION OF THE COMMANDING OFFICER THE SHIP MAY
 CONTINUE TO TEST DEPTH UNLESS THE COMMANDING OFFICER DETERMINES IT
 APPROPRIATE TO ABORT THE DIVE.**
 5. THIS DEPTH AUTHORIZATION IS AUTOMATICALLY SUSPENDED UPON RE-ENTRY TO THE
 SUBSAFE CERTIFICATION BOUNDARY OR CASUALTY AFFECTING RECOVERABILITY, SALVAGE,
 WATERTIGHT INTEGRITY, OR OPERATION OF SHIP'S CONTROL SURFACES. THE SHIP SHALL NOT
 OPERATE AT A DEPTH GREATER THAN 200 FEET UNTIL RE-ENTRY IS CERTIFIED. TYCOM
 APPROVAL IS REQUIRED PRIOR TO COMMENCING A SUBSEQUENT DEEP DIVE TO CERTIFY WORK
 ACCOMPLISHED TO CORRECT SUBSAFE DEFICIENCIES DISCOVERED DURING THE SEA TRIAL
 UNLESS SPECIFICALLY ADDRESSED IN THE SEA TRIAL AGENDAS.//
 BT
**NOTE: ENSURE MESSAGES ARE IN ACCORDANCE WITH CURRENT MESSAGE FORMAT AND
 CURRENT PLAD IS UTILIZED.**

(This Page Intentionally Left Blank)

APPENDIX Q

MINIMUM SEA TRIALS REQUIREMENTS FOR IDD OR PIRA AVAILABILITIES

1. Sea Trial Agenda. This Appendix delineates the minimum requirements incident to Sea Trials following an IDD or PIRA availability. Additional events listed in Appendix O of Part I, Chapter 3, of this volume. Minimum Sea Trials Requirements for Chief of Naval Operations Availabilities Greater Than Six Months Duration (Submarines only), may be included by the repair activity based on the scope of work accomplished and/or as desired by the CO.
2. Sea Trial Policy. The following policies apply to conduct of trials and tests associated with IDD or PIRA availabilities:
 - a. No test or trial event shall be conducted that requires crew intervention to avoid exceeding normal operating limits. Trial agendas will be based on the expectation that the ship will remain within normal operating limits of the SOE and at angles of less than 30 degrees.
 - b. Any run which will result in exceeding normal operating limits of the SOE or 30 degree angles but which is essential to provide adequate test data must be specifically approved by the TYCOM. The test/trial sponsor will obtain this permission.
 - c. A violation of the SOE limit or exceeding a 30 degree angle, not previously approved, should be reported by unit Situation Report. The TYCOM will resolve the situation.
 - d. Specific written approval by the TYCOM is not required to operate outside the upper limits of the SOE, i.e., shallow and fast, while conducting the following operations during Sea Trials or tests in accordance with an agenda approved by the ISIC, NAVSEA or higher authority:
 - (1) Conducting full power runs or cavitation curves.
 - (2) NAVSEA sponsored acoustic trials in accordance with Naval Surface Warfare Center, Carderock Division acoustic trial agenda.
 - e. In cases where troubleshooting is required, it must meet the following criteria or a formally approved change to the agenda is mandatory.
 - (1) The troubleshooting does not violate any policy listed in paragraphs 2.a through 2.e of this Appendix or any other requirement of the trial agenda.
 - (2) The troubleshooting will not result in the ship being in a certain condition before that condition is reached during the normal testing sequence. For example, troubleshooting requiring the ship to be deeper than 200 feet cannot be done until after the deep dive. Likewise, troubleshooting requiring large angles or turn rates cannot be done until after the completion of the steering and diving operational tests and the large angle tests.
 - f. Each person involved in Sea Trials should be allowed to obtain a minimum of six hours of continuous, uninterrupted sleep during any 24-hour period.
3. Testing Phase. The Sea Trials should be scheduled and phased to support actions en route to the test dive area, in the test dive area, prior to the deep dive, etc., subject to the amplifying notes.
 - a. The following tests and evolutions shall be carried out on the surface en route to the test dive area and prior to the initial tightness dive:
 - (1) Underway. Rig for dive.
 - (2) Ship's Force instruct Sea Trials riders on the proper use of Emergency Air Breathing System.
 - (3) At slow speed, conduct operational test of rudder in all modes (local and remote) in accordance with applicable class operating procedures.
 - (4) Navigation system check. Takes fixes by all means available and compare.
 - (5) Test underwater log(s) using the base course/reciprocal course method (i.e., inertial reference method) or other approved functional procedures to determine accuracy.

- (6) Test accuracy of all bearing transmitters and indicators. Compare sonar, visual and radar bearings.
 - (7) Check operation of all radars. Demonstrate accuracy by conducting simultaneous radar and visual plot.
 - (8) Inspect stern tube packing gland/seals and circulating water flow for excessive heating, leakage and audible noise.
 - (9) Test fathometer(s) and compare with charted soundings.
 - (10) Run ahead, at maximum allowable surface speed, long enough for temperatures to reach a stable value. After readings have stabilized, at maximum allowable surface speed, operate the rudder through full throw in each direction, in **all remote modes of operation**.
 - (11) Ahead, at maximum allowable surface speed, to back emergency.
For SSBN/SSGN 726 Class **only** - Answer ahead standard. Once ship speed has stabilized, perform back emergency for 5 minutes.
 - (12) Run astern up to a **back full bell**. Full power run astern to be within the main engine limits of the applicable Steam and Electric Plant Manual.
For SSBN/SSGN 726 Class **only** - Run astern up to a back full bell for 5 minutes, followed by 60 SRPM for 5 minutes. (See Note 1.)
 - (13) Check operation and accuracy of ship's gyro compass.
 - (14) Rendezvous with escort, if an escort is required. Conduct radio and sonar communications checks (See Note 2).
 - (15) **Rig out bow planes**, if applicable. Test bow/fairwater and stern planes in all modes.
 - (16) Flood variable tanks to computed compensation less a safety factor.
 - (17) Operate trim and drain pumps.
 - (18) Test variable ballast system for proper operation.
 - (19) Perform a low pressure, normal and EMBT blow for as long as necessary to verify system operability. A static blow shall not be used to test the EMBT blow system. For SSN 23 only: Perform an MBT 6 normal blow from the BCP for a minimum duration of 2 seconds to verify that air flows into MBT 6 as indicated by a reduction in air bank pressure.
 - (20) Check that initial EMBT Blow system actuating air pressure and air bank pressure is within +0 PSIG, -200 PSIG of nominal operating air pressure.
 - (21) Ensure all MBT blow systems are in a normal line up configuration.
 - (22) Additional requirements may be imposed at the discretion of the CO.
- b. The following tests and evolutions shall be carried out immediately prior to or during the initial tightness dive:
- (1) Obtain navigational fix and take sounding. Maximum depth of water is 400 feet as specified in reference (g).
 - (2) Rig ship for deep submergence. Line up propulsion plant for maximum reliability. All systems shall be in the maximum secure condition with unnecessary sea systems isolated (See Note 3).
 - (3) Station additional personnel throughout the ship to inspect for leaks.
 - (4) Transmit commencing initial tightness dive message. Submerge the ship per the Ship Systems Manual Operating Procedures. If desired to conduct periscope depth tests, the ship may be submerged to periscope depth.
 - (5) Check operation of ship control systems, including depth indication (See Note 4).

- (6) When escort is required, communicate with escort on RAC/WQC at each depth increment or at 10-minute intervals, whichever is sooner. If communications are lost, return to depth at which communications can be established before continuing (See Note 2).
 - (7) All hands inspect for leaks and report them.
 - (8) Inspect the discharge of all automatic drains in each EMBT Blow quadrant for sea water leakage prior to the first dive when the ballast tanks are flooded (e.g., at periscope depth).
 - (9) At periscope depth, operate all masts checking optics and leakage. Observe speed and depth restrictions for masts without violation of the SOE (See Note 5). Event may be performed following initial dive, if sea state prevents operation at periscope depth.
 - (10) Test operation of trim and drain system **discharging** to sea.
 - (11) If not at 150 feet for SSN 688 Class submarines (155 feet for SSN 774 Class submarines), (160 feet for SSBN/SSGN 726 and SSN 21 Class submarines), proceed to 150 feet for SSN 688 Class submarines (155 feet for SSN 774 Class submarines), (160 feet for SSBN/SSGN 726 and SSN 21 Class submarines) and obtain SAT 1/3 trim in accordance with the Ship's Operating Manual. Take readings as required to make a check of ballasting.
 - (12) At 200 feet:
 - (a) Adjust trim (See Note 6).
 - (b) Inspect for leaks.
 - (c) Communicate with escort at each depth increment or at 10-minute intervals, whichever is sooner. If communications are lost, return to depth at which communications can be re-established before continuing (See Note 2).
 - (13) At 200 feet, in accordance with reference (s):
 - (a) Check accuracy of gauges and repeaters (See Note 4).
 - (b) Evaluate signal ejectors or launchers. Conduct operational test of each by hand and impulse methods, as applicable (See Note 7).
 - (c) Check shafting bearings and stern tubes for excessive heating, leakage and noise. Main shaft seals must be tested at each depth specified in reference (s) testing one seal for 20 minutes, and shifting to the other seal. Test the second seal for 20 minutes or until the boat is ready to go to the next depth, whichever comes first.
 - (d) Cycle rudder and planes through full throw at slow speed to check for binding.
- NOTE: REQUIRED SYSTEMS ARE LISTED IN PARAGRAPH 4b OF REFERENCE (s). OBSERVE RESTRICTIONS ON OPERATION OF SYSTEMS LISTED IN PARAGRAPH 4d OF REFERENCE (s).**
- (e) Operate all Main and Auxiliary Sea Water hull and back-up valves and those other seawater system valves worked during the availability (using remote closures, as applicable, from flooding control stations) that are required to maintain propulsion and other functions vital to the ship's operation.
 - (f) Operate Trim and Drain pumps, discharging to sea.
 - (g) Cycle main ballast tank vents to check for binding. Main ballast tank vents will be cycled hydraulically except at test depth where they will be cycled manually.
- (14) Test the SPM (See Note 13 in Appendix O of Part I, Chapter 3 of this volume).
 - (15) Additional requirements may be imposed at the discretion of the CO.

- c. The following tests and evolutions shall be carried out following the initial tightness dive and prior to the deep dive:

- (1) Transmit initial tightness dive complete message.
 - (2) A minimum of six hours of **ISE submerged for crew training**.
 - (3) Charge air banks and battery as necessary. The ship may be submerged while charging air banks provided the depth of the ship does not exceed other guidelines in this instruction, or those of the flooding bill or ship's operating procedure.
 - (4) If escort is required, detach escort after initial tightness dive. Escort will then proceed to station for deep dive. Ensure that deep dive rendezvous time and location are clearly established before escort is released. The escort may be retained for additional testing during the transit as described in Part I, Chapter 3, Appendix P of this volume. Transit depths shall not exceed depth as described in Part I, Chapter 3, Appendix P of this volume.
 - (5) Additional requirements may be imposed at the discretion of the CO.
- d. The following tests and evolutions shall be carried out immediately prior to or during the deep dive:
- (1) Check that initial EMBT Blow system actuating air pressure and air bank pressure is within +0 PSIG, -200 PSIG of nominal operating air pressure.
 - (2) Verify MBT systems lined up for normal operation.
 - (3) Take sounding. Accurately fix ship's position within the specified dive area in accordance with reference (g). Transmit commencing deep dive message.
 - (4) Proceed to normal submergence depth and obtain a 1/3 speed trim. Use conservative angles and speed on initial dive.
 - (5) Trim ship to maintain neutral buoyancy (See Note 6).
 - (6) Rig ship for deep submergence. Line up propulsion plant for maximum reliability. All systems shall be in the maximum secure condition with unnecessary sea systems isolated (See Note 3).
 - (7) Station additional personnel throughout the ship to inspect for leaks.
 - (8) At 400 feet and then in increments of 100 feet descending to one-half the maximum operating depth and every 100 feet or other lesser specified increments thereafter down to the maximum authorized operating depth:
 - (a) Adjust trim (See Note 6).
 - (b) Inspect for leaks.
 - (c) Communicate with escort (if escort required) at each 100 foot depth increment or at 10-minute intervals, whichever is sooner. If communications are lost, return to a depth at which communications can be re-established before continuing (See Note 2).
 - (9) At depths listed for hull valve cycling in reference (s) including the maximum authorized operation depth:
 - (a) Check accuracy of gauges and repeaters (See Note 4).
 - (b) Evaluate signal ejectors or launchers. Conduct operational test of each by hand and impulse methods, as applicable (See Note 7).
 - (c) Check shafting bearings and stern tubes for excessive heating, leakage and noise. Main shaft seals must be tested at each depth specified in reference (s) testing one seal for 20 minutes, and shifting to the other seal. Test the second seal for 20 minutes or until the boat is ready to go to the next depth, whichever comes first.
 - (d) Cycle rudder and planes through full throw **at slow speeds** to check for binding. Cycling of rudder and planes through full throw shall be limited to 90 % of test depth. **For SSN 21 Class follow the specific Sea Trial Agenda.**

NOTE: REQUIRED SYSTEMS ARE LISTED IN PARAGRAPH 4b OF REFERENCE (s). OBSERVE RESTRICTIONS ON OPERATION OF SYSTEMS LISTED IN PARAGRAPH 4d OF REFERENCE (s).

- (e) Operate all Main and Auxiliary Sea Water hull and back-up valves and those other seawater system valves worked during the availability (using remote closures, as applicable, from flooding control stations) that are required to maintain propulsion and other functions vital to the ship's operation at increments of depth specified in reference (s).

NOTE: TRASH DISPOSAL UNITS (TDU) WITH BALL VALVES WILL NOT BE OPERATED BELOW 200 FEET. TDUs WITH FLAPPER VALVES WILL NOT BE OPERATED BELOW 150 FEET.

- (f) Operate trim and drain pumps, discharging to sea.
- (g) Cycle main ballast tank vents to check for binding. Main ballast tank vents will be cycled hydraulically except at test depth where they will be cycled manually.
- (10) Surface fully with EMBT blow in accordance with applicable URO MRC. Check air bank pressures before and after blow. For SSN 23 only: Perform an MBT 6 normal blow from the BCP until MBTs 6A and 6B are blown to residual water levels.
- (11) Transmit completion of deep dive message.
- (12) Additional requirements may be imposed at the discretion of the Commanding Officer.
- e. The following tests and evolutions shall be carried out submerged following the deep dive:
 - (1) Full power run (See Notes 8, 9 and 10).
 - (2) Emergency stop (See Notes 9 and 10).
 - (3) Steering and diving operation at full speed (See Note 11).
 - (4) Steep angles - operate ship through several depth changes using large up and down angles. Check operation of ship machinery (See Note 9).
 - (5) Time raising each periscope and mast at maximum depth and speed for which they are designed. Check training feature where applicable.
 - (6) Run and observe air conditioning plants throughout trials noting deficiencies. Operate the Lithium Bromide air conditioning plant (if installed) to demonstrate ability to carry entire maximum existing ship's air conditioning load or 100 percent capacity.
 - (7) Additional requirements may be imposed at the discretion of the Commanding Officer.

4. Sea Trial Conclusion. At the conclusion of Sea Trials, and based on a review of Sea Trial deficiencies and TYCOM concurrence, the submarine may transit to a port other than the overhauling activity. During this transit the submarine shall not operate at depths greater than 400 feet (one-half test depth plus fifty feet for SSN 688 class), and shall not be released for unrestricted operations until all RECs are closed and any deficiencies identified during the controlled dive to test depth have been reported and reviewed by the TYCOM and specific TYCOM approval for URO is granted.

NOTES

1. For SSBN/SSGN 726 Class submarines **only** - This surface evolution, full power run astern, shall be conducted only if maintenance was accomplished on the reduction gears, the astern throttle(s) or the main shaft thrust bearing.
2. In the execution of any Sea Trial, whether escorted or not, submarine COs are reminded of their responsibility to communicate with escorts and/or shore authorities within the prescribed previously agreed upon time limits to avoid initiation of lost submarine procedures.
3. Reference (s) [C9094.2 (Series)] prescribes procedures for system operation during the deep dive.

4. Compare all depth and pressure gauges. Depth and pressure gauges should be checked as soon as each next specified depth is reached.
5. Any evolutions (e.g., mast testing, propeller cavitation data collection, etc.) required by the Sea Trial Agenda, which violate the ship's SOE, must be approved by the TYCOM prior to Sea Trials, in accordance with paragraph 2 of this Appendix.
6. Deep dive should be conducted using moderate speed and constantly adjusting trim at depths indicated in paragraphs 3.b.(12)(a) and 3.d.(8)(a) of this Appendix, to maintain neutral buoyancy. Moderate speed shall be defined as that range of speed that allows the ship to recover from a loss of stern plane control or flooding casualty or as otherwise directed by NAVSEA.
7. Integrity of launchers or signal ejectors shall be established by admitting sea pressure through equalizing lines or flooding connection and the muzzle valve/door operated before conducting operational tests. Shoot water slugs from specified launchers or signal ejectors at depths specified by reference (s). Shoot pyrotechnics on initial dive and at test depth on deep dive **only** if work was accomplished on the launchers or signal ejectors or if an escort vessel is required for the trial.
8. Run full power submerged for at least two hours. Operate at minimum non-cavitating depth, but not to exceed 400 feet, in accordance with reference (g); water depth is not limited for this event.
9. Note that the required sequence of events is initial dive, deep dive, full power run submerged, back emergency, then high speed maneuverability, and steep angle tests. Initial high speed ship control tests, steep angle tests and exercises at major casualties shall be conducted in water that does not exceed one and one-half times design test depth.
10. The submerged full power run with an ahead flank bell is to be terminated with a back emergency bell, consistent with current Main Propulsion Operating Limits (shaft torque is not a limiting factor in this test). The duration of the back emergency bell will be limited to 45 seconds, to be followed immediately by an appropriate ahead bell. The 45 second limit will:
 - a. Standardize the crashback requirements throughout the submarine force.
 - b. Provide a backing transient similar to that experienced in response to a stern plane jam.
 - c. Be short enough that no ship will gather sternway.

For SSBN/SSGN 726 Class submarines **only** - The submerged full power run with an ahead flank bell is to be terminated by reducing the bell to ahead standard until speed stabilizes. The ship is then to conduct a back emergency bell consistent with current Main Propulsion Operating Limits (shaft torque is not a limiting factor in this test). The duration of the back emergency bell will be limited to 45 seconds, to be followed by an appropriate ahead bell. The 45-second limit will avoid developing sternway.
11. At maximum safe speed, operate the rudder and planes through full throw in both directions, in all remote modes of operation.

APPENDIX R
SUBMARINE SEA TRIAL SITUATION REPORT
(SITREP)

FM USS <SHIP NAME>//
 TO COMSUB<LANT/PAC> <NORFOLK VA/PEARL HARBOR HI>//
 INFO CNO WASHINGTON DC//
 COM<LANT/PAC>FLT <NORFOLK VA/PEARL HARBOR HI>//
 COMNAVSEASYS COM WASHINGTON DC//
 DIRSSP WASHINGTON DC// {For SSBN/SSGN Only}
 <SUBOPAUTH>// {IF OTHER THAN PARENT TYCOM}
 COMSUBRON ELEVEN//
 COMSUBGRU <NO.>//
 COMSUB<RON/GRU NO.>//
 <SUPERVISING AUTHORITY>//<CODES>//
 (OTHER UNITS IN AREA IF APPLICABLE)//
 BT
 UNCLAS //N09094//
 MSGID/GENADMIN/USS <SHIP NAME>//
 SUBJ/(TYPE AVAILABILITY) SITREP (SEQUENTIAL NUMBER)//
 REF/A/DOC/COMUSFLTFORCOM/<DATE>//
 REF/B/DOC/AS APPLICABLE/<DATE>//
 NARR/ REF A IS COMUSFLTFORCOMINST 4790.3, JOINT FLEET MAINTENANCE MANUAL, VOLUME II.
 RMKS/1. CO'S SUMMARY, EVENTS 1-9 COMPLETED WITH THE FOLLOWING DEFICIENCIES NOTED:
 A. SUBSAFE/URO DEFICIENCIES.
 1) #1 SCOPE HULL GLAND LEAK 1 DPM AT 20% TD
 2) TDU VENT, TD-104 LEAKS 3 DPM AT 65% TD.
 3) STERN PLANES AUX ANGLE INDICATOR ON BCP DOES NOT ILLUMINATE, URO-16
 B. NON-SUBSAFE/URO DEFICIENCIES.
 1) SCULLERY DRAIN LEAKING AT FITTING F-18, 27 DPM
 2) 3 FLOOR TILES IN CREWS MESS LIFTED AFFECTING SANITATION
 3) CO HOT WATER SHOWER RECIRC PUMP FAILED
 2. PREVIOUS DEFICIENCIES REPORTED AND STATUS.
 (LIST ALL PREVIOUS DEFICIENCIES AND CURRENT STATUS-THE GOAL IS TO CAPTURE THE COMPLETE MATERIAL CONDITION IN EACH MESSAGE) STATUS = REPAIRED (REP), CORRECTIVE ACTION REQUIRED (CAR), NOT APPLICABLE (NA)
 EXAMPLE –
 1) SCULLERY DRAIN LEAKING AT FITTING F-18, 27 DPM -REP
 2) 3 FLOOR TILES IN CREWS MESS LIFTED AFFECTING SANITATION - CAR
 3) CO HOT WATER SHOWER RECIRC PUMP FAILED - CAR
 4) #1 SCOPE HULL GLAND LEAK 1 DPM AT 20% TD - CAR
 5) TDU VENT, TD-104 LEAKS 3 DPM AT 65% TD - CAR
 6) STERN PLANES AUX ANGLE INDICATOR ON BCP DOES NOT ILLUMINATE, URO-16 - REP
 3. ADDITIONAL INFO.
 1) DESCRIBE ANY ADDITIONAL INFO DESIRED OR LIST "NONE".
 4. TYCOM, NAVSHIPYD, AND NAVSEA REPS CONCUR-DO NOT CONCUR (AS APPROPRIATE).//
 BT
NOTE: ENSURE MESSAGES ARE IN ACCORDANCE WITH CURRENT MESSAGE FORMAT AND CURRENT PLAD IS UTILIZED.

(This Page Intentionally Left Blank)

APPENDIX S

SAMPLE TYCOM MESSAGE TO SHIP CONCERNING URO FOR IDD OR PIRA AVAILABILITIES

FM COMSUB<LANT/PAC> <NORFOLK VA/PEARL HARBOR HI>//
 TO USS <SHIP NAME>//
 INFO CNO WASHINGTON DC//
 COMNAVSEASYS COM WASHINGTON DC//
 COM<LANT/PAC>FLT <NORFOLK VA/PEARL HARBOR HI>//
 DIRSSP WASHINGTON DC//{FOR SSBN/SSGN}
 COMSUBGRU <NO.>//
 COMSUB<RON/GRU NO.>//
 <SUPERVISING AUTHORITY>//
 BT
 UNCLAS //N09094//
 MSGID/GENADMIN/COMSUB<LANT/PAC>//
 SUBJ/(SUBS) UNRESTRICTED OPERATION OF USS <SHIP NAME/HULL NO.>//
 REF/A/RMG/ USS <SHIP NAME>/<DTG>//
 REF/B/DOC/COMUSFLTFORCOMINST 4790.3//
 REF/C/DOC/ NAVSEA 0924-062-0010//
 NARR/REF A IS USS <SHIP NAME> MSG CONCERNING COMPLETION OF SEA TRIALS. REF B IS THE
 JOINT FLEET MAINTENANCE MANUAL. REF C IS THE SUBMARINE SAFETY
 (SUBSAFE) REQUIREMENTS MANUAL.//
 RMKS/1. REF A REPORTED THE SATISFACTORY COMPLETION OF SEA TRIALS WITH NO SUBSAFE
 DEFICIENCIES IDENTIFIED. (IF SPECIFIC SUBSAFE DEFICIENCIES WERE IDENTIFIED BUT WERE NOT DEEP DIVE
 RETEST FAILURES LIST SPECIFICS – DEEP DIVE TEST FAILURES WILL REQUIRE A FOLLOW-ON SEA TRIALS)
 2. TYCOM AUTHORIZES, USS <SHIP NAME/HULL NO.> TO CONDUCT OPERATIONS TO <SPECIFIED> DEPTH,
 SUBJECT TO THE FOLLOWING RESTRICTIONS: <LIST RESTRICTIONS IF THEY EXIST OR STATE "NONE">.
 3. CONTINUED CERTIFICATION FOR OPERATIONS TO TEST DEPTH IS SUBJECT TO COMPLIANCE
 WITH REF B AND REF C.
 BT
**NOTE: ENSURE MESSAGES ARE IN ACCORDANCE WITH CURRENT MESSAGE FORMAT AND
 CURRENT PLAD IS UTILIZED.**

(This Page Intentionally Left Blank)

APPENDIX T

**SAMPLE SHIP MESSAGE TO TYCOM CONCERNING READINESS FOR FOLLOW-ON SEA TRIALS
FOR IDD OR PIRA AVAILABILITIES**

FM USS <SHIP NAME>//
 TO COMSUB<LANT/PAC> <NORFOLK VA/PEARL HARBOR HI>//
 INFO COMSUBRON ELEVEN//
 COMSUBGRU <NO.>//
 COMSUB<RON/GRU NO.>//
 <SUPERVISING AUTHORITY>//<CODES>//
 BT
 UNCLAS //N09094//
 MSGID/GENADMIN//USS <SHIP'S NAME>//
 SUBJ/(SUBS) USS <SHIP NAME/HULL NO.>READINESS FOR <FOLLOW-ON ^(NOTE 1)>SEA TRIALS//
 REF/A/DOC/<SUPERVISING AUTHORITY>/<DATE>//
 REF/B/DOC/COMUSFLTFORCOM/<DATE>//
 REF/ REF A IS <SUPERVISING AUTHORITY> SUBSAFE CERTIFICATION CONTINUITY REPORT FOR <SHIP
 NAME/HULL NO.>. REF B IS COMUSFLTFORCOMINST 4790.3, JOINT FLEET MAINTENANCE MANUAL,
 VOLUME II.//
 RMKS/1. REF A CERTIFIED THE SUBSAFE MATERIAL CONDITION OF THOSE PARTS OF USS <SHIP
 NAME/HULL NO.> INSTALLED, REPAIRED AND/OR TESTED BY THE SHIPYARD IS SATISFACTORY FOR
 SEA TRIALS TO TEST DEPTH.
 2. USS <SHIP NAME/HULL NO.> AND CREW REPORTED READY TO PROCEED IAW REF B, ON <FOLLOW-ON
^(NOTE 1)> SEA TRIALS WITH THE FOLLOWING EXCEPTIONS:
 A. REMOVAL OF SHORE SERVICE CONNECTIONS.
 B.
 3. MATERIAL CONDITION SUPPORTS ADEQUATE CREW REST FOR UNDERWAY AT <TIME AND DATE>.
 4. REQUEST PERMISSION TO COMMENCE <FOLLOW-ON ^(NOTE 1)> SEA TRIALS.//
 BT
**NOTE 1: UPCOMING TRIAL WHICH IS SUBJECT OF THIS CERTIFICATION (E.G., SECOND SEA
 TRIAL, ETC.).**
**NOTE: ENSURE MESSAGES ARE IN ACCORDANCE WITH CURRENT MESSAGE FORMAT AND
 CURRENT PLAD IS UTILIZED.**

(This Page Intentionally Left Blank)

APPENDIX U

**SAMPLE ISIC MESSAGE TO TYCOM CONCERNING
MATERIAL CERTIFICATION FOR FOLLOW-ON SEA TRIALS IN CASES WHERE A PREVIOUS SEA
TRIAL WAS ABORTED OR CORRECTIVE ACTIONS FOR SEA TRIAL DEFICIENCIES REQUIRE AN
ADDITIONAL DEEP DIVE FOR IDD OR PIRA AVAILABILITIES**

FM COMSUB<RON/GRU NO.>//
 TO COMSUB<LANT/PAC> <NORFOLK VA/PEARL HARBOR HI>//
 INFO COMSUBRON ELEVEN//
 COMSUBGRU <NO.>//
 USS <SHIP NAME>//
 <SUPERVISING AUTHORITY>//<CODES>//
 BT
 UNCLAS //N09094//
 MSGID//GENADMIN/COMSUB<RON/GRU NO.>//
 SUBJ/(SUBS) USS <SHIP NAME/HULL NO.>MATERIAL CERTIFICATION/ READINESS FOR <FOLLOW-ON ^(NOTE 1)>
 SEA TRIALS//
 REF/A/DOC/ COMUSFLTFORCOM/<DATE>//
 REF/B/RMG/COMSUB<RON/GRU NO.>/<DTG>//{ APPENDIX Y }
 REF/C/DOC/NAVSEA /<DATE>//
 REF/D/RMG/USS <SHIP NAME>/<DTG>//{ APPENDIX T }
 NARR/REF A IS COMUSFLTFORCOMINST 4790.3, JOINT FLEET MAINTENANCE MANUAL, VOLUME II.
 REF B IS COMSUB<RON/GRU NO.> MSG TO TYCOM ON MATERIAL STATUS PRIOR TO INITIAL SEA
 TRIALS. REF C IS NAVSEA 0924-062-0010, SUBMARINE SAFETY (SUBSAFE) REQUIREMENTS
 MANUAL. REF D IS USS <SHIP NAME/HULL NO.> REPORT OF READINESS FOR FOLLOW-ON SEA
 TRIALS.//
 RMKS/1. IAW REF A AND C, THIS MSG CERTIFIES THAT NO MANDATORY DEFICIENCIES FOR
 <FOLLOW-ON ^(NOTE 1)> SEA TRIALS HAVE BEEN IDENTIFIED. THERE HAVE BEEN NO RECS OPENED AND
 NO FORCES AFLOAT SUBSAFE DEPARTURES FROM SPECIFICATION PROCESSED SINCE THE START
 OF THE INITIAL SEA TRIALS <OR, SUBSEQUENT TO REF B, REPORT ANY MANDATORY DEFICIENCIES DISCOVERED
 WITH CORRECTIVE ACTION, AND IF RECS AND/OR DEPARTURES FROM SPECIFICATIONS WERE PROCESSED SINCE THE
 START OF THE INITIAL SEA TRIALS, REPORT ALL RECS OPENED SINCE THE START OF INITIAL SEA TRIALS ARE CLOSED
 AND/OR ALL SUBSAFE DEPARTURES FROM SPECIFICATIONS PROCESSED SINCE THE START OF SEA TRIALS ARE RESOLVED
^{NOTE 2}>
 2. THERE ARE NO SUBSAFE DEPARTURES FROM SPECIFICATIONS WITH CONDITIONS WHICH
 HAVE NOT BEEN SATISFIED. THE FOLLOWING DEPARTURES FROM SPECIFICATIONS ARE
 CURRENTLY OUTSTANDING:

<u>DEPARTURE NO.</u>	<u>TYPE</u>	<u>SYSTEM/COMPONENT</u>	<u>RESTRICTION (IF ANY)</u>
A.			
B.			

 3. SHIP REPORTED READINESS FOR FOLLOW-ON SEA TRIALS IN REF D.//
 BT
 NOTE 1: **UPCOMING TRIAL WHICH IS SUBJECT OF THIS CERTIFICATION (E.G., SECOND SEA
 TRIAL, ETC.).**
 NOTE 2 **LIST ALL RE-ENTRIES TO MATERIAL CERTIFICATION BOUNDARY AND ALL WORK
 ON SYSTEMS AFFECTING RECOVERABILITY, SALVAGE, WATERTIGHT INTEGRITY,
 OR OPERATION OF SHIP'S CONTROL SURFACES WITH CORRECTIVE ACTION SINCE
 RELEASE FOR FAST CRUISE MESSAGE.**
 NOTE: **ENSURE MESSAGES ARE IN ACCORDANCE WITH CURRENT MESSAGE FORMAT AND
 CURRENT PLAD IS UTILIZED.**

(This Page Intentionally Left Blank)

APPENDIX V

**SAMPLE TYCOM MESSAGE TO SHIP CONCERNING FOLLOW-ON
SEA TRIALS DEPTH AUTHORIZATION FOR IDD OR PIRA AVAILABILITIES**

FM COMSUB<LANT/PAC> <NORFOLK VA/PEARL HARBOR HI>//
 TO USS <SHIP NAME>//
 INFO CNO WASHINGTON DC//
 COMNAVSEASYS COM WASHINGTON DC//
 COM<LANT/PAC>FLT <NORFOLK VA/PEARL HARBOR HI>//
 DIRSSP WASHINGTON DC//{FOR SSBN/SSGN}
 COMSUBGRU <NO.>//
 COMSUB<RON/GRU NO.>//
 <SUPERVISING AUTHORITY>/{<CODES>}//
 BT
 UNCLAS //N09094//
 MSGID/GENADMIN/COMSUB<LANT/PAC>//
 SUBJ/(SUBS) USS <SHIP NAME/HULL NO.> <FOLLOW-ON ^(NOTE 1)> SEA TRIALS DEPTH AUTHORIZATION//
 REF/A/DOC/<SUPERVISING AUTHORITY>/{<DATE>}//
 REF/B/RMG/ COMSUB<RON/GRU NO.>/{<DTG>}//{APPENDIX U}
 REF/C/RMG/ USS <SHIP NAME>/{<DTG>}//{APPENDIX T}
 NARR/ REF A IS <SUPERVISING AUTHORITY> SUBSAFE CERTIFICATION CONTINUITY REPORT FOR <SHIP NAME/HULL NO.>. REF B IS COMSUB<RON/GRU NO.> REPORT OF MATERIAL CONDITION OF SHIP NOT WORKED BY THE SHIPYARD. REF C IS SHIP REPORT OF READINESS FOR <FOLLOW-ON ^(NOTE 1)> SEA TRIALS
 RMKS/1. REF A CERTIFIED THE SUBSAFE MATERIAL CONDITION OF THOSE PARTS OF USS <SHIP NAME/HULL NO.> INSTALLED, REPAIRED, AND/OR TESTED BY THE SHIPYARD IS SATISFACTORY FOR <FOLLOW-ON ^(NOTE 1)> SEA TRIALS TO TEST DEPTH.
 2. REF B AND C CONFIRM THAT CREW IS READY FOR <FOLLOW-ON ^(NOTE 1)> SEA TRIALS AND REPORT THE CERTIFICATION OF THE REMAINDER OF ITEMS WITHIN SUBSAFE CERTIFICATION BOUNDARY OF USS <SHIP NAME/HULL NO.> HAS BEEN SUSTAINED. ACCORDINGLY, THE STATUS OF THE SUBSAFE CERTIFICATION BOUNDARY OF USS <SHIP NAME/HULL NO.> IS SATISFACTORY FOR <FOLLOW-ON ^(NOTE 1)> SEA TRIALS TO TEST DEPTH.
 3. USS <SHIP NAME/HULL NO.> IS AUTHORIZED TO DIVE UNDER DELIBERATE AND CONTROLLED CONDITIONS TO <SPECIFIED> DEPTH IAW THE <FOLLOW-ON ^(NOTE 1)> SEA TRIALS AGENDA CONCURRED IN BY REF B AND APPROVED BY REF C.
NOTE: IF AN UNSATISFACTORY CONDITION OR SEAWATER LEAKAGE IN EXCESS OF THE SPECIFICATION IS FOUND DURING THE CONDUCT OF THE CONTROLLED DIVE TO TEST DEPTH, AT THE DISCRETION OF THE COMMANDING OFFICER THE SHIP MAY CONTINUE TO TEST DEPTH UNLESS THE COMMANDING OFFICER DETERMINES IT APPROPRIATE TO ABORT THE DIVE.
 4. THIS DEPTH AUTHORIZATION IS AUTOMATICALLY SUSPENDED UPON RE-ENTRY TO THE SUBSAFE CERTIFICATION BOUNDARY OR CASUALTY AFFECTING RECOVERABILITY, SALVAGE, WATERTIGHT INTEGRITY, OR OPERATION OF SHIP'S CONTROL SURFACES. THE SHIP SHALL NOT OPERATE AT A DEPTH GREATER THAN 200 FEET UNTIL RE-ENTRY IS CERTIFIED. TYCOM APPROVAL IS REQUIRED PRIOR TO COMMENCING A SUBSEQUENT DEEP DIVE TO CERTIFY WORK ACCOMPLISHED TO CORRECT SUBSAFE DEFICIENCIES DISCOVERED DURING THE SEA TRIAL UNLESS SPECIFICALLY ADDRESSED IN THE SEA TRIAL AGENDAS.//
 BT
NOTE 1: UPCOMING TRIALS WHICH ARE SUBJECT OF THIS CERTIFICATION (E.G., SECOND SEA TRIALS, ETC.).
NOTE: ENSURE MESSAGES ARE IN ACCORDANCE WITH CURRENT MESSAGE FORMAT AND CURRENT PLAD IS UTILIZED.

(This Page Intentionally Left Blank)

APPENDIX W

SAMPLE SHIP MESSAGE TO ISIC CONCERNING READINESS FOR FAST CRUISE FOR IDD OR PIRA AVAILABILITIES

FM USS <SHIP NAME>//
 TO COMSUB<RON/GRU NO.>//
 INFO COMSUBRON ELEVEN//
 COMSUBGRU <NO.>//
 <SUPERVISING AUTHORITY>/<CODES>//
 BT
 UNCLAS //N09094//
 MSGID/GENADMIN/USS <SHIP NAME>//
 SUBJ/(SUBS) USS <SHIP NAME/HULL NO.> READINESS FOR FAST CRUISE//
 REF/A/DOC/<SUPERVISING AUTHORITY>/<DATE>//
 REF/B/RMG/COMSUB<RON/GRU NO.>/<DTG>/{ APPENDIX K}
 REF/C/DOC/COMUSFLTFORCOM/<DATE>//
 NARR/ REF A IS <SUPERVISING AUTHORITY> SUBSAFE CERTIFICATION CONTINUITY REPORT. REF B IS
 COMSUB<RON/GRU NO.> REPORT OF CREW CERTIFICATION AND MATERIAL CONDITION FOR FAST
 CRUISE AND SEA TRIALS. REF C IS COMUSFLTFORCOMINST 4790.3, JOINT FLEET MAINTENANCE
 MANUAL, VOLUME II.//
 1. REFS A AND B REPORTED READINESS OF SHIP FOR FAST CRUISE AND SEA TRIALS. USS <SHIP
 NAME/HULL NO.> AND CREW ARE READY FOR SEA TRIALS IAW REF C WITH THE FOLLOWING
 EXCEPTIONS:
 A. COMPLETION OF FAST CRUISE.
 B. REMOVAL OF SHORE SERVICE CONNECTIONS.
 2. REQUEST PERMISSION TO START FAST CRUISE.//
 BT
**NOTE: ENSURE MESSAGES ARE IN ACCORDANCE WITH CURRENT MESSAGE FORMAT AND
 CURRENT PLAD IS UTILIZED.**

(This Page Intentionally Left Blank)

APPENDIX X

SAMPLE ISIC MESSAGE TO SHIP AUTHORIZING COMMENCEMENT OF FAST CRUISE
FOR IDD OR PIRA AVAILABILITIES

FM COMSUB<RON/GRU NO.>//
 TO USS <SHIP NAME>//
 INFO CNO WASHINGTON DC//
 COM<LANT/PAC>FLT <NORFOLK VA/PEARL HARBOR HI>//
 COMNAVSEASYS COM WASHINGTON DC//
 COMSUB<LANT/PAC> <NORFOLK VA/PEARL HARBOR HI>//
 DIRSSP WASHINGTON DC // {For SSBN/SSGN only}
 <SUBOPAUTH>// {If other than parent TYCOM}
 COMSUBRON ELEVEN//
 COMSUBGRU <NO.>//
 <SUPERVISING AUTHORITY>/<CODES>//
 BT
 UNCLAS //N09094//
 MSGID/GENADMIN/USS <SHIP NAME>//
 SUBJ/(SUBS) USS <SHIP NAME/HULL NO.> READINESS FOR FAST CRUISE//
 REF/A/DOC/<SUPERVISING AUTHORITY>/<DATE>//
 REF/B/RMG/COMSUB<RON/GRU NO.>/<DTG>//{ APPENDIX K}
 REF/C/RMG/ USS <SHIP NAME>/<DTG>//{ APPENDIX W}
 REF/D/DOC/ COMUSFLTFORCOM/<DATE>//
 NARR/ REF A IS <SUPERVISING AUTHORITY> SUBSAFE CERTIFICATION CONTINUITY REPORT. REF B IS
 COMSUB<RON/GRU NO.> REPORT OF CREW CERTIFICATION AND MATERIAL CONDITION FOR FAST
 CRUISE AND SEA TRIALS. REF C USS <SHIP NAME> IS REPORT OF READINESS FOR FAST CRUISE AND
 SEA TRIALS. REF D IS COMUSFLTFORCOMINST 4790.3, JOINT FLEET MAINTENANCE MANUAL,
 VOLUME II.//
 1. REF A REPORTED <SUPERVISING AUTHORITY> ASSIGNED WORK COMPLETE AND READINESS FOR
 FAST CRUISE AND SEA TRIALS.
 2. REF B REPORTED REMAINING PORTIONS OF SUBSAFE BOUNDARY NOT WORKED BY
 <SUPERVISING AUTHORITY> MAINTAINED CERTIFIED AND READINESS FOR FAST CRUISE AND SEA
 TRIALS.
 3. REF C REPORTED SHIP'S FORCE READINESS FOR FAST CRUISE AND SEA TRIALS AND
 REQUESTED PERMISSION TO COMMENCE FAST CRUISE.
 4. IAW WITH REF D USS <SHIP NAME> IS AUTHORIZED TO COMMENCE FAST CRUISE. <SHIP NAME> IS
 DIRECTED TO REPORT COMPLETION OF FAST CRUISE AND ALL SUBSAFE DEFICIENCIES
 IDENTIFIED DURING FAST CRUISE TO COMSUB<RON/GRU NO.>, COMSUB<LANT/PAC> AND <SUPERVISING
 AUTHORITY>//
 BT

**NOTE: ENSURE MESSAGES ARE IN ACCORDANCE WITH CURRENT MESSAGE FORMAT AND
CURRENT PLAD IS UTILIZED.**

(This Page Intentionally Left Blank)

APPENDIX Y

**SAMPLE SHIP MESSAGE TO ISIC AND TYCOM CONCERNING READINESS FOR SEA TRIALS
FOR IDD OR PIRA AVAILABILITIES**

FM USS <SHIP NAME>//
TO COMSUB<LANT/PAC> <NORFOLK VA/PEARL HARBOR HI>//
COMSUB<RON/GRU NO.>//
INFO COMSUBRON ELEVEN//
COMSUBGRU <NO.>//
<SUPERVISING AUTHORITY>//<CODES>//
BT
UNCLAS //N09094//
MSGID/GENADMIN//USS <SHIP'S NAME>//
SUBJ/(SUBS) USS <SHIP NAME/HULL NO.>READINESS FOR SEA TRIALS//
REF/A/DOC/ COMUSFLTFORCOM/<DATE>//
NARR/REF A IS COMUSFLTFORCOMINST 4790.3, JOINT FLEET MAINTENANCE MANUAL, VOLUME
II//
RMKS/1. FAST CRUISE COMPLETED <TIME AND DATE>.
2. IAW REF A, USS <SHIP NAME/HULL NO.> AND CREW REPORTED READY TO PROCEED ON SEA TRIALS
WITH THE FOLLOWING EXCEPTIONS:
 A. REMOVAL OF SHORE SERVICE CONNECTIONS.
 B.
3. MATERIAL CONDITION SUPPORTS ADEQUATE CREW REST FOR UNDERWAY AT <TIME AND DATE>.
4. REQUEST PERMISSION TO COMMENCE SEA TRIALS.//
BT

**NOTE: ENSURE MESSAGES ARE IN ACCORDANCE WITH CURRENT MESSAGE FORMAT AND
CURRENT PLAD IS UTILIZED.**

(This Page Intentionally Left Blank)

VOLUME II
PART II
CHAPTER 1
SHIP MAINTENANCE VALIDATION,
SCREENING AND BROKERING

REFERENCES.

- (a) OPNAVINST 4700.7 - Maintenance Policy for U.S. Naval Ships

LISTING OF APPENDICES.

A Availability Creation and Numbering

1.1 PURPOSE. This chapter provides procedures and guidance regarding ship maintenance work candidate validation, screening and brokering processes. These processes affect all Type Commanders (TYCOM), Regional Maintenance Center (RMC) Commanding Officers and ship Maintenance Teams.

1.2 MAINTENANCE.

1.2.1 Regional Maintenance Centers. The command with overall responsibility for efficient planning and execution of all ship maintenance and modernization for assigned ships is the local RMC. The RMC is a subordinate command to Naval Sea Systems Command (NAVSEA). The RMC shall report Additional Duty to the appropriate TYCOMs. This reporting relationship ensures that the TYCOMs continue to effectively carry out their responsibilities relating to material readiness of their ships. Contact information for the RMCs can be found in Volume VI, Chapter 2, Appendix A of this manual.

1.2.2 Maintenance Team. Each ship shall have a formally structured Maintenance Team as identified in Volume VI, Chapter 41 of this manual

1.2.3 Class Maintenance Plan. The Class Maintenance Plan (CMP) database is an engineered set of organizational, Intermediate and Depot-level maintenance tasks, including the following: material condition assessment tasks (I-tasks), qualified repair and life renewal tasks (Q-tasks), availability routine tasks (R-tasks) and authorized Fleet and Program ship change tasks. Tasks are either scheduled or unscheduled.

- a. Scheduled tasks are those "I" Level and "D" Level tasks the cognizant technical authority (usually the designated In-Service Engineer) requires to be accomplished on a periodic basis. These tasks have been identified, using Reliability Centered Maintenance, to be both applicable and effective. The CMP system automatically pushes scheduled tasks for Maintenance Team screening and brokering based on last accomplished date and task periodicity.
 - (1) For Aircraft Carriers, scheduled tasks are pushed to the shore Current Ship's Maintenance Project (CSMP) six quarters before the deadline date, unless the periodicity is such that the task is due in less than 18 months. These tasks are mandatory and must be completed by the due date or approved for deferral or cancellation by the Ship Design Manager (SDM) (see paragraph 1.4.5.e of this chapter).
 - (2) For Surface Force ships, scheduled tasks are pushed to the shore CSMP and must be completed by the due date or approved for deferral or cancellation by the SDM (see paragraph 1.4.5.e of this chapter).
- b. Unscheduled tasks are pulled by the Maintenance Team based on evidence of need. This includes unscheduled assessment tasks, qualified repair tasks, approved ship changes with their associated support and service tasks and availability routine tasks. Additionally, if the need arises for a scheduled task to be accomplished before it has been pushed into the CSMP, the Maintenance Team has the ability to pull that scheduled task, and the last accomplished date will be appropriately updated.

1.3 WORK CANDIDATES.

1.3.1 Current Ship's Maintenance Project Composition. An accurate, up-to-date CSMP is essential for a well-maintained ship. The importance of documenting all discrepancies cannot be overemphasized because the CSMP is the basis for all funding. Only work that is documented in the CSMP will be authorized for accomplishment. The CSMP is maintained in two files, the organizational unit file and the shore file.

- a. Shipboard File. This file contains information regarding all known material discrepancies that require corrective maintenance. These discrepancies are normally discovered either by Ship's Force personnel during routine operations and planned maintenance or by non-Ship's Force personnel during material assessment, training and assist visits, documented in accordance with Volume VI Chapter 42 of this manual. The criticality of the discrepancy determines the maximum length of time allowed to upload the information regarding the discrepancy to the RMC responsible for managing the shore file. Exceptions to this policy are made within the considerations of bandwidth availability and Operational Security conditions.
 - (1) 2-Kilos (Naval Operations (OPNAV) 4790/2K) associated with correction of C2 Casualty Reports shall be uploaded within 24 hours.
 - (2) 2-Kilos associated with correction of C3/C4 Casualty Reports shall be uploaded within four hours.
- b. Shore File. This file contains the material discrepancies uploaded from the shipboard file, other work identified by shore-based managers and tasks from the CMP. Tasks from the CMP include pushed scheduled tasks, pulled tasks, authorized program and Fleet modernization work and availability support routines. The Type Desk Officer and Ashore Ship's Maintenance Manager are responsible for pulling CMP tasks as required based on evidence of need, availability support routines and Fleet and Program alterations into availability work packages. Although only on the CSMP shore file, this work is visible to Ship's Force via reports sent to the ship.

1.3.2 Requirements. All work requiring an expenditure of man-hours, material or a combination of both requires a work candidate (OPNAV 4790/2K) to document the identified requirement. Pushed and pulled CMP tasks are already formatted as OPNAV 4790/2Ks when transferred to the CSMP shore file. The OPNAV 4790/2K requires certain information to be included by the identifying activity to support the maintenance request and may be authored by activities other than the affected ship. There are three levels of the validation process:

- a. The ship (Ship Material Maintenance Officer or 3MC) shall do an initial validation of the work statement to determine if there is enough information for the designated representative (e.g., Ashore Ship's Maintenance Manager, Fleet Maintenance Activity Ship Superintendent, Project Manager, etc.) to understand the requirement.
- b. The Ashore Ship's Maintenance Manager working with members of the Maintenance Team is responsible for requirement validation, and will determine whether there is real need (objective evidence) and, if so, will also verify the requirement's urgency.
- c. Final validation is the responsibility of the Ashore Ship's Maintenance Manager. The Ashore Ship's Maintenance Manager ensures that the scope of the work is adequately defined and technically accurate before authorizing the work. This is the final product screened and brokered to a planning or execution activity.

1.3.3 Elements. A valid work candidate will provide the following key data elements at a minimum. The blocked numbers to the right of each item reference a OPNAV 4790/2K data block.

- a. Configuration information automatically entered from the master configuration database (Configuration Data Manager's Database/Ship's Configuration and Logistics Support Information System) by the shipboard system:
 - (1) Ship Unit Identification Code [1]
 - (2) Work Center Job Control Number [2]
 - (3) Allowance Parts List/Allowance Equipage List [4]

(4)	Ship Name	[A]
(5)	Ship Hull Number	[B]
(6)	Equipment Noun Name	[5]
(7)	Equipment Identification Code	[14]
(8)	Location	[16]
(9)	Ship Work List Item Number	[56]
(10)	References	
b.	Job Sequence Number	[3]
c.	Equipment Status Code	[7]
d.	When Discovered Date	[17]
e.	Deferred Date	[26]
f.	Symptoms and Supporting Information	[35]
g.	First Contact Name	[38]
h.	Priority	[41]
i.	Type Availability - (Recommended Accomplishment Level)	[42]
j.	Required Delivery Date	[28]
k.	Recommended resolution	[35]
	(1) Master Job Catalog, if applicable	
	(2) Port Engineer's Notes	
	(3) Additional references	
l.	Maintenance Action Requested	[35]
	(1) Assessment	
	(2) Repair	
	(3) Modernization	
m.	Maintenance Figure of Merit	In CSMP Shore File
n.	Initial Estimate (man days & material)	In CSMP Shore file
o.	TYCOM Screening Code	[45]
p.	TYCOM Screening Remarks	In CSMP Shore File

1.3.4 Guidelines. After a work candidate is created and uplined by an assessment activity or provided and entered into the CSMP shore file by the CMP or other means, it will be reviewed by the Ashore Ship's Maintenance Manager with the Maintenance Team. The Ashore Ship's Maintenance Manager will use the guidelines below to validate each work statement.

- a. Initial validation will be conducted on each new work candidate to ensure there is sufficient information to understand the requested maintenance action. The originator must populate configuration data elements from the master database by selecting the correct configuration item in a configuration-based system and complete data elements (1) through (7) listed in paragraph 1.3.3a. of this chapter. If the ship is the originator then data element (8) must also be present. All work candidates created in an ad-hoc mode or with an incorrect configuration item (and therefore incorrect configuration data) will be returned to the originating activity for cancellation and recreation.

- b. If configuration data in the master data base is incorrect (e.g., Allowance Parts List/Allowance Equipage List, Hierarchical Structure Code (Ship Work List Item Number) references, location, etc.), the Ashore Ship's Maintenance Manager shall act to correct the data at its source. The Ashore Ship's Maintenance Manager may request additional logistic assistance from the Configuration Data Manager to determine and document the correct data.
- c. When an initially validated work candidate is accepted as complete, the Ashore Ship's Maintenance Manager will then determine if there is enough objective evidence of need to validate the requirement. If not valid, the work candidate will be returned to the originator and cancelled.
- d. CMP material assessments may be accomplished outside of a depot maintenance period to allow for proper planning and preparation of resulting work during a depot maintenance period. However, CMP maintenance should be scheduled and executed during depot maintenance periods.
- e. If during validation, the Maintenance Team finds inaccurate configuration data or has questions concerning the necessity of a "Pushed" CMP work candidate, they will contact the appropriate maintenance planning activity prior to returning or cancelling the work candidate.

1.3.5 Validation.

- a. Validation is the process of reviewing an off-ship work statement to ensure that the correct configuration item (lowest repairable unit, equipment, system, etc.) is properly identified and that there is enough information to determine if the work candidate is required (objective evidence) and, if valid, contains enough information to:
 - (1) Properly determine the correct resolution inclusive of the root cause.
 - (2) Screen to the right maintenance period to support ship operations.
 - (3) Broker to the right activity to perform the work at the most practicable level.
 - (4) Pass to history.
- b. The goal of the validation process is to provide a work candidate that is sufficiently defined, contains correct and complete information, provides an accurate diagnosis, and provides an applicable, effective, and feasible recommended resolution. A properly validated work candidate should provide the planning and executing activities with the ability to understand the requirement without expending additional manpower or time obtaining required information. The Ashore Ship's Maintenance Manager along with the Maintenance Team validates all off-ship (Type Availability 1, 2 and 3) work candidates before screening them to the planning activity by review of 2-Kilo documentation, personal shipboard observation of conditions, and knowledge of the quality of work candidates written by selected work centers or through additional technical assistance. All validated work candidates shall be ship-checked by the Ashore Ship's Maintenance Manager or designated representative when practicable. The purpose of this check is to determine the best maintenance action and add to Block 35 (data elements k. and l. in paragraph 1.3.3 of this chapter).

1.3.6 Verification. The Ashore Ship's Maintenance Manager may request additional assistance to determine and document the best corrective action. The recommended action will include all pertinent interferences, integration issues, verification of urgency and an initial estimate (data element n. in paragraph 1.3.3 of this chapter). The initial estimate for each job includes mandays, manday rate and material costs. When validated, the Ashore Ship's Maintenance Manager will assign a TYCOM Screening Code (data element o. in paragraph 1.3.3 of this chapter) to the work candidate. This shows the job as valid and ready for screening and brokering.

1.4 SCREENING/BROKERING.

1.4.1 Screening and Brokering Work Candidates. The Ashore Ships Maintenance Manager validates and screens work candidates continuously as they are documented. Work integration may entail screening multiple work candidates together when possible. Work screening also entails selecting the appropriate level of repair and the best opportunity in which to accomplish the work. The Ashore Ships Maintenance Manager makes recommendations on the lowest level of executing activity with the capability and the capacity to accomplish the work during the required time frame, following the guidance of the TYCOM business rules (e.g., Volume VI, Chapter 31 of this manual for Surface Force Ships).

- a. Management of ship maintenance is best performed by individuals most familiar with the condition of the ship, budgetary considerations and available workforce. (This requires a cooperative effort from the Ashore Ships Maintenance Manager and the Naval Supervisory Authority (NSA) Lead Maintenance Activity (LMA) for Submarine Fleet Availabilities). They have the responsibility to accomplish maintenance, repair and modernization work within available financial resources while balancing operational and technical risk.
- b. The Ashore Ship's Maintenance Manager screens all work candidates to the right time period and maintenance availability (e.g., Chief of Naval Operations (CNO) availabilities, Continuous Maintenance Availability, Window of Opportunity (WOO), Emergent Availability). Determination includes balancing operational schedule, material readiness requirements and cost concerns to maximize maintenance productivity (material readiness/related maintenance cost).
- c. All work screened by the Ashore Ship's Maintenance Manager to be accomplished aboard ship will be electronically visible to the NSA (LMA for Submarine Fleet Availabilities). Work assigned to the NSA (LMA for Submarine Fleet Availabilities) will be tasked in accordance with Ashore Ship's Maintenance Manager brokering determination. TYCOM approval is required if the initial brokering determination needs to be changed.

1.4.2 Screening/Brokering. Although they may appear to be accomplished simultaneously, screening and brokering are actually two distinct processes.

- a. Screening. Determines and assigns the work candidate to the right time period and maintenance availability. Determination includes balancing operational schedule, material readiness requirements and cost concerns to maximize maintenance productivity (material readiness/related maintenance cost).
- b. Brokering. Determines and tasks the right activity to perform the work based on business case analysis, material availability, experience, tool requirements, personnel requirements, special considerations (Environmental, Health and Safety) and capacity.

1.4.3 Key Data.

- a. The validated work candidate contains the following key data elements to aid in the screening and brokering process:
 - (1) Configuration Item (maintenance object) identification.
 - (2) Symptom (OPNAV 4790/2K - Block 35).
 - (3) Expected scope of preventive/corrective/alterative maintenance (OPNAV 4790/2K - Block 35).
 - (4) Required Completion Date (RCD).
 - (5) Level of Maintenance (TYCOM Code 1,2,3).
 - (6) Identification of a Master Spec Catalog item (pre-planning data).
 - (7) Priority (Figure of Merit).
- b. All OPNAV 4790/2Ks in the Master File should be screened and brokered to a maintenance availability within eight days after being uploaded from the Shipboard File.
- c. Work candidates will be brokered to the appropriate maintenance activity with the capability and capacity to accomplish the work during the required time frame. When practicable, Fleet Maintenance Activity capacity will be utilized first.
- d. Available capacity will be judged after applying Maintenance Figure of Merit and Deadline Date. For Surface Force ships, this determination is made through a coordinated effort between the Project Manager, Ashore Ship's Maintenance Manager, RMC Ship superintendent and the Maintenance Team Private Sector Industrial Activity representative (If under a Private Sector Industrial Activity contract).

- e. The cause and effect relationship between screening and brokering must be exercised to maximize maintenance productivity. This may require negotiation with the ship and/or maintenance activity to adjust the Deadline Date.
- f. Other considerations for screening and brokering:
 - (1) Synergistic relationship between work candidates exist.
 - (2) Splitting responsibility.
 - (3) Third party access.
 - (4) Port loading.
 - (5) RMC Production Department training requirements.

1.4.4 Guidelines.

- a. Validation, screening and brokering will be accomplished continuously. The Ship Material Maintenance Officer will provide recommendations to the Ashore Ship's Maintenance Manager. The Ashore Ship's Maintenance Manager will use the guidelines below to screen and broker work candidates to the proper availability.
- b. All work will be screened to an availability created and numbered in accordance with the business rules in Appendix A of this chapter.
- c. Work candidates shall be screened to the following type of availabilities: CNO, Continuous Maintenance (CM), emergent or unfunded. No other type of availability shall be used.
 - (1) CNO Availability. The work candidate is best performed during the scheduled CNO availability. These work candidates include major Ship Alterations and repairs that require support services and coordination.
 - (2) Continuous Maintenance Availability. Based on ship availability, priority of the job, business case analysis, periodicity or other consideration, the maintenance should be performed during a scheduled Continuous Maintenance Availability or during a window of opportunity permitted by ship's schedule.
 - (3) Emergent Availability. Emergent work is performed at greater cost than work planned and completed in other availabilities. The criteria to be used to qualify work as emergent is provided in TYCOM business rules (e.g., Volume VI, Chapter 31, Paragraph 31.3.3 of this manual for Surface Force ships).
 - (4) Unfunded Availability. This availability is reserved for work candidates, which should be shown as backlog or are of such low priority they are unlikely ever to be accomplished.
- d. Brokering shall be as follows:
 - (1) Work candidates for technical assistance, assessment or inspection will be brokered to the RMC Fleet Maintenance Activity or another technical activity.
 - (2) Work candidates will be brokered to the lowest level of maintenance activity, filling Fleet Maintenance Activity capacity first, based on the following criteria:
 - (a) Material availability.
 - (b) Capability:
 - 1 Experience.
 - 2 Available Production Resource Tools.
 - 3 Available qualified/certified personnel.
 - 4 Ability to comply with Environmental, Health and Safety regulations.
 - (c) Work center capacity.

(d) Funding.

1.4.5 Additional Requirements for Scheduled Mandatory Tasks Pushed by CMP. (Surface Force ships only) Since mandatory tasks pushed to the CSMP by the CMP are directed by proper Technical Authority, further screening and brokering restrictions apply.

- a. Certain fields on mandatory tasks cannot be changed, including job summary, problem description, recommended solution, deadline date and maintenance level.
- b. Mandatory tasks must be accomplished by an off-ship maintenance activity, not by Ship's Force. Organizational-level requirements are scheduled by Planned Maintenance System (PMS), not by CMP.
- c. Mandatory tasks cannot be cancelled or passed to history by the Maintenance Team, or customer completed without being screened to an availability. If cancellation is requested, the CMP item must be adjudicated by proper Technical Authority and approved for cancellation as dictated in paragraph 1.2.3 of this chapter.
- d. Mandatory tasks shall be screened to a defined maintenance period instead of to the year-long CM availability. When equipment condition requirement or other scheduling problems make it impractical to accomplish the mandatory task, the year-long CM availability may be used for non-depot mandatory tasks. However, mandatory tasks screened to a CM availability will be considered to be improperly deferred after the mandatory tasks deadline date without consideration of the availability end date (see paragraph 1.4.5.g.(1) of this chapter).
- e. Mandatory task may not be screened to an emergent maintenance period. Planned maintenance does not warrant the use of emergent maintenance money. This requirement does not preclude pulling a task from the CMP when needed and screening it to an emergent maintenance period.
- f. If the mandatory task is screened to the unfunded availability or to an availability that begins more than 90 days after the mandatory task's deadline date, a "notification" is triggered by the Cancellation Deferral Notification System (CDNS) to notify the appropriate Technical Authority and a Departure From Specification (DFS) may be required. The Ashore Ship's Maintenance Manager comments will be reviewed and the Technical Authority will either recommend approval or disapproval of the DFS. The Ashore Ship's Maintenance Manager shall then rescreen the mandatory tasks to an appropriate availability in accordance with the guidance provided in the DFS. This functionality is referred to as the "CDNS Process".
 - (1) The Ashore Ship's Maintenance Manager may challenge whether the mandatory tasks should be accomplished (as opposed to not accomplished until after the deadline date). The task should be screened to the unfunded availability and comments entered. Depending on whether the CDNS notification is administrative or technical, the mandatory tasks will be adjudicated in the following manner:

NOTE: THE SUBSTITUTED WORK CANDIDATE WILL BE SUBJECT TO THE SAME PUSHED TASK RESTRICTIONS DESCRIBED IN THIS SECTION.

- (a) Administrative: If the intent of the task was completed since the Last Accomplished Date by a non-CMP work candidate, provide that Job Control Number in the comment field. If the Planning Activity Engineer agrees that the intent of the task was met by the non-CMP work candidate, the Planning Activity Engineer will cancel the pushed mandatory tasks from the CSMP. If the intent of the task is covered by a non-CMP work candidate that is currently open and in planning or execution, the Planning Activity Engineer will substitute the pushed mandatory tasks with the non-CMP work candidate and cancel the pushed mandatory tasks from the CSMP. If the mandatory tasks cannot be accomplished because the component/system no longer exists on the ship, the Planning Activity Engineer will cancel the pushed mandatory tasks from the CSMP and update the configuration records. For all administrative notifications, if the Planning Activity Engineer does not agree with the Port Engineer's comments, the CDNS notification will be forwarded to the SDM for resolution.

- (b) Technical: The Ashore Ship's Maintenance Manager can technically challenge pushed mandatory tasks using CDNS. Reasons for technically challenging mandatory tasks include: non-modernization configuration change, permanent or temporary DFS exists, and/or authorized modernization upgrade to equipment. If the Planning Activity or SDM disapproves the CDNS notification an email will be sent to the Ashore Ship's Maintenance Manager providing justification. All technical challenges will be reviewed by the Planning Activity or SDM for resolution.
 - (2) If the Ashore Ship's Maintenance Manager determines that the mandatory tasks should be accomplished beyond the due date, the task should be screened to the recommended availability and comments entered. Reasons for deferring a mandatory task past its due date include: a temporary DFS exists making the task unnecessary before the due date, lack of an appropriate maintenance availability by the due date, unable to set required assessment conditions because of a related casualty or other issue, lack of capability/capacity to accomplish the mandatory tasks by due date, etc. Deadline challenges shall be documented using the CDNS Process and must be reviewed and approved by the Planning Activity and a DFS may be required.
- g. CMP push tasks must be accomplished within required periodicity, or approval for deferral in the CDNS Process by NAVSEA Technical Authority. Ashore Ship's Maintenance Managers, RMCs and TYCOMs should resolve these mandatory task deferrals promptly. CMP push tasks can be addressed using a DFS and/or the CDNS Process. Deferred CMP push task delays are categorized as:
 - (1) Open and overdue. Often, CMP push tasks are screened to an appropriate availability but are not executed by their deadline dates. Sometimes, task deferrals are approved through the CDNS Process but then are subsequently moved to a later availability without further Planning Activity or SDM approval. Open and overdue jobs are particularly troublesome because they are now past the deadline date and do not have deferral approval from Technical Authority via a DFS and/or the CDNS Process. Specific types of open and overdue CMP push tasks jobs include:
 - (a) Job is open, screened to a year-long CM availability and past its deadline date.
 - (b) Job is open, screened to an acceptable numbered availability (one that starts no later than 90 days after the deadline date or one approved in the CDNS Process by the Planning Activity or SDM).
 - (c) Job is open, unscreened and past its deadline date.
 - (2) Overturned and not rescreened. When a mandatory task is challenged by the Ashore Ship's Maintenance Manager via DFS and/or the CDNS Process but that challenge is overturned by Technical Authority, the Ashore Ship's Maintenance Manager receives an email stating that the job must be rescreened to an appropriate availability for accomplishment. Jobs should be rescreened to an appropriate availability within 30 days after the Ashore Ship's Maintenance Manager is made aware of the ruling.
- h. Deferral notifications approved by the Planning Activity or SDM are approved for the availability to which the mandatory task was screened when the mandatory task triggered a notification. If a mandatory task is subsequently rescreened to a later availability, the approval is removed and the screening action must be acted on by the Planning Activity or SDM again.

1.5 ASSESSMENTS.

1.5.1 Maintenance Team.

- a. All material condition assessments, including tasks for Combat Systems Command, Control, Communications and Computer Readiness Assessments or Total Ship's Readiness Assessment, shall be derived from the CMP. Scheduled condition assessments have been validated by an approved Reliability Centered Maintenance analysis to be applicable and effective, and are pushed by the CMP system to the CSMP shore file for the Ashore Ship's Maintenance Manager action, based on the ship's last accomplished date and task periodicity. Unscheduled material condition assessments are not,

without further evidence of need, considered effective and are thereby not pushed into the CSMP shore file, but can be pulled from the CMP by the Ashore Ship's Maintenance Manager or his representative if there is evidence of need (such as degraded performance, errors, or other indication of problems). Scheduled tasks can also be pulled if circumstances warrant, and the Last Accomplished Date will be properly updated. The Ashore Ship's Maintenance Manager with help from the Maintenance Team shall review all 2-Kilos pushed from the CMP system just as for any other offship 2-Kilo, and broker to the appropriate assessing activity.

- b. Only assessment tasks in the CMP or assessment procedures in the PMS database may be used for assessments. Information addressing assessment requirements found not to be included within the CMP or PMS databases, such as local practices, In-Service Engineering Activity unique items, RMC practices, etc., shall be forwarded using the Technical Feedback Report for review and approval as an acceptable addition to the CMP and PMS databases. If not approved, these practices shall not be used by any activity.
- c. The Ashore Ship's Maintenance Manager will make the preliminary determination of the most appropriate source for all off-ship activity work for their assigned ships. Decisions made by the Ashore Ship's Maintenance Manager, with concurrence from the Maintenance Team, shall be in compliance with policies in this instruction, reference (a), and guidance provided by the cognizant RMC.

1.5.2 Type Commander. The TYCOM shall develop and execute a Memorandum of Agreement in accordance with Volume II, Part I, Chapter 3 of this manual with each supporting RMC to define reporting and administrative relationships between the TYCOM and the RMCs.

(This Page Intentionally Left Blank)

APPENDIX A

AVAILABILITY CREATION AND NUMBERING

1. Specifying Availabilities. A uniform method of specifying availabilities is an essential part of availability management and data collection. No deviation from these protocols is permitted. **An availability is defined as a specified period of time during which maintenance is conducted. Only Type Desk Officers, Type Desk Program Managers, and Ashore Ship's Maintenance Managers are authorized to create availabilities. Availabilities shall include all work completed during a specific time period regardless of executing activity. With exception of the emergent availability, availabilities shall not overlap and work by every activity (depot, Intermediate Maintenance Activity (IMA), Alteration Installation Team, tech assist and Ship's Force) shall be entered into the same availability. Availability numbers are not to be used as a method of segregating the executing activity or the level of work performed. SSGN and SSBN will be exempt from the requirements of this appendix due to use of the existing Logistic Data System (LDS) program. TRIDENT Availabilities are negotiated and established based on the Fleet Scheduling Conference and are not managed by Type Desk Officers, Type Desk Program Managers or Ashore Ship's Maintenance Managers.**
2. Availability Numbering. The availability number consists of the first four digits -- the availability category code and the availability serial number. The Funding Activity Code (FAC) is used to identify the source of funding for any job and is entered at the time of job screening and authorization. The availability numbering system shall consist of:
 - a. A one-digit availability category code.
 - b. A three-digit availability serial number.
 - c. A two-digit funding activity code.
3. Availability Category Code: This code is the first character of the four-digit availability number. These codes are used by all TYCOMs and, therefore, not all codes are applicable to all ships. The stand alone "I" availability is no longer used by the Surface Force.

<u>CODE</u>	<u>TITLE</u>
A	ALONGSIDE SCHEDULED CONTINUOUS MAINTENANCE
B	DOCKING SELECTED RESTRICTED AVAILABILITY (DSRA)
C	SELECTED RESTRICTED AVAILABILITY (SRA)
D	COMPLEX OVERHAUL
E	EXTENDED INCREMENTAL SELECTED RESTRICTED AVAILABILITY
F	EXTENDED DOCKING SELECTED RESTRICTED AVAILABILITY (EDSRA)
G	EXTENDED SELECTED RESTRICTED AVAILABILITY (ESRA)
H	DOCKING INCREMENTAL SELECTED RESTRICTED AVAILABILITY (DISRA)
I	INTERMEDIATE MAINTENANCE AVAILABILITY
J	INCREMENTAL SELECTED RESTRICTED AVAILABILITY
K	INTERIM/EMERGENT DRY DOCK
L	DOCKING PHASED MAINTENANCE AVAILABILITY
M	PHASED PLANNED MAINTENANCE AVAILABILITY
N	INACTIVATION AVAILABILITY (INAC)
O	POST DELIVERY AVAILABILITY
P	CONTINUOUS AVAILABILITY (YEAR LONG CM)
Q	POST SHAKEDOWN AVAILABILITY

R	REGULAR OVERHAUL
S	SELF AVAILABILITY/SHIP TO SHOP AVAILABILITY
U	UNFUNDED
V	PLANNED INCREMENTAL AVAILABILITY (PIA)
W	DEPOT MODERNIZATION PERIOD
Z	VOYAGE REPAIRS (PER TITLE X)/STRIKE FORCE INTERMEDIATE MAINTENANCE ACTIVITY
1	DOCKING PLANNED INCREMENTAL AVAILABILITY (DPIA1)
2	DOCKING PLANNED INCREMENTAL AVAILABILITY (DPIA2)
3	DOCKING PLANNED INCREMENTAL AVAILABILITY (DPIA3)
4	PLANNED INCREMENTAL AVAILABILITY (PIA1)
5	PLANNED INCREMENTAL AVAILABILITY (PIA2)
6	PLANNED INCREMENTAL AVAILABILITY (PIA3)
7	REFUELING COMPLEX OVERHAUL (RCOH)
8	NOT USED

4. Availability Serial Number. The availability serial number is the same three character serial field currently used in Regional Maintenance Automated Information System (RMAIS). This entry is made in the “serial” field of the maintenance data system availability editor window. There are five authorized serial codes used to designate availabilities.

- a. Alongside Availability (XAZ). The XAZ availability is intended to be a planned CM availability, such as a Continuous Maintenance Availability, over a specified period of time determined by the ship’s operational schedule. The TYCOM will schedule the availability during the normal fleet scheduling process. A nominal time frame for availability length is no less than two weeks and no more than six weeks. A ship is not to get underway during any period of the availability. There is no limit to the number of XAZ availabilities that may be scheduled during a year. The first character indicates FY at availability start. The last character indicates a specific XAZ availability during that FY. If the number of availabilities in a single FY results in the Z character being greater than 9, alphabetical characters will then be used beginning with “A”. Sequential serial number assignment is desired, but the occasion may arise when a significant schedule change allows for a new availability to be scheduled prior to an existing availability. In this unique case availability may be created using an out of sequence serial number. This eliminates the need to move jobs that are already screened in RMAIS and Navy Maintenance Database and additional maintenance data systems. Availabilities may be scheduled in RMAIS for future years using notional time frames and the exact dates can be adjusted later once a more precise schedule is promulgated. All executing activities may be scheduled to work during this availability. If a job scheduled for completion is not started then it must be moved into another availability and the availability closed on the scheduled completion date. The fact that the job was not completed will be reported in the availability completion report.
- b. CNO Scheduled Availability (XCZ). The XCZ availability is the scheduled CNO availability promulgated in the OPNAV 4700 Notice. These availabilities are normally conducted in a shipyard under the direct supervision of the Naval Supervisory Authority. All major modernization programs will be scheduled for CNO availabilities. Other executing activities may conduct work during these availabilities pursuant to the contractual limits imposed by the shipyard and the Naval Supervisory Authority. Notional CNO availabilities may be established for years beyond the scope of the OPNAV Notice to support long-term work item placement. The first character indicates FY at availability start. The last character indicates a specific XCZ availability during that FY. Software programs require that only one contract solicitation may be recorded against a given availability, therefore the situation may arise when two availabilities must be simultaneously executed. In this case the same type of availability will be used and the next sequential number assigned.

- c. Year-long Continuous Maintenance Availability (XCM). The XCM availability is a year-long availability for the scheduling and completion of work items that are not accomplished during any other scheduled availability. A job is not to be kept in the XCM availability if it is accomplished in an XCZ or XAZ availability. The first character indicates the FY.
 - d. Year-long Emergent Work Availability (XEM). The XEM availability is for the completion of emergent work items as defined in Volume VI, Chapter 31 of this manual. Jobs screened to an XEM availability are paid for using emergent work funding. Items assigned to this availability will not be moved into any other availability and will remain in the XEM availability. Emergent work will not be conducted in a XCZ availability. Emergent work that is discovered during a CNO availability will be added to the availability and paid for using CM funding, for example, work required to support light off or sea trials. The first character indicates the FY.
 - e. Multi-year Unfunded (UNF) availability. The UNF availability is for those items for which there is no realistic expectation that they will be funded even in the out years but must be maintained for material history purposes. It is also for those jobs with a Maintenance Figure of Merit such that there is a low probability of accomplishment, but the job remains valid. These jobs will be screened to the UNF availability but will not be authorized in RMAIS.
5. Availability Category Code (Aircraft Carriers). The codes in this section are authorized for use on all Aircraft Carrier availabilities at Norfolk Naval Shipyard.

CODE	AVAILABILITY ID	EXAMPLE
A	XRZ	9R1 - JCNs ASSIGNED TO NNSY (RRC) FOR ACCOMPLISHMENT BY FMS SHOP "RUN CONCURRENT WITH CNO AVAILABILITY".
A	XSZ	9S1 - JCNs ASSIGNED TO NNSY (OLD SIMA SHOP) FOR ACCOMPLISHMENT BY FMR SURFACE SHOP TO "RUN CONCURRENT WITH CNO AVAILABILITY".
P	NXX	N09 - ORIGINATING WORK CENTER FOR 2009 CHANGES YEARLY CALENDAR.
P	990	990 - JCN REQUIRES SCD TO BE SUBMITTED. STATIC AVAILABILITY CODE.
P	991	991 - SCD WRITTEN/SUBMITTED AWAITING APPROVAL. STATIC AVAILABILITY CODE.
P	992	992 - TYCOM HOLD FOR REVIEW/INVESTIGATION. STATIC AVAILABILITY CODE.
P	REJ	REJ - REJECTED BACK TO SHIP FOR SF ACTION. ACCOMPANIED WITH TYCOM REMARKS. STATIC AVAILABILITY CODE.

CODE	AVAILABILITY ID	EXAMPLE
P	N43	N43 - SHIP ASSIGNED (SMM OFFICE) TA1, 2, 3. TA4 REQUESTING ACCOMPLISHMENT DURING CNO AVAILABILITY. STATIC AVAILABILITY CODE.
P	BDF	BDF - DEFERRED BASELINE JCN FOR REASSIGNMENT AT A LATER DATE. STATIC AVAILABILITY CODE.
P	XSM	9SM - JCN ASSIGNED TO NNSY (OLD SIMA SHOP) FOR ACCOMPLISHMENT "OUTSIDE CNO AVAILABILITY". CONTINUOUS MAINTENANCE RUNS FISCAL YEAR. FUNCTIONS THE SAME AS THE 9CM/0CM BUT ONLY PROCESSES TA2 FOR NNSY. ASSIGNED TO FMR SURFACE SHOP.
P	XRМ	9RM - JCN ASSIGNED TO NNSY (OLD RRC) FOR ACCOMPLISHMENT "OUTSIDE CNO AVAILABILITY". CONTINUOUS MAINTENANCE RUNS FISCAL YEAR. FUNCTIONS THE SAME AS THE 9CM/0CM BUT ONLY PROCESSES TA2 FOR NNSY. ASSIGNED TO FMS.
P	CIS	Commercial Industrial Services approved by TYCOM
P	DIQ	Commercial Preservation Work approved by TYCOM - Indefinite Delivery, Indefinite Quantity
P	MAC	Commercial Deck Work approved by TYCOM - Multiply Award Contract
S	SXX	S09 - SHIP SELF AVAILABILITY 2009 CHANGES YEARLY CALENDAR.
U	UNF	UNF - UNFUNDED. STATIC AVAILABILITY CODE.

X, XX = YEAR Z = SEQUENTIAL NUMBER

6. Funding Activity Code. The FAC is a two-digit exportable field in RMAIS. A FAC must be entered for every non-TYCOM funded 2-Kilo prior to being screened and brokered. Any member of the maintenance team authorized to screen work may enter a FAC. The FAC table is NAVSEA controlled. The approved FACs are:

<u>CODE</u>	<u>TITLE</u>
AA	TYCOM CM NON-NUCLEAR
AB	TYCOM EM NON-NUCLEAR
AC	TYCOM DIVING SERVICES
AD	TYCOM FLEET ALTERATION (NON NUCLEAR)

AE	TYCOM FUNDED SEMAT (ETC) SHIP'S FORCE ASSISTANCE
AF	TYCOM NUCLEAR MAINTENANCE/REPAIRS
AG	TYCOM NUCLEAR ALTERATION
AH	TYCOM FUNDED CNO SCHEDULED AVAILABILITY MAINTENANCE
BA	NAVSEA NUCLEAR ALTERATION
BB	NAVSEA ORDNANCE ALTERATION (ORDALTS)
BC	NAVSEA NON-NUCLEAR PROGRAM ALTERATION
BD	NAVSEA - UNIQUE - NON-NUCLEAR (INCLUDES ALTERATION DEVELOPMENT, TECHNICAL SUPPORT)
BE	NAVSEA - UNIQUE - NUCLEAR AND/OR REFUELING
BF	NAVAL SHIPYARD MISSION FUNDED
BG	SRF MISSION FUNDED
CA	IMA FUNDED MAINTENANCE
CB	IMA FUNDED FLEET ALTERATION
DA	ADMINISTRATIVE SUPPORT NON-NUCLEAR (PRORATABLE) INCLUDING DSA FUNDED
DB	ADMINISTRATIVE SUPPORT SERVICES NUCLEAR (PRORATABLE)
EA	SHIP'S FORCE MAINTENANCE/REPAIRS
EB	SHIP'S FORCE - SELF HELP HABITABILITY
FA	TECHNICAL SUPPORT: SPAWAR SSC, RMC (MISSION FUNDED)
FB	TECHNICAL SUPPORT: SPAWAR (SEPARATE FUNDING ONLY)
GA	VRT-N, VRT-M, ALRE
HA	NAVAIR (CAFSU, NAWC, FAA, ASIR)
HB	NAEC LAKEHURST NJ
HC	NAWC CHINA LAKE
HD	NAWC PT MUGU
HE	NAWC PAX RIVER
HF	NAWCAD ST INIGOES MD
IA	NSWCCD/DAVID TAYLOR
IB	NSWCCD/SSES
IC	NSWCCD/PHD
ID	NSWC CRANE
IE	NSWC PANAMA CITY
IF	NSWC NEWPORT
IG	NSWC KEYPORT
IH	NSWC LOUISVILLE
JA	SPAWAR (ALTERATION INSTALLATION TEAM)
KA	ESU

- OO OTHER - EXPLAIN IN REMARKS
- VV VISITING SHIP SUPPORT (FOREIGN NAVY)

7. Example Cases: The FAC is designed to be applied from a user perspective. For example, if Naval Surface Warfare Center, Carderock Division (NSWCCD)/Ship System Engineering Station (SSES) plans to use an Alteration Installation Team to install an alteration and they are funded for the install, then the maintenance team would select the FAC for NSWCCD/SSES. The maintenance team is not expected to know if it was OPNAV or the TYCOM that funded SSES, this is beyond their level of knowledge and those agencies are expected to track their own funds. In this case a FAC of “IB” would be applied. The following table provides examples of how the various codes can be applied to common availabilities:

Availability Category	Availability Serial	Fund Activity Code
A, K, X, Z	XAZ	AA, AC, AD, AE, BB, BC, FA, FB, VV, OO (Note: 1)
B, C, H, J, K, L, M, N, R, T, W	XCZ	AA, AC, AD, AE, AH, BB, BC, BF, DA, FA, FB, OO (Note: 2)
P	XCM	AA, AC, AD, FA, FB, OO (Note: 3)
P	XEM	AB, BF, BG, VV, OO (Note: 4)
U	UNF	NONE

NOTES

- Note 1:** The primary fund activity code is AA for the alongside availability as most work is TYCOM funded maintenance. Commander, Naval Surface Force Atlantic ships should not use codes CA or CB unless the IMA becomes a fleet funded activity as it is in the Pacific region. Pacific Fleet ships would use CA for IMA work performed during this availability. The voyage repair Availability Category should be used for scheduled voyage repairs using either the AA or AB activity code as appropriate, the XEM availability should not be used for voyage repairs.
- Note 2:** The primary fund activity code is AH and a common additional code is BC. In Atlantic Fleet any IMA work would use the AA code, Pacific Fleet ships would use CA for IMA work performed during this availability.
- Note 3:** Primary FAC is AA for TYCOM funded maintenance.
- Note 4:** Primary FAC is AB indicating ERATA expenditure. In some cases BF or BG may be used as dictated by each region.

Examples:

- a. A ship entering a scheduled CNO docking availability in FY07 will have an availability number consisting of a “B” for the Availability Category Code and the serial will use the XCZ format. The full availability number will be B7C1 as this will be the first CNO availability for this ship in FY07. The “B” is entered in its own field in RMAIS as described above using the availability drop down menu. The three digit serial is manually entered in the “serial” data field of the RMAIS window.

- b. A ship entering an alongside three-week CM availability will use “A” as the Availability Category and the XAZ format for the serial. So the third alongside CM availability for FY06 will be an A6A3 availability. Again the first digit and the last three digits are entered in separate RMAIS entry fields. The FAC is applied on a job-by-job basis and is not tied to the availability number. In a single availability you can have several executing activities and multiple FACs across all the jobs screened to the availability. For example, Job EA04-1111 might be a pump repair screened to Supervisor of Shipbuilding and paid out of TYCOM CM funds so that job will have “AA” FAC assigned when it is screened to the A6A3 availability.

(This Page Intentionally Left Blank)

VOLUME II**PART II****CHAPTER 2****SURFACE SHIP AND AIRCRAFT CARRIER WORK PACKAGE PREPARATION**REFERENCES.

- (a) NAVSEAINST 4710.8 - Cost and Performance Reporting for CNO Scheduled Ship Maintenance Availabilities
- (b) NAVSEA S0300-B2-MAN-010 - Supervisor of Shipbuilding Conversion and Repair Operations Manual

LISTING OF APPENDICES.

- A Prorate Items with Explanations
- B Master Specification Catalog Maintenance Office Guidelines
- C Surface Ship Prorate Process
- D Surface Ship Availability Milestones
- E Aircraft Carrier Navy Modernization Process Milestones
- F Planning Priority Matrix
- G Depot Planning Priority Schedule (PSIA)
- H₁ Process Flowchart Firm Fixed Price CNO Availability
- H₂ Process Flowchart Firm Fixed Price CMAV or Emergency Availability
- H₃ Process Flowchart Firm Fixed Price PSIA CNO Availability
- H₄ Process Flowchart Firm Fixed Price PSIA CMAV Availability

2.1 PURPOSE. To establish ship maintenance work items and specification package preparation procedures, milestones and business rules. These rules apply to Regional Maintenance Centers (RMC), Commander, Naval Surface Force Pacific; Commander, Naval Surface Force Atlantic; Commander, Naval Air Forces Atlantic; Commander, Naval Air Forces Pacific; Systems Commanders (sponsoring Program Alterations) and other Alteration Installation Team (AIT) Sponsors. This chapter is not applicable to submarine availabilities.

2.1.1 Prorated Business Rules. This chapter also provides prorate business rules including:

- a. Defining common prorates, those prorates to be assigned to specific alterations, and those Type Commander (TYCOM) operational prorates (Appendix A).
- b. Providing a simple consistent method to divide those prorates between Program Alterations, Fleet Alterations, maintenance and repair items.
- c. Providing a coast specific "Prorate Factor" used in planning as part of the Cost Benefit Analysis of the Ship Change (SC) Document to estimate installation cost of the alteration. Paragraph 2.4.6.2 of this chapter lists the Prorate Factors.

2.1.2 Responsibilities.

- a. The Life Cycle Manager/Ship Program Manager (SPM) is responsible for the planning, budgeting and execution of the approved Program Ship Modernization.
- b. The TYCOM is responsible for the planning, budgeting and execution of the approved Fleet Ship Modernization, ship repair and ship maintenance.
- c. The Ashore Ship's Maintenance Manager is responsible for the execution of each ship's Maintenance and Modernization Business Plan (MMBP) and the division of the prorate percentages between Fleet and Program based on the business rules herein.

2.2 SCOPE. The goal of the effort is to deliver effective maintenance and modernization while capturing efficiencies. The cost avoidance can then be put to use in accomplishing additional maintenance. This chapter introduces work package preparation improvements that leverage existing planning information and process

capabilities to make final work package content decisions closer to the time work is actually scheduled to begin. This will significantly reduce the churn in the work package content and support timely delivery of all work desired for the Chief of Naval Operations (CNO) availability. This includes the depot level repair and modernization package, Ship's Force, Intermediate Maintenance Activity and AIT modernization work. Effective financial management of ship maintenance and modernization depends upon use of return cost data in planning for future installations. Upon completion of each availability, the participants must use the availability completion report return cost data to update Navy Data Environment modernization cost estimates and the next fiscal year business plan. Return costs for repair work will also be used to populate and validate costs estimates that are resident in the Master Specification catalog. A disciplined prorated distribution process, coupled with updates to the Navy Data Environment database and the business plan will help modernization financial planning and reduce cost surprises both before and during availability execution.

2.3 EXECUTING ACTIVITY PLANNING. Work Package Preparation process improvements include long-term contractual relationships and Private Sector Industrial Activity (PSIA) contracts, with our executing activities and private ship repair yards. The Executing Activity (EA) is the public or private enterprise that is assigned or awarded the responsibility for accomplishing the actual production work to effect modernization and repairs to surface force ships/aircraft carriers. For the most part, the EAs will perform the planning for accomplishment of the work that they will execute. All work, whether CNO availability, continuous maintenance or emergent work will have a Ship Specification Package (SSP) prepared in the appropriate maintenance database work planning and execution tool. The exception to EA planning is first of ship class ship alteration advance planning (drawing preparation and material ordering). This will be performed by the assigned planning yard. The EA will plan subsequent ship alteration installations provided they are not of such a complex nature that it is determined that these should be assigned to the planning yard. In most cases, as part of the planning effort, the EA will prepare the actual work specification (accomplished today in the Navy Maintenance Database (NMD) for depot level or in another maintenance Automated Information System for I-Level). The exceptions to the EA work item preparation is that the government may elect to accomplish work item development to provide an avenue to train government personnel in the critical skill sets used during the work item development process and/or to provide surge capabilities for the EA during peak work loading.

2.4 MASTER SPECIFICATION CATALOG.

2.4.1 Work Package Preparation. The Work Package Preparation process will leverage the large library of planning documents that exist today and are currently stored in Master Specification Catalogs (MSC). The MSCs provide a ready resource of technically correct and current work items that are universally accessible for use. The vast majority of these documents can be reused for planning future repair actions. The primary purpose of the MSC is to reduce maintenance costs by:

- a. Reducing planning efforts.
- b. Identifying and promoting best practices.
- c. Effectively managing lessons learned.
- d. Minimizing delays associated with maintenance planning.
- e. Providing a cost estimate for the work item.

2.4.2 Use of the Master Specification Catalog. Use of the MSC by Maintenance Teams and Planners at maintenance activities is mandatory. Processes are established to allow all users to recommend content and provide feedback regarding the quality of specifications and templates. The Depot level MSC can be accessed through the NMD application. The Depot level catalog consists of master specifications, specifications used directly without any modification, and templates that can be used with minor modifications. NMD has been modified to capture the contractors' planning estimates and actual return costs. This allows standard costs to be developed for the specifications residing in MSC. The D-Level MSC is maintained by the Master Specification Catalog Maintenance Office (MSCMO) at Surface Maintenance Engineering Planning Program (SURFMEPP), who is assigned to standardize all templates to the maximum extent possible to ensure the specifications that reside there are technically correct and reflect the most current guidance. Appendix B provides the general guidelines for template preparation, processing and maintenance. The MSCMO will incorporate the directives of Naval Sea Systems Command (NAVSEA) Standard Specification for Ship Repair and Alteration Committee, and Volume VII, Chapter 4,

Appendix 4-E of this manual. Under certain circumstances, these guidelines may expand upon or differ from Volume VII, Chapter 4, Appendix 4-E of this manual. The intent is to standardize templates for all ship classes at each geographic location. The MSCMO relies on the expertise of the author for technical content of templates, although when processing a template, the MSCMO will question areas of omission and scrutinize non-conformance to Volume VII, Chapter 4, Appendix 4-E of this manual. SURFMEPP also acts as the clearinghouse for the nomination/acceptance of additional specifications to the MSC.

2.4.3 Central Planning Activities. Central management is used to ensure quality and consistency of the catalog content and a Central Planning Activity is assigned for each branch to carry out central management responsibilities. For the NMD branch, the Central Planning Activity is the MSC Maintenance Office and is functionally part of SURFMEPP. For the I Level Planning, the Central Planning Activity is the Southwest Regional Maintenance Center. The Central Planning Activity responsibilities include:

- a. Ensuring MSC content adheres to a standard format.
- b. Enforcing technical authority compliance for MSC content.
- c. Ensuring reference lists cited by MSC content are current.
- d. Ensuring that documents stored in the MSC are current and technically correct.
- e. Managing the review process for proposed MSC documents.
- f. Managing the MSC document change process.
- g. Addition of new content to the MSC.
- h. Deletion of content from the MSC.
- i. Analysis of feedback and metrics; monitor and maintain MSC content quality.
- j. Monitoring MSC business rule compliance.
- k. Providing decision quality data to oversight commands and committees.
- l. Provide first level support for questions related to MSC use and/or content.
- m. Screening requests for access to the MSC prior to submittal to the catalog user and Information Technology management offices.

Each Central Planning Activity has established detailed processes to accomplish the above responsibilities. These processes are contained in Central Planning Activity process/instruction manuals.

2.4.4 General Process. The general process for using the MSC is common to both systems and is discussed in the following paragraphs.

- a. The ship identifies a problem and requests a maintenance action via the Office of the Chief of Naval Operations 2-Kilo Maintenance and Material Management Maintenance Action Form (OPNAV 4790/2K) using the ship's Maintenance Data System.
- b. The request is transferred to the fleet brokering system - Regional Maintenance Automated Information System.
- c. The Maintenance Team screens the request, determines maintenance level, and enters the appropriate branch of the MSC to determine if there is a work item that accomplishes the scope of work required by the work request.
- d. If there is a work item, the OPNAV 4790/2K is annotated with the work item identification information prior to brokering the OPNAV 4790/2K.
- e. The OPNAV 4790/2K is brokered to a maintenance activity.
- f. The maintenance activity receives the work request and checks for MSC information. If there is MSC information that identifies a master specification, or if the maintenance activity identifies an appropriate master specification, the maintenance activity uses the specified pre-planned MSC specification and adds the new specification to the work package without additional planning review.

- g. If there is MSC information that identifies a template, or if the maintenance activity identifies an appropriate template, the maintenance activity uses the specified pre-planned MSC template, makes the required changes, performs the normal planning reviews, and then adds the resulting work item to the work package.
- h. If there is no catalog identification information, the maintenance activity verifies that there is no appropriate master or template. After verification, the activity plans the work using the established planning and planning review processes. The maintenance activity also forwards the new work item to the MSC Maintenance Office and local standards personnel as a proposed template.
- i. The work in the work package is released at the appropriate time and sent through established work integration and/or contracting processes.

While details and terminology will vary from system to system, the basic workflow and responsibilities are common to both systems.

2.4.5 Common Business Rules. There are seven business rules that are common to both branches of the MSC. These business rules form the fundamental base for the catalog. Consequently, Central Planning Activity processes, as well as programming of the MSC software systems, are designed to support these business rules. Additionally, enforcement of the rules is required to attain MSC goals. Metrics and review processes have been established to support compliance monitoring and reporting. The following business rules apply to both branches of the MSC.

NOTE: NAVSEA “STANDARD ITEMS” ARE NON-DEVIATIONAL.

NOTE: CONTRACTS DICTATE THAT “TEMPLATES” MAY BE CHANGED OR MODIFIED. CHANGES SHALL BE FED BACK TO THE MSCMO AS APPROPRIATE.

- a. NAVSEA Standard Items shall be used whenever they fulfill the requirements of a specific maintenance task.
- b. Standard Items and templates shall be the preferred method of planning for both public and private Lead Maintenance Activities (LMA).
- c. NAVSEA Standard Items will be used without change.
- d. NAVSEA Standard Items and templates shall be centrally filed and maintained by a Central Planning Activity. Only the Central Planning Activity will be allowed to store, delete or change the status of a NAVSEA Standard Item or template stored in the central library.
- e. MSC task lists will adhere to a specific format. The format is defined in:
 - (1) Volume VII, Chapter 4, Appendix 4-E of this manual maintained on the Standard Specification for Ship Repair and Alteration Committee (SSRAC) web site.
 - (2) Enclosure (1) of the I-Level MSC process manual for I-Level specifications and templates.
- f. NAVSEA Standard Items are reviewed prior to approval for use. No additional planning review is required prior to use of a Standard Item to accomplish a maintenance task.
- g. Although NAVSEA Standard Items do not require planning review, they are subject to established release, scheduling and integration planning processes.

2.4.6 Prorate Information.

2.4.6.1 Prorate Distribution Process. The prorate distribution process map (Appendix C) summarizes the steps in arriving at an equitable distribution of prorate costs. The prorate distribution process follows the milestones below:

- a. April prior to execution fiscal year:
 - (1) RMC/TYCOM/Program Executive Officer (PEO) SHIPS issues the Maintenance and Modernization Business Plan Guidance. This is the baseline for prorate distribution.
 - (2) The TYCOM input to the MMBP will provide total dollars budgeted for the Fleet Modernization, Maintenance and Repair scheduled for each availability.

- (3) The Program Modernization input to the MMBP is the Extended Planning Hull Maintenance Plan which provides man-days and material costs for each scheduled SC. The RMC multiplies the current port man-day rate by the total number of program man-days, by appropriation, and adds locally procured material costs to provide total “installation dollars” for Program Modernization.

NOTE: THE TOTAL DOLLARS USED TO DETERMINE THE PRORATE PERCENTAGES DO NOT INCLUDE SERVICES, GROWTH OR AWARD FEES.

- (4) The proportion of TYCOM dollars and Program dollars relative to the total dollars will provide the percentage of prorate costs assigned to TYCOM and Program respectively.
- b. In accordance with Maintenance and Modernization Process milestones as shown in Appendices D and E:
 - (1) TYCOM/PEO SHIPS issues the Letters of Authorization for all modernization.
 - (2) The work package that began definition at the Integrated Planning Conference is further refined with a 50% lock on repair items. The Project Manager provides a list of expected prorated items, with work item numbers assigned, using Appendix A for guidance, for all Program and Fleet Letter of Authorization authorized modernization and TYCOM repair items.
 - (3) All SCs listed in the Letter of Authorization, except ST1 and ST2 SCs, are mature, impact approved or are removed from the Letter of Authorization (except for ST1 and ST2 SCs, Programmed but not Authorized SCs will be removed at this time). This locks the prorate distribution percentages. This milestone obligates the cost of prorates based on the locked Letters of Authorization and MMBP budget of the repair and maintenance package.
 - (4) If one of the participants elects to remove maintenance, repair or modernization work from the availability work package after 80% lock, that participant is still responsible for payment of the actual prorate costs incurred, as of the date of the withdrawal, on execution planning for the removed work. In the event a Program SC owner declines to comply with paying the prorate charges, payment of the delinquent charges will be a prerequisite for adding the SC to the Letter of Authorization for the next availability for which the SC is programmed.
 - (5) If new modernization work is added after 80% lock, the activity requesting the SC will incur all additional prorate costs generated as a result of the additional work.
 - (6) A 100% lock is placed on all repair items. Funding is requested from the participating activities. The Naval Supervisory Authority (NSA) must receive funding to support definitization.
 - (7) The modernization, maintenance and repair package is definitized.
- c. If the availability is extended, the additional prorate requirements are paid for by the party(ies) causing the extension.
- d. Once the originally planned growth pool is expended, large increases due to growth (exceeding 2% of the total work package costs) will result in reallocation of prorates.

2.4.6.2 Prorate Factors. The prorate factor is used in the budget process for modernization, repair and maintenance, in order to ensure adequate funding for planned work. The following prorate factors are to be applied to total estimated ship repair cost to forecast the portion of total cost for “Prorate” effort. These factors are based on data from selected Departure Reports for ship repairs completed in 2003 through 2005 and are subject to periodic updates.

	Prorate Factor		
	<u>East coast</u>	<u>West coast</u>	<u>Navy-Wide Average</u>
All Prorate work	33%	33%	33%

2.5 MILESTONES. Package preparation milestones have been developed that support the continuous maintenance philosophy. These milestones are designed to allow a more continuous flow of work to create a work package. The milestones now require that only 50% of the work, measured by 50% of the budgeted funds for repair work during the availability being committed, be “locked” at the 50% lock in accordance with the appropriate milestones in Appendix D of this chapter for Surface Force Ships and Appendix E of this chapter for Aircraft Carriers. It is expected that this work will be repair and major industrial work that is generally known well before the 50% lock. Every effort should be made to include unscheduled and unaccomplished mandatory Class Maintenance Plan work items in the ship’s Baseline Availability Work Package (BAWP) in the work package. Once work is placed in the package, and funding for that work is committed, the EA is authorized to plan that work, order material and expend other funds as necessary to execute the work. It should be the rare exception that work is ever removed from a work package. TYCOM will obtain technical adjudication for any BAWP items prior to the removal of any BAWP item from the work package. It is extremely important that the right work at the right time is placed in the work package. Operational commitments, port loading or other reasons may require modification to availability schedules and milestones may need to be adjusted accordingly.

- a. (Surface Force Ships Only) Availabilities that are in the A-720 to A-360 window when rescheduled should not impact the Maintenance and Project Teams ability to meet milestones that begin inside of the A-360 date.
- b. Availabilities that are within the A-360 window may miss milestones due to the compressed timeline, however, every effort should be made to accommodate those milestones lost to compression. There should be no attempt to compress milestones of an availability that is already inside of the A-90 date. The TYCOM, NSA, affected Program Office and LMA will agree on the compressed milestone timeline and enter a Memorandum of Agreement (MOA) for the record dictating the agreement. Items to consider are as follows:
 - (1) The Contracting officer should be notified immediately.
 - (2) Each compression timeline will be different; therefore, adjustment of those milestones lost should be addressed and adjudicated by TYCOM, NSA, affected Program Office and LMA.
 - (3) Where availability compression causes a loss of either the 50% or 80% lock milestone, the 100% lock date should be adjusted in order to accommodate an excess of scope, plan and estimate requirements which should aide in completion of Final Technical Analysis Report (TAR) and definitization on their regularly scheduled dates.
 - (4) TYCOM, NSA, LMA sign MOA identifying the adjusted milestones.
 - (5) Where applicable, the appropriate package lock date should be met as soon as practical (if lost in the compression) following the change of availability dates. The Class Maintenance Plan (CMP) BAWP should be used to accommodate this event. Repair items on the Current Ship’s Maintenance Project (CSMP) will also be locked based on the highest readiness return on investment (Use Maintenance Figure of Merit screening values where appropriate). An example of this is: The availability is compressed and the 50% or 80% lock milestones were lost in the compression, they should in turn be met as soon as practical.
 - (6) All work items should be scoped, estimated and TAR submitted where those process milestones are lost in the compression.
 - (7) In all cases, the Final TAR and definitization milestones shall be met.
 - (8) In all cases, an Integrated Project Team Development (IPTD) Integrated Planning Conference (IPC) and Work Package Execution Review (WPER) shall be convened to discuss the integration and execution plans regarding the adjusted work package and accommodate Project Team communications regarding changes.

2.5.1 Committed Work at 80% Lock. The milestones require that 80% of the depot level work package be committed at 80%, and 100% of the Ship’s Force and I-Level work that is planned to be executed during the availability concurrently with the depot level work be identified. This provides a period of time during which this work can be evaluated and placed in the depot level package if necessary. Additionally, all AIT support requirements must be identified no later than the 80% lock date.

2.5.2 Committed Work at 100% Lock. One hundred percent of the depot level package must be identified, with the activity accomplishing the planning to complete planning and estimating in accordance with the appropriate milestones in Appendix D of this chapter for Surface Force Ships and Appendix E of this chapter for Aircraft Carriers. The EA will then have 30 days to produce an integrated work schedule that will be reviewed at a Work Package Execution Review. By delaying the final commitment of the last 20% of the depot level work package until the 100% lock date there should no longer be any reason to front load “insurance” work. The new entitled work package preparation process will better reflect the most current priority of maintenance that needs to be performed on the ship. The milestones described above are designed for use by those ships supported with PSIA contracts. For Surface Force Ships, Appendix D describes milestones to be used with Firm Fixed Price (FFP) contracts. Where PSIA contracts are not in effect and no existing Indefinite Delivery, Indefinite Quantity (IDIQ) contracts cover the work contemplated, work packages for Continuous Maintenance Availabilities (CMAV) must be submitted to meet local contracting milestones.

2.5.2.1 Automated Work Request Screening. By no later than the 100% lock date, the entire depot level package shall have been screened to the appropriate IT System availability by the Ashore Maintenance Manager (PE). The PE shall screen the Automated Work Requests (AWR) based upon the established TYCOM controls and planning budget. The Project Manager will broker the screened work to the planning activity for development of work specifications. No additional AWRs shall be brokered for inclusion into the basic proposal after lock date.

- a. The 100% package lock is the official milestone to mark identification of 100% of the work requirements for an availability based on the MMBP budget. All work added to or deleted from the package after the 100% lock will be via an errata, addendum or inducted as new work via the Request for Contract Change Process.
- b. For certain availabilities, the 100% lock date will need to be adjusted to a date which will support timely definitization. Appendix D reflects the various milestones based upon the package size. This will usually be based upon the total projected budget (all funding sponsors) of the project to be contracted. The RMC and TYCOM shall agree upon the change in planning preparation dates. It is anticipated that any change will be made no later than A-360.
- c. TYCOM Port Engineers shall screen work using AWR estimates against their Available Controls/budget. Available planning budget is defined as the remaining budget after Long Lead Time Material (LLTM), contractor fees, other work and growth pools are subtracted from controls.
- d. The contractor Class C and Independent Government Estimate (IGE) submission at the 50 and 80 percent milestones are required to ensure that calculations of package build are based on an accurate estimated value.
- e. The Project Manager will verify that the planning budget supports the estimated value of the 100% locked work package. If the work package exceeds the planning budget, the Project Manager will notify the funding sponsor(s) of the delta and request additional funds or removal of work from the authorized priority list to get to the budget allocated.
- f. On the lock date, the Project Manager will provide the RMC Administrative Contracting Officer with a complete/consolidated list of all AWRs that make up the 100% D Level work package. The Administrative Contracting Officer will issue the list of AWRs to the PSIA contractor annotating that all AWRs listed constitute the basic work package. The contractor shall ensure that all AWRs listed are incorporated in work items, published and included in the proposal through to award. Currently availabilities are not being definitized on time due to the time it takes from package lock. Furthermore, churn in package content after the 100% lock date causes turmoil in the contractors ability to develop a work package proposal.

2.5.3 Flow Metric. In order to track the progress of creation of the work package, a work package flow metric has been created. This metric will provide the maintenance team a tool to manage their work package preparation progress. It also provides the RMC Commander and the maintenance teams a leading indicator of the manner in which the ship’s Maintenance and Modernization Business Plan is being executed.

2.6 CONTINUOUS MAINTENANCE AVAILABILITIES. CMAVs are intended to provide the maintenance team with the flexibility required to do the right maintenance at the right time for the right price. An additional intent of CMAVs is to provide the agility required to support the fleet response plan.

2.6.1 Continuous Maintenance Availability Types. CMAVs are established as the only type of availability that will be accomplished on Surface Force ships outside of CNO availabilities for non-emergent maintenance. Fleet Maintenance Activity Availabilities, Restricted Availabilities, Technical Availabilities are no longer authorized to describe ship maintenance availabilities. There are two basic types of CMAVs, scheduled (XAZ) and unscheduled (XCM). CMAV schedules will be reviewed at each Planning Board for Maintenance and will be adjusted as ship's operational schedules dictate. Schedule adjustment should be requested by the ship via naval message to the Immediate Superior In Command (ISIC), information to the applicable RMC.

2.6.2 Continuous Maintenance Availability Business Rules. The following CMAV business rules have been established to provide guidance for developing work items associated with scheduled and unscheduled repair and modernization availabilities, managing assigned work brokered to both CNO and CMAV availabilities for FFP and PSIA contracts, and establishing priorities for the executing activity to accomplish planning and execution of Work Candidates into work items. This enables the Vision of Entitlement to be realized. The Vision of Entitlement requires a somewhat continuous flow of the planned work items to allow for a continual estimating, work item review and cost definitization process.

2.6.2.1 Applicability. This process is applicable to all personnel involved with writing work items for repair and modernization contracts using work items developed/maintained in NMD in accordance with this manual, Maintenance and Modernization contracts and NAVSEA Standard Items. The start and stop points of the process are when a Work Candidate is brokered from an appropriate IT system into an availability and the production period of the maintenance availability is completed.

2.6.2.2 Ship Specification Package. The Project Manager, or if required by contract, the contractor's Planning Manager on behalf of the Maintenance Team shall:

- a. Establish a SSP within NMD Planning for scheduled and unscheduled CMAVs ((XAZ), (XCM) and (XEM)) and set up the availability in NMD to receive AWRs from Regional Maintenance Automated Information System (RMAIS) electronically in accordance with this manual.
- b. For each Work Candidate that is brokered to the availability in NMD, ensure that the planning date, the "Deadline Date" and the "Availability Number" (in which an availability period can be entered) listed on the Work Candidate is correct, and also include a preliminary man-hour and material cost estimate. Work must be planned and estimated (man hours and material cost) with LLTM identified prior to being routed into any NMD execution availability. This planning estimate is necessary to more accurately predict, for a CNO availability, what percent of the package (in dollars), has been authorized at the 50%, 80% and 100% milestones, and for a CMAV (XAZ) and (XCM) availability, will allow us to know if we have adequate funding available in the budget. A minimum of **fourteen calendar days** should be allowed for planning unscheduled (XCM) availabilities before routing a job to an NMD execution availability.

2.6.2.3 Planning. With the creation of an SSP in NMD, the actual Planning start and stop dates for the execution of the work within that SSP will be established. The one exception to this will be the year long CMAV, Scheduled/Unscheduled CMAV (XAZ) and (XCM) (XEM) availabilities.

- a. All valid maintenance items will have a specification prepared in the NMD Planning module in accordance with this manual. All new work will also be written in the planning module of NMD.
- b. When a valid maintenance item is ready for brokering, review of the currently scheduled SSP availabilities in NMD Planning will then determine to which SSP the item should be added. All SSPs existing within NMD Planning will have a date established when that package should be "locked" per the advance planning milestones contained in Appendix D of this chapter. No valid work items can be added to an existing SSP if the current date is past the "lock" milestone date without providing a written detailed description of the rationale used to add it in the "Work Item" comments field.
- c. The priorities for the Planning Activity are then established by the next scheduled availability milestone that is coming due in accordance with Appendix F and G. This could be a CNO, the next scheduled CMAV (XAZ) or year long XCM availability. Process flowcharts appear in Appendices H₁ through H₄ of this chapter. The year long XCM SSP availability will be a work load leveling mechanism for the planning activity and the goal would be to have these items brokered, planned, material ordered,

funded, scheduled and ready to start work within 14 calendar days prior to start. The valid maintenance items in the XCM SSP availability will become candidates for scheduled CMAVs and unscheduled XCM execution availabilities (windows of opportunity) that are identified on short notice. These planned work items for PSIA contracts will be routed to NMD execution availabilities that branch off of this year long NMD XCM planning availability. Re-broker those remaining AWRs at the end of the fiscal year, into the next fiscal year long XCM and scheduled CMAV (XAZ) SSP availability. Refer to Appendices H₁ through H₄. Refer to Appendix F to assist in determining priority of planning work.

- d. If the urgency to accomplish any emergency maintenance repairs does not allow for development of a work item prior to the start of work and a work item does not exist in the MSC, then a work item will be prepared after completion of work to document it within NMD. Route these emergent Work Candidates to the applicable SSP planning availability, which can then be forwarded to the NMD execution availabilities where the emergency maintenance work was executed.
- e. The Project Manager will check NMD daily for AWRs received in NMD SSP planning availability, review and validate each AWR to determine scope of work. If the information contained in the AWR is insufficient to write a work item, the Project Manager shall coordinate and manage any required shipchecks.
- f. The RMC will determine who should plan a given availability (other than CNO) based on manpower available either at the PSIA contractor or the Government. (Check Contract Line Item Number verbiage for actual contract requirements.)

2.6.2.4 Planners and Estimators.

2.6.2.4.1 Key Terms. Key Terms as found in Volume VII, Chapter 4, Appendix 4-E of this manual.

- a. Standard Items: Mandatory and non-deviational. There are two types of Standard Items:
 - (1) Standard Items (SI)
 - (2) Local Standard Items (LSI)
- b. Templates: Work Items that can be modified and used for single or multiple ship classes. There are three types of Templates:
 - (1) Standard Work Templates (SWT)
 - (2) Class Standard Work Templates (CSWT)
 - (3) Local Work Templates (LWT)

2.6.2.4.2 Planning/Estimating Process.

- a. Determine if the information contained in the AWR is adequate enough to write a work item. If yes, continue development. If no, check the inadequate box and note reasons for inadequacy, then continue.
- b. Review for MSC Templates as follows:
 - (1) Identify appropriate Ship Work List Item Number that applies for AWR to be planned under.
 - (2) Check/search for an appropriate Master Specification Template such as a Class Standard Work Template, Standard Work Template or Local Work Template that addresses the scope of work identified in AWR.
 - (a) If no applicable template is found, check/search for a previously written work item that is applicable and addresses the scope of work identified in AWR.
 - (b) If no previously written work item is found that is applicable, check/search for a "basic" work item template/format.
- c. Select appropriate Master Specification Template, previously written work item or "basic" work item template/format and initiate planning the work item.
- d. Identify and validate all references, including Liaison Action Requests/Reverse Liaison Action Requests required to complete the work item.

- e. Identify test requirements needed to complete work item. If test procedures are required, obtain from execution site design group, planning yard contractor or In-Service Engineering Activity.
- f. Identify security and certification requirements. Develop technical requirements and Planning Estimate.
- g. Identify repair material required to include long lead-time items and submit to material specialist for procurement.
- h. Determine if there is Hazardous Material involved with the work item.
- i. Review the completed work item for candidacy as a new or revised template for inclusion into the MSC. If a candidate, submit the new or revised template to the local NSA Standards Person for review and subsequent routing to the MSCMO for processing and inclusion into the catalog.
- j. Route completed work item in its preliminary state to the Program Manager queue in NMD to be included in a final review work package compiled in NMD.

2.6.2.5 Maintenance Team Program Manager.

- a. Route review work package of work items to Pre-lim Spec review web site. Web Site Address: <https://www.spear.navy.mil/onlineSpecReview.aspx>.
- b. Review and respond to comments on pre-lim work item review web site.
- c. Route and approve work items to “APPROVED” work item review web site.
- d. Process entire work package and issue.

2.6.2.6 Advanced Planning Manager. The PSIA Contractor will publish the CNO PSIA Package in NMD at A-60 and the CMAV PSIA at A-25. This is an important milestone/metric captured within NMD.

2.6.2.7 Scheduled Availabilities.

- a. Scheduled XAZ availabilities are normally 3 to 6 weeks in duration and are nominally scheduled once per non-deployed quarter during a period when the ship will be in port at least three continuous weeks. The ship, via the ISIC, will schedule XAZ availabilities. RMC requirements will be addressed to the ship via the maintenance team. Adjustments to XAZ availability start dates are inevitable; however, the start dates may not move “forward” if package preparation and work package “lock” milestone dates would be violated by the new start date. In this case, the applicable XAZ CMAV availability must be rescheduled to support the entitled process milestone dates. In general, CMAVs will be scheduled to start on the first weekday after arriving in port and will be scheduled to complete one week prior to the scheduled underway day. The minimum length of a ship’s uninterrupted period will be three weeks if an XAZ availability is to be scheduled, with the XAZ availability preferably being a minimum length of three weeks. Any XAZ availability that is scheduled without adhering to these minimums should be avoided and work required during that timeframe will be conducted as XCM. Ships and ISICs shall ensure that other in port requirements (training, inspections, etc.) are not scheduled concurrent with an XAZ availability if these requirements will impede scheduled production.
- b. CMAVs will not normally start on weekends or holidays when support for tag-outs and availability start up is limited, and will not be the same day the ship arrives in port. As a result of requiring the XAZ availability to complete one week prior to getting underway, a reduction in premiums is expected by eliminating the last minute rush to complete work to support the scheduled underway. Maintenance teams must ensure that work scheduled for an XAZ availability can realistically be accomplished in the production window. When operational schedule changes occur early enough to allow the scheduling of an additional XAZ availability without violating the milestones discussed in paragraph 2.5 of this chapter, a new XAZ availability should be scheduled when possible rather than executing maintenance in the unscheduled XCM availability. Additionally, the length of an existing XAZ availability may be increased to accommodate changes in operational schedules provided none of the scheduling rules are violated.

NOTE: XCM AVAILABILITIES ARE NOT TO BE USED AS HOLDING QUEUES FOR MAINTENANCE ITEMS.

2.6.2.8 Unscheduled Availabilities.

- a. The unscheduled XCM availability is a single yearlong availability, for the period of 01 October through 30 September, scheduled for each ship every fiscal year. This yearlong availability is used to accomplish maintenance when a ship is not in a scheduled XCM availability or CNO availability. Since the XCM CMAV Windows Of Opportunity (WOO) are potentially short notice, a reduced set of D level milestones is established. Read in three columns as follows:

<u>TASK</u>	<u>RESPONSIBLE ACTIVITY</u>	<u>MILESTONE</u>
WORK SPECS DEVELOPED	RMC OR MSR	WOO-14
WORK PACKAGE DEFINITIZED	RMC OR MSR	WOO-7

- b. No length requirement exists for an XCM availability. These are accomplished as WOOs become available. If a work item is determined to require more than one WOO to accomplish in its entirety, then it may be executed during multiple WOOs provided that it can be broken into several shorter period requirements.

2.6.3 Continuous Maintenance Availability Applicability. The CMAV business rules apply to all XAZ availabilities and XCM. Since the potential exists for CMAVs to become increasingly more complex, an NSA will be assigned for every CMAV. The NSA will typically be the applicable RMC, or naval shipyard (if applicable).

2.6.4 Work Included in Continuous Maintenance Availabilities. All levels of work (organizational, intermediate and depot) shall be included in a single CMAV for a specific availability period regardless of the executor (Ship’s Force, RMC production personnel or contractor). The intent is to integrate all types of work into a single production schedule for a specific CMAV. Separate intermediate and depot availabilities will not be established for the same period of time. Dependent upon complexity of the scheduled maintenance and/or modernization and the number of maintenance activities involved, the Ashore Ship’s Maintenance Manager may include a work item for production scheduling and integration in the work package or bid specifications. If this work item is not used, then the Ashore Ship’s Maintenance Manager will perform this function.

2.6.5 Concurrent Continuous Maintenance Availabilities. It is incumbent upon the Ashore Ship’s Maintenance Manager to ensure that two non-emergent availabilities are not in progress at the same time. Additionally, CMAVs are not to be scheduled concurrently with CNO availabilities. As required, XCM work items meeting the requirements of paragraph 2.6.2.8 of this chapter that are being accomplished in WOOs may overlap with XAZ and CNO availabilities.

2.6.6 Ship Movement During a Continuous Maintenance Availability. In order to maintain focus on the maintenance work package and minimize premium costs, no ship shall get underway during a CMAV other than to support the maintenance availability or to complete sea trials. Maintenance that prevents a ship from being ready for sea within 96 hours will normally only be screened to XAZ availabilities. Ships will notify their ISIC of any production item that will prevent the ship from getting underway within 96 hours. If this work is being conducted within a scheduled XAZ availability, a waiver is not required. It is imperative that the ISIC take a proactive role in ensuring that the integrity of the scheduling process be maintained as it relates to CMAVs. CMAVs must be incorporated into the ship’s operational schedule and must remain as a priority for completion.

2.6.7 Continuous Maintenance Availability Metrics. In order for accurate metrics to be obtained, it is imperative that all CMAVs be planned and executed utilizing the appropriate IT systems. The following placement and oversight metrics will be collected to measure the effectiveness of the CMAV process. This is not a complete listing of all CMAV metrics. Volume VI, Chapter 36 of this manual provides additional guidance and discussion on the metrics topic.

- a. Award on time delivery (XAZ only). Scheduled CMAV “on time award” is defined as the percentage of time contract award is made on time or early.
- b. Completion on time delivery (XAZ only). The CMAV completion on time delivery metric calculates the percentage of occasions when a CMAV availability is completed on or before the CMAV end date as recorded in the appropriate maintenance database.

- c. Availability churn (XAZ only). The CMAV availability churn percentage is a monthly capture of the dollar value of work items changed, deleted or added in a CMAV work package from contract award until availability completion versus the dollar value of the work package at award for all CMAV availabilities that ended in the current measurement month and the previous two months. This metric is collected by availability and reported in the month the availability completes.
- d. Growth and New Work Premiums. The Growth and New Work Premiums metric is a measure of late work premiums paid as a percent of growth and new work monthly. It does not include authorized work included at the start of the availability as growth reserves for specific work items or execution of pre-priced option items if executed within the scope and schedule as pre-priced. This metric is collected weekly with each change to the original contract award (FFP) or definitization (PSIA) work package transaction being reported one time in the data call for the week in which it was settled for scheduled CMAVs.

2.6.8 Continuous Maintenance Availability Late Work Premium (XAZ only). The CMAV late work premium metric is a measure of the total dollar value of late work premiums paid for CMAV availabilities completed in the current month divided by the sum of the execution contract award (FFP) or definitization (PSIA) and the settled cost of all Request for Contract Changes for that availability.

2.6.9 Continuous Maintenance Planning. Continuous maintenance is the process of scheduling and accomplishing work outside of CNO availabilities. PSIA contracts create a long-term relationship with the EA that accomplishes the continuous maintenance to maintain the ship at an acceptable readiness level. The Ashore Ship's Maintenance Manager will use every scheduled in-port period as an opportunity to accomplish continuous maintenance. Funding for continuous maintenance is included in the ship's Maintenance and Modernization Business Plan. In order to prevent premiums from being accrued, a minimum of 30 days will be allotted between the time depot level work is brokered to the EA and the time work is scheduled to start. A minimum of 40 days will be allotted for work brokered to I-Level activities. This will provide for adequate time to plan the work and acquire the necessary material in an efficient manner. This will allow a Work Package Execution Review to take place and for all work to be definitized in accordance with the milestones listed in Appendix D of this chapter for Surface Force Ships and Appendix E of this chapter for Aircraft Carriers. If these minimum thresholds cannot be complied with, the work should be postponed until the next continuous maintenance opportunity. The Ashore Ship's Maintenance Manager may run a business case analysis if there are other factors that might justify the addition of work inside these preferred windows.

2.7 ADVANCE PLANNING STATUS MESSAGES. The Advance Planning Status Messages required by reference (a) should continue to be issued by the activity responsible for planning the ship's CNO availability. Messages should commence at the completion of the Integrated Planning Conference. These messages play a vital role in keeping all concerned parties informed of the status of the planning effort. The messages document the successful accomplishment or failure to achieve milestones and produce deliverables. The Work Package Execution Review meeting, held to review the integrated work production schedule that has been prepared by the EA, is the final opportunity to resolve any work interface or production support issues between the different activities before actual production work begins.

2.8 MAINTENANCE TEAMS EXECUTING MAINTENANCE WITH FIRM FIXED PRICE CONTRACTS. PSIA contracts are not in place for all surface force ships in the Navy's inventory. Some classes of ships will not receive PSIA contracts as they will be decommissioning soon, others have such a small number in their class that it is not worthwhile to do this. A modified planning milestone table for FFP contracts is included in Appendix D.

APPENDIX A

PRORATE ITEMS WITH EXPLANATIONS

- A. The following items may be shared by all parties participating in the availability. The share will be based upon installation manhours. The manhours will be the sum of Prime (PSIA), Prime Subcontractor and AIT manhours for each maintenance or modernization work item. These are then subtotaled to arrive at the equitable distribution weight for each participating organization. If the total manhours for an AIT work item is less than 2% of the total work package, then the AIT will not be assigned a share of the prorates. Each prorated item below is followed by a brief description.
1. Production Planning (813-10-XXX): The PSIA contractors are required to develop and maintain an integrated production plan for the availability. The plan integrates all repair and modernization work, including AIT work items. All parties gain benefit from the plan which assists in manhour and material planning for the PSIA contractor as well as the repair and Participating Acquisition Resource Managers (PARM). AITs will not be included in the share of prorates for this item.
 2. Temporary Services (863-50-XXX): These include ventilation air, compressed air, fire main, cooling water, potable water, shore power, sewer connections and welding leads as examples. These items benefit all and are appropriate for equitable sharing.
 3. Housekeeping (864-90-XXX): Housekeeping includes trash disposal, deck coverings, post workday tidying and final cleaning during the compartment closeout process. Every participant benefits from this service.
 4. Integrated Test Plan (894-90-XXX): The Integrated Test Plan is closely associated with the Production Plan. The Integrated Test Plan benefits every participating repair and modernization manager by showing when they can expect various equipment and services to be ready for use and when their own equipment must be ready for testing. Examples include ship's power which must be available to complete combat systems testing.
 5. Program Management (897-00-XXX): Every PSIA contractor has a small staff which manages the overall availability. These include the availability manager and principle assistants. Every participant benefits from this team.
- B. The costs of the following will be charged to the individual work items.
1. Provisioning Technical Documentation (PTD) (830-21-XXX): PTD is the source document notifying the Supply System that new equipment is being installed on the ship. PTD typically arises from a modernization installation or in repair cases where original equipment is beyond repair, or repair parts are not available, and a substitute must be installed. In all cases the PTD is generated for an individual work item and will be charged accordingly.
 2. Waterfront Liaison Engineering Services (838-10-XXX): Waterfront Liaison Engineering Services are typically required when the Ship Installation Drawings (SID) for a modernization installation have an error or there are interferences not accounted for in the SIDs. It is also possible to need Waterfront Liaison Engineering Services if there are deteriorated structural members/sections which must be analyzed to see if replacement is mandatory or advisable. In all cases the work is tied to an individual work item.
 3. Test Memorandum Development (841-10-XXX): This item is for individual work item testing as compared to the total ship Integrated Test Plan which is shared by all. The individual Test Memoranda are charged to the respective work items.
 4. Technical Support (861-00-XXX): This is technical support such as Original Equipment Manufacturer on-site assistance provided for individual work items. In all cases the support is charged to the individual work item.
 5. Condition Report Estimating (862-30-XXX): Condition reports are typically required for "open and inspect" repair items and for emergent requirements during a modernization installation. In all cases the cost will be assigned to the individual work item.

6. Dry docking (863-40-XXX): Dry docking may be required for maintenance of the hull or underwater appendages or there may be needs for access cuts low on the hull to install modernization items. Unlike most of the items in this section, the costs will typically not be charged to a single work item. It is much more likely that the costs will be distributed between parties that require use of the dock. The equitable distribution weight factor will be manhours.
 7. Hazardous Waste Disposal (863-50-XXX): This item is tied to specific work items. Examples include asbestos from propulsion space piping replacements. Lead abatement when sand or water blasting or doing preparations for welding. In all these cases charging the cost to an individual work item is appropriate.
 8. Temporary Access Cuts (863-60-XXX): In many cases the cuts are for general access to reduce time to get both people and equipment in and out of high intensity work areas such as main machinery spaces. These cases will probably be charged to the TYCOM. In other cases, cuts must be made for a specific repair or modernization work item and they will be charged accordingly.
 9. Gas Free and Maintenance of Gas Free (864-42-XXX): The requirement to gain access to a tank or void is usually job specific and will be charged to the individual work item. Exceptions will be evaluated on a case-by-case basis.
 10. Crane Services (865-20-XXX): The crane services requirement will be estimated and assigned to individual work items that require the service.
 11. Rigging Services (865-30-XXX): This is for rigging for the cranes and is assigned to individual work items.
 12. Material Handling (865-20-XXX): This charge is for the “yellow gear” forklifts that support material handling on the pier, dock or main deck of the ship. The cost is assigned to individual work items that require the service.
 13. Fire Watch Services (865-70-XXX): The fire watch personnel are estimated and assigned to individual work items.
 14. Quality Assurance Support (866-20-XXX): In keeping with ISO 9000, each PSIA contractor maintains its own Quality Assurance. The cost of Quality Assurance will be assigned to individual work items.
 15. Production Supervision (897-00-XXX): Every PSIA contractor has a small staff which manages the accomplishment of repairs and the installation of the alterations. The costs will be assigned to the appropriate work items.
- C. The TYCOM will pay for the following items:
1. Armed Security Guards and Waterway Security Barrier (042-27-XXX): The security guards and the water barrier are designed to stop terrorist attacks similar to the events at the Marine Barracks in Beirut and the small craft attack upon USS Cole. The security guards are supported by land obstacles which are designed to stop unauthorized boats from approaching the ship.
 2. Compartment Closeout Schedule (813-00-XXX): The Compartment Closeout Schedule is developed in conjunction with the Production Plan. The Compartment Closeout Schedule shows when each of the ship compartments will be completed in every respect. This includes all work as well as painting, labeling and final cleaning. The closeouts are usually done by a team of PSIA and Navy (civilian and/or military) personnel who sign the closeout form.
 3. Weight and Moment Change Data (843-10-XXX): Every significant availability requires compilation of weight and moment changes to ensure long term damaged stability of the ship is maintained. Though many repair items, and some modernization alterations, have negligible impact upon weight and moment, it is impractical to try to fractionalize the weight and moment costs to individual jobs.
 4. Ship’s Force Parking (863-70-XXX): This is a TYCOM item.
 5. RMC Office Space (863-70-XXX): When the TYCOMs assumed responsibility for the repair RMCs, the cost of personnel and spaces became a TYCOM responsibility.

6. Cleaning and Pumping Bilges and Maintenance of the Oil Boom (864-42-XXX): This is a ship housekeeping item that is properly charged to the ship/TYCOM.
7. Light Off Assessment (868-30-XXX): This is a TYCOM item.
8. Dock Trial/Fast Cruise (868-40-XXX) and Sea Trials (868-50-XXX): This is a TYCOM item.
9. Work Authorization Forms (897-00-XXX): The Work Authorization Form formally documents the work scope to be performed, establishes a schedule, provides a cost estimate, identifies a responsible person for accomplishing the work, and provides time phased cost and manpower profiles.
10. Temporary Staging for Ship's Force Use (991-12-XXX): This is a TYCOM item.

(This Page Intentionally Left Blank)

APPENDIX B**MASTER SPECIFICATION CATALOG MAINTENANCE OFFICE GUIDELINES**

1. Scope. This procedure is applicable to all personnel involved in processing and submitting new proposed templates, including updated proposals of existing templates, in the Navy Maintenance Database (NMD) for processing by the MSCMO.

2. Procedure.

2.1 Template.

- a. Select template candidate.
- b. Check for an existing template in the following order:
 - (1) Class Standard Work Template.
 - (2) Standard Work Template.
 - (3) Local Work Template.
 - (4) Past Availability.
- c. Initiator of the proposed new template candidate must first review existing templates within the MSC to ensure a duplicate is not being created. If there is no duplicate, initiator can proceed with proposal.
- d. Ensure item number conforms to Volume VII, Chapter 4, Appendix 4-E of this manual (e.g., correct Expanded Ship Work Breakdown Structure and contains 8 digits). If non-conforming, correct proposed template.
- e. Template Paragraph 1 “Scope”, ensure the following:
 - (1) Paragraph 1.1 Title: Conforms to Volume VII, Chapter 4, Appendix 4-E of this manual B.2.a.
 - (2) Paragraph 1.2 Location of Work: Conforms to Volume VII, Chapter 4, Appendix 4-E of this manual B.2.b.
 - (3) Paragraph 1.3 Identification: Conforms to Volume VII, Chapter 4, Appendix 4-E of this manual B.2.c.
 - (4) Paragraph 1.4 Security Classification of Equipment, Components, Spaces and Documents: When required to identify classified spaces, equipment or documents, conforms to Volume VII, Chapter 4, Appendix 4-E of this manual B.2.d.

All Titles that currently contain ANY PHRASE in parentheses that is not a Navy Standard acronym/abbreviation or part of a Planning Yard drawing title shall be removed. Example: (OPTION ITEM, DRYDOCK).

- f. Ensure the following:
 - (1) Template Paragraph 2 “References” conforms to Volume VII, Chapter 4, Appendix 4-E of this manual B.3.

Reference is appropriate and correct for work being done. References shall be in one of the following formats:

602-6663754PL Rev *, (Title)
 602-6663754 Rev *, (Title)
 525146-1 Rev B, (Title) (No Group listed/Manufacturer’s Drawing)

- (2) For FFG-7 Class, any of the above or as follows:
 528-****501 Rev *, (Title)
 528-****501PL Rev *, (Title)
 - (3) Reference type is correctly identified and in accordance with Instructions for Entering Reference Types table located in the help section of NMD.
 - (4) Any liens (Liaison Action Requests/Reverse Liaison Action Requests) against a drawing shall be deleted from the proposed template.
 - (5) The order in which the references are listed is in the same order as they appear in the body of the proposed template.
- g. Ensure Template Paragraph 3 “Requirements” conforms to Volume VII, Chapter 4, Appendix 4-E of this manual B.4. Verify the following:
- (1) NAVSEA Standard Items are called out as required.
 - (2) Category I NAVSEA Standard Item requirements are not invoked.
 - (3) Current Volume VII, Chapter 4, Appendix 4-E of this manual Standard Phraseology is used.
 - (4) Required reports are called out and flagged in NMD. Required flag identifies the purpose of the report such as Inspection Results. The first letter of each word shall be upper case.
 - (5) Inspections, Tests, and Government Notifications conform to Volume VII, Chapter 4, Appendix 4-E of this manual B.4.j.
 - (6) Planner’s Notes are used to call out information that needs to be inserted or addressed.
 - (7) Verify that parts listed as repair parts have the correct information.
 - (8) Cleaning and pumping requirements of Standard Work Template 992-31 are not invoked.
 - (9) Fluid capacities for tanks with designated tank numbers are not listed in the proposed template.
 - (10)
 - (a) A lead paragraph shall include phraseology that begins with a verb, and refer to paragraphs 1.2 and 1.3 within the sentence structure where applicable (e.g., 3.1 Remove existing and install new the equipment listed in 1.3 and located in 1.2).
 - (b) Or refer to a previous lead paragraph that referred to paragraphs 1.2 and 1.3 within the template (e.g., 3.2 Remove each watertight closure listed in 1.3 and located in 1.2., 3.4. Install each watertight closure removed in 3.2).
 - (11) The following format shall be used when entering Contractor Furnished Material:
 - (a) Each entry shall be inserted to line up to header standard phrase B-30 to justify left.
 - (b) No space between material line entries as follows:

TOTAL QUANTITY REQUIRED	NAME OF PART	PIECE NO.	REF. NO.	FIGURE DRAWING NO.	PART NO.
One EA	Seal	2	2.2	7-6	12345
Two EA	Worm Gear	4	2.2	7-6	6789
 - (12) Where Table, Line(s), and Column(s) of 009-32 are specified within a template, the template shall be updated and filled in using the appropriate Table, Line(s), and Column(s). If non-conforming or incorrect, correct proposed template.

- h. Ensure Template Paragraph 4 “Notes” conforms to Volume VII, Chapter 4, Appendix 4-E of this manual B.5. If non-conforming, correct proposed template.
- i. Ensure Template Paragraph 5 “Government Furnished Material (GFM)” conforms to Volume VII, Chapter 4, Appendix 4-E of this manual B.6. If Government Furnished Material is listed in paragraphs 5.1 - 5.3 insure Government Furnished Material information is correct.
- j. Ensure Attachments are correct and open properly in NMD. If errors are found, correct errors.
- k. Review template for conformance to Volume VII, Chapter 4, Appendix 4-E of this manual. If non-conforming, correct proposed template.
- l. Ensure proposed template estimate is completely filled out, estimated as a minimum to the lead paragraph level, and accurate. Templates that are silent in paragraph 1.3 (where the equipment has no identification or specific quantity listed) do not have a true and accurate estimate on file reflecting the actual work within the template. Insert a Planner’s Note in the template to reflect a unit of (One EA) for estimating purposes.
- m. Is the proposed template complete and in conformance with Volume VII, Chapter 4, Appendix 4-E of this manual and the MSCMO Guidelines? If yes, submit proposed template.

2.2 Submission of Change.

- a. Recommended changes to the MSCMO Guidelines shall be submitted to the MSCMO for consideration. Approved changes to the Guidelines will be forwarded by the MSCMO to the Joint Fleet Maintenance Manual Program Manager for inclusion in the next scheduled Joint Fleet Maintenance Manual release, utilizing the Joint Fleet Maintenance Manual Change Request Form.
- b. Recommended changes, to Volume VII, Chapter 4, Appendix 4-E, of this manual shall be submitted to the SSRAC, for consideration of adding to reference (b), through the SSRAC proposed change process. See Volume VII, Chapter 4, Appendix 4-E of this manual for the SSRAC website and e-mail addresses and phone number.
- c. Recommended Enhancements to the NMD program shall be submitted to the Automated Information Service Center through the Configuration Control Board process.

2.3. Internal Review (Planner to Supervisor). Initiating activity shall perform an internal review of proposal to ensure template candidate is appropriate and conforms to Volume VII, Chapter 4, Appendix 4-E of this manual and meets the MSCMO Guidelines. Upon completion of review, template candidate is routed to the Regional RMC/NSA Standards Coordinator.

NOTE: CONTRACTOR GENERATED PROPOSALS MUST BE ROUTED FROM THE CONTRACTOR’S LOCAL STANDARDS COORDINATOR TO THE REGIONAL RMC/NSA STANDARDS COORDINATOR IN THEIR GEOGRAPHIC AREA.

2.4 Command Review. The Regional RMC/NSA shall review proposal to ensure proposed template candidate is appropriate and conforms to Volume VII, Chapter 4, Appendix 4-E of this manual and the MSCMO Guidelines. Upon completion of review, proposed template candidate is:

- a. Routed to the MSCMO for review; or
- b. Prior to routing to the MSCMO for review, the RMC/NSA for that class of ship shall review proposed Class Standard Work Template candidate. This shall be initiated by an e-mail notification from the submitting Regional RMC/NSA MSC Standards Coordinator to the cognizant class RMC/NSA MSC Standards Coordinator. The e-mail notification shall include the file number of the new proposal. The cognizant class RMC/NSA MSC Standards Coordinator receiving the notification shall review proposed template for technical accuracy, current applicable phraseology, conformance to Volume VII, Chapter 4, Appendix 4-E of this manual and the MSCMO Guidelines, estimate information, and submit a response to the submitting Regional RMC/NSA Standards Coordinator via e-mail within 10 days of receipt of notification. Responses shall be provided for all templates submitted for review.

2.5 Master Specification Catalog Maintenance Office.

- a. The MSCMO shall review proposal to ensure template conforms to Volume VII, Chapter 4, Appendix 4-E of this manual and the MSCMO Guidelines. If there are no issues, MSCMO activates new template. If there are significant issues with proposal, MSCMO initiates dialog with local standards person or originator of proposal to resolve issues. Once issues are resolved, MSCMO activates new template.
- b. The MSCMO will return a template if there is no estimate or if the proposed template is a duplicate of an existing template.
- c. Processing Changes to Existing Template. The MSCMO is responsible for maintaining templates (Class Standard Work Templates and Standard Work Templates) up to date. When a user finds an active MSC template that needs to be updated (as a result of changes through Lessons Learned, error, outdated requirements, etc.), a proposed change shall be initiated in accordance with these Guidelines and processed for review in accordance with paragraph 2.4 of this appendix.

3. Naval Supervisory Authorities and Class Assignment Responsibilities.

- a. Mid-Atlantic Regional Maintenance Center (MARMC):
AGF-3, AOE, ARS-50, LCC-19 & DD-963
- b. Norfolk Naval Shipyard (NNSY):
LHA & LHD
- c. Southwest Regional Maintenance Center:
LPD-4, LSD-41, LSD-49, MCM & MHC
- d. Southeast Regional Maintenance Center (SERMC):
FFG-7
- e. SUPSHIP Gulf Coast (SSGC):
CG-47
- f. SUPSHIP Bath (SBAT):
DDG-51

Processing Templates in Navy Maintenance Database
(Proposed New Template or Proposed Change to Existing Template)

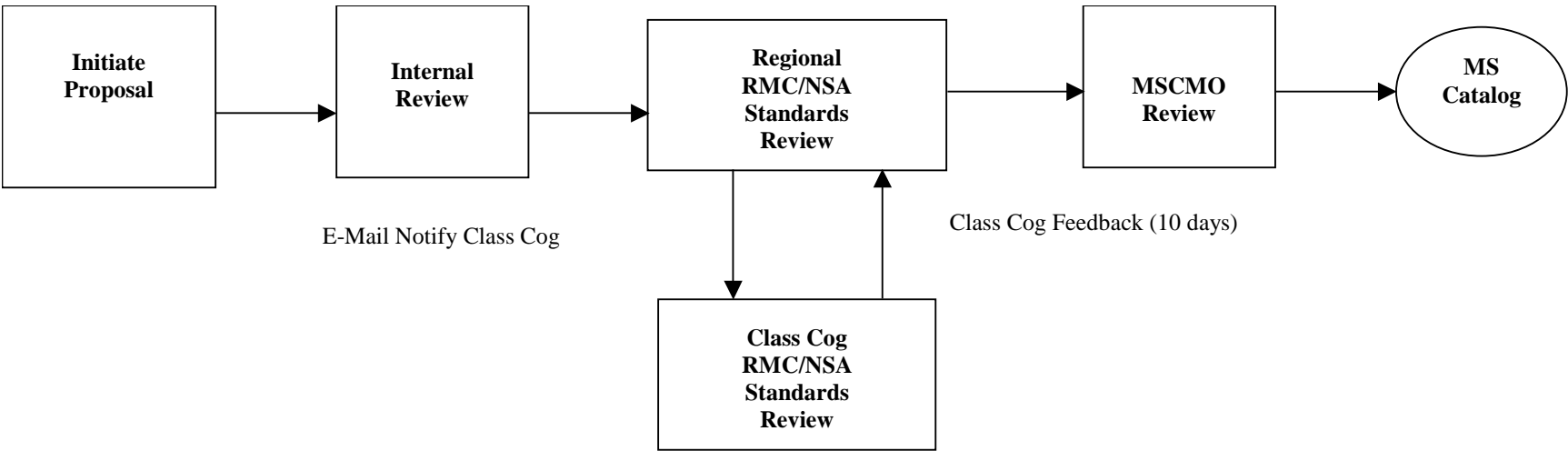

(This Page Intentionally Left Blank)

APPENDIX C

SURFACE SHIP PRORATE PROCESS

II-II-2C-1

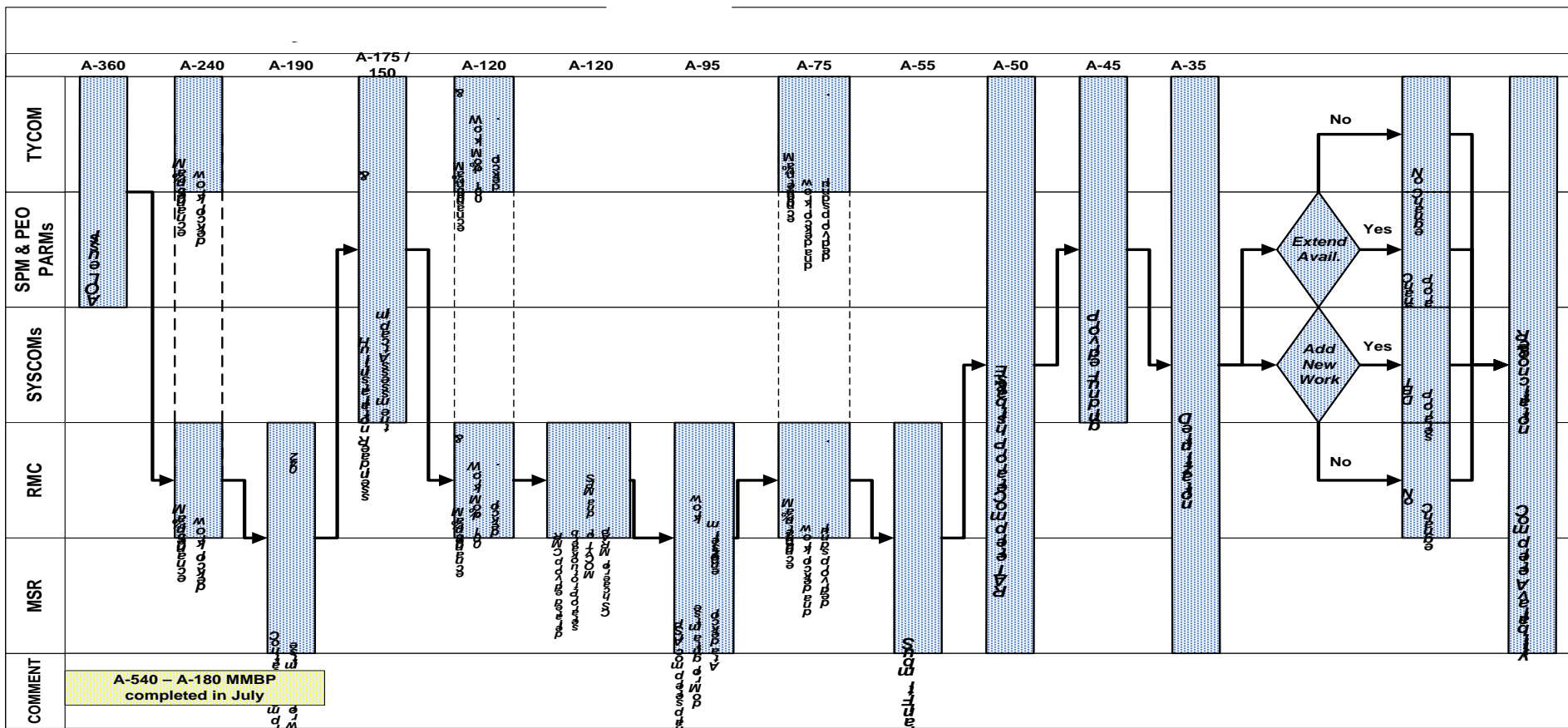

(This Page Intentionally Left Blank)

APPENDIX D

SURFACE SHIP AVAILABILITY MILESTONES

EVENT #	Task/Milestone	Responsible Activity	CNO COST (<\$5M)	CNO COST (>\$5M <\$20M)	CNO COST (>\$20M <\$100M)	CNO COST (>\$100M)	CNO FFP (JAPAN)	COMMENTS/ REMEDIAL ACTION	DESCRIPTION
CNO ADVANCE PLANNING PROCESS (SEA 21 RESPONSIBILITY)									
1	Establish CNO/CM Availability Schedule	TYCOM	A-720	A-720	A-720	A-720	A-720		<u>Establish CNO/CM Availability Schedule:</u> Fleet Response Plan Baselines are developed on a three-year cycle. CNO avails will be identified in accordance with that cycle. TYCOM will publish routine updates in Navy Data Environment (NDE) as they occur.
2	Fund Modernization Procurement & Installation - Decision Point 3 in the Ship Change Document Process	PARM/ TYCOM	Varies	Varies	Varies	Varies	Varies		<u>Fund Modernization Procurement & Installation - Decision Point 3 in the Ship Change Document process:</u> Decision Point 3 is to validate/update the Modernization Plan and to proceed with material procurement and scheduling installations with Resource Sponsor confirmation that funds exist in the budget to fully execute the Ship Change (SC).
3	Issue Execution Planning Hull Modernization Plan (EHMP)	SPM	Varies	Varies	Varies	Varies	Varies		<u>Issue Execution Planning Hull Modernization Plan (EHMP):</u> In support of MMBP development, in March of each year, SPMs will deliver an EHMP listing all program SCs scheduled for each active ship under their cognizance to the RMCs. TYCOMs will deliver an EHMP listing all scheduled fleet SCs for each active ship under their cognizance to the RMCs. The EHMP will contain all SCs scheduled for the next fiscal year and the first quarter of the following fiscal year. It is a snapshot of the current maturity and authorization status and industrial man-day and material estimates for SCs scheduled for installation in the next fiscal year.

II-II-2D-1

COMUSFLTFORCOMINST 4790.3 REV C CH-2

APPENDIX D

SURFACE SHIP AVAILABILITY MILESTONES

EVENT #	Task/Milestone	Responsible Activity	CNO COST (<\$5M)	CNO COST (>\$5M <\$20M)	CNO COST (>\$20M <\$100M)	CNO COST (>\$100M)	CNO FFP (JAPAN)	COMMENTS/ REMEDIAL ACTION	DESCRIPTION
4	Issue 2-year rolling Advance Planning Hull Modernization Plan (AHMP)	SPM	Varies	Varies	Varies	Varies	Varies		<p><u>Issue 2-year rolling Advance Planning Hull Modernization Plan (AHMP):</u> An AHMP for all active ships shall be provided by the cognizant SPM to each RMC in July each year in support of the A-810 to A-450 rolling HMP NMP milestone and development of SPM Advance Planning Letters. The AHMP will contain all Program and Fleet SCs planned for the year after the next fiscal year (Example: JUL 2006 release is for FY 2008). The RMC is advised of the planned SCs for installation to facilitate necessary long lead-time planning efforts for ships under their cognizance.</p>
5	Planning Yard (PY) Submit Funding Request for work assigned	Planning Yard	A-480	A-480	A-480	A-480	A-480		<p><u>Planning Yard (PY) Submit Funding Request for work assigned:</u> PYs request funding from the alteration sponsors for what they know they are going to be tasked to perform.</p>
6	SC Design/Planning Funds provided	PARM/ SPM/ TYCOM	A-425	A-425	A-425	A-425	A-420		<p><u>SC Design/Planning Funds provided:</u> Funding is requested by the PY and the Alt sponsor is to provide the funding. The purpose is to accomplish site-specific advanced planning of the SC. The attention is redirected from overall SC applicability to design for installation on a specific hull or at a specific location. This includes finalized design (including ship check/site survey and drawings, technical installation instructions, etc.), initiation of procurement, pre-installation certification and testing, installation readiness reviews and risk assessments.</p>

APPENDIX D

SURFACE SHIP AVAILABILITY MILESTONES

EVENT #	Task/Milestone	Responsible Activity	CNO COST (<\$5M)	CNO COST (>\$5M <\$20M)	CNO COST (>\$20M <\$100M)	CNO COST (>\$100M)	CNO FFP (JAPAN)	COMMENTS/ REMEDIAL ACTION	DESCRIPTION
7	Send habitability project advance planning notice	TYCOM N43	A-420	A-420	A-420	A-420	A-420		<u>Send habitability project advance planning notice:</u> This TYCOM generated notice identifies Projects proposed for accomplishment, and provides work scope details including, if applicable, Ship's Force manpower requirements. This notice also requests Commanding Officer's comments, concurrence and commitment of resources to the proposed projects.
8	Installation Control Drawings (ICD)/Installation Requirements Drawings (IRD) delivered to alteration developer/PY	PARM	A-420				A-420		<u>Installation Control Drawings (ICD)/Installation Requirements Drawings (IRD) delivered to alteration developer/PY:</u> ICDs and IRDs are equipment specific drawings and should be used as general guidance to develop Ship Specific/Ship Class Ship Installation Drawings (SID). SIDs are the authorized/approved drawings to be used by the IAs for shipboard implementation of SCs. ICDs/IRDs should be used as supplemental information where SIDs are deficient in specific guidance, and should be accompanied by a Liaison Action Record (LAR) prior to their use. Alteration Sponsors provide the ICD for SID development to the appropriate party (PY or Third Party).

II-II-2D-3

APPENDIX D

SURFACE SHIP AVAILABILITY MILESTONES

EVENT #	Task/Milestone	Responsible Activity	CNO COST (<\$5M)	CNO COST (>\$5M <\$20M)	CNO COST (>\$20M <\$100M)	CNO COST (>\$100M)	CNO FFP (JAPAN)	COMMENTS/ REMEDIAL ACTION	DESCRIPTION
9	Issue Request for the EP Proposal to the planning activity. Notify each funding sponsor of the requirement and amount of funding for Execution Planning. Provide no later than date for required funding.	RMC C300	A-410	A-410	A-410	A-410	A-410		<u>Issue Request for the EP Proposal to the planning activity. Notify each funding sponsor of the requirement and amount of funding for Execution Planning. Provide no later than date for required funding:</u> Develop Execution Planning CLIN MSC Work Item. Develop Independent Government Estimate (IGE), and Issue RFP for Planning. Notify each funding sponsor of the requirement for Planning funding. Provide “no later than date” for required funding. Each funding Sponsor is required to fund the Planning Costs associated with their requirements. If an advanced LOA is not available, the SEA21 Monthly Advanced Planning Letter will be used to estimate the Modernization Sponsor’s cost. Funding must be received NLT A-365 to ensure Work Item development and Long Lead Time Material (LLTM) identification can start at A-360 in conjunction with issuance of the AWP and LOAs.
10	Accomplish SURFMEPP Mid-Cycle Review	SURFMEPP	A-410	A-410	A-410	A-410	A-410		<u>Accomplish SURFMEPP Mid Cycle Review:</u> This is the SURFMEPP Mid Cycle Review of the ship’s BAWP, CSMP, active DFSs, Class Advisories, routines/services, and the Availability Duration. All items will be reviewed and evaluated for branding. The MT will ensure 100% of BAWP is screened to a scheduled or future maintenance availability. The MT will screen all requirements to a maintenance period/availability (other than unfunded) within the current FRP maintenance cycle. This is the final verification prior to the BAWP change to the AWP. The A-360 Letter is the output.

II-II-2D-4

COMUSFLTFORCOMINST 4790.3 REV C CH-2

APPENDIX D

SURFACE SHIP AVAILABILITY MILESTONES

EVENT #	Task/Milestone	Responsible Activity	CNO COST (<\$5M)	CNO COST (>\$5M <\$20M)	CNO COST (>\$20M <\$100M)	CNO COST (>\$100M)	CNO FFP (JAPAN)	COMMENTS/ REMEDIAL ACTION	DESCRIPTION
11	Provide Funding for Execution Planning	PARM/SPM/ TYCOM	A-365	A-365	A-365	A-365			<u>Provide Funding for Execution Planning:</u> Funding must be received NLT A-365 to ensure Work Item development and LLTM identification can start at A-360 in conjunction with issuance of the AWP and LOAs.
12	Provide Availability Financial Target Control	SPM/TYCOM	A-360	A-360	A-360	A-360	A-360		<u>Provide Availability Financial Target Control:</u> A financial control is required in order to establish the Availability Planning Requirements.
13	Issue Initial Letter Of Authorization (including AITs)/ Hull Modernization Plan	SPM/ TYCOM	A-360	A-360	A-360	A-360	A-360		<u>Issue Initial Letter Of Authorization (including AITs)/ Hull Modernization Plan:</u> NAVSEA and TYCOM Letters of Authorization (LOA) are issued showing all modernizations scheduled for the CNO Availability. The SPM LOA specifies to the NSA the SCs approved to be accomplished during a specific ship CNO availability. Forecasted ship changes may be viewed through the NDE database at C+130 and continuing throughout the BAWP to AWP development process. This list will be reviewed at each BAWP Milestone Meeting. Items from this list will not be entered into the ship's CSMP until they have been reconciled with an issued LOA.
CNO PLANNING PROCESS (RMC RESPONSIBILITY)									
14	Definitize Execution Planning	RMC C400	A-360	A-360	A-360	A-360	N/A		<u>Definitize Execution Planning:</u> A negotiated price for the anticipated planning actions necessary to support the availability that has been funded via a supplemental agreement. This step contractually obligates both the government and contractor to the requirements defined in the EP work Item(s).
15	Establish Availability in the appropriate IT system	RMC C300	A-360	A-360	A-360	A-360	A-360		<u>Establish Availability in the appropriate IT system:</u> Availabilities will be established in the applicable planning data base when known or work is ready to be screened.

II-II-2D-5

COMUSFLTFORCOMINST 4790.3 REV C CH-2

APPENDIX D

SURFACE SHIP AVAILABILITY MILESTONES

EVENT #	Task/Milestone	Responsible Activity	CNO COST (<\$5M)	CNO COST (>\$5M <\$20M)	CNO COST (>\$20M <\$100M)	CNO COST (>\$100M)	CNO FFP (JAPAN)	COMMENTS/ REMEDIAL ACTION	DESCRIPTION
16	Advance Planning to Planning Event	NRMC C300	A-355	A-355	A-355	A-355	A-355		Advance Planning to Planning Event: IPTD Overview Introduction of the IPTD Program to the Ship/MT. BAWP package review. AWP Package Review to include any planned habitability work scheduled for the avail and TYCOM funded alterations. Modernization Package review LOA, discussion of the PY drawing status including Ship checks (if they are funded), etc. Review schedule risk identified during BAWP process, start identification of overall availability risks. Select Planning Milestones to suit availability. Establish Communication plan/strategy and meeting/planning drumbeat.
17	Task/Fund SID Development	SPM/NSA/ AIT/TYCOM	A-330	A-330	A-330	A-330	A-330 (A-375)		Task/Fund SID Development: Alteration Sponsors task and fund appropriate party to develop SIDS (PY or Third Party). This is a Modernization milestone to ensure funding has been obligated in support of SID development/SID delivery milestones.
18	Modernization Ship Checks Completed	Planning Yard/Or Other as Assigned	A-300	A-300	A-300	A-300	A-300 (A-315)		Modernization Ship Checks completed: Ship checks (Design, Verification, Production and Proofing) are accomplished in support of the development of SIDs. All ship checks will incorporate a validation/verification of actual Hull/Site configuration. This is a Modernization milestone to ensure all design ship checks are complete in support of the SID delivery milestone.

II-II-2D-6

COMUSFLTFORCOMINST 4790.3 REV C CH-2

APPENDIX D

SURFACE SHIP AVAILABILITY MILESTONES

EVENT #	Task/Milestone	Responsible Activity	CNO COST (<\$5M)	CNO COST (>\$5M <\$20M)	CNO COST (>\$20M <\$100M)	CNO COST (>\$100M)	CNO FFP (JAPAN)	COMMENTS/ REMEDIAL ACTION	DESCRIPTION
19	Provide incremental funds for ordering LLTM for both repair and alt/mod work to meet required dates	SYSCOM/SPM/TYCOM	A-270	A-270	A-270	A-270	A-270 (A-315)	Overseas location of SRF-JRMC results in longer procurement and shipping times.	Incremental funding: Provide incremental funds for ordering LLTM for both repair and alt/mod work to meet required dates. This is an iterative process as LLTM is identified and funding is requested and authorized based on the lead time. It is incumbent on the Execution Planning Activity/MT to identify LLTM as soon as possible. LLTM is defined as any material with a delivery date in excess of 30 days.
20	50% of D-level maintenance work package development 2Ks have been screened based on target control	TYCOM	A-240	A-240	A-240	A-240	A-240		50% of D-level maintenance work package development 2Ks have been screened based on target control: Intent is that 50% of the expected AWRs (work, not services) have been screened to the planning activity. The planning activity continually develops specs in the most cost effective manner and does not batch this work in front of the next package development milestone.
21	Total Ships Readiness Assessment (TSRA)-1 Discrepancies Screened	Ashore Ships Maintenance Manager	A-240	A-240	A-240	A-240	A-240		Total Ships Readiness Assessment (TSRA) 1 Discrepancies Screened: TSRA-1 is a TYCOM-scheduled two-week ship-wide pre-deployment material condition assessment designed to identify work items for inclusion in the post-deployment maintenance availability. The goal of this phase is to reduce availability growth and new work, by providing the earliest possible identification of work, which is then notionally scheduled in an availability. This is a validation that the discrepancies identified as a result of TSRA-1 assessment has been screened by this date.

II-II-2D-7

APPENDIX D

SURFACE SHIP AVAILABILITY MILESTONES

EVENT #	Task/Milestone	Responsible Activity	CNO COST (<\$5M)	CNO COST (>\$5M <\$20M)	CNO COST (>\$20M <\$100M)	CNO COST (>\$100M)	CNO FFP (JAPAN)	COMMENTS/ REMEDIAL ACTION	DESCRIPTION
22	Submit A-220 Deferral Letter with Maintenance Team Assist	TYCOM	A-220	A-220	A-220	A-220	A-220		<u>Submit A-220 Deferral Letter with Maintenance Team Assist:</u> At A-220, TYCOM will submit a Change Deferral Request Letter to SURFMEPP, which will include a list of Change Deferral Requests for subject FRP Maintenance Cycle.
23	Issue/Deliver SIDs to NSA for contractors and AITs	Planning Yard	A-210	A-210	A-210	A-210	A-240		<u>Issue/deliver SIDs to NSA for contractors and AITs:</u> SID delivery is listed in the NMP MOM as a critical milestone. All SIDs must be issued to the NSA NLT A-210 to ensure planning milestones can be met.
24	IPTD Strategy Development	NRMC C300	A-190	A-190	A-190	A-190	A-190		<u>IPTD Strategy Development:</u> "Strategy Development Meeting. The PT's risk assessment letter will be reviewed with the team at the event and any newly discovered risks will be evaluated and added to the letter. Strategies identified by the PT will serve as the focus of the event presentations with a goal of generating real time discussions amongst the major stakeholders pertaining to the strategy documents and by the end of the event making them acceptable for signature." The PT will review and submit to the availability risk assessment letter to the respective RMC Commander within 10 days of the A-190 milestone.
25	Planning Activity complete planning and estimating of work assigned as required by the 50% package development milestone .	Contractor	A-190	A-190	A-190	A-190	N/A		<u>Planning activity complete planning and estimating of work assigned as required by the 50% package development milestone:</u> The requirement is that all work brokered by the 50% package development milestone shall be planned (Work Item complete and LLTM identified) and estimated with minimum quality as described as a "Class C" estimate.

APPENDIX D

SURFACE SHIP AVAILABILITY MILESTONES

EVENT #	Task/Milestone	Responsible Activity	CNO COST (<\$5M)	CNO COST (>\$5M <\$20M)	CNO COST (>\$20M <\$100M)	CNO COST (>\$100M)	CNO FFP (JAPAN)	COMMENTS/ REMEDIAL ACTION	DESCRIPTION
26	IGE Submitted in support of 50% package development.	RMC C300	A-190	A-190	A-190	A-190	A-190		<u>IGE Submitted in support of 50% package development:</u> The requirement is that all work Planned in support of the 50% package development milestone shall be estimated by the government with minimum quality as described as a "Class C" estimate.
27	Estimate Comparison Complete in support of 50% package development	RMC C400/C300	A-180	A-180	A-180	A-180	N/A		<u>Estimate Comparison Complete in support of 50% package development:</u> The requirement is that a bottom line comparison of the contractor provided Class C estimate and IGE Class C will be compared. Any estimate in excess of 10% or \$10K (whichever is greater) will be scoped for requirements. Estimates will be revised as required to ensure that there is a consensus for the scope of work required. The government estimate will be documented to reflect the outcome of the scoping.
28	LOA Change 1 Issued	SPM	A-180	A-180	A-180	A-180	A-180		<u>LOA Change 1 issued:</u> After LOA Change 1 is issued, any change to the Fielding Plan in NDE-NM that requires SIDs or impacts ship distributed systems requires sponsoring activity to submit a late add impact assessment.
29	All Modernization Risk Assessments (including waivers) submitted	PARM/ SPM/ TYCOM	A-175	A-175	A-175	A-175	A-175 (A-210)	Overseas location of SRF-JRMC necessitates earlier planning in support of longer logistics pipeline.	<u>All Modernization Risk Assessments (including waivers) submitted:</u> Complete all required design, procurement of material, pre-installation testing, and obtain all required certifications/impact assessment(s) prior to final installation. Evaluate maturity of an installation and determine if the SC is ready for installation. Perform an impact assessment for SCs that have not achieved maturity in accordance with the Navy Modernization milestone charts to determine whether or not to proceed with installation planning.

II-II-2D-9

COMUSFLTFORCOMINST 4790.3 REV C CH-5

APPENDIX D

SURFACE SHIP AVAILABILITY MILESTONES

EVENT #	Task/Milestone	Responsible Activity	CNO COST (<\$5M)	CNO COST (>\$5M <\$20M)	CNO COST (>\$20M <\$100M)	CNO COST (>\$100M)	CNO FFP (JAPAN)	COMMENTS/ REMEDIAL ACTION	DESCRIPTION
30	Risk Letter Sent to CNRMC	RMC Code 100	A-170	A-170	A-170	A-170	A-170		Risk Letter Sent to CNRMC: A-180 Risk letter will be submitted to CNRMC (with copy to TYCOM) for review and endorsement no later than 10 days after the A-180 milestone. The A-180 Risk Letter (Include Modernization Risk) will address, at a minimum, the following: Budget, Schedule, Resources (Manpower/ Fiscal), RMC/NSA Capability/ Capacity, Contractor Capability/ Capacity, Availability Duration, Planning, Modernization, Funding. (Include work items MT intends to broker to IDIQ contracts and other government agencies.)
31	All Modernization Risk Assessments (including waivers) approved	FLEET/ TYCOM	A-150	A-150	A-150	A-150	A-150 (A-185)	Overseas location of SRF-JRMC necessitates earlier planning in support of longer logistics pipeline.	<u>All Modernization Risk Assessments (including waivers) approved:</u> Perform an impact assessment for SCs that have not achieved maturity IAW the Navy Modernization milestone charts to determine whether or not to proceed with installation planning.
32	Award AIT contracts for work not being done by prime contractor/ Identify all outside activities participating in the availability and associated support requirements	AIT Sponsor/ TYCOM N43/SEA 21	A-150	A-150	A-150	A-150	A-150		<u>Award AIT contracts for work not being done by prime contractor/ Identify all outside activities participating in the availability and associated support requirements:</u> The AIT Manager shall have the AIT contract in place NLT this milestone. Contract tasking can also include testing support, incidental and consumable material, ship check and post-install support. The selected contractor must have a NAVSEA 04XQ accepted QMS in order to accomplish shipboard industrial work. The AIT Manager shall ensure that the contract identifies all contractor deliverables necessary to complete schedule, return costs and design change feedback. Date supports requirement for POA&M at A-135. All non-AIT contractor outside activities will be contacted to obtain service requirements.

II-II-2D-10

APPENDIX D

SURFACE SHIP AVAILABILITY MILESTONES

EVENT #	Task/Milestone	Responsible Activity	CNO COST (<\$5M)	CNO COST (>\$5M <\$20M)	CNO COST (>\$20M <\$100M)	CNO COST (>\$100M)	CNO FFP (JAPAN)	COMMENTS/ REMEDIAL ACTION	DESCRIPTION
33	Identification of AIT support requirements and POA&M provided	AIT Manager	A-135	A-135	A-135	A-135	A-180		<u>Identification of AIT support requirements and POA&M provided:</u> If the AIT will require industrial support, (e.g., crane and rigging services, welding/burning, compressed air), during accomplishment of the alteration/SC, additional information (OPNAV Form 4790/2K) requesting these services will be provided for loading into the CSMP shore file. The AIT Manager, or their designated representative, will prepare information for the creation of a 2K/JCN. In addition, if required by the NSA, any required support services must be specified using 4790/2K. The planning activity can then prepare a 4E specification work item in accordance with Volume VII, Chapter 4, Appendix E of this manual for inclusion in the CNO availability work package for private sector industrial availabilities, or a job summary and Task Group Instruction (TGI) for Naval shipyard availabilities.
34	80% of D-level maintenance work package development 2Ks have been screened based on target control	TYCOM	A-120	A-134	A-155	A-155 See Note 1	A-210		<u>80% of D-level maintenance work package development 2Ks have been screened based on target control:</u> Intent is that 80% of the expected AWRs (work not services) have been screened/brokered to the planning activity. The planning activity continually develops specs in the most cost effective manner and does not batch this work in front of the next package development milestone.
35	Conduct Work Package Integration Conference (WPIC)	RMC C300	A-120	A-120	A-120	A-120	A-120		<u>Conduct Work Package Integration Conference (WPIC):</u> Provides a forum for early identification of work requirements that require integration to avoid conflicts with other work during execution.

APPENDIX D

SURFACE SHIP AVAILABILITY MILESTONES

EVENT #	Task/Milestone	Responsible Activity	CNO COST (<\$5M)	CNO COST (>\$5M <\$20M)	CNO COST (>\$20M <\$100M)	CNO COST (>\$100M)	CNO FFP (JAPAN)	COMMENTS/ REMEDIAL ACTION	DESCRIPTION
36	LOA CH 2, 100% Modernization Lock	SPM	A-120	A-120	A-120	A-120	A-120		<u>LOA CH 2, 100% Modernization Lock:</u> The SPM shall prepare and issue the A-120 LOA. The A-120 LOA will identify any planned SCs identified in the A-360 letter that have reached maturity. All SCs that have not reached maturity at A-120 or do not have an approved impact assessment will be deferred from the availability with the exception of Sustainment Type SCs which must meet this criteria by A-75.
37	Submit Execution Risk Letter	RMC Code 100	A-110	A-110	A-110	A-110	A-110		<u>Submit Execution Risk Letter:</u> A-120 Risk letter will be submitted to CNRMC for review and endorsement (to be sent to TYCOM) NLT 10 days after the A-120 milestone. The A-120 Risk Letter is the first Risk Letter to specifically address Execution Risk along with Planning Risk.
38	Planning Activity complete planning and estimating of work assigned as required by the above 80% package development milestone.	Planning Activity	A-95	A-109	A-120	A-120 See Note 1	N/A		<u>Planning Activity complete planning and estimating of work assigned as required by the above 80% package development milestone:</u> The requirement is that all work brokered by the 80% lock milestone shall be planned (Work Item complete and LLTM identified) and estimated with the minimum quality described as a "Class C" estimate.
39	IGE Submitted in support of 80% package development	RMC C300	A-95	A-109	A-120	A-120 See Note 1	A-185		<u>IGE Submitted in support of 80% package development:</u> The requirement is that all work Planned in support of the 80% package development milestone shall be estimated by the government with the minimum quality described as a "Class C" estimate.

APPENDIX D

SURFACE SHIP AVAILABILITY MILESTONES

EVENT #	Task/Milestone	Responsible Activity	CNO COST (<\$5M)	CNO COST (>\$5M <\$20M)	CNO COST (>\$20M <\$100M)	CNO COST (>\$100M)	CNO FFP (JAPAN)	COMMENTS/ REMEDIAL ACTION	DESCRIPTION
40	Total Ships Readiness Assessment (TSRA)-2 Discrepancies Screened	Ashore Ship Maintenance Manager	A-90	A-114	A-128	A-128 See Note 1	A-180		<u>TSRA-2 Discrepancies Screened:</u> TSRA-2 focuses on the evaluation of equipment after deployment to minimize growth and new work within the ship's CNO availability. It includes a post-deployment, underway material assessment of selected HM&E and C5I systems and is designed to add work items needed to fully define the Availability Work Package (AWP).
41	I-level work package fully brokered	Ashore Ship Maintenance Manager	A-90	A-90	A-90	A-90	A-90		<u>I-level work package fully brokered:</u> Intent is to fully broker all known Intermediate Level work to I-level by this date.
42	Estimate Comparison Complete in support of 80% package development	RMC C400/C300	A-85	A-99	A-110	A-110 See Note 1			<u>Estimate Comparison Complete in support of 80% package development:</u> The requirement is that a bottom comparison of the contractor provided Class C estimate and IGE Class C will be compared. Any estimate in excess of 10% or \$10K (whichever is greater) will be scoped for requirements. Estimates will be revised as required to ensure that there is a consensus for the scope of work required. The government estimate will be documented to reflect the outcome of the scoping.
43	I-level work package fully accepted	RMC Code 900	A-75	A-75	A-75	A-75	A-75		<u>I-level work package fully accepted:</u> Intent is for I-level to accept or reject all work brokered to it up to this point in time. Any work entering later in the process will be subject to the Business Case Analysis process and will likely need to be inducted into the work package as new work.

APPENDIX D

SURFACE SHIP AVAILABILITY MILESTONES

EVENT #	Task/Milestone	Responsible Activity	CNO COST (<\$5M)	CNO COST (>\$5M <\$20M)	CNO COST (>\$20M <\$100M)	CNO COST (>\$100M)	CNO FFP (JAPAN)	COMMENTS/ REMEDIAL ACTION	DESCRIPTION
44	100% of O-level maintenance work package locked	Ship's Force	A-75	A-75	A-75	A-75	A-75		<u>100% O-level Maintenance Work package locked:</u> Develop a Ship's Force concurrent Work Package that includes all major maintenance actions such as Planned Maintenance System (PMS), repairs, alterations and testing to be conducted by Ship's Force during the availability, as applicable. Review PMS, CSMP and Testing requirements and ensure all Ship's Force maintenance actions scheduled for accomplishment during availability are identified
45	100% of D-level maintenance work package 2K's locked based on target control	Ashore Ship Maintenance Manager	A-75	A-90	A-120	A-140 Note 1	A-170		<u>100% of D-level maintenance work package 2Ks locked based on target control:</u> Intent is that 100% of the expected AWRs have been brokered to the planning activity. The planning activity continually develops specs in the most cost effective manner and does not batch this work in front of the next package development milestone.
46	Final Work Item Review/Approval	RMC C300	A-65	A-92	A-104	A-104 See Note 1	A-156		<u>Final Work Item Review/Approval:</u> Work Item reviews shall be accomplished on a routine drumbeat established by the MT with the final work item review being completed in support of the established publishing date for the specification package. This will include the final quality and technical and contractual review of the work items. Contractual shall include legal requirements, i.e., if sole source, is there sole source justification?

APPENDIX D

SURFACE SHIP AVAILABILITY MILESTONES

EVENT #	Task/Milestone	Responsible Activity	CNO COST (<\$5M)	CNO COST (>\$5M <\$20M)	CNO COST (>\$20M <\$100M)	CNO COST (>\$100M)	CNO FFP (JAPAN)	COMMENTS/ REMEDIAL ACTION	DESCRIPTION
47	Solicit Bids	RMC C400	N/A	N/A	N/A	N/A	A-120		<u>Solicit Bids</u> : Non-Multi-Option Contracting Vehicles. The Federal Acquisition Regulation designates FedBizOpps as the mandatory "Government wide point of entry (GPE)" for posting of Government business opportunities, including proposed contract actions, solicitations and associated information.
48	100% of D-level maintenance work package 2Ks planned, estimated.	Planning Activity	A-65	A-89	A-106	A-106 See Note 1	A-155 (A-110)		<u>100% of D-level maintenance work package 2Ks planned, estimated</u> : The requirement is that all work brokered by the 100% lock milestone shall be planned (Work Item complete and LLTM identified) and estimated with the minimum quality described as a "Class C" estimate.
49	Planning Activity "publish" package in the appropriate IT system	Planning Activity	A-65	A-92	A-104	A-104 See Note 1	N/A		<u>Planning Activity "publish" package in the appropriate IT system</u> : This is the act of issuing a final specification package for the availability that will be used to formulate a proposal. All work after this date will be handled as supplemental and/or new work.
50	IGE Submitted in support of 100% lock	RMC C300	A-65	A-67	A-78	A-78 See Note 1	A-120		<u>IGE submitted in support of 100% lock</u> : The requirement is that all work Planned in support of the 100% lock milestone shall be estimated by the government with the minimum quality described as a "Class C" estimate.
51	Issue Specification package to FLC (SRF-JRMC only)	MT	NA	NA	NA	NA	(A-130)		<u>Issue Specification package to FLC (SRF-JRMC only)</u> : This is the act of issuing a final specification package for the availability that will be used to propose upon. All work after this date will be handled as supplemental and/or new work.

APPENDIX D

SURFACE SHIP AVAILABILITY MILESTONES

EVENT #	Task/Milestone	Responsible Activity	CNO COST (<\$5M)	CNO COST (>\$5M <\$20M)	CNO COST (>\$20M <\$100M)	CNO COST (>\$100M)	CNO FFP (JAPAN)	COMMENTS/ REMEDIAL ACTION	DESCRIPTION
52	Submit I-level work package and schedule for integration	RMC C900	A-60	A-60	A-60	A-60	A-60		Submit I-level work package and schedule for integration: The LMA shall develop an inclusive, detailed, integrated and resource-loaded schedule of all participating activities. All participants shall meet and review the proposed plan and make necessary adjustments to render a balanced and optimized integrated schedule. This formal schedule review shall occur after the WPIC, but no later than the Work Package Execution Review. The NSA/LMA shall serve as the final arbiter of conflicts. By the Work Package Execution Review, all integrated schedule conflicts shall be resolved by the NSA/LMA.
53	Cutoff for bidders questions	PCO	N/A	N/A	N/A	N/A	A-100		Cutoff for bidders questions: The NLT date, issued by the PCO, is the date that the government will no longer accept pre-bid inquiries for a particular solicitation. The time frame established allows the PCO time to respond to the inquiry while still maintaining adequate time for the contractor to produce a proposal/bid.
54	Submit Bids	Contractor	N/A	N/A	N/A	N/A	A-90		Submit Bids: This is the date, provided by the PCO, when a Firm Fixed Price (FFP) offeror must submit their bid to be considered responsive. Submissions after this date are typically rejected.
55	Award Contract	RMC C400	N/A	N/A	N/A	N/A	A-60		Award Contract: This is the notification by the Contracting Officer to a bidder that his offer, or a negotiated proposal, has been accepted. This award establishes a legal obligation between the parties.

APPENDIX D

SURFACE SHIP AVAILABILITY MILESTONES

EVENT #	Task/Milestone	Responsible Activity	CNO COST (<\$5M)	CNO COST (>\$5M <\$20M)	CNO COST (>\$20M <\$100M)	CNO COST (>\$100M)	CNO FFP (JAPAN)	COMMENTS/ REMEDIAL ACTION	DESCRIPTION
56	Contractor submit final package cost proposal	Contractor	A-55	A-67	A-76	A-76 See Note 1	N/A		Contractor submit final package cost proposal: This is the date that the Prime contract holder must submit their valid/complete cost proposal. It shall be in compliance with the DCAA's "CRITERIA FOR ADEQUATE CONTRACT PRICING PROPOSALS" associated with an option within the contract in support of a defined scope of work. The proposal shall include an integrated schedule based upon the proposed work package.
57	Complete TAR	RMC C400	A-50	A-53	A-55	A-55 See Note 1	N/A		Complete TAR: The Technical Advisory Report (TAR) will be prepared by the technical analyst on claims/proposals that meet threshold criteria established by the FAR. At any value below that threshold, and at the discretion of the negotiator, a "desk" TAR may be performed by the negotiator. Usually the evaluation involves review of direct labor hours and costs associated with material, delay in delivery and/or disruption costs. It will also include review of the contractor's estimating standards. The TAR should reflect the technical evaluation and its results. The TAR serves several essential purposes, including essential file documentation, advice to the negotiator and ACO and advice to the auditor if an audit is to be conducted. The objective of the TAR is to establish the acceptability and reasonableness of the contractor's proposal and/or backup data and records.

APPENDIX D

SURFACE SHIP AVAILABILITY MILESTONES

EVENT #	Task/Milestone	Responsible Activity	CNO COST (<\$5M)	CNO COST (>\$5M <\$20M)	CNO COST (>\$20M <\$100M)	CNO COST (>\$100M)	CNO FFP (JAPAN)	COMMENTS/ REMEDIAL ACTION	DESCRIPTION
58	Establish Prorate based on final cost proposal	RMC C400 RMC C300 SEA 21 Program Managers Rep TYCOM N43	A-50	A-53	A-55	A-55 See Note 1	N/A		<u>Establish prorate based on final cost proposal:</u> At A-120, all mature SCs listed on the LOA will be considered for prorations. The budgets associated with SCs and repair and maintenance will lock the proration distribution percentages. If modernization is added after this date, the sponsor will assume the full increase in cost associated with the prorated items. The percentages established at this time will be applied to the proratable items proposal amount by sponsor to establish the full funding required.
59	Submit Funding Requests to Funding Sponsors	RMC C300	A-50	A-53	A-55	A-55	N/A	Program Office wants 14 days from receipt of request to receipt of funds.	<u>Submit Funding Requests to Funding Sponsors:</u> Sponsors must be kept aware of anticipated funding needs including pro rated amounts. This typically happens as estimates come in but MUST be communicated when the proposal is received and finalized as the TAR completes.
60	Pre-Business Clearance Approved Within C400	RMC C400	A-46	A-46	A-45	A-45 See Note 1	N/A		<u>Pre-Business Clearance Approved within C400:</u> The pre-negotiation plan is an official document of the contracting officer's negotiation objectives relating to pricing, technical, business and contractual issues. It assists in the contracting officer's determination of a fair and reasonable price. It must document the pertinent issues to be negotiated and the cost objectives and a profit or fee objective. Because it serves as the basis of the negotiation, the pre-negotiation plan should fully explain the contractor and Government positions.

II-II-2D-18

APPENDIX D

SURFACE SHIP AVAILABILITY MILESTONES

EVENT #	Task/Milestone	Responsible Activity	CNO COST (<\$5M)	CNO COST (>\$5M <\$20M)	CNO COST (>\$20M <\$100M)	CNO COST (>\$100M)	CNO FFP (JAPAN)	COMMENTS/ REMEDIAL ACTION	DESCRIPTION
61	Provide Availability Funding for Repair and Modernization to the RMC	SYSCOMS/ SPM/TYCOM	A-45	A-45	A-45	A-45	A-75 (A-150)		<u>Provide Availability Funding for Repair and Modernization to the RMC:</u> Availability funding is required prior to definitization. In order to assure that the correct amount and type of funding is available, it should be received at the RMC NLT 10 days prior to the scheduled definitization date. Receipt of funding later than that may cause the work package to be deleted from the work package or may delay definitization.
62	Pre BCM Routed and Approved Through SEA 02	RMC C400/SEA 02	N/A	A-40	A-40	A-40	N/A		<u>Pre-BCM Routed and Approved through SEA 02:</u> SEA 02 must approve the Pre-BCM for all contracting actions expected to exceed the Contracting Officers threshold for award.
63	Final Negotiations	RMC C400/ SEA 02	A-43	A-43	A-38	A-38 See Note 1	N/A		<u>Final Negotiations:</u> Negotiation is a procedure that includes the receipt of proposals from offerors, permits bargaining, and usually affords offerors an opportunity to revise their offers before award of a contract. Bargaining, in the sense of discussion, persuasion, alteration of initial assumptions and positions, and give-and-take, may apply to price, schedule, technical requirements, type of contract or other terms of a proposed contract.

II-II-2D-19

COMUSFLTFORCOMINST 4790.3 REV C CH-5

APPENDIX D

SURFACE SHIP AVAILABILITY MILESTONES

EVENT #	Task/Milestone	Responsible Activity	CNO COST (<\$5M)	CNO COST (>\$5M <\$20M)	CNO COST (>\$20M <\$100M)	CNO COST (>\$100M)	CNO FFP (JAPAN)	COMMENTS/ REMEDIAL ACTION	DESCRIPTION
64	Post BCM Drafted within C400	RMC C400	N/A	N/A	A-35	A-35	N/A		Post BCM Drafted within C400: Upon completing negotiations, a price negotiation memorandum must be developed. It should document the purpose and results of the negotiation, the extent to which negotiation objectives were met and the basis for accepting a position that departs from the established objective. To the extent that specific negotiation objectives were met, a statement to this effect is sufficient. A restatement or summary of information and analysis provided in the pre-negotiation is not required. However, where there are differences between the negotiation objectives and the actual negotiated outcome or issues not identified in the pre-negotiation plan, the price negotiation memorandum should provide a full explanation of the agreement reached.
65	CHINFO Release	RMC C400	N/A	A-40	A-32	A-32	N/A		CHINFO Release: A news release is required per DFARs to provide information on all contractual actions or modifications that have a face value of more than \$6.5 million, excluding unexercised options. This information will be used in a public news release announcing the award. Congressional members whose states or districts are affected by the contract (either the contractor lives in the state or district or the work will be performed there) will be provided similar information concurrent with the public announcement. Contract award information will be provided to the appropriate Public Affairs Office (PAO) in the form of a news release.

II-II-2D-20

COMUSFLT/FORMCOMINST 4790.3 REV C CH-5

APPENDIX D

SURFACE SHIP AVAILABILITY MILESTONES

EVENT #	Task/Milestone	Responsible Activity	CNO COST (<\$5M)	CNO COST (>\$5M <\$20M)	CNO COST (>\$20M <\$100M)	CNO COST (>\$100M)	CNO FFP (JAPAN)	COMMENTS/ REMEDIAL ACTION	DESCRIPTION
66	Post BCM Routed and Approved Through SEA 02	RMC C400/ SEA 02	N/A	N/A	A-30	A-30	N/A		<u>Post-BCM Routed and Approved through SEA 02:</u> SEA 02 must approve the Post-BCM for all contracting actions exceeding the Contracting Officers threshold for award.
67	Definitize Work Package	RMC C400	A-35	A-35	A-30	A-30	N/A		<u>Definitize Work Package:</u> The culmination of the contractual planning efforts resulting in a negotiated price for the availability that has been funded via a supplemental agreement. This step contractually obligates both the government and contractor to the requirements of the Work Package.
68	Deliver Material (LLTM and Kitted Materials) to Executing Activity	Planning Yards/PARM	A-30	A-30	A-30	A-30	A-30 (A-75)	Overseas location of SRF-JRMC necessitates earlier receipt for recovery time in case of shortages	<u>Deliver Material (LLTM and Kitted Materials) to Executing Activity:</u> LLTM is any material that will take in excess of 30 days to procure. The government may elect to provide LLTM or prefabricated assemblies generally kitted via a planning yard. This material procured through sources other than the executing activity should be delivered 30 days prior to start of the availability to ensure that there is no disruption to production.
69	Conduct Work Package Execution Review (WPER)	RMC C300	A-30	A-30	A-30	A-30	A-30		<u>Conduct Work Package Execution Review (WPER):</u> Review of the integrated work production schedule that has been prepared by the Executing Activity. The complete LMA Availability work package is defined and agreed upon at the WPER.
70	Start of Availability	Ship's Force/ MT/ Industrial Activity	A-0	A-0	A-0	A-0	A-0		<u>Start of Availability:</u> The first day of the production period for the executing activity.
<p>Note 1: For Availabilities in excess of \$100M, milestones may need to be established earlier in the planning process to account for the DCAA Audit and other issues unique to the magnitude of the work package.</p> <p>Note2: Milestones may vary from the dollar amounts dependent on the CCO's warrant.</p>									

II-II-2D-21

COMUSFLTFORCOMINST 4790.3 REV C CH-5

APPENDIX D

SURFACE SHIP AVAILABILITY MILESTONES

EVENT #	Task/Milestone	Responsible Activity	CMAV COST	CMAV FFP/IDIQ (Japan)	CME= Execution Start		ADDITIONAL NOTES	DESCRIPTION
CMAV (RMC RESPONSIBILITY)								
These are notional milestones for CM/CMAV packages that are within the TAR threshold. If availabilities are expected to exceed the TAR threshold, the MT shall establish milestones that fit the particular availability.								
							Anything over \$750k must TAR.	
71	Establish CM Availability Schedule	TYCOM	Annually	Annually	NA			<u>Establish CM Availability Schedule:</u> CMAV Schedules are established annually at the fleet scheduling conferences. TYCOM will publish routine updates as they occur for the CMAV schedules.
72	Establish Availability in the appropriate IT system	RMC C300	As Required	As Required	As Required			<u>Establish Availability in the appropriate IT system:</u> Availabilities will be established in the applicable planning data base when known or work is ready to be screened.
73	I-level work package fully brokered	Ashore Ship Maintenance Manager	A-40	A-40	N/A			<u>I-level work package fully brokered:</u> Intent is to fully broker all known Intermediate Level work to I-level by this date.
74	I-level work package fully accepted	RMC C900	A-33	A-33	N/A			<u>I-level work package fully accepted:</u> Intent is for I-level to accept or reject all work brokered to it up to this point in time, work entering later in the process will be subject to normal Business Case Analysis and will likely need to be inducted into the work package as new work.
75	100% of D-level maintenance work package 2Ks locked based on target control.	Ashore Ships Maintenance Manager	A-60	A-60 (A-80)	N/A			<u>100% of D-level maintenance work package 2Ks locked based on target control:</u> Intent is that 100% of the expected AWRs have been screened to the CMAV. The planning activity continually develops specs in the most cost effective manner and does not batch this work in front of the next package development milestone.
76	Solicit Bids	RMC C400	N/A	A-50	N/A		If CMAV is to be performed under an IDIQ contract and is over \$500k, we may need to add 30 days for solicitation IAW Fair Value purchasing policy. This would reset the CMAV solicit bid milestone to A - 70.	<u>Solicit Bids:</u> The Federal Acquisition Regulation designates FedBizOpps as the mandatory "Government wide point of entry (GPE)" for posting of Government business opportunities, including proposed contract actions, solicitations and associated information.

II-II-2D-22

APPENDIX D

SURFACE SHIP AVAILABILITY MILESTONES

EVENT #	Task/Milestone	Responsible Activity	CMAV COST	CMAV FFP/IDIQ (Japan)	CME= Execution Start		ADDITIONAL NOTES	DESCRIPTION
77	100% of D-level maintenance work package 2Ks planned, estimated	Planning Activity	A-50	A-60 (A-30)	E-1			<u>100% of D-level maintenance work package 2Ks planned and estimated:</u> The requirement is that all work brokered by the 100% lock milestone shall be planned to include Work Item complete and LLTM identified and estimated with minimum quality as described as a "Class C" estimate.
78	IGE Submitted in support of 100% lock	RMC C300	A-50	A-53	E-1			<u>IGE Submitted in support of 100% lock:</u> The requirement is that all work Planned in support of the 100% lock milestone shall be estimated by the government with minimum quality as described as a "Class C" estimate.
79	Final Work Item Review/Approval	RMC C300	A-45	A-53	E-1			<u>Final Work Item Review/Approval:</u> Work Item reviews shall be accomplished on a routine drumbeat established by the MT with the final work item review being completed in support of the established publishing date for the specification package. This will include the final quality, technical and contractual review of the work items (contractual shall include legal requirements i.e.; if sole source: is there sole source justification?).
80	Planning Activity "publish" package in the appropriate IT system	Planning Activity	A-45	N/A	N/A			<u>Planning Activity "publish" package in the appropriate IT System:</u> This is the act of issuing a final specification package for the availability that will be used to formulate a proposal. All work after this date will be handled as supplemental and/or new work.
81	Contractor submit final package cost proposal	Contractor	A-35	N/A	N/A			<u>Contractor submit final package cost proposal:</u> This is the date that the Prime contract holder must submit their valid/complete cost proposal. It shall be in compliance with the DCAA's "CRITERIA FOR ADEQUATE CONTRACT PRICING PROPOSALS" associated with an option within the contract in support of a defined scope of work.

II-II-2D-23

COMUSFLTFORCOMINST 4790.3 REV C CH-5

APPENDIX D

SURFACE SHIP AVAILABILITY MILESTONES

EVENT #	Task/Milestone	Responsible Activity	CMAV COST	CMAV FFP/IDIQ (Japan)	CME= Execution Start		ADDITIONAL NOTES	DESCRIPTION
82	Submit I-level work package and schedule to contractor for integration	RMC C900	A-30	A-15	N/A			<u>Submit I-level work package and schedule to contractor for integration:</u> The LMA shall develop an inclusive, detailed, integrated and resource-loaded schedule of all participating activities. All participants shall meet and review the proposed plan and make necessary adjustments to render a balanced and optimized integrated schedule. This formal schedule review shall occur after the WPIC, but no later than the Work Package Execution Review. The NSA/LMA shall serve as the final arbiter of conflicts. By the Work Package Execution Review, all integrated schedule conflicts shall be resolved by the NSA/LMA.
83	BCM and Negotiations Complete	RMC C400	A-22	N/A	N/A			<u>BCM and Negotiations Complete:</u> Negotiation is a procedure that includes the receipt of proposals from offerors, permits bargaining and usually affords offerors an opportunity to revise their offers before award of a contract. Bargaining, in the sense of discussion, persuasion, alteration of initial assumptions and positions, and give-and-take, may apply to price, schedule, technical requirements, type of contract or other terms of a proposed contract. Upon completing negotiations, a price negotiation memorandum must be developed. It should document the purpose and results of the negotiation, the extent to which negotiation objectives were met and the basis for accepting a position that departs from the established objective.
84	Definitize Work Package	RMC C400	A-18	N/A	E-7			<u>Definitize Work Package:</u> The culmination of the contractual planning efforts resulting in a negotiated price for the availability that has been funded via a supplemental agreement. This step contractually obligates both the government and contractor to the requirements of the Work Package.
85	Start of Availability	RMC C300	A-0	A-0	A-0			<u>Start of Availability: The first day of the production period for the executing activity.</u>

APPENDIX D

SURFACE SHIP AVAILABILITY MILESTONES

AVAILABILITY CLOSE OUT - START OF NEXT CYCLE (RMC/SURFMEPP RESPONSIBILITY)						
EVENT #	Task/Milestone	Responsible Activity	CNO	CNO FFP (Japan)	COMMENTS/REMEDIAL ACTION	DESCRIPTION
86	Conduct Departure and Assessment Conference	RMC C300	C+0	C+0		<u>Conduct Departure and Assessment Conference:</u> To verify completion of all work assigned to the availability or to document exceptions. Exceptions shall have a plan for completion with an estimated completion date and must be tracked through completion. This conference will establish the date and conditions under which the TYCOM and NAVSEA will accept redelivery of the ship.
87	Issue Completion Report	NSA	C+60	C+60		<u>Issue Completion Report:</u> NAVSEAINST 4710.8 series details the requirements for availability completion reporting which shall include financial as well as production and exception reporting.
88	SURFMEPP BAWP Close-Out Meeting	MT/ RMC/ TYCOM/ SURFMEPP	C+70	C+70		<u>SURFMEPP BAWP Close-Out Meeting:</u> To identify "A" branded BAWP requirements that were completed, not completed or deferred. To establish requirements for the next FRP Maintenance Cycle and to review outstanding DFS.
89	Verify Completion of Departure Report and Close Out of Avail in the Appropriate IT System	RMC C300	C+90	C+90		<u>Verify Completion of Departure Report and Close Out of Avail in the Appropriate IT System:</u> Purpose is to verify that financial information, AWRs and work items, as applicable, have been uploaded and closed out in the appropriate IT system as required by NAVSEA Standard Item 009-99.
90	Submit Final BAWP Close-Out Report	SURFMEPP	C+100	C+100		<u>Submit Final BAWP Close-Out Report:</u> Purpose is to document the results (including follow up action items) resulting from the Close Out Meeting.
91	Conduct the Corrosion Planning Conference	SURFMEPP	C+115	C+115		Supported by CNSF/TYCOM/SEA 21/CNRMC FLAGS and RMC Commanders.
92	Life Cycle Planning Conference (LCPC) Meeting	SURFMEPP	C+140	C+140	FDNF Yoko A-615	<u>Life Cycle Planning Conference (LCPC) Meeting:</u> The LCPC agenda will include a review of the planning schedule, required CMP assessments, NDE modernization forecasts, CNO Availability services/routines as applicable, organizational responsibilities and DFSs.

II-II-2D-25

COMUSFLTFORCOMINST 4790.3 REV C CH-5

APPENDIX D

SURFACE SHIP AVAILABILITY MILESTONES

EVENT #	Task/Milestone	Responsible Activity	CNO	CNO FFP (Japan)	COMMENTS/REMEDIAL ACTION	DESCRIPTION
93	Upload BAWP task to ship's CSMP	SURFMEPP	C+150	C+150	FDNF Yoko A-605	<u>Upload BAWP task to ship's CSMP:</u> SURFMEPP will upload a data file with all mandatory maintenance actions and expected CNO Availability services into the ship's CSMP in support of ship-specific MT screening and brokering requirements. The data file will span approximately ten (10) calendar quarters and will include the requirements through C+120.
94	Issue Post-LCPC Planning Schedule Letter	SURFMEPP	C+150	C+150	After last CNO Availability Completion	<u>Issue Post-LCPC Planning Schedule Letter:</u> SURFMEPP issue planning schedule letter containing outstanding action items from the LCPC as well as communicating the remaining BAWP-specific JFMM milestones through avail execution.
95	TSRA-5 Discrepancies Screened	Ashore Ships Maintenance Manager	C+360	C+360	Done after intermediate training phase and should be completed 90 days prior to deployment.	<u>TSRA-5 Discrepancies Screened:</u> This event is the final validation of equipment prior to the ships deployment.

APPENDIX E

AIRCRAFT CARRIER NAVY MODERNIZATION PROCESS MILESTONES

Item #	Task/Milestone	Responsible Activity	Milestones are in days					
			Critical	PIA/ DPIA	CIA/ WOO	FDNF SRA	RCOH	PSA/ SRA
1	Issue Advance Planning Letter (APL)	SPM		Approx A-720	N/A	Approx A-720	N/A	Approx A-720
2	Issue Baseline AWP (for PIAs and DPIAs planned for C+3 months from previous availability)	Carrier Planning Activity (CPA)		Approx A-720	Incl w/ PIA/ DPIA	Approx A-480	A-1440	Approx A-720
3	Initial Drawing Shipcheck (approximate)	PY		A-600	Incl w/ PIA/ DPIA	Approx A-480	A-1080	A-600
4	Initiate Procurement of LLTM	NSA/ PARM		A-600	Incl w/ PIA/ DPIA	A-600	A-1080	A-600
5	Populate Baseline Modernization Readiness Assessment (MRA) (no later than)	CPA		A-510	I-360	A-510	A-1440	A-510
6	ICD Delivered to SC developer/PY	PARM		A-420	I-360	A-420	A-780 to A-420	A-420
7	Issue SC Letter of Authorization (LOA) (no later than)	SPM	X	A-360	N/A	A-360	N/A	A-360
8	Begin Monthly Issuance of MRA (no later than)	CPA		A-360	A-360	A-360	A-540	A-360
9	Complete SIDs for NSA SCs	PY	X	A-300	I-180	A-300	TBD	A-300
10	Complete/Deliver SIDs for AIT SCs to NSA/PY	AIT		A-210	I-180	A-210	TBD	A-210
11	Conduct Modernization Readiness Assessment #1 (MRA1)	NSA/CPA		A-210	As Needed	A-210	A-240	A-210
12	Statement of Work due to SRF to support work for AIT and work assigned to SRF			N/A	N/A	A-210	N/A	N/A
13	Complete/Approve SIDs for AIT SCs	PY	X	A-180	I-120	A-180	I-120	A-180
14	If SC is added to the MP after this date, submit LATE ADD REQUEST to TYCOM	PARM		A-180	A-180	A-180	A-180	A-180
15	Initial Platform Certification Decision (IPCD) for C5I installations	SEA 05W		A-150	TBD	A-150	TBD	A-150
16	Submit ILS Certification to CALICo	PARM		A-150	A-150	A-150	TBD	A-150

APPENDIX E

AIRCRAFT CARRIER NAVY MODERNIZATION PROCESS MILESTONES

Item #	Task/Milestone	Responsible Activity	Milestones are in days					
			Critical	PIA/DPIA	CIA/WOO	FDNF SRA	RCOH	PSA/SRA
17	Provide POA&M to NSA/TYCOM	AIT	X	A-120	A-120	A-120	TBD	A-120
18	Complete ILS Certification/Issue ILS Cert Message. Final date for SC approval except for Sustainment Type 1 (ST1) and Sustainment Type 2 (ST2) SCs.	SPM	X	A-120	A-120	A-120	TBD	A-120
19	All Modernization Risk Assessment submitted to TYCOM	PARM		A-120	A-120	A-120	N/A	A-120
20	Conduct Modernization Readiness Assessment #2 (MRA2)	TYCOM/CPA		A-90	As Needed	A-90	N/A	A-90
21	Final date for ST1 and ST2 SC approval or deferral from LOA	SPM		A-75	A-75	A-75	A-75	A-75
22	Issue Risk Assessment Message (results of MRA2)	TYCOM		A-60	As Needed	A-60	N/A	A-60
23	Ensure COP data is compiled and prepared	PARM		I-60	I-60	I-60	I-60	I-60

APPENDIX F**PLANNING PRIORITY MATRIX**

The priority for work item planning completion is set by the required due date for the work accomplishment. This date is established by the Maintenance Team, based on the availability start date minus the required contracting time. The tables below provide guidelines for FFP and PSIA contract vehicles.

DEPOT PLANNING PRIORITY SCHEDULE (FFP)

PRI	TYPE WORK	SPEC EST DUE DATE	PRIORITY SET BY	PLNG SYS	AWARD INTERVAL	COMMENTS/REMARKS
1	EM	“ASAP”	MT-BASED ON EM SKED	NMd	N/A	<ul style="list-style-type: none"> ▪ CAN USE IDIQ IF AVAIL ▪ INCLUDES EM DOCKING (SUSTAIN IDIQ) ▪ OT USE AS NEEDED
2	CM	1-3 DAYS BASED ON SKED	MT-BASED ON CM SKED	NMd	N/A	<ul style="list-style-type: none"> ▪ CAN USE IDIQ IF AVAIL ▪ SMALL PKGS 5-10 SPECS FOR CM SKED AVAILS (10-21 DAYS)
3	CNO	PER ADV PLNG SKED	PLNG-LAST SPEC DUE DATE	NMd	A-60	<ul style="list-style-type: none"> ▪ INCLUDES FFG SHAPEC AVAILS ▪ PLNG START A-360 ▪ BID SPEC REVIEW (BSR) REQUIRED
4	IDIQ UPDATE AND NEW CONTRACTS	PER ADV PLNG SKED	PLNG-LAST SPEC DUE DATE	NMd	A-60	<ul style="list-style-type: none"> ▪ PLNG START A-360 BASED ON CONTRACT EXPIRATION/NEW START ▪ SEE IDIQ LIST FOR CONTRACT EXP DATES ▪ BID SPEC REVIEW (BSR) REQUIRED
5	SERVICE CRAFT	PER ADV PLNG SKED	PLNG-LAST SPEC DUE DATE	NMd	A-60	<ul style="list-style-type: none"> ▪ PLNG START A-360 TO 300 IF POSSIBLE ▪ USUALLY COASTWIDE SOL ▪ BID SPEC REVIEW (BSR) REQUIRED
6	OTHER (TRF, SUSTAIN, DECOM, ETC)	PER ADV PLNG SKED	PLNG-LAST SPEC DUE DATE	NMd	A-60	<ul style="list-style-type: none"> ▪ PLNG START A-360 TO 300 IF POSSIBLE ▪ BID SPEC REVIEW (BSR) REQUIRED

(This Page Intentionally Left Blank)

APPENDIX G
DEPOT PLANNING PRIORITY SCHEDULE (PSIA)

PRI	TYPE WORK	SPEC EST DUE DATE	PRIORITY SET BY	PLNG SYS	AWARD INTERVAL	COMMENTS/REMARKS
1	EM	"ASAP"	MT-BASED ON EM SKED	NMd	N/A	<ul style="list-style-type: none"> ▪ INCLUDES EM DOCKING ▪ OT USE AS NEEDED
2	CM (SCHEDULED)	A-24	MT-BASED ON CM SKED	NMd	N/A	<ul style="list-style-type: none"> ▪ APPLICABLE TO ALL QTRLY CMAVS ▪ SMALL PKGS 5-10 SPECS FOR CM SKED AVAILS (10-21 DAYS)
3	CM (UNSCHEDULED)	A-14 days prior to start	MT-BASED ON CM SKED	NMd	N/A	<ul style="list-style-type: none"> ▪ APPLICABLE TO IN-PORT PERIODS WHEN SHIP IS AVAIL TO PERFORM REPAIRS ▪ CONTRACTOR NEEDS ADEQUATE NOTICE TO PERFORM PRODUCTION SCHEDULING & PLANNING
4	CNO	A-60	PLNG-LAST SPEC DUE DATE	NMd	N/A	<ul style="list-style-type: none"> ▪ INCLUDES ALL CNO AVAILS ▪ PLNG START A-360

(This Page Intentionally Left Blank)

APPENDIX H₁
PROCESS FLOWCHART
FIRM FIXED PRICE CNO AVAILABILITY

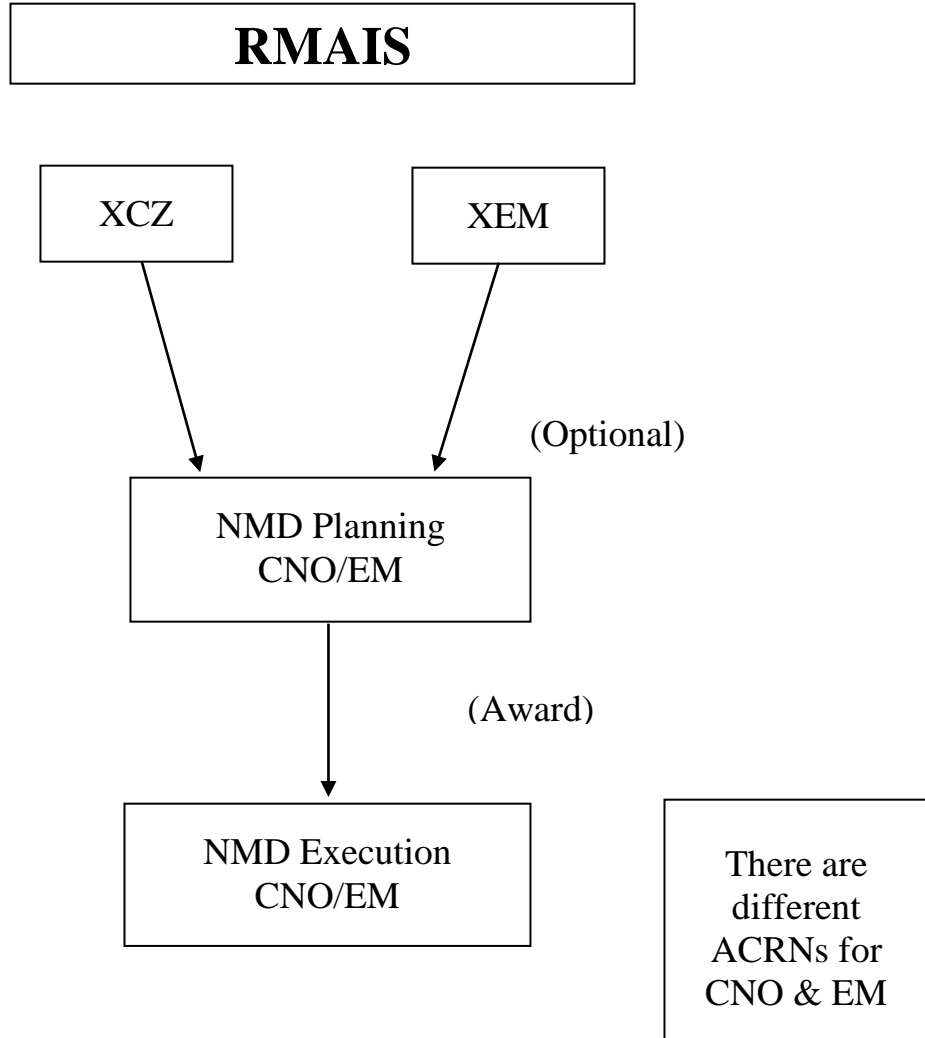

APPENDIX H₂
PROCESS FLOWCHART
FIRM FIXED PRICE CMAV OR EMERGENCY AVAILABILITY

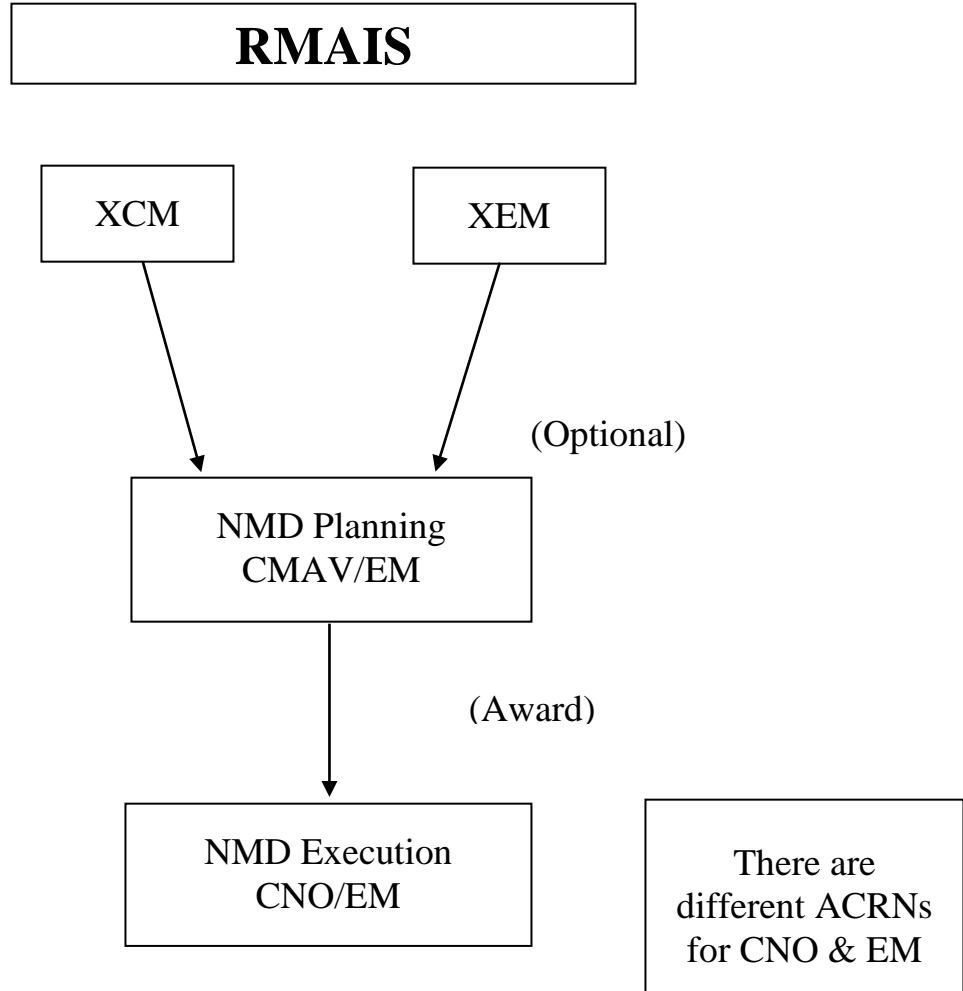

APPENDIX H₃
PROCESS FLOWCHART
FIRM FIXED PRICE PSIA CNO AVAILABILITY

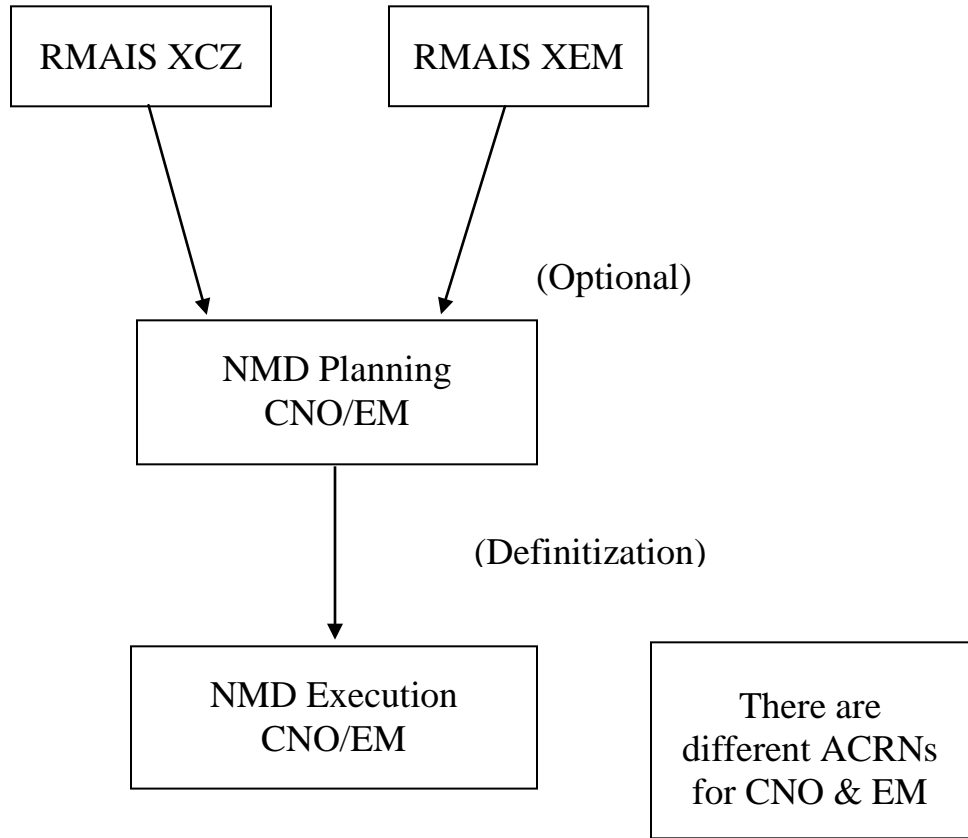

APPENDIX H₄
PROCESS FLOWCHART
FIRM FIXED PRICE PSIA CMAV AVAILABILITY

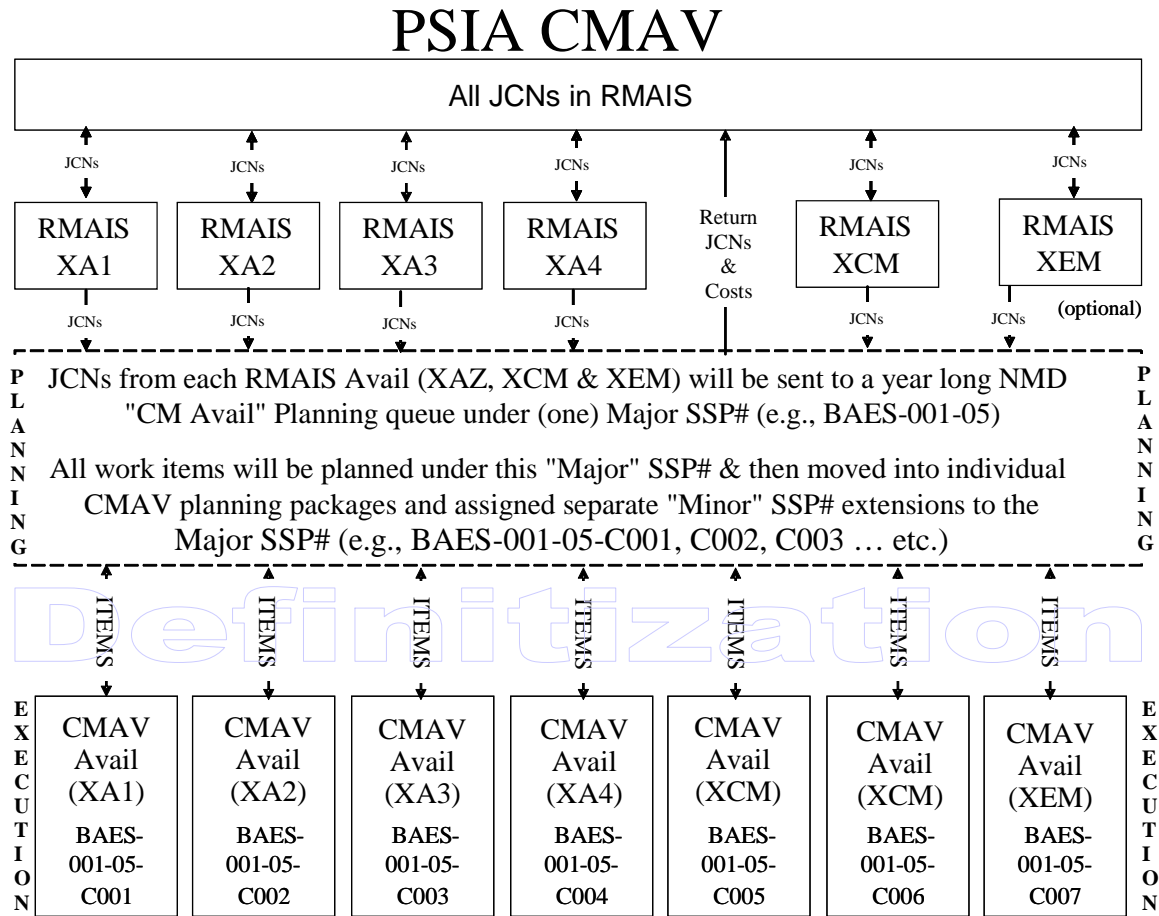

VOLUME II
PART II
CHAPTER 3
MAINTENANCE WORK CLOSEOUT

REFERENCES.

- (a) NAVSEA SI 009-99 - Ship Departure Report; Provide
- (b) NAVSEAINST 4790.8 series - Ship's Maintenance and Material Management (3-M) Manual
- (c) NAVSEAINST 4790.14 series - Ship Departure and Alteration Completion Reports

3.1 **PURPOSE.** This chapter provides procedures and guidance regarding ship and submarine maintenance and modernization work candidate closeout. These rules apply to Maintenance Activities (MA), Maintenance Teams (MT), Regional Maintenance Centers, Fleet Maintenance Activities (FMA), Naval Shipyards, Systems Commanders sponsoring Program Alterations and other Alteration Installation Team sponsors.

3.2 **SCOPE.** This chapter covers the process and responsibilities for closing all Form 4790/2K (2-kilos) work candidates that were screened and brokered to an activity other than Ship's Force.

3.3 **BACKGROUND.** Prior to changes in the work closeout process, 2-kilos executed in shipyards (public and private), by intermediate-level activities, and technical assistance organizations often did not get closed until long after the work was completed, and then often by someone unfamiliar with the actual work accomplished. Additionally, even though shipyards provide completion data in the form of departure reports following an availability, that information was either not captured in Ship's Maintenance and Material Management (3-M) History or captured manually. This means that useful data was not seamlessly making its way into the Navy's maintenance data warehouse. Since this data is used to determine troubled systems, identify trends in system health, identify causes and solutions to expensive growth work, update cost estimates in the Master Specification Catalogs, update return costs in the Open Architecture Retrieval System database, program for future maintenance budgets, identify the most cost-efficient periodicity for scheduled assessments, and identify candidates for alterations or assessments, it is critical that it be captured and made readily available to all users. This chapter provides the required means to close and report accurate completion data for all 2-kilos executed by other than Ship's Force personnel.

3.4 **WORK CLOSEOUT PROCEDURES.**

3.4.1 **Depot Maintenance Activity Responsibilities.**

3.4.1.1 **Private Shipyards Using the Navy Maintenance Database.** Comply with reference (a) for submission of cost and completion information directly in Navy Maintenance Database (NMD) for each work specification and Request for Contract Change (RCC). No other ship departure reports should be created or distributed because stakeholders can print standardized departure reports that contain the required data directly from NMD. Submission of cost and completion information is required within 60 days after the completion of an availability (including Continuous Maintenance Availability), or within 60 days after completion of the work for emergent maintenance or unscheduled continuous maintenance. This data can be entered either directly in NMD Planning or through a computer-to-computer connection to NMD. The MA shall notify the MT when cost and completion information has been entered.

- a. For Surface Forces: If the work item is a Class Maintenance Plan (CMP) scheduled maintenance task or assessment, include the As Found Condition as part of the Final Action code (see paragraph B-2.5.2 of Appendix B to reference (b) for code definitions).
- b. For Submarine Force: If the work item is a CMP (Periodic Maintenance Requirement/Unrestricted Operation), see Volume VI, Chapter 24 and 25 of this manual.
- c. For Firm-Fixed-Price contracts, the completion costs are, by definition, the award costs for original work and the Regional Maintenance Center-approved RCC costs for growth and new work. As such, for Firm-Fixed-Price availabilities, cost information for original work items shall be entered by the Project Manager directly in NMD Execution on the Work Item Management screen cost tab after award, and cost information for RCCs shall be entered by the Negotiator directly in NMD Execution on

the RCC Management screen during RCC settlement. These cost values will populate to the Actual Return Cost screen in NMD Planning and are not editable by the MA. However, completion information (Final Action and Completion Date) must still be entered in NMD just as it is for Cost contracts.

- d. Once the MA enters the required information and the MT closes the availability, NMD automatically prorates completion costs from the work specification to the 2-kilos that make up the specification based on the proportion of the most recent estimates. NMD also submits a “growth 2-kilo” for each completed growth or growth on new work RCC. A growth 2-kilo is used strictly for documentation purposes, getting its information from the “parent” 2-kilo and cost/completion data from the RCC. It requires no additional actions by, and should be transparent to, the MA or MT.

3.4.1.2 Naval Shipyards and Facilities Using Advanced Industrial Management (AIM) or AIM Express (AIMXP). Comply with reference (c) for submitting Ship Departure Reports. AIM (via AIMXP) transmits 2-kilo cost and completion information to the brokering Information Technology (IT) system automatically based on labor entries and material transactions made during availability execution. Users should follow local instructions for AIM operations.

3.4.1.3 Depot Maintenance Activities Not Using Navy Maintenance Database or Advanced Industrial Management. The MA is responsible for providing to the Ashore Ship’s Maintenance Manager (or Immediate Superior in Command for submarines), within 60 days after completion of the work, the man-days, labor costs, material cost, total cost, date completed, and the Final Action code (see paragraph B-2.5.2 of Appendix B to reference (b) for code definitions) for each 2-kilo. At the time of submission, return costs shall be the best prediction of the final costs for that 2-kilo. If the costs are not finalized when the MA reports return cost data (i.e., there are outstanding invoices), report costs from the Final Cost Report or equivalent financial report. Additionally, if the 2-kilo was a scheduled task generated by the CMP, the MA must report the As Found Condition (the second character in the Final Action code).

3.4.2 Fleet Maintenance Activity Responsibilities.

3.4.2.1 Fleet Maintenance Activities Managing 2-kilos Using AIM, AIMXP, Advanced Industrial Management for Regional Maintenance Centers (AIM4RMC) or Tech Assist, Assessments and Scheduling Information Software (TAAS-INFO). AIMXP, AIM (via AIMXP), AIM4RMC and TAAS-INFO transmit 2-kilo cost and completion information to the brokering IT system automatically based on labor entries and material transactions made during 2-kilo execution. FMAs working 2-kilos assigned to these IT systems should follow local instructions for AIMXP, AIM, AIM4RMC or TAAS-INFO operations.

3.4.2.2 Fleet Maintenance Activities Managing 2-kilos Using Logistics Data System. Logistics Data System (LDS) transmits a portion of the required cost and completion information to the brokering IT system. The information that is transmitted can be used to calculate the missing information with a reasonable level of accuracy. Naval Sea Logistics Center has implemented a procedure in Ship’s 3-M History to calculate and fill in the missing information. FMAs should follow local instructions for LDS operations.

3.4.2.3 Fleet Maintenance Activities Managing 2-kilos in a System Other Than AIM, AIMXP, AIM4RMC, TAAS-INFO or LDS. The FMA is responsible for coordinating with the applicable Ashore Ship’s Maintenance Manager, within 60 days after completion of the work, to enter in the brokering IT system the man-days, labor costs, material cost, total cost, date completed, and the Final Action code (see paragraph B-2.5.2 of Appendix B to reference (b) for code definitions) for each 2-kilo. Additionally, if the 2-kilo was a scheduled task generated by the CMP, the FMA must report the As Found Condition (the second character in the Final Action code).

3.4.3 Maintenance Team Responsibilities.

- a. The MT, led by the Ashore Ship’s Maintenance Manager, is administratively responsible for all work screened and brokered to an activity other than Ship’s Force.
- b. Depending on the settings of the brokering IT system, 2-kilos may require both a “Maintenance Activity Completion” and a “Customer Completion” to fully close the 2-kilo. CMP, non-modernization “Z” 2-kilos that originate from the Surface Maintenance Engineering Planning Program (SURFMEPP) will be assigned a “Maintenance Activity complete” closure method, which will allow the task to be closed by the Maintenance Activity upon completion of work and the task Lead Maintenance Activity

be updated in the CMP. The Type Commander Representative (or Immediate Superior in Command for submarines), or Ship's Force shall "Customer Complete" all remaining open 2-kilos executed in the availability no later than 90 days after the completion of an availability (including Continuous Maintenance Availability), or no later than 90 days after completion of the work for emergent maintenance or unscheduled continuous maintenance.

- c. If a 2-kilo was created in the brokering IT system, it may not appear on the ship's Current Ship's Maintenance Project. These 2-kilos may need to be "Customer Completed" by the MT on behalf of the ship.

3.4.3.1 Work Executed by Private Shipyards Using the Navy Maintenance Database. The following steps shall be followed by the MT to properly closeout the work.

- a. After notification that the MA entered cost and completion information data in NMD, but not later than 90 days after the completion of an availability (including Continuous Maintenance Availability), or no later than 90 days after completion of the work for emergent maintenance or unscheduled continuous maintenance, enter Government Furnished Material costs for each specification and RCC in NMD Planning and set the Actual Cost Tab to "Complete".
- b. Change the Avail Status to "Closed" and enter the Closed Date in NMD Execution. This transmits the cost and completion information to the brokering IT system and creates a "Maintenance Activity Completion" for the executed 2-kilos.
- c. Obtain validation that the work was accepted by Ship's Force.
- d. Close any 2-kilos not closed by the ship or auto-closed by the brokering IT system by completing a "Customer Completion". They can be closed individually, or group selected and closed.
- e. When an availability is closed in NMD, all 2-kilos that were in the work package will be closed. It is not possible to keep 2-kilos that were not accepted or not worked from getting a "Maintenance Activity Completion". For that reason, if the work is not acceptable by the end of the availability, a new 2-kilo, referencing the original 2-kilo in the narrative text, should be created to document the remaining deficiencies. This new 2-kilo will then be screened and brokered to the appropriate MA for a future availability.

3.4.3.2 Work Executed by Maintenance Activities Using AIM, AIMXP, AIM4RMC, LDS or TAAS-INFO. These IT systems automatically report cost information and create a "Maintenance Activity Completion" for 2-kilos executed using those systems. The following steps shall be followed by the MT to properly closeout the work:

- a. Obtain validation that the work was accepted by Ship's Force.
- b. Close any 2-kilos not closed by the ship or auto-closed by the brokering IT system by completing a "Customer Completion". They can be closed individually, or group selected and closed.

3.4.3.3 Work Executed by Maintenance Activities Not Using NMD, AIM, AIMXP, AIM4RMC, LDS or TAAS-INFO. 2-kilos executed outside of these IT systems will not automatically have their costs transmitted to the brokering system, nor will a "Maintenance Activity Completion" be recorded. Instead, the required cost and completion information must be entered directly in the brokering IT system. The following steps shall be followed by the MT to properly closeout the work:

- a. Upon receipt of cost and completion information from the MA, enter this information in the brokering IT system and complete a "Maintenance Activity Completion".
- b. Obtain validation that the work was accepted by Ship's Force.
- c. Close any 2-kilos not closed by the ship or auto-closed by the brokering IT system by completing a "Customer Completion". They can be closed individually, or group selected and closed.

(This Page Intentionally Left Blank)

VOLUME II
PART III
FOREWORD

MISSION FUNDED FLEET MAINTENANCE ACTIVITIES

1.1 PURPOSE. Volume II, Part III of this manual provides procedures and guidance which reasonably ensure that accounting for work performed on or for a specific Navy ship's hull, ship class, or reimbursable customer's final product or service applies uniform costing policies and procedures for Fleet Maintenance Activities (FMA). Application of uniform costing practices and procedures is necessary to ensure comparability among FMAs costing procedures, reliability in development of activities' budget requirements and the proper funding of these requirements. The coordination of costing, budgeting and funding requirements will help ensure the maximum benefit from the consumption of resources by the FMAs.

1.2 SCOPE.

1.2.1 Applicability. The guidance contained in Part III of this volume is directive in nature and applicable to each FMA performing work on specific ship's hull, ship class, or reimbursable customer's final product or service and to outside organizations (contractors) performing maintenance work on specific ship's hull, ship class, or reimbursable customer's final product or service. This volume does not currently apply to organic depot maintenance organizations (naval shipyards) when a maintenance availability is conducted by organic assets of the depot facility or the reimbursable customer's order specifies the use of other specifications. It does apply to all contract maintenance work.

1.2.2 Authority. Part III of this volume is directive in nature and may be cited as authority for action as the need dictates. Where higher authority imposes more stringent requirements or conflicts exist, such requirements shall have precedence. Where conflicts exist with previously issued Commander, United States Fleet Forces Command, Commander, Naval Reserve Force, Type Commander (TYCOM) letters, transmittals and instructions, this manual shall take precedence. When such conflicts are identified, they should be reported immediately to the Fleet and TYCOMs for resolution.

1.3 ORGANIZATION.

1.3.1 Basic Principles for Costing Maintenance. In order for maintenance costs records to be accurate, reliable and uniform, several principles must be adhered to:

- a. The individual worker must have a process that guides him or her in accurately charging performance of maintenance. (See Part III, Chapter 3 of this volume.)
- b. The supervisors (shop supervisors, Leading Petty Officers, etc.) and individual worker must be trained so that work can be charged correctly and in a timely manner. This training will provide the craftsman with the basic principle related to identifying direct versus indirect charges. (See Part III, Chapter 3 of this volume.)
- c. The maintenance charges recorded by the individual worker must have proper oversight and supervisory direction to assure management of the accuracy and completeness of the information. (See Part III, Chapter 5 of this volume.)
- d. The worker must be provided the correct charge number prior to commencing work. In the case where an individual worker utilizes multiple charge numbers, the supervisors are critical to ensure the proper charge number is used. (See Part III, Chapter 3 of this volume.)
- e. In order for all levels of management to have confidence that costs are accurate and complete, an appropriate level of independent testing/audit must be performed. The specific metrics and an assessment check list is provided. (See Part III, Chapter 5 of this volume.)

1.3.2 Special Requirements Associated with Maintenance Costing. In the course of accumulating maintenance costs, special actions may be required to achieve certain goals. Other actions not directly related to accumulating maintenance costs are required to assure accuracy and completeness of cost information. Other chapters in this volume discuss these:

- a. Resources (Organization). (See Part III, Chapter 3 of this volume.)
- b. Audits and assessments. (See Part III, Chapter 5 of this volume.)
- c. Retention of records. (See Part III, Chapter 4 of this volume.)

1.4 BENEFITS OF CAPTURING COSTS. In periods of increased competition for limited available funding, it is imperative that budget submissions and other requests for these limited funds be thoroughly justified. One of the more effective means of justifying funding requests is through the demonstration of the benefits and results achieved with previous successful funding efforts. As part of this justification, it is essential that these benefits and outcomes be tied to a specific result, that is in terms of maintenance to specific ship hulls, ship class or customer orders. Direct costs are those expenditures which result in a specific definable benefit to a specific Navy ship's hull, ship class, or reimbursable customer's final product or service. In contrast, indirect cost, while essential at some level, cannot be defined as benefiting a specific outcome. Obviously, it is not reasonable to have zero indirect cost but it is vital that cost that can be identified as benefiting a specific outcome be so identified. Programs that have the minimum indirect cost or overhead are generally looked upon as being more efficient and thus it is far easier to justify resources for efficient programs to support vital maintenance requirements than programs with high overhead.

VOLUME II
PART III
CHAPTER 1
UNIFORM COSTING POLICIES AND PROCEDURES
FOR FLEET MAINTENANCE ACTIVITIES

REFERENCES.

- (a) DoD Financial Management Regulation 7000.14-R - Volume 4, Chapter 21
- (b) DoD Financial Management Regulation 7000.14-R - Volume 4, Chapter 20

1.1 PURPOSE. To provide procedures and guidance necessary to accurately allocate cost for work performed on or for Navy ships, ship classes or customer projects by Fleet Maintenance Activities (FMA). Uniformly applying these costing practices and procedures will ensure comparability among FMAs costing procedures, reliability in development of activities' budget requirements and the highest probability of successfully funding these requirements. The requirements contained in Part III of this volume are directive in nature and mandatory for all FMAs.

1.2 UNIFORM COSTING POLICIES AND PROCEDURES. The following principles and guidelines were applied in establishing these uniform costing policies and procedures:

1.2.1 Function. Each function will be identified as being either a mission overhead (indirect) or a direct cost. Direct costs may be funded by either direct mission funds or by a reimbursable customer as appropriate. Overhead costs will be funded with direct mission funds.

1.2.2 Classification. Reclassification from overhead to direct or from direct to overhead must be fully justified and based on generally accepted accounting principles. Commander, United States Fleet Forces Command authorization is required prior to any reclassification.

1.2.3 Uniformity. The rules contained herein are mandatory, therefore, if all FMAs consistently apply these rules, a significant level of uniformity in their financial operations will be achieved. Where ambiguity exists with this guidance, the activity should immediately report the ambiguity to the Commander, United States Fleet Forces Command for clarifying guidance.

1.2.4 Control. Focus will be on controlling total cost and not the classification of costs. Controlling total cost of maintenance will help ensure the greatest return from the expenditure of the limited funding provided. Adherence to these requirements in this volume by the FMAs should eliminate the issues related to classification of cost, direct versus indirect.

1.2.5 Proration. Accurate costs are desired within reasonable economic considerations. Proration techniques are allowed under strict control when absolutely necessary due to the magnitude of the cost. Proration will be employed only when it is either not possible to accurately classify the cost or too expensive to classify the cost (cost versus benefit).

1.2.6 Unique or New Requirements. Unique customer requirements that result in procedures, methods, etc., which have no foreseeable use for the same or another customers' work, will be charged, in their entirety, to the requesting customer.

1.2.7 Performance. The decision to charge cost incurred to direct or indirect will be completely dependent on the function/operation being performed and not the employee's title.

1.2.8 Direct Cost Basic Definition. Reference (a) defines a production operation as a direct cost center. Direct costs, whether funded with direct mission funds or customer reimbursable funds, are defined as those items that can be identified to a specific ship's hull, ship class, end product or a customer order. Reference (a) also identifies direct costs as including labor of identifiable individual employees, material required for the job, travel and contracts or services required to complete the end product. Costs may be charged direct when the following criteria are met:

- a. Readily identifiable with the benefiting ship's hull, ship class, end product or customer order.
- b. The effort expended is conducive to uniform costing to a specific ship's hull, ship class, end product or a customer order.
- c. Readily definable and appraisable for planning, estimating and authorization of effort to be expended to a specific ship's hull, ship class, end product or a customer order.
- d. An individual employee's hours must be identifiable and measurable to a specific job. You may not prorate labor hours at the end of a shift between direct and overhead or between direct Job Order Numbers. Cost proration within direct is permitted when absolutely necessary to accurately charge costs to the benefiting customers. Proration should be a rare occurrence.
- e. Direct labor may include:
 - (1) Craft and trade skill labor, production support such as crane operators and material handlers, planners and schedulers, project management team members, waterfront maintenance teams and class teams (including clerical support), Engineering Services (including Chief Test Engineers, Assistant Chief Test Engineers, Shift Test Engineers, Shift Refueling Engineers, and Chief Refueling Engineers), Technical Support which includes inspections, certifications, assessments, distance support and on site technical assistance.
 - (2) Direct labor may also include project-related contract and fund administration, including but not limited to: contract managers, contracting officer's representatives, price/cost analysts, cost monitors, and quality assurance specialists.
- f. Where direct charging is indicated but the cost of the effort (including clerical) required for such charging makes it impractical or burdensome (cost versus benefit) and the direct charge is not material to the total cost of the project, the effort should be charged to overhead.

1.2.9 Mission Overhead Costs Basic Definition. Reference (b) states that overhead costs are those costs which pertain to departments supporting production departments. Overhead costs are defined as costs incurred at a FMA that CANNOT be directly identified and charged to a specific ship's hull, ship class, or end product, or customer order, but are necessary for the operation of the FMA.

VOLUME II
PART III
CHAPTER 2
DETAILED COSTING GUIDANCE
FOR FLEET MAINTENANCE ACTIVITIES

REFERENCES.

- (a) NAVSEA 389-0288 - Radiological Controls
- (b) Public Law 109-61 - Emergency Preparedness and Response
- (c) Title 10 U.S. Code - Armed Forces
- (d) NAVSHIPS 0948-045-7010 - Material Identification and Control (MIC) for Piping Systems
- (e) NAVSHIPS 0900-070-6010 - Material Control Standard
- (f) NAVSEA 0900-LP-083-0010 - Naval Shipyard Quality Program Manual
- (g) OPNAVINST 11010.20 - Facilities Project Instruction Manual
- (h) DoD Directive 7220.1 - Regulations Governing the Use of Project Orders

2.1 PURPOSE. The purpose of this chapter is to provide detailed guidance regarding direct versus overhead (indirect) cost charges. While this chapter attempts to address all foreseeable categories of costs, it is recognized that an unforeseen cost category will likely materialize. In that case, please notify the Commander, United States Fleet Forces Command so that the situation may be addressed.

2.2 TYPES OF COSTS.

2.2.1 Accommodation Storage and Handling. Accommodation storage and handling represents the cost of handling and storing ship's equipment and stores taken off the ship when it is in the Fleet Maintenance Activity (FMA) for a conversion, alteration or repair.

- a. Overhead.
 - (1) Accommodation storage and handling, principally warehouse operations, which cannot be specifically identified and conveniently charged on a direct labor basis, shall be charged to the overhead of the performing cost center.
 - (2) Warehouse operations related to accommodation storage provided by Supply Department personnel, which cannot be specifically identified and charged directly to a job order, shall be charged to overhead.
- b. Direct Cost. The handling of a ship's equipment and stores and the subsequent accommodation storage, while the ship is undergoing conversion, alteration or repair, which can be identified with the ship involved, shall be charged direct or to a service type productive job order. When production schedules dictate the presence of a safety monitor during hazardous operations, such as loading/off-loading of military explosives from ships, the safety monitor will be costed direct. Also, includes Q-Cosal actions. Warehouse operations related to accommodation storage for a specific ship's hull, ship class, end product or customer order shall be charged to direct for the specific Job Order Number assigned the maintenance effort.

2.2.2 Administrative Assistance to Managers and Supervisors. Employees are assigned to assist managers and supervisors with administrative duties, paperwork, messenger services, correspondence, scheduling, etc. The duties consist of a number of operations, none of which are normally directly connected with a productive job order. This permits the supervisors to function more actively in a supervisory capacity.

- a. Overhead. Employees assigned as assistants to managers and supervisors shall be considered as overhead personnel and shall be charged to the expense of the parent shop or code.
- b. Direct Cost. When an administrative assistant is performing duties as part of project management or specific to a direct-funded job, such administrative assistance shall be charged direct to the job.

2.2.3 Administrative Services for Tenants.

- a. Overhead. None.
- b. Direct Cost. Administrative services for tenants should be charged direct. Administrative services rendered tenant activities, which can be identified, in sufficient increments of time shall be charged on a direct labor basis.

2.2.4 Allowance List Outfit Material Items - Outfit Supply Activity Furnished Material.

- a. Overhead. None.
- b. Direct Cost. All labor expended in obtaining, receiving, packing, stowing and delivery of Outfit Material items shall be directly charged to Naval Supply funds.

2.2.5 Issue and Return of Anti-Contamination Clothing.

- a. Overhead. None.
- b. Direct Cost. When the cost of issue and return of anti-contamination clothing is identifiable to a specific Navy ship's hull, ship class, or reimbursable customer's final product or service it shall be charged to that effort. All other costs associated with issue and return of anti-contamination clothing shall be charged to a service type job order for prorating to nuclear work customers. The percentages for the prorating are to be determined by the Planning Department.

2.2.6 Funding Support of Board of Inspection and Survey. In accordance with Chapter 20 of the U.S. Navy Regulations, the Board of Inspection and Survey (INSURV) is required to conduct acceptance trials, material inspections, surveys and such other inspections and trials of naval vessels. The regulations also provide that representatives from the systems commands and other naval activities shall assist the INSURV on request. It is recognized that qualified maintenance personnel may be utilized to meet INSURV requirements, therefore, the responsibility for financing these services is established so that INSURV requests will receive prompt and effective response.

- a. Overhead. None.
- b. Direct Cost. The cost of personnel (salaries and overtime) and travel/per diem required by the INSURV to assist in the conduct of trials and material inspections shall be charged to customer funds.

2.2.7 Calibration of Instruments. All instruments, i.e., electrical, electronic and mechanical standards and non-standard instruments are included.

- a. Overhead. The cost of calibration for activity-owned mechanical and electrical/electronic test equipment and calibration standards shall be charged to overhead. Exceptions are as described below.
- b. Direct Cost.
 - (1) The cost of calibration of non-indigenous instruments to Fleet Maintenance Activity (FMA) electrical/electronic and mechanical standards, both local and reference, are to be charged to funds provided by the customer.
 - (2) All calibration of fleet-held electrical/ electronic instrumentation and standards are to be charged to funds provided by the customer.
 - (3) The cost of special calibration performed on test equipment dedicated to specific programs and utilized for those programs will be funded by the appropriate customer.

2.2.8 Clerical and Office Automation Staff.

- a. Overhead. Clerical and Office Automation staff shall be charged overhead, except as provided in paragraph 2.2.8 b. below.
- b. Direct Cost. When the clerical and Office Automation staff services are a significant ingredient to the end product or project and can be identified as directly supporting a project, these charges may be charged to the project.

2.2.9 Administration and Review of Contractor Work.

- a. Overhead. All design administrative services supporting contractor work, which are undertaken in conjunction with and in support of other productive services within the activity, shall be charged to overhead.
- b. Direct Cost. Administrative and technical services supporting contractor work, not in support of other or additional productive effort of the activity, shall be charged to a job order under the applicable customer order. Technical services supporting contractor work and the checking of plans returned by contractors, which is undertaken in conjunction with and in support of other productive services within the activity, shall be charged direct. If the administrative and technical services are in direct support of a specific ship's hull, ship class, end product or customer order, the services shall be charged to direct cost.

2.2.10 Crane Operators.

- a. Overhead. Inside crane operators' time shall be charged to overhead, when not dedicated to a single direct project.
- b. Direct Cost.
 - (1) Waterfront crane operators' and crane walkers' time shall be charged as identified to service-type job orders, or to specific job orders when feasible. Crane operators used in the prefabrication of major ship structures, regardless of location, will be charged to the customer.
 - (2) Crane services necessary for loading and unloading material or parts which, though not directly involved in productive work, have to be removed to permit the performance of productive work on a ship incident to an availability are chargeable to the customer order as a service type productive job order.
 - (3) In the case where the FMA has a contract for the provision of crane services and the specific cost for crane services can be identified to a specific Navy ship's hull, ship class, or reimbursable customer's final product or service, those costs will be charged as direct. In the event that information is not available, the cost of the contract will be charged as an indirect cost.

2.2.11 Special Test and Certification of Cranes.

- a. Overhead. Regular test of cranes performed in accordance with Naval Facilities Engineering Command directives shall be charged to overhead.
- b. Direct Cost.
 - (1) The cost of testing cranes performed at a customer's direction that are outside the time frames or with more stringent requirements than those specified by Naval Facilities Engineering Command directives shall be charged to the customer establishing the requirement. When the more stringent requirement is applicable to a specific type of work or a specific task and more than one customer benefits, the cost will be charged to a service job order and prorated to the benefiting customers on the basis to be determined by the Planning Department.
 - (2) The cost to perform a technical assistance visit to a ship to troubleshoot or perform required test on a ship's crane is a direct charge.

2.2.12 Continuous Process Improvement.

- a. Overhead. Assigned as a Team Member to a process improvement event that is not directly associated with a specific Navy ship's hull, ship class or reimbursable customer's final product or service.
- b. Direct. Assigned as a Team Member to process improvement event that is directly associated with a specific Navy ship's hull, ship class or reimbursable customer's final product or service.

2.2.13 Data Processing Resources. Includes cost of administrating, programming, operating, rental and maintenance of FMA Automatic Data Processing Equipment, supplies and operating Automatic Data Processing Equipment in direct support of activity's Management Information System (MIS) applications and local applications, as well as claimant approved pilot installations.

- a. Overhead. The following categories of Data Processing Resources are considered overhead and properly chargeable to the Data Processing Office or Information Technology Department:
 - (1) All costs identified for operating the various standard activity MIS applications.
 - (2) All costs identified to the development and maintenance of the activity MIS applications as assigned by their major claimant.
 - (3) All costs identified to the programming, testing and debugging of activity MIS improvement Automatic Data Processing (ADP) programs, except hardware, of local programs or the testing of corporate programs commencing at the point at which Central Design Agent provides the package to the activity.
 - (4) All labor costs identified to the implementation of the various activity MIS improvement program applications, (e.g., provide material, support, material requirements, etc.).
 - (5) Rental and maintenance cost including terminal and required ancillary equipment such as uninterrupted power supply.
 - (6) Augmentation to the standard activity MIS computer equipment configuration in support of activity MIS.
- b. Direct Cost.
 - (1) Direct costs are recoverable via direct labor charges and through reimbursement rates when supported by an acceptable method of accounting which clearly identified the time used on various equipment for each job identifiable to a specific ship's hull, ship class, end product or customer order.
 - (2) Systems analysis and programming services as well as equipment rental and ADP material costs when provided for ADP applications which are either the end product or provided in support of activity customers. These provisions are not to be interpreted as authorization to charge activity customers for standard activity MIS reports.
 - (3) All costs where a clearly identifiable industrial customer is the principal beneficiary of the ADP resource, e.g., analysis, programming and associated material identified to the propeller profiler, rental of terminals, timesharing costs used for engineering/scientific calculations.

2.2.14 Decontamination of Equipment and Tools.

- a. Overhead. None.
- b. Direct Cost. The cost of decontamination of equipment or tools identified to a specific Navy ship's hull, ship class, or reimbursable customer's final product or service shall be charged to that effort. All other costs associated with decontamination of equipment or tools shall be charged to a service type job order for prorating to nuclear work customers.

NOTE: DELAY TIME SHOULD NOT BE CONFUSED WITH LOST TIME. LOST TIME OCCURS DUE TO EVENTS THAT ARE SIGNIFICANT OR CATASTROPHIC IN NATURE. LOST TIME IS TIME IN A WORK STATUS PRIOR TO RELEASE CHARGEABLE TO ADMINISTRATIVE LEAVE. FOR SPECIFICS, REFER TO LOST TIME.

2.2.15 Delay Time.

- a. Overhead. None.
- b. Direct Cost. Delay time occurs during the performance of productive work due to inherent causes which prevent the work from being accomplished in the most efficient manner. Delay time is charged directly to the actual work being performed when the delay occurs. Delay time may be a result of internal or external causes.

Examples (1) through (7) are causes of delay time internal to the activity and therefore within the activity's responsibility. Examples (8) through (10) are causes of delay time external to the performing activity.

- (1) Material. Time spent by mechanics waiting for material that should be available or time spent by them in procuring material beyond the designated point of delivery.
- (2) Tools and/or Equipment. Time spent in getting or waiting for tools and/or equipment the use of which should have been anticipated and brought to the job or their delivery scheduled.
- (3) Plans and Instruction. Time spent in waiting for plans and instructions or getting plans from a location beyond the designated point of delivery.
- (4) Waiting for Assist Trade. When an assist has been requested and the mechanic is unable to continue working.
- (5) Waiting for Supervisor.
- (6) Trade Interference. Held up by another trade which is not an assist to the trade held up.
- (7) Minor Power Failures. Time spent due to minor power failures caused by faulty temporary utility connections.
- (8) Waiting for ship to conduct required steps (Tag Out).
- (9) Held up by the ship while conducting a drill or security alert.
- (10) Held up during fueling or ammo handling.

2.2.16 Dive Lockers.

- a. Overhead. Diving services performed within the shop are for planning/administrative management, diving equipment maintenance, diver's life support systems maintenance, training, inspections/quality assurance, boat maintenance/cleanliness and cofferdam inventory control and are charged to overhead.
- b. Direct. Diving services performed outside shop areas are for underwater ships husbandry, dry-docking support of a particular ship and emergency salvage support. These are charged as direct costs to the appropriate productive job orders.

2.2.17 Dosimetry Issuing and Processing. Dosimetry processing is defined in Article 233 of reference (a).

- a. Overhead. None.
- b. Direct Cost. The cost of issuing and processing dosimetry used to monitor personnel radiation exposure shall be charged to the benefiting customer.

2.2.18 Drills - Conducting and Participation. The time and costs for employees vacating the work site during mock and/or actual drill and employees assisting in the drill, i.e., street and building wardens/monitors. It does not include the time and costs of employees whose job is primarily associated with security and prevention such as fire, security and police personnel. These people will charge their normal cost class or function as well as the personnel who are conducting, supervising or administering the drill. Drills include radiological control, communication, disaster preparedness, perimeter security and fire (nuclear and non-nuclear).

- a. Overhead. All labor associated with conducting and participating in drills is considered overhead. Employees should be provided specifics to properly account for this time.
- b. Direct Cost. None.

2.2.19 Dry Dock Blocks and Dock Caps. Dry dock blocks are fabricated, reusable composite concrete and wooden timber structures. Dry dock caps are wooden structures which are appended to the dry dock block.

- a. Overhead. Fabrication or purchase of reusable dry dock blocks or caps.
- b. Direct Cost. Fabrication or purchase of dock wood caps, shapes, wedges, ties and shims to support a specific hull's requirement is charged to customer funds.

2.2.20 Dry Dock Operation.

- a. Overhead. Cost associated with the overall effectiveness of the Dry Dock Operation and not specifically identified to a customer.

- b. Direct Cost. Labor of operators during docking and undocking and while the vessel is in dock, including the costs of cleaning dry docks and caissons, shall be charged on a direct labor basis against the productive job orders (multiple dockings shall be prorated to the respective productive job orders).

2.2.21 Preparation of Engineering Procedures for Specific Authorized Work. Preparation of engineering procedures, such as Nuclear Power Engineering Authorizations, for specifically authorized work shall be charged as follows:

- a. Overhead. The development of engineering procedures for specific authorized work that can be used for other customers.
- b. Direct Cost. The development of engineering procedures for specific authorized customer work is chargeable to the customer authorizing the work.

2.2.22 Equipment Maintenance. The cost of maintenance discussed below includes maintenance of equipment, machine tools, machinery, plant equipment and office furniture. Government Furnished Equipment provided to the activity for use will be maintained in a similar preventive maintenance program.

- a. Overhead.
 - (1) The cost of labor and material incident to preventive maintenance inspection, lubrication and minor adjustments, repair, overhaul and subsequent performance testing of all equipment and their attachments.
 - (2) In the event routine maintenance and inspection indicate the necessity of major overhaul or repair, the maintenance cost will be charged to overhead.
- b. Direct Cost. When the maintenance of equipment is the service being requested by a customer, it will be charged direct. When repairs are due to customer negligence, the customer is responsible. Government Furnished Equipment certification and return of equipment to certification standards will be charged direct. For example: Processing of Hazardous Waste, Oil Waste.

Equipment used in support of a project should be placed in a Ready for Use Condition for the next customer. The customer (last user) is to provide a post-use job order for equipment refurbishment, replacement of worn out, damaged and lost equipment. Customer should also be charged for the labor for sorting and establishing equipment after use.

NOTE: OPERATOR'S COST REQUIRED BY THE EQUIPMENT RENTAL AGENCY TO ACCOMPANY RENTAL EQUIPMENT SHOULD BE CHARGED TO THE SAME JOB/EXPENSE ORDER THAT AN ACTIVITY OPERATOR WOULD BE CHARGED.

2.2.23 Equipment Rental. A lease contract is considered an operating cost of the activity. However, if such a lease is for property or equipment, which may be offered for sale at a certain point in time, the activity may exercise an option to purchase. When this option is exercised, the cost to purchase may be changed from an operating cost to an investment cost. If the cost to acquire title at the time the option is exercised is \$250,000 or more and the item has a remaining useful life of more than 2 years, it is considered a purchased fixed asset, financed using Other Procurement Navy funds. Conversely, if at the time of conversion, the cost to acquire title is less than \$250,000 or the item has a remaining useful life of less than 2 years, such financing will be expensed. Regardless of the amount of credit given toward purchase, rental costs will remain an operating cost as initially charged and costs to purchase will be recorded as a capital investment. It is the responsibility of the maintenance activity to have on hand general purpose equipment to perform the required work.

- a. Overhead. Rental costs of equipment procured because there is insufficient equipment available to meet FMA workload requirements are charged to the overhead of the cost center with functional custody.
- b. Direct Cost. Rental costs of equipment rented to meet a specific customer's unique requirement or to fulfill a specific unique work requirement for a customer are charged as direct costs. The direct charging of equipment rental costs to a specific customer order is limited to the particular customer's requirements. Direct charging of rental costs required to supplement inoperative activity equipment is not authorized.

2.2.24 Disposal of Excess Plant Property.

- a. Overhead. The cost of removing, preparing and transporting of excess Class 3 or 4 plant property to be disposed of, which is incurred prior to acceptance of accountability by the property disposal officer, shall be charged to overhead.
- b. Direct Cost. The cost of preparation for shipment, packing, loading, shipping and transporting incident to reference (b) donations of excess plant property shall be charged to the applicant for such donation. After the property disposal officer accepts accountability for excess Class 3 or 4 plant property to be disposed of, costs incurred are properly chargeable to disposal funds.

NOTE: PARAGRAPH 2.2.25 APPLIES TO NON-GENERAL SERVICES ADMINISTRATION VEHICLES ONLY. FUEL FOR GENERAL SERVICES ADMINISTRATION VEHICLES IS INCLUDED IN THE LEASE COST. GENERAL SERVICES ADMINISTRATION VEHICLES DO NOT USE THE ON-BASE FUEL STATION. FUEL FOR VEHICLES TO SUPPORT SPECIFIC CUSTOMERS (OTHER COMMANDS, PROJECTS) IS A COST REIMBURSABLE DIRECT CHARGE.

2.2.25 Fuel.

- a. Overhead. Fuel such as petroleum products consumed in the generation of power or motor gas, for operating vehicles, weight handling, service craft and other such equipment.
- b. Direct. Fuel shall be charged direct if special delivery arrangements were set up for a particular Ship project where deliveries were made exclusively.

2.2.26 Guarantee Work. Work performed by a maintenance activity shall be guaranteed, i.e., deficiencies attributable to actions of the activity shall be corrected at activity expense. The guarantee applies to work performed and materials procured by the activity, and to Government Furnished Materials and/or equipment only to the extent that the failure and/or deficiency directly results from the activity's acts or failure to act (in area of local responsibility).

- a. Overhead. None.
- b. Direct. When maintenance (Chief of Naval Operations, Continuous Maintenance, Emergent Availability, etc.) is complete the warranty period starts. The Maintenance Team will be notified and take appropriate action.

2.2.27 Incentive Awards Program for Civilian and Military Personnel Assigned to the Activity.

- a. Overhead. All supervisor's efforts and administrative services supporting the incentive awards programs within an individual productive or general expense cost center shall be charged to overhead.
 - (1) Administration. Each activity should provide internal guidance on specific accounting structures for tracking of award programs.
 - (2) Cash Awards. All cash awards are to be charged at the discretion of each activity.
 - (3) Cash Incentive Awards for Military Personnel. These are limited to awards for scientific achievement, inventions and beneficial suggestions. No cash incentive can be given to a military person for performance based on reference (c).
 - (4) Civilian and Military Non-monetary Awards. These awards are to be modest in cost (up to \$100.00 maximum), have no significant utilitarian value (e.g., medal, certificate, plaque, citation, badge, tie-tack, coffee mug, belt buckle or other similar item that carries an honorary award connotation).
- b. Direct. Awards paid on behalf of another activity.

2.2.28 Inspection, Including Non-Destructive Testing.

- a. Definitions.
 - (1) Level I is the highest level of inspection and applies to inspections performed on material identified to Level I in accordance with reference (d) or (e).

- (2) Non-level I inspection is all other inspections identified in references (d) and (e).
- (3) Non-level inspection is authorized for specific material in accordance with reference (f).
- b. Policy.
 - (1) All direct costs incurred in Level I inspections, non-level inspections and controlled industrial material inspections shall be charged to the job and customer order. Overhead type functions (e.g., material handlers, clerks, supervisors, etc.), may be charged direct if dedicated to Level I inspections and the criteria for direct labor are met.
 - (2) Level II and III inspections may be charged direct if the criteria for costing direct labor in this manual are met.
 - (3) Non-level inspection costs will be charged the same as Level I.

2.2.29 Inspection Services. The general principle involved is that the customer is entitled to have the completed work given a normal inspection for proper accomplishment. If the cost of inspection is part of a package, then no additional costs should be incurred by the customer.

When an activity is providing quality assurance and oversight of contractor work as its mission, the quality assurance and oversight effort will be charged to the appropriate funds to support the specific customer.

- a. Overhead. The cost of developing procedures for conducting inspections or other quality control actions or the maintenance of records of such, is an overhead function of the performing cost center except when development of procedures is one time and will not be used for other customers, such work shall be charged direct.
- b. Direct Cost.
 - (1) The cost of inspection or test of productive work and the associated or related engineering or technician costs shall be charged direct when the criteria for direct costs in Volume II, Part III is met.
 - (2) The time of Inspector Foreman, when engaged in the aforementioned inspection duties shall be charged as direct labor.
 - (3) Inspection services performed to determine the productive work to be accomplished shall be charged direct, i.e., services rendered by engineers, inspectors, laboratory technicians and others performing inspection tests, Sea Trials and Dock Trials are also charged direct. Inspection work specifically requested by the customers is considered as a direct cost.

2.2.30 Installation of Equipment.

- a. Overhead. The cost of installation of activity equipment is charged to overhead. Exceptions are noted under Direct Cost. The cost of installation of customer equipment is direct.
- b. Direct Cost.
 - (1) The cost of installation of capital investment equipment (the purchase cost is \$250,000 or more with useful life of at least two years) is charged to the Other Procurement, Navy (OPN) funds purchasing the equipment if the installation is part of the contract (turn key). In-house labor for installation would be overhead funded; material to support installation of equipment would be OPN funded.
 - (2) The cost of installation of built-in equipment associated with a military construction project is Military Construction funded; considered to be part of the bid (elevators, paint booths, etc.).
 - (3) The cost of installation of collateral equipment (Class III & IV) associated with military construction projects is charged to in-house overhead labor for installation unless the purchase cost of the equipment exceeds \$250,000, the guidance provided above in paragraph 2.2.30 a. applies.

2.2.31 Janitorial Services and Work Area Clean-Up.

- a. Overhead.
 - (1) General clean-up details in shop's high security areas not accessed by contractor employees are charged to that shop or shop group.
 - (2) Clean up of approved eating areas shall be charged to the shop or shop group that uses it.
- b. Direct. Productive personnel, when required to clean up their own immediate work areas and/or equipment incident to work on a productive job order, shall be charged direct to the productive job.

2.2.32 Laundry Service.

- a. Overhead. Laundry service for military uniforms related to specific tasks such as color guard, linens for watch standers and shop rags.
- b. Direct Cost. Laundry service, which is provided by outside sources and is in support of customers/multiple ships, shall be prorated and charged to all benefiting customers.

2.2.33 Lean.

- a. Overhead. This includes the permanently assigned staff, as well as those loaned from other shops/departments. If they are located in the Lean Office, they charge to the Lean Office job order. Employees attending Lean events, but not assigned to the Lean Office, will charge to their shop/department's overhead job orders, except as noted below.
- b. Direct. Employees working on a Lean event that are for a specific customer will charge to the project's job order.

2.2.34 Lost and Damaged Tools.

- a. Overhead. All tools that are lost, damaged or require refurbishment after use over a period of time by activity employees.
- b. Direct. Any tool in a Tool Kit that is damaged, needs refurbishment, or is wasted for a reason after being used to accomplish work on a project will be direct charged to the project.

NOTE: LOST TIME SHOULD NOT BE CONFUSED WITH DELAY TIME. DELAY TIME IS CHARGED TO A DIRECT JOB ORDER NUMBER ASSOCIATED WITH A SPECIFIC NAVY SHIP'S HULL, SHIP CLASS, OR REIMBURSABLE CUSTOMER'S FINAL PRODUCT OR SERVICE, OCCURS DURING THE PERFORMANCE OF PRODUCTIVE WORK DUE TO INHERENT CAUSES WHICH PREVENT THE WORK FROM BEING ACCOMPLISHED IN THE MOST EFFICIENT MANNER. (SEE DELAY TIME IN THIS CHAPTER.)

2.2.35 Lost Time.

- a. Overhead. Employees assigned to productive work and prevented from performing such work because of events, primarily unavoidable, but always of a significant or catastrophic nature. This would include but is not limited to, major power plant failures, fire or severe weather conditions that cause most, if not all, productive work to cease. Lost time is charged while the employees are in a working status. If the employees are released from duty, administrative leave would apply.
- b. Direct Costs. None.

2.2.36 Upkeep of Maintenance Equipment.

- a. Overhead. Upkeep costs of equipment used in the maintenance of grounds, streets, roads and walks, including the upkeep of equipment used in the collection of trash and garbage material.
- b. Direct. When maintenance represents the specific service requested by the customer, it will be charged direct.

2.2.37 Maintenance of Nuclear Equipment.

- a. Overhead. The costs of maintenance of equipment used exclusively in the area of nuclear work.
- b. Direct. Equipment used in support of a project should be placed in a Ready for Use Condition for the next customer. The customer (last user) is to provide a post-use job order for equipment refurbishment, replacement of worn out, damaged and lost equipment. Customer should also be charged for the labor for sorting and establishing equipment after use.

2.2.38 Management and Industrial Engineering Studies.

- a. Overhead.
 - (1) Routine management engineering studies undertaken for activity departments.
 - (2) Special one-time studies requiring more than 40 man-hours on the part of Most Efficient Organization and initiated upon the request of the Type I Supply Department.
- b. Direct Cost. A special one-time study for another activity shall be charged directly to funds provided by requesting activity.

2.2.39 Material Handling and Expediting.

- a. Overhead. Those costs related to general material handling, i.e., those persons not directly supporting a specific project, that are responsible for checking, processing, moving and distributing material, shall be charged to the overhead expense of the performing shop. This includes shipping clerks, material runners, expeditors, handlers and equipment operators. The general operators of material stations/centers that support multiple projects are charged to overhead.
- b. Direct Cost.
 - (1) The time of mechanics and helpers devoted to material handling functions shall be charged direct when this work is directly related to the productive work which the employees are assigned.
 - (2) Personnel involved in material expediting and material issue or staging may be charged direct if their time is dedicated to a specific Navy ship's hull, ship class or reimbursable customer's final product or service when it is clearly identifiable to that project. This would include all personnel involved in the operation of a material cage/station that is dedicated to a single project or, individual personnel that are operating out of a multi-project support cage/station, but whose specific individual efforts are dedicated to a single project, e.g., material kitting for a specific availability. Such personnel inside a production shop do not normally meet the criteria for direct charging.
 - (3) At times the activity may be required to receive, store and issue material owned outside the Navy Supply System and the Navy Working Capital Fund, in the categories of Government Furnished Material and NAVSEA or fleet-owned items. All labor and material costs incurred by the FMA in connection with such storage and handling are properly chargeable to funds provided by the owner of the material.
 - (4) Material Inventory Managers or Specialists dedicated to a single project.

2.2.40 Fitness for Duty Medical Examination.

- a. Overhead. When an agency obtains a fitness for duty medical examination (in connection with a separation for medical unfitness) whether by a federal medical officer or an employee-designated physician, there must be no cost to the employee or the Office of Personnel Management. The Comptroller General has ruled that agencies have authority to pay for such medical examinations, which are made by employee-designated physicians under the above conditions.
- b. Direct Cost. Medical examinations required by a specific customer prior to work performance.

2.2.41 Metal Stock Cutting (Bar, Pipe, Plate, Cable, etc.).

- a. Overhead. The function of cutting metal is charged against overhead when the purpose of the cutting is in support of an overhead job because the benefiting customer of the end product is not readily identifiable.
- b. Direct Cost. When the benefiting customer of the end product is readily identifiable, the function of cutting metal is charged against the appropriate direct project.

2.2.42 Acquisition of Minor Property.

- a. Overhead. The acquisition of all minor property. The limit for minor property has been raised to \$250,000.
 - (1) Items of equipment with a purchase cost less than \$250,000.
 - (2) Items of equipment with a purchase cost of \$250,000 or more but with a useful life of less than two years.
- b. Direct. None.

2.2.43 Miscellaneous Expenses of the Production Resources Department Shops.

- a. Overhead. Provides for the accumulation of miscellaneous costs and labor, identifiable with the productive cost centers of the Production Resources Department. Work performed by cost centers outside the Production Resources Department will not be charged to this cost center. This center is primarily established to cover such items as maintaining common use grounds and shipways, printing for shops and maintenance of shop equipment benefiting more than one cost center or more than one common services group cost center. It is the intent of Commander, United States Fleet Forces Command that this cost center be highly restrictive and charged only with those productive expense costs that cannot be identified to a productive shop or common services group cost center. Various Cost Classes will be utilized to meet the correct costing requirements.
- b. Direct Cost. None.

2.2.44 Mock-Up Work. Mock-ups include those full size replicas which are used to facilitate production efforts by saving time or reducing material costs. Included in the cost of mock-ups are the labor, material and other direct costs associated with producing replicas, as the interior of a submarine replica of materials or parts to be test welded, etc.

Mock-ups do not include construction of facilities required for test purposes when such construction requires various levels of approval and special funding as specified in reference (g).

Mock-ups that qualify as plant equipment must follow the rules concerning the acquisition of plant property.

- a. Overhead. The cost of mock-up to reconstruct a specific problem condition such as a mock-up to reinstruct personnel involved in deficient work aboard ship.
- b. Direct Cost.
 - (1) The cost of mock-ups is chargeable to customer funds under the following conditions:
 - (a) It is specifically authorized as chargeable to the initial ship of a class; or
 - (b) Is required for accomplishment of a specific job.
 - (2) If the mock-up will be used for more than one customer or ship, the cost of the mock-up may be distributed to the benefiting customers.

2.2.45 Pilot and Tug Service.

- a. Overhead. The cost of all pilot and tug services (naval and commercial) are the cost of the movement or rearrangement of various types of floating equipment such as sludge barges, wheelerizing equipment, floating cranes, etc., used in connection with FMA support, but not directly related to the immediate productive efforts, will be charged to overhead except as provided herein.

- b. Direct Cost. The cost of the pilot and tug services shall be charged to customer funds, based on a unit rate which includes the costs of maintenance and operation of the naval craft and the rental costs of commercial tugs.
 - (1) For ships (U.S. Navy and Financial Management Supervisor cases) with an assigned Naval FMA availability - the cost of tug and pilot services in connection with the overhaul.
 - (2) For ships without a Naval FMA industrial availability, such as loading/unloading equipment/supplies onto a commercial ship.
 - (3) For ships under construction at the Naval FMA.
 - (4) For assist services provided to activities which have the responsibility for providing pilot and tug services.
 - (5) The costs for movement of the various types of floating equipment discussed in paragraph a. above will be charged to customer's funds when such movements are directly related to immediate productive efforts.

2.2.46 Planning and Estimating Services.

- a. Overhead.
 - (1) Planning and Estimating support personnel.
 - (2) Estimators who provide basic ("boilerplate") estimates used for several customers, e.g., Baseline Cost Estimating Standards Program.
 - (3) Production Resources Department estimators other than identifiable to direct labor.
 - (4) All planning and estimating services in support of estimating potential work that is not subsequently assigned to the activity.
- b. Direct Cost.
 - (1) All planning and estimating services performed for assigned work shall be charged to sponsor funds.
 - (2) Cost of scoping and estimating work assigned to the FMA which is subsequently eliminated at work definition conference or thereafter because of a shortage of funds, rescheduled for ships force, deferred or cancelled because of non-availability of material or funds.
 - (3) Services performed for the Inactive Ship Maintenance Facility in preparing and updating estimates for ship activation during mobilization are chargeable to Inactive Ship Program Funds.
 - (4) Cancellation of work. Paragraph VIII C10 of reference (h) shall apply to any reimbursable order. "Costs incurred in the termination of project orders shall be reimbursable to the performing establishment when such orders are terminated by the ordering component, to the extent such costs do not exceed the amount of the fixed price, or the current ceiling amount in the case of cost reimbursement project orders. In determining termination costs for reimbursement purposes, the performing establishment shall be guided by the principles stated in this directive. When military departments cannot agree on the costs of terminations, the case will be referred to the Assistant Secretary of Defense (Comptroller) for settlement".
 - (5) Preparation of data in support of work to be accomplished by Ship's Force during overhaul.
 - (6) The effort utilized in collating the authorized work into a Ship Alteration and Repair Package, including printing and mailing.

2.2.47 Acquisition of Plant Property Equipment.

- a. Overhead.
 - (1) The purchase cost of an equipment type item costing less than \$250,000 (i.e., minor property) will be expensed to overhead.

- (2) Acquisition of OPN equipment with a purchase cost of over \$250,000 and a useful life of more than two years will be purchased using OPN funds, including transportation, installation, training, discounts, etc.
- b. Direct Costs. Procurement, transportation and installation of equipment specifically authorized to be acquired by a reimbursable order for use in fulfilling the requirements thereof may be financed by the customer. Equipment acquired specifically for a customer in this manner is the property of the customer and will be disposed of in accordance with the customer's instruction.

2.2.48 Pollutant Clean-Up. Naval activities are called upon to remove and dispose of contaminated waste from a variety of sources, e.g., ships under an availability, ships without an availability, general pollution clean-up and ships under the jurisdiction of the FMA. Examples are oil, chemical spills, etc. If the pollution resulted in a fine from the Environmental Protection Agency or other agency, the cost of the fine would be charged in the same way the clean-up is charged. If the clean-up were charged as a direct expenditure the corresponding fine would be charged as a direct expenditure.

- a. Overhead. When the pollution is caused by activity effort, no matter where it occurs, the cost of pollution clean-up is chargeable to overhead. Also, the disposal costs of pollutants will be charged to overhead.
- b. Direct Costs. The cost of clean-up and disposing of pollutants will be charged direct under the following circumstances:
 - (1) When the pollution is caused by the action of Ship's Force personnel, the cost of clean-up will be funded by the ship.
 - (2) When the cause of the pollution is not the activity, and the activity is required to perform clean-up in a non-activity designated area of responsibility, the activity responsible for the area will be required to provide the funds.
 - (3) Disposal cost resulting from pollution clean-up that is chargeable to ship or station is chargeable to the same ship or station as the pollution clean-up.

2.2.49 Pre-Expended Bins.

- a. Overhead. The cost of stocking and replenishing pre-expended bins of items with a unit cost of \$50.00 or less. Items of unit cost in excess of \$50.00 may be authorized by the Activity Commander.
- b. Direct Costs. None.

2.2.50 Printing, Reproduction and Duplication.

- a. Overhead. Charges of all purchased printing, reproduction and duplicating when not chargeable to a project.
- b. Direct. Charges that can be readily identifiable to a project; for example, copies of project drawings.

2.2.51 Programming Effort for Numerically-Controlled Machines.

- a. Overhead. The cost of programming effort for numerically-controlled machines is usually charged to overhead, since they are used by more than one sponsor.
- b. Direct Costs. The cost of programming effort is chargeable to customer funds when the programs are planned for use by a specific program or project.

2.2.52 Purchase of Gas, Liquid or Solid.

- a. Overhead. The cost of natural gas consumed in the generation of power.
- b. Direct. The cost of gas, (argon, nitrogen, etc.) which represents the level of service required for a customer is charged direct.

2.2.53 Radiological Control Engineering.

- a. Overhead. Costs associated with the FMA, whose objective is to ensure the continual over-all effectiveness of the Radiological Engineering effort and not specifically identified to a particular availability, are charged to overhead. For example:

- (1) Preparation and maintenance of local FMA procedures which are formulated to implement directives from higher authority.
 - (2) Evaluation of FMA Functional Area and Radiological Trend Analysis.
 - (3) Training or travel related thereto.
 - (4) Review and evaluation of applicable improvement suggestions.
 - (5) Production support-type work where it is difficult to charge direct.
- b. Direct Cost. Radiological Engineering activities, whose associated costs are clearly identified to a specific availability or would not have been incurred were it not for the presence of that availability, is direct. This activity consists of providing engineering and technical services in direct support of maintaining the radiological control effort of a specified availability. For example:
- (1) Review and concurrence of work instructions, such as Nuclear Power Authorizations or Production Engineering Memos, to verify compliance with applicable Radiological regulations or requirements.
 - (2) Initiation and preparation of Nuclear Power Engineering Authorizations.
 - (3) Preparation and issue of local Radiological agreements between activity arriving ships.
 - (4) Planning and scoping the Radiological Engineering effort for a particular availability. This includes the allocation of resources required to perform this effort, and the identification and analysis of those areas which are unique to this availability and require special emphasis.
 - (5) Direct technical support of the daily in-progress Radiological effort on an availability.
 - (6) The design and modification of radiological containments that are to be used only on a specific availability.

2.2.54 Radiological Waste Processing.

- a. Overhead. Costs associated with activity, whose objective is to ensure the continual over-all effectiveness of the Radiological Waste Processing effort and not specifically identified to a particular availability, is charged to overhead. For example:
- (1) Preparation and maintenance of local activity procedures which are formulated to implement directives from higher authority.
 - (2) Review and evaluation of applicable improvement suggestions. Production support-type work where it is difficult to charge direct.
- b. Direct Cost. The cost of processing should be charged to a Mission Funded Process Shop.

2.2.55 Refueling Equipment. Assembly and certification for use and decontamination, disassembly and preparation for storage (nuclear) of refueling equipment are charged:

- a. Overhead. Cost of preventative and storage maintenance on the equipment while in storage.
- b. Direct Costs. The cost of assembly and certification for use and the decontamination, disassembly and preparation for storage after use shall be charged to the refueling customer orders.

2.2.56 Ripout Material. Ripout of equipment component, etc., is defined as the removal action for accessibility, interference, Ship Alteration or other repair work. It is performed during a specific key operation of the ship's availability.

- a. Overhead. None.
- b. Direct Cost. Costs incurred during ripout operation aboard ship will be charged to the customer job order.

2.2.57 Satellite Steam Boiler. High pressure steam generated from auxiliary steam boilers used for Quality Assurance (QA) test evaluation. High pressure steam may be generated from steam barges, portable boilers, Mobile Utility Support Equipment or satellite steam boilers. High pressure steam is used in the testing phase of the ship's operating system. The steam is not utility steam to provide heat for the ship.

- a. Overhead. The repair and maintenance of the auxiliary steam generating facility is charged to the overhead.
- b. Direct Cost. Costs associated with the operations (and set-up for operation) of the auxiliary steam generating equipment/facility, including fuel and chemicals.

2.2.58 Security Furnished by the Fleet Maintenance Activity.

- a. Overhead. Providing security for the general safety of property including routine services for customers.
- b. Direct Cost. When required by the customer or his agent, the cost of providing special security may be charged to ship project funds. For example, the cost of civilian personnel performing shipkeeper duties, which is usually performed by ship's crews when available, is to be charged to a service job order under the Type Commander's funds. The cost of marines for refueling security, including their travel, per diem, etc., is also direct chargeable to the project they are supporting.

2.2.59 Service Craft and Floating Equipment (Other Than Nuclear).

- a. Overhead. The costs of maintenance of service craft, floating dry docks, camels, dredges, work barges, floating cranes and other floating equipment and costs of miscellaneous overhead functions performed for such craft.
- b. Direct. Only for customer owned items (i.e., United States Fleet Forces Command barges).

NOTE: ACTIVITIES WILL CHARGE OPERATING TARGET FUNDS FOR COST OF TOOLS BORROWED BY SHIP'S FORCE AND NOT RETURNED PRIOR TO COMPLETION OF THE SHIP'S AVAILABILITY. IF OPERATING TARGET FUNDS ARE NOT AVAILABLE (E.G., MANAGEMENT ACTION PLAN SHIPWORK), ACTIVITIES SHOULD OBTAIN FUNDS FROM THE CUSTOMER FINANCING THE MAJOR SHIP CUSTOMER ORDER.

2.2.60 Services in Support of Centralized Tools and Equipment.

- a. Overhead.
 - (1) The cost of labor and material incident to preventive maintenance inspection and normal corrective maintenance including: lubrication, minor adjustments, repair, overhaul, alignment and subsequent performance testing of all machine tools and industrial shop equipment and their attachments under cognizance and inventory control of the activity.
 - (2) Manning and operating of all inside and outside tool rooms.
 - (3) Conditioning and sharpening of all cutting tools, including saws.
 - (4) Heat treating of tools regardless of physical location of the facilities.
 - (5) Procurement initiation, inventory control, maintenance, storage, issue, accountability and development of statistics on tool life, usage, cost and performance of craftsmen's furnished by the activity, abrasion wheels and devices, and special issue of industrial clothing and safety equipment.
 - (6) Minor layouts.
 - (7) The acquisition of safety shoes, safety goggles and lenses (including prescription lenses) and the custody, maintenance and issue of such equipment and other safety equipment.
- b. Direct.

- (1) Purchase or manufacture of tools required for work outside of the activity assigned missions/functions, and such other tools as are necessary to fill a particular need under a specific customer order and their future use on other work is not contemplated. Such tools become the property of the customer and are disposed of in accordance with his direction.
- (2) Overhaul and repair of equipment in the Navy supply system.
- (3) Overhaul and repair of ship equipment and allowance materials.
- (4) Miscellaneous services for the Inactive Ship Maintenance Facility.
- (5) Loaned tools lost or damaged beyond economical repair shall be charged to the customer.

2.2.61 Temporary Services.

- a. Overhead.
 - (1) Maintenance of facilities required to perform assigned functions such as storage bins and racks, work benches, cleaning vats, lines, blowers, ventilation equipment, pumps, etc.
 - (2) Manufacture, stage and store items such as electrical distribution equipment; air, water, hoses, strainers, valves, sewage lift stations built by the FMA, air and water filter systems, chilled water units, refrigeration units (chill and freeze boxes), air conditioning units, heaters, etc., for nuclear as well as non-nuclear. Build/repair tool air hose for the tool rooms. Assemble and maintain emergency response gear (electrical and mechanical) for disaster relief support, nuclear and non-nuclear (spills, earthquakes, etc.)
 - (3) Maintenance work (cleaning, lubricating and minor adjustment of temporary service equipment). This excludes the regular maintenance of equipment which is under the responsibility of Shop 06.
 - (4) Security patrol, emergency response, of temporary service connections provided dry docks and berthing areas shall be charged to the overhead of the performing cost center.
- b. Direct Cost. Cost of installation, connection, maintenance and removal for utilities services such as fresh and salt water, steam and hot water, steam power, hydraulic power, electricity, gas and compressed air furnished ships and communication systems at an activity or off-site location.

2.2.62 Severance Pay.

- a. Overhead. Severance pay costs will be charged to overhead.
- b. Direct Cost. None.

2.2.63 Special Programs (External/Claimant Authorized). To provide a better focus on the costs of this type, only programs specifically authorized by the claimant will be included. Basically, such programs will be approved only if they are directed by the claimant and are not an inherent functional responsibility of a specific department or activity, e.g., activity assignments under the FMA MIS program are usually automated information systems assignments and will continue to be charged as such.

- a. Overhead. The cost of activity-wide special programs that have been specifically authorized for reporting in this category shall be charged to overhead. Each program must be separately identifiable, so that the cost of each individual program can be readily determined.
- b. Direct Cost. None.

NOTE: THE DIRECT COSTING OF SUPERVISION IS NOT ALLOWED WHEN THE SUPERVISION IS OF EMPLOYEES WHOSE EFFORTS ARE FOR A MULTITUDE OF END PRODUCTS OR CUSTOMERS. THE PRORATION OF SUPERVISORY COSTS FOR DIRECT CHARGING, WHERE THE BASIS OF PRORATION IS OF AN ARBITRARY NATURE AND THE TIMEKEEPING EFFORT IMPRACTICAL, IS PROHIBITED.

2.2.64 Supervision.

- a. Overhead. When performing administrative functions, or supervisory functions which cannot be readily identified to one project, the supervisory effort will be charged to overhead.
- b. Direct Cost. Time spent when working on a specific project where the supervisory effort is directly identifiable to the end product. This could include any level of supervision, e.g., project managers, if the effort is identified to one project. This also applies to engineering codes if the supervisor's employees are clearly costed to only one sponsor. Supervisors may not be charged direct to a productive job when working in an administrative capacity.

2.2.65 Consumable Supplies.

- a. Overhead. Consumable supplies, such as x-ray film, tracing cloth and office supplies, including those consumed in the process of serving tenants, shall be charged to the appropriate overhead classification.
- b. Direct Cost. Industrial x-ray film and other specialized consumable supplies issued in quantities that can be identifiable to a specific customer may be charged direct. Direct costs should be easily identifiable items not of the pre-expended bin type.

2.2.66 Operation and Maintenance of Tank Cleaning System.

- a. Overhead. Maintenance costs are charged to the overhead for this equipment.
- b. Direct Cost. Operating costs for productive work will be charged direct.

2.2.67 Telephone Services.

- a. Overhead. The following costs should be charged to overhead:
 - (1) Activity telephone services - all costs including installation/removal, lease lines, basic service, relocation, message units (or current electronic texting devices) and toll charges when the service is for the benefit of the activity will be charged to overhead.
 - (2) Ships with an availability - basic services and toll call charges related to activity's industrial effort will be charged to overhead.
- b. Direct Cost.
 - (1) The following costs should be charged direct:
 - (a) Voice - the charge for toll calls and identifiable additional message units, installation and relocation costs, special services and devices such as data phones, speaker phones, call directors and private leased lines.
 - (b) Data/record - the charges for private line services and leased equipment, such as TWX, TELEX and FACPHONE and off-line message preparation using optical character reading machines or other special equipment when such equipment is not required by the Naval Communication Telecommunication Service Center.
 - (2) Tenant activities and other users - costs in 2.2.67 a.(1) and 2.2.67 a.(2) which can be identified to the users will be charged direct.
 - (3) Cable installation connections for ships with an availability are charged to ship funds. Connections for those telephones needed to coordinate or support the FMA's ship availability work both aboard ship and ashore are chargeable to ship overhaul funds. Connections for additional convenience telephones are properly chargeable to the ship's Operating Target Fund.
 - (4) The cost of telephone services, including cable connections, rentals, etc., including toll calls, rendered to ships in the activity for berthing only, shall be charged to the ship funds.

2.2.68 Issue of Uncontaminated and Contaminated On Return Tools.

- a. Overhead. None.

- b. Direct Cost. When the effort requires the use of a special tool crib and can be readily identified to a specific ship, the costs shall be charged to a service job order and to the sponsors. Proration will be based on auditable, consistent accounting methods.

2.2.69 Training of Personnel.

- a. Overhead.
 - (1) All training on the job by supervisors is a regular duty of supervision and the supervisors' time will be charged to the supervisor's regular job order. Any formal training of apprentices on jobs will be treated as an expense of the job order on which the apprentice is working.
 - (2) Apprentices while attending Apprentice School Training will charge so that the expense is separately identifiable. All other training not associated with the Apprentice School will be charged to overhead.
 - (3) Apprentice Instructors charge overhead in their applicable shop/department.
 - (4) The time of trainees while they are receiving scheduled instruction away from productive work and the instructor's time will be charged as overhead. Related training duties applicable to instructors are the preparation and revision of course and lesson plans and related materials.
 - (5) The training and qualification of personnel to perform special skills, within their cognizance, which are required by advanced technology being applied. Examples are: Train and qualify welders to perform welding in accordance with applicable standards; train and qualify personnel for reactor plant work, i.e., radiological control, quality control and all classroom work to qualify or periodically requalify Shift Refueling Engineers, Shift Test Engineers, Chief Test Engineers, etc. Retraining and requalification are required based on lapsed time.
 - (6) The cost related to sending employees to the equipment manufacturer's plant for in-house training to undergo training for a new product or system shall be treated as an overhead expense. This includes training and qualification of employees to perform special skills, within their cognizance, which are required by advanced technology. In such instances, the costs (travel, per diem and labor) are chargeable to overhead expense.
 - (7) The cost of training after the initial training for a new product or function that has been introduced into the Navy shall be treated as overhead expense.
- b. Direct Cost.
 - (1) Apprentices' time when working (not merely observing or other non-contributive conduct) on productive jobs is chargeable to the job order on which the apprentice is working.
 - (2) The training and qualification of personnel to perform specific functions when such training and qualification is required each time the function is performed is chargeable directly to the benefiting customer.
 - (3) The development and qualification of employees requested by activities outside the activity shall be a direct charge to the requesting customer.
 - (4) It is suggested that, initially, training be provided to state and local government employees on a space available basis and that the activity not require reimbursement for this service. If, however, the scope, frequency or other characteristics of the training requested by the state or local government requires significant alteration to the activity's existing training program, reimbursement should be requested for the costs incurred from the appropriate state/local government.
 - (5) The adaptation of standard activity procedure to specific application is chargeable to the benefiting customer.

- (6) The cost of providing the initial training for new products or weapons systems is chargeable to the organization introducing the new product or system. These costs include instructional material and instructors costs which occur as a result of contracts placed with equipment manufacturers or within the Navy to teach maintenance and repair techniques to employees of the Government. After an initial training for a new product or system has been introduced, the training program is chargeable to overhead.
- (7) Training and qualification of personnel to perform specific functions, when such training and qualifications are required each time the function is performed, is chargeable directly to the benefiting customer. In this instance, the training is peculiar to and identifiable to a specific product or system and expertise is lost through non-use. Examples of this exception include the training of personnel to overhaul/repair unique equipment, which is not within their normal cognizance or expertise, nor is it expected that such unique equipment will be overhauled/repared for other customers in the future. In addition, if a customer imposes additional training or re-qualification of personnel even though the personnel may be properly certified in accordance with current training manuals, then the additional training costs would be properly charged to the benefiting customer.

2.2.70 Traumatic Injuries - Continuation of Pay. When an employee sustains a traumatic injury, Public Law 93-416 provides that the employee can be retained in full pay status for up to 45 calendar days for each injury without charge to leave.

- a. Overhead. The labor cost for employees sustaining traumatic injuries will be charged to a separate overhead job order.
- b. Direct Cost. None.

2.2.71 Utilities for Ships. Utilities, excluding telephone service, include fresh and salt water, steam and hot water heat, steam power, hydraulic power, electricity, gas and compressed air, whether delivered to the vessels proper or used by shore activity personnel in dockside operation.

- a. Overhead. None.
- b. Direct Cost.
 - (1) All utilities for ships with an assigned availability shall be charged to a service type job order based upon utility rates.
 - (2) Utilities for ships not in an availability shall be charged to funds provided for this purpose.

(This Page Intentionally Left Blank)

VOLUME II

PART III

CHAPTER 3

**UNIFORM COSTING POLICIES AND PROCEDURES
RESPONSIBILITIES**

REFERENCES.

- (a) OPNAVINST 4780.6 - Policy for Administering Service Craft and Boats in the Navy
- (b) DoD Financial Management Policies and Procedures Regulation 7000.14-R - Volume 12, Chapter 9

3.1 DIRECT AND INDIRECT COST IDENTIFICATION FUNCTIONS AND TASKS OVERVIEW. Since the consolidation of the Repair Supervisors of Shipbuilding, Conversion and Repair, USN (SUPSHIP) into the Regional Maintenance Centers (RMC), RMCs have assumed responsibility, within their geographic region, for all ship maintenance work contracted for accomplishment by commercial shipyards as well as organic intermediate level maintenance efforts. Along with operational responsibility came the responsibility to prepare and manage financial budgets and budget execution. This chapter provides an overview of the RMC functions and responsibilities regarding uniform costing of direct versus indirect expenditures within the maintenance enterprise. Uniform costing of direct versus indirect is an important tool in the budget process.

3.1.1 Financial Management Organization. The financial management program with regard to maintenance is managed at various levels of the Department of the Navy.

- a. Chief of Naval Operations (CNO).
- b. Naval Sea Systems Command (NAVSEA).
- c. Commander, United States Fleet Forces Command.
- d. Type Commanders (TYCOM).
- e. Ship Commanding Officer/Officer in Charge.
- f. Commander, RMC/Commanding Officer, Fleet Maintenance Activity (FMA).

3.2 ORGANIZATIONAL RELATIONSHIPS FOR FINANCIAL MANAGEMENT OF MAINTENANCE ACTIVITIES.

3.2.1 General. The following sections discuss the basic responsibilities of various levels of the Navy as they affect the financial management of maintenance funding within each organization.

3.2.2 Chief of Naval Operations. The CNO is responsible to the Secretary of the Navy for the readiness, operations and logistics support of all U.S. Naval Forces. As the military chief of the Navy, the CNO is the principal advisor to the Secretary of the Navy and the executive branch of the Government on naval military matters, including funding of ship maintenance. The CNO formulates detailed budget submissions which identify the resources required to carry out the missions assigned to the Navy. These budget submissions are based on detailed support from subordinate commands and include funding requests to Congress for the resources necessary to carry out specific ship modernization, repair and maintenance programs.

3.2.3 Systems Commands.

- a. To provide support for the operating Fleet, the Navy has established five Systems Commands (SYSCOM) with specific support responsibilities. These SYSCOMs are:
 - (1) Naval Sea Systems Command (NAVSEASYSCOM or NAVSEA).
 - (2) Naval Air Systems Command (NAVAIRSYSCOM).
 - (3) Space and Naval Warfare Systems Command (SPAWARSYSCOM).
 - (4) Naval Supply Systems Command (NAVSUPSYSCOM).
 - (5) Naval Facilities Engineering Command (NAVFAC).

- b. The SYSCOMs are responsible for establishing technical requirements and meeting logistics, maintenance and support requirements of Fleet Commanders in the area of new construction and ship maintenance. In addition, these SYSCOMs provide technical requirements for all varieties of maintenance and conduct detailed analyses to determine the proper balance between design improvement and logistics support to achieve the required operational availability.

3.2.4 Naval Sea Systems Command.

- a. For procurement purposes, Commander, NAVSEA, is Head Contracting Agency with delegated authority in the Federal Acquisition Regulation to enter into and administer contracts for materials and services for which the COMNAVSEA is responsible. COMNAVSEA, in turn, has delegated this authority to the Deputy Commander for Contracts (NAVSEA 02). Delegation of authority to the RMC Contracts Department Head is addressed in the NAVSEA Contracts Handbook and in other volumes of this manual. Only COMNAVSEA and individuals designated by NAVSEA 02 who are duly authorized and acting within the limits of their written delegated authority can commit the Government to any contractual action.
- b. As the agent of the CNO, COMNAVSEA maintains the Navy Data Environment and develops documentation for all authorized alterations. COMNAVSEA also authorizes and funds all program alterations not authorized and funded by the cognizant TYCOM. The maintenance, repair and modernization of ships, submarines, craft and boats assigned to the operating forces may be carried out by procurement of services and material from private industry through the RMCs, organic assets of the RMCs, or the Naval Shipyards (organic depot maintenance).
- c. COMNAVSEA is also responsible for developing, validating and maintaining Organizational, Intermediate, and Depot-level maintenance requirements and tasks in the Planned Maintenance System.

3.2.5 The Atlantic and Pacific Fleets. The Commanders, Atlantic and Pacific Fleets under the direction of the Commander, United States Fleet Forces Command are responsible for all aspects of their assigned ships including adequate funding of maintenance requirements. The Commanders must balance the competing needs of funding the operational Fleets with the funding need for maintenance and modernization of the Fleet. Ships and craft under their cognizance comprise the largest portion of the repair and overhaul budget. Fleet Commanders, through their respective Fleet Maintenance Officers, are responsible for the budgeting, scheduling and executing CNO-scheduled ship maintenance and modernization availabilities plus emergent maintenance requirements. Through the respective TYCOMs, the Fleet Commanders provide funding for advance planning and execution of scheduled ship maintenance availabilities.

3.2.6 Type Commanders.

- a. TYCOMs and RMCs are responsible for preparing budget submissions and managing budget execution in support of ship modernization, repair and maintenance availabilities as well as the material readiness and training of their assigned ships. The basis of the TYCOM budget should be historical cost incurred for similar efforts. These historical costs are generated by the RMC/FMA based on direct versus indirect maintenance cost identification. In this regard, the TYCOM is one of the most important activities involved in scheduling and managing ship repair planning activities.
- b. Under guidelines established by the CNO and Fleet Commanders, the TYCOMs and RMC manage funds for advance planning for repairs and some selected alterations, and execution of the availabilities. TYCOMs are responsible for providing advanced planning funds to the respective ships Maintenance Team for availability planning. After the availability work package has been identified and documented, the TYCOM provides a level of funding to accomplish necessary repairs and some of the alterations. Depending on the availability of funds, the funds provided may not be sufficient to accomplish the entire work package.

3.2.7 Regional Maintenance Centers/Fleet Maintenance Activities.

- a. The CNO has delegated authority to RMC Commanding Officers to assign availabilities for ships under their cognizance. The local RMC has overall responsibility for efficient planning, brokering and execution of all ship maintenance and modernization for assigned ships. Contact information for the RMCs can be found in Appendix A of Volume VI, Chapter 2 of this manual. This section outlines RMC/FMA responsibilities related to financial budgeting, execution and reporting.
- b. From a budget formulation perspective, the individual RMC/FMA is the first step in preparing the annual budget submission for ship maintenance. Based on cost incurred in prior periods, the RMC/FMA determines the resources necessary to perform the anticipated level of maintenance effort. The charges passed on to the reimbursable customers form the basis for preparing their budget submission for the maintenance the activity plans for the future period. Therefore, it is critical that all costs are properly classified as direct or indirect. With regard to reimbursable customers, the RMC/FMA is only allowed to pass on direct cost incurred for their project since indirect costs are supported with direct mission funding. If direct costs are misclassified as indirect, the RMC/FMA is not able to recoup the cost of the effort and the customer's historical record shows a flawed lower cost for the effort and consequently future funding requests may not be sufficient to support future maintenance efforts. The RMC will perform the following related to direct versus indirect charge:
 - (1) Providing detailed guidance regarding identifying, charging, classifying, collecting and reporting expenditures related to maintenance cost with the exception of organic depot level maintenance.
 - (2) Review budget submissions from subordinate commands.
 - (3) Prepare budget submissions, with appropriate supporting documentation, for submission to higher headquarters.
 - (4) Provide necessary training and supervision to internal intermediate level resources to ensure the requirements of this manual are implemented.
 - (5) It is the responsibility of the local RMC to provide necessary oversight to subordinate FMAs ensuring the requirements of this manual are executed.

3.2.8 User Commands or Activities (Users). In accordance with reference (a), the CNO assigns service craft and boats to Users. These craft and boats are maintained and overhauled using funds granted by Support Commanders to their subordinate Users activities. Service craft and boats under the cognizance of the Users comprise a portion of the RMC/FMA repair and overhaul workload and the User Commands must provide the required funding through reimbursable orders for the RMC/FMA to maintain the User's assets. For example, the Naval Station Port Operations are assigned service craft that support home ported or visiting ships. When one of these craft requires maintenance the Naval Station Port Operations provides a reimbursable order to the RMC/FMA to provide the required maintenance.

3.2.9 Naval Inactive Ship Maintenance Facilities. The RMC/FMA may be required to support the inactivation of ships scheduled for retention at Inactive Ship Maintenance Facilities. The TYCOM normally authorizes the work and NAVSEA funds such work using reimbursable orders. In some cases, inactive ships may be reactivated for delivery to foreign Governments through the Foreign Military Sales Program. This work is normally authorized and funded by NAVSEA or higher authority using reimbursable orders.

3.2.10 Naval Reserve Force Vessels. Ships assigned for training Naval Reserve Force personnel comprise a portion of the RMC/FMA workload. The TYCOM who has cognizance over these ships authorizes and funds the repair and overhaul work using the reimbursable order process.

3.2.11 Foreign Governments. RMCs/FMAs may interact with foreign Governments, when requested and authorized by the CNO or NAVSEA, to procure commercial repair work to:

- a. Recondition and otherwise repair Navy ships that are to be, or have been, transferred to foreign Governments.
- b. Effect emergency voyage repairs or other services for vessels of foreign Governments, when approved and authorized by CNO.

- c. Unless specific legal authority to price on other than a full cost basis, DoD services and materials shall be priced on a full cost basis in accordance with Volume 12, Chapter 9 of reference (b). In order to accomplish this requirement it is critical the RMC/FMA accurately identify and accumulate direct and indirect cost. Full cost basis requires that the RMC/FMA accumulate all costs associated with the maintenance effort. This includes all direct costs that are normally captured as well as a portion of the indirect cost. In a situation like this, if the system for capturing cost is not accurate, the RMC/FMA may recoup more or less than the cost incurred and if it is discovered later, a refund or additional bill would have to be issued.

3.2.12 Private Companies - Demilitarizing and Stripping. The RMC/FMA may be required to arrange for the demilitarization and stripping of ships that are programmed for disposal or for sale to private concerns. In the case of ships programmed for disposal, these functions, when not performed by the activity having cognizance of the vessel, are carried out by the responsible RMC/FMA. When the ships are sold to private concerns, the work will be performed by the purchasing contractor as a condition of sale. In these cases, the RMC/FMA will be requested to provide surveillance over the work to ensure its proper performance. Of particular concern is the compliance with Environmental Protection Agency rules and regulations where there is potential for environmental impacts resulting from work associated with disposal action. The cost of this surveillance would be considered a direct cost and charged to the contract.

3.3 STANDARDS OF CONDUCT.

- a. Congress has passed numerous laws which place significant controls over funds management such as those identified in Volume VII Chapter 6 of this manual (references (a) through (f)). The Department of Defense has promulgated additional regulations in the form of reference (b). Practices that may be acceptable in the private business world regarding funds management are not necessarily acceptable for naval personnel. Individuals who manage, control, expend or report on government funding are held to high standard regarding the control of those funds. In order to accomplish the intent of these legal requirements it is critical the RMC/FMA accurately identify and accumulate direct and indirect cost.
- b. All personnel shall exercise special diligence to prevent fraud, collusion, larceny, embezzlement or other improper conduct within the area of their responsibilities and shall report immediately to the RMC Commanding Officer any instance of fraud or other improper conduct they observe or suspect. Failure to accurately record expenditures could be considered improper conduct in certain circumstances.

VOLUME II

PART III

CHAPTER 4

RETENTION OF FINANCIAL RECORDS

REFERENCES.

- (a) SECNAV M-5210.1 - Records Management Manual, Part III Chapter 7
- (b) DoD Financial Management Regulation Policies and Procedures 7000.14-R - Volume 1, Chapter 9
- (c) National Archives and Records Administration General Records Schedules, General Records Schedule 8 - Stores, Plant, and Cost Accounting Records, Transmittal No. 13, September 2004
- (d) National Archives and Records Administration General Records Schedules, General Records Schedule 8 - Stores, Plant, and Cost Accounting Records, Transmittal No. 8, December 1998

4.1 PURPOSE. This chapter provides guidance and policy for maintaining and retaining financial records related to the charging of direct and indirect maintenance expenditures.

4.2 GENERAL. Maintenance cost records provide a historical record of financial resources required to perform a specific level of maintenance and the cost history of repairs and alterations performed on individual ships of the fleet. These records must be accurate and complete so as to "stand alone", that is, the record will be understood without additional explanation. These records will provide a basis to estimate the cost of similar efforts in the future and preparing and supporting future budget requests. Records will be maintained for direct mission funded efforts, indirect mission funded efforts, and reimbursable orders.

4.2.1 Maintenance Cost Record Requirements. The process of maintaining financial related records can affect the perceived validity of completed financial record. If the process used to maintain the financial records appears to have inadequate controls, then the accuracy and completeness of the information produced will be questionable. In order to maintain confidence in Fleet maintenance financial records, and to provide the necessary support for budgeting, the following record keeping rules are specified:

- a. When recording labor or materials against a specific Job Order Number it is critical that all entries be legible and in ink. Erasures, write-overs, white outs, ditto marks, continuation arrows, signature stamps, etc., are not acceptable. When corrections are required the employee must initial all changes.
- b. Neatness and readability of the original record is paramount. Copying records to "make them neat" is prohibited. Original documentation must be maintained to support summary reports.
- c. When an error is made, it will be corrected by drawing a single line through the error, recording the correct entry, initialing and dating the correction. This allows the original record to be available and provides an audit trail through the entire process.
- d. When a questionable item is identified, research will be initiated to determine the validity of the item. The research will be fully documented and if the research determines the original item was correct or incorrect, that will be clearly identified and the documentation will fully explain the decision and be added or appended to the original record as appropriate.

4.2.2 Record Retention in General. The following paragraphs summarize the general requirements for retaining financial records and how long they will be retained:

- a. Records required to be maintained for periods exceeding 12 months may be reduced in size (such as by microfilming or CD-ROM in .pdf format only). However, the Fleet Maintenance Activity (FMA) responsible for the record will ensure that the reduced size records are clearly legible, reproducible, and will so certify prior to destroying the original records. The following procedure will be followed for record reduction:
 - (1) Record reduction shall be in accordance with reference (a).

- (2) Compare the reduced size record against the original record to ensure each page of the original record has been reduced, is clearly legible and reproducible. This comparison shall ensure that the front and the associated back of documents have been reproduced.
- (3) Reproduce two randomly selected pages of the reduced record into paper copy. Verify completeness and legibility of reproduced pages by comparing against the original record.
- (4) Person making comparison will sign the logbook or some other permanent record to certify that the reduced size record is complete and legible after being reproduced.

b. After steps (1) through (4) above are satisfactorily completed, the original record may be destroyed.

4.3 IMMEDIATE SUPERIOR IN COMMAND RECORD RETENTION.

4.3.1 Financial Record Retention. Copies of documents used to provide maintenance funds to FMAs and Immediate Superiors In Command will be retained in accordance with reference (b).

4.3.2 Inspection Record Retention. Copy of last Immediate Superior In Command or Type Commander inspection of the FMAs financial records including copies of discrepancies identified, root cause analysis performed and corrective action implemented.

4.3.3 Command Evaluation and Independent Audit Record Retention.

- a. Records of command evaluation reviews related to financial management will be retained for 5 years after cutoff of corrective actions as required by references (b) and (c).
- b. Copy of last independent audit (if any) of FMA financial management procedures and processes.

4.3.4 Assessments, Evaluations and Audits. The Financial Management Officer will retain records of assessments and evaluation for the past 24 months (unless otherwise stated). The records will consist of:

- a. A log will be maintained of all Financial Management Discrepancy Forms, Part III, Chapter 5, Appendix E of this volume. Financial Management Discrepancy Form, Part III, Chapter 5, Appendix E of this volume identifies the Job Order Number reviewed, work center responsible, discrepancy identified (if any), corrective action to be taken, and estimated date corrective action is expected to be complete.
- b. Copy of last higher authority assessment and the corrective action for all discrepancies identified.
- c. Results of all reviews of the financial reporting program, including the corrective action taken or pending. (This may be kept with the rest of the monitor program records.)
- d. Last annual evaluation of the financial reporting program performed.

4.3.5 Training. Each employee will be trained on how to accurately charge their labor and materials to direct and indirect Job Order Numbers. Records related to this training will be retained in accordance with Type Commander or Immediate Superior In Command instructions.

4.4 FLEET MAINTENANCE ACTIVITY FINANCIAL MANAGEMENT RECORD RETENTION. Financial records, including those focusing on direct versus indirect costs, will be maintained for 3 years, in accordance with references (b) and (d). Reference (b) requires the financial information "be maintained for at least the minimum period specified in the applicable National Archives and Records Administration General Records Schedules and longer if compelling reasons exist or supplemental guidance directs". The specific records addressed by this volume relate to cost accounting which must be maintained for at least 3 years from the date the actions are closed.

4.5 LOST RECORDS.

- a. In the event that it is determined that some portion of the financial records have been lost and/or destroyed, an investigation will be performed to document the circumstances. The RMC/FMA Commanding Officer will appoint, in writing, an investigating officer. The written appointment will identify, in detail, the lost records and the circumstances, as they are known. The investigating officer will make sufficient inquiries to determine the most likely disposition of the records.

- b. The investigating officer will prepare a written report to the Commanding Officer, detailing the results of the investigation. The report will include recommendations designed to correct the control weakness that allowed the records to be lost.

(This Page Intentionally Left Blank)

VOLUME II
PART III
CHAPTER 5
FINANCIAL AUDITS, EVALUATIONS AND ASSESSMENTS

LISTING OF APPENDICES.

- | | |
|---|---|
| A | Vertical Audits |
| B | Horizontal Audits |
| C | Checklist for Evaluating Direct versus Indirect Costing |
| D | Financial Management Audit Discrepancy Form |
| E | Financial Management Discrepancy Form |

5.1 PURPOSE. This chapter provides requirements, procedures and criteria for audits, evaluations and assessments regarding direct versus indirect expenditures incurred by the Fleet Maintenance Activities (FMA). The expenditures include both Direct Mission Funded Resources and funds received through reimbursable orders and the provisions of this chapter apply to both.

5.2 GENERAL. An effective command evaluation program is essential to ensure the accuracy and completeness of the cost data associated with maintenance efforts. Audit, evaluation and assessment programs are objective, constructive tools to monitor the accuracy and completeness of the maintenance cost data collected. These same tools also evaluate the effectiveness and efficiency of the collection process. The purpose of the command evaluation program is to determine the activity's compliance with established directives and their ability to capture and correctly classify the overall cost of maintenance and provide an opportunity to correct any discrepancies. The command evaluation program must be flexible and dynamic. Focusing on specific areas of interest or current issues should be done on a regular basis to increase the benefit of the audit. Focusing reviews would prove most beneficial when the activity is involved with infrequent repair efforts, components with an abnormally high cost of maintenance or first time repair efforts. Review guides should be developed which lend themselves to evaluating recent command, division or cost center efforts related to identifying the accuracy and completeness of direct versus indirect expenditures. The involvements of the highest levels of the command are essential to ensure the Department of the Navy gets the greatest return from the limited maintenance funds available.

5.2.1 Audits. Audits are an independent systematic comparison of financial cost reports with the supporting documentation to ensure the accuracy and completeness of maintenance cost reported to higher headquarters and used to support budget requests. Different types of audits may be performed depending on the area to be audited and the purpose of the audit. The general audit categories are as follows:

- a. Vertical Audit. These audits review all aspects of the cost of one repair/maintenance action or Job Order Number (JON). They track the maintenance task from inception to completion. This is done by verifying all cost aspects of the technical, material, process and documentation requirements associated with the work. These audits include attributes covering the entire spectrum of the cost charged to the effort. Reviewing the direct versus indirect charging of cost will be just one part to the audit. Appendix A provides guidelines for the preparation and execution of vertical audits.
- b. Horizontal Audit. These audits are conducted on only one specific area or aspect of the direct or indirect cost program (e.g., material charges or a specific category of labor on multiple JONs, administrative efforts within the activity, etc.). They focus on the particular area and do not track a complete JON from inception to completion but rather track expenditures across the activity for a specific function. Appendix B provides guidelines for preparation and conduct of horizontal audits.
- c. Repeat Findings. Once an audit is conducted and findings are identified, it is expected that the command will take action to correct the identified discrepancy and institute controls that will prevent reoccurrence of the condition. If during the course of an audit a repeat finding is identified, the recommended corrective actions must be addressed to the Immediate Superior In Command (ISIC). A repeat finding is one that was identified in the preceding audit.

5.2.2 Evaluation. The results of evaluations provide the Commanding Officer with an unbiased review of the overall accuracy and completeness of cost reported. Based on these results the Commanding Officer can, if discrepancies are noted, make an informed decision to apply additional emphasis or resources against the program to improve the condition. If the results of the evaluation reveal no significant discrepancies then the Commanding Officer has independent verification of the effectiveness of the function.

5.2.3 Assessments. Assessments are an external programmatic review of processes to ensure compliance with parent directives. The assessment could include a review of the accuracy and completeness of direct versus indirect costing. Assessments are normally conducted by the activity's Type Commander or ISIC with participation of other commands if the Type Commander or ISIC determines additional expertise is necessary.

5.2.4 Key Elements of an Effective Command Evaluation Review. Fleet Activities will use, as a minimum, the following key elements to assure the effectiveness of their command evaluation program.

- a. Conduct training for all personnel assigned to the command evaluation effort on techniques for preparation, execution, documentation and the evaluation of findings prior to conducting an audit for the first time. Subsequent evaluations, performed with experienced personnel, will only require refresher training. The training should be adequately documented in order for other independent reviewers to ascertain what was and who were trained.
- b. Development and use of attribute sheets/guides. These should be based on key attributes from the source documents and are not meant to limit the scope of the review.
- c. Develop a thorough review process focusing on previously identified audit deficiencies to disclose potential adverse trends and recurring deficiencies.

5.2.5 Record Retention. The retention of records for audits will be in accordance with Part III, Chapter 4 of this volume.

5.3 RESPONSIBILITIES AND PROCEDURES.

5.3.1 Fleet Maintenance Activity Audit and Evaluation Program.

- a. Audits. FMAs will schedule and conduct the following command evaluation audits:

NOTE: IF YOU ONLY OBSERVE PERSONNEL WORKING ON SHIPS, EXPECT TO FIND VIRTUALLY 100% DIRECT. THEREFORE, WHEN SELECTING THE PERSONNEL TO OBSERVE, ENSURE YOU GET A REPRESENTATIVE SAMPLING.

- (1) Annual audits to be conducted:
 - (a) Perform an evaluation of the percentage of direct versus indirect expenditures using Appendix C as a guide. Identify and evaluate any unusual results in order to determine the root cause of the anomaly. Also, based on the results of this review, evaluate whether it is possible to economically reduce the indirect percentage. The command is required to review the percentage of indirect expenditures on a monthly basis and report that information to the ISIC.
 - (b) Perform an audit on the accuracy of charges direct versus indirect. This will involve observing the recording of cost against selected JONs.
- (2) Perform post closeout audit of the expenditure charge for selected Controlled Work Packages (CWP). Determine if the total direct expenditures recorded were within the range of what was expected. The CWPs selected should be representative of the maintenance efforts performed during the period.
- (3) Written audit guides shall be used for each audit. The activity performing the audit will develop audit guides based on the unique nature of the audit planned. The audit guides should be tailored and customized for the specific organization or area being audited. One successful technique is to acquire a collection of audit findings from other FMAs and incorporate these into the audit guides. Once an audit guide is prepared, it will be filed and reused when similar audits are performed. It is also recommended that the FMAs share audit guides.

- (4) The results of each step in the audit guides will be documented sufficiently to support the final conclusion/finding.
 - (5) Audits should be conducted on an annual basis unless a shorter period is specified. Those areas identified as weak should be followed-up on more frequently. The periodicity of these audits shall be adjusted by the Financial Management Officer (FMO) based upon the results of previous audits.
 - (6) Report results of all audits to the Commanding Officer with copies to the FMO and cognizant Department Head/Division Officer.
 - (7) A copy of the final report will be provided to the Commander, Navy Regional Maintenance Center or appropriate ISIC after the FMA Commanding Officer has accepted and implemented the corrective actions.
- b. Evaluations. The FMA FMO will conduct a semi-annual evaluation of the overall adequacy and effectiveness of the FMA's direct versus indirect program. This effort is less than an audit, requiring less documentation and of shorter duration. The results of this evaluation will provide an indication of the effectiveness of the program. If the results indicate a significant, widespread problem the evaluation will be expanded into an audit.
- (1) Results of this evaluation will be provided to the FMO, appropriate Department Head, and Commanding Officer if the results indicate a significant problem.
 - (2) A copy of the final report will be provided to the Commander, Navy Regional Maintenance Center or appropriate ISIC after the FMA Commanding Officer has accepted and implemented the corrective actions.

5.3.2 Management Metrics for Direct Versus Indirect Costing.

5.3.2.1 Metric Number 1, Total Indirect Time.

5.3.2.1.1 Activity Goal. Recognizing that establishing an activity goal for indirect cost before the FMAs have had an opportunity to evaluate and implement the guidance is arbitrary and will probably require adjustment after more detailed information is accumulated. The initial goal for indirect expenditures is 10% of total expenditures. Total expenditures are the sum of total direct mission funding plus the total of reimbursable order expenditures. This metric is computed at the organizational level.

5.3.2.1.2 Activity Level. On a monthly basis, the financial manager will determine the total expenditures for the overall FMA; this includes both direct mission funding expended and reimbursable order funding expended for the period. Based on the collection of cost information using the guidance in Volume II, Part III of this manual, determine the total indirect cost reported by the FMA for the period. Using this information and the following formulas, determine the percentage of expenditures which are attributable to indirect efforts. The following formula will be used:

$$\begin{aligned} & \text{Direct Mission Funds Expended} \\ & \text{Plus + } \underline{\text{Reimbursable Order Funding Expended}} \\ \text{Equals = } & \text{Total Expenditures by Maintenance Activity for Period} \\ & \text{(Total Indirect Expenditures for Period) Divided by/} \\ & \text{(Total Expenditures by Maintenance Activity for Period)} \\ \text{Equals = } & \text{(Percentage of Indirect Expenditure for Period)} \end{aligned}$$

If the total indirect percentage exceeds the goal, the FMA should determine what events caused the increase. The FMA should identify what actions are necessary to bring the indirect into the acceptable range. The results of the evaluation will be provided to the Commander, Navy Regional Maintenance Center not later than the 15th day following the close of the month.

RATINGS: GREEN 10% or less RED More than 10%

5.3.2.2 Metric Number 2, Direct Positions Charging Indirect.

5.3.2.2.1 Activity Goal. The goal of the FMA with regard to direct versus indirect costing is to minimize indirect expenditures. Minimizing indirect expenditures will help maximize the return that the Fleet gets from resources committed to maintenance efforts. The FMA is staffed with personnel who are primarily working on direct maintenance efforts and some personnel who would primarily be performing overhead assignments. For personnel who are primarily working on direct maintenance efforts, occasionally they will be required to charge their efforts against an indirect Job Order Number (JON). Charging personnel who are primarily assigned to the activity to perform direct maintenance efforts against indirect JONs should be minimized. Therefore, another metric that should be measured is the amount and percentage of indirect cost generated by personnel in direct maintenance positions.

5.3.2.2.2 Activity Level. On a quarterly basis, obtain a listing of all personnel who charged to an indirect JON for the preceding month. Determine if personnel who normally work on direct maintenance efforts are identified on the list. If any of the direct personnel charged over 10% of their available efforts to an indirect JON, determine why the indirect JON was used. Document the results. If the charges were inappropriate, document corrective actions taken to prevent a reoccurrence of the error.

Using the same listing, review the charges for personnel who potentially could have charged a direct effort, such as contract specialists, and identify their direct charges for the period. Determine if there were other opportunities for them to charge a direct JON.

RATINGS: GREEN 10% or less RED More than 10% without
adequate explanation

5.3.2.3 Metric Number 3, Indirect Charges Against Reimbursable Orders.

5.3.2.3.1 Activity Goal. The FMA is allowed to pass along all direct costs incurred in the completion of a reimbursable order. Those costs include materials, direct labor, and contracts or any other cost that must be incurred to complete the work requested. All indirect costs must be borne by the activity using direct mission funding. The indirect cost must be captured because in certain instances, such as performing work for private parties or foreign government, they must be recouped.

5.3.2.3.2 Activity Level. On a quarterly basis, randomly select 5 reimbursable orders which were completed during the period. Evaluate the cost that was charged to them to determine if any indirect costs were charged to the efforts. If as a result of the evaluation it is determined that indirect cost has been improperly charged to the reimbursable orders reviewed, document the control that failed and the actions taken to prevent future inappropriate charges against reimbursable orders.

Using the same 5 reimbursable orders, review the charges for personnel who would normally charge an indirect effort, such as administrative staff, and identify their direct charges for the period. Determine if those charges were appropriate. This test provides assurance that the direct charges reported are supportable.

RATINGS: GREEN 0 RED More than 0

5.3.3 Immediate Superior In Command Financial Management Assessments and Audits.

- a. Financial Management (FM) Program Assessment.
 - (1) The ISIC shall schedule and conduct a financial management program assessment periodically, but not less than annually of all assigned Regional Maintenance Centers (RMC)/FMAs. This assessment will review the following areas:
 - (a) Vertical audit of selected JONs.
 - 1 Material charges to those JONs.
 - 2 Contract charges to those JONs.
 - 3 Evaluate whether direct versus indirect cost charging training for personnel working on those JONs was conducted.
 - (b) Review selected FM records to determine that they are complete and retention is in accordance with regulations.

- (2) Copies of the assessment reports will be provided to the RMC/FMA Maintenance Officer and the FMA Commanding Officer. Written responses will be provided by the FMA Commanding Officer if any significant findings or if findings of an unusual or serious nature were identified.
 - (3) Copies of the assessment reports will be forwarded to the ISIC Maintenance Officer, to include the FMA Commanding Officer's comments, if there are any significant findings or if findings of an unusual or serious nature are found requiring corrective action by the ISIC or higher authority.
- b. ISICs will conduct the following additional periodic audits:
- (1) Conduct periodic monitoring of RMC/FMA direct versus indirect cost charges related to controlled work and on all assigned ships during maintenance availabilities.
 - (2) Conduct monitoring of assigned FMAs direct versus indirect cost charges. This monitoring will include:
 - (a) Review of direct versus indirect cost charges procedures including practices related to opening and closing of maintenance efforts.
 - (b) Monitoring of direct versus indirect cost charges for progress work both on tended ships and in FMA work centers.

5.4 REPORTING AUDIT RESULTS AND CORRECTIVE ACTION.

5.4.1 Reporting Requirements for External Audits and Assessments.

- a. **Audit Reports.** Each finding should be a concise statement of the situation, complete to the extent that it will stand on its own as a summary of the condition. It should include the requirement for defined corrective action where discrepancies are identified. A discussion should generally be included to amplify the nature of the finding. If not included in the finding, identify positively what directives were violated. Audit findings will be reported using the format of Appendix D. Each finding will provide space for the command response to the recommended corrective action, which includes a root cause/immediate corrective action/permanent corrective action, and when returned to the originator, ensuring the single document provides the complete record of the finding and actions taken. The ISIC cover letter forwarding the FM Audit Discrepancy forms (Appendix D) will include a summary of all areas where discrepancies were identified. When repeat findings are noted the effectiveness of the corrective action taken in response to previous audits should be addressed. RMC/FMA will provide a report to the ISIC of completed corrective action, proposed corrective action and schedule of accomplishment within 60 days of receipt of the ISIC Official Audit Report. Those items determined to require immediate correction should be addressed on a case-by-case basis.
- b. **ISIC/RMC/FMA Reports.** Reports of audit/review should usually take the form of locally generated forms. It may be an existing form used in other monitoring programs. An FM Discrepancy Form (Appendix E) should be used to report deficiencies that require investigation and program evaluation.

5.4.2 Correcting Deficiencies in Job Order Numbers and/or Financial Records. When deficiencies are identified in Financial Records associated with certified (closed) CWPs or JONs corrective action is required. The action must focus on updating or correcting those records to reflect the correct data and be thoroughly documented to leave an adequate audit trail. The CWP and financial record shall be annotated to associate the additional information to the document(s) as follows:

- a. An FM Discrepancy Form shall be generated for each JON deficiency identified. Each FM Discrepancy Form shall identify the deficiency, root cause and corrective action required or completed. The corrective action taken shall clearly identify the overall impact on the financial records of the RMC/FMA and any customer records.
- b. Once all required actions are completed to revise or update the financial records, a copy of the completed FM Discrepancy Form and any additional documentation generated shall be attached to the CWP and financial record such that it is clear that the record was revised or updated. The FM Discrepancy Form index log shall be updated to indicate the action was completed.

5.4.3 Assessments, Evaluations and Audits. The FMAs' FMO will retain records of assessments and evaluation for the past 24 months (unless otherwise stated). The records will consist of:

- a. FM Discrepancy Form index log that has the document numbers, work center responsible to correct and estimated date corrective action is expected to be complete.
- b. Copy of all FM Discrepancy Forms that have been completed during the period.
- c. Copy of last higher authority assessment and the corrective action for all identified deficiencies.
- d. Last annual financial management program evaluation performed.

APPENDIX A
VERTICAL AUDITS

1. The function of a vertical audit is to determine if a single job (JON) or maintenance effort has been completed in accordance with the financial management requirements. It tracks the JON from inception to completion by evaluating the documentation associated with the job (labor, material, contract charges, etc.) against the financial records. The following steps are considered the minimum requirements to conduct an audit:
 - a. Assemble the documentation for the job being audited.
 - b. Assemble the references.
 - c. Assign auditors who are familiar with the job being audited. If the assigned auditors are not familiar with the area to be audited, provide sufficient training.
 - d. Develop (if not already existing) attribute sheets to be used during conduct of audit.
 - e. Assemble previous audit discrepancies, if applicable.
 - f. Brief and train auditors on the following:
 - (1) Purpose of vertical audit.
 - (2) Common discrepancies from previous audits.
 - (3) Audit attributes.
 - g. Conduct audit as follows:
 - (1) Review procedure against the governing references and/or documentation to ensure they reflect what was supposed to be accomplished, if it was accomplished, and how it was accomplished.
 - (2) Review all documentation pertaining to financial records to ensure that they actually reflect that the job was charged correctly. Additionally, a check for accuracy and completeness of forms is required of the financial records and supporting documentation.
 - (3) All deficiencies noted, that require a more detailed investigation or program evaluation to identify root cause and permit effective and permanent corrective action, will be documented on a Financial Management Audit Discrepancy form (Appendix C), or FM Discrepancy Form (Appendix E), as appropriate, and presented to the activity being audited.
2. There is no specific formula for the successful completion of a vertical audit other than time and attention to detail. If properly performed, this audit provides an excellent method to assess the effectiveness of the financial management program regarding direct versus indirect costing process, since it provides small concise snap-shots of several areas of the entire program.

(This Page Intentionally Left Blank)

APPENDIX B
HORIZONTAL AUDITS

1. Horizontal Audit. These audits are conducted on only one specific area or aspect of the direct or indirect cost program (e.g., material charges or a specific category of labor on multiple JONs, administrative functions of the activity, etc.). These audits focus on the particular area and do not track a complete JON from inception to completion but rather track the funds expended across the activity for a specific function. This appendix provides guidelines for preparation and conduct of horizontal audits.
 - a. Assemble the source documents/references for the area being audited.
 - b. Assemble the documentation/records of area being audited.
 - c. Develop (if not already existing) attribute sheets/audit guide to be used during conduct of the audit. These attribute sheets will be posted to the Fleet Desk Guide website (<https://www.portal.navy.mil/crmc/fdg>) for use by other commands and will initially focus on the standard processes.
 - d. Assemble previous audit findings (if applicable) for area being audited.
 - e. Assemble, brief and train auditors on the following:
 - (1) Purpose of audit.
 - (2) Audit attributes.
 - (3) Common discrepancies from previous audits (if applicable).
 - f. Conduct audit as follows:
 - (1) Review area being audited using attribute sheets/audit guide.
 - (2) Review the organization's implementation and adherence to the source documents.
 - (3) Review the documentation used to certify that the organization is in compliance with the governing requirements.
 - (4) Document deficiencies which require investigation or program evaluation to determine root cause and permit effective and permanent corrective action on a Financial Management Audit Discrepancy form (Appendix C), or FM Discrepancy Form (Appendix E), as appropriate, and present it to the organization being audited.
2. If properly performed this type audit provides an excellent command-wide assessment of a specific area within the overall financial management program.

(This Page Intentionally Left Blank)

APPENDIX C
CHECKLIST FOR EVALUATING
DIRECT VERSUS INDIRECT COSTING

<i>Evaluation Step</i>	<i>Discrepancy Identified</i>	<i>Corrective Action Recommended</i>
1. Determine if all personnel have been trained on the identification of direct versus indirect costing.		
2. Evaluate charges placed against 5 randomly selected Job Order Numbers that were completed in the prior period.		
a. Determine if there are charges against the JON which should have been indirect.		
b. Determine if there were any charges against the JON by personnel who predominantly charge indirect JONs and evaluate the accuracy of those charges.		
3. Review the process used by the FMA to compute the monthly direct versus indirect percentage. Ensure that all expenditures were included in the computation.		
4. Randomly select 25 FMA personnel who should predominantly charge direct cost. Determine if any of those personnel charged over 10% of their available time to indirect efforts.		
a. If any of these personnel charged over 10% indirect, determine the reason.		
5. Obtain a listing of personnel who charged 100% of their efforts to an indirect JON. Select 20 personnel randomly and determine if there should have been an opportunity to charge some portion of their efforts to direct.		
6. Randomly select 5 reimbursable orders that were completed in the preceding period. Evaluate the charges against these orders to ensure that no indirect charges were applied.		

(This Page Intentionally Left Blank)

APPENDIX D

FINANCIAL MANAGEMENT AUDIT DISCREPANCY FORM

() CORRECTIVE ACTION REQUIRED

() REPEAT FINDING

ITEM:

AREA:

AUDITOR:

DISCUSSED WITH:

REFERENCE:

FINDING:

DISCUSSION:

RECOMMENDATION ADDRESSEE AND RECOMMENDED CORRECTIVE ACTIONS:

CORRECTIVE ACTIONS TAKEN:

A. ROOT CAUSE:

B. TEMPORARY CORRECTIVE ACTION (Designed to correct financial records.):

C. PERMANENT CORRECTIVE ACTION (Designed to prevent reoccurrence of condition.):

(This Page Intentionally Left Blank)

FINANCIAL MANAGEMENT DISCREPANCY FORM INSTRUCTIONS
SURVEILLANCE/MONITORING/AUDIT DISCREPANCY RECORD

PURPOSE: Provide a method or means of documenting and reporting discrepancies identified by reviewers during audits, evaluations and assessments of the financial management records process. The form also provides a means to document and monitor corrective actions taken by the FMA, Work Center or division. This form is intended for use in documenting the results of command evaluations, internal audits and inspections. When completed and maintained in an accurate, auditable fashion, the form provides a record of completed corrective action. This form can also be used to evaluate trends to improve overall financial management and reporting of FMA.

NOTE: A COPY OF ALL ASSOCIATED FM DISCREPANCY FORMS SHALL BE INCLUDED WITH THE FINAL CWP, ALONG WITH RECORD DEFICIENCIES FOUND IN A CLOSED CWP. FM RECORDS THAT REQUIRE CORRECTION SHALL BE DOCUMENTED ON AN FM DISCREPANCY FORM. NO CHANGE TO THE CLOSED CWP OR FM RECORD IS PERMITTED EXCEPT AS CITED IN THIS NOTE. THE FM DISCREPANCY FORM SERIAL NUMBER WILL BE ANNOTATED TO CLEARLY INDICATE THE FORM WAS WRITTEN AFTER THE CWP OR FM RECORD WAS CLOSED/CERTIFIED AND THAT ADDITIONAL OBJECTIVE EVIDENCE IS ASSOCIATED WITH THE CLOSED PACKAGE.

NOTE: THE REPAIR OFFICER, RESPONSIBLE DEPARTMENT HEADS, DIVISION OFFICERS AND FINANCIAL MANAGEMENT OFFICER (FMO) MUST ENSURE THAT ALL FM DISCREPANCY FORMS ARE APPROPRIATELY PROCESSED TO ENSURE THE ACCURACY AND COMPLETENESS OF THE FINANCIAL RECORDS.

PROCEDURE: The numbered blocks in FM Discrepancy Form correspond with the instructions listed below.

BLOCK 1 - **JON REVIEWED**

The Financial Management Supervisor (FMS) will enter the appropriate Job Order Number (JON) for the specific maintenance cost being reviewed. This allows the original submission to be compared with the validated charges.

BLOCK 2 - **WORK CENTER (WC)**

Person performing the review will enter the original WC responsible for the maintenance cost input.

BLOCK 3 - **DATE**

Person performing the review will enter the date the review was performed.

BLOCK 4 - **DISCREPANCY DESCRIPTION**

Person performing the review will enter a description of the discrepancy, if any are noted. Enter the CWP serial number if appropriate. If no discrepancies are noted, the details of the review should be included and note that no discrepancies were identified.

BLOCK 5 - **REVIEWER'S SIGNATURE**

The individual performing the review will sign, and legibly print, type or stamp his/her name.

BLOCK 6 - **WC SUPERVISOR SIGNATURE**

The WC Supervisor will sign, and legibly print, type or stamp his/her name signifying a review of and concurrence of the results of the review.

BLOCK 7 - **CORRECTIVE ACTION**

- a. **ROOT CAUSE:** If discrepancies are identified, the FMO, with the assistance of the Division Officer of the WC where the discrepancy was identified (Block 2), will identify and enter the root cause of the discrepancy. The root cause should address the control failure that allowed inaccurate data to be reported.

- b. **CORRECTIVE ACTION:** If discrepancies are identified, the FMO, with the assistance of the Division Officer of the WC where the discrepancy was identified, will enter a description of the corrective action that has been initiated to correct the erroneous data and address actions taken to prevent recurrence, including any process improvements and policy/procedural changes.

BLOCK 8 - **ECD**

If discrepancies are identified, the FMO, with the assistance of the Division Officer of the WC where the discrepancy was identified, will enter the Estimated Completion Date (ECD) of the corrective action identified in Block 7. The reviewer will follow-up to ensure the actions were effective.

BLOCK 9 - **DIVISION OFFICER/DATE**

The Division Officer of the WC reviewed will enter signature and date, and legibly print, type or stamp his/her name after Blocks 7 and 8 are complete.

BLOCK 10 - **RE-INSPECTION/AUDIT COMMENTS**

Upon completion of any required corrective actions or reaching the ECD of Block 8, the FMO or an FMS designated by the FMO and the individual who performed the review, should perform a re-inspection audit and enter the re-inspection results and any additional comments. This shall include a positive statement regarding effectiveness of the corrective action. The re-inspection audit will pay special attention to actions taken to prevent a reoccurrence of the problem.

BLOCK 11 - **FINANCIAL MANAGEMENT OFFICER (FMO)/FINANCIAL MANAGEMENT SUPERVISOR (FMS) SIGNATURE**

The FMO or FMS will enter signature and date, and legibly print, type or stamp his/her name indicating acceptance of the actions taken and the results of those actions identified in Block 10. This will indicate that the actions are complete and the FM Discrepancy Form is closed.

COPY TO:

The appropriate WC will be identified to receive a copy of the completed/closed form.

NOTE: AFTER ALL SECTIONS OF THE FORM HAVE BEEN COMPLETED AND THE ACTIONS COMPLETE, ALL PREVIOUS COPIES OF THE FORM MAY BE DISCARDED AND THE FINAL COMPLETED/CLOSED FORM RETAINED.

(This Page Intentionally Left Blank)

JOINT FLEET MAINTENANCE MANUAL**VOLUME III****DEPLOYED MAINTENANCE****LIST OF EFFECTIVE PAGES**

Page Numbers	Change in Effect	Page Numbers	Change in Effect
i	Change 5		
ii thru iv	REV C		
v thru vi	Change 3		
vii	Change 2		
viii	Change 1		
ix thru x	REV C		
III-1-1	Change 3		
III-1-2	REV C		
III-1A-1 thru III-1A-2	Change 3		
III-1B-1	Change 3		
III-1B-2	Change 4		
III-2-1 thru III-2-2	Change 3		
III-2-3	Change 2		
III-2-4 thru III-2-5	Change 5		
III-2-6	Change 2		
III-3-1	Change 3		
III-3-2	Change 1		
III-3-3	Change 3		
III-3-4 thru III-3-6	Change 1		
III-3-7	Change 3		
III-3-8	REV C		
III-4-1 thru III-4-3	Change 3		
III-4-4	Change 1		
III-4A-1 thru III-4A-2	REV C		
III-5-1 thru III-5-2	REV C		

(This Page Intentionally Left Blank)

JOINT FLEET MAINTENANCE MANUAL
VOLUME III
DEPLOYED MAINTENANCE
RECORD OF CHANGES

CHANGE NO.	DATE	TITLE OR BRIEF DESCRIPTION	ENTERED BY (INITIALS)

(This Page Intentionally Left Blank)

JOINT FLEET MAINTENANCE MANUAL CHANGE REQUEST FORM
<p>FROM: ACTIVITY/SHIP _____ E-MAIL ADDRESS _____ CODE/DEPT/SHOP _____ DATE _____ ORIGINATOR _____ TEL EXT () _____</p>
<p>VOL-PART-PARA NO. _____ FIGURE _____ TABLE _____ PROCESSING NORMAL _____ URGENT* _____ * (Justify in rationale below if urgent is marked and transmit via e-mail as "High Importance") PROBLEM DESCRIPTION:</p>
<p>RECOMMENDED CHANGE: (Include any proposed text addition/deletion)</p>
<p>RATIONALE:</p>

E-mail to PTNH.SUBMEPP.JFMMMGR@Navy.Mil
 (If mailing, fold on dotted line on reverse side and mail to Submarine Maintenance Engineering, Planning and Procurement (SUBMEPP) Activity or send facsimile to (207) 438-6210.)

FOLD

Commanding Officer

OFFICIAL BUSINESS

Commanding Officer
Submarine Maintenance Engineering,
Planning and Procurement (SUBMEPP) Activity
Attn: Code 1832JM
P.O. Box 2500
Portsmouth Naval Shipyard
Portsmouth, NH 03804-2500

FOLD

JOINT FLEET MAINTENANCE MANUAL
VOLUME III
DEPLOYED MAINTENANCE
TABLE OF CONTENTS

	Page No.
LIST OF EFFECTIVE PAGES	i
RECORD OF CHANGES	iii
JOINT FLEET MAINTENANCE MANUAL CHANGE REQUEST FORM.....	v
 CHAPTER 1 - INTRODUCTION	
1. Notice.....	III-1-1
1.1 Purpose	III-1-1
1.2 Scope	III-1-1
1.3 Changes and Corrections	III-1-2
1.4 Requests for Copies of the Manual.....	III-1-2
 Appendices	
A List of Acronyms	III-1A-1
B Glossary of Terms.....	III-1B-1
 CHAPTER 2 - MAINTENANCE ORGANIZATIONS AND CAPABILITIES	
2.1 Command Relationships.....	III-2-1
2.2 Maintenance Organizations and Capabilities.....	III-2-2
2.2.1 Sixth Fleet Organizations.....	III-2-2
2.2.2 Commander, Naval Service Force, Fifth Fleet Organizational Structure	III-2-3
2.3 Common Maintenance Facilities - All Areas of Responsibility	III-2-3
2.3.1 Afloat Fleet Maintenance Activities	III-2-3
2.3.1.1 Capabilities	III-2-3
2.3.1.2 Workload	III-2-3
2.3.1.3 Afloat Fleet Maintenance Activity Fly Away Team.....	III-2-3
2.3.1.4 Fly Away Team Funding	III-2-3
2.3.1.5 Afloat Fleet Maintenance Activity Tasking.....	III-2-3
2.3.2 Strike Force Intermediate Maintenance Activity	III-2-3
2.3.2.1 Mission	III-2-3
2.3.2.2 Policy	III-2-4
2.3.2.3 Applicability	III-2-4
2.3.3 Regional Maintenance Center.....	III-2-4
2.3.4 Regional Maintenance Center/Technical Assistance	III-2-4
2.3.5 Naval Regional Contracting.....	III-2-4
2.4 Unique Maintenance Facilities - Commander, United States Naval Forces, Europe-Commander, United States Naval Forces Africa-Commander, Sixth Fleet Area of Responsibility	III-2-4
2.4.1 U.S. Navy Facilities	III-2-4
2.4.2 Repairs in Ports Without Navy Ship Maintenance Organizations	III-2-4
2.4.3 Commercial Industrial Activities.....	III-2-5
2.5 Unique Maintenance Facilities - Commander, Fifth Fleet Area of Responsibility.....	III-2-5
2.6 Unique Maintenance Facilities - Commander, Seventh Fleet Area of Responsibility	III-2-5
2.6.1 Ship Repair Facility - Japan Regional Maintenance Center Yokosuka, Japan	III-2-5
2.6.2 Ship Repair Facility - Japan Regional Maintenance Center Detachment Sasebo, Japan	III-2-5
2.6.3 Space and Naval Warfare Systems Facility Pacific Yokosuka, Japan.....	III-2-5

CHAPTER 3 - MAINTENANCE MANAGEMENT

3.1 Purpose III-3-1

3.2 Casualty Report Summary III-3-1

3.3 Deployed Maintenance Periods III-3-1

3.3.1 Ship's Force Upkeep III-3-1

3.4 Voyage Repair Policy - (Non-Nuclear Work) III-3-1

3.4.1 Surface Force Ship and Aircraft Carrier Policy III-3-1

3.4.2 Voyage Repair Policy Commander, Logistics Western Pacific Area of Responsibility III-3-5

3.4.2.1 Voyage Repair Availability Execution III-3-5

3.4.2.1.1 Naval Regional Contract Detachment III-3-5

3.4.2.1.2 Arrival III-3-5

3.4.2.1.3 Pre-Production Meeting III-3-5

3.4.2.1.4 Daily Production Meeting III-3-5

3.4.2.1.5 Growth and New Work III-3-5

3.4.2.1.6 Constructive Changes III-3-5

3.4.2.1.7 Contractor Support III-3-5

3.4.2.1.8 Schedule Limitations III-3-6

3.4.2.1.9 Quality Assurance Responsibilities III-3-6

3.4.2.1.10 Unsatisfactory Work or Work Practices III-3-6

3.4.2.1.11 Post-Production Meeting III-3-6

3.4.2.1.12 Assessment Report III-3-6

3.4.3 Submarine Policy III-3-7

3.4.4 Nuclear Propulsion Plant and Related Equipment III-3-7

3.5 Ship Repair Work in Seventh Fleet Area of Responsibility III-3-7

3.5.1 Funding and Management for Naval Ship Repair Facility Availabilities III-3-7

3.5.2 Current Work Package III-3-7

3.6 Unsatisfactory Work/Work Practices III-3-7

CHAPTER 4 - SCHEDULED MAINTENANCE PLANNING, PREPARATION AND PRIORITIES

4.1 Purpose III-4-1

4.2 Surface Force Ship Work Package Preparation III-4-1

4.3 Continuous Maintenance Planning III-4-1

4.4 Current Ship's Maintenance Project Maintenance While Deployed III-4-1

4.5 Work Candidate Preparation and Priority III-4-2

4.6 Submission of Work Packages III-4-2

4.7 Work Candidate Screening and Brokering III-4-2

4.8 Screening of Work Candidates and Work Packages III-4-3

Appendices

A Format for Work Screening Message III-4A-1

CHAPTER 5 - MAINTENANCE SUPPORT FOR NON-UNITED STATES NAVY SHIPS AND ACTIVITIES

5.1 Purpose III-5-1

5.2 Military Sealift Command Vessels III-5-1

5.3	United States Coast Guard Vessels.....	III-5-1
5.4	Other Service Craft and Activities.....	III-5-1

(This Page Intentionally Left Blank)

VOLUME III
CHAPTER 1
INTRODUCTION

REFERENCES.

- (a) COMPACFLTINST 4710.6 - Policy for Accomplishment of Ship Repair Work in WESTPAC
- (b) COMSEVENTHFLT OPORD 201
- (c) NWP 1-03.1 - Naval Warfare Publication Operational Report

LISTING OF APPENDICES.

- A List of Acronyms
- B Glossary of Terms

1. **NOTICE.** Volume III revision reflects changes in Commander, U.S. Naval Force, Europe-U.S. Naval Forces, Africa, Sixth Fleet (COMUSNAVEUR-COMUSNAVAF-COMSIXTHFLT) maintenance support philosophy, practices and procedures. Transformational changes included the establishment of the Forward Deployed Regional Maintenance Center (FDRMC) Naples, Italy. Listed references, Operational Orders, instructions, policies and procedures will remain in effect and continue to be used until all references can be revised to reflect these changes and incorporated into this manual.

1.1 **PURPOSE.** To provide in one publication essential information concerning the maintenance policy for ships deployed in COMUSNAVEUR-COMUSNAVAF-COMSIXTHFLT, Commander, Fifth Fleet (COMFIFTHFLT), and Commander, Seventh Fleet (COMSEVENTHFLT) Areas of Responsibility (AOR).

1.2 **SCOPE.**

- a. COMUSNAVEUR-COMUSNAVAF-COMSIXTHFLT N43 oversees matters pertaining to repair and maintenance of Naval Surface Force ships in the COMUSNAVEUR AOR. Day-to-day administration of Surface Ship Maintenance in COMSIXTHFLT has been delegated to FDRMC NAPLES. Administration of repair and maintenance for Submarine Force ships has been delegated to Commander, Task Force 69 (CTF 69)/Commander, Submarine Group 8 (COMSUBGRU EIGHT). COMFIFTHFLT administers maintenance related matters and maintenance scheduling in the COMFIFTHFLT AOR. Day to day administration and scheduling of deployed submarine maintenance in the COMFIFTHFLT AOR is accomplished by Commander, Task Force 54 (CTF 54).

By references (a) and (b), Commander, Logistics (COMLOG) Western Pacific (WESTPAC) has the same responsibilities for ships deployed in the COMSEVENTHFLT AOR, other than Japan and Okinawa, which are the responsibility of the Ship Repair Facility - Japan Regional Maintenance Center (SRF-JRMC). Day-to-day administration and scheduling of deployed submarine maintenance in the COMSEVENTHFLT AOR is accomplished by Commander, Task Force 74 (CTF 74)/Commander, Submarine Group 7 (COMSUBGRU SEVEN).
- b. This manual authorizes overseas maintenance facilities to accomplish repairs on Military Sealift Command and United States Coast Guard ships and service craft, carrying out missions for the Navy in AORs specified in section 1.2.a of this Chapter, when authorized by the area commander. The procedures apply to all Navy ship maintenance administered and funded within the COMUSNAVEUR-COMUSNAVAF-COMSIXTHFLT, COMFIFTHFLT and COMSEVENTHFLT AORs.
- c. The COMSEVENTHFLT area and chop procedures are defined and governed by references (b) and (c). These maintenance procedures are not applicable in all cases to planned availabilities such as Selected Restricted Availabilities/Drydock Selected Restricted Availabilities, Phased Maintenance Availabilities, and planned availabilities, which are assigned to SRF-JRMC shore repair activities, for ships assigned to the Forward Deployed Naval Forces. Forward Deployed Naval Forces ships may also be assigned availabilities with Ship Repair Units (SRU) when deployed.
- d. Task Force Commanders and Commanding Officers shall be guided by this manual to obtain maintenance assistance while deployed. Commanding Officers of RMCs and Shore Fleet Maintenance Activities, Repair Officers of Afloat Fleet Maintenance Activities and Officers-In-Charge of Space and

Naval Warfare Systems Facilities Guam and Japan, as well as other activities involved in maintenance of deployed ships shall comply with the direction provided in this manual. Comments and recommendations for its improvement are invited.

- e. The Foreword of this manual contains a master list of references. These references are arranged in alphanumeric order to facilitate the ordering of documents. References used in specific chapters are listed at the beginning of each chapter. Appendices A and B of this chapter contain a list of acronyms and glossary of terms used in this specific volume.
- f. Equipment under the cognizance of the Strategic Systems Programs and Naval Sea Systems Command Nuclear Propulsion Directorate (NAVSEA 08) is maintained in accordance with Strategic Systems Programs and NAVSEA 08 directives, respectively.

1.3 CHANGES AND CORRECTIONS. Changes and corrections will be issued as required. Comments and suggestions for improving or changing this volume are invited. Address comments, recommendations and requested changes to Submarine Maintenance Engineering, Planning and Procurement (SUBMEPP) Activity utilizing the change request form located in the front of this manual. If changes are submitted in electronic format, facsimile or E-mail, each change request shall contain the information required on the change request form.

1.4 REQUESTS FOR COPIES OF THE MANUAL. Activities on distribution for the Joint Fleet Maintenance Manual (JFMM) that require additional copies or activities wanting to be added to distribution should submit a letter to their applicable Type Commander (TYCOM), identifying CD-ROM/paper requirements along with justification for the request. To the maximum extent possible, technical publications libraries at each activity will receive all copies of the manual for that activity and coordinate local distribution and updates.

APPENDIX A
LIST OF ACRONYMS

AER	Alteration Equivalent to a Repair
AFMA	Afloat Fleet Maintenance Activity (Submarine Tender)
AOR	Area of Responsibility
C4ISR	Command Control, Communications. Computers, Intelligence, Surveillance and Reconnaissance
C5I	Command, Control, Communications, Computers, Combat Systems and Intelligence
CASREP	Casualty Report
CM	Continuous Maintenance
COMFIFTHFLT	Commander, Fifth Fleet
COMLOGWESTPAC	Commander, Logistics Group Western Pacific
COMNAVAIRLANT	Commander, Naval Air Force, U.S. Atlantic Fleet
COMNAVAIRPAC	Commander, Naval Air Force, U.S. Pacific Fleet
COMNAVSURFGRU	Commander, Naval Surface Force Group
COMNAVSURFLANT	Commander, Naval Surface Force, U.S. Atlantic Fleet
COMNAVSURFPAC	Commander, Naval Surface Force, U.S. Pacific Fleet
COMPACFLT	Commander, Pacific Fleet
COMSEVENTHFLT	Commander, Seventh Fleet
COMSIXTHFLT	Commander, Sixth Fleet
COMSUBGRU	Commander, Submarine Group
COMSUBRON	Commander, Submarine Squadron
COMUSNAVAF	Commander, U.S. Naval Forces Africa
COMUSNAVEUR	Commander, U.S. Naval Force, Europe
CSMP	Current Ship's Maintenance Project
CTF	Commander Task Force
DDSI	Defense Distribution Depot, Sigonella, Italy
DET	Detachment
FAT	Fly Away Team
FDNF	Forward Deployed Naval Forces
FDRMC	Forward Deployed Regional Maintenance Center
FLC-NRCD	Fleet Logistics Center-Naval Regional Contracting Detachment
FMA	Fleet Maintenance Activity
FTA	Fleet Technical Assistance
IIT	Integrated Installation Team
INMARSAT	International Marine Satellite Communications
ISIC	Immediate Superior In Command
JFMM	Joint Fleet Maintenance Manual
MARAV	Master Agreements for Repair and Alterations of Vessels
MED	Mediterranean
MIC	Material Identification Code
MIOC	Maritime Integrated Operations Center
MSC	Military Sealift Command
MT	Maintenance Team
MUSE	Mobile Utility Support Equipment

NAVCALAB	Navy Calibration Laboratory
NAVIMFAC	Naval Intermediate Maintenance Facility
NAVSEA	Naval Sea Systems Command
NAVSEA 08	Naval Sea Systems Command Nuclear Propulsion Directorate
NSRF	Naval Ship Repair Facility
OIC	Officer in Charge
OPREP	Operation Report
PLAD	Plain Language Address Directory
PRI	Priority
QA	Quality Assurance
QAI	Quality Assurance Inspector
RADIAC	Radiation Detection, Indication and Computation
RMC	Regional Maintenance Center
RMT	Regional Maintenance Team
RSG	Regional Support Group
SEVENTHFLT	Seventh Fleet
SFIMA	Strike Force Intermediate Maintenance Activity
SIXTHFLT	Sixth Fleet
SMMO	Ship's Maintenance Management Officer
SPAWAR	Space and Naval Warfare
SRF-JRMC	Ship Repair Facility - Japan Regional Maintenance Center
SRU	Ship Repair Unit
SUBMEPP	Submarine Maintenance Engineering, Planning and Procurement Activity
SUPSHIP	Supervisor of Shipbuilding, Conversion and Repair
TYCOM	Type Commander
USCG	United States Coast Guard
VR	Voyage Repair

APPENDIX B
GLOSSARY OF TERMS

<u>TERM</u>	<u>DEFINITION</u>
Fleet Maintenance Activity (FMA)	FMAs include tenders, shore based maintenance activities (Regional Maintenance Centers, Naval Ship Repair Facilities, Naval Submarine Support Facilities, Naval Intermediate Maintenance Facilities (NSRF), TRIDENT Refit Facilities, Weapons Repair Facilities and other activities of that type) and supporting activities (port services, etc. that perform maintenance on Fleet assets).
Industrial Activity	The activity responsible for accomplishing construction or repair of ships whether private or public. This includes Regional Maintenance Centers, Naval shipyards, private shipyards, shipbuilders, commercial contractors, Naval Aviation Depots, NSRFs, Ship Repair Units (SRU) and other Naval Repair/Technical Activities (Naval Undersea Warfare Center (NUWC), Naval Surface Warfare Center (NSWC), etc.).
Maintenance Manager	Those persons, such as Maintenance Teams, Port Engineers, Ship Superintendents, Ships Coordinator and Maintenance Planning Managers, assigned to assist Ship's Force in the tracking of work candidates, development of work packages and tracking of AFMA/Regional Maintenance Center (RMC)/NSRF/Industrial Activities assigned jobs.
Maintenance Team	The Maintenance Team (MT), led by the Ashore Ships Maintenance Manager, is responsible for validating, scheduling and tracking through execution of all maintenance candidates. The primary responsibility of the Maintenance Team is to execute the maintenance policies, directives and regional business rules of this manual, the TYCOM and the RMC.
Naval Supervisory Authority/Supervisory Authority	The officer designated to represent the Navy Department at an industrial activity; normally a Supervisor of Shipbuilding (new construction), RMC (Conversion and Repair) or the Commander of a Naval Shipyard.
Regional Maintenance Team (RMT)	A site specific, multi-disciplined group of people normally accomplishing "outside shop" or on-platform work. An RMT may be platform or technology specific (e.g., submarines or nuclear) to facilitate necessary worker training and competency. An RMT is generally comprised of both military and civilian workers.
Regional Repair Center (RRC)	An "inside shop" focusing on a particular product line (e.g., motors) or technology (e.g., machinery). An RRC is generally comprised of both military and civilian workers.
Technical Data	Recorded information (regardless of the form or method of recording) of a scientific or technical nature (including computer databases and computer software documentation). This term does not include computer software or financial, administrative, cost or pricing, or management data or other information incidental to contract administration. The term includes recorded information of a scientific or technical nature that is included in computer databases. For these purposes, technical data includes the characteristic of a particular science, trade or profession.

Voyage Repairs A Voyage Repair availability is assigned solely for the accomplishment of corrective maintenance of mission or safety essential items necessary for a ship to deploy or continue on its deployment. Repairs accomplished during a VR availability are frequently referred to as Voyage Repairs.

Waterline The term “waterline” in this manual refers to where the hull of a ship meets the surface of water when afloat.

Work

- a. Any action that actually or potentially changes (including disassembly for the purposes of inspection or repair) the approved configuration of any part, component or ship’s system.
- b. Any action that removes or affects the ship’s ability to operate ship’s systems or components in accordance with ship’s systems/operating manuals or reactor plant manuals.
- c. Any testing or inspections required to establish, maintain or reestablish certification.
- d. Any design, engineering, planning or configuration management functions that involve the final review and/or approval of technical information.

Examples of work include the following:

1. Action which disassembles or removes any part, component or ship’s system.
2. Action specified in a Technical Work Document.
3. Any action that removes or affects the ship’s ability to operate ship’s systems or components in accordance with ship’s systems manuals, operating manuals or reactor plant manuals, excluding tagout in accordance with the Tagout Users Manual, including but not limited to:
 - (a) Component or system tests.
 - (b) Intrusive inspections (such as breaking the plane of electrical panels requiring electrical safety).
 - (c) Valve line ups that alter the normal system line up not governed by operating procedures.
 - (d) Removing valve hand wheels, disconnecting of reach rods.

VOLUME III**CHAPTER 2****MAINTENANCE ORGANIZATIONS AND CAPABILITIES**REFERENCES.

- (a) COMPACFLTINST 4710.6 - Policy for Accomplishment of Ship Repair Work in WESTPAC
- (b) COMPACFLTINST 4341.1 - Fleet Technical Assistance (FTA) Program (Cancelled)
- (c) OPNAVINST 4700.7 - Maintenance Policy for U.S. Naval Ships

2.1 COMMAND RELATIONSHIPS.

- a. Commander, U.S. Naval Force, Europe-Commander, U.S. Naval Forces, Africa-Commander, Sixth Fleet (COMUSNAVEUR-COMUSNAVAF-COMSIXTHFLT) assigns maintenance reporting responsibilities to subordinate Task Force commanders (CTF) while operating in the Area of Responsibility (AOR). Commander, Submarine Group (COMSUBGRU) Eight is the maintenance representative for all deployed Commander, Submarine Force, U.S. Atlantic Fleet units. Ships deployed to the COMUSNAVEUR-COMUSNAVAF-COMSIXFLT or Commander, Fifth Fleet (COMFIFTHFLT) AOR will address maintenance related correspondence to Forward Deployed Regional Maintenance Center (FDRMC) Naples and FDRMC DET Bahrain. Submarines deployed to COMSIXTHFLT address maintenance related correspondence to COMSUBGRU Eight, with information copy to their homeport Regional Maintenance Center (RMC)/Regional Support Group (RSG). Submarines deployed to COMFIFTHFLT, address all maintenance related correspondence directly to Commander Task Force 54 (CTF 54) with information copy to COMSUBGRU Eight.
- b. Commander, Naval Service Force, Fifth Fleet (COMSERVFORFIFTHFLT) is responsible for scheduling of maintenance and utilization of maintenance assets in the COMFIFTHFLT AOR. COMSERVFORFIFTHFLT has one other assignment: CTF 53, Force Logistics Commander for COMFIFTHFLT. COMSUBGRU Seven is responsible for coordination and execution of all deployed submarine maintenance in COMFIFTHFLT AOR as CTF 54.
- c. Commanding Officer, Ship Repair Facility - Japan Regional Maintenance Center (SRF-JRMC) is the Pacific Fleet Maintenance Officer's (CPF N43) representative for the Seventh Fleet AOR, coordinates ship repair and maintenance in Japan and Okinawa in accordance with references (a) and (b), and executes Fleet Technical Assistance (FTA) and Assessment in the entire Seventh Fleet AOR. Policy, procedures and guidance regarding utilization of FTA program resources are contained in Volume VI, Chapter 2 of this manual. He also acts as the Maintenance Representative for Commander Naval Surface Force, Pacific Fleet, Commander Naval Surface Force Atlantic Fleet and Commander Naval Air Force Pacific Fleet (COMNAVAIRPAC) Forward Deployed Naval Forces ships for all maintenance accomplished in Japan and Okinawa. Commander Logistics Western Pacific (COMLOG WESTPAC) is the Maintenance Representative for Commander Naval Surface Force, Pacific Fleet, and COMNAVAIRPAC for ship maintenance in the WESTPAC outside of Japan and Okinawa. COMNAVAIRPAC, Commander Naval Surface Force, Atlantic Fleet and COMNAVAIRPAC ships permanently forward deployed to WESTPAC as part of the Forward Deployed Naval Forces will address maintenance correspondence to SRF-JRMC for all maintenance in Japan and Okinawa, information copy to their Immediate Superior In Command (ISIC) and to COMLOG WESTPAC, information copy to their ISIC for all maintenance outside of Japan and Okinawa. All other deploying surface ships will address maintenance related correspondence directly to COMLOG WESTPAC copy to ISIC or to SRF-JRMC for Port Visits in Japan.

COMSUBGRU Seven is the Maintenance Representative for all deployed Commander, Submarine Force, U.S. Pacific Fleet ships. Submarines deployed to the Commander, Seventh Fleet AOR will address all maintenance correspondence directly to Commander Task Force 74 (CTF 74)

(COMSUBGRU Seven), information copy to ISIC and SRF-JRMC for maintenance that will be accomplished in Japan and Okinawa.

2.2 MAINTENANCE ORGANIZATIONS AND CAPABILITIES. The following organizations support maintenance on ships in their respective AORs:

2.2.1 Sixth Fleet Organizations.

- a. COMUSNAVEUR-COMUSNAVAF-COMSIXFLT.
 - (1) Fleet Maintenance Officer (N43). Sole staff advisor on subjects regarding naval surface aviation maintenance and salvage. Coordinates with COMUSNAVEUR-COMUSNAVAF-COMSIXTHFLT Maritime Integrated Operation Center (MIOC) Logistics, and CTF Commanders on maintenance support requirements. Provides liaison with FDRMC Naples for in-theater ship repairs. Monitors programs relating to aircraft, surface force ship and aircraft carrier maintenance, engineering and material support.
 - (2) CTFs. Task Force commanders are responsible for monitoring the material condition of units assigned and coordinating emergent repairs and requests for technical assistance. Coordinate changes to operational scheduling due to maintenance related problems (must be approved by MIOC). CTF Commanders also provide recommendations regarding operational delays of C3/C4 Casualty Reports (CASREP).
 - (3) CTF 63. COMUSNAVEUR-COMUSNAVAF-COMSIXTHFLT Task Force Commander for Logistics. Responsible for the scheduling and execution of Combat Logistics Force and Navy Unique Fleet Essential Airlift assets in charge of logistic support and distribution. MIOC Log Ops fulfills this responsibility for the CTF Commander.
 - (4) MIOC Log Ops. Provide logistical support to units operating in the COMUSNAVEUR-COMUSNAVAF-COMSIXTHFLT AOR. (PLAD: NAVEURLOGCOORD CENTER (NELCC)).
 - (a) Air Log. Manages Navy Unique Fleet Essential Airlift assets used to transport personnel and material in COMSIXTHFLT AOR and adjoining AORs.
 - (b) Passenger, Mail, Cargo and CASREP. Passenger, Mail, Cargo and CASREP division tracks all material movement from Continental U.S. to AOR. Once in the AOR, they direct material shipments to the unit via the most economical means possible using MILAIR, Defense Distribution Depot Sigonella, Italy (DDSI) (Commercial Air or Ground) or Combat Logistics Force.
 - (c) Sustainment. Provides logistical coordination for provisions, hazardous material, ordnance and fuel.
 - (5) COMSUBGRU Eight (CSG-8). Screens and coordinates maintenance for submarine-specific voyage repair. Assists CTF-69 in monitoring material condition of submarines assigned. Coordinates Voyage Repair (VR) repair brokerage through homeport RMC/RSG. Monitors Technical Assistance requests submitted to FDRMC Naples.
- b. FDRMC Naples. Commander, Navy Regional Maintenance Center Repair representative in the COMUSNAVEUR-COMUSNAVAF-COMSIXTHFLT AOR. Additional Duty to COMUSNAVEUR-COMUSNAVAF-COMSIXTHFLT as Fleet Surface Maintenance Officer (N43A). NAVSEA 00C Dive/Salvage Officer assigned to FDRMC Naples is Additional Duty to COMUSNAVEUR-COMUSNAVAF-COMSIXTHFLT as Fleet Salvage Officer for all dive and salvage related operations. Coordinator of FTA for surface and subsurface units and sole coordinator of voyage repair efforts for surface units. Provide contract maintenance support in all ports when required. Functions include shipcheck of screened work packages, specification writing, contract technical representation, and Quality Assurance of contracted work. Working closely with Fleet Logistics Center (FLC) Sigonella which performs the Primary Contracting Officer functions. FDRMC Naples ensures completion of all work accepted for accomplishment as VR is on time and in accordance with specifications. (PLAD: FDRMC NAPLES IT).
- c. FLC Sigonella provides fleet and base support for U.S. Navy, Military Sealift and Coast Guard ships; U.S. bases and facilities located in Europe, Africa and Southwest Asia; contingency operations; and continental U.S. activities requiring supplies and services from Europe, Africa and Southwest Asia.

- d. DDSI provides the full complement of physical distribution services to all four service components and other federal agencies located south of the Italian Alps. It provides forward stock positioning support and enhanced physical distribution services. Specialized handling and support services include managing the Navy's hazardous materials, depot level repair part storage and distribution, and a complete range of material packing and shipping services. DDSI also provides expedited requisitioning and centralized receiving support to the military community.

2.2.2 Commander, Naval Service Force, Fifth Fleet Organizational Structure. COMSERVFORFIFTHFLT N43 provides all organizational services. SRU DET Bahrain provides local management for the following services:

- a. Combat Systems and Hull, Mechanical and Electrical assists, provided by local RMC.
- b. Gas Turbine Changeout Vans.
- c. Waterjet Machines.
- d. Availability scheduling.

2.3 COMMON MAINTENANCE FACILITIES - ALL AREAS OF RESPONSIBILITY. The following types of maintenance facilities are common to all AORs and provide the services indicated.

2.3.1 Afloat Fleet Maintenance Activities.

2.3.1.1 Capabilities. For purposes of this volume, the Repair Department of a submarine tender will be referred to as Afloat Fleet Maintenance Activity (AFMA). AFMAs offer the broadest range of industrial capabilities of any afloat Navy activity. AFMAs are capable of repairs in all areas (e.g., hull, mechanical, electrical, electronic and ordnance equipment). Where there are shortfalls in shipboard expertise, AFMAs will be augmented by outside resources.

2.3.1.2 Workload. Maintenance Managers, Operational Commanders and AFMA Commanding Officers will maximize use of deployed AFMA Fly Away Teams (FAT), deployed or otherwise.

2.3.1.3 Afloat Fleet Maintenance Activity Fly Away Team. FATs provide a unique method of rapid deficiency correction which stresses mobility, initiative and maximization of resource utilization. AFMA FATs shall be used for CASREP correction and technical assistance for ships not collocated with the AFMA. AFMA FATs are tasked by the Maintenance Manager only after the following conditions have been established:

- a. Casualty is not correctable by any ship, element or unit of the Strike Force Intermediate Maintenance Activity.
- b. Ship will provide parts or FAT can carry all required parts.

Each AFMA will establish procedures to enable the deployment of FATs within hours of receiving tasking. The procedures will include pre-designation of FAT members, rapid preparation for travel orders, travel regulation briefings, advances in travel funding, area briefings, and area clearance messages as appropriate.

2.3.1.4 Fly Away Team Funding. FAT funding will be provided in accordance with Fleet direction.

2.3.1.5 Afloat Fleet Maintenance Activity Tasking. Tasking AFMA for performance of VRs, FAT assistance or other availabilities will be performed as follows: Maintenance Brokers for Fifth/Sixth/Seventh Fleet assigned units will request AFMA support and availability periods, via CTF 74, who will task Commander, Submarine Squadron (COMSUBRON) 15 for AFMAs located in Guam. For AFMAs in other locations in Fifth/Sixth/Seventh Fleet, Maintenance Brokers will request AFMA support and availability periods via the CTF (54/69/74) exercising Operational Control of the tender. The CTF exercising Operational Control will directly task the appropriate tender. CTF 54/69/74 or COMSUBRON 15, as applicable, shall provide the required support based on AFMA operational considerations and resource limitations (e.g., manpower and/or materials).

2.3.2 Strike Force Intermediate Maintenance Activity.

2.3.2.1 Mission. The mission of the Strike Force Intermediate Maintenance Activity is to provide a first response to units needing assistance with maintenance candidates beyond their capability to correct while deployed, at sea, or away from regular support facilities. It is a self-help effort that takes advantage of the organic capabilities of each

member of the deploying force. Maintenance candidates beyond the Strike Force Intermediate Maintenance Activity capability and/or capacity or those that would interfere with the mission of the service provider shall be managed per Chapter 4 of this volume. The Strike Force is not authorized to perform SUBSAFE, **Deep Submergence Systems Scope of Certification and Fly-By-Wire** work.

2.3.2.2 Policy. With the exception of SUBSAFE, Strike Force maintenance and repair actions are limited only by the procedures and guidelines contained in reference (c) and in the Quality Maintenance section, Volume V, Part I, Chapter 2 of this manual. The Strike Force is not authorized to perform SUBSAFE work.

2.3.2.3 Applicability. This paragraph applies to all Forces, Ships, Units and Detachments deploying as a cohesive force.

2.3.3 Regional Maintenance Center. RMCs provide contract maintenance support in all ports when assigned. RMC functions include shipcheck of screened work packages, specification writing, contract technical representation and Quality Assurance of contracted work. Working closely with FLC-Naval Regional Contracting Detachment (NRCD), which performs the Primary Contracting Officer functions; RMCs ensure all work accepted for accomplishment as VR is completed on time and in accordance with specifications. RMCs are located in Naples, Bahrain and Japan.

2.3.4 Regional Maintenance Center/Technical Assistance. The RMC Technical Support mission is to promote shipboard self sufficiency in accordance with references (a) and (b) as applicable. This is carried out by providing system and equipment Subject Matter Experts to assist and train Ship's Force in casualty prevention and correction. When the assistance required is not resident in the AOR, the responsible RMC will arrange technical assistance from other sources. Each RMC publishes a list of their organic technical capabilities. RMCs can request additional resources to provide assistance in accordance with Volume VI, Chapter 2 of this manual. RMCs can provide assistance for all non-nuclear shipboard systems. Additional details on FTA are available in Volume VI, Chapter 2 of this manual and reference (a).

2.3.5 Naval Regional Contracting. FLC-NRCD Naples and Singapore, provide contracting in support of AFLOAT and ASHORE activities. In support of afloat maintenance, FLC-NRCDs can perform all pre- and post-award contracting functions. They execute a variety of contract actions to support ship maintenance such as: issue Master Agreements for Repair and Alterations of Vessels (MARAV); place calls against Blanket Purchase Agreements, award Contracts or Purchase Orders; and compete job orders among MARAV holders. Please note that establishment of a MARAV only pre-qualifies industrial activities to accomplish Navy work which streamlines the procurement process. Being a MARAV holder does not guarantee the industrial activity can accomplish all types of work.

2.4 UNIQUE MAINTENANCE FACILITIES - COMMANDER, UNITED STATES NAVAL FORCES, EUROPE-COMMANDER, UNITED STATES NAVAL FORCES, AFRICA-COMMANDER, SIXTH FLEET AREA OF RESPONSIBILITY.

2.4.1 U.S. Navy Facilities. Maintenance piers and limited shore power are available at Naval Station Rota, Spain; Naval Support Activity Naples Detachment Gaeta, Italy; and Naval Station Souda Bay, Greece. Host nations also provide basic pier side services at the following ports: Faslane, Scotland; Gibraltar; Naples and Augusta Bay, Italy.

2.4.2 Repairs in Ports Without Navy Ship Maintenance Organizations.

- a. VRs are accomplished in many ports where there is no permanent Navy presence. This is accomplished by FDRMC Naples Surveyors and FLC-NRCD Naples Contracting Officers. FDRMC will develop contract specifications from ship's work packages, and NRCD will contract the work out to local contractors who have MARAV with FLC-NRCD. See Chapter 3, section 3.4 of this volume for additional information.
- b. FLC-NRCD contracted Husbanding Services Contractors may be used to obtain contract repair services using ship's operating budget. This should be done only on a very limited basis in emergency type situations. When used, Quality Assurance and conformance to Navy specifications are entirely the responsibility of Ship's Force.
- c. Submarine maintenance personnel and repair equipment will be assigned from the unit's homeport Fleet Maintenance Activity (an RMC or RSG), or brokered by the Fleet Maintenance Activity to another organization as necessary.

2.4.3 Commercial Industrial Activities. FLC-NRCD Naples maintain lists of commercial industrial activities in most major Mediterranean and some North Sea ports which have MARAVs with the Navy. Since this list changes with business conditions, it is not included here, but can be obtained from FLC-NRCD Naples.

2.5 UNIQUE MAINTENANCE FACILITIES - COMMANDER, FIFTH FLEET AREA OF RESPONSIBILITY. SRU Detachment Bahrain maintains a list of commercial industrial activities in Manama Bahrain, Jebel Ali United Arab Emirate, and Dubai United Arab Emirate, which have MARAVs with the Navy. Since this list changes with business conditions, it is not included here, but can be obtained from FDRMC Detachment Bahrain.

2.6 UNIQUE MAINTENANCE FACILITIES - COMMANDER, SEVENTH FLEET AREA OF RESPONSIBILITY.

2.6.1 Ship Repair Facility - Japan Regional Maintenance Center Yokosuka, Japan. SRF-JRMC Yokosuka, Japan is the Naval Supervisory Authority responsible for non-nuclear repair work in Yokosuka, Japan that has the resources to undertake voyage repairs, routine repairs, alterations, Selected Restricted Availability (SRA), and Drydocking Selected Restricted Availability (DSRA). SRF-JRMC Yokosuka, Japan is capable of repairing Hull, Mechanical, Electrical, Electronics, Ordnance, Gas Turbine equipment, boilers, etc., on all fossil fueled ships including mechanical and electronic test equipment repair and calibration. Graving docks are available for all classes of ships. Cold iron and feed water services are available. Portable tools are available for loan. Messages relating to repair matters in Yokosuka should be addressed to SRF-JRMC YOKOSUKA JA.

2.6.2 Ship Repair Facility - Japan Regional Maintenance Center Detachment Sasebo, Japan. SRF-JRMC DET Sasebo is the Naval Supervisory Authority responsible for arranging SRA, DSRA and repair work during upkeep and VR periods in Sasebo. Because most of the SRA/DSRA work in Sasebo is contracted to Japanese industrial activities, repairs to classified weapons, electronics, or cryptological equipment is accomplished by work force augmentation from SRF-JRMC Yokosuka, Japan. A metrology lab at SRF-JRMC Sasebo has the capability of performing most mechanical and some electrical and General Purpose Electronic Test Equipment calibration. Ship-to-shop equipment repair and calibration beyond SRF-JRMC DET Sasebo's capabilities will normally be trucked or flown to Yokosuka for accomplishment. **Calibration shall be accomplished in accordance with the requirements of Volume VI Chapter 9 of this manual.** The Production Shop can perform intermediate and depot level installs/repairs. Portable tools are available for loan. Messages relating to repair matters in Sasebo should be addressed to SRF-JRMC DET SASEBO JA, with information copies to SURFMO SASEBO JA, SRF-JRMC YOKOSUKA JA and COMFLEACT SASEBO JA.

2.6.3 Space and Naval Warfare Systems Facility Pacific Yokosuka, Japan. Space and Naval Warfare Systems Facility Pacific is chartered and tasked to manage installations of all Space and Naval Warfare Systems Command (SPAWAR) sponsored Command, Control, Communications, Computers, Intelligence, Surveillance and Reconnaissance (C4ISR) systems (e.g., hardware, software and networking) aboard all ships assigned to Commander, U. S. Seventh Fleet. Integrated installations aboard individual ships will be completed so that the overall Strike Group command, control and communications interoperability is achieved. The overall Space and Naval Warfare Systems Facility Pacific management and oversight for Fleet C4ISR installations consists of an Integrated Installation Team (IIT). Members of the IIT include but are not limited to the following:

- a. Installation Management Office. Functions as the conduit by which SPAWAR Systems Center Pacific receives installation related advanced planning, execution tasking and funding. The Installation Management Office ensures product delivery within cost, schedule and performance.
- b. IIT Leader. Overall management and oversight of the IIT, Strike Group Officers, Strike Group Superintendents and Ship Superintendents. Long-range planning for execution of installations in ships of respective Strike Groups. Ensures all parties (e.g., ship and chain of command, IIT and chain of command, system managers and chain of command) are informed. Liaisons with SPAWAR Fleet Readiness Directorate and applicable Program Executive Officers for engineering related issues.
- c. IIT Strike Group Officer. Works scheduling conflicts and issues. Liaisons with SPAWAR Fleet Readiness Directorate for Strike Group scheduling issues. Responsible to IIT Team leader for Strike Group scheduling, availability and system readiness to install. Ensures timely submission of reports and other engineering documentation. Liaisons with Ship Repair Facility, Naval Supervising Activity, NAVSEA Ship Platform Manager, Fleet Commands, Type Commanders, Strike Group Commanders and Commanding Officers to resolve Strike Group availability, scheduling and Strike Group C4ISR composition issues. Coordinate final authorization to install in Strike Group ships.

- d. IIT Strike Group Superintendent. Project Manager for Strike Group IIT installations. Scheduling for Strike Group availabilities. Work scheduling conflicts and issues. Liaison with SPAWAR Fleet Readiness Directorate for Strike Group scheduling issues. Responsible to IIT Team leader for Strike Group scheduling, availability and system readiness to install. Ensure timely submission of reports and other engineering documentation. Liaison with Ship Repair Facility, Naval Supervising Activity, NAVSEA Ship Platform Manager, Fleet Commands, Type Commanders, Strike Group Commanders and Commanding Officers to resolve Strike Group availability, scheduling and Strike Group C4ISR composition issues. Coordinate final authorization to install in Strike Group ships.
- e. IIT Ship Superintendent. Represents Commanding Officer, SPAWAR Systems Center Pacific, to Fleet Commanding Officers. Verifies work performed adheres to prescribed scope of tasking, policy and guidance. Designated person with overall responsibility for the conduct of the IIT. Has technical authority over contractor team members; shall be knowledgeable of and responsible for team adherence to all invoked requirements including safety and quality. Provides a single point of contact between ships and various waterfront activities. Coordinates installations with the Regional Maintenance and Modernization Coordination Office.
- f. Alteration Installation Team Manager. Responsible for installation of individual C4ISR systems in Strike Group ships. Ensures system has current funding, approved Ship Change Document and Government-Furnished Equipment ready for installation. Writes Statement of Work; provides and reviews cost estimates for contractor support as required. Provides system engineering and technical specifications before and during installation. Conducts System Operational Verification Testing and provides operator and maintenance training. Delivers drawings, configurations change forms and other system Integrated Logistics Support to ship's company as necessary. Updates Ship Selected Record as necessary. Reports to SPAWAR Systems Center Technical Code for installation assignment, pay, travel and other administrative matters. Reports to Ship Superintendent for operational matters concerning individual system installations.
- g. Integrated Logistics Support Manager. Implements Integrated Logistics Support policies and procedures in accordance with Integrated Logistics Support guidance to the Installation Management Office and IITs.

VOLUME III
CHAPTER 3
MAINTENANCE MANAGEMENT

REFERENCES.

- (a) Title 10 U.S. Code
- (b) COMPACFLTINST 4710.6 - Policy for Accomplishment of Ship Repair Work in WESTPAC
- (c) OPNAVINST 4700.7 - Maintenance Policy for U.S. Naval Ships
- (d) COMNAVAIRFORINST 4790.2 - Naval Aviation Maintenance Program
- (e) NAVSEAINST 4790.8/OPNAVINST 4790.4 - Ship's Maintenance and Material Management (3-M) Manual

3.1 **PURPOSE.** To implement the policies of references (a) through (e) when conducting deployed maintenance. Commanding Officers will keep their operational, administrative, and logistic commanders fully apprised of their material readiness status. The effectiveness of maintenance availabilities, as well as technical assistance is highly dependent on the detailed information provided.

3.2 **CASUALTY REPORT SUMMARY.** To assist maintenance and logistics activities in maintaining current readiness status for all ships assigned to various Areas of Responsibility (AOR), in-chopping ships will report all outstanding Casualty Reports prior to in chop in accordance with the applicable area Operational Orders.

3.3 **DEPLOYED MAINTENANCE PERIODS.** Commander, Fifth Fleet (COMFIFTHFLT), Commander, U.S. Naval Force, Europe-Commander, U.S. Naval Forces, Africa-Commander, Sixth Fleet, Commander, Seventh Fleet, Commander, Submarine Group (COMSUBGRU) Seven or COMSUBGRU Eight schedule all Availability periods for ships and submarines in their respective AORs (in accordance with references (a) and (b)) after receiving proposals from Operational Commanders.

3.3.1 **Ship's Force Upkeep.** A Ship's Force Upkeep is a maintenance period during which steaming notice is extended sufficiently to facilitate the maintenance of equipment and systems. A ship may accomplish self-maintenance or be assigned any of the following upkeep maintenance availability types:

- a. **Maintenance Availability.** A Maintenance Availability is an availability for the accomplishment of scheduled or emergent maintenance and may be further categorized based on scope, location and type.
- b. **Voyage Repair Availability.** A Voyage Repair (VR) Availability is assigned solely for the accomplishment of corrective maintenance on mission or safety essential items necessary for a ship to deploy or to continue on its deployment. Repairs accomplished during a VR availability are frequently referred to as Voyage Repairs.
 - (1) In accordance with Subtitle C, Part IV, Chapter 633, Section 7310 of reference (a), a naval vessel or any other vessel under the jurisdiction of the Secretary of the Navy, the homeport of which is in the United States may not be overhauled, repaired, or maintained in a shipyard outside of the United States or Guam other than in the case of VRs.
 - (2) Forward Deployed Regional Maintenance Center (FDRMC) Naples and Commander Logistics Western Pacific (COMLOG WESTPAC), will submit to Congress, via Fleet Commanders and the Chief of Naval Operations, quarterly reports of work items accomplished during VRs.

3.4 **VOYAGE REPAIR POLICY (NON-NUCLEAR WORK).**

3.4.1 **Surface Force Ship and Aircraft Carrier Policy.**

- a. VR work package screening guidelines in reference (c) limit the type of work which may be accomplished using overseas shipyards or Ship Repair Facilities - Japan Regional Maintenance Center (SRF-JRMC) to VRs only. For the purpose of this prohibition, a shipyard is any facility that repairs naval vessels and is located outside the United States or its territories. VRs include only mission or

safety essential items necessary for a ship to deploy or continue on its deployment. Only work which falls within these boundaries will be authorized for VR accomplishment. All other work will be deferred.

- b. VR work screening activities provide the results of screening to customer ships in a screening message. Approved work candidates are forwarded to the cognizant Regional Maintenance Center (RMC) for accomplishment or contract award. After authorized jobs are received by the RMC, the following steps take place:
 - (1) RMC Surveyor accomplishes shipcheck as ship schedule permits.
 - (2) Cognizant RMC Surveyor writes work specifications or contract work specifications prior to ship arrival.
 - (3) RMC/Contractor shipchecks take place upon ship's arrival. For VR that must be contracted, competitive bidding constraints require not less than three contractors be considered for contract award if possible.
 - (4) When VR contracting is required, contract award follows not later than arrival plus one day.
- c. Voyage Repair Availability Execution.
 - (1) The assigned Ashore Ships Maintenance Manager and Ship Superintendent or Surveyor will meet ship on arrival and will ensure the Job Order Specification or contract is in place, as applicable. The assigned Ashore Ships Maintenance Manager and Ship Superintendent or Surveyor will ensure the Job Order Specification or technical portion of the contract is adhered to and provide liaison with the local industrial activity on technical matters. It is the RMC Ship superintendent/Surveyor and Ship's Force responsibility to ensure the activity performing the VR complies with work specifications.
 - (2) Where applicable, the Fleet Logistics Center (FLC) Naval Regional Contracting Detachment (NRCD) representative will award the contract and provide liaison with the contractor on contractual matters, including new work and payment.
 - (3) A pre-production meeting will be scheduled, after the contractor shipcheck. Purpose is for assigned Ashore Ships Maintenance Manager and Ship Superintendent or Surveyor to review with the Ship's Force, contents of the Job Order Specification or Contract Specification, ship-contractor coordination requirements (if applicable), Quality Assurance (QA) requirements of Ship's Force and repair activity performing the VR, and list of government furnished material to be provided by the ship. The ship should provide the RMC Ship Superintendent/Surveyor a list of the ship's Quality Assurance Inspectors (QAI) to be used during the VR period.
 - (4) Daily Production Meeting. The Ship's Maintenance Management Officer, Surveyor, and other essential personnel will meet daily to review progress, discuss daily production efforts, and remove possible "interferences" with the intent of minimizing length of the availability. Early and frequent communication between all parties involved in the repair/maintenance process will help to ensure the overall success and effectiveness of any availability.
- d. Growth and New Work.
 - (1) Growth work identified during the open and inspect phase of the baseline repairs will be reviewed for cost and schedule impacts and incorporated in the work package by the RMC assigned Port Engineer or Surveyor, as applicable. No growth work or new work is authorized to commence until FLC NRCD negotiates with the contractor and the appropriate contract documentation is issued.
 - (2) New work must be processed and authorized without violating Public Law restrictions. To assure these restrictions are not violated, the ship shall submit an OPNAV 4790/2K in accordance with the normal process and provide a copy to the assigned Ashore Ships Maintenance Manager or Surveyor. Continuous Screening process will ensure that the forward maintenance activity receives it in a timely manner. The Surveyor shall determine the

feasibility of completing new work and shall obtain the required authorization from the cognizant organization (FDRMC Naples, FDRMC Det Bahrain, COMLOG WESTPAC, SRF-JRMC).

- e. Constructive changes are changes to contracts in the intent of work specifications directed at the contractor by anyone other than the surveyor or FLC-NRCD representative. Since they are not pre-negotiated with the contractor, constructive changes are against the law. Ship's Force personnel should be cautioned **not** to direct or otherwise influence contractor personnel to accomplish work not clearly delineated by contract specifications.
- f. Contractor Limitations.
 - (1) Military Specification material may be available from SRF-JRMC or requisitioned by the SRF-JRMC for contractor VR conducted on ships inport Yokosuka and Sasebo, Japan.
 - (2) With the exception of lagging, Military Specification parts and material are not available to local contractors in other ports. Some parts can be manufactured, but the material and parts required for work package execution should be provided by the ship.

CAUTION: THE SHIP SHOULD PROVIDE ONLY THE PARTS REQUIRED BY WORK SPECIFICATIONS. WITH THE EXCEPTION OF YOKOSUKA AND SASEBO, JAPAN, DRAWINGS AND TECHNICAL MANUALS ARE GENERALLY NOT AVAILABLE IN THEATER. SHIP'S FORCE SHOULD BE PREPARED TO PRODUCE ASSOCIATED TECHNICAL INFORMATION AS REQUIRED.

- g. Schedule Restrictions. Ships in VR should support the work week schedule provided by local contractors to make the most productive use of personnel resources during the maintenance period.
 - (1) In the COMFIFTHFLT AOR, the Arab work week is Saturday through Wednesday with the weekend being on Thursday and Friday.
 - (2) Contractor ability to accomplish work is sometimes limited by Port Captain regulations, and local strikes. Although generally short term in nature, the FLC-NRCD representative and RMC surveyor should be notified immediately of any indication of problems.
- h. Ship's Force QA responsibilities during VRs for work performed by non-Navy Maintenance Activities.
 - (1) Planning. Increased emphasis is required by Ship's Force to identify the level of control of maintenance of systems being worked and proper equipment, Allowance Parts List, technical manuals and drawings. Early identification of controlled work or work requiring Material Identification and Control/Material Identification Code (MIC)-LEVEL I material, in accordance with Volume V of this manual, will assist RMC Surveyors in producing correct work specifications.
 - (2) Execution. Although the name implies quick repairs, VRs require no less stringent QA procedures than any other routine planned repair. While Ship's Force is ultimately responsible for ensuring that the QA level is maintained on all repairs, regardless of who performs the work, the RMC overseeing the VR is responsible to Ship's Force to ensure all required specifications are met. Ship's Force QA responsibilities during execution include:
 - (a) Witnessing all tests and inspections specified in the contract work specification. Witnesses shall be qualified QAIs who are aware of the technical requirements to be fulfilled by the test or inspection. For steam systems, final inspections will consist of two steps: unlagged and lagged.
 - (b) Ensuring that documentation of each contractor test or inspection is provided to the QAI at its conclusion. If not provided, the QAI will use the applicable form from Volume V, Part I, Chapter 11 of this manual to document the test or inspection. Records of all Ship's Force and contractor tests and inspections will be maintained in accordance with Volume V, Part I, Chapter 10 of this manual.

- (c) Insisting on verbatim compliance with the work specification, through the QAI, during the test or inspection. The QAI will immediately inform the Department Head of any discrepancies noted.
 - (d) Ensuring that any material provided by Ship's Force by direction of the work specification is in strict accordance with technical requirements.
 - (e) Ensuring that no other material, tools, or physical assistance is provided to the contractor unless it is specifically required by the contract specification. The entire Ship's Force will be briefed on this prior to the start of the VR period.
 - (f) Providing continual in-process inspections of work being accomplished aboard ship. In-process inspections of work accomplished off-ship will be accomplished as deemed necessary by the Department Heads and as agreed to by the RMC Surveyor.
 - (g) Providing ship-specific operating/design system parameters to aid in determining actual testing requirements. Reporting specified test results on appropriate QA forms to the RMC Surveyor prior to the end of the VR period.
 - (h) Providing all MIC LEVEL I material required to the RMC Surveyor. Material will not be accepted unless properly controlled by Ship's Force. A face to face turnover by a designated Controlled Material Petty Officer to the RMC Surveyor is required.
- i. RMC Quality Assurance and Quality Control responsibilities during VR availabilities.
- (1) An RMC Surveyor will be present on the site of the VR for the duration of the availability. The RMC Surveyor will be the sole point of contact between Ship's Force, FLC-NRCD and the contractor for all questions and actions concerning work specifications.
 - (2) The RMC Surveyor will assist Ship's Force in QA monitoring of each job. The surveyor will:
 - (a) Provide a working copy of the work specifications and all modifications to be used for each job to the ship availability coordinator prior to job start or as soon as they are developed.
 - (b) Brief the ship availability coordinator and ship supervisory personnel on the nature of the industrial environment and the need to insist on verbatim compliance with the job specification by the contractor, stressing that failure of the contractor to provide required material, perform required tests, or otherwise conform to the specification requirements of the work, should be reported immediately. The briefing will specify that Ship's Force will not obligate the government or diminish the requirements of the work specification by direct interface with the contractor personnel on any level.
 - (c) Identify in the work specifications all tests and inspection check points which require Ship's Force witness or participation.
 - (d) Identify in the work specifications all tests which the ship must complete. Provide test parameters. If operational design and test information are not available or are unclear, the RMC will request assistance from the Type Commander (TYCOM).
 - (e) Identify in writing the specifications for material to be provided by the ship to the contractor.
 - (f) Inspect all material to be turned over to the contractor by Ship's Force for controlled work with the designated Ship's Force QAI. If the controlled material is MIC-Level I, the material inspection shall be a joint inspection, to include the designated Ship's Force QAI and the Ship's Controlled Material Petty Officer, prior to a turnover of the material to the contractor.
 - (g) Inspect each completed controlled work job with the designated Ship's Force QAI prior to final acceptance.

- (h) Advise the ship availability coordinator of any condition where the lack of references, Military Specification material, or qualified contractor personnel will require Ship's Force submission of a Departure from Specification in accordance with Volume V, Part I, Chapter 8 of this manual.
- j. Post-Production Meeting. The RMC Surveyor will provide to Ship's Force all appropriate documentation, including objective quality evidence, to verify the VR was satisfactorily completed. As necessary, technical justification will also be provided when a Departure from Specification request is required to be submitted.
- k. Following the completion of the VR Availability, Ship's Force shall generate and transmit a Post-VR Assessment Report for transmission via message or e-mail.

3.4.2 Voyage Repair Policy Commander, Logistics Western Pacific Area of Responsibility.

3.4.2.1 Voyage Repair Availability Execution.

3.4.2.1.1 Naval Regional Contract Detachment. The NRCD representative will award the contract and liaison with the contractor on contractual matters, including new work and payment.

3.4.2.1.2 Arrival. The RMC Surveyor will meet ship on arrival and ensure contracts are in place prior to the commencement of work. The Surveyor will ensure the technical portion of the contract is satisfied and will liaison with local industrial activity on technical matters. It is both the Surveyor and Ship's Force responsibility to ensure the contractor complies with work specifications.

3.4.2.1.3 Pre-Production Meeting. After the contractor ship-check, an arrival conference will be scheduled, during which the surveyor and Ship's Force will review the specifications, ship-contractor coordination requirements, QA requirements, and required government furnished material to be provided by the ship. The ship shall provide the Surveyor a list of the ship's QAIs to be used during the availability.

3.4.2.1.4 Daily Production Meeting. The RMC Surveyor, Ship's Maintenance Management Officer, and other personnel as necessary will meet daily, as a minimum, to review progress with the intent being to identify possible problem areas that may require specific attention. The overall success and effectiveness of any availability is almost entirely a reflection of the customer ship's interest in the work being accomplished.

3.4.2.1.5 Growth and New Work.

- a. Growth work identified during the open and inspect phase of the baseline repairs will be reviewed for cost and schedule impacts and incorporated in the work package by the Surveyor, as applicable. No growth work or new work is authorized to commence until FLC-NRCD negotiates with the contractor and the appropriate contract documentation is issued.
- b. New work must be processed and authorized without violating Public Law restrictions. To assure these restrictions are not violated, the ship shall submit an OPNAV 4790/2K in accordance with the normal process and provide a copy to the Surveyor. The Surveyor shall determine the feasibility of completing new work and shall obtain the required authorization from the Maintenance Manager.

3.4.2.1.6 Constructive Changes. Constructive changes are changes to contracts in the intent of work specifications directed at the contractor by anyone other than the Surveyor or FLC-NRCD representative. Since they are not pre-negotiated with the contractor, constructive changes are against the law. Ship's Force personnel should be cautioned not to direct or otherwise influence contractor personnel to accomplish work not clearly delineated by contract specifications.

3.4.2.1.7 Contractor Support.

- a. Material Support. Military Specification parts and material are often not available to local contractors. Some parts can be manufactured, but the ship should provide the material and parts required for work package execution. The ship should provide only the parts required by the work specifications.
- b. Technical Support. Drawings and Technical Manuals are generally not available in theater. Ship's Force should be prepared to produce associated technical information as required.

3.4.2.1.8 Schedule Limitations.

- a. In the COMFIFTHFLT AOR, the Arab workweek is Saturday through Wednesday with the weekend being on Thursday and Friday. Ships in VR Availabilities should support this schedule for the most productive use of the maintenance period.
- b. In Israel, the weekend is on Friday and Saturday. Ships in VR Availabilities should support this schedule for the most productive use of the maintenance period.
- c. Contractor ability to accomplish work is sometimes limited by Port Captain regulations, local strikes, and holidays. These stoppages are relatively frequent but short term in nature. The FLC-NRCD representative and RMC Surveyor should be notified immediately of any indication of problems.

3.4.2.1.9 Quality Assurance Responsibilities. Although the name implies quick repairs, VRs require no less stringent QA procedures than any other routine planned repair. While Ship's Force is ultimately responsible for ensuring that appropriate QA is maintained on all repairs, regardless of who performs the work, the Surveyor overseeing the VRs is responsible to Ship's Force to ensure that all requirements specified in the contract are met. Specific Ship's Force QA responsibilities may include:

- a. Providing personnel to witness tests and inspections as required by the Surveyor. Witnesses shall be qualified QAIs who are aware of the technical requirements to be fulfilled by the test or inspection.
- b. Ensuring that documentation of each contractor test or inspection is provided to the QAI at its conclusion. If not provided, the QAI will use the applicable form from Volume V, Part I, Chapter 11 of this manual to document the test or inspection. Records of all Ship's Force and contractor tests and inspections will be maintained in accordance with Volume V, Part I, Chapter 10 of this manual.
- c. Insisting on verbatim compliance with the work specification, through the QAI, during the test or inspection. The QAI will immediately inform the appropriate Department Head and Surveyor of any discrepancies noted.
- d. Ensuring that any material provided by Ship's Force by direction of the work specification is in strict accordance with technical requirements.
- e. Ensuring that no other material, tools, or physical assistance is provided to the contractor unless it is specifically required by the contract specification or requested by the Surveyor. The entire Ship's Force will be briefed on this prior to the start of the VR period.
- f. Assisting the Surveyor in providing continual in-process inspections of work being accomplished aboard ship. In-process inspections of work accomplished off-ship will be accomplished as deemed necessary by the Department Heads and as agreed to by the Surveyor.
- g. Providing ship-specific operating/design system parameters to aid in determining actual testing requirements. Reporting specified test results on appropriate QA forms to the Surveyor prior to the end of the VR period.
- h. Providing all MIC LEVEL I material required to the Surveyor. Material will not be accepted unless properly controlled by Ship's Force. A face-to-face turnover by a designated Controlled Material Petty Officer to the Surveyor is required.

3.4.2.1.10 Unsatisfactory Work or Work Practices. Any unsatisfactory work accomplished or work practice conducted by any maintenance activity shall be promptly reported to the activity involved and the applicable Maintenance Manager. Reports should include sufficient detail to ensure timely and proper corrective action may be taken. Prior to informing the Maintenance Manager, direct liaison between customer and repair activity in identifying and clarifying deficiencies is required.

3.4.2.1.11 Post-Production Meeting. The Surveyor will provide to Ship's Force all appropriate documentation, including objective quality evidence, to verify that the VRs were satisfactorily completed. As necessary, technical justification will be provided when a Departure from Specification request is required to be submitted.

3.4.2.1.12 Assessment Report. Following the completion of the VR Availability, Ship's Force shall generate and transmit a Post-VR Assessment Report for transmission via message or e-mail.

3.4.3 Submarine Policy.

- a. Mission essential VR support will be coordinated by COMSUBGRU Seven/COMSUBGRU Eight and applicable TYCOM, with information copies to MARCM DET Bahrain, COMLOG WESTPAC, and homeport Fleet Maintenance Activity (RMC/RSG).
- b. With the exception of Japanese National Master Labor Contract personnel employed by SRF-JRMC, foreign nationals shall **not** be contracted to perform VRs onboard submarines. Japanese National Master Labor Contract personnel employed by SRF-JRMC may perform VR work in non-nuclear areas only.
- c. When required, Mobile Utility Support Equipment (MUSE) support can be provided in some WESTPAC foreign ports. Ship requests for MUSE support shall be submitted to COMSUBGRU Seven, with information copies to FDRMC Det Bahrain and COMLOG WESTPAC. Commander, U.S. Naval Force, Europe-Commander, U.S. Naval Forces, Africa-Commander, Sixth Fleet has no MUSE support.

3.4.4 Nuclear Propulsion Plant and Related Equipment. Only qualified Navy or Naval Industrial Activity personnel shall perform maintenance on nuclear propulsion plant and related equipment. Ship requests for VRs to this equipment shall be forwarded to the TYCOM, with information copies to the parent Immediate Superior In Command, FDRMC Det Bahrain, COMLOG WESTPAC, COMSUBGRU Seven or COMSUBGRU Eight.

3.5 SHIP REPAIR WORK IN SEVENTH FLEET AREA OF RESPONSIBILITY. Subtitle C, Part IV, Chapter 633, Section 7310 of reference (a) limits vessels with a homeport in the United States to receiving **ONLY** VRs from foreign maintenance facilities. The restrictions imposed by Subtitle C, Part IV, Chapter 633, Section 7310 of reference (a) include SRF-JRMC. The WESTPAC Afloat Fleet Maintenance Activity and Guam repair facilities are considered U.S. repair facilities and are not limited to performing Voyage Repairs on U.S. homeported ships. Additionally, the VR restrictions under reference (a) do not apply to the Forward Deployed Naval Forces ships. Reference (b) provides specific instruction for the preparation of work packages, funding and management of WESTPAC availabilities.

3.5.1 Funding and Management for Naval Ship Repair Facility Availabilities. Detailed procedures for financing Naval Ship Repair Facility availabilities in WESTPAC are contained in reference (b). Funds for the accomplishment of repairs in WESTPAC are centrally budgeted and managed by Commander, Pacific Fleet, with the WESTPAC availability funds being provided direct to each individual repair activity for the accomplishment of authorized repairs to Seventh Fleet ships.

3.5.2 Current Work Package. For Commander, Seventh Fleet AOR, the Maintenance Team will screen, budget and broker ship's 2 Kilos to repair facilities, COMLOG WESTPAC, SRF-JRMC, or FLC- NRCD for local contracting (via RMC/COMLOG WESTPAC) in accordance with current FLEET and TYCOM policies and procedures.

3.6 UNSATISFACTORY WORK/WORK PRACTICES. Any unsatisfactory work accomplished by any maintenance activity shall be promptly reported to the activity involved. Inform the operational and administrative chains of command and RMC, as applicable. Reports should include sufficient detail to ensure that timely and proper corrective action may be taken. Direct liaison between customer and repair activity in clarifying deficiencies is mandatory.

(This Page Intentionally Left Blank)

VOLUME III**CHAPTER 4****SCHEDULED MAINTENANCE PLANNING, PREPARATION AND PRIORITIES**REFERENCES.

- (a) NAVSEAINST 4790.8/OPNAVINST 4790.4 - Ship's Maintenance and Material Management (3-M) Manual

LISTING OF APPENDICES.

- A Format for Work Screening Message

4.1 PURPOSE. To implement the policies of reference (a) when planning deployed maintenance, and describe the process for the submittal and review of work packages and message work candidates for deployed ships.

4.2 SURFACE FORCE SHIP WORK PACKAGE PREPARATION. Volume II, Part II, Chapter 2 of this manual establishes Naval Surface Force ship maintenance work item/specification package preparation procedures, milestones and business rules. These business rules apply to Regional Maintenance Centers (RMC), Surface Type Commanders, Systems Commanders (sponsoring Program Alterations) and other Alteration Installation Team Sponsors.

4.3 CONTINUOUS MAINTENANCE PLANNING. In this Chapter on Deployed Maintenance, the term Continuous Maintenance (CM) Planning refers to Forward Deployed Naval Forces (FDNF) ships, and to work brokered to the Afloat Fleet Maintenance Activity (AFMA) for all other ships. A vital part of CM is the scheduling and accomplishment of work outside of Chief of Naval Operations availabilities. This allows the ship to be consistently maintained at acceptable readiness levels. Private Sector Industrial Activity contracts create a long-term relationship with the executing activity that facilitates the execution of CM. The ship's maintenance teams should recognize every scheduled in-port period as an opportunity to accomplish CM. Funding for CM is included in the ship's Maintenance and Modernization Business Plan. Discussions with Private Sector Industrial Activity contractors and I-Level service providers indicate that in order to get the most efficient use of our CM maintenance dollars there are some minimum planning thresholds that should be adhered to in order to prevent premiums from being accrued. A minimum of 30 days should be allotted between the time depot level work is brokered to the executing activity and work is scheduled to start. A minimum of 40 days should be allotted for work brokered to I-Level activities. This assures there is adequate time to plan the work and acquire the necessary material in an efficient manner. If these minimum thresholds cannot be complied with, the work should be postponed until the next CM opportunity. The Maintenance Team may run a business case if there are other factors that might justify the addition of work inside these preferred windows. As described above all work for a CM Availability should be identified at A-40 for I-Level and at A-30 for D-Level. This will allow a Work Package Integration review to take place at A-20 and for all work to be defined at A-10.

4.4 CURRENT SHIP'S MAINTENANCE PROJECT MAINTENANCE WHILE DEPLOYED.

- a. Under the CM concept, parent Maintenance Team/RMC/Immediate Superior In Command (ISIC)/Fleet Maintenance Activity (FMA) will not transfer the Current Ship's Maintenance Project to the deployed unit's maintenance activity. Parent Maintenance Team/RMC/ISIC/FMA will maintain control of the Current Ship's Maintenance Project and will broker work, as a continuous process, in accordance with Volume II, Part I, Chapter 2 of this manual.
- b. Parent Maintenance Team/RMC/ISIC/FMA will identify work candidates brokered to a deployed screening activity in the appropriate IT system and report them to the ship through weekly Work Package Summary reports.
- c. When normal screening systems are down, parent Maintenance Team/RMC/ISIC/FMA will receive automatic feedback on status of brokered work candidates through the appropriate IT system(s). The forward screening activity can identify work candidates that will **not** be undertaken during deployment by using the "Return to Broker" function.

4.5 WORK CANDIDATE PREPARATION AND PRIORITY.

- a. Work candidates shall be prepared in strict accordance with reference (a). Use a message work candidate in accordance with Volume II, Part I, Chapter 4 of this manual whenever an OPNAV 4790/2K **cannot** be sent by any other means.
- b. In accordance with End to End Maintenance Process procedures, an appropriate Figure of Merit should be assigned.
- c. Priority (PRI) assignment in 2 Kilo is a major factor in determining whether a work candidate is approved for accomplishment during deployment and must be accurate. The following table illustrates the interrelationships.

DEPLOYED ACCOMPLISHMENT FOR NON-FORWARD DEPLOYED NAVAL FORCES (FDNF) SHIPS

<u>PRI</u>	<u>DESCRIPTION</u>	<u>ACTIVITIES</u>
1	Voyage Repairs.	Afloat Fleet Maintenance Activity (AFMA), Technical Assistance or Foreign Contractor, Naval Ship Repair Facility (NSRF), Strike Force Intermediate Maintenance Availability (SFIMA).
2	Urgent repairs during: Unscheduled Maintenance Availabilities.	AFMA, Technical Assistance or SFIMA.
3	Routine repairs.	AFMA or SFIMA.
4	Desirable ship work.	AFMA or SFIMA.

4.6 SUBMISSION OF WORK PACKAGES. Screened work packages should be continuously available to Commander, Logistics (COMLOG) Western Pacific (WESTPAC), Forward Deployed Regional Maintenance Center (FDRMC) Naples, Det Bahrain and the AFMAs from the ship's parent Maintenance Team Ship Repair Facility - Japan Regional Maintenance Center (SRF-JRMC)/ISIC. These work packages will form the basis for each availability. To ensure clearly defined work packages at availability start, the accomplishing activity (FMA/RMC or Maintenance Manager) will provide a screening message at arrival minus ten days to all concerned with an information copy to responsible ISICs and RMC (See Appendix A of this chapter).

4.7 WORK CANDIDATE SCREENING AND BROKERING. For Commander, U.S. Naval Forces, Europe-Commander, Sixth Fleet (COMUSNAVEUR)-(COMSIXTHFLT) Area of Responsibility (AOR), FDRMC Naples will screen, budget and broker surface ship's maintenance work candidates to Fleet Maintenance Activities, stateside repair facilities or to the Naval Regional Contracting Department for local. Commander, Submarine Group (COMSUBGRU) Eight will screen submarine Message Work Candidates, and coordinate with the Unit's home Fleet Maintenance Activity to broker the work to the appropriate repair facility.

For Commander, Fifth AOR, the Maintenance Team will screen, budget and broker ship's 2-Kilos to repair facilities, COMLOG WESTPAC, RMC, or Fleet Logistics Center/Naval Regional Contracting Department for local contracting (via RMC/COMLOG WESTPAC) in accordance with current FLEET and Type Commander policies and procedures.

For Commander, Seventh Fleet AOR. For all maintenance actions in Japan and Okinawa, SRF-JRMC will screen, budget and broker surface ship's maintenance work candidates to FMAs, stateside repair facilities, or to Fleet Logistics Center Yokosuka for local contractor accomplishment. For all maintenance outside Japan, COMLOG WESTPAC will screen, budget and broker surface ship's maintenance work candidates to FMAs, stateside repair facilities or to Fleet Logistics Center Det Singapore for local contractor accomplishment. COMSUBGRU Seven will screen submarine Message Work Candidates, and coordinate with the Unit's home FMA to broker the work to the appropriate repair facility. COMSUBGRU Seven will also screen surface ship 2-Kilos to its assigned AFMA referred to them from COMLOG WESTPAC.

4.8 SCREENING OF WORK CANDIDATES AND WORK PACKAGES.

a. The following activities are authorized to conduct screening of work packages:

<u>AREA OF RESPONSIBILITY</u>	<u>ACTIVITY</u>	<u>REMARKS</u>
COMUSNAVEUR-COMUSNAVAF-COMSIXTHFLT	FDRMC Naples	Screening for surface ships deployed to SIXTH Fleet
	COMSUBGRU Eight	Screening for submarines deployed in SIXTH Fleet.
Commander, Fifth Fleet (COMFIFTHFLT)	FDRMC Det Bahrain	Screening for all Arabian Gulf/Arabian Sea/Red Sea activities (AFMA, Contractor).
	COMFIFTHFLT AFMA	Screening for assigned MAVs only.
	COMSUBGRU Seven	Screening for all deployed submarines.
Commander, Seventh Fleet (COMSEVENTHFLT)	SRF-JRMC	Screening for FDNF for ports covered by SRF-JRMC.
	WESTPAC AFMA	Screening for AFMAs only.
	COMSUBGRU Seven	Screening for all submarine and assigned surface ship AFMAs.
	SRF-JRMC	Screening for all COMSEVENTHFLT deployers visiting Yokosuka.
	SRF-JRMC	Screening for all COMSEVENTHFLT deployers visiting Sasebo.
	COMSUBGRU Seven	Screening for all deployed submarines.
	COMSUBBRON Fifteen	Screens all work candidates and work packages brokered to the assigned AFMA.

b. Non-FDNF Voyage Repairs Only. When AFMAs visit ports with substantial Naval repair facilities or are in commercial ports during times of high port loading, it is often desirable to divide availabilities and primary work screening functions between the shore activity and the AFMA on a ship by ship basis. When this happens, the applicable maintenance manager will, by message, assign the primary availability and work package screening responsibility to either the shore activity or the AFMA. When assigned, the primary activity will request and screen the work package. The primary activity will also screen work candidates for referral to the secondary activity for review and acceptance or rejection. The secondary activity will then issue its own screening message concerning only the work candidates referred by the primary activity. Ports where this may be routinely expected to happen are:

<u>PORT</u>	<u>ACTIVITY</u>
Yokosuka	SRF-JRMC
Sasebo	SRF-JRMC Det

- c. The following guidance applies to work to be accomplished by all maintenance activities on ships not permanently homeported overseas:
- (1) Work candidates which are clearly within the capability of Ship's Force will not normally be accomplished by repair activities, but technical assistance will be provided if the need is substantiated.
 - (2) Work candidates for material only or manufacture of standard stock items will not be approved, unless the item is not available in time to ensure timely correction of Casualty Reports or major safety items only.
 - (3) Unless previously authorized by the Type Commander, work candidates for ship changes will not normally be approved while deployed.
 - (4) Activities authorized to accomplish work screening will use screening messages prepared in accordance with Appendix A of this chapter, or via Email (SIPRNET/NIPRNET) as applicable.

APPENDIX A
FORMAT FOR WORK SCREENING MESSAGE

FM (ACTIVITY)//
TO USS (SHIP NAME AND HULL NO.)//
INFO (MAINTENANCE MANAGER)//
(OPERATIONAL COMMANDER)//
(PARENT RSG/RMC)//
(PARENT ISIC)//
BT
UNCLAS //N04700//
MSGID/GENADMIN/ACTIVITY//
SUBJ/WORK PACKAGE SCREENING FOR VR/OTHER AVAILABILITIES//
REF/A/MSG/(SHIP NAME)//
REF/B/DOC/COMUSFLTFORCOMINST 4790.3//
NARR/REF A IS CALL DOWN MESSAGE. REF B IS JOINT FLEET MAINTENANCE MANUAL//
RMKS//1. WORK PACKAGE (CALL DOWN) FORWARDED REF A RECEIVED AND SCREENED IAW REF
B AS FOLLOWS:
A. ACCEPTED FOR ORIG (NSRF) ACCOMPLISHMENT.
(LIST JSNS)(LIST SHIP-TO-SHOP JSNS)
B. SCREENED FOR AFMA USS (SHIP NAME) ACCOMPLISHMENT.
(LIST JSNS)
C. DEFERRED PENDING SHIPCHECK.
(LIST JSNS)
D. DEFERRED: SHIPALT/AER REQUIRES TYCOM AUTH.
(LIST JSNS)
E. DEFERRED: SHIPS FORCE ACCOMPLISHMENT.
(LIST JSNS)
F. DEFERRED: WORKLOAD, FUNDING OR NON-VR.
(LIST JSNS)
G. DEFERRED: INSUFFICIENT INFORMATION.
H. DEFERRED: OTHER.
2. EVALUATION AND COMMENTS CONCERNING WORK PACKAGE QUALITY (IF APPLICABLE)
3. OTHER COMMENTS: SHORE POWER AVAILABILITY, BERTHING PLAN, OTHER SERVICES
OFFERED OR PLANNED, ETC.//
BT

**NOTE: ENSURE MESSAGES ARE IN ACCORDANCE WITH CURRENT MESSAGE FORMAT AND
CURRENT PLAIN LANGUAGE ADDRESS DIRECTORY (PLAD) IS UTILIZED.**

(This Page Intentionally Left Blank)

VOLUME III
CHAPTER 5
MAINTENANCE SUPPORT FOR
NON-UNITED STATES NAVY SHIPS AND ACTIVITIES

5.1 PURPOSE. Maintenance activities addressed in this volume shall provide support to Military Sealift Command (MSC) ships, United States Coast Guard (USCG) ships and other craft and activities on a not to interfere with primary mission basis, at the discretion of the Commanding Officer or Officer In Charge. Generally, all material directly chargeable to the work accomplished shall be funded by the requesting activity. Requesting activity should also fund any related temporary additional duty and travel expenses. If the requesting activity is non-United States Navy, man-day rates for military and civilian personnel will be chargeable.

5.2 MILITARY SEALIFT COMMAND VESSELS. Before the acceptance of work by the industrial activity, MSC vessels must obtain prior authorization and funding from the cognizant MSC program manager via the ship's MSC port engineer and MSC type desk. Where prior authorization has not been received, the Master and Chief Engineer of the requesting vessel should be directed to submit their Voyage Repair request to their MSC Port Engineer and MSC type desk for work authorization and brokering. After the MSC type desk authorizes the work, and it is accepted by the industrial activity, the industrial activity will use their standard procedures for work candidate processing, planning, Quality Assurance, and work execution methods. The MSC ship Chief Engineer and/or Port Engineer will be the primary points of contact to coordinate jobs. Work performed by Fleet Maintenance Activities shall be included in the Maintenance Resource Management System for tracking and up line reporting. Note that MSC ships do not use the 3M system. A maintenance tracking number and a point of contact must be provided to the Chief Engineer and Port Engineer for tracking the job.

5.3 UNITED STATES COAST GUARD VESSELS. USCG vessels assigned to Navy operational control will be treated the same as Navy vessels for the purposes of maintenance, with the exception that the USCG will fund any direct material, or contractor charges.

5.4 OTHER SERVICE CRAFT AND ACTIVITIES. Work requested by non-Navy activities shall be carefully screened to ensure the work is authorized by higher authority, funding arrangements are in place and technical requirements are fully understood prior to acceptance.

(This Page Intentionally Left Blank)

JOINT FLEET MAINTENANCE MANUAL**VOLUME IV****TESTS AND INSPECTIONS****LIST OF EFFECTIVE PAGES**

Page Numbers	Change in Effect	Page Numbers	Change in Effect
i thru iv	Change 5	IV-3E-1 thru IV-3E-2	REV C
v thru vi	Change 1	IV-3F-1 thru IV-3F-2	REV C
vii thru viii	Change 3	IV-3G-1 thru IV-3G-2	REV C
ix thru xii	Change 1	IV-4-1	Change 3
xiii	Change 5	IV-4-2	REV C
xiv	Change 1	IV-4-3	Change 5
xv thru xviii	Change 4	IV-4-4	Change 1
xix thru xx	Change 1	IV-4-5	Change 2
IV-1-1	Change 1	IV-4-6 thru IV-4-9	Change 3
IV-1-2	REV C	IV-4-10	REV C
IV-1A-1 thru IV-1A-4	Change 2	IV-4A-1	Change 1
IV-2-1 thru IV-2-3	Change 3	IV-4A-2	REV C
IV-2-4	Change 5	IV-5-1 thru IV-5-2	Change 1
IV-2A-1 thru IV-2A-2	REV C	IV-6-1	Change 1
IV-2B-1 thru IV-2B-2	REV C	IV-6-2 thru IV-6-4	REV C
IV-2C-1 thru IV-2C-2	REV C	IV-7-1 thru IV-7-3	REV C
IV-2D-1 thru IV-2D-2	REV C	IV-7-4	Change 2
IV-3-1 thru IV-3-4	Change 1	IV-7A-1 thru IV-7A-2	REV C
IV-3-5 thru IV-3-6	Change 5	IV-7B-1 thru IV-7B-2	REV C
IV-3-7	REV C	IV-8-1	Change 2
IV-3-8 thru IV-3-10	Change 1	IV-8-2	Change 1
IV-3A-1 thru IV-3A-2	REV C	IV-8-3 thru IV-8-4	REV C
IV-3B-1 thru IV-3B-2	REV C	IV-9-1 thru IV-9-2	Change 3
IV-3C-1 thru IV-3C-2	REV C	IV-9A-1 thru IV-9A-4	REV C
IV-3D-1 thru IV-3D-2	REV C	IV-9B-1 thru IV-9B-4	REV C

Page Numbers	Change in Effect	Page Numbers	Change in Effect
IV-9C-1 thru IV-9C-2	REV C	IV-12-4	REV C
IV-9D-1 thru IV-9D-6	REV C	IV-12A-1 thru IV-12A-2	REV C
IV-10-1	Change 5	IV-12B-1 thru IV-12B-2	REV C
IV-10-2 thru IV-10-6	Change 2	IV-13-1	REV C
IV-10-7	Change 5	IV-13-2	Change 1
IV-10-8	Change 2	IV-13-3	REV C
IV-10-9	Change 1	IV-13-4	Change 2
IV-10-10	Change 4	IV-13-5 thru IV-13-8	REV C
IV-10-11 thru IV-10-12	Change 1	IV-14-1	Change 1
IV-10A-1	REV C	IV-14-2	REV C
IV-10A-2 thru IV-10A-3	Change 2	IV-15-1 thru IV-15-4	REV C
IV-10A-4	REV C	IV-16-1	Change 1
IV-10B-1 thru IV-10B-2	REV C	IV-16-2 thru IV-16-3	Change 2
IV-10C-1 thru IV-10C-4	REV C	IV-16-4	REV C
IV-10D-1	Change 5	IV-17-1 thru IV-17-2	Change 4
IV-10D-2 thru IV-10D-3	Change 4	IV-17-3 thru IV-17-6	REV C
IV-10D-4	REV C	IV-17-7	Change 4
IV-10E-1	Change 2	IV-17-8	REV C
IV-10E-2	REV C	IV-17A-1 thru IV-17A-2	REV C
IV-10F-1	Change 2	IV-17B-1 thru IV-17B-2	REV C
IV-10F-2	REV C	IV-17C-1 thru IV-17C-2	REV C
IV-10G-1	Change 2	IV-17D-1	Change 4
IV-10G-2	REV C	IV-17D-2	REV C
IV-10H-1 thru IV-10H-2	Change 2	IV-17D-3 thru IV-17D-6	Change 4
IV-11-1 thru IV-11-2	Change 5	IV-17E-1 thru IV-17E-2	REV C
IV-11-3	Change 1	IV-17F-1 thru IV-17F-2	REV C
IV-11-4 thru IV-11-5	Change 3	IV-17G-1	Change 3
IV-11-6 thru IV-11-8	Change 1	IV-17G-2	REV C
IV-12-1 thru IV-12-3	Change 1	IV-18-1	Change 5

Page Numbers	Change in Effect	Page Numbers	Change in Effect
IV-18-2	Change 3	IV-20-1	Change 1
IV-18-3	Change 2	IV-20-2 thru IV-20-8	REV C
IV-18-4	REV C	IV-20A-1 thru IV-20A-2	REV C
IV-18A-1	Change 4	IV-20B-1 thru IV-20B-2	REV C
IV-18A-2	Change 2	IV-21-1	Change 2
IV-18A-3	Change 5	IV-21-2	Change 5
IV-18A-4 thru IV-18A-11	Change 2	IV-21-3 thru IV-21-4	Change 2
IV-18A-12	Change 4	IV-22-1 thru IV-22-2	Change 2
IV-18A-13 thru IV-18A-14	Change 2	IV-23-1	Change 1
IV-18B-1 thru IV-18B-2	Change 4	IV-23-2	REV C
IV-18B-3	Change 5	IV-23-3	Change 1
IV-18B-4 thru IV-18B-10	Change 2	IV-23-4	REV C
IV-18B-11	Change 4	IV-23-5 thru IV-23-6	Change 2
IV-18B-12 thru IV-18B-14	Change 2	IV-24-1 thru IV-24-6	REV C
IV-18C-1	Change 4	IV-25-1 thru IV-25-4	REV C
IV-18C-2 thru IV-18C-11	Change 2	IV-25A-1 thru IV-25A-12	REV C
IV-18C-12	Change 4	IV-26-1	Change 1
IV-18C-13 thru IV-18C-14	Change 2	IV-26-2	REV C
IV-18D-1 thru IV-18D-2	Change 4	IV-26-3 thru IV-26-4	Change 3
IV-18D-3	Change 5	IV-26-5 thru IV-26-6	Change 1
IV-18D-4 thru IV-18D-11	Change 2	IV-26A-1	REV C
IV-18D-12	Change 4	IV-26A-2	Change 1
IV-18D-13 thru IV-18D-15	Change 2	IV-26A-3 thru IV-26A-4	REV C
IV-18D-16	REV C	IV-27-1 thru IV-27-3	REV C
IV-18E-1 thru IV-18E-3	Change 2	IV-27-4	Change 2
IV-18E-4	REV C	IV-27-5 thru IV-27-8	REV C
IV-18F-1 thru IV-18F-2	REV C	IV-27A-1 thru IV-27A-2	REV C
IV-19-1 thru IV-19-2	REV C	IV-27B-1 thru IV-27B-2	REV C
IV-19A-1 thru IV-19A-4	REV C	IV-27C-1 thru IV-27C-2	REV C

Page Numbers	Change in Effect	Page Numbers	Change in Effect
IV-27D-1 thru IV-27D-2	REV C		

JOINT FLEET MAINTENANCE MANUAL

VOLUME IV

TESTS AND INSPECTIONS

RECORD OF CHANGES

CHANGE NO.	DATE	TITLE OR BRIEF DESCRIPTION	ENTERED BY (INITIALS)

(This Page Intentionally Left Blank)

JOINT FLEET MAINTENANCE MANUAL CHANGE REQUEST FORM
<p>FROM: ACTIVITY/SHIP _____ E-MAIL ADDRESS _____ CODE/DEPT/SHOP _____ DATE _____ ORIGINATOR _____ TEL EXT () _____</p>
<p>VOL-PART-PARA NO. _____ FIGURE _____ TABLE _____ PROCESSING NORMAL _____ URGENT* _____ * (Justify in rationale below if urgent is marked and transmit via e-mail as "High Importance") PROBLEM DESCRIPTION:</p>
<p>RECOMMENDED CHANGE: (Include any proposed text addition/deletion)</p>
<p>RATIONALE:</p>

E-mail to PTNH.SUBMEPP.JFMMMGR@Navy.Mil
 (If mailing, fold on dotted line on reverse side and mail to Submarine Maintenance Engineering,
 Planning and Procurement (SUBMEPP) Activity or send facsimile to (207) 438-6210.)

FOLD

Commanding Officer

OFFICIAL BUSINESS

Commanding Officer
Submarine Maintenance Engineering,
Planning and Procurement (SUBMEPP) Activity
Attn: Code 1832JM
P.O. Box 2500
Portsmouth Naval Shipyard
Portsmouth, NH 03804-2500

FOLD

JOINT FLEET MAINTENANCE MANUAL
VOLUME IV
TESTS AND INSPECTIONS
TABLE OF CONTENTS

	Page No.
LIST OF EFFECTIVE PAGES	i
RECORD OF CHANGES	v
JOINT FLEET MAINTENANCE MANUAL CHANGE REQUEST FORM.....	vii
CHAPTER 1 - INTRODUCTION	
1.1 Purpose	IV-1-1
1.2 Scope	IV-1-1
1.3 Changes and Corrections	IV-1-1
1.4 Request for Copies of the Manual	IV-1-2
Appendices	
A List of Acronyms	IV-1A-1
CHAPTER 2 - FLEET MAINTENANCE ACTIVITY ASSESSMENT	
2.1 Purpose	IV-2-1
2.1.1 Scope	IV-2-1
2.1.2 Applicability	IV-2-2
2.2 Assessment Areas	IV-2-2
2.3 Assessment Results.....	IV-2-2
2.4 Responsibilities.....	IV-2-2
2.4.1 Type Commander	IV-2-2
2.4.2 Fleet Maintenance Activity.....	IV-2-2
2.5 Assessment Findings/Corrective Action.....	IV-2-3
2.5.1 Immediate Corrective Action Required	IV-2-4
2.5.2 Corrective Action Required	IV-2-4
Appendices	
A Typical Core Capability Assessment Areas.....	IV-2A-1
B Typical Core Capability Assessment Projects	IV-2B-1
C Sample FMA Assessment Report	IV-2C-1
D FMA Assessment Deficiency Format.....	IV-2D-1
CHAPTER 3 - BOILER INSPECTION	
3.1 Purpose	IV-3-1
3.1.1 Policy.....	IV-3-1
3.2 Types of Boiler Inspections	IV-3-1
3.3 Responsibilities.....	IV-3-2
3.3.1 Naval Sea Systems Command	IV-3-2
3.3.2 Naval Surface Warfare Center, Carderock Division.....	IV-3-2
3.3.3 Fleet Commander.....	IV-3-2
3.3.4 Regional Maintenance Center.....	IV-3-3
3.3.5 Regional Maintenance Center Commanding Officers	IV-3-3
3.3.6 Immediate Superior In Command.....	IV-3-3
3.3.7 Ship Commanding Officer/Officer In Charge/Maintenance Team.....	IV-3-3

3.3.8	Regional Maintenance Center Senior Inspector.....	IV-3-3
3.3.9	Steam Generating Plant Inspector.....	IV-3-4
3.4	Inspection Scheduling.....	IV-3-4
3.5	Boiler Safety Procedures	IV-3-4
3.6	Boiler Inspections and Requirements	IV-3-5
3.6.1	Routine Inspection	IV-3-5
3.6.2	Pre-start of Availability Inspection.....	IV-3-6
3.6.3	Start of Availability Inspection.....	IV-3-6
3.6.4	Strength and Integrity Inspection.....	IV-3-6
3.6.5	Industrial Support Visit Inspection	IV-3-6
3.6.6	Completion of Availability Inspection.....	IV-3-6
3.6.7	Inactivation or Reactivation Inspection	IV-3-6
3.6.8	Engineer Officer Inspection.....	IV-3-6
3.6.9	Special Inspection.....	IV-3-7
3.6.10	Operational Assessments	IV-3-7
3.7	Boiler Inspection Guidelines and Reports	IV-3-7
3.7.1	Guidelines.....	IV-3-7
3.7.2	Reports.....	IV-3-7
3.8	Boiler Inspection Preparation	IV-3-8
3.9	Boiler Inspection.....	IV-3-8
3.9.1	Boiler Inspection Forms.....	IV-3-8
3.9.2	Boiler Inspection Areas	IV-3-8
3.9.3	Completion of Inspection.....	IV-3-9
3.10	Automatic Boiler Control Systems/Online Verification Guidelines.....	IV-3-9
3.11	Boiler Flexibility Tests	IV-3-10
3.12	Certified Boiler Water and Feedwater Tester Requirements	IV-3-10
3.13	Operating and Casualty Procedures	IV-3-10
Appendices		
A	Sample Boiler Inspection Request Message	IV-3A-1
B	Sample Inspection Confirmation Message	IV-3B-1
C	Summary of Boiler Inspection Scheduling and Responsibilities	IV-3C-1
D	Sample Boiler Inspection Report Cover Letter.....	IV-3D-1
E	Sample Boiler Inspection - RBO/Severely Degraded Deficiencies Message	IV-3E-1
F	Sample RBO Rescission Message	IV-3F-1
G	Sample 30 Day Update Message	IV-3G-1

CHAPTER 4 - DIESEL ENGINES

4.1	Purpose	IV-4-1
4.2	Diesel Engine Inspector Certification.....	IV-4-1
4.3	Diesel Inspections.....	IV-4-2
4.3.1	Diesel Engines Requiring Inspections	IV-4-2
4.3.2	Periodicity of Inspections	IV-4-2
4.3.3	Inspection Scheduling.....	IV-4-4
4.3.3.1	Inspection Deferrals	IV-4-5
4.3.4	Inspection Phases.....	IV-4-5
4.3.5	Preparation for Diesel Engine Inspection	IV-4-5
4.3.6	Inspection Findings.....	IV-4-6
4.3.6.1	Repair Before Operating	IV-4-6
4.3.6.2	Major Deficiency	IV-4-6
4.3.6.3	Minor Deficiency	IV-4-7
4.3.6.4	Re-inspections.....	IV-4-7

4.3.6.5	Recurring Discrepancies	IV-4-7
4.3.6.6	Component Certification (Aircraft Carriers only).....	IV-4-7
4.4	Reporting Requirements	IV-4-7
4.5	Operation and Maintenance	IV-4-8
4.6	Compliance	IV-4-9
4.7	Subject Matter Expert in the Repair and Maintenance of Diesel Engines	IV-4-9
Appendices		
A	Assessment/Inspection Main Propulsion Diesel Engine and Ship Service Diesel Generators for LSD-41/49 and LPD-17 Class Ships	IV-4A-1

CHAPTER 5 - MARINE SANITATION DEVICES

5.1	Purpose	IV-5-1
5.1.1	Scope	IV-5-1
5.2	Certification	IV-5-1
5.3	Responsibilities	IV-5-1
5.3.1	Type Commander/Immediate Superior In Command.....	IV-5-1
5.3.2	Commanding Officer/Officer In Charge.....	IV-5-1
5.4	System Maintenance and Inspection.....	IV-5-2
5.4.1	Fleet Maintenance Activity Maintenance	IV-5-2
5.5	Technical System Assessment	IV-5-2
5.6	Training	IV-5-2

CHAPTER 6 - OXYGEN AND NITROGEN SYSTEMS

6.1	Purpose	IV-6-1
6.2	Precautions.....	IV-6-1
6.3	Aviators Breathing Oxygen Testing	IV-6-1
6.4	Operations and Maintenance	IV-6-2

CHAPTER 7 - ACCOUNTABILITY AND CERTIFICATION OF NUCLEAR PROPULSION PLANT TEST AND SUPPORT EQUIPMENT

7.1	Purpose	IV-7-1
7.1.1	Discussion.....	IV-7-1
7.2	Nuclear Test Equipment Categories	IV-7-1
7.3	Action	IV-7-1
7.4	Procurement.....	IV-7-1
7.5	Nuclear Test Equipment Certification	IV-7-2
7.5.1	Electronic/Electrical Test Equipment	IV-7-2
7.5.2	Mechanical Test Equipment	IV-7-2
7.5.3	Recertification Following Reference Revision	IV-7-2
7.5.4	Certification Documentation.....	IV-7-2
7.6	Accountability.....	IV-7-3
7.6.1	Lost/Damaged Test Equipment.....	IV-7-4
7.6.2	Cleanliness and Foreign Material Exclusion	IV-7-4
7.6.3	Stowage	IV-7-4
7.6.4	Inventory.....	IV-7-4

Appendices

A	Nuclear Test Equipment Check-Out/Check-In Form	IV-7A-1
B	Nuclear Support and Test Equipment Certification Record.....	IV-7B-1

CHAPTER 8 - WEAPONS AND CARGO ELEVATOR ASSESSMENTS

8.1	Purpose	IV-8-1
8.1.1	Background.....	IV-8-1
8.2	Elevator Support Unit	IV-8-1
8.3	Ship's Force Assessment Responsibilities	IV-8-1
8.4	Elevator Support Unit Evolutions	IV-8-1
8.4.1	Material Condition Assessment Visit	IV-8-1
8.4.2	Repair Visit.....	IV-8-2
8.4.3	In Process Review.....	IV-8-2
8.4.4	On-Board Maintenance Training	IV-8-2
8.4.5	Integrated Logistics Support.....	IV-8-2
8.5	Visit Scheduling.....	IV-8-2
8.6	Reports.....	IV-8-3

CHAPTER 9 - SYSTEM TEST CHECK LIST

9.1	Purpose	IV-9-1
9.1.1	Background.....	IV-9-1
9.2	General Instructions.....	IV-9-1
9.3	Record Retention	IV-9-2

Appendices

A	Nuclear Test Rig Determination and Inspection Check List.....	IV-9A-1
B	Non-Nuclear Test Rig Determination and Inspection Check List	IV-9B-1
C	Nuclear/Non-Nuclear Pre-Test Inspection Check List	IV-9C-1
D	Nuclear/Non-Nuclear Performance of Test Check List	IV-9D-1

CHAPTER 10 - WORK AUTHORIZATION AND CONTROL

10.1	Purpose	IV-10-1
10.2	Work Authorization	IV-10-1
10.3	Work Authorization Control.....	IV-10-1
10.4	Work Authorization System	IV-10-2
10.4.1	Administration	IV-10-2
10.4.1.1	Work Authorization Form.....	IV-10-2
10.4.1.2	Work Authorization Log	IV-10-2
10.4.1.3	Technical Work Document Record Sheet	IV-10-2
10.4.1.4	Work Authorization Form Continuation and Revision Sheets	IV-10-2
10.4.1.5	Numbering Work Authorization Form Continuation and Revision Sheets	IV-10-2
10.4.2	Work Authorization Procedure	IV-10-3
10.4.3	Transfer of Non-Nuclear Systems and Nuclear Instrumentation and Control Systems (Depot availabilities only)	IV-10-3
10.4.4	Work Authorization Form Revisions.....	IV-10-5
10.4.5	Centralized Work Control Procedures	IV-10-6
10.4.6	Equipment Tagout Procedures.....	IV-10-6
10.4.7	Barrier Criteria.....	IV-10-6
10.4.8	Safety of Ship Maintenance Item Identification, Listing and Control (Submarines only).....	IV-10-7
10.4.9	Ship in Dry Dock (Submarines Under Joint Fleet Maintenance Manual Controls).....	IV-10-9
10.5	Final Certification, Close-Out and Re-entry of Submarine Spaces, Tanks and Voids	IV-10-10

10.5.1 Purpose IV-10-10
 10.5.2 Discussion IV-10-10
 10.5.3 Action IV-10-10
 10.5.4 Applicability IV-10-11

Appendices

A Work Authorization Form IV-10A-1
 B Technical Work Document Record Sheet..... IV-10B-1
 C Work Authorization Form Continuation and Revision Sheets..... IV-10C-1
 D Barrier Criteria for Hull Penetrations IV-10D-1
 E Safety of Ship Maintenance Item List Example IV-10E-1
 F Safety of Ship Maintenance Item List IV-10F-1
 G Procedures and Safety Precautions for Entering Submarine Spaces, Tanks and Voids..... IV-10G-1
 H Close-Out Inspection Check-Off List IV-10H-1

CHAPTER 11 - TECHNICAL DATA AND INFORMATION MANAGEMENT

11.1 Purpose IV-11-1
 11.1.1 Discussion..... IV-11-1
 11.2 Shipboard Technical Document Management IV-11-1
 11.3 Technical Libraries IV-11-2
 11.3.1 Technical Library Supervisor IV-11-2
 11.3.1.1 Technical Library Non-Supervisory Personnel IV-11-4
 11.3.2 Technical Library Materials..... IV-11-5
 11.3.2.1 Indices..... IV-11-5
 11.3.2.2 Technical Manuals IV-11-5
 11.3.2.3 Drawings IV-11-5
 11.3.2.4 Handbooks and Cataloging IV-11-5
 11.3.2.5 Military Specifications and Standards IV-11-5
 11.3.2.6 Documents and Lists..... IV-11-6
 11.3.2.7 Instructions, Technical Publications and Bulletins IV-11-6
 11.3.2.8 Repair Standards IV-11-6
 11.4 Index of Technical Publications and Ship's Drawing Index IV-11-6
 11.4.1 Index of Technical Publications..... IV-11-6
 11.4.2 Ship's Drawing Index..... IV-11-6
 11.5 Maintenance Support Centers (Aircraft Carriers only) IV-11-7

CHAPTER 12 - HULL INSPECTION OF SHIPS AND CRAFT

12.1 Purpose IV-12-1
 12.1.1 Scope IV-12-1
 12.1.2 Discussion..... IV-12-1
 12.2 Action IV-12-2
 12.3 Reports..... IV-12-3

Appendices

A Sample Layout of Inspection Areas IV-12A-1
 B Hull Reporting Format..... IV-12B-1

CHAPTER 13 - WEIGHT HANDLING EQUIPMENT TESTING AND INSPECTION

13.1 Purpose IV-13-1
 13.1.1 Scope IV-13-2
 13.2 Naval Sea Systems Command Afloat Requirements IV-13-2
 13.2.1 Definitions IV-13-2
 13.2.2 Procedure IV-13-2
 13.2.3 Load Test Types and Duration..... IV-13-3

13.2.3.1	Static Load Test	IV-13-3
13.2.3.2	Dynamic Load Test.....	IV-13-4
13.2.3.3	Rated Load Test.....	IV-13-4
13.2.4	Load Test Periodicity.....	IV-13-4
13.2.5	Crane Certification Program.....	IV-13-5
13.2.6	Daily Inspections	IV-13-5
13.2.7	Use of Nylon Straps.....	IV-13-5
13.2.8	Weight Test Procedure Matrix.....	IV-13-5
13.2.9	Identification of Equipment	IV-13-6
13.2.10	Witnessing Qualification	IV-13-7
13.2.11	Record Keeping	IV-13-7
13.3	Naval Facilities Engineering Command Ashore Requirements.....	IV-13-7
13.3.1	Certification Program	IV-13-7
13.3.2	Operator Licensing Program.....	IV-13-7
13.3.2.1	Operator Qualification and Testing.....	IV-13-7
13.3.2.2	Licensing Procedures and Documentation.....	IV-13-7
13.3.3	Inspections	IV-13-7
13.3.4	Test Procedures.....	IV-13-7
13.3.5	Special Purpose Service.....	IV-13-7
13.4	Slings	IV-13-7
13.4.1	Crane Rigging Gear and Miscellaneous Equipment	IV-13-8

CHAPTER 14 - MAGAZINE SPRINKLER INSPECTION REQUIREMENTS

14.1	Purpose	IV-14-1
14.2	Responsibilities	IV-14-1
14.2.1	Commanding Officers	IV-14-1
14.2.2	Verification Activity.....	IV-14-1
14.2.3	Immediate Superior In Command.....	IV-14-2

CHAPTER 15 - CIRCUIT BREAKERS

15.1	Purpose	IV-15-1
15.2	Circuit Breaker Function and Acquisition on Navy Ships.....	IV-15-1
15.3	Circuit Breaker Overhaul Facilities and Part Procurement.....	IV-15-1
15.3.1	Submarines	IV-15-1
15.4	Navy Policy on Shipboard Circuit Breaker Maintenance and Overhaul.....	IV-15-2

CHAPTER 16 - AIRCRAFT LAUNCH AND RECOVERY SYSTEMS FOR AIRCRAFT CARRIERS ONLY

16.1	Purpose	IV-16-1
16.1.1	Scope	IV-16-1
16.2	Aircraft Launch and Recovery Equipment Maintenance Program.....	IV-16-1
16.2.1	Applicability	IV-16-1
16.2.2	Objectives	IV-16-1
16.2.3	Responsibilities.....	IV-16-1
16.2.4	Management Team	IV-16-1
16.2.5	Assist Visits	IV-16-2
16.2.6	Audits.....	IV-16-2
16.3	Aviation Certification	IV-16-2
16.4	Carrier And Field Service Unit.....	IV-16-2
16.4.1	Responsibilities.....	IV-16-3
16.4.1.1	Aircraft Carrier Commanding Officer	IV-16-3
16.4.1.2	Industrial/Repair Activity	IV-16-3
16.5	Naval Aviation Depot.....	IV-16-3

16.6 Naval Aviation Depot Voyage Repair Team IV-16-4

CHAPTER 17 - STEAM CATAPULT INSPECTION

17.1 Purpose IV-17-1
 17.1.1 Policy IV-17-1

17.2 Types of Inspections IV-17-1

17.3 Responsibilities IV-17-2
 17.3.1 Naval Sea Systems Command IV-17-2
 17.3.2 Naval Surface Warfare Center, Carderock Division IV-17-2
 17.3.3 Type Commander IV-17-3
 17.3.4 Regional Support Group/Regional Maintenance Center/Fleet Maintenance Activity
 Commanding Officers IV-17-3
 17.3.5 Ship Commanding Officer IV-17-3
 17.3.6 Regional Maintenance Center Senior Inspector IV-17-3
 17.3.7 Steam Generating Plant Inspector IV-17-3

17.4 Inspection Scheduling IV-17-4

17.5 Safety Procedures IV-17-4

17.6 Catapult Accumulator Inspections and Requirements IV-17-5
 17.6.1 Routine Inspection IV-17-5
 17.6.2 Pre-Start of Availability Inspection IV-17-5
 17.6.3 Start of Availability Inspection IV-17-5
 17.6.4 Strength and Integrity Inspection IV-17-5
 17.6.5 Industrial Support Visit Inspection IV-17-5
 17.6.6 Completion of Availability Inspection IV-17-5
 17.6.7 Inactivation or Reactivation Inspection IV-17-6
 17.6.8 Special Inspections IV-17-6

17.7 Inspection Guidelines and Reports IV-17-6
 17.7.1 Guidelines IV-17-6
 17.7.2 Reports IV-17-7

17.8 Catapult Accumulator Inspection Preparation IV-17-7

17.9 Catapult Accumulator Inspection IV-17-7
 17.9.1 Catapult Accumulator Inspection Forms IV-17-7
 17.9.2 Catapult Accumulator Inspection Areas IV-17-7
 17.9.3 Completion of Inspection IV-17-8
 17.9.4 Automatic Controls Systems Inspection Guidelines IV-17-8
 17.9.5 Operating and Casualty Procedures IV-17-8

Appendices

A Sample Catapult Accumulator Inspection Request IV-17A-1
 B Sample Inspection Confirmation Letter IV-17B-1
 C Summary of Catapult Accumulator Inspection Scheduling and Responsibilities IV-17C-1
 D₁ Sample Catapult Accumulator Inspection Report Cover Letter IV-17D-1
 D₂ Sample 5 Year Strength and Integrity Catapult Accumulator Inspection Report Cover
 Letter IV-17D-3
 D₃ Sample Other Catapult Accumulator Inspection Report Cover Letter IV-17D-5
 E Sample Catapult Accumulator Inspection RBO/Severely Degraded Deficiencies Message IV-17E-1
 F Sample 30 Day Update Message IV-17F-1
 G Sample Catapult Accumulator Rescission Message IV-17G-1

CHAPTER 18 - SUBMARINE SALVAGE INSPECTION

18.1 Purpose IV-18-1

18.2 Inspections IV-18-1
 18.2.1 Periodicity IV-18-1

18.2.2 Procedures and Reports IV-18-1
18.2.3 Inspection Resources IV-18-1
18.3 Responsibilities IV-18-2
18.3.1 Immediate Superior In Command IV-18-2
18.3.2 Commanding Officer/Officer In Charge IV-18-2
18.3.3 Senior Inspecting Officer IV-18-2
Appendices
A SSN 21 Class Submarine Salvage Inspection Check-Off List IV-18A-1
B SSN 688 Class Submarine Salvage Inspection Check-Off List IV-18B-1
C SSBN/SSGN 726 Class Submarine Salvage Inspection Check-Off List IV-18C-1
D SSN 774 Class Submarine Salvage Inspection Check-Off List IV-18D-1
E Sample Pre-Inspection Information/Certification IV-18E-1
F Sample Report of Salvage Inspection Forwarding Letter IV-18F-1

CHAPTER 19 - RETENTION OF MATERIAL DEFICIENCY REPORTS AND RECORDS OF EQUIPMENT CHARACTERISTICS AND TESTS

19.1 Purpose IV-19-1
19.2 Inspection Reports IV-19-1
19.3 Retention of Records of Equipment Characteristics and Tests IV-19-1
Appendices
A Bearing Log (Submarines Only) IV-19A-1

CHAPTER 20 - DIVER LIFE SUPPORT SYSTEMS, SUBMARINE RESCUE CHAMBER AND DRY DECK SHELTER MAINTENANCE AND CERTIFICATION

20.1 Purpose IV-20-1
20.2 Diver Life Support System Maintenance and Certification IV-20-1
20.2.1 General IV-20-1
20.2.2 Objective IV-20-1
20.2.3 United States Navy Diving and Manned Hyperbaric Systems Safety Certification IV-20-1
20.2.4 System Certification IV-20-2
20.2.5 Maintenance Guidelines IV-20-2
20.2.6 Formal System Surveys IV-20-2
20.2.7 Certification Maintenance Requirements IV-20-3
20.2.8 Action IV-20-3
20.2.9 Commanding Officer/Officer In Charge Responsibilities IV-20-4
20.3 Submarine Rescue Chamber Maintenance and Certification IV-20-5
20.3.1 Certification IV-20-5
20.3.2 Action IV-20-5
20.4 Dry Deck Shelter Maintenance and Certification IV-20-6
20.4.1 Certification IV-20-6
20.4.2 Action IV-20-6
Appendices
A System Certification Requirements IV-20A-1
B Submarine Rescue Chamber Scope of Certification Items IV-20B-1

CHAPTER 21 - SUBMARINE OXYGEN GENERATING PLANTS

21.1 Purpose IV-21-1
21.1.1 Policy IV-21-1
21.1.2 Background IV-21-2
21.2 Responsibilities IV-21-2
21.2.1 Immediate Superior In Command IV-21-2
21.2.2 Performance Monitoring Team IV-21-2

21.2.3 Commanding Officer IV-21-3

21.3 Requirements for Shipboard Personnel Qualification..... IV-21-3

 21.3.1 Training IV-21-3

 21.3.2 Watchstanding Prerequisites..... IV-21-4

CHAPTER 22 - SUBMARINE ANTENNA TESTING

22.1 Purpose IV-22-1

22.2 Background IV-22-1

22.3 Policy IV-22-1

 22.3.1 Hydrostatic Pressure Testing IV-22-1

 22.3.2 Fleet Maintenance IV-22-1

22.4 Procedure IV-22-2

CHAPTER 23 - GAS TURBINE ENGINE INSPECTION FOR SURFACE FORCE SHIPS

23.1 Purpose IV-23-1

 23.1.1 Discussion..... IV-23-1

23.2 Marine Gas Turbine Inspector IV-23-1

 23.2.1 Certification IV-23-1

 23.2.2 Authorized Functions and Responsibilities..... IV-23-2

 23.2.2.1 Naval Sea Systems Command IV-23-2

 23.2.2.2 Naval Surface Warfare Center, Carderock Division..... IV-23-2

 23.2.2.3 Fleet Commander..... IV-23-2

 23.2.2.4 Regional Maintenance Center IV/23-2

 23.2.2.5 Regional Maintenance Center Commanding Officers IV-23-3

 23.2.2.6 Immediate Superior In Command..... IV-23-3

 23.2.2.7 Ship Commanding Officer/Officer In Charge/Maintenance Team IV-23-3

 23.2.2.8 Marine Gas Turbine Inspectors..... IV-23-3

23.3 Gas Turbine Inspections and Requirements..... IV-23-4

 23.3.1 Applicability IV-23-4

 23.3.2 Pre-Planned Major Maintenance Availability..... IV-23-4

 23.3.3 Pre-Deployment..... IV-23-4

 23.3.4 Gas Turbine Bulletin Inspections..... IV-23-4

 23.3.5 Casualties..... IV-23-4

23.4 Requesting Procedures..... IV-23-5

23.5 Preparation for Inspection..... IV-23-5

23.6 Inspection Procedures IV-23-5

 23.6.1 Post Casualty Inspections IV-23-5

 23.6.2 Pre-Availability Inspections IV-23-5

23.7 Inspection Criteria IV-23-5

 23.7.1 Repair Before Operating..... IV-23-5

 23.7.2 Major Deficiencies..... IV-23-5

 23.7.3 Minor Deficiencies IV-23-6

23.8 Inspection Results IV-23-6

CHAPTER 24 - WOOD HULLED SHIPS AND CRAFT

24.1 Purpose IV-24-1

24.2 Wood Decay IV-24-1

 24.2.1 Primary Causes IV-24-1

 24.2.2 Recognition..... IV-24-1

 24.2.3 Preventive Measures..... IV-24-1

24.2.4	Corrective Measures	IV-24-2
24.3	Deck and Hull Maintenance	IV-24-2
24.3.1	Inspection Requirements.....	IV-24-2
24.3.2	Maintenance Policies	IV-24-2
24.3.3	Deck Covering Repairs	IV-24-3
24.3.4	Caulking Techniques	IV-24-3
24.3.5	Weather Deck/Planked Deck Repair	IV-24-3
24.3.6	Underwater Planking Repairs	IV-24-4
24.4	Surface Preparation and Painting.....	IV-24-4
24.4.1	General Techniques	IV-24-4
24.4.2	Preparation and Painting Policies	IV-24-4
24.5	Wooden Hull Bottom Sheathing.....	IV-24-5
24.6	Wooden Sea Chest Foundations	IV-24-5

CHAPTER 25 - GAS FREE ENGINEERING INSPECTIONS

25.1	Purpose	IV-25-1
25.2	Scope	IV-25-1
25.3	Discussion.....	IV-25-1
25.4	Oversight	IV-25-3

Appendices

A	Gas Free Engineering Program Assessment Sheet	IV-25A-1
---	---	----------

CHAPTER 26 - BOARD OF INSPECTION AND SURVEY INSPECTIONS POLICY

26.1	Purpose	IV-26-1
26.1.1	Scope	IV-26-1
26.1.2	Background.....	IV-26-1
26.1.3	Discussion.....	IV-26-1
26.1.4	Policy	IV-26-2
26.2	Responsibilities.....	IV-26-2
26.2.1	Type Commander	IV-26-2
26.2.2	Immediate Superior In Command.....	IV-26-2
26.2.3	Ship Commanding Officer.....	IV-26-3
26.2.4	INSURV Coordinator	IV-26-3
26.2.5	Regional Maintenance Centers	IV-26-3
26.3	Inspection Scheduling.....	IV-26-3
26.3.1	Combined Trial/Acceptance Trial Inspections	IV-26-3
26.3.2	Guarantee Material Inspection/Final Contract Trials.....	IV-26-4
26.3.3	Material Inspections.....	IV-26-4
26.4	Preparation for INSURV Inspection.....	IV-26-4
26.4.1	Active Preparation	IV-26-4
26.4.2	Ship's Internal Organization.....	IV-26-4
26.4.3	Updating the Current Ship's Maintenance Project	IV-26-5
26.5	Board of Inspection and Survey Inspection Conduct and Documentation	IV-26-5
26.5.1	Inspection Conduct	IV-26-5
26.5.2	Deficiency Documentation	IV-26-5
26.6	Post Board of Inspection and Survey Inspection Actions	IV-26-5
26.6.1	Deficiency Processing and Resolution.....	IV-26-5
26.6.2	Post INSURV Inspection Reports.....	IV-26-6
26.6.3	Unsatisfactory Finding.....	IV-26-6

Appendices

A INSURV Plan of Action and Milestones IV-26A-1

CHAPTER 27 - REBOILER INSPECTION

27.1 Purpose IV-27-1
 27.1.1 Policy IV-27-1

27.2 Types of Inspections IV-27-1

27.3 Responsibilities IV-27-2
 27.3.1 Naval Sea Systems Command IV-27-2
 27.3.2 Naval Surface Warfare Center, Carderock Division IV-27-2
 27.3.3 Type Commander IV-27-2
 27.3.4 Regional Maintenance Center Commanding Officer IV-27-3
 27.3.5 Ship's Commanding Officer IV-27-3
 27.3.6 Regional Maintenance Center Senior Inspector IV-27-3
 27.3.7 Steam Generating Plant Inspector IV-27-3

27.4 Inspection Scheduling IV-27-3

27.5 Safety Procedures IV-27-3

27.6 Steam Reboiler Inspections and Requirements IV-27-4
 27.6.1 Eddy Current Inspection IV-27-4
 27.6.2 Routine Inspection IV-27-4
 27.6.3 Start of Availability Inspection IV-27-4
 27.6.4 Strength and Integrity Inspection IV-27-4
 27.6.5 Industrial Support Visit Inspection IV-27-4
 27.6.6 Completion of Availability Inspection IV-27-5
 27.6.7 Inactivation or Reactivation IV-27-5
 27.6.8 Special Inspection IV-27-5
 27.6.9 Annual Inspection IV-27-5
 27.6.10 Operational Assessments IV-27-5

27.7 Reboiler Inspection Guidelines and Reports IV-27-5
 27.7.1 Guidelines IV-27-5
 27.7.2 Reports IV-27-5

27.8 Steam Reboiler Inspection Preparation IV-27-6

27.9 Steam Reboiler Inspection IV-27-6
 27.9.1 Steam Reboiler Inspection Forms IV-27-6
 27.9.2 Steam Reboiler Inspection Areas IV-27-6
 27.9.3 Completion of Inspection IV-27-6

27.10 Steam Reboiler Control Systems/Online Verification Guidelines IV-27-6

Appendices

A Sample Steam Reboiler Inspection Request IV-27A-1
 B Sample Inspection Confirmation Message IV-27B-1
 C Sample Steam Reboiler Inspection Report Cover Letter IV-27C-1
 D Sample Reboiler Inspection RBO/Severely Degraded Deficiencies Message IV-27D-1

(This Page Intentionally Left Blank)

VOLUME IV
CHAPTER 1
INTRODUCTION

REFERENCES.

- (a) OPNAVINST 3120.32 - Standard Organization and Regulations of the U.S. Navy
- (b) OPNAVINST 4700.7 - Maintenance Policy for U.S. Naval Ships
- (c) COMLANTFLTINST 5400.2 - U.S. Atlantic Fleet Regulations
- (d) COMPACFLTINST 5400.3 - U.S. Pacific Fleet Regulations
- (e) NAVSEAINST 4790.8/OPNAVINST 4790.4 - Ships' Maintenance and Material Management (3-M) Manual

LISTING OF APPENDICES.

- A List of Acronyms

1.1 PURPOSE. To provide guidance in the execution and management for tests, inspections and assessments applicable to units of the Navy.

- a. The Foreword of this manual contains a master listing of all references used throughout the Joint Fleet Maintenance Manual. These references are arranged in alphanumeric order to facilitate their procurement for use with this manual. References used in specific chapters of this volume are listed at the beginning of each chapter in the order in which they appear in the chapter text.
- b. Acronyms are identified when they are initially used in this volume. Appendix A of this chapter contains a master listing of acronyms used throughout this volume.
- c. References (a) through (e) shall be used in conjunction with this manual, however, the requirements of this manual shall **not** take precedence over these higher authority directives, or technical directives from applicable Systems Commands. Where conflicts exist with previously issued Fleet Commander, Commander, Naval Reserve Forces (COMNAVRESFOR), Type Commander (TYCOM) letters, transmittals and instructions, other than references (c) and (d), this manual shall take precedence. Conflicts shall be reported to the cognizant TYCOM for resolution.

1.2 SCOPE. This volume applies to all ships and shore activities under the cognizance of Commander, United States Fleet Forces Command (COMUSFLTFORCOM), Commander, Pacific Fleet (COMPACFLT) and COMNAVRESFOR. This volume is not intended to be all encompassing, since the guidance for many elements of the maintenance programs and their execution are promulgated by higher/technical authority (e.g., Naval Ships' Technical Manuals (NSTM), Office of the Chief of Naval Operations Instruction (OPNAVINST)).

- a. This volume contains general topics, applicable to all ships and units under the cognizance of COMUSFLTFORCOM or COMPACFLT. In those cases where chapters, sections and/or paragraphs of chapters are not applicable to certain Forces, an applicability statement has been used for clarification.
- b. Equipment under the cognizance of the Strategic Systems Programs and Naval Sea Systems Command Nuclear Propulsion Directorate (NAVSEA 08) is maintained in accordance with Strategic Systems Programs and NAVSEA 08 directives, respectively.

1.3 CHANGES AND CORRECTIONS. Changes and corrections will be issued as required. Comments and suggestions for improving or changing this volume are invited. Address comments, recommendations, and requested changes to Submarine Maintenance Engineering, Planning and Procurement Activity utilizing the change request form located in the front of this manual. If changes are submitted in electronic format, facsimile or E-mail, each change request shall contain the information required on the change request form.

1.4 REQUEST FOR COPIES OF THE MANUAL. Activities on distribution for the Joint Fleet Maintenance Manual (JFMM) that require additional copies or activities wanting to be added to distribution should submit a letter to their applicable TYCOM, identifying CD-ROM/paper requirements along with justification for the request. To the maximum extent possible, technical publications libraries at each activity will receive all copies of the manual for that activity and coordinate local distribution and updates.

APPENDIX A
LIST OF ACRONYMS

3-M	Maintenance and Material Management
ABC	Automatic Boiler Control
ABO	Aviators Breathing Oxygen
ACN	Advance Change Notice
AEL	Allowance Equipage List
AEOG	Automated Electrolytic Oxygen Generator
AIMD	Aviation Intermediate Maintenance Department
ALRE	Aircraft Launch and Recovery Equipment
ALREMP	Aircraft Launch and Recovery Equipment Maintenance Program
APL	Allowance Parts List
ATIS	Advanced Technical Information Support
AWR	Automated Work Request
BIRMIS	Boiler Inspection and Repair Maintenance Information System
CAFSU	Carrier And Field Service Unit
CAI	Completion of Availability Inspection
CASREP	Casualty Report
CD-ROM	Compact Disk
CHT	Collection, Holding and Transfer
CMAV	Continuous Maintenance Availability
CNO	Chief of Naval Operations
COMNAVAIRLANT	Commander Naval Air Force Atlantic
COMNAVAIRPAC	Commander Naval Air Force Pacific
COMNAVRESFOR	Commander Naval Reserve Force
COMNAVSURFLANT	Commander Naval Surface Force Atlantic
COMNAVSURFPAC	Commander Naval Surface Force Pacific
COMPACFLT	Commander, Pacific Fleet
COMSUBLANT	Commander Submarine Force Atlantic
COMSUBPAC	Commander Submarine Force Pacific
COMSUBRON	Commander Submarine Squadron
COMUSFLTFORCOM	Commander, United States Fleet Forces Command
COSAL	Coordinated Shipboard Allowance List
CPO	Chief Petty Officer
CSMP	Current Ship's Maintenance Project
CWP	Controlled Work Package
DCA	Damage Control Assistant
DDS	Dry Deck Shelter
DEI	Diesel Engine Inspector
DFS	Departure From Specification
DFT	De-Aerating Feed Tank
DISSUB	Disabled Submarine
DLSS	Diver Life Support System
DMP	Depot Modernization Period
DO	Duty Officer
DOD	Department of Defense
DOP	Designated Overhaul Point
ECI	Eddy Current Inspection
EDG	Emergency Diesel Generator
EDO	Engineering Duty Officer
EOG	Electrolytic Oxygen Generator

EOOW	Engineering Officer Of the Watch
EOSS	Engineering Operational Sequencing System
ESU	Elevator Support Unit
FMA	Fleet Maintenance Activity
FWP	Formal Work Package
GFE	Gas Free Engineering
GS	Gas Turbine Technician
GTB	Gas Turbine Bulletin
GTRR	Gas Turbine Readiness Review
HSC	Hierarchical Structure Code
ILPE	Integrated Low Pressure Electrolyzer
ILS	Integrated Logistics Support
INSURV	Board of Inspection and Survey
IRAC	Interim Rapid Action Change
ISIC	Immediate Superior In Command
ISV	Industrial Support Visit
ITP	Index of Technical Publications
JCN	Job Control Number
JFMM	Joint Fleet Maintenance Manual
JSN	Job Sequence Number
LCEM	Life Cycle Engineering Manager
LET	Logistics and Escape Trunk
LMD	Library Management Database
LPE	Low Pressure Electrolyzer
LWC	Lead Work Center
MDS	Maintenance Data System
METCAL	Metrology and Calibration
MGTI	Marine Gas Turbine Inspector
MGTIS	Marine Gas Turbine Information System
MI	Material Inspection
MILSPEC	Military Specification
MIP	Maintenance Index Page
MOA	Memorandum of Agreement
MPA	Main Propulsion Assistant
MPDE	Main Propulsion Diesel Engine
MR	Maintenance Requirement
MRC	Maintenance Requirement Card
MS	Maintenance Standard
MSC	Maintenance Support Center
MSD	Marine Sanitation Device
NATEC	Naval Air Technical Data and Engineering Service Command
NAVAIR	Naval Air Systems Command
NAVAIRWARCEN	Naval Air Warfare Center
NAVFAC	Naval Facilities Engineering Command
NAVSEA	Naval Sea Systems Command
NAVSEA 08	Naval Sea Systems Command Nuclear Propulsion Directorate
NAVSUP	Naval Supply Systems Command
NEC	Navy Enlisted Classification

NFPA	National Fire Protection Agency
NMF	Naval Maintenance Facility
NSDSA	Naval Systems Data Support Activity
NSF	Nuclear Support Facility
NSN	National Stock Number
NSTM	Naval Ship's Technical Manual
NSWCCD	Naval Surface Warfare Center, Carderock Division
NSWCCD-SSES	Naval Surface Warfare Center, Carderock Division - Ship System Engineering Station
NTE	Nuclear Test Equipment
O ₂ -N ₂	Oxygen - Nitrogen
OEM	Original Equipment Manufacturer
OJT	On the Job Training
OOD	Officer Of the Deck
OPNAVINST	Office of the Chief of Naval Operations Instruction
PLAD	Plain Language Address Directory
PMS	Planned Maintenance System
PMT	Performance Monitoring Team
POAM	Plan of Action and Milestones
PQS	Personnel Qualification Standard
PSAI	Pre-Start of Availability Inspection
QA	Quality Assurance
QPL	Qualified Products List
RBO	Repair Before Operating
REC	Re-Entry Control
RIRMIS	Reboiler Inspection and Repair Management Information System
RMC	Regional Maintenance Center
RMCSG	Regional Maintenance Center Support Group
RPM	Reactor Plant Manual
RSG	Regional Support Group
RTE	Remote Temperature Element
SAI	Start of Availability Inspection
SAMM	Shipboard Automated Maintenance Module
SCA	System Certification Authority
SCIRMIS	Steam Catapult Inspection and Repair Maintenance Information System
SCSC	System Certification Survey Cards
SDI	Ship's Drawing Index
SEIE	Submarine Escape Immersion Ensemble
SEMAT	Systems and Equipment Material Assessment Team
SGPI	Steam Generating Plant Inspector
SME	Subject Matter Expert
SOC	Scope Of Certification
SOSMIL	Safety Of Ship Maintenance Item List
SRC	Submarine Rescue Chamber
SRDRS	Submarine Rescue Diving Recompression System
SSDG	Ship Service Diesel Generator
SSES	Ship System Engineering Station
SUBSAFE	Submarine Safety
SWL	Safe Working Load
TDKM	Technical Data Knowledge Management

TDMIS	Technical Data Management Information System
TRF	TRIDENT Refit Facility
TWD	Technical Work Document
TYCOM	Type Commander
VLA	Visual Landing Aids
VRT	Voyage Repair Team
VSV	Variable Stator Vane
WAF	Work Authorization Form
WC	Work Center
WHE	Weight Handling Equipment

VOLUME IV

CHAPTER 2

FLEET MAINTENANCE ACTIVITY ASSESSMENT

REFERENCES.

- (a) NAVSEA S9810-AA-GTP-010 - Intermediate Maintenance Activity Work Center Requirements Manual
- (b) COMPACFLTINST 4700.5/COMLANTFLTINST 4700.1 - Navy Afloat Maintenance Training Strategy (NAMTS) Job Qualification Requirements (JQR) Management
- (c) NAVSEAINST 4790.8/OPNAVINST 4790.4 - Ships' Maintenance and Material Management (3-M) Manual
- (d) OPNAVINST 5100.23 - Navy Occupational Safety and Health (NAVOSH) Program Manual
- (e) OPNAVINST 5100.19 - Navy Occupational Safety and Health (NAVOSH) Program Manual for Forces Afloat
- (f) OPNAVINST 3120.32 - Standard Organization and Regulations of the U.S. Navy
- (g) NAVSEA SS521-AG-PRO-010 - U.S. Navy Diving Manual

LISTING OF APPENDICES.

- A Typical Core Capability Assessment Areas
- B Typical Core Capability Assessment Projects
- C Sample FMA Assessment Report
- D FMA Assessment Deficiency Format

2.1 PURPOSE. To provide guidance for conducting a Fleet Maintenance Activity (FMA) Assessment, including areas to be assessed, responsibilities for conducting the assessment and deficiency correction and reporting requirements.

2.1.1 Scope. Fleet Maintenance Activity assessments will be conducted by the Type Commander (TYCOM) or Fleet Commander with cognizance over the FMA. For assessments conducted by the cognizant TYCOM, the assessment team will be comprised of members from each TYCOM that the FMA performs repairs for, with the senior member from the cognizant TYCOM. For assessments conducted by the cognizant Fleet Commander, the assessment team will be comprised of members from each TYCOM that the FMA performs repairs for, with the Fleet Commander, or Fleet Commander assigned TYCOM representative as the senior member of the assessment team. Assessments will be conducted in accordance with references (a) through (g) using the Quality Assurance assessment areas prescribed by Volume V, Part I, Chapter 9 of this manual.

- a. Assessments of Afloat FMAs will be performed annually, not to exceed 18 months.
- b. Assessments of shore based FMAs will be performed every 18 months, not to exceed 24 months. (TYCOM Quality Assurance assessments, explained in Volume V, Part I, Chapter 9 of this manual, will be accomplished concurrently with FMA assessments when scheduled in the same calendar year.)
- c. (Regional Maintenance Centers only) The following Regional Maintenance Centers (RMC) will be assessed every 18 months not to exceed 24 months. Areas may be assessed more frequently based upon results of previous assessments. These assessments encompass all functions of the RMC standard departments as listed in Commander, Naval Regional Maintenance Center Ship Organization and Regulation Manual:

Mid-Atlantic Regional Maintenance Center (MARMC)
 Southeast Regional Maintenance Center (SERMC)
 Southwest Regional Maintenance Center (SWRMC)
 Pearl Harbor Naval Shipyard and Intermediate Maintenance Facility
 Puget Sound Naval Shipyard and Intermediate Maintenance Facility
 U.S. Naval Ship Repair Facility and Japan Regional Maintenance Center (SRF-JRMC)

Forward Deployed Regional Maintenance Center (FDRMC)

- d. Assessments are to evaluate the ability of the FMA to execute maintenance in accordance with applicable technical directives and specifications. The assessment of FMAs encompasses Repair Department Work Centers (WC) and the direct repair WC support functions performed by other departments.

2.1.2 Applicability. The assessments described in this chapter are applicable for non-nuclear work only. This chapter does not apply to nuclear work and systems; they are addressed separately in Volume V, Part I, Chapter 9 of this manual.

2.2 ASSESSMENT AREAS.

- a. FMAs are expected to maintain a broad spectrum of capabilities at full readiness. The FMA can expect that many of these capabilities will be observed and evaluated during the course of the assessment. The Assessment Team will place primary emphasis on the essential core capabilities, utilizing the guidelines of references (a) and (b).
- b. Core capability craftsman demonstration areas are shown in Appendices A and B of this chapter. These represent the typical areas to be assessed and, as time permits, the team leader may observe other areas/projects. Observation of "in process work" is preferred to the assignment of projects or mockups in core capability areas. The team leader will make all decisions regarding the assignment of projects.

2.3 ASSESSMENT RESULTS. An overall grade of satisfactory or unsatisfactory will be assigned based on the FMA's compliance with higher-level requirements and governing technical documents.

2.4 RESPONSIBILITIES.

2.4.1 Type Commander.

- a. Promulgate an assessment schedule by 30 November for the following calendar year.
- b. Forward a precepts letter, or a message, to the FMA's Commanding Officer at least two weeks prior to the assessment. This letter should include:
 - (1) The date of the assessment.
 - (2) Assessment Team member's security clearance information.
 - (3) Core capability areas for the observation of in process work.
 - (4) Logistic support requirements.
 - (5) Additional information as appropriate.
- c. Conduct an inbrief and outbrief with the Immediate Superior in Command (ISIC) (if assigned), FMA's Commanding Officer and designated personnel. A preliminary copy of the Assessment Report will be provided to the FMA at the outbrief.
- d. Issue the Assessment Report (Appendix C of this chapter) to the FMA via the ISIC within 15 calendar days following completion of the assessment.

2.4.2 Fleet Maintenance Activity.

- a. Forward team security clearance information to the local base security office and to all units who are or will be in availability during the period of the assessment.
- b. Designate an Assessment Coordinator to act as the point of contact between the Assessment Team and the command. Notify the appropriate TYCOM of the name and phone number of the Assessment Coordinator upon receipt of the assessment precepts letter.
- c. Ensure the following assessment support is provided:
 - (1) Access to all industrial areas within the FMA.

- (2) An adequate and dedicated administrative work area to allow the Assessment Team to assemble.
- (3) Parking for the Assessment Team.
- (4) A telephone with off-ship and long distance capability.
- (5) Access to Maintenance Resource Management System.
- (6) Clerical personnel to assist. These personnel will report to the Assessment Team Leader for assignment of working hours and duties.
- (7) Copying services.
- (8) Access to all Controlled Work Packages (CWP) and standard Formal Work Packages (FWP), including the index of FWPs.
- (9) Access to selected Repair Department training records and the departmental weekly training schedule for the week of the assessment.
- (10) A list of all non-nuclear Technical Work Documents performed since the last assessment.
- (11) A list of key personnel and telephone numbers.
- (12) A list of capabilities required per references (a) and (b), but not held.
- (13) A list of all critical path jobs scheduled during the assessment.
- (14) A list of all production/management meetings scheduled during the assessment.
- (15) In the Assessment Team work area, provide:
 - (a) One desk top computer and a laser printer.
 - (b) A copy of the following reference documents:
 - 1 The previous TYCOM/Fleet Assessment report with corrective actions.
 - 2 Equipment out of commission lists.
 - 3 All FMA instructions and notices, including those pertaining to safety, production and repair functions, and the Command Availability Guide (if applicable).
 - 4 Activity manpower documents.
 - 5 Navy Afloat Maintenance Training Strategy-Training Reports.
 - 6 FMA Capabilities (currently titled IMA Capabilities) and WC Validation Reports for all applicable WCs.
 - 7 Joint Fleet Maintenance Manual.
 - 8 TYCOM Training Manual.
 - 9 Repair Department Equipment Status Log.
 - 10 FMA Audit and Surveillance Program records.
 - 11 FMA self-assessments.
 - 12 Departure from Specification files.
- d. Initiate action to systematically correct each assessment deficiency finding (Appendix D of this chapter) in accordance with paragraph 2.5.1 and 2.5.2 of this chapter.

2.5 ASSESSMENT FINDINGS/CORRECTIVE ACTION.

- a. For each noted deficiency in an assessment area, a finding will be written and classified as either “Immediate Corrective Action Required” or “Corrective Action Required”.

- b. Audit cards must clearly “stand on their own” and indicate if certification is or is not impacted by the finding when the audit card deals with SUBSAFE, Deep Submergence Systems or Fly-By-Wire deficiencies. All audit cards annotating a certification issue will be classified as “Immediate Corrective Action Required”.
- c. The FMA will annotate in the corresponding assessment report enclosure, the corrective actions taken for each finding.
- d. The Commanding Officer will also submit a findings status report to the TYCOM via the administrative chain of command within 60 days following receipt of the official assessment report.
- e. Unless a delay is specifically authorized by the TYCOM, all findings will be corrected within the time limits specified in paragraphs 2.5.1 and 2.5.2 of this chapter.

2.5.1 Immediate Corrective Action Required. A deficiency that poses a significant safety hazard or results in a total loss or extreme degradation of the FMA’s readiness to perform work or provide a service within an area of required capability. Findings classified as “Immediate Corrective Action Required” require the immediate attention of the Commanding Officer and must be corrected within 15 days following the date of the assessment out-brief. Additionally, the TYCOM may direct the immediate suspension of work in any area(s) pending resolution of critical deficiencies.

2.5.2 Corrective Action Required. A deficiency which poses a potential hazard to personnel safety or has a significant impact on the FMA’s readiness to perform work or provide a service within an area of required capability. Findings classified as “Corrective Action Required” require the prompt attention of the Commanding Officer to preclude them from developing into “Immediate Corrective Action Required” deficiencies and must be corrected within 60 days following receipt of the official assessment report.

APPENDIX A
TYPICAL CORE CAPABILITY ASSESSMENT AREAS

1. Safety/Navy Occupational Safety and Health.
2. Repair Training Effectiveness.
3. Maintenance Management.
4. Maintenance Data System Management.
5. Calibration - Production/WC Management.
6. FWP's (Volume V, Part I, Chapter 2 of this manual).
7. Tool/Equipment Control Programs.
8. Corrosion Control Program (as applicable).
9. Welding and Brazing Programs.
10. Quality Assurance Organization (Volume V of this manual).
11. Nondestructive Testing/Nondestructive Inspection (Volume V, Part I, Chapter 3 of this manual).
12. Technical Work Documents (Volume V, Part I, Chapter 2 of this manual).
13. Planning & Estimating.
14. Technical Library.
15. Hull Repair.
16. Machinery Repair.
17. Electrical Repair.
18. Electronics Repair.
19. Ordnance Repair (as applicable).
20. Weapon System Repair.
21. Weight Handling/Rigging.
22. Diving/Diver Life Support Systems (as applicable).
23. Regional Repair Center Capabilities (as applicable).

(This Page Intentionally Left Blank)

APPENDIX B
TYPICAL CORE CAPABILITY ASSESSMENT PROJECTS

1. Butt Weld (pipe).
2. HY-80 Weld Process.
3. Weld Hardface.
4. Silver Braze.
5. Tube Bend.
6. Flex Hose Manufacture & Testing.
7. Electroplating.
8. Hydraulic Control Valve Repair.
9. Weight Handling Sling Manufacture and Weight Test.
10. Valve Lap and Hydrostatic Test.
11. Other projects as necessary.

(This Page Intentionally Left Blank)

APPENDIX C
SAMPLE FMA ASSESSMENT REPORT

From: TYCOM (as appropriate)
To: Commanding Officer, FMA
Via: ISIC (as appropriate)
Subj: FMA ASSESSMENT

Ref: (a) COMUSFLTFORCOMINST 4790.3; Joint Fleet Maintenance Manual
(b) Precepts letter

Encl: (1) FMA Assessment Findings
(2) FMA Assessment Project Summary

1. Per Volume IV, Chapter 2 of reference (a) and reference (b), an FMA Assessment was conducted onboard FMA (Name of assessed command), during the period (Dates of Assessment).
2. The Assessment Team reviewed selected areas as prescribed in reference (a) and their findings and comments are contained in enclosures (1) and (2). Any required corrective actions should be initiated in accordance with Volume IV, Chapter 2, paragraph 2.5.1 and 2.5.2 of reference (a).
3. Overall Observation: (A brief summary of the results of the assessment including an overall evaluation of satisfactory/unsatisfactory).
4. (Subsequent paragraphs should briefly comment on major areas of concern found during the assessment).

(This Page Intentionally Left Blank)

APPENDIX D

FMA ASSESSMENT DEFICIENCY FORMAT

() IMMEDIATE CORRECTIVE ACTION REQUIRED

ITEM:

AREA:

ASSESSOR:

DISCUSSED WITH:

FINDING:

REFERENCE:

DISCUSSION:

CORRECTIVE ACTION:

A. ROOT CAUSES:

B. TEMPORARY CORRECTIVE ACTION:

C. PERMANENT CORRECTIVE ACTION:

(This Page Intentionally Left Blank)

VOLUME IV
CHAPTER 3
BOILER INSPECTION

REFERENCES.

- (a) OPNAVINST 9220.3 - Propulsion and Auxiliary Plant Inspection and Inspector Certification Program
- (b) NAVSEA S9086-GY-STM-010 - NSTM Chapter 221 (Boilers)
- (c) NAVSEA S9221-D2-MMA-010 - Steam Generating Plant Inspection (Non-Nuclear)
- (d) NWP 1-03.1 - Naval Warfare Publication Operational Report
- (e) NAVSEA S6470-AA-SAF-010 - Gas Free Engineering Manual
- (f) NAVSEA S9086-CH-STM-030 - NSTM Chapter 074 Volume 3 (Gas Free Engineering)
- (g) NAVSEA S0400-AD-URM-010/TUM - Tag-Out Users Manual
- (h) NAVSEA S9086-GX-STM-020 - NSTM Chapter 220 Volume 2, (Boiler Water/Feedwater Test and Treatment)
- (i) NAVSEA S9086-RK-STM-010 - NSTM Chapter 505 (Piping Systems)
- (j) NAVSEA S9086-G3-STM-010 - NSTM Chapter 225 (Steam Machinery Controls Systems)
- (k) OPNAVINST 9220.2 - U.S. Navy Boiler Water and Feedwater Test and Treatment Program (Nuclear Excluded)
- (l) OPNAVINST 4100.11 - Navy Energy Usage Reporting System (NEURS)
- (m) COMLANFLTINST/COMPACFLTINST 4100.3 - Navy Energy Usage Reporting System (NEURS)

LISTING OF APPENDICES.

- A Sample Boiler Inspection Request Message
- B Sample Inspection Confirmation Message
- C Summary of Boiler Inspection Scheduling and Responsibilities
- D Sample Boiler Inspection Report Cover Letter
- E Sample Boiler Inspection - RBO/Severely Degraded Deficiencies Message
- F Sample RBO Rescission Message
- G Sample 30 Day Update Message

3.1 **PURPOSE.** To establish policy and provide procedures and inspection requirements for the inspection of all conventional steam generating plants in surface force ships and training sites including schedules, preparations for inspection, inspection guidelines and reporting.

3.1.1 **Policy.** Periodic standardized inspections are required of all non-nuclear propulsion, auxiliary, waste heat and training site boilers by a certified Steam Generating Plant Inspector (SGPI) and/or Naval Surface Warfare Center, Carderock Division (NSWCCD) Life Cycle Engineering Manager (LCEM), as applicable. The maximum interval between boiler inspections and other occasions requiring boiler inspections, including responsibilities for continuation and standardization of the boiler inspection program, are formally assigned in reference (a).

3.2 TYPES OF BOILER INSPECTIONS.

- a. Routine Inspection.
- b. Pre-start of Availability Inspection (PSAI).
- c. Start of Availability Inspection (SAI).
- d. Strength and Integrity Inspection.
- e. Industrial Support Visit (ISV).
- f. Completion of Availability Inspection (CAI).
- g. Inactivation or Reactivation Inspection.
- h. Engineer Officer Inspection.

- i. Major Repair Inspection.
- j. Special Inspection.
- k. Operational Assessments.

3.3 RESPONSIBILITIES.

3.3.1 Naval Sea Systems Command. NAVSEA shall provide technical authority oversight over all main, auxiliary, waste heat and training site boiler systems and associated equipment. The designated NAVSEA Technical Warrant Holder shall:

- a. Assure safe and reliable system operation.
- b. Set and enforce all technical requirements.
- c. Approve all major Departure from Specifications (DFS).
- d. Provide technical oversight and management of the SGPI and NSWCCD LCEM programs:
 - (1) Establish and enforce requirements for SGPI certification and recertification.
 - (2) Ensure periodic SGPI seminars are conducted.
 - (3) Ensure periodic technical audits of all Integrated Logistics Support documentation and Training.
 - (4) Maintain the Boiler Inspection and Repair Management Information System (BIRMIS).
 - (5) Routinely evaluate and ensure state of the art inspection, maintenance and repair tools and techniques are used.

3.3.2 Naval Surface Warfare Center, Carderock Division. NSWCCD shall:

- a. Provide support to NAVSEA for the SGPI and NSWCCD LCEM programs. Ensure that the required technical documentation to support the SGPI/NSWCCD LCEM Inspector programs is maintained current.
- b. Establish and monitor the requirements and standards for routine and industrial inspections of steam generating plants.
- c. Develop, implement and maintain a program to train and certify NSWCCD LCEM Inspectors in accordance with reference (a).
- d. Ensure that inspections of newly constructed ships and ships undergoing major overhaul and/or conversion are conducted in accordance with this instruction.
- e. Conduct periodic technical audits of the SGPI Training Course per reference (a).
- f. Provide management of technical data, boiler history and the associated repair management information database system.
- g. Provide technical support to the semi annual seminars.
- h. Maintain a roster of all certified SGPIs by name, rating, duty station, date of certification and expiration date of certification. Revoke inspector certification and initiate action to decertify inspectors who fail to comply with requirements of reference (a).
- i. Ensure that the requirements for SGPI certification, recertification and certification extensions are met prior to final approval.

3.3.3 Fleet Commander. The Fleet Commander shall:

- a. Identify and designate those fleet activities which have inspection responsibilities and maintain a base of certified SGPIs within those activities.
- b. Ensure the availability of "school ships" to support SGPI/NSWCCD LCEM Inspector training. Student certification must be conducted on "D" type boilers.

- c. Host the semi-annual SGPI seminars on an alternating coast basis.

3.3.4 Regional Maintenance Center. The Regional Maintenance Center (RMC) shall:

- a. Provide certified SGPIs to perform inspections per section 3.6 of this chapter.
- b. Review the guidelines and inspection requirements for all boiler inspections required by this instruction and ensure that each inspection report is recorded and updated into BIRMIS.
- c. Schedule and coordinate inspections of all steam generating plants required by this instruction with the appropriate technical activities to avoid the unnecessary opening of boilers.
- d. Provide a qualified SGPI when requested by the ship, Immediate Superior in Command (ISIC) or Type Commander (TYCOM).

3.3.5 Regional Maintenance Center Commanding Officers. RMC Commanding Officers shall:

- a. Coordinate inspections in cognizant maintenance areas.
- b. Maintain an up-to-date status of required steam generating plant inspections which shall include the latest inspection for all ships assigned to RMCs in their respective area of responsibility.

3.3.6 Immediate Superior In Command. The ISIC shall:

- a. Maintain overall cognizance of the Steam Generating Plant Inspection Program within their area of responsibility to ensure requirements and standards are met.
- b. Schedule routine steam generating plant inspections in coordination with the cognizant RMC.
- c. Arrange for the availability of an SGPI during the SAI and CAI in coordination with NSWCCD and the cognizant RMC.
- d. Monitor the follow-up action required to correct noted discrepancies by randomly sampling the ship's deferred maintenance action file and most recent boiler inspection report.
- e. Assist Commanding Officers in arranging for the corrective action of items beyond the capability of Ship's Force, when requested.

3.3.7 Ship Commanding Officer/Officer In Charge/Maintenance Team. Ship Commanding Officers/Officers In Charge/Maintenance Team shall:

- a. Request boiler inspections via Naval Message using the format in Appendix A of this chapter.
- b. Prepare for scheduled inspections to include required operational testing in accordance with references (b) and (c).
- c. Review inspection results and initiate corrective action for those items within Ship's Force capability. Initiate requests for the correction of items beyond Ship's Force capability. If any of the discrepancies of paragraph 3.9.2 of this chapter cannot be corrected within 72 hours following completion of the inspection, or if said discrepancies will impact the ship's operational schedule, initiate a Casualty Report (CASREP) for the affected boiler(s) in accordance with reference (d).
- d. Assess the impact (if any) of corrective action on operating schedules and advise the operational commanders. Decide (with repair activities) the optimum timing of repair actions to minimize impact on operating schedules.
- e. Submit reports per paragraph 3.7.2 of this chapter.
- f. Schedule boiler inspections as required by appropriate Planned Maintenance System (PMS)/Class Maintenance Plan item.

3.3.8 Regional Maintenance Center Senior Inspector. RMC Senior Inspectors shall:

- a. Ensure all assigned SGPIs maintain current certifications per reference (a).
- b. Perform steam generating plant inspections per section 3.9 of this chapter, when directed.
- c. Review and submit reports per paragraph 3.7.2 of this chapter.

- d. Send inspection confirmation messages using Appendix B of this chapter.
- e. Administer an SGPI pre-test for SGPI training school candidates per reference (a).

3.3.9 Steam Generating Plant Inspector. The SGPI shall:

- a. Maintain SGPI certifications per reference (a).
- b. Perform steam generating plant inspections per section 3.9 of this chapter, when directed.
- c. SGPIs are part of the technical authority chain-of-command and are accountable to the NAVSEA Technical Warrant Holder for the performance of their inspection duties.
- d. The shipboard SGPI shall:
 - (1) Monitor all repairs conducted on the boilers, such as tube replacements, casing/refractory work, burner settings, hydrostatic test, etc., and annotate findings in Boiler Water/Feedwater log.
 - (2) Observe PMS performed on the boilers to include MLOCs (burner front checks), greasing of sliding feet, setting safety valves, high and low static checks, flex tests and auxiliary support equipment safety/governor settings.
 - (3) Accomplish special inspections and repairs on boilers after boiler casualties while underway and report in BIRMIS. Also, accomplish operational assessments on ship's boiler auxiliary support equipment prior to upcoming availabilities and report in BIRMIS and in ships Current Ship's Maintenance Project (CSMP), if repairs are required.
- e. It is recommended that the shipboard SGPI be assigned as the LCPO of the Oil Lab in order to monitor the boiler water chemistry, boiler lay-ups and the Boiler Water/Feedwater Program (not to be assigned as Ships Oil King).

NOTE: THE SHIP'S FORCE SGPI CAN ONLY ACCOMPLISH SPECIAL INSPECTIONS AND OPERATIONAL ASSESSMENTS ON THEIR OWN SHIP, AS DESCRIBED IN PARAGRAPHS 3.6.9 AND 3.6.10 OF THIS CHAPTER. THE SHIP'S FORCE SGPI WILL ASSIST THE RMC SGPI/NSWCCD LCEM INSPECTOR DURING ROUTINE AND AVAILABILITY RELATED INSPECTIONS. THE SHIP'S FORCE SGPI MAY NOT INDEPENDENTLY CONDUCT ROUTINE, STRENGTH AND INTEGRITY, PSAI, SAI, ISV, CAI INSPECTIONS ON THEIR OWN SHIP.

3.4 INSPECTION SCHEDULING. Commands will initiate boiler inspection requests in a timely manner to assist with inspection scheduling coordination to include operational testing. Commands shall ensure the inspection scheduling complies with the following:

- a. Commanding Officers/Officers In Charge of ships shall request boiler inspections by message. In addition, OPNAV 4790/2-Kilo shall be submitted to the RMC requesting a certified SGPI/NSWCCD LCEM inspector as required to conduct inspections.
- b. Inspections should coincide with the required routine waterside and fireside maintenance.
- c. Boiler inspection services shall be coordinated by geographic areas for maximum utilization of SGPIs/NSWCCD LCEM Inspectors. ISICs will combine inspection requests and schedule inspections.

3.5 BOILER SAFETY PROCEDURES. The safety of personnel must be given the highest priority. Observance of good engineering practices and careful control of boiler water chemistry will reduce the frequency of pressure vessel entry.

- a. Ensure "idle boiler condition" is accomplished per the provisions of the Engineering Operational Sequencing System (EOSS) and reference (b). Where conflicts occur, an EOSS feedback form should be submitted for resolution.

- b. Do not enter any part of a boiler or De-Aerating Feed Tank (DFT) until it has been fully ventilated and certified by a Naval Maintenance Facility Gas Free Engineer/National Fire Protection Agency marine chemist as safe for entry in accordance with references (e) and (f), as applicable, and Chapter 25 of this volume.
- c. Ensure the idle boiler is tagged out (valves wired shut and danger tagged). Observe two-valve protection per reference (g) where applicable. Open to the atmosphere the drain connections on all dead interconnecting piping to observe drainage.
- d. The use of unshielded or non-approved portable lighting in an open boiler is prohibited. Portable lighting shall be watertight. (National Stock Number (NSN) 9S-6230-00-701-2947 applies.)
- e. Ensure all precautions cited in Section 2.24 of reference (b) are followed before entering an idle boiler.
- f. There shall be a safety observer outside the boiler entrance to provide assistance whenever personnel are inside a boiler (steam drum, water drum, firebox or smokepipe).
- g. Maintain an inventory log for accountability of all items taken into a boiler. The pockets of all personnel working in a boiler shall be emptied and all jewelry removed. The removal of all items from the boiler shall be verified from the inventory log prior to the close-up inspection. The Chief Engineer or his designated representative shall inspect the boiler prior to final close-out.
- h. Cleaning of firesides or repairs conducted to the pressure vessel exterior of a boiler is acceptable with a steaming boiler in the same space provided the precautions cited in Section 2.7 of reference (b) are observed. Water washing of the firesides is not authorized without NAVSEA approval.
- i. Requiring personnel to enter the steam/water side of a boiler with an adjacent steaming boiler is considered an unnecessary risk and will be avoided unless operations dictate otherwise. The decision to override normal safety precautions will be made by the Commanding Officer/Officer In Charge and will be reported to the TYCOM by message.
- j. Keep the area under the boiler clean and dry.
- k. Place signs warning that personnel are working in the boiler at the Boiler Console Operating station in the boiler operating space. The sign shall remain there until the work has been completed and personnel are clear of the secured boiler.

3.6 **BOILER INSPECTIONS AND REQUIREMENTS.** Main propulsion, auxiliary, waste heat and training site boiler inspections conducted per the requirements of this chapter shall fulfill all other requirements for comprehensive inspections of propulsion, auxiliary and waste heat boilers. All boiler inspections, including pre- and post-operational assessments, should be scheduled for coincidental performance. Appendix C of this chapter is a summary of boiler inspection scheduling and responsibilities. Propulsion, auxiliary and waste heat boilers will be inspected by a certified SGPI at the following intervals:

3.6.1 **Routine Inspection.** Routine Inspections will be conducted at least once every Fleet Readiness Training Plan and shall not exceed 30 months from its last inspection. For newly constructed ships, the period shall begin at the completion of the Board of Inspection and Survey (INSURV) Acceptance Trials. The normal interval between routine boiler inspections shall be 24 months. To provide scheduling flexibility, boiler inspections may be performed as early as 12 months or as late as 30 months after the previous inspection. Inspections that exceed the 24 month interval will require a minor DFS to the TYCOM with recommendation from NSWCCD-SSES. Extensions shall not result in the inspection interval exceeding 30 months. Any boiler which exceeds the inspection interval shall be placed out of commission until inspected by a certified SGPI. A major DFS with NAVSEA Technical Warrant Holder approval is required to operate a boiler beyond 30 months without a Routine Boiler inspection.

- a. The boiler inspection will be scheduled by the cognizant ISIC.
- b. The boiler inspection will be performed by the cognizant SGPI.
- c. The TYCOM may utilize PSAIs, CAIs, and Strength and Integrity Inspections which are documented in BIRMIS, to satisfy the pressure vessel portion of a routine boiler inspection. This will reduce the number of boiler openings. A Routine Inspection will not be considered completed until an SGPI has

certified all items required in NSTM 221-2.1.2.3 Ship's Pre-inspection Checklist For Up-coming Routine Boiler Inspection by U.S. Navy Steam Generating Plant Inspector and reference (c), Appendix E, F and Figure E-6 addressing Operational Assessments has been accomplished. Once completed, this resets the periodicity required for the next inspection to 24 months not to exceed 30 months.

3.6.2 Pre-start of Availability Inspection. The PSAI may be required at the discretion of the TYCOM to support early bid specification and work package development.

- a. The PSAI will be scheduled by the ISIC, as approved by the cognizant TYCOM.
- b. The PSAI will be performed by the NSWCCD LCEM Inspector and the RMC SGPI.

3.6.3 Start of Availability Inspection. The SAI may be required to be accomplished at the beginning of an overhaul/availability to better define or re-evaluate the boiler bid specifications and/or work items at the discretion of the ISIC with TYCOM concurrence.

- a. The SAI will be scheduled by the ISIC, as approved by the cognizant TYCOM.
- b. The SAI will be performed by the NSWCCD LCEM Inspector and the RMC SGPI.

3.6.4 Strength and Integrity Inspection. The normal interval between Strength and Integrity Inspections shall be 60 months. Strength and Integrity Inspections may be performed as early as 48 months or as late as 72 months after the last Strength and Integrity Inspection to provide scheduling flexibility. Inspections that exceed the 60 month interval will require a minor DFS to the TYCOM with recommendation from NSWCCD-SSES. Strength and Integrity Inspections **shall not** exceed 72 months since the last inspection. Any boiler which exceeds the inspection interval shall be placed out of commission until inspected by an NSWCCD LCEM Inspector and a certified SGPI. A major DFS with NAVSEA Technical Warrant Holder approval is required to operate a boiler beyond 72 months without a Strength and Integrity Inspection.

- a. The Strength and Integrity Inspection will be scheduled by the cognizant ISIC.
- b. The Strength and Integrity Inspection will be performed by an NSWCCD LCEM Inspector and the cognizant RMC SGPI.

3.6.5 Industrial Support Visit Inspection. The ISV inspection shall be scheduled during the availability, but may be waived by the TYCOM for availabilities of short duration.

- a. The ISV inspection will be scheduled by the industrial activity or Supervising Authority as applicable.
- b. The ISV inspection will be performed by an NSWCCD LCEM Inspector and the cognizant SGPI.

3.6.6 Completion of Availability Inspection. The CAI will be conducted before reinstallation of steam drum internals and de-superheater for the Strength and Integrity Inspection.

- a. The CAI will be scheduled by the industrial activity or Supervising Authority, as applicable, and may be conducted in conjunction with a Routine Inspection.
- b. The CAI will be performed by an NSWCCD LCEM Inspector and the cognizant SGPI.

3.6.7 Inactivation or Reactivation Inspection. The Inactivation/Reactivation Inspection shall be conducted on all boilers prior to completion of the inactivation/reactivation.

- a. The Inactivation/Reactivation Inspection will be scheduled by the industrial activity, Supervising Authority or Inactive Ship Facility as applicable.
- b. The Inactivation/Reactivation Inspection will be performed by an NSWCCD LCEM Inspector and the cognizant SGPI.

3.6.8 Engineer Officer Inspection. The Engineer Officer Inspection shall be conducted per PMS and situational requirements of references (b) and (c), but does not qualify as a Routine Inspection described in paragraph 3.6.1 of this chapter. This inspection will be scheduled and performed by the ship's Engineer Officer. All results are to be documented in the Boiler/Water Feedwater logs and the Engineering Logs.

3.6.9 Special Inspection.

- a. A special inspection shall be conducted whenever major repair work as defined by references (b) and (g) is accomplished. This inspection is arranged by the ISIC in coordination with the TYCOM and the RMC and performed by an SGPI.
- b. Additionally, SGPIs are authorized to conduct special no-notice inspections at their discretion to assess operational, chemistry and maintenance related problems.

3.6.10 Operational Assessments. An operational assessment shall be accomplished prior to and at the completion of all Chief of Naval Operations (CNO) scheduled maintenance availabilities. These assessments are part of the Routine and Strength and Integrity Inspection requirements. These assessments will include both cold and hot plant inport safety checks and an operational evaluation. Detailed assessment requirements and check lists are available in reference (c), Figure E-6.

3.7 BOILER INSPECTION GUIDELINES AND REPORTS.

3.7.1 Guidelines.

- a. Routine Inspections of boilers will be conducted by certified SGPIs.
- b. Only an SGPI with a current certification may issue a Repair Before Operating (RBO) deficiency. All RBO items shall be corrected prior to boiler operation and reinspected by a certified SGPI or NSWCCD LCEM Inspector, as applicable, and preferably the same SGPI/NSWCCD LCEM Inspector who originally inspected the boiler. RBO discrepancies include those for which continued unrestricted operation could endanger personnel. RBOs may not be departed via DFS. If there is not an immediate or near future danger to personnel, the discrepancy shall be assigned as SEVERELY DEGRADED with major operational restrictions.
- c. An SGPI-designated discrepancy discovered in accordance with reference (c) and paragraph 3.9.2 of this chapter which is assigned as severely degraded with major operational restrictions, and is considered for a DFS submission, is a major DFS and must be brought forward to the attention of the NAVSEA Boiler and Condenser Technical Warrant. A Major DFS must be forwarded for NAVSEA review and approval with accompanying engineering analysis recommendations from the originator. A severely degraded discrepancy in accordance with this chapter must be corrected/repared prior to boiler operation unless it has been properly approved as a Major DFS.
- d. The status of a boiler related DFS will be verified by the SGPI during the inspection for conformance with the requirements of this manual prior to placing the boiler into operation.

3.7.2 Reports.

- a. The SGPI shall provide an oral critique and preliminary report to the ship's Commanding Officer or his designated representative. The report will contain the findings of the inspection, with special note of recurring discrepancies from previous inspections. The SGPI shall ensure a maintenance ready 2-Kilo for every discrepancy found during the inspection is entered into the Current Ship's Maintenance Project.
- b. The Senior Inspector will forward a copy of the BIRMIS report with cover letter per the sample shown in Appendix D of this chapter to the ship's Commanding Officer no later than ten days after satisfactory clearance of all discrepancies.
- c. The SGPI shall report deficiencies discovered during the inspection by message within 24 hours, using the message format of Appendix E of this chapter. This message shall contain both RBO and severely degraded deficiencies as described in paragraph 3.7.1 of this chapter.
- d. The cognizant SGPI shall report by message, using the format in Appendix F of this chapter, the correction and re-inspection of all RBO deficiencies prior to lighting off an inspected boiler.
- e. The ship's Commanding Officer shall submit a copy of the Current Ship's Maintenance Project to the SGPI for verification of downloaded 2 Kilos.

- f. The ship's Commanding Officer shall report corrected deficiencies, by message, to the ISIC and TYCOM using the format in Appendix G of this chapter, within 30 days of the completed inspection and at 30 day intervals thereafter until all deficiencies are corrected or deferred to a CNO Maintenance Availability. The TYCOM is the sole authority for deferral of deficiencies. Update messages shall list the BIRMIS item number/2K Job Sequence Number of those items which have been completed since the last update message. A corrected BIRMIS report will be provided to the ship after BIRMIS status codes are updated.
- g. The ship's Commanding Officer shall notify the ISIC (as applicable)/TYCOM when a scheduled steam generating plant inspection cannot be conducted by submitting a DFS request. State the reason why the inspection cannot be conducted and recommend a revised date.

3.8 BOILER INSPECTION PREPARATION.

- a. Conduct the operational assessment before disassembling the boiler for inspection. Detailed assessment requirements are reported in reference (c).
- b. Prepare the boiler using the guidance provided in reference (b).
- c. Keep air passages, including the air box beneath the boiler and uptake spaces, clean and dry.
- d. Wire shut and danger tag all steam and water valves to the boiler per the ship's Tag Out Users Manual. Open to the atmosphere the drain connections on all dead interconnecting piping to observe drainage.
- e. The ship's Engineer Officer shall ensure all Ship's Force responsibilities are complete using the guidance provided in reference (c).
- f. Open DFT for inspection.

3.9 BOILER INSPECTION.

3.9.1 Boiler Inspection Forms. Boiler inspections will be conducted using the appropriate BIRMIS forms. Include specific comments on the state of preservation and material condition of the boiler, hull structural members beneath the boiler and the effectiveness or ineffectiveness of the boiler water chemistry program.

3.9.2 Boiler Inspection Areas. A discrepancy is classified as an RBO, if left uncorrected, it could endanger personnel safety. All RBO items shall be corrected prior to boiler operation and re-inspected by a certified SGPI or NSWCCD LCEM Inspector as applicable, and preferably the same SGPI/NSWCCD LCEM Inspector who originally inspected the boiler. As inspected by an SGPI/LCEM inspector, RBO discrepancies may include but are not limited to the following:

- a. Active oxygen attacking the boiler watersides.
- b. Hard scale or baked sludge.
- c. Significant lube oil/fuel oil contamination of watersides.
- d. Inoperative/misadjusted/missing safety devices.
- e. Refractory deterioration which allows heat penetration to casings or causes incomplete combustion.
- f. Ship's Force Boilerwater/Feedwater certifications, chemical inventory and shelf life not within requirements in reference (h).
- g. Inability to maintain water chemistry within limits. Ineffective Boilerwater/Feedwater program based on log review which left uncorrected may result in severe degradation of the boiler watersides. Inoperative or degraded treatment, sampling and blow-down systems.
- h. Excessively fouled or tacky firesides, fireside deposits built up on the crown of the water drum.
- i. Sliding feet that do not accept grease and/or do not show indication of movement.
- j. Lack of maintenance and preservation of the boiler, resulting in deterioration and weakening of boiler and hull structural members. This includes deterioration in the air casing which allows water and combustion air/gasses into the space.

- k. Lube oil contamination of Automatic Boiler Control (ABC) Systems.
- l. Fire/safety hazards (fuel/lube oil in the machinery room), deteriorated or missing flange shields. Oil soaked lagging and insulation.
- m. Inoperative or missing fire fighting equipment.
- n. ABC equipment inoperable or failed cold/hot checks.
- o. Steam smothering system inoperative (plugged nozzles, deteriorated or improperly installed piping).
- p. Deteriorated boiler smoke pipes which allow stack gas to escape. Clogged or deteriorated stack drains.
- q. Incorrectly adjusted burners or inoperative air registers. Safety Shut-off Devices which do not meet the leakage criteria of reference (b). Insufficient amount of sprayer plates, burner barrels and go-no-go gages to meet main space requirements as specified in reference (b).
- r. Boiler that does not pass design hydrostatic test.
- s. Non-deferrable defects/indications in the pressure vessel and piping boundary.
- t. Damaged or deteriorated internals.
- u. Defective tubes such as blistered, excessively warped or married tubes which prevent proper gas passage. Cracked tube bells.
- v. Ultrasonic test results on soot blower heads or pressure vessel piping that are currently or projected to be at or below minimum requirements, out of periodicity, or when visual inspection dictates replacement before the next scheduled ultrasonic inspection.
- w. Out of periodicity, in-operative temperature or pressure measuring instruments.
- x. In-operative, out of adjustment Forced Draft Blower counterweight shutters.
- y. Non-functioning DFT components or defects in the pressure vessel.
- z. In-operative fuel and steam systems remote isolation devices.
- aa. Valve tightness integrity and operation which limits its ability to perform its intended function and exceeds the criteria of reference (i).
- ab. Non-conformance of electrical safety and deteriorated or damaged wiring or components.
- ac. Any other discrepancy deemed by the SGPI which would cause injury to personnel.

NOTE: A SEVERELY DEGRADED DESIGNATION IS ASSIGNED TO A DEFICIENCY THAT IS NOT AN IMMEDIATE OR NEAR FUTURE DANGER TO PERSONNEL, BUT WILL HAVE MAJOR OPERATIONAL RESTRICTIONS. A SEVERELY DEGRADED DISCREPANCY IN ACCORDANCE WITH THIS CHAPTER MUST BE CORRECTED/REPAIRED PRIOR TO BOILER OPERATION UNLESS IT HAS BEEN PROPERLY APPROVED AS A MAJOR DFS.

3.9.3 Completion of Inspection. An oral critique and a preliminary inspection report, including a summary of restrictive deficiencies, will follow the inspection. Paragraph 3.7.2 of this chapter identifies official reporting requirements.

3.10 AUTOMATIC BOILER CONTROL SYSTEMS/ONLINE VERIFICATION GUIDELINES.

- a. ABC Systems, which include Automatic Combustion Controls, Boiler Feedwater Level Controls, and Automatic Feed Pump Controls and DFT Level Controls have been designed and installed for the purpose of permitting steady and transient operation with the least variation possible. Proper utilization and maintenance of these systems will also allow a reduction of watch standers on station thereby enabling engineering personnel to devote more time to routine maintenance of machinery and upkeep of spaces, as well as providing the ship with instant response to signaled engine orders.
- b. The following guidelines shall be adhered to regarding any or all ABC Systems installed:

- (1) Ships shall use the controls at all times while steaming. Manual operation at the control panel/console (remote manual) shall be used when lighting off or securing the boiler. ABCs should be cut out and the boiler controlled in local manual only when required for casualty control, maintenance of equipment, or training of personnel. When ABCs cannot be operated in automatic, this fact shall be reported by a CASREP message.
 - (2) Installed multi-element feedwater regulators shall be cut in and used at all times except for periods devoted to training operators in the manual operation of feed check valves. Prime reliance for the control of water level in the boiler steam drum shall be placed on the automatic regulator. When any indicator, alarm or feedwater regulating valve is not functioning properly, or is out of commission, a qualified checkman shall be assigned. He/She shall have no other duties as directed by temporary standing orders.
 - (3) Prior to boiler light off, all ABCs shall be tested in accordance with EOSS.
 - (4) Maintenance and calibration of the ABC Systems shall be accomplished by qualified technicians in accordance with the direction provided in applicable PMS, reference (j) and the manufacturer's technical manuals.
- c. Online Alignment Verification procedures provide a set of checks to verify proper performance of each of the sub-systems or control loops within the automatic combustion, feedwater and feed pump control systems. Online Alignment Verification shall be accomplished using the periodicity and procedures in PMS and applicable ABC ship specific technical manuals.

3.11 BOILER FLEXIBILITY TESTS. PMS and Online Alignment Verification procedures contain the necessary procedures for a boiler flexibility test. The periodicity is provided by and included in the PMS scheduling. The applicable Maintenance Requirement Card contains the NAVSEA guidelines governing the performance level of the boiler flexibility tests. Level I is the desired boiler flexibility performance level. Boilers with performance levels of II and III are considered safe to steam and safe for the conduct of Engineering Casualty Control Exercises. Boilers which cannot achieve a minimum level III flexibility are unsafe to steam and the ABC System should be reported by CASREP in accordance with the requirements of reference (d).

3.12 CERTIFIED BOILER WATER AND FEEDWATER TESTER REQUIREMENTS. All personnel who are required in the course of their duties to test, treat and/or manage boiler water/feedwater programs shall be certified as specified in reference (k).

3.13 OPERATING AND CASUALTY PROCEDURES. Each ship with steam generating plants will have approved Steam Generating Plant Operations Procedures in the format prescribed by their respective TYCOM. They shall contain detailed procedures and precautions for:

- a. Normal operations including startup and shutdown.
- b. Infrequent operations such as initial steam generating plant light-off following an availability.
- c. Operating parameters, limitations, alarms and set points.
- d. Casualty conditions including indications, immediate and supplementary actions.
- e. Propulsion fuel economy per references (l) and (m).
- f. JP-5 for use as boiler fuel.
- g. Management of boiler water and feedwater.
- h. Quality Assurance (QA) requirements for boiler repairs.
- i. Maintenance and storage of boiler burner atomizers.

APPENDIX A

SAMPLE BOILER INSPECTION REQUEST MESSAGE

FM USS (SHIP'S NAME AND HULL NO)
TO: REGIONAL MAINTENANCE CENTER
INFO ISIC//
TYCOM
NAVSURFWARCEN SHIPSYSENGSTA PHILADELPHIA PA//
COMNAVSEASYSKOM WASHINGTON DC//
BT
UNCLAS
MSGID/GENADMIN/(USS SHIP'S NAME HULL NO)//
SUBJ/REQUEST FOR ROUTINE BOILER INSPECTION//
REFERENCE/A/DOC/COMUSFLTFORCOMINST 4790.3//
AMPN/REF A IS THE JOINT FLEET MAINTENANCE MANUAL//SHIPS POC//USS (SHIP'S NAME AND HULL NO)/EMAIL://
GENTEXT/REMARKS/1. PER REF A REQUEST RMC PROVIDE A CERTIFIED SGPI TO ACCOMPLISH ROUTINE BOILER INSPECTION OF (NO. BOILER(s)).
2. REQUEST PRIMARY INSPECTION START DATE OF (PROVIDE DATE) FOR BOILER (NO) AND AN ALTERNATE START DATE OF (PROVIDE DATE)
3. AWR ENTERED IN SHIP'S CSMP (JSN) JOB SEQUENCE NUMBER//
BT
NOTE: ENSURE MESSAGES ARE IN ACCORDANCE WITH CURRENT MESSAGE FORMAT AND CURRENT PLAIN LANGUAGE ADDRESS DIRECTORY (PLAD) IS UTILIZED.

(This Page Intentionally Left Blank)

APPENDIX B

SAMPLE INSPECTION CONFIRMATION MESSAGE

FM REGIONAL MAINTENANCE CENTER (COMMAND)
TO USS (SHIP'S NAME AND HULL NUMBER)
INFO COMNAVSURFFOR//
TYCOM//
ISIC//
COMNAVSEASYS COM WASHINGTON DC//
NAVSURFWARCEN SHIPSYSENGSTA PHILADELPHIA PA//
BT
UNCLAS
MSGID/GENADMIN/
SUBJ/INSPECTION DATE CONFIRMATION//
REFERENCE/A/MSG/USS/ (SHIPS NAME HULL NUMBER)/DTG REQUEST//
REFERENCE/B/DOC/COMUSFLTFORCOMINST 4790.3//
NARR/REFERENCE A IS REQUESTING BOILER INSPECTION. REFERENCE B IS
COMUSFLTFORCOMINST 4790.3 DEFINING JOINT FLEET BOILER INSPECTION CRITERIA AND
PROCEDURES//
POC/SENIOR SGPI/RATE/UIC/LOC:CITY/TEL:/DSN//
RMKS/1. IN RESPONSE TO REF A, AN (TYPE) MONTH BOILER INSPECTION WILL BE CONDUCTED
IAW REF B BEGINNING (DATE) ON NUMBER () BOILER. ONE OR MORE OF THE FOLLOWING
CERTIFIED INSPECTORS ARE ASSIGNED TO CONDUCT THE INSPECTIONS:
INSPECTOR NAME/RATE//LAST 4//CLEARANCE.
2. POC E-MAIL ADDRESS IS: SENIOR SGPI//
BT
**NOTE: ENSURE MESSAGES ARE IN ACCORDANCE WITH CURRENT MESSAGE FORMAT AND
CURRENT PLAD IS UTILIZED.**

(This Page Intentionally Left Blank)

APPENDIX C

SUMMARY OF BOILER INSPECTION
SCHEDULING AND RESPONSIBILITIES

<u>Type Inspection</u>	<u>Schedule Date</u>	<u>Scheduling Responsibility</u>	<u>Responsibility for Inspections</u>
1. Routine	Every 18 months	ISIC/Ship	Cognizant SGPI
2. Pre-Start of Availability Inspection	Schedule PSAI and operational testing in conjunction with Routine boiler appraisal 3-12 months prior to availability	ISIC	NSWCCD LCEM INSPECTOR and Cognizant SGPI
3. Start of Availability Inspection	At start of overhaul/with strength and integrity inspection	Naval Shipyard RMC	NSWCCD LCEM INSPECTOR and Cognizant SGPI
4. Strength and Integrity Inspection	Once every 60 Months	ISIC/RMC	NSWCCD LCEM INSPECTOR and Cognizant SGPI
5. ISV*	During availability	Industrial Activity or Supervising Authority	NSWCCD LCEM INSPECTOR and Cognizant SGPI
6. CAI	To be conducted before reassembling boiler for final hydrostatic test	Industrial Activity or Supervising Authority	NSWCCD LCEM INSPECTOR and Cognizant SGPI
7. Inactivation or Reactivation	Prior to final action	Industrial Activity, Supervising Authority or Inactive Ship Facility	NSWCCD LCEM INSPECTOR and Cognizant SGPI
8. Engineer Officer	Per PMS and references (b) and (c)	Engineer Officer	Engineer Officer
9. Special	Subsequent to major repairs No-Notice at SGPI discretion	ISIC (Coordinate with Regional Maintenance Center)	NSWCCD LCEM INSPECTOR and Cognizant SGPI
10. Operational Availabilities	Prior to and at completion of all CNO maintenance	TYCOM	Cognizant SGPI

*The ISV inspection may be waived by the TYCOM for availabilities of short duration.

(This Page Intentionally Left Blank)

APPENDIX D

SAMPLE BOILER INSPECTION REPORT COVER LETTER

From: Commanding Officer, Regional Maintenance Center

To: Commanding Officer, USS (Ship's Name and Hull No.)

Subj: (Routine, etc.) INSPECTION OF BOILER(S) NUMBER (1A, 1B, 2A, etc.) AND REVIEW OF BOILER WATER/FEEDWATER TEST AND TREATMENT IN USS (Ship's Name and Hull No.)

Encl: (1) Boiler Inspection Report of Boiler(s) Number (1A, 1B, 2A, etc.)

1. (Parent Command) Steam Generating Plant Inspector, (Inspector's Name) inspected Boiler(s) Number (1A, 1B, 2A, etc.) in USS (Ship's Name and Hull No.) on (Day, Month, Year) while (ship's location).
2. Discrepancies which require corrective action are outlined in enclosure (1).
3. Advance copies of enclosure (1) have been delivered to the ship's Commanding Officer.

Copy to: (as appropriate)
TYCOM (N43AD)
ISIC
NSWCCD (Code 9222)

(This Page Intentionally Left Blank)

APPENDIX E**SAMPLE BOILER INSPECTION - RBO/SEVERELY DEGRADED DEFICIENCIES MESSAGE**

FM COMMANDING OFFICER, REGIONAL MAINTENANCE CENTER

TO USS (SHIP'S NAME AND HULL NO.)

INFO TYCOM//(AS APPROPRIATE)

ISIC//(AS APPROPRIATE)

COMNAVSEASYS COM WASHINGTON DC//

NAVSURFWARCEN SHIPSYSENGSTA PHILADELPHIA PA//

BT

UNCLAS/N09221//

MSGID/GENADMIN/COMMANDING OFFICER, REGIONAL MAINTENANCE CENTER

SUBJ/USS (SHIP'S NAME AND HULL NO.) NR (1A, 1B, 2A, ETC.) ROUTINE/STRENGTH AND

INTEGRITY INSPECTION (AS APPROPRIATE)//

REF/A/DOC/COMUSFLTFORCOMINST 4790.3//

REF/B/DOC/NAVSEAINST 4790.8/OPNAVINST 4790.4//

NARR/REF A IS JOINT FLEET MAINTENANCE MANUAL VOL IV CH 3 AND PROVIDES GUIDANCE FOR BOILER INSPECTIONS. REF B IS 3-M MANUAL AND PROVIDES GUIDANCE FOR CSMP DOCUMENTATION//

RMKS/1. BOILER NUMBER (1A, 1B, 2A, ETC.) ROUTINE/STRENGTH AND INTEGRITY (AS APPROPRIATE). INSPECTION CONDUCTED (DATE) BY (INSPECTOR'S NAME) WHILE (SHIPS LOCATION). RBO DEFICIENCIES AND PROPOSED CORRECTIVE ACTION ARE REPORTED IAW REF A AS FOLLOWS:

A. (BIRMIS ITEM NO, DEFICIENCY, REPAIR, ETC.)

B.

C.

2. BOILER NUMBER (1A, 1B, 2A, ETC.) SHALL NOT BE STEAMED UNTIL ABOVE LISTED DEFICIENCIES ARE CORRECTED AND A REINSPECTION IS CONDUCTED IAW REF A.

3. SEVERELY DEGRADED DEFICIENCIES AND PROPOSED CORRECTIVE ACTION ARE REPORTED IAW REF A AS FOLLOWS:

A.

B.

C.

4. SEVERELY DEGRADED DEFICIENCIES ARE REQUIRED TO BE CORRECTED PRIOR TO STEAMING OR MUST BE SUBMITTED FOR MAJOR DEPARTURE FROM SPECIFICATION (DFS).

5. IAW REF A DEFICIENCIES COMPLETED SHALL BE REPORTED EVERY 30 DAYS USING THE GUIDANCE PROVIDED IN REF A APPENDIX F. ALL DEFICIENCIES HAVE BEEN DOCUMENTED IN THE SHIPS CSMP FOR CORRECTIVE ACTION IAW REF B.//

BT

NOTE: ENSURE MESSAGES ARE IN ACCORDANCE WITH CURRENT MESSAGE FORMAT AND CURRENT PLAD IS UTILIZED.

(This Page Intentionally Left Blank)

APPENDIX F

SAMPLE RBO RESCISSION MESSAGE

TO USS (SHIP'S NAME AND HULL NO)
CC USS (SHIP'S NAME AND HULL NO)
INFO TYCOM//(AS APPROPRIATE)
ISIC//(AS APPROPRIATE)
COMNAVSEASYS COM WASHINGTON DC//
NAVSURFWARCEN SHIPSYSENGSTA PHILADELPHIA PA//
BT
UNCLAS
SUBJ/USS (SHIP'S NAME AND HULL NO) NUMBERS (1A, 1B, 2A, ETC.) (TYPE) BOILERS REPAIR
BEFORE OPERATE (RBO)//
REF/A (ORIGINATING RBO MESSAGE DTG)
REF/B/CON/USS//(SHIP'S NAME AND HULL NO) (SHIP POC)
NARR/REF A ADDRESSES RBO DEFICIENCIES FOUND DURING BOILER INSPECTION CONDUCTED
ON (DATES). REF B IS BTWN USS (SHIP'S NAME AND HULL NO) (SHIP POC)/AND RMC SGPI/(NAME)
DISCUSSING RBO DEFICIENCIES CORRECTION.
GENTEXT/REMARKS/1. REF A RESTRICTIONS RESCINDED BASED UPON RE-INSPECTION.
THIS MESSAGE CONFIRMS REF B.
BT

**NOTE: ENSURE MESSAGES ARE IN ACCORDANCE WITH CURRENT MESSAGE FORMAT AND
CURRENT PLAD IS UTILIZED.**

(This Page Intentionally Left Blank)

APPENDIX G

SAMPLE 30 DAY UPDATE MESSAGE

FM USS TO USS (SHIP'S NAME AND HULL NO)
CC USS (SHIP'S NAME AND HULL NO)
INFO TYCOM//(AS APPROPRIATE)
ISIC//(AS APPROPRIATE)
NSWCCD//
NAVSEA//
RMC//
BT
UNCLAS
MSGID/GENADMIN/USS (SHIP'S NAME AND HULL NO)//
SUBJ/USS (SHIP'S NAME AND HULL NO) NR (1A, 1B, 2A, ETC.) ROUTINE BOILER INSPECTION//
REF/A/DOC/BIRMIS REPORT FROM (RMC AND DATE)
REF/B/DOC/COMUSFLTFORCOMINST 4790.3//
REF/C/DOC/OPNAVINST 4790.4D//
NARR/REF A IS BIRMIS REPORT FROM COMMANDER (RMC). REF B IS COMUSFLTFORCOMINST
4790.3 JOINT FLEET MAINTENANCE MANUAL AND PROVIDES GUIDANCE FOR BOILER
INSPECTIONS. REF C IS OPNAVINST 4790.4D 3-M MAINTENANCE MANUAL AND PROVIDES
DIRECTION FOR CSMP DOCUMENTATION.//
GENTEXT/REMARKS/1. NR (1A, 1B, 2A, ETC.) BOILER(S) ROUTINE INSPECTION WAS CONDUCTED
(DATE) BY (SGPI INSPECTOR NAME) ITEMS CORRECTED ARE REPORTED IAW REF B AS FOLLOWS:
1. (BOILER NUMBER)
A. BIRMIS ITEM (I.E., B14/01) JOB SUBMITTED JSN (NUMBER)
BT

**NOTE: ENSURE MESSAGES ARE IN ACCORDANCE WITH CURRENT MESSAGE FORMAT AND
CURRENT PLAD IS UTILIZED.**

(This Page Intentionally Left Blank)

VOLUME IV
CHAPTER 4
DIESEL ENGINES

REFERENCES.

- (a) OPNAVINST 9220.3 - Propulsion and Auxiliary Plant Inspection and Inspector Certification Program
- (b) NAVSEA S9233-CJ-HBK-010/020 - U.S. Navy Diesel Engine Inspectors Handbook, Parts 1 (Inspection Procedures) and 2 (Technical Information)
- (c) NAVSEAINST 4730.1 - Shipyard Inspection and Required Conditions of Propulsion Plant Systems (Non-Nuclear) on Nuclear Powered Submarines
- (d) NAVSEAINST 4730.2 - Inspection and Required Conditions of Propulsion Plant Systems (Non-Nuclear) for Nuclear Powered Aircraft Carriers
- (e) NWP 1-03.1 - Naval Warfare Publication Operational Report
- (f) NAVSEAINST 4790.8/OPNAVINST 4790.4 - Ships' Maintenance and Material Management (3-M) Manual
- (g) NAVSEA S9086-HB-STM-010 - NSTM Chapter 233 (Diesel Engines)
- (h) NAVSEA S9086-H7-STM-010 - NSTM Chapter 262 (Lubricating Oil)
- (i) NAVSEA S9086-GX-STM-020 - NSTM Chapter 220, V3 (Water Treatment)

LISTING OF APPENDICES.

- A Assessment/Inspection Main Propulsion Diesel Engine and Ship Service Diesel Generators for LSD-41/49 and LPD-17 Class Ships

4.1 PURPOSE. To provide guidance for the conduct of diesel engine inspections, timely correction of discrepancies and the general operation and maintenance of diesel engines.

4.2 DIESEL ENGINE INSPECTOR CERTIFICATION. The Diesel Engine Inspector (DEI) Program Manager is Naval Sea Systems Command (NAVSEA) Philadelphia. The Regional Maintenance Center (RMC) is the administrative manager for their respective region. DEI certification and certification extension requirements as outlined in reference (a), are amplified as follows:

- a. Initial Certification. All DEI candidates that have satisfactorily completed the required Certification course, Service School Command A-652-0311, shall receive an Interim Navy Enlisted Classification (NEC). The DEI candidate will have a period of one year from course completion date to satisfactorily perform two diesel inspections under instruction from a certified DEI. Upon completion of the second, successful inspection, the candidate must submit a request to be assigned the DEI NEC 4314, through his chain of command to the appropriate RMC for their review. The RMC will forward their endorsement to the Type Commander (TYCOM) for their endorsement, if required, and then to NAVSEA Philadelphia, who initiates the process of assigning the 4314 NEC. Initial qualification to perform diesel inspections will be for a period of 36 months. The requesting letter must contain:
 - (1) A copy of the two completed inspection reports performed under the observation and supervision of a DEI.
 - (2) Date of graduation from the certification course of instruction.
- b. Transfer of the DEI will not require re-designation or re-qualification, as long as the DEI has maintained his qualifications in accordance with paragraph 4.2.c. of this chapter.
- c. Maintaining Certification. All DEIs must maintain up to date knowledge of approved inspection practices and policies. Certification will be maintained by:
 - (1) Successfully conducting a minimum of two inspections annually in accordance with reference (b).
 - (2) In each calendar year, attending one of the semi-annual inspector seminars. DEIs unable to meet this requirement may obtain a waiver from the Program Manager.

- (3) Extending Qualification. Qualified inspectors may request to extend their initial or subsequent qualifications, in 36 month increments, providing that the requirements in paragraph 4.2.c. of this chapter are met. To extend qualification:
 - (a) The DEI shall submit a letter to the RMC requesting qualification extension that includes a brief description of the inspector's duties during the qualification period, specify the date of the latest seminar attended and provide as enclosures a copy of the two most recent inspection report cover letters performed by the inspector.
 - (b) The RMC shall endorse the letter and forward it to the Diesel Program Manager.
 - (c) The TYCOM may require endorsement on these extension requests.
- d. Revoking Certification. If an inspector has not maintained the qualification requirements of paragraph 4.2 of this chapter, the RMC may submit a request to the Program Manager to have the DEI NEC4314, removed from the inspector. The TYCOM requires endorsement on this action.
- e. Reinstatement of Expired/Revoked Certification. A DEI whose certification either expired or was revoked may request reinstatement of his certification by submitting a letter to the Program Manager via his chain of command and the RMC. The letter must contain:
 - (1) A brief description of the DEI's duties during and following the certification period.
 - (2) Copies of the two most recent inspections performed. If the DEI's certification has been expired for more than six months prior to the request or was revoked, the two most recent inspections shall be completed under the instruction of a certified DEI.

4.3 DIESEL INSPECTIONS.

NOTE: FOR THE ASSESSMENT/INSPECTION OF MAIN PROPULSION DIESEL ENGINES (MPDE) AND SHIP SERVICE DIESEL GENERATORS (SSDG) ON LSD-41/49 AND LPD-17 CLASS SHIPS SEE APPENDIX A.

4.3.1 Diesel Engines Requiring Inspections.

- a. All diesel engines, including main propulsion, ship service and emergency diesel generators onboard ships and submarines shall be inspected in accordance with references (a) and (b).
- b. All small boat diesel engines, including main propulsion, ship service and emergency diesel generators that are 400 Brake Horsepower and above, unless otherwise determined by TYCOM, shall be inspected in accordance with references (a) and (b). TYCOMs may exempt diesel engines on small boats and craft from inspection requirements where the engine or boat configuration provides insufficient access to accomplish the inspection.

4.3.2 Periodicity of Inspections. Diesel engines shall be inspected in accordance with references (a) and (b) on the following events:

- a. Routine/Pre-Availability Inspections.
 - (1) Once during the unit's cycle, not to exceed 24 months. The normal interval between routine diesel inspections is 18 months. Routine/Pre-Availability Inspections may be performed as early as 12 months or as late as 24 months to allow for maximum scheduling flexibility and utilization of assessment findings. The TYCOM, Immediate Superior in Command (ISIC) and other Fleet Maintenance Managers shall ensure the Routine/Pre-Availability Inspection is scheduled to allow adequate time prior to availabilities to utilize the inspection/assessment results to plan work on the diesel. As per reference (a), in no case shall the interval between Routine Inspections exceed 24 months. A Routine/Pre-Availability Inspection normally consists of all three phases as discussed in paragraph 4.3.4 of this chapter. For Emergency Diesel Generators (EDG) onboard nuclear powered vessels, industrial activity work on the diesel engine(s) or its support systems will not normally be approved except during a Chief of Naval Operations (CNO) Availability. The TYCOM/ISIC shall ensure that adequate upkeep time is made available prior to the availability to ensure there are a sufficient number of diesel engines with no outstanding discrepancies to provide the required standby power during the availability.

- (2) For Submarine CNO Availabilities greater than six months.
- (a) The Pre-Availability Inspection shall be integrated into the Shipyard's work definition period and shall be considered the **material health assessment** for the EDG.
 - (b) SUBMEPP shall enter this Pre-Availability Inspection in the applicable 000-Series SWLIN as a **material health assessment** assigned to Forces Afloat.
 - (c) The DEI shall include the Executing Shipyard (Code 260) and the Supervisor of Shipbuilding/NAVSEA Shipyard Representative's Office, as applicable, on distribution for all DEI reports conducted as a Pre-Availability Inspection or during the availability.
 - (d) As Lead Maintenance Activity, the executing shipyard will work with the TYCOM to assign all deferred inspection deficiencies to the appropriate repair activity for repair.
 - (e) The Shipyard's technical review of this inspection report may satisfy the Pre-Availability technical assessment requirement of reference (c).
- b. Post Casualty/Pre-Overhaul. When major internal engine malfunctions have occurred or are suspected (e.g., crankcase explosion, major bearing, blower or crankshaft failure), or there are indications that the engine is in need for overhaul. Extent of disassembly/inspection is at the discretion of the DEI based on the casualty or observed indications. For Post Casualty Inspections, the DEI must determine the full extent of damage and the cause, along with recommendations for repairs. For Pre-Overhaul Inspections, the TYCOM may require the DEI confirm that an overhaul is required and determine the scope of the overhaul. Partial inspections do not satisfy the requirement for a complete Routine Inspection and this fact will be annotated in the DEI's written report.
- c. Post Overhaul/Repair. When an engine has been overhauled or significant maintenance/repair has been completed. A Post Overhaul/Repair Inspection shall be conducted by a DEI prior to continuous operation. The DEI will make the final determination of whether the overhaul/repair was extensive enough to warrant a Post Overhaul/Repair Inspection. The inspection shall consist of a review of actions taken to complete the overhaul/repair, external visual inspection, tests of safety devices, review of required readings/clearances and a Phase III operational test. Unless there are indications of internal discrepancies, Phase II (internal inspection) is waived and the Routine Inspection periodicity requirement in paragraph 4.3.2.a of this chapter will be considered complete and valid. The Post Overhaul/Repair inspection should be an integral part of the overhaul/repair vice a separate inspection. Specifically, the Phase III operational test should be part of the final operational testing of the overhaul/repair vice a separate operational test.
- (1) For contractor accomplished work, the contractor specification will contain requirements for the contractor to document required readings/clearances on applicable forms and have appropriate check points made by a DEI/Industrial Subject Matter Expert (SME) during the overhaul/repair. If there is evidence of poor workmanship, use of improper parts, discrepancies in reassembly/test documentation or missing information as part of the repair process or during the inspection, the DEI/Industrial SME will advise the Repair Project Manager of the quality issues and required actions. The Repair Project Manager will coordinate required actions with the RMC Technical Authority and Maintenance Team. The RMC shall liaise with the TYCOM and obtain TYCOM concurrence on all required actions and shall advise the TYCOM of all potential cost and schedule impacts.
 - (2) For Ship's Force/Fleet Maintenance Activity accomplished engine overhauls, a Post Overhaul/Repair Inspection will be conducted by a DEI prior to starting the engine. The scope of the inspection will be as specified in paragraph 4.3.2.c of this chapter. Commanding Officer (or designated representative) permission is required to perform Phase II (internal inspection) when requested by the DEI.
- d. New Construction (Acceptance Inspection).

- (1) Prior to the delivery of a newly constructed ship, when requested by the Board of Inspection and Survey. An acceptance inspection will normally be conducted in conjunction with the open-and-inspect phase of Board of Inspection Survey acceptance trials. The acceptance inspection does not satisfy the requirements of a routine inspection.
 - (2) The initial Routine Inspection on a new construction unit shall occur prior to initial start up by Ship's Force. The cognizant Supervisor of Shipbuilding should incorporate the DEI as part of the Government Test Plan/Acceptance Plan. The cognizant Supervisor of Shipbuilding shall notify the DEI for new construction acceptance test prior to Ship's Force accepting responsibility of the diesel engine. This will ensure that an inspection baseline is established and construction discrepancies are identified/corrected early in the life of the unit.
 - (3) For submarine and CVN construction programs, the initial Routine Inspection on a new construction unit shall occur prior to initial start up by Ship's Force. For ships with temporary systems in place or less than 95 percent load available, the Phase I (see paragraph 4.3.4a of this chapter) and Phase II (see paragraph 4.3.4b of this chapter) inspections shall occur in conjunction with crew Operational Control Transfer including an operational test at available load. The Phase III (see paragraph 4.3.4c of this chapter) inspection shall occur prior to ship delivery when sufficient loading is available. Any as found conditions requiring corrections shall be adjudicated via the normal shipyard Operational Control Transfer inspections adjudication process. The routine diesel inspection periodicity shall commence upon completion of all three diesel engine inspection phases.
- e. Reactivation of Engines in Inactive Equipment Maintenance. Prior to the first operation of engines which have been placed in Inactive Equipment Maintenance. The inspection consists of a Phase I review of the actions taken to place the engine in and out of lay-up status, external visual inspection, test of safety devices and a Phase III operational test. Unless there are indications that an internal inspection (Phase II) is required, the inspection will be considered complete. This inspection should be requested far enough in advance of the first key event requiring use of the diesel. This will ensure any significant discrepancies found can be corrected prior to the start of the key event. This inspection does not satisfy the requirements of a routine inspection as per paragraph 4.3.2.a of this chapter unless a complete Phase II is accomplished.

4.3.3 Inspection Scheduling.

- a. Diesel inspections are scheduled by the ship with RMC, via ISIC when appropriate, in accordance with reference (a) and the Planned Maintenance System (PMS). As part of this process, units shall contact the local RMC/ISIC Diesel Inspector to schedule the diesel inspection 120 days prior to the desired inspection date and submit a work request (OPNAV 4790/2K) to the appropriate RMC a minimum of 90 days in advance of the desired dates to allow for DEI scheduling.
- b. It is the responsibility of the Fleet Maintenance Managers (the ship, ISIC, and Ashore Ships Maintenance Managers, as appropriate) to schedule the diesel inspection with the RMC during a period where the inspection's condition assessment can be best utilized for repair planning. The inspection may require that each engine being inspected normally be placed out of commission for five to seven days at the minimum. This time frame may increase when significant Repair Before Operating (RBO) discrepancies are discovered that require extensive repairs. Sufficient time must be allowed for the performance of the operational phase of the inspection which requires specific load testing as defined by PMS. SSDGs normally have the operational phase performed inport, whereas operational assessment of MPDEs requires the ship to be underway for a minimum of one day. Units with MPDEs must allot underway time to allow the DEI to complete the operational phase. The operational phase of the inspection must be completed within 90 days of the start of the inspection. If the operational phase cannot be completed within these 90 days, a TYCOM approved Departure From Specification (DFS) per Volume V, Part I, Chapter 8 of this manual is required. Without a DFS, the inspection will be terminated and rescheduled. Ships should integrate the operational phase of the inspection into the Fleet Response Training Plan underway schedule.
- c. A Diesel Inspection shall be accomplished by an ISIC/RMC DEI. It is encouraged that persons holding the DEI NEC that may be assigned to the ship being inspected be part of this inspection.

4.3.3.1 Inspection Deferrals. Surface and Carrier Forces shall submit a minor DFS for approval by the respective TYCOM for diesel inspections in the 18 to 24 month window. When an inspection cannot be accomplished within 24 months, Surface, Carrier and Submarine units shall submit a DFS request to the TYCOM no later than the 23rd month since the last inspection, that includes satisfactory operating trend data reviewed by a DEI confirming that the engine is in sound operating condition. For inspection deferrals of greater than 24 months, the TYCOM will forward endorsement to NAVSEA 05Z for approval of the DFS.

4.3.4 Inspection Phases. The diesel inspection consists of a detailed records check, internal material condition inspection and observation of engine operating characteristics. During all phases of an inspection, all safety precautions with the engine and space shall be strictly adhered to. The degree of the inspection shall be decided by the DEI based on the results of reference (b) mandatory check points, TYCOM directed check points, if any, operating data and other records maintained on the diesel engine. The inspection will include the following phases (For LSD-41/49 Class ships and LPD-17 Class ships see Appendix A):

- a. Phase I - Administrative Inspection. This is a complete review of the administrative records associated with the diesel engine(s).
- b. Phase II - Secured Inspection (partial disassembly). Based on the results of Phase I, the inspector will decide the degree of disassembly and will conduct a thorough evaluation of the internal condition of the engine as warranted by Phase I and Phase II findings. In accordance with reference (b), disassembly of the engine will be minimized. Submarines shall have a complete Phase II Inspection in accordance with reference (b).
- c. Phase III - Operation Inspection. The DEI will observe and analyze operating data on all inspected engines in accordance with reference (b) and PMS Maintenance Requirement Card (MRC) for performance testing/troubleshooting the engine. If no PMS guidance exists, then 100 percent or maximum attainable load on all inspected engines should be achieved.

4.3.5 Preparation for Diesel Engine Inspection.

- a. The DEI shall meet with the inspected ship's Commanding Officer or his designated representative, Engineer Officer and a diesel system expert prior to the start of the inspection. Where appropriate, either the Reactor Officer or the Engineer Officer may fulfill this role. This visit will ensure that Ship's Force is aware of the extent of the inspection, what PMS is to be accomplished, required support to be provided to the DEI and interference to be removed to allow access to the diesel engine. Coordination between the ship and the DEI can significantly reduce the time the diesel will be out of commission for inspection purposes and maximize the training to Ship's Force. Ship's Force will perform diesel engine disassembly, reassembly and operation, as well as correcting Ship's Force capable discrepancies concurrent with the inspection. It is the responsibility of Ship's Force to order all software and repair parts for Ship's Force capable work, to include all gaskets, lockwire, etc., for engine reassembly. Discrepancies beyond Ship's Force capability will be scheduled to be corrected through the Fleet Maintenance Managers, utilizing the Current Ship's Maintenance Project. At all times during the inspection, safety precautions with the engine and the space will be strictly adhered to. The DEI will meet with the Main Propulsion Assistant or Engineer Officer on a daily basis to ensure the unit's leadership is informed and produce optimal coordination efforts.
- b. The ship will:
 - (1) Prepare the diesel engine for inspection.
 - (2) Provide the DEI with dedicated time and the appropriate personnel to conduct the inspection. The inspection will be structured to maximize training of shipboard personnel. The ship should ensure continuity of personnel is maintained during the inspection/assessment.
 - (3) Assign a Job Control Number for accomplishing the inspection and record all parts usage through the Maintenance and Material Management system.

- (4) Ensure all equipment directly associated with the engine(s) is operable.
- (5) Ensure all records are available and in good order.
- (6) Ensure that the tools listed on the appropriate MRCs, technical manuals, and DEI check sheets are available for use during the inspection.
- (7) Ensure that all applicable MRCs and technical manuals for the engine and related support systems are available.
- (8) Test diesel engine lubricating oil in accordance with the applicable Lube Oil Quality Management program, as defined by PMS, prior to the inspection. In most cases, this requires Navy Oil Analysis Program results of recent oil sample be available.
- (9) Test jacket water treatment in accordance with PMS prior to the inspection.
- (10) For SSN/SSBN/SSGN Class Submarine EDGs, the unit should evaluate existing conditions of battery capacity, propulsion plant status and shore power reliability. Based upon this evaluation, if conditions warrant, the ship will submit a request for a stand-by generator for emergency power during the diesel inspection.

4.3.6 Inspection Findings. The inspection will report “as found” conditions.

4.3.6.1 Repair Before Operating. An RBO condition is any condition existing that, if left unattended, would pose an immediate or near term hazard to personnel safety. Only a DEI that is currently certified may issue an RBO. RBO deficiencies require reinspection by a DEI that is currently certified after repairs and before the diesel engine is operated. A DFS will not be approved for RBOs. If there is not an immediate or near term danger to personnel but there is to the equipment, the discrepancy shall be assigned as SEVERELY DEGRADED with major operational restrictions. A diesel engine with SEVERELY DEGRADED condition cannot be operated until it is corrected/repaired and reinspected or has a properly approved Major DFS. Discrepancies that may cause an RBO include but are not limited to:

- a. Malfunctioning overspeed governor or trip.
- b. Inoperative alarms or safety devices.
- c. Low lube oil pressure.
- d. Readings that exceed the limits of PMS or manufacturer specifications that would pose a hazard to personnel.
- e. Uncontrollable lube oil or fuel oil leaks.
- f. Lube oil fuel dilution above safe levels.
- g. Evidence of serious internal failure.

4.3.6.2 Major Deficiency. This finding is made when major problems exist, but the engine is still operable with restrictions approved by the TYCOM. Any deficiency that has been noted as major shall require either immediate correction within 30 days of discovery or reported by Naval message in accordance with paragraph 4.4.b(3) of this chapter. This requirement does not alter the normal Casualty Reporting or DFS reporting requirements. In accordance with references (a) and (b), major deficiencies include, but are not limited to:

- a. Engine unable to maintain rated load.
- b. Automatic equipment inoperative or not functioning properly.
- c. Critical components exceed prescribed limits but do not meet the RBO criteria.
- d. Temperature and/or pressure between cylinders are not within specification.
- e. Either Remote or Local engine starting (one of two must be operational) or remote securing devices are inoperative.
- f. Excessive blower clearance readings.
- g. Air box exhaust belt/muffler is excessively dirty or oil laden.

- h. Clogged valves or ports.
- i. Malfunctioning fuel injection system.
- j. Jacket water treatment out of specification.

4.3.6.3 Minor Deficiency. Categorize all other deficiencies as minor.

4.3.6.4 Re-inspections. RBO deficiencies must be re-inspected prior to engine operation by a DEI. If possible, the original DEI should be used, if available. Re-inspection of major and minor deficiencies is not required unless stated in the engine's inspection report.

4.3.6.5 Recurring Discrepancies. A recurring discrepancy from a previous inspection will be so noted on the inspection report.

4.3.6.6 Component Certification (Aircraft Carriers only). With the exception of RBOs, deficiencies identified in the course of diesel engine inspections performed prior to or during a CNO availability do not necessarily affect component certification to support readiness conditions identified in reference (c) and reference (d). Evaluation of specific deficiencies by Ship's Force and Naval Supervisory Authority/project team personnel is necessary to determine system readiness conditions are met. An emergency diesel generator is considered certified for operation per reference (c) and reference (d) provided the diesel inspection and all required PMS are within periodicity, including completion of a satisfactory performance test.

4.4 REPORTING REQUIREMENTS.

- a. Casualty Reporting (submarines only).
 - (1) Purpose. To provide guidance for Casualty Reporting (CASREP) requirements for submarine diesel generators. CASREPs are in addition to, and do not replace the reporting requirements of other documents (e.g., Naval Reactors Technical Bulletins, Operational Orders, Mishap Reports, etc.).
 - (2) Background. The significance of a submarine's emergency and backup power supplies cannot be overstated. Reference (e) defines the CASREP types, requirements and format. CASREP requirements of Out of Commission power generating or storage equipment require additional clarification.
 - (3) SSBN/SSGN Class Submarine EDGs. Report EDG casualties by message as allowed by operational constraints.
- b. The ship's Commanding Officer shall:
 - (1) Ensure that each inspection/assessment is entered in the applicable machinery history with a brief description of any RBO conditions found at the conclusion of the assessment/inspection.
 - (2) All maintenance actions and parts usage as the result of the inspection/assessment are properly documented in accordance with reference (f).
 - (3) Send a Naval message listing the status of all discrepancies listed in the inspection/assessment report within 30 days of receipt of the serialized report and every quarter thereafter until all deficiencies are corrected/resolved or brokered by the Maintenance Manager. The message must contain the engine number, date of inspection, type of inspection conducted, and the status of deficiencies not previously reported as corrected or a listing of what has been brokered. All deficiencies not corrected during or immediately after the inspection must have a Job Control Number assigned and be listed in the message. The ISIC/Fleet Maintenance Managers shall ensure that the deficiencies listed in the inspection/assessment message are corrected at the earliest opportunity in the unit's maintenance cycle.
- c. The DEI shall:

- (1) The DEI shall ensure a maintenance ready 2-Kilo for every discrepancy found during the inspection is entered into the Current Ship's Maintenance Project. The DEI shall also make a verbal report to the ship's Commanding Officer or his designated representative. The verbal report should discuss the findings of the inspection/assessment, with special note of recurring discrepancies from previous inspections/assessments.
- (2) Prepare the inspection report in accordance with reference (b) within 30 days following completion of the inspection. The write up shall further detail the cause or conditions that lead to the discrepancy noted on the 2-Kilo or in the report. The report shall identify what was accomplished during the inspection/assessment to correct any discrepancies and any actions required to correct outstanding discrepancies.
- (3) Utilize the Diesel Inspection Management Information System using the DEI report generator for classes of ships that are currently in use. For classes of ships that are not yet in the system, use the current guidance that is in reference (b). This inspection shall be reviewed by the RMC prior to forwarding the report to the Commanding Officer of the inspected ship, with information copies to the ISIC, TYCOM, Fleet Maintenance Managers, the cognizant Shipyard (Code 260) and Supervisors of ShipBuilding/NAVSEA Shipyard Representative's Office (Pre-Availability and during Availability Inspections only) and In Service Engineering Agent.

4.5 OPERATION AND MAINTENANCE. This section does not supersede existing engine, ship or ship class specific guidance and is only meant to provide guidance where currently none exists.

- a. Per reference (g), the light loading of a diesel engine (less than 60 percent) should be avoided. Consistently light loading a diesel engine will cause one or more undesirable conditions, depending on specific engine design:
 - (1) A loss of cylinder compression due to glazed cylinder walls, leading to an unnecessary premature engine overhaul.
 - (2) Carryover of engine lube oil into the exhaust, causing excessive exhaust smoke and creating conditions for a possible exhaust stack fire.
 - (3) Fuel oil dilution of lube oil, leading to frequent oil changes.
 - (4) Carbon formation on exhaust valves, leading to valve failure.

In situations where light loading of a diesel engine is unavoidable, arrangements should be made to operate the engine at 60-80 percent rated load capacity for a minimum of thirty minutes, preferably three hours, unless other guidance exists specific to the engine's application. This can help offset the detrimental effects of light loading; however, it is not to be considered a suitable alternative to the avoidance of light loading. Further details are provided for LSD-41/49 Class MPDE in Appendix A.
- b. Per reference (h), diesel engines that have online purification capability shall operate the purifier continuously while the diesel engine is operating. On installations where multiple engines are serviced by one purifier, the purifier alignment should be shifted periodically within a 24 hour period to ensure all engines receive adequate oil purification and maintain satisfactory oil condition. Each engine's operating hours and oil condition should be considered when scheduling purification of several engines on a rotational basis.
- c. Per reference (i) and PMS, diesel engine jacket water treatment must be tested and maintained to ensure proper corrosion control and freeze protection, as applicable.
- d. Diesel engine operating hours since engine commissioning, engine overhaul and lifecycle maintenance requirement completions (PMS/Class Maintenance Plan requirements), at a minimum, shall be maintained on all MPDEs, SSDGs, and EDGs. The hours shall be documented and recorded in the appropriate machinery history records in order to assist with scheduling of overhauls and lifecycle maintenance requirements. An overhaul typically includes rebuilding/replacing, as complete sets to new criteria the following components: cylinder heads, piston rings, cylinder liners, main and connecting rod bearings. If one of these sets is not rebuilt/replaced, the repair is generally not considered an overhaul and engine operating hours since overhaul shall not be zeroed, however, machinery history will be

updated and lifecycle operating hours since the significant repairs shall be tracked. A certified DEI shall make the final determination if the extent of the work accomplished constitutes an engine overhaul for a particular engine or not during execution of the Post Overhaul/Repair Inspection detailed in paragraph 4.3.2(c) of this chapter.

4.6 COMPLIANCE.

- a. All ships, submarines and craft shall comply with the procedures herein for the operation, maintenance and inspection of installed diesel engines.
- b. Ship's Commanding Officers shall ensure all diesel records are readily available for the inspector's review and Ship's Force use, including:
 - (1) Engine operating logs.
 - (2) Navy Oil Analysis Program test results, or, for submarines, the applicable oil analysis results.
 - (3) Onboard lube oil testing logs.
 - (4) Diesel Maintenance/history records to include all maintenance and significant items accomplished on the engine since last engine overhaul.
 - (5) Diesel operating and maintenance documents, including Engineering Operational Sequencing System, Steam Plant Manual, Ship System Manual (Submarines only), PMS, Engineering Standing Orders, etc., as appropriate.
 - (6) Engine hours log.
 - (7) Diesel inspection reports since last overhaul and associated Naval message on the status of discrepancies.
 - (8) Fuel Oil Quality Management records.
 - (9) Diesel Engine Technical Manuals.
 - (10) References (g), (h) and (i).
 - (11) Appropriate diesel-related Training records.
- c. The TYCOM/ISIC shall ensure that assigned ships operate and maintain diesel engines in accordance with the procedures in references (a), (b), (g), (h) and (i). Specifically, they shall:
 - (1) Ensure ships are complying with all required instructions by observation of diesel engine operations during shipboard visits.
 - (2) Conduct follow-up action to ensure that any unsatisfactory conditions found are correct at the earliest possible date.
 - (3) Maintain a library of technical material and appropriate visual aids for use by assigned ships in training diesel operations.
- d. (Submarines only) Ensure the induction and exhaust systems are inspected in accordance with the appropriate Maintenance Requirement, and/or Maintenance Requirements for continued Unrestricted Operation.

4.7 SUBJECT MATTER EXPERT IN THE REPAIR AND MAINTENANCE OF DIESEL ENGINES. The SME provides technical oversight on all scheduled and emergent work performed by the RMC personnel, and contractor, as required. The SME ensures work packages include proper repair procedures and are used with maintenance standards and appropriate technical documentation related to the diesel engine assessment/inspection. The SME shall have direct communication with the RMC Engineering Department regarding resolutions of repairs that do not meet Original Equipment Manufacturer specifications.

This Page Intentionally Left Blank

APPENDIX A

ASSESSMENT/INSPECTION MAIN PROPULSION DIESEL ENGINE AND SHIP SERVICE DIESEL GENERATORS FOR LSD-41/49 AND LPD-17 CLASS SHIPS

Purpose: To provide direction for assessment vice inspection of LSD-41/49 and LPD-17 Class ship engines.

1. ROUTINE/PRE-AVAILABILITY DIESEL INSPECTION. Per Commander Naval Surface Force policy and concurred by NAVSEA Technical Warrant, the Routine/Pre-Availability diesel inspection directed by reference (a) is replaced with this Appendix's diesel assessment process. Note that Paragraphs 4.3.2.(b) through 4.3.2.(e) of this chapter remain applicable for LSD-41/49 and LPD-17 class MPDE and SSDGs.
2. OBJECTIVE. Significant repairs and I/D-Level work packages shall be accomplished by directive maintenance. Condition based maintenance is defined as maintenance that is directed by the engine's condition. Engine condition shall be assessed by non-intrusive monitoring and analysis of operating data, supplemented by engine performance data. The goal is to avoid significant disassembly, which includes such things as removal of cylinder heads, bearings, vertical drive assemblies, etc. Significant disassembly does not include removal of covers, use of borescopes, conducting main bearing presses, or removal of fuel injection components.
3. ASSESSMENT. Assessment of engine condition shall be accomplished by two, interrelated processes: Continuous Assessment/Analysis of data and Formal Periodic Assessment/Analysis of equipment condition and on board documentation. This process is based on continuous assessment and continuous analysis, is focused on the integration of fluid management, measured engine performance, assessment, analysis, recommendations and feedback.
4. CONTINUOUS ASSESSMENT/ANALYSIS. Each engine's condition data shall be analyzed on a monthly basis to identify any abnormalities, downward trends or other issues. Results of each Continuous Assessment shall be reported, with recommendations for corrections of any problems/potential problems, to the Ship's Engineer Officer and ISIC and documented in the Shipboard Automated Maintenance Module (SAMM). Condition data assessed shall include, but not limited to:
 - a. Lube oil results from onboard oil test kits (Kittiwake).
 - b. Lube oil results from shore based oil testing lab (PREDICT).
 - c. Fuel oil log results.
 - d. Jacket water log results.
 - e. Engine hour data.
 - f. Engine repair data.
 - g. Electronic log review.
 - h. Engine performance data (DOCTOR).

If the ship is locally available, a visit shall be conducted to review the data with ship's personnel.

5. FORMAL PERIODIC ASSESSMENT/ANALYSIS. A Periodic Assessment will be accomplished with the same periodicity as non-LSD-41/49 and LPD-17 MPDE and SSDG diesel engine inspections. At the 18th month point, a formal data review of the previous 18 months of collected data will be completed to determine if the data supports continued engine operation without inspection. This analysis will also be used as the foundation for recommending directed inspection of specific engine components as required. A minor DFS is required to the TYCOM with recommendation from RMC to extend engine operation to 24 months without completion of the formal periodic assessment. Extension of the assessment beyond 24 months will require a major DFS granted by NAVSEA 05. The 18 month clock is either measured from the last Periodic Assessment, the last diesel inspection, or the one-time baseline assessment, or as directed by an approved DFS (see below), as applicable. The DEI shall perform everything in the Continuous Assessment plus Phase III – Operational Inspection (paragraph 4.3.4.c. of this chapter). The DEI will determine if a full Phase II (paragraph 4.3.4.b. of this chapter), a focused portion of Phase II, as required PMS MRCs related to a Phase II, or any other significant disassembly is warranted. If the DEI

concludes that all or part of Phase II, specific PMS MRCs, and/or significant disassembly is warranted, then the RMC shall recommend this to the TYCOM by Naval Message for TYCOM approval. If the DEI concludes that the diesel engine is in sound condition and does not warrant any part of Phase II, applicable MRCs, or significant disassembly, then the RMC shall recommend by Naval Message to the ship to submit a DFS extending their periodic assessment. TYCOM can extend the periodic assessment up to 24 months with a minor DFS; beyond 24 months will require a major DFS granted by NAVSEA 05. The DFS approval shall include when the next Periodic Assessment should be scheduled.

6. RESPONSIBILITIES.

- a. TYCOM. Review/approve RMC recommendations resulting from Formal Periodic Assessments/Analysis.
- b. ISIC. Ensure that the ship has available time in the schedule to execute the Formal Periodic Assessment/Analysis.
- c. RMC. Maintenance Team to schedule Formal Periodic Assessments/Analysis. The RMC shall provide the Formal Periodic Assessment/Analysis recommendations to TYCOM by Naval Message. Maintenance Team will schedule diesel engine repair work based on results of the Continuous Assessments, Formal Periodic Assessments, Current Ship's Maintenance Project, emergent repairs and Class Maintenance Plan.
- d. DEI. DEI will complete the appropriate sections of the DEI Report, defined by reference (b), for each Periodic Assessment and post them in SAMM. DEI will also post results of Continuous Assessments in SAMM. When performing steps 4.3.2.b through e of this chapter, DEIs shall utilize engine condition data to the fullest extent possible.
- e. SHIP. To submit oil samples, record DOCTOR data, Kittiwake results, engine operating hours, maintenance actions accomplished (including PMS), fuel oil, jacket water data and any abnormal conditions in SAMM. To follow the actions recommended by the shore based technical community's assessment and report the actions taken and the results in SAMM.
- f. IN-SERVICE ENGINEERING ACTIVITY. Monitor the Continuous Assessment/Analysis and Formal Periodic Assessment/Analysis process, utilizing SAMM.

7. FUEL OIL DILUTION. Additional guidance for fuel oil dilution of lube oil for LSD-41/49 MPDEs and SSDGs:

- a. Fuel dilution 1.0-2 percent is a cautionary condition and requires monitoring by daily sampling.
- b. Fuel dilution greater than 2 percent is a hazard condition and considered unacceptable for continued use.
- c. Fuel dilution greater than 5 percent is a RBO per paragraph 4.3.6.1 of this chapter.

Source of fuel shall be identified and repaired. Sump and lube oil filters and strainers shall be drained and refilled with new oil when operationally feasible and resample to confirm corrected condition. Engines with fuel dilution levels greater than 2 percent may be operated at the discretion of the Commanding Officer if operational circumstance dictates (e.g., restricted maneuvering) with a TYCOM DFS.

8. LIGHT LOADING. Additional guidance for light loading of LSD-41/49 MPDEs: Light loading of Pielstick PC2.5 MPDE is defined as operation below 60 percent of the engine rating. This translates to operation of the engine at below 24 mm fuel rack position. Light loading of MPDEs should be avoided. In situations where light loading of engines is unavoidable, arrangements should be made to operate the engines at above 80 percent rated load (31 mm fuel rack). Operation above 80 percent rated load shall be conducted for a minimum of one hour (after operating temperatures and pressures have stabilized) for every four hours of light load operation during a twenty-four hour period.

VOLUME IV
CHAPTER 5
MARINE SANITATION DEVICES

REFERENCES.

- (a) NAVSEAINST 9593.1 - Certification Program for Sewage Marine Sanitation Devices in U.S. Navy Surface Ships and Craft
- (b) OPNAVINST 5090.1 - Environmental and Natural Resources Program Manual
- (c) NAVSEA S9086-T8-STM-010 - NSTM Chapter 593 (Pollution Control)
- (d) NAVSEA S9086-CH-STM-030 - NSTM Chapter 074 V3 (Gas Free Engineering)
- (e) NWP 1-03.1 - Naval Warfare Publication Operational Report
- (f) NAVEDTRA 10500 - Catalog of Navy Training Courses

5.1 **PURPOSE.** To provide guidance in the operation, maintenance and certification of surface ship Marine Sanitation Devices (MSD) and to specify the requirements, procedures and responsibilities applicable to those systems.

- a. Sewage systems must be properly operated and maintained or serious health hazards can result. References (a) and (b) require that all MSD systems being installed on naval ships and craft be inspected and certified. The prevention of health, sanitation and safety problems associated with the various sewage handling and disposal systems shall be a priority matter.
- b. Environmental considerations have made the operation of shipboard sanitation systems more restrictive with regard to the discharge of sewage to navigable waters. Local and State environmental laws are generally more restrictive than the requirements of reference (b). Senior Officer Present Afloat regulations are continually reviewed and revised to comply with the laws under which the Senior Officer Present Afloat is licensed to operate sanitation systems.

5.1.1 **Scope.** This chapter is applicable to all surface ships, service craft and small boats on which pollution abatement sewage systems are installed, either during construction or by alteration. It includes all types of shipboard sewage handling and treatment systems or MSDs certified in accordance with reference (a) and described in Section 4 of reference (c). Reference (d) describes the procedures, equipment, and records to be used during maintenance of MSD system components where toxic and/or combustible gases may be present. The most common pollution abatement sewage system in use on ships and craft is the Collection, Holding and Transfer system. Other systems in use include the Pall Trinity, JERED, GATX MK1 and the Vacuum Collection, Holding and Transfer System.

5.2 **CERTIFICATION.** The purpose of MSD certification is to confirm that the system, as installed, meets established design requirements, that adequate logistic support is available onboard, and that major installation deficiencies are corrected. A single level certification program has been implemented by Naval Sea Systems Command to supersede the older two level system (provisional and full). Ships that presently hold a "Full" certification are considered to be certified and require no further certification inspections.

5.3 **RESPONSIBILITIES.** The cognizant Type Commander (TYCOM) will coordinate the operation, maintenance, and certification of MSD systems installed on all units in accordance with the procedures established by references (a) and (c).

5.3.1 **Type Commander/Immediate Superior In Command.** The TYCOM/Immediate Superior In Command shall:

- a. Ensure surface ships participate in the pollution abatement program to the maximum extent possible by utilizing their pollution control equipment when within U.S. territorial waters (three miles).
- b. Ensure MSD systems are properly installed, operated, and maintained and that shipboard personnel working with sewage systems are properly trained in health and sanitation procedures.

5.3.2 **Commanding Officer/Officer In Charge.** The Commanding Officer/Officer In Charge shall:

- a. Oversee the correction of discrepancies on MSD system installations in accordance with reference (a).

- b. Prevent food stuffs from being stored in areas adjacent to or below sanitation system valves, flanges, or take down joints. Drip pans shall be installed beneath all sanitation system valves, flanges and take down joints in health sensitive areas.
- c. Log the time, duration and justification for each unavoidable discharge of prohibited sewage in restricted waters. Notify the TYCOM and Immediate Superior In Command of each occurrence. In a situation where holding sanitary wastes would present a health or safety hazard, the system shall be reported by Casualty Report in accordance with reference (e) and secured.

5.4 SYSTEM MAINTENANCE AND INSPECTION.

5.4.1 Fleet Maintenance Activity Maintenance.

- a. Ship-to-Shop Work. All Fleet Maintenance Activities are capable of accomplishing repair and overhaul of all MSD components on a ship-to-shop basis. When components are delivered to the Fleet Maintenance Activity, their cleanliness will be certified in writing by the delivering ship's Medical Department representative.
- b. MSD Cleaning. The only authorized MSD pipe cleaning processes are hydroblast cleaning and acid cleaning. Acid cleaning may only be performed by qualified activities using the procedures of reference (c). Request cleaning for the removal of hard deposits which cannot be removed by ordinary shipboard means.
 - (1) Due to the extreme hazards involved in cleaning MSD systems, a high level of supervisory attention must be applied to all evolutions. An agreement on the procedures to be used by the Fleet Maintenance Activity and Ship's Force shall be established by a locally prepared Memorandum Of Agreement which describes all aspects of the operation.
 - (2) Disposal of effluent must be accomplished in an environmentally safe manner. Depending on port availability, the following methods of disposal must be used in priority order:
 - (a) Discharge to pier side sewage system.
 - (b) Discharge to tank truck or barge.
 - (c) Discharge to sea (when hydroblasting while underway).
 - (d) If none of the above methods are available, and an emergency situation exists, refer to reference (b) for emergency disposal requirements.

5.5 TECHNICAL SYSTEM ASSESSMENT.

- a. Technical System Assessments may be requested for training or, when necessary, to develop a work package.
- b. Technical assist visits and assessments are described in Volume VI, Chapter 42 of this manual.

5.6 TRAINING.

- a. Training courses in the maintenance and operation of MSD systems are offered by Fleet Training Centers at various locations. Consult reference (f) for current course offerings and details.
- b. On ships with Collection, Holding and Transfer and JERED systems installed, the following school graduates are required:
 - (1) An Officer responsible for the operation and maintenance of the system.
 - (2) Senior enlisted personnel assigned the responsibility for operation and maintenance of the system.
 - (3) Other maintenance personnel; at least one in each inport duty section.

VOLUME IV
CHAPTER 6
OXYGEN AND NITROGEN SYSTEMS

REFERENCES.

- (a) NAVSEA S9086-SX-STM-010 - NSTM Chapter 550 (Industrial Gases; Generating, Handling, and Storage)
- (b) MIL-STD-1330 - Standard Practice for Precision Cleaning and Testing of Shipboard Oxygen, Helium, Helium-Oxygen, Nitrogen and Hydrogen Systems
- (c) NAVAIR A6-332AO-GYD-000 - Laboratory and Aviators Breathing Oxygen Field Guide

6.1 **PURPOSE.** Oxygen - Nitrogen (O₂-N₂) producing storage and transfer systems are installed onboard all Aircraft Carriers, Submarine Tenders and other surface force ships and shore stations to provide liquid and gaseous oxygen and nitrogen for use by Ship's Force and embarked air wings. Guidance for the proper operation and maintenance of these systems is provided by this chapter and references (a) and (b).

6.2 PRECAUTIONS.

- a. Oxygen is not flammable but supports and rapidly accelerates the combustion of all flammable materials. Any substance that burns in a normal atmosphere will burn much more rapidly in concentrated oxygen with a much higher flame temperature. Combustible material (e.g., dirt, dust, soap, oil, cloth, paper, wood, cork, carbon black and gasoline) should not be allowed to come in contact with an enriched oxygen environment. Oxygen can cause combustion of substances not normally considered burnable (notably steel wool, thin gauge metals and certain types of cloth).
- b. Gaseous nitrogen is an almost totally inert gas, does not burn, and does not support combustion or respiration. It is not poisonous but can displace oxygen from the air and cause asphyxia.
- c. Cryogenic fluids (liquid oxygen and liquid nitrogen) are extremely dangerous. They can cause severe burns or frostbite if they contact the skin. Prolonged exposure to the cold vapors can damage delicate tissues such as those of the eye, windpipe and lung. The cold surface of piping components, and vessels containing cryogenic fluid can burn or freeze bare flesh and cause it to stick to the cold metal. At the temperature of cryogenic fluids many metals and other materials become brittle. Ship structural steel can crack if contacted by cryogenic fluid. Liquid oxygen and nitrogen will produce a very large volume of gas when they vaporize. In a closed compartment with inadequate ventilation, vaporizing liquid can create a hazardously high concentration of oxygen or nitrogen. The cloudy vapor that appears from vaporizing liquid, or cold gas venting is condensed moisture, making the issuing gas visible. When handling liquid cryogenic products, personnel must utilize protective clothing in accordance with the requirements of reference (b) and comply with all safety rules.

6.3 AVIATORS BREATHING OXYGEN TESTING.

- a. Because of the severe consequences of liquid oxygen failing to meet the standards for Aviators Breathing Oxygen (ABO), stringent requirements for testing and ABO certifications have been established. Liquid oxygen/nitrogen is to be sampled and tested for production and stowage in accordance with reference (a) and Planned Maintenance System procedures.
- b. All Aircraft Carriers producing ABO have certified ABO test sites and are capable of certifying shipboard produced liquid oxygen. These ABO test sites are under the control of the shipboard Aviation Intermediate Maintenance Department. The testing and surveillance requirements of Aircraft Carrier shipboard O₂-N₂ plant oxygen/nitrogen products must be accomplished in accordance with reference (a) and meet the spectrographic analysis requirements of reference (c).

- c. Aircraft Carrier O₂-N₂ producers are known to experience high levels of methane (i.e., aircraft exhaust fumes, Collection, Holding and Transfer system discharge and boiler/Emergency Diesel Generator exhaust gases) which exceed the current established maximum limit of 25 parts per million per reference (c). The following direction is established for aircraft carrier O₂-N₂ producer liquid samples as stated in reference (a).
 - (1) For shipboard produced liquid oxygen, the limit for methane, when sampled at the storage tank, is 75 parts per million. This limit shall not be exceeded.
 - (2) Liquid oxygen samples drawn from the storage tank are "customer/user" samples, for issuance in compliance with the ABO surveillance program. Samples from the O₂-N₂ producer are Maintenance samples used for monitoring and contaminate analysis and correction.
- d. If at any time a liquid oxygen test sample or test method is found unsatisfactory, Ship's Force O₂-N₂ Plant operators and Aviation Intermediate Maintenance Department ABO laboratory personnel shall work together to identify and correct the problem. Guidelines to follow for this are outlined in references (a), (b), and (c).
- e. Certification of high pressure gaseous storage flasks shall be performed in accordance with reference (b).

6.4 OPERATIONS AND MAINTENANCE.

- a. In accordance with reference (a), only qualified personnel with full knowledge and understanding of the applicable safety requirements and hazards associated with oxygen production and handling shall be permitted to handle gaseous and liquid oxygen aboard ship. Equipment such as O₂-N₂ producing plants, storage tanks, and pump-vaporizer units shall be operated only under the supervision of a Fleet Cryogenics School graduate that holds a current Navy Enlisted Classification (NEC)-4283 qualification. Ideally, all operating personnel, as well as supervisory personnel, will be graduates of the Cryogenics School; however, there may be cases where sufficient personnel with this formal training are not available. In this event, operators trained by a currently qualified NEC-4283 supervisor may be used if they have successfully completed the required Personnel Qualification Standard and are designated in writing by the Commanding Officer.
- b. Only qualified personnel will be authorized to perform oxygen clean maintenance and repairs to shipboard oxygen or nitrogen system components. The procedures and guidelines, as stated in reference (b), must be followed.
- c. High-Pressure O₂-N₂ Producers onboard Aircraft Carriers are equipped with R-22 Refrigeration Units. When maintenance or repairs are being conducted on this equipment strict guidance must be followed to prevent the release of any ozone depleting substances (i.e., CFCs and HCFCs) to the atmosphere as mandated by the Environmental Protection Agency Clean Air Act. The Environmental Protection Agency Clean Air Act, Section 608 prohibits individuals from knowingly venting ozone depleting compounds, used as refrigerants, into the atmosphere while maintaining, servicing, repairing, or disposing of air-conditioning or refrigeration equipment. Only the following four types of ozone depleting substance venting releases are permitted under this section of the act.
 - (1) Absolute minimum quantities of refrigerant released in the course of making good faith attempts to recapture and recycle or safely dispose of refrigerants.
 - (2) Refrigerants emitted in the course of normal operation of air-conditioning and refrigeration equipment, (i.e., purging of air and non-condensable gases), as opposed to during the maintenance, servicing, repair or disposal of the equipment.
 - (3) Mixtures of nitrogen and R-22 that are used as holding charges or as leak test gases, because in these cases, the ozone depleting compound is not used as a refrigerant. However, a technician may not avoid recovering refrigerant by adding nitrogen to a charged system.
 - (4) Small releases of refrigerant which result from purging hoses or from connecting or disconnecting hoses to charge or service appliances. Additionally, refrigerant recovery and recycling equipment must be equipped with low-loss fittings.

- d. Personnel who perform maintenance or repairs to equipment that utilize ozone depleting substances, are required to successfully pass an Environmental Protection Agency approved technician certification test and be licensed before any commencement of work begins.

(This Page Intentionally Left Blank)

VOLUME IV

CHAPTER 7

ACCOUNTABILITY AND CERTIFICATION OF NUCLEAR
PROPULSION PLANT TEST AND SUPPORT EQUIPMENTREFERENCES.

- (a) NAVSEA 0989-031-4000 - Reactor Plant Instrumentation and Control Equipment Maintenance
- (b) NAVSEA 0989-064-3000 - Cleanliness Requirements for Nuclear Propulsion Plant Maintenance and Construction

LISTING OF APPENDICES.

- A Nuclear Test Equipment Check-Out/Check-In Form
- B Nuclear Support and Test Equipment Certification Record

7.1 PURPOSE. To promulgate requirements for the certification and accountability of Nuclear Propulsion Plant Test and Support Equipment as required by the applicable Reactor Plant Manual (RPM) and reference (a). Nuclear Propulsion Plant Test and Support Equipment is commonly referred to as Nuclear Test Equipment (NTE).

7.1.1 Discussion. NTE specified by the applicable RPM and reference (a) to support planned and corrective maintenance of Nuclear Propulsion Plant systems must be carefully controlled. Maintaining accountability and certifying accuracy, operability, and reliability per the most current Field Changes and technical specifications is an essential element of reactor safety. The basic elements of the NTE program are certification and verification.

- a. Certification is the detailed technical evaluation of the equipment to conclude that the item conforms to the required specification. Certification is conducted prior to initial issue and after any event that invalidates the certification, such as repair, Field Change installation or a revision to the equipment reference drawing/figure and is recorded on a NTE Certification Record. Equipment will normally be maintained in a Ready for Issue, certified condition, requiring verification prior to each issue.
- b. Verification is the validation that the equipment is certified based on a review of records and is in a physically acceptable condition for issue and use. Verification is conducted prior to each issue and is recorded on a NTE Check-out/Check-in Form contained in Appendix A of this chapter.

7.2 NUCLEAR TEST EQUIPMENT CATEGORIES. For purposes of this chapter, NTE is divided into three categories.

- a. General Purpose Electronic Test Equipment.
- b. Electronic/Electrical Test Equipment, non-General Purpose Electronic Test Equipment (e.g., switchboard test equipment, scram breaker time response equipment, etc.).
- c. Mechanical Test Equipment.

7.3 ACTION. The Repair Officer shall implement the requirements of this chapter. The Nuclear Repair Officer is designated as the custodian of NTE and shall ensure that assigned personnel carry out the requirements of this chapter.

7.4 PROCUREMENT. Only test equipment meeting the specifications of the applicable RPM and reference (a) may be used to conduct testing on Nuclear Propulsion Plant Systems. Requisitions for new equipment shall contain sufficient detail to ensure the correct item is purchased. Allowance Equipage Lists for required NTE are provided in the tender Coordinated Shipboard Allowance List or Q-Coordinated Shipboard Allowance List. The requirements for General Purpose Electronic Test Equipment to support nuclear electrical/electronics testing are contained in the applicable Ship's Portable Electronic Test Equipment Requirements List.

7.5 NUCLEAR TEST EQUIPMENT CERTIFICATION. NTE shall be certified using a Formal Work Package (FWP) for Electronic/Electrical Test Equipment and a Controlled Work Package (CWP) for Mechanical Test Equipment. Certification is required for new equipment prior to initial issue and following repairs or modifications which could impact performance. Periodic recertification is not required. The FWP/CWP should be as simple as possible. As a minimum, the FWP/CWP shall provide the exact equipment reference and indicate the attributes that must be verified and the required testing. Recertification following repair shall be a step in the repair FWP/CWP. Certification shall be documented on NTE Certification Records and is discussed in detail in paragraph 7.5.4 of this chapter. Certification shall be accomplished per paragraph 7.5.1 or 7.5.2 of this chapter. The ultimate objective is to demonstrate that the NTE available for Nuclear Propulsion Plant application is technically correct.

7.5.1 Electronic/Electrical Test Equipment. The FWP shall require completing and retaining an NTE Certification Record.

- a. To certify new or existing measuring and recording equipment, such as a Visicorder or strip chart recorder, verify that the specifications given in the equipment technical manual match the specifications required by the applicable RPM, reference (a), or applicable test reference.
- b. To certify repaired or re-calibrated measuring and recording equipment, the repair and/or calibration activity shall certify that the item still conforms to the original technical specifications and is properly calibrated (as evidenced by a calibration sticker). The Fleet Maintenance Activity Work Center performing the repair/calibration shall complete the NTE Certification Record. If the repair/calibration was not performed by the Fleet Maintenance Activity, Nuclear Repair shall certify the equipment. Work orders for repair shall require conformance to referenced drawings and figures.
- c. To certify other existing electrical test equipment not previously certified, such as switch boxes, jumper boxes, cables, Under Voltage/Under Frequency test boxes, etc., each component and the wiring configuration shall be compared to the referenced drawing for correctness.
- d. To certify other new electrical test equipment verify the test equipment as correct with respect to what was ordered and the nameplate data or other markings compared to the equipment requirements of the RPM, reference (a), or referenced test procedure.

7.5.2 Mechanical Test Equipment.

- a. To certify existing or newly manufactured mechanical test equipment, the CWP that manufactures the test equipment shall include steps to verify that the material specifications and configuration match the equipment reference. The CWP shall also include all required testing.
- b. To certify purchased mechanical test equipment, the CWP shall include steps to verify the equipment as correct with respect to what was ordered, compare the equipment to the requirements of the RPM, reference (a) and or referenced test procedure and shall also specify any testing that may be required prior to use.

7.5.3 Recertification Following Reference Revision. To certify existing equipment after a revision to the equipment configuration reference, take the actions necessary for the NTE to conform to the revision and complete an NTE Certification Record for recertification. The FWP for Electronic/Electrical Test Equipment and a CWP for Mechanical Test Equipment used to accomplish the equipment changes will specify recertification. A new NTE Certification Record will be generated regardless of whether or not the equipment required modification. The new certification record will serve to update the applicable revision and will provide evidence that the NTE was in fact validated to the correct revision.

7.5.4 Certification Documentation. The FWP or CWP shall contain a NTE Certification Record. The minimum attributes are shown in Appendix B of this chapter.

- a. The Certification Record page (current and superseded) shall be retained by the Nuclear Repair Officer for the life of the equipment. This record shall be available for review by personnel checking out equipment.

- b. The active revision/advance change notice level of the reference to which the equipment was built shall be specific enough to allow verification of the effects of future reference revisions. For example, while the RPM or reference (a) may be at revision 480, a figure showing test equipment details may be revision 453. The reference should be stated as the exact figure number and 453 should be recorded as the revision level.
- c. Existing records that contain proper certification data are acceptable and need not be replaced.

7.6 ACCOUNTABILITY.

- a. Electrical and electronic test equipment shall be fitted with tamper resistant seals where unauthorized access to calibration settings or internal components may invalidate certification.
- b. Requests for test equipment are normally made using an OPNAV 4790/2L form and identifying the appropriate Master Job Catalog routine Job Sequence Number. The OPNAV 4790/2L form requesting the test equipment must be specific with respect to the fittings or other associated components required in addition to the specific piece of test equipment. For hydrostatic test equipment, sufficient information must be provided to complete the check list requirements of Chapter 9 of this volume.
- c. Equipment should be issued for a specified period and delinquent equipment recovered as soon as possible.
- d. Activities receiving NTE must be briefed that only the issuing activity is authorized to repair NTE and that tampering will invalidate certification.
- e. Equipment Check-out/Check-in Forms will, as a minimum, contain the attributes contained in Appendix A of this chapter.
- f. Verification that the equipment is in accordance with the current revision of the controlling reference shall be accomplished by:
 - (1) Review of the NTE Certification Record prepared in accordance with Section 7.5 of this chapter above to demonstrate that the item has been certified.
 - (2) Compare the revision level stated on the NTE Certification Record to the current revision of the reference.
- g. When equipment is returned, those items of the issue and receipt procedure necessary to determine the condition of the equipment shall be repeated. This will ensure that equipment requiring repair is identified in a timely manner. A check-in operational test need not be performed in every case, but would be appropriate if visible physical conditions indicate possible damage affecting operability.
- h. Prior to issue by the repair facility, mechanical NTE which is expected to be subjected to pressure greater than 10 pounds per square inch will be operationally pressure tested to the highest pressure expected during use in the propulsion plant. Individual gages are excluded provided they are issued as individual components without adapters or hoses (for normal installation in a system) and are properly calibrated.
- i. The activity requesting mechanical NTE will be specific when requesting NTE. The following data (at a minimum) will be specified as applicable:
 - (1) Maintenance for which the NTE is required.
 - (2) Gage range and required tolerance.
 - (3) Set-points of protective devices.
 - (4) Length of hose.
 - (5) Size and style of fittings for attachment to ships system (e.g., swagelock SS 1/8" inverted 37 Degrees SAE flare fitting).
 - (6) Maximum temperature the NTE is expected to be subjected to during use.
 - (7) Date required.

(8) Any special requirements.

7.6.1 Lost/Damaged Test Equipment. Lost/damaged test equipment must be repaired or replaced in a timely manner. Equipment requiring repair will be entered in the Equipment Deficiency Log, assigned a Job Sequence Number and entered in the Current Ship's Maintenance Project. Out-Of-Commission equipment that results in an inability to provide necessary test equipment for reactor plant testing shall be given high repair priority. Maintenance of NTE will only be accomplished by the issuing activity.

7.6.2 Cleanliness and Foreign Material Exclusion. Mechanical Test Equipment/Assemblies attached to Nuclear Propulsion Plant Systems must meet the requirements for cleanliness control and foreign material exclusion specified by reference (b). Verification of cleanliness will be incorporated into check-out/check-in forms and into FWP's and Technical Work Documents.

7.6.3 Stowage. NTE shall be stowed in a location segregated from non-NTE. Ready For Issue equipment will be stowed apart from non-Ready For Issue equipment. Segregated stowage shall be such that it precludes inadvertent mixing of equipment.

7.6.4 Inventory. NTE will be inventoried at least annually. A record of the most recent inventory will be retained by the Nuclear Repair Officer.

**APPENDIX A
NUCLEAR TEST EQUIPMENT
CHECK-OUT/CHECK-IN FORM**

Receiving Activity: _____ Date _____

Lending Activity: _____

1. **Equipment description and serial numbers.** Include all individual components. _____

2. Required return date:

ATTRIBUTE	CHECK-OUT			CHECK-IN		
	SAT	UNSAT	N/A	SAT	UNSAT	N/A
Physical condition of assembly/item						
Calibration current						
Tamper resistant seals intact						
Level of cleanliness is as required						
Operational test. Protective feature set point _____. For hydro rigs, complete Test Rig Determination and Inspection Check List (see Chapter 9 of this volume) and provide with hydro rig.						
Equipment previously certified. Review Certification Record Card						
Equipment verified correct to current revision/advance change notice of referenced drawing or manual.						

3. Equipment found to be unsatisfactory has been segregated from satisfactory equipment and repair request submitted.

CHECK-OUT
YES (☐)

CHECK-IN
YES (☐)

CHECK-OUT and CHECK-IN signatures on reverse.

CHECK-OUT

Prepared and Issued By:

Signature _____

Printed Name _____

Received By:

Signature _____

Printed Name _____

NOTE: RECEIPT SIGNATURE ACKNOWLEDGES THAT ONLY THE ISSUING ACTIVITY IS AUTHORIZED TO REPAIR NTE AND THAT TAMPERING WILL INVALIDATE CERTIFICATION. THIS SIGNATURE ALSO ACKNOWLEDGES THAT A REVIEW OF CERTIFICATION RECORDS CONFIRMS THAT THE EQUIPMENT CONFORMS TO THE REQUIRED TEST REFERENCE REQUIREMENTS.

CHECK-IN

Returned by:

Signature _____

Printed Name _____

Received by:

Signature _____

Printed Name _____

**APPENDIX B
NUCLEAR SUPPORT AND TEST EQUIPMENT
CERTIFICATION RECORD**

1. SHIP/ACTIVITY	2. FWP/CWP NUMBER	3. DATE CERTIFIED (CIRCLE ONE) INITIAL CERTIFICATION RECERTIFICATION
4. EQUIPMENT IDENTIFICATION		
5. EQUIPMENT CONFIGURATION REFERENCE, INCLUDING EXACT REVISION AND ACN TO WHICH THE EQUIPMENT WAS BUILT		
6. CERTIFICATION TEST(S)/CHECK(S) PERFORMED AND RESULTS (include certification method)		
7. REASON FOR RECERTIFICATION (not applicable to initial certification)		
8. CERTIFIED BY: _____ DATE: _____ SIGNATURE: _____ PRINTED NAME: _____	9. ACCEPTED BY NRO: _____ DATE: _____ SIGNATURE: _____ PRINTED NAME: _____	

(This Page Intentionally Left Blank)

VOLUME IV

CHAPTER 8

WEAPONS AND CARGO ELEVATOR ASSESSMENTS

8.1 PURPOSE. To provide guidance in the preparation for and execution of shipboard weapons and cargo elevator assessments and assist visits by the Elevator Support Unit (ESU).

8.1.1 Background. Shipboard weapons and cargo handling elevators are supported through the elevator assessment and repair program, which is executed by the ESU. The ESU program, formerly the Program to Assess and Repair Shipboard Elevators for the Atlantic Fleet, and Weapons Elevator Support Unit for the Pacific and Atlantic Fleets, provides direct fleet support for the maintenance and modernization of shipboard elevators. The program is executed by the ESU on a per ship cycle, as dictated by the individual ship's deployment and maintenance schedules. Although ESU scheduled milestones are based on the maintenance cycle, the primary focus of the program is to achieve peak system readiness at the time of deployment by evaluating and repairing elevators throughout the ship's cycle. Additionally, DDG-51 Class 5"/54 and 5"/62 Ammunition Strike Down Equipment, which are similar to elevators, are supported through the ESU program.

8.2 ELEVATOR SUPPORT UNIT. The Regional Maintenance Center ESU is composed of skilled technicians qualified in the operation, repair, testing and training of weapons and cargo elevator systems. The ESUs are responsible for periodic material assessments, repair, technical assistance, on board operator maintenance training, and verification of Integrated Logistics Support (ILS) elements under this program.

8.3 SHIP'S FORCE ASSESSMENT RESPONSIBILITIES.

- a. Ensure that the Current Ship's Maintenance Project (CSMP) is up to date.
- b. Ensure operators and maintenance personnel are available to assist the Assessment Team.
- c. Require operators and maintenance personnel to accompany the Assessment Team for on the job training to increase self-sufficiency.
- d. Prepare and submit an OPNAV 4790/2K for each deficiency not corrected prior to completion of the assessment. Provide a listing of Job Control Numbers to the ESU.

8.4 ELEVATOR SUPPORT UNIT EVOLUTIONS. The specific components of each ESU evolution are defined below. These evolutions are designed to ensure deficiencies are identified and repaired in a timely manner. Prior to commencement of any ESU evolution, a pre-brief will be conducted by the ESU representative and attended by the ship's Maintenance Manager and all applicable departmental representatives. The pre-brief will cover, but is not limited to, the following topics:

- a. Key evolution elements.
- b. Roles and responsibilities of:
 - (1) ESU technical personnel.
 - (2) Ship's Force personnel.
- c. Working relationship between ESU technical personnel and Ship's Force.
- d. Overall safety practices and precautions applicable to the evolution.

8.4.1 Material Condition Assessment Visit. A Material Condition Assessment visit will be used to determine a baseline and establish the scope of follow-on actions. This visit is accomplished once per Fleet Readiness Training Plan. The ESU uses assessment guidelines to determine the system's material condition, while ensuring the following is accomplished:

- a. The CSMP is validated to avoid redundancies during the assessment.
- b. The elevator system is assessed, repaired, groomed and operationally tested. The ESU will make every effort to correct all deficiencies prior to the end of the visit.
- c. On the Job Training (OJT) is conducted with Ship's Force to promote self-sufficiency.

- d. Working with the ship's cognizant Department(s) Maintenance Manager, and TYCOM coordinators, determine the preliminary level of effort required to correct the discrepancies.
- e. All discrepancies and corrected items have been documented in the ship's CSMP using the appropriate IT System.
- f. The Commanding Officer, or an officer designated by the Commanding Officer, is briefed on the elevator system material condition.
- g. A final report is issued to the ship, ISIC and TYCOM following the Material Condition Assessment visit. The report shall address the following:
 - (1) Safety of systems, including "safe to operate" conditions.
 - (2) Major discrepancies found during the visit.
 - (3) System Operability Test results.
 - (4) Training status of Ship's Force with respect to Personnel Qualification Standards (PQS) and practical elevator system maintenance and operation.
 - (5) Status of authorized, completed, and/or programmed Ship Alterations.
 - (6) Recommendations to the In-Service Engineering Agent for system changes.
 - (7) In-Service Engineering Agent.

8.4.2 Repair Visit. The Repair Visit is designed to correct discrepancies identified in the ship's CSMP that could not be repaired during the assessment visit.

- a. Conduct multiple visits, as receipt of material permits, to repair as-found conditions.
- b. Provide logistics assistance as necessary.
- c. Conduct OJT with Ship's Force.

8.4.3 In Process Review. This review will be conducted on a case-by-case basis, contingent on the scope of repairs programmed for the maintenance availability. When tasked, the ESU will review the elevator system work package prior to the start of an availability. During the availability the ESU will:

- a. Monitor the progress and Quality Assurance of the repair contractor, coordinating with Supervisor of Shipbuilding and industrial activity representatives, Naval Surface Warfare Center, Carderock Division, and TYCOM Maintenance Manager, as applicable.
- b. Provide technical and logistic support to Ship's Force.
- c. Monitor the CSMP status.
- d. Witness elevator tests, as tasked.

8.4.4 On-Board Maintenance Training. On-board maintenance training will be conducted at least once per Fleet Readiness Training Plan with each ship receiving training as a host ship or by having their personnel participate in training on another ship of the same class. It consists of operator and maintenance classroom instruction followed by hands-on training. The ship class on-board maintenance training documentation is tailored to be ship specific, giving the ship the most accurate and coherent training possible.

8.4.5 Integrated Logistics Support.

- a. A one-time ILS validation of elevator configuration, Allowance Parts Lists (APL), Coordinated Shipboard Allowance Lists (COSAL) and technical manuals will be conducted.
- b. Follow-on ILS visits will be accomplished at the TYCOM's request.

8.5 VISIT SCHEDULING. The ISIC will schedule all ESU visits through the TYCOM sponsored Quarterly Scheduling Conference. Visits shall not be authorized without prior approval by the cognizant TYCOM.

8.6 REPORTS. Before departing the ship, the ESU will debrief the Commanding Officer, or designated officer, on the material condition of the elevator system. The ESU shall provide the ISIC and TYCOM a report, outlining the results, not later than 30 days following the visit.

(This Page Intentionally Left Blank)

VOLUME IV
CHAPTER 9
SYSTEM TEST CHECK LIST

REFERENCES.

- (a) NAVSEA 0387-046-8000 - System Hydrostatic Test Requirements
- (b) NAVSEA S9086-RJ-STM-010 - NSTM Chapter 504 (Pressure, Temperature and Other Mechanical and Electromechanical Measuring Instruments)
- (c) NAVSEA S9505-AF-MMA-010 - Submarine Non-Nuclear Piping Systems Test Manual
- (d) NAVSEA S9086-RK-STM-010 - NSTM Chapter 505 (Piping Systems)

LISTING OF APPENDICES.

- A Nuclear Test Rig Determination and Inspection Check List
- B Non-Nuclear Test Rig Determination and Inspection Check List
- C Nuclear/Non-Nuclear Pre-Test Inspection Check List
- D Nuclear/Non-Nuclear Performance of Test Check List

9.1 **PURPOSE.** To provide standard check lists for the proper preparation for the conduct of and recovery from nuclear and non-nuclear tests. Appendices A through D of this chapter are applicable to installed ship systems, individual components and support equipment tested in conjunction with Formal Work Packages (FWP) and Technical Work Documents (TWD).

9.1.1 **Background.**

- a. Appendices A through D of this chapter are similar to a standard FWP that will require entries, prior to each use, to detail the specifics of the test to be performed. When TWDs are utilized, the locally developed FWP should direct execution of the check lists and need only direct other actions that are not included in the check lists. For example, since Forces Afloat rarely perform hydrostatic tests on hot systems, the check lists are prepared based on system temperatures less than 200 degrees F. In the event that a hydrostatic test is performed with temperatures greater than 200 degrees F, the locally developed FWP must contain additional requirements for the test from the referenced test manual.
- b. These lists are developed from references (a) through (d) and **are not inclusive of all requirements.** All applicable test references must be reviewed in preparation for the test to ensure no requirement or precaution is overlooked. Other references such as the Reactor Plant Manual (RPM), Propulsion Plant Manual, Steam Plant Manual, Steam and Electric Plant Manuals, Ship Systems Manuals, Ships Information Books, Test Pressure Drawings, component technical manuals, etc., provide additional guidance and requirements that shall be included in the locally developed FWP for the test.

9.2 **GENERAL INSTRUCTIONS.**

- a. Blank spaces are provided throughout the check lists so that requirements for the specific test to be performed may be added. These specifics shall be entered during FWP preparation.
- b. Portions that are not applicable shall be marked "N/A" prior to FWP approval.
- c. Multiple "Completed by" signature blanks are provided at the end of each check list since one individual may not be able to fully complete a particular check list. Additional signature blanks may be added if required.
- d. The Test Rig Determination and Inspection Check List, Appendices A and B of this chapter, shall be completed by the activity issuing the test equipment. It is the responsibility of both the issuing and receiving activity to ensure that the correct test gear is used. Local exceptions to gages specified in reference (b) Table 504-6-1 will be approved by an individual with a technical warrant. When gage exceptions are invoked, the approved exception shall be included with associated test form. This may be accomplished by requesting the correct test equipment, and the issuing activity completing the

check list and providing it with the test equipment for review. To satisfy the scope of this chapter, the activity requesting the test equipment must include in their request (OPNAV 4790/2L) the information necessary for the issuing activity to complete Item 1 of Appendices A or B of this chapter, as applicable.

- e. These check lists may also be used when a maximum operating pressure test is specified and an external pressure source is required to obtain this pressure. Installed system equipment shall be used whenever possible to perform operating pressure tests.
- f. Appendices B, C, and D of this chapter may contain classified information when filled in (i.e., the nuclear information or classified test pressures). It will be the responsibility of the requesting activity to ensure the proper classification is annotated on the document when applicable.

9.3 **RECORD RETENTION.** System Check Lists do not require retention after the test has been satisfactorily completed, documented in the FWP or TWD, and the FWP or TWD is closed. Additional reviews of testing information are provided as follows:

- a. For Ship's Force testing to recertify TWD work performed by the Fleet Maintenance Activity (FMA), the completed check lists, or copies shall be provided with the test documentation provided to the FMA. When the FMA Quality Assurance Officer accepts the completed retest, the check list may be discarded.
- b. For FMA shop testing of controlled work, the completed check lists, or copies, shall be provided with the test documentation required by the Controlled Work Package until the FMA Quality Assurance Officer or Quality Assurance Supervisor accepts the testing objective quality evidence. Once the tests are accepted, the check list may be discarded.

**APPENDIX A
NUCLEAR
TEST RIG DETERMINATION AND INSPECTION CHECK LIST**

References: (a) NAVSEA 0387-LP-046-8000 - System Hydrostatic Test Requirements

ITEM NO.	ATTRIBUTE	CHECK OFF or N/A
1. Complete the following based on the information provided by the requesting activity.		
a.	System/component to be tested	
b.	Test Pressure _____ Reference _____	
c.	Number of test gages required: Total _____ Primary _____ (per reference (a) Appendix D). Backup _____ Indicate zero if multiple primary gages are required, one of which will also serve as a backup or if an installed system gage will be used.	
d.	Level of cleanliness required	
e.	Planned method of over pressure protection (e.g., manual using installed system valve plus one automatic relief included with test rig, or other combination). Unless otherwise specified, the rig will be provided with one manual and one automatic relief.	
2. GAGES: Normally installed instrumentation may be used as backup pressure indication. If an installed gage is not available and the backup gage will be a temporary gage, then complete Items a-f for both primary and backup gages. Otherwise, a-f apply to primary gage(s) only.		
a.	Complete and attach reference (a), Exhibit F.1-2 for selection of test gages.	
b.	Reference (a), Exhibit F.1-2, Item 8 (maximum gage error at test pressure) must not exceed 2% of test pressure.	
c.	Nominal indicated test pressure shall be no less than 25% of the primary gage's range. Nominal indicated test pressure shall be no less than 10% of the backup gage's range, if the backup gage is a temporary gage.	
d.	The gage range shall be capable of indicating the manual over pressure protection pressure at no greater than 90% of full scale and the potential maximum overpressure at no greater than 98% of full scale.	
e.	Temporary gages shall be single scale analog gages or digital pressure instruments calibrated in psig.	
f.	RECORD GAGE DATA: Primary gage range _____ psi Cal due date _____ Ser Number _____ Backup gage range _____ psi Cal due date _____ Ser Number _____	

(CONFIDENTIAL When filled in)

ITEM NO.	ATTRIBUTE	CHECK OFF or N/A
g.	<p>Gages have been calibrated within the required periodicity.</p> <p>Circle applicable item:</p> <p>(1) Normal metrology requirements list calibration frequency (This is the frequency unless specified otherwise for the specific test).</p> <p>(2) Special frequency _____ Required by _____ (Indicate required frequency and reference).</p>	
3. OVERPRESSURE PROTECTION:		
a.	The manual release of pressure is the primary method of protection.	
b.	Automatic backup relief valve will be provided.	
c.	If the temporary relief valves provided are to be installed in the system, installation shall be such that it does not cause damage to the system or system components.	
d.	The over-capacity of relief valves should not cause excessive thermal and pressure shock. (Relief valve capacity should not be grossly higher than pressure source capacity).	
e.	The blow down characteristics shall be compatible with the system being tested. (The reseating characteristics of automatic reliefs should be consistent with the requirements of the system being tested. For example, a relief that does not reseat until pressure is reduced to zero would not be acceptable for a primary hydro). (Review manufacturer's data).	
f.	Valve accumulation at the flow of the test pressure source shall not exceed 10% of the relief valve set point.	
g.	Temporary automatic relief valves which have more than one inlet and therefore provide different relief valve performance characteristics (e.g., set pressure) shall not be used.	
h.	<p>Temporary automatic reliefs which require no tools for setpoint adjustment (e.g., employ hand adjustment knob) must:</p> <p>(1) Have some means to positively lock the setting once it has been made or</p> <p>(2) Must be designed to prevent ready access to the adjustment knob.</p>	
4. OVERPRESSURE PROTECTION SETPOINT DETERMINATION:		
a.	Record required hydrostatic test pressure _____ psi.	
b.	<p>Record required overpressure protection setpoint _____ psi.</p> <p>Circle applicable determination method:</p> <p>(1) As specified in the applicable RPM.</p> <p>(2) Other Naval Sea Systems Command (NAVSEA) approved document (identify reference).</p> <p>(3) Using Reference (a), Exhibit F.1-2 (attach).</p>	
c.	Potential maximum overpressure (Reference (a), Exhibit F.1-2, item 29) conforms to the requirements of reference (a) Section E.3.3.	

(CONFIDENTIAL When filled in)

ITEM NO.	ATTRIBUTE	CHECK OFF or N/A
5. TEMPORARY EQUIPMENT REQUIREMENTS:		
a.	Temporary connections and equipment (cap, spoolpieces, jumpers, blank flanges, etc.) shall be verified to be capable of withstanding hydrostatic test pressure.	
b.	Verify that within the last year and subsequent to disassembly or replacement of any test rig equipment, the assembled test rig (pump, hoses, gages, connecting tubing) has been satisfactorily tested to a pressure at least equal to the maximum pressure which might be encountered during this hydrostatic test. (Hydro is not required to test pressure gage and relief valve replacement or fittings between subassemblies designed to be broken for portability. Setpoint testing of the test rig relief valve while on the test rig meets this requirement).	
c.	Verify the rig has been cleaned to meet the system cleanliness requirements of the system being tested. If the rig is not maintained clean, comply with the cleanliness boundary requirements of reference (a), Section E.4.	
d.	No quick-disconnects with check features are to be used in the hydro rig.	
6. OPERATIONAL TEST:		
<p>INSTRUCTIONS: The following checks shall be performed with the test rig isolated from the system being tested. This may be done by blanking the hose prior to connecting the rig to the system. Equipment provided by an FMA will be tested at the FMA prior to being issued to a tended ship. The operational test need not be repeated by the tended ship receiving the test gear.</p>		
<p>NOTE: FOR SHOP TEST FACILITIES (I.E., INTERMEDIATE MAINTENANCE ACTIVITIES, NAVAL SHIPYARDS AND TENDERS) WHERE HYDROSTATIC TESTS ARE CONDUCTED AT LEAST ONCE EVERY TWO WEEKS AND WHERE THE TEST GAGES (BACKUP AND MASTER) ARE COVERED UNDER THE NAVY METROLOGY AND CALIBRATION (METCAL) SYSTEM, CROSS CHECKING THE GAGES BEFORE TEST IS NOT REQUIRED.</p>		
a.	Mark hydro gages with a red pointer at the required relief setpoint.	
b.	<p>Raise rig pressure to the specified test pressure. If the backup gage is included with the test rig, (vice an installed system gage) verify primary and backup gages are in agreement. (Maximum difference after height correction is no more than the sum of the specified accuracies plus a readability error of one half the smallest graduation of each gage).</p> <p>Required accuracy +/- _____ psig.</p> <p>If not in agreement, replace or re-calibrate and repeat this step until satisfied.</p>	
c.	<p>Record required overpressure protection setpoint _____ psig.</p> <p>Continue to raise pressure to the specified overpressure protection setpoint.</p> <p>If the manual relief is installed on the rig, with the pressure source operating at the specified manual relief setpoint, verify that the manual relief and associated piping relieve the capacity of the pressure source.</p>	
d.	<p>Set/confirm setpoint of the automatic relief valve.</p> <p>With the pressure source operating and at the relief setpoint, verify that the automatic relief and associated piping relieve the full capacity of the pressure source.</p>	
e.	Vent the rig to reduce pressure to reseal the automatic relief valve. Slowly raise pressure again to recheck the automatic relief setpoint.	

(CONFIDENTIAL When filled in)

ITEM NO.	ATTRIBUTE	CHECK OFF or N/A
f.	With the rig vented, verify that pressure gages that will be installed as primary or backup pressure indication, which are not equipped with a dial adjustment device read zero (within the gage accuracy plus the readability of one half of the smallest graduation on the dial face).	
g.	With the rig completely assembled, verify cleanliness by operating the pump to flush the pump and any attached piping or equipment.	
h.	Ensure cleanliness controls are established on the rig such that cleanliness is not lost in the interim period between flushing and the operational test and connection to the system being tested.	

Completed by _____ Items Completed _____ Date _____

Completed by _____ Items Completed _____ Date _____

Reviewed (Div Off/Engineering Duty Officer (EDO)) _____ Date _____

(CONFIDENTIAL When filled in)

APPENDIX B
NON-NUCLEAR
TEST RIG DETERMINATION AND INSPECTION CHECK LIST

- References:
- (a) NAVSEA S9086-RJ-STM-010 - NSTM Chapter 504 (Pressure, Temperature and Other Mechanical and Electromechanical Measuring Instruments)
 - (b) NAVSEA S9505-AF-MMA-010 - Piping Systems/Submarine Non-Nuclear Piping Systems Test Manual
 - (c) NAVSEA S9086-RK-STM-010 - NSTM Chapter 505 (Piping Systems)

ITEM NO.	ATTRIBUTE	CHECK OFF or N/A
1. Complete the following based on information provided by the requesting activity.		
a.	System/component to be tested.	
b.	Test Pressure _____ Reference _____	
c.	Number of test gages required: Total _____ Primary _____ Backup _____ Indicate zero if an installed system gage will be used.	
d.	Level of cleanliness required _____	
e.	Planned method of overpressure protection (e.g., manual using installed system valve plus one automatic relief included with test rig, or other combination). Unless otherwise specified, the rig will be provided with one manual and one automatic relief.	
2. GAGES:		
NOTE: TYPICAL GAGES FOR MOST NON-NUCLEAR TESTS ARE LISTED IN REFERENCE (a), TABLE 504-6-1.		
CAUTION: REFERENCE (a) TABLE 504-6-1 ALLOWS EXCEPTIONS TO THE GAGES LISTED IN THE TABLE. IF USING A GAGE NOT LISTED ON THE TABLE, IT MUST STILL COMPLY WITH THE CRITERIA SPECIFIED BELOW.		
a.	The pressure gage range based on the maximum test pressure up to and including the relief valve setting must be: - greater than the test pressure and - not more than 200% of the maximum test pressure.	
b.	For tests 0-60 psi and below, the range may exceed 200% of the test pressure but will be as low as practical.	
c.	Test gage pressure graduations are equal to or smaller than those specified by reference (a) Table 504-6-1.	

ITEM NO.	ATTRIBUTE	CHECK OFF or N/A
d.	Primary gage accuracy shall be at least +/- 1.0% of the gage span.	
e.	RECORD GAGE DATA: Primary gage range _____ psi Cal due date _____ Ser Number _____ Backup gage range _____ psi Cal due date _____ Ser Number _____	
f.	Gages have been calibrated within the required periodicity. Circle applicable item: (1) Normal metrology requirements list calibration frequency (This is the frequency unless specified otherwise for the specific test). (2) Special frequency _____ required by _____ (Indicate required frequency and applicable reference).	
3. OVERPRESSURE PROTECTION:		
a.	The manual release of pressure is the primary method of protection.	
b.	Backup relief valve, automatic or manual, will be provided. (Automatic preferred unless otherwise specified).	
c.	If the temporary relief valves provided are to be installed into the system, installation shall be such that it does not damage the system or system components. Review reference (b) or (c), as applicable.	
d.	The over-capacity of relief valves should not cause excessive thermal and pressure shock. (Relief valve capacity should not be grossly higher than pressure source capacity).	
e.	The blow down characteristics shall be compatible with the system being tested. (The reseating characteristics of automatic reliefs should be consistent with the requirements of the system being tested). (Review manufacturer's data).	
f.	Valve accumulation at the flow of the test pressure source shall not exceed 10% of the relief valve set point.	
g.	Temporary automatic relief valves which have more than one inlet and therefore provide different relief valve performance characteristics (e.g., set pressure) shall not be used.	
h.	Temporary automatic reliefs which have a rapid adjustment feature by which the setpoint may be inadvertently changed shall not be used.	
4. OVERPRESSURE PROTECTION SETPOINT DETERMINATION:		
a.	If performing a maximum operating pressure test, verify that installed system relief valves are unisolated and not blocked/gagged. The setpoint for the manual release of pressure shall be based on installed system relief setpoints.	
<p align="center">CAUTION: WHEN PERFORMING MAXIMUM OPERATING PRESSURE TESTS, INSTALLED RELIEF VALVES PROVIDE SYSTEM PROTECTION. SYSTEM RELIEF VALVES MUST NOT BE REMOVED FROM SERVICE.</p>		
b.	Record required hydrostatic test pressure _____ psi.	
c.	Record required overpressure protection setpoint _____ psi. Circle applicable determination method: the lesser of: (1) 100 psi over test pressure. (2) 10% above test pressure.	

ITEM NO.	ATTRIBUTE	CHECK OFF or N/A
5. TEMPORARY EQUIPMENT REQUIREMENTS:		
a.	Temporary connections and equipment (cap, spoolpieces, jumpers, blank flanges, hoses, etc.) shall be verified to be capable of withstanding the test pressure.	
b.	Verify that within the last year and subsequent to disassembly or replacement of any test rig equipment the assembled test rig has been satisfactorily tested to a pressure approximately 15% above the maximum pressure it will witness during the system hydrostatic test. (Hydro is not required to test pressure gage and relief valve replacement or fittings between subassemblies designed to be broken for portability. Setpoint testing of the test rig relief valve while on the test rig meets this requirement).	
c.	Verify the rig has been cleaned to meet the system cleanliness requirements of the system being tested.	
d.	No quick-disconnects with check features are to be used in the test rig.	
6. OPERATIONAL TEST:		
<p>INSTRUCTIONS: The following checks shall be performed with the test rig isolated from the system being tested. This may be done by blanking the hose prior to connecting the rig to the system. References (b) and (c) provide a sample step by step procedure for these checks. Equipment provided by an FMA or Industrial Activity shall be tested prior to being issued to a tended ship. If documentation is provided by the issuing FMA or Industrial Activity that the assembled test rig has been verified to meet all of the below requirements, the operational test need not be repeated by the end user.</p>		
<p>NOTE: FOR SHOP TEST FACILITIES (I.E., INTERMEDIATE MAINTENANCE ACTIVITIES, NAVAL SHIPYARDS AND TENDERS) WHERE HYDROSTATIC TESTS ARE CONDUCTED AT LEAST ONCE EVERY TWO WEEKS AND WHERE THE TEST GAGES (BACKUP AND MASTER) ARE COVERED UNDER THE NAVY METROLOGY AND CALIBRATION (METCAL) SYSTEM, CROSS CHECKING THE GAGES BEFORE TEST IS NOT REQUIRED.</p>		
a.	Mark hydro gages with a red pointer at the required relief setpoint, half way between the test pressure and the relief valve setpoint.	
b.	<p>Raise rig pressure to the specified test pressure. Verify primary and backup gages are in agreement. Maximum difference between the two gage readings after height correction is no more than 2%. Calculate 2% for each gage using the full scale pressure measured by each gage (i.e., a 0-100 psi gage, 2% = 2 psig, the maximum difference between two gages with a 0-100 psi scale at a given pressure is 2 psig).</p> <p>Required accuracy +/- _____ psig.</p> <p>If not in agreement, replace or re-calibrate and repeat this step until satisfied.</p>	
c.	<p>Continue to raise pressure to the specified overpressure protection setpoint.</p> <p>If the manual relief is installed on the rig (vice using an installed system valve), with the pressure source operating and at the specified manual relief setpoint, verify that the manual relief and associated piping relieve the capacity of the pressure source.</p>	

ITEM NO.	ATTRIBUTE	CHECK OFF or N/A
d.	Set/confirm setting of the automatic relief valve. With the pressure source operating and at the relief setpoint, verify that the automatic relief and associated piping relieve the capacity of the pressure source.	
e.	Vent the rig to reduce pressure to reseal the automatic relief. Slowly raise pressure again to recheck the automatic relief setpoint.	

Completed by _____ Items Completed _____ Date _____

Completed by _____ Items Completed _____ Date _____

Reviewed (Div Off/EDO) _____ Date _____

APPENDIX C
NUCLEAR/NON-NUCLEAR
PRE-TEST INSPECTION CHECK LIST

- References: (a) NAVSEA S9505-AF-MMA-010 - Piping Systems/Submarine Non-Nuclear Piping Systems Test Manual
 (b) NAVSEA 0387-LP-046-8000 - System Hydrostatic Test Requirements

ITEM NO.	ATTRIBUTE	CHECK OFF or N/A
1. REVIEW TEST PREPARATIONS: The following attributes are necessary for proper test accomplishment and may be included in the test procedure, indicated on the Quality Assurance (QA) form 26 or covered in the pre-test briefing.		
a.	Test equipment installation location and method of installation is clearly indicated in sketch on the QA form 26, or is clearly defined. Test accomplishment will be in accordance with reference (a).	
b.	Specific jumpers/gagging devices/blanks etc. are indicated for both installation and removal. These items shall be danger or caution tagged.	
c.	Boundaries of test and specific inspection points are clearly identified.	
d.	Instructions are provided for returning the system to normal or to a specifically stated condition upon completion of the test.	
e.	Procedure minimizes the amount of system to be pressurized to accomplish the test.	
f.	All components within the test boundary are capable of withstanding the test pressure (gages not over-ranged, etc.).	
g.	Necessary precautions as identified on the test pressure drawing have been taken (List or none). Use reverse if additional space required.	
h.	Applicable chapter (maintenance section) or maintenance instruction of the RPM reviewed for test/flush requirements (List or none). Use reverse if additional space required. (Not applicable to non-nuclear tests).	

ITEM NO.	ATTRIBUTE	CHECK OFF or N/A
i.	Specific actions/precautions taken are included in the test procedure as a result of a review of reference (b), sections 7.2.3, 7.2.4 and 7.2.5 to preclude damage to installed system components due to pressure or temperature conditions that may occur during the test (List or none). Use reverse if additional space required (Not applicable to non-nuclear tests).	
2. WALKTHROUGH OF THE TEST AREA: The below listed attributes are basic quality control checks that should be conducted/supervised by the Petty Officer in charge of the test.		
a.	Piping in the test boundary is free from dents, gouges, arc strikes and other external defects (Removal of additional lagging or other interference is not required to perform this check).	
b.	Conditions for detecting leaks are satisfactory (e.g., joints being tested are not covered/lagged).	
c.	Hot piping and/or equipment that could result in a safety hazard to personnel has been insulated or precautions have been taken to minimize the hazard.	
d.	The hydrostatic test will not be a hazard to other evolutions adjacent to the test area (e.g., Work on an open oxygen system adjacent to a seawater hydro).	
e.	Adequate measures have been taken to prevent spray damage to electrical equipment in the event of a leak during pressure testing.	
f.	Pipe hangers removed for work have been reinstalled.	
g.	All mechanical joints are re-made; system integrity established.	
h.	No obvious loose fasteners.	
i.	No obvious instances of missing fasteners or improper fastener material or material mismatch (e.g., no carbon steel fasteners in seawater systems, no improper use of black oxide coated fasteners).	

Completed by _____ Items Completed _____ Date _____

Completed by _____ Items Completed _____ Date _____

Reviewed (Div Off/EDO) _____ Date _____

APPENDIX D
NUCLEAR/NON-NUCLEAR
PERFORMANCE OF TEST CHECK LIST

NOTE: DO NOT PRESSURIZE TEST PUMP WITH AIR AND WATER SUPPLY UNTIL READY TO ACTUALLY START THE TEST. DO NOT LEAVE TEST PUMP UNATTENDED DURING ANY PORTION OF THE TEST.

ITEM NO.	ATTRIBUTE	CHECK OFF or N/A
1. VERIFY SYSTEM LINE-UP:		
a.	Verify the system to be tested is aligned for the test by performing valve lineup checks or by aligning valves via procedural steps in the test procedure or by steps in an operating instruction.	
b.	Verify that required plant conditions have been established.	
c.	All valves are DANGER TAGGED OPEN that: Could block either the primary or backup pressure relief point from the pressure source unless they are to be used during the test to isolate the pressure source from the portion of the system being tested. Could block discharge from the pressure relieving point. Could block either the primary or the back up pressure gage from the pressure source. (To ensure pressure indication, a clear pressure path between the applied pressure source and at least one pressure gage must be confirmed by danger tagging any isolation valve in this path. Confirmation that the other pressure gage is not isolated will be made by comparison with the tagged open gage). Would isolate the test pressure gages and the portion of the system being tested. Are vent paths in adjacent systems when the design or test pressure of the adjacent system is less than that of the system being tested.	
d.	If a section of pipe will be pressurized downstream of a check valve and no provisions are available for measuring the pressure in that section of piping, ensure that: (1) Pressure sources in that portion of the system are isolated or inoperative as discussed in item e below. (2) Provisions are included to manually depressurize any section of pipe isolated by a check valve as soon as possible after test completion.	
e.	Potential pressure sources within the test area boundaries that are not required for testing are isolated or rendered inoperative by danger tagging out fuses, danger tagging shut appropriate valves, etc.	
f.	There shall be no valves in the pressure-relieving path which could shut as a result of depressurization and thereby block the relief path from relieving the applied test pressure.	
g.	System relief valves within the test boundary are rendered inoperable to permit reaching elevated test pressure.	

ITEM NO.	ATTRIBUTE	CHECK OFF or N/A
h.	<p>Systems susceptible to chloride stress corrosion are isolated to protect in-leakage of chlorides from adjacent systems being tested to an elevated pressure. This isolation may be accomplished either by using double valve isolation with leakoff in between or by pressurizing the system susceptible to chloride stress corrosion to prevent in-leakage.</p> <p>If such isolation cannot be attained by practical means or is not assured, then the system susceptible to chloride stress corrosion shall be flushed outwardly before and after the elevated pressure test and appropriate samples taken to confirm the absence of contaminants.</p> <p>(Not applicable to non-nuclear tests).</p>	
i.	<p>Verify test equipment:</p> <p>(1) Installation is as specified on the QA form 26.</p> <p>(2) Test gages are within required calibration periodicity.</p> <p>(3) Automatic relief valves setpoint have been checked within 30 days prior to the test.</p>	
j.	<p>If test gages are provided with a dial adjustment which does not affect calibration, the dial should be adjusted to zero after the gage is installed for the test and prior to opening the valve that isolates the gage from the system being tested.</p>	
k.	<p>Verify calibration and dial adjustment devices, if readily accessible, are protected from inadvertent movement or adjustment during the test.</p>	
l.	<p>The discharge of test medium for overpressure protection is directed into areas where the discharge will not cause damage to equipment, create personnel hazards or radioactive problems.</p>	
m.	<p>Pressure gages shall be clearly visible and readable by test personnel.</p>	
n.	<p>The location of gages is such that no path exists whereby pressure could be applied to any portion of the system undergoing test without a pressure gage (primary or backup) indicating this pressure.</p>	
o.	<p>The primary and backup pressure gages shall be located on different branch lines (where this can be done without extending the test boundaries).</p>	

ITEM NO.	ATTRIBUTE	CHECK OFF or N/A
2. VERIFY PERSONNEL ARE READY TO CONDUCT TEST:		
a.	<p>Brief personnel, ensuring that the following attributes are understood:</p> <ul style="list-style-type: none"> (1) Personnel assignments. (2) Maintaining communications. (3) Test gage requirements: <ul style="list-style-type: none"> - Gage locations. - Calibration cross checks. - Gage indication and pressure readings. - Primary pressure indications. - Back up pressure indications. (4) Overpressure setpoint. (5) Type and location of primary overpressure protection. (6) Type and location of back up overpressure protection. (7) Duties of test pressure source operator. (8) Duties of system inspector(s) and required inspection points. (9) Duties of manual overpressure relief operators. (10) Immediate action shall be taken to secure the test pressure source and investigate the problem should any of the following occur: <ul style="list-style-type: none"> - Pressure gages fail to respond to changes in test pressure. - A rupture of a test gage occurs. - Pressure gage readings do not agree with the sums of their accuracies plus readability errors +/- _____ psig. - Changes in test pressures are erratic or operation of the test pumps after the system is filled solid does not produce a corresponding increase in pressure. (11) Immediate action shall be taken to secure the test pressure source and relieve system pressure if the pressure at which manual overpressure protection is to be initiated is exceeded on any primary or backup pressure gage. (12) Plant and system status. (13) Preliminary leak checks. (14) Valve packing leak checks (if applicable). (15) Criteria for an acceptable elevated pressure test. (16) Pressurizing to elevated test pressure. (17) Depressurization following completion of test. 	
b.	<p>Manual overpressure protection relief valve operators have no other responsibilities assigned.</p> <p>NOTE: WHEN PRESSURE IS BEING APPLIED BY A HAND-OPERATED TEST PUMP OR WHEN THE PRIMARY AND BACKUP TEST GAGES AND THE MANUAL OVERPRESSURE PROTECTION VALVE(S) ARE ALL INSTALLED ON THE HYDROSTATIC TEST RIG, THE TEST PUMP OPERATOR MAY ALSO SERVE AS THE PRIMARY OVERPRESSURE PROTECTION WATCH, PROVIDED THAT:</p> <ul style="list-style-type: none"> (1) THE MANUAL OVERPRESSURE PROTECTION VALVE IS WITHIN EASY REACH. (2) PROPERLY SET AND TESTED BACKUP RELIEF VALVE PROTECTION IS PROVIDED (FOR OTHER THAN HAND-OPERATED TEST PUMPS, EITHER AN AUDIBLE OVERPRESSURE ALARM IS PROVIDED OR A SECOND BACKUP RELIEF VALVE IS INSTALLED ON THE TEST RIG). (3) THE USE OF THIS EXCEPTION DOES NOT RESULT IN ONE INDIVIDUAL BEING SOLELY RESPONSIBLE FOR SATISFACTORY TEST PERFORMANCE. 	

ITEM NO.	ATTRIBUTE	CHECK OFF or N/A
c.	Adequate communications have been established between testing personnel.	
d.	Rate of pressurization and depressurization is specified at 100 psi/minute maximum. If testing a small component or small volume system such that 100 psi/minute is not practicable, control rate as low as possible.	
3. PERFORM ELEVATED PRESSURE TEST:		
a.	Obtain permission to conduct test.	
b.	Verify that the water purity of the test medium will not degrade system cleanliness or the required purity of water already in the system.	
c.	<p>Note depressurized gage readings of all primary gages for comparison later, at test completion.</p> <p>Location _____ ____ psig Location _____ ____ psig</p> <p>Mark all test gages with a red mark at the overpressure protection setpoint, half way between the test pressure and the relief valve setpoint.</p>	
d.	<p>Raise rig pressure to the specified test pressure. Verify primary and backup gages are in agreement. Maximum difference between the two gage readings after height correction is no more than 2%. Calculate 2% for each gage using the full scale pressure measured by each gage (i.e., a 0-100 psi gage, 2% = 2 psig, the maximum difference between two gages with a 0-100 psi scale at a given pressure is 2 psig).</p> <p>Required accuracy +/- _____ psig.</p> <p>If not in agreement, replace or re-calibrate and repeat this step until satisfied.</p>	
e.	If a less accurate gage is used for backup and is indicating higher than the primary gage during gage cross checks, increase the overpressure setpoint mark on the backup gage by the indication differential after the second cross check.	
f.	Increase pressure in increments and perform preliminary leak checks.	
g.	Unless required to be positioned differently (e.g., throttle valves), backseat all valves that were aligned for packing leak checks prior to increasing pressure above normal operating pressure.	
h.	Hold test pressure for 30 minutes prior to commencing final inspection unless otherwise specified.	
i.	Primary and backup gages are in agreement at test pressure. (Same criteria as above) +/- _____ psig.	
j.	Results of inspection _____. Also record data on QA form 26. Remarks:	
k.	<p>Slowly depressurize the test area at less than 100 psi/minute. If testing a small component or small volume system such that 100 psi/minute is not practicable, control rate as low as possible.</p> <p>For nuclear tests only:</p> <p>When depressurizing systems which are adjacent to systems potentially contaminated with chlorides, ensure that the potentially contaminated systems are depressurized before depressurizing the system susceptible to chloride stress corrosion to prevent in-leakage.</p> <p>Ensure that the depressurization path is selected such that any fluid flow produced by depressurization will tend to keep chlorides away from the system of concern.</p>	

ITEM NO.	ATTRIBUTE	CHECK OFF or N/A
l.	Note the depressurized gage readings of all primary gages. Location _____ _____ psig Location _____ _____ psig Compare to pre-test depressurized readings. Gages shall agree within the gage accuracy and readability error. Disagreement is not cause for rendering the elevated pressure test unsatisfactory, provided gage cross-checks in items d and i above are satisfactory. However, disagreement should be considered unusual and warrant further investigation.	
m.	Remove temporary equipment.	
n.	Perform system restoration as directed by the FWP.	

Completed by _____ Items Completed _____ Date _____

Completed by _____ Items Completed _____ Date _____

Reviewed (Div Off/EDO) _____ Date _____

(This Page Intentionally Left Blank)

VOLUME IV
CHAPTER 10

WORK AUTHORIZATION AND CONTROL

REFERENCES.

- (a) NAVSEA S9002-AK-CCM-010/6010 - Industrial Ship Safety Manual for Submarines
- (b) S0400-AD-URM-010/TUM - Tag-Out User's Manual
- (c) MIL-STD-1625 - Safety Certification Program for Drydocking Facilities and Shipbuilding Ways for U.S. Navy Ships
- (d) COMSUBFORINST 5400.38 - Standard Submarine Organization and Regulations Manual (SSBN)
- (e) COMSUBFORINST 5400.39 - Standard Submarine Organization and Regulations Manual (SSN)
- (f) COMSUBFORINST 5400.48 - Standard Submarine Organization and Regulations Manual (SSGN)
- (g) NAVSEA MS 6310-081-015 - Submarine Preservation
- (h) NAVSEA S9505-AF-MMA-010 - Submarine Non-Nuclear Piping Systems Test Manual
- (i) OPNAVINST 5100.19 - Navy Occupational Safety and Health (NAVOSH) Program Manual for Forces Afloat
- (j) OPNAVINST 5100.23 - Navy Occupational Safety and Health (NAVOSH) Program Manual
- (k) NAVSEA S9165-AC-HBK-010 - Submarine Sonar Dome Handbook
- (l) NAVSEA SE300-AZ-MMA-010 - Description, Operation and Maintenance SSN21 Class Sonar Bow Dome
- (m) NAVSEA SE300-MA-MMA-011 - Glass Reinforced Plastic (GRP) Bow Sonar Dome
- (n) COMSUBPACNOTE 9086 - COMSUBPAC Engineering Notes and Technical Notes

LISTING OF APPENDICES.

- A Work Authorization Form
- B Technical Work Document Record Sheet
- C Work Authorization Form Continuation and Revision Sheets
- D Barrier Criteria for Hull Penetrations
- E Safety of Ship Maintenance Item List Example
- F Safety of Ship Maintenance Item List
- G Procedures and Safety Precautions for Entering Submarine Spaces, Tanks and Voids
- H Close-out Inspection Check-off List

10.1 **PURPOSE.** To provide the procedures for authorization and control of shipboard work.

10.2 **WORK AUTHORIZATION.** Work on ship's systems and components, as defined in Volume I, Chapter 1, Appendix D of this manual, must be properly authorized and controlled in order to ensure rigorous personnel and ship safety standards are met at all times. All outside activity work on ship's systems and components, regardless of who performs the work, requires formal authorization through a Work Authorization Form (WAF) for the specific work to be accomplished. This applies to all U.S. Naval ships in all types of maintenance availabilities, public and private. The Work Authorization System and preparation of the WAF are discussed below. For the purpose of this chapter, the term "Repair Activity" is any activity other than Ship's Force involved in the construction, testing, inspection, repair, overhaul, refueling or maintenance of the ship.

10.3 **WORK AUTHORIZATION CONTROL.** Work on the Fleet's ships is conducted under positive Work Authorization Control in order to ensure rigorous personnel and ship safety standards are met at all times. The following considerations apply in meeting these standards:

- a. Work requiring formal authorization may include Planned Maintenance System (PMS), troubleshooting, corrective maintenance (repair) or alterations. It may also include removal of system components for repairs.

- b. As many ship systems, such as hydraulics and high-pressure air, are operationally interrelated, caution must be exercised in planning work so that other systems are not unintentionally disabled when setting work boundaries for the system to be worked.

10.4 WORK AUTHORIZATION SYSTEM. Work Authorization shall be controlled as follows:

- a. Designation of Work Requiring Formal Control. The WAF is the vehicle by which work requiring formal control is authorized for accomplishment and tracked to completion or otherwise no longer requiring isolation or authorization.
- b. A WAF, shown in Appendix A, is required to authorize the start of work on all ship systems and equipment by activities other than Ship's Force. Work includes all maintenance, repairs or modifications and installation or removal of temporary support systems and equipment. Repair activity non-intrusive work (e.g., painting, lagging, sheet metal work, deck plate, structural foundation) that does not affect ship or personnel safety does not normally require a WAF.
- c. For Ship's Force maintenance conducted in nuclear propulsion plants, the Engineering Department Manual contains the requirements regarding when a WAF is needed. For Ship's Force work conducted outside the nuclear propulsion plant, the cognizant department head shall determine the necessity for a WAF.
- d. For availabilities where a repair activity is assigned responsibilities for work authorization control by Memorandum of Agreement (MOA), the requirement regarding when Ship's Force must submit a WAF shall be specified in the MOA.

10.4.1 Administration. The following administrative process is to be used in executing Work Authorization Control:

10.4.1.1 Work Authorization Form. The WAF, shown in Appendix A, shall be filled out by the organization conducting the work, or Ship's Force, as determined by the MOA signed for the availability per Volume II, Part I, Chapters 3 and 4 of this manual.

10.4.1.2 Work Authorization Log. The Work Authorization Log(s) shall be maintained at the same location and administered by the same individuals as the ship's tagout logs or, when the repair activity is assigned responsibilities for work authorization control by MOA, the repair activity shall retain original WAFs with a copy of all WAFs (or as specified by local MOA) and the WAF index shall be provided to Ship's Force either by hard copy or electronically via a database that can be easily accessed by the Ship's Duty Officers.

NOTE: FOR SHIP'S FORCE GENERATED WAFS, THE SERIAL NUMBER SHALL USE THE SAME PREFIXES USED FOR THE TAGOUTS THAT SET THE SYSTEM ISOLATION FOR THE WORK. WHEN A REPAIR ACTIVITY IS ASSIGNED RESPONSIBILITIES FOR WORK AUTHORIZATION CONTROL, THAT ACTIVITY WILL SPECIFY THE SERIALIZATION PROCESS USED BY ALL ACTIVITIES INCLUDING SHIP'S FORCE FOR THE AVAILABILITY.

10.4.1.3 Technical Work Document Record Sheet. When the job description on the WAF covers multiple components and their associated Technical Work Documents (TWD), a TWD Record Sheet (Appendix B) in addition to the WAF may be used to document this work.

10.4.1.4 Work Authorization Form Continuation and Revision Sheets. If necessary, a WAF Continuation Sheet similar to the one shown in Appendix C may be used when information on the initial original WAF will not fit in the blocks provided in the WAF form in Appendix A. The WAF Continuation Sheet shown in Appendix C depicts the minimum blocks that must be filled out. Additional blocks may be utilized as deemed appropriate. Any changes necessary to the information on the WAF form after Block 14 is signed will be on the WAF Revision Sheet or changes to the existing WAF as described in paragraph 10.4.4 of this chapter. Existing WAF Continuation Sheets may be used until exhausted if desired. The WAF Revision Sheet, similar to the one shown in Appendix C, may be used to accomplish WAF revisions as permitted by paragraph 10.4.4 of this chapter. The WAF Revision Sheet shown in Appendix C depicts the minimum blocks that must be filled out. Additional blocks may be utilized as deemed appropriate.

10.4.1.5 Numbering Work Authorization Form Continuation and Revision Sheets. Revisions and continuation sheets generated by computer software may be numbered as determined by the software programming. Paper WAF continuation and revision sheets are to be numbered as follows:

- a. The WAF (Appendix A) will be identified as “Sheet 1”.
- b. Continuation sheets will be identified as “Sheet 1A, Sheet 1B”, etc.
- c. Revision sheets will be identified as “Sheet 2, Sheet 3”, etc.

10.4.2 Work Authorization Procedure. The following procedure is to be followed for properly authorizing work:

- a. The WAF is presented to the Watch/Duty Officer by the division/repair activity tasked with the work.
- b. (Submarines Only) For Safety of Ship items, as defined in paragraph 10.4.8 of this chapter and reference (a), the Watch/Duty Officer shall obtain the Commanding Officer’s permission prior to authorizing work. When assigned, the Repair Activity’s Ship Safety Officer signature is required.
- c. The Watch/Duty Officer will then determine if adequate isolation and plant/system conditions exist to safely and properly conduct the work including that the system is drained, deenergized and depressurized. The tagout is then established in accordance with reference (b). The work is not to be authorized if doubt exists on either of these points. For high energy systems (i.e., >200°F, >1000 psi) that could have the potential for trapped energies, the repair activity after consulting with Ship’s Force, may provide a written plan (i.e., valve lineup, procedure, marked up drawings) to Ship’s Force to ensure all parties are satisfied the system is properly drained and depressurized.
- d. When system isolation and plant conditions are satisfactory to conduct the work (e.g., tagout complete, system depressurized, drained and deenergized), the Watch/Duty Officer authorizes the work and signs the WAF. For repair activity generated WAFs, the Repair Activity Representative (RAR) also signs the WAF. The Watch/Duty Officer and RAR signature indicates that, based on personal observation, certified records or direct report from watchstanders or divisional personnel, that system isolation and plant/ship conditions are set and the division/repair activity is authorized to start work.

NOTE: ELECTRICAL SAFETY CHECKS (E.G., VOLTAGE CHECKS TO ENSURE CIRCUITS ARE DE-ENERGIZED) ARE PART OF THE WORK PROCESS, NOT PART OF THE TAGOUT PROCESS, AND THEREFORE SHOULD BE PERFORMED AFTER BLOCK 14 OF THE WAF IS SIGNED.

- e. Some component contractor personnel who perform work on ships are not knowledgeable of ship systems and are not qualified to determine if plant/ship conditions are satisfactory to conduct work. For such cases, the contractor’s signature will be based on a direct report or briefing they receive from Ship’s Force or the Lead Maintenance Activity (if assigned), unless another method of providing the information to the contractor is specified in a MOA. The contractor’s signature represents confirmation that the contractor understands the hazards presented by the ship’s systems on which he will be working, and that he/she has received assurances the work area has been appropriately isolated, depressurized, de-energized or drained. As an alternative, the contractor may specifically agree via their contract or MOA that all repair activity responsibilities as defined in this chapter will be assigned to a Lead Maintenance Activity per paragraph 10.4.5 of this chapter. In all cases, appropriate information should be provided to the contractor prior to initiating work to ensure the contractor understands the hazards involved.
- f. The original WAF is placed in the Work Authorization Log and a copy shall be maintained with the TWD until the work is completed.
- g. Once the work is completed, the WAF is signed by the repair activity as work complete and forwarded to Ship’s Force for clearing of Tagout Record Sheet line items in accordance with reference (b).
- h. Following completion of testing (if there is no formal test program) and setting of appropriate system status (e.g., clear tags and perform valve line-ups as appropriate for the situation), the WAF is signed as closed and forwarded to the cognizant department head for review.

10.4.3 Transfer of Non-Nuclear Systems and Nuclear Instrumentation and Control Systems (Depot availabilities only). During depot availabilities, large amounts of work will be performed on ship’s systems. Formal work control practices in place by a shipyard enable Ship’s Force to transfer non-nuclear systems and Nuclear Instrumentation and Control systems to the shipyard. Transfer of systems is the process by which Ship’s Force transfers the

authority to approve all actions within a system or portion of a system to a shipyard and subsequent return of systems back to Ship's Force prior to major events. Systems, or portions of systems, are transferred with or without transferring the ability to operate ship's equipment. By transferring a system or portion of a system to the shipyard, the shipyard is responsible for authorizing all work, testing and equipment operation within the boundary transferred. Transfer of systems does not diminish a Commanding Officer's overall responsibility for the safety of personnel, equipment and the ship. Although other activities may perform work within the boundaries and Ship's Force normally retains responsibility for operating ship's equipment, all actions (i.e., work, testing, equipment operations, etc.) within the boundary must be approved by the shipyard.

- a. The MOA between the shipyard and ship for the availability shall include the following minimum attributes regarding transfers:
 - (1) Clearly state that all actions performed within the boundary being transferred must be approved by the shipyard.
 - (2) Normally, Ship's Force retains responsibility for operating ship's equipment. If any transfers with operations are planned, the MOA shall define the extent to which the shipyard will operate ship's equipment within the boundaries.
 - (3) Normally, Ship's Force retains responsibility for PMS, unless otherwise specified in the MOA.
 - (4) Delineate who is responsible to maintain system status within the boundary.
 - (5) Identify the process (e.g., Joint Fleet Maintenance Manual Volume IV, Chapter 10, paragraphs 10.2 through 10.4.5) by which work control shall be administered, including interface between the shipyard, Ship's Force and other applicable activities.
- b. A WAF shall be used to transfer a system or portion of a system to the shipyard. Block 7 of the WAF shall clearly state this intent (i.e., specify "transfer" or "transfer including operations"). Ship's Force formally transfers a system or portion of a system to the shipyard by signing Block 14 of the WAF. Unless Block 7 of the WAF states the transfer is "including operations", the shipyard is not authorized to operate ship's equipment within the transferred boundary.
- c. The shipyard returns a system or portion of a system back to Ship's Force by completing all authorized work and testing specified on the WAF and signing Blocks 16, 17 and 18 of the WAF. Ship's Force indicates acceptance of the work and testing and, if applicable, operation by signing Block 18 of the WAF. For nuclear powered ships, the Engineering Department Manual contains requirements for accepting operational control from the shipyard.
- d. When the shipyard is responsible for operating ship's equipment as specified in the transfer MOA, operation of ship's equipment shall be in accordance with shipyard or Naval Sea Systems Command (NAVSEA) procedures (e.g., test procedures, ship's operating instructions, Steam and Electric Plant Manual, etc.).
- e. When waterborne, Ship's Force shall retain operation of hull and back-up valves.
- f. When portions of a system are required to be operational to support propulsion plant key events in accordance with NAVSEA Instruction 4730.1 and 4730.2 series, those portions of the system shall be transferred back to Ship's Force.
- g. Ship's Force shall have the capability to isolate the transferred area from components and systems under Ship's Force control. The valves, switches, breakers, fuses, blanks, etc., that provide this capability shall remain under Ship's Force control.
- h. Any ship system which could directly affect the reactor plant or conduct of reactor plant testing shall not be transferred to a shipyard until required nuclear temporary support systems are installed and the system is isolated from the reactor plant.
- i. Within the boundaries transferred to the shipyard, Ship's Force shall be notified prior to commencing testing and when testing is interrupted and completed.
- j. All transfers on submarines shall be consistent with ship's safety requirements and reference (a).

- k. In order to minimize subsequent changes to the WAF and ensure that Ship's Force is aware of the work scope, the WAF which transfers systems or portions of systems should include all known customer authorized work within the specified job description.
- l. This authority applies to all work performed by or sub-contracted by the shipyard.
- m. Within the boundaries approved by the WAF, the shipyard can add additional work to the WAF without Ship's Force approval by adding additional TWDs to a TWD Record Sheet (Appendix B) provided the additional work is within the original description of work and tagout boundaries (i.e., no additional tags are required). This method is applicable only when two independent reviews of the additional work by the shipyard confirms that the existing WAF and its associated tagout(s) provide adequate isolation and conditions for the work (see paragraph 10.4.5 of this chapter). TWDs (Task Group Instructions (TGI), Deficiency Logs, Deficiency Reports, etc.) that meet this criteria and require work control per paragraph 10.3 of this chapter will be added to the TWD Record Sheet. To ensure Ship's Force remains informed of all work being performed on ship's systems, the shipyard shall verbally notify Ship's Force at the time work is added to the TWD Record Sheet and subsequently provide a hard copy of the changed TWD Record Sheet if it cannot be printed by the Ship's Duty Officer from an electronic database. Work added to the TWD Record Sheet does not need to be added to the associated Tagout Record Sheet.
- n. When other activities perform work and testing within boundaries transferred to a shipyard and the shipyard is acting as their RAR, the shipyard may add the other repair activity's work to the TWD Record Sheet. Otherwise, a separate WAF shall be generated and a new line item shall be added to the existing Tagout Record Sheet.
- o. Ship's Force performing work, testing or equipment operations within boundaries transferred to a shipyard shall prepare a separate WAF processed as described in paragraph 10.4.2 of this chapter, add a new line item to the existing Tagout Record Sheet and obtain shipyard concurrence in Block 12 of the WAF. RAR signature is not required on the Tagout Record Sheet.
- p. For small depot availabilities (e.g., conventional surface ship availabilities less than six months in duration, submarine Selected Restricted Availabilities and Extended Refit Periods, Aircraft Carrier upkeep), the above provisions may be applied on a case basis where the amount of work on a system is extensive and warrants transferring a portion of a system. These exceptions require Type Commander approval.

10.4.4 Work Authorization Form Revisions. Changes to the scope of the existing job description or system transfer boundary shall be authorized by a formal revision to the existing WAF. Except as noted below for minor administrative changes, changes to conditions (i.e., Blocks 7, 8, 11, 13 and/or 14) established by an authorized WAF, including the associated tagout(s), also require a formal revision to the existing WAF. A formal revision to a WAF can be accomplished by either preparing a new WAF with the same number or revising the existing WAF.

- a. Prepare a new WAF. A new WAF with the same number will be used primarily for major changes to Block 7, Job Description or other major changes which warrant reverification of all aspects of the work authorization.
 - (1) A new WAF with the same number will be generated with changes included.
 - (2) In Block 9, enter revision (REV A, REV B, REV C, etc.) and reason for and description of the change.
 - (3) Authorize the new WAF in accordance with the requirements of this chapter.
 - (4) Mark superseded WAF(s) "SUPERSEDED" and retain with the new WAF.
- b. Revise Existing WAF. The revised existing WAF will be used primarily for tag shifts or other minor changes.
 - (1) Enter all required changes. Include initials, date and revision with each entry.
 - (2) Line-out all changed or invalidated information. Include initials, date and revision with each line-out.

- (3) Remake all affected signatures.
 - (4) In Block 9, enter reason for and description of the change. Sign and date the entry.
 - (5) Obtain authorization including verification of "Plant/Ship Conditions Set" by resigning Blocks 13 and 14 of the WAF.
- c. Revise existing WAF using the WAF Revision Sheet.
- (1) Fill in the information required by the WAF Revision Sheet, including the revision (REV A, REV B, REV C, etc.). Add additional blocks as deemed appropriate.
 - (2) Enter the reason for and description of the change. Sign and date the entry.
 - (3) Obtain all required signatures.
 - (4) Once the WAF Revision Sheet has been completed, it must be maintained with the original WAF in the WAF log.
- d. Minor Administrative Changes to Existing WAFs. The Watch/Duty Officer or the RAR may make pen and ink changes that are editorial and/or administrative in nature to the original WAF without processing a new or revised WAF. These changes must not affect the scope or sequence of shipboard work, and include items such as obvious typographical errors, erroneous job order numbers or spelling errors. Either the Watch/Duty Officer or Repair Activity may make these changes on the original WAF without resigning Blocks 13 and 14. The changes shall be initialed and dated by the person entering the changes.
- e. Iterative Tagouts. When using the reference (b) Iterative Tagout procedure, a revision to the WAF is not required provided the specific tests or maintenance evolutions are controlled by a formal process. This process is to be defined and concurred with by a MOA established between Ship's Force and the Lead Maintenance Activity. The process shall ensure that isolation is re-established and system conditions verified prior to recommencing work.

10.4.5 Centralized Work Control Procedures. It is the responsibility of the Lead Maintenance Activity to determine the need for centralized work control and to assign the responsibility for work authorization control. During depot availabilities, a centralized work control team will be established. For other availabilities, this decision is based on the number of repair activities performing work during the availability and the complexity of the work. When centralized work control procedures are invoked, the following process shall be used:

- a. Work by all repair activities is processed by the centralized work control team including work covered by paragraph 10.4.3 of this chapter. Ship's Force involvement will be defined by MOA.
- b. The Lead Maintenance Activity will specify participation and supervision of the centralized work control team by MOA. Ship's Force is an integral part of the centralized work control team and should man the team with experienced officers or senior petty officers.
- c. The repair activity performing the work shall prepare the WAF, sign as RAR on the Tagout Record Sheet and sign the WAF, Blocks 10, 14, 16 and 17 if applicable, unless specified otherwise by MOA (e.g., repair activity does not maintain qualified personnel). The Lead Maintenance Activity assigned responsibility for centralized work control is responsible for processing the WAF and signing all other repair activity blocks on the WAF.
- d. For work covered by paragraph 10.4.3 of this chapter, the Ship's Force member(s) of the centralized work control team would notify the responsible Division or Work Center Supervisor and Duty Officer of added work to a TWD Record Sheet to ensure that Ship's Force remains informed of all work being performed on ship's systems.

10.4.6 Equipment Tagout Procedures. Tagouts shall be accomplished in accordance with the requirements of reference (b).

10.4.7 Barrier Criteria.

- a. Barrier criteria for maintenance is located in reference (b) and applicable Reactor Plant and Steam and Electric Plant manuals.

NOTE: BARRIER CRITERIA REQUIRED BY REACTOR PLANT AND STEAM AND ELECTRIC PLANT MANUALS HAVE PRECEDENCE OVER REFERENCE (b) CRITERIA.

- b. (Submarines only) Specific guidance for hull penetrations is located in Appendix D.

10.4.8 Safety of Ship Maintenance Item Identification, Listing and Control (Submarines only).

- a. Safety of Ship Maintenance Item List (SOSMIL). Safety of Ship maintenance items are those evolutions having significant potential to impact the ship's watertight integrity, damage control capability or which require special attention to ensure ship safety.

NOTE: DESIGNATION OF SAFETY OF SHIP MAINTENANCE ITEMS FOR BOTH SHIP'S FORCE AND ANY OUTSIDE ORGANIZATION IS REQUIRED WHEN FLEET MAINTENANCE ACTIVITY (FMA), INDUSTRIAL ACTIVITIES AND CONTRACTOR PRODUCTION WORK IS IN PROGRESS. REQUIREMENTS OF PARAGRAPH 10.4.8 OF THIS CHAPTER OR A SHIP'S PLAN OF THE DAY, IF REFERENCE (a) IS IN EFFECT, WILL BE IMPLEMENTED ANY TIME WORK AFFECTING SAFETY OF SHIP ITEMS IS PERFORMED REGARDLESS OF AVAILABILITY STATUS.

- b. Safety of Ship Maintenance Items. The ship's Commanding Officer's permission is required prior to authorizing the maintenance evolution. The following, as a minimum, shall be scheduled on the SOSMIL:
- (1) All maintenance involving single closure isolation from sea.
 - (2) All maintenance which removes a means of blowing main ballast tanks.
 - (3) All maintenance requiring the use of flat patches, hull blanks or cofferdams, with specific entries identifying the actual installation and removal of these items.
 - (4) All maintenance which removes the capability to dewater the ship using either the trim or the main drain systems.
 - (5) All maintenance which removes the ship's installed firefighting capability (e.g., maintenance which prevents pressurization of the trim system).
 - (6) Bleeding or charging oxygen banks.
 - (7) Handling or loading of explosives or weapons.
 - (8) All maintenance which removes portions of, or the entire Emergency Air Breathing system.
 - (9) Fueling or defueling.
 - (10) Diver operations.
 - (11) Pumping or flooding the sonar dome.
 - (12) Battery charges.
 - (13) Nitrogen load.
 - (14) Refrigerant on/off load.
 - (15) Evolutions with an expected draft change of >3 inches (e.g., ballasting, lead load, etc.).
 - (16) Securing the Emergency Diesel Generator.
 - (17) Other maintenance or evolutions which require special coordination between Ship's Force and maintenance providers to ensure safe accomplishment of authorized work (e.g., Loading Vertical Launch System Platform).
 - (18) All maintenance that violates the integrity of the pressure hull, watertight bulkhead or watertight doors, excluding the routine operations of access hatches.
 - (19) All maintenance that disables any bilge alarm or any portion of an emergency announcing circuit when temporary alarms or indications are not installed.

- (20) All maintenance that secures normal or emergency lighting circuits in a compartment or space such that damage control response would be significantly impacted.

NOTE: USE OF TEMPORARY SYSTEMS TO REPLACE FUNCTIONS OF SHIP'S INSTALLED SYSTEMS SHOULD BE CONSIDERED WHEN DEEMED NECESSARY. CLASS SUBMARINE ORGANIZATION AND REGULATIONS MANUALS AND SHIP SYSTEM MANUALS MAY PROVIDE FURTHER GUIDANCE.

- c. **SOSMIL Preparation.** The SOSMIL will be prepared by a person designated by the ship's Commanding Officer using written input provided by Ship's Force divisions and the FMA representative. A new SOSMIL will be prepared prior to the FMA Daily Production Meeting of Volume II, Part I, Chapter 4, paragraph 4.4.11 of this manual. Appendix E of this chapter is provided as an example and depicts the minimum attributes that must be documented on the SOSMIL. Appendix F of this chapter may be reproduced locally for use. Prepare the SOSMIL as follows:
 - (1) Indicate ship's name, hull number, upkeep number, calculated maximum expected draft, actual morning draft and date prepared.
 - (2) For each job, list the Job Control Number/WAF number (as applicable) (operating instruction, PMS item, operating procedure), job description, scheduled end date and any remarks.
 - (3) The SOSMIL should indicate planned work for the next seven days. A thick black line shall be used on the left side of the current day to indicate the current days work.
 - (4) In the job description block, indicate in parentheses a number that corresponds to the list at the bottom of the sheet as to why the job requires a SOSMIL entry.
 - (5) Items shall remain listed on the SOSMIL until work has been verified complete and associated WAF has been completed or Block 11 of the WAF revised as no longer affects Safety of Ship.
- d. **Maximum Expected Draft.** For those items which will have an affect on ship's draft, expected draft changes greater than three (3) inches will be calculated fore and aft for that evolution and indicated in the remarks section. Draft calculations will be made by a Diving Officer of the Watch qualified individual. Additionally, for all ballasting evolutions, a second independent calculation will be performed and provided by a second Diving Officer of the Watch qualified individual. The worst-case draft change for each item will be totaled to arrive at a "maximum draft" and a maximum one foot buffer added to arrive at the "maximum expected draft". (The ship's Commanding Officer can decide to reduce the buffer as he desires. If Safety Draft Marks are in use, the bottom edge of the mark shall match the "maximum expected draft".) The "maximum expected draft" is listed at the top of the SOSMIL. Calculation sheets will be retained until the job is no longer carried on the SOSMIL. If the ship exceeds the "maximum expected draft", the Duty Officer will stop the evolution, place the ship in a safe condition and notify all parties who signed the SOSMIL and the ship's Commanding Officer.

NOTE: THIS SHALL IN NO WAY BE CONSTRUED AS LIMITING ACTIONS BY THE DUTY OFFICER OR NOTIFICATION OF THE SHIP'S COMMANDING OFFICER OF SMALLER DRAFT CHANGES. ANY UNEXPECTED DRAFT CHANGE SHOULD BE THOROUGHLY INVESTIGATED AND UNDERSTOOD.

- e. **Morning Actual Draft.** The actual ship's draft recorded each morning prior to the Daily Production Meeting. This draft will serve as a baseline value for draft changes that occur throughout the day.
- f. The Ship's Force Availability Coordinator will present the SOSMIL at the FMA daily production meeting for review and signatures. The SOSMIL will be signed by:
 - (1) Ship's Force (signed by a department head). Signature indicates that all evolutions that affect ballast have been identified, the form has been completed in accordance with this instruction and the correct drafts have been calculated and at least four feet of freeboard is available to all hull openings.
 - (2) Immediate Superior In Command (ISIC) (signed by an ISIC representative). Signature indicates that all maintenance has been identified, the form has been completed in accordance with this instruction and the draft measurements are noted.

- (3) Maintenance Organization (signed by appropriate senior level person of the repair activity, normally the Production Officer, as he leads the FMA Daily Production Meeting). Signature indicates all authorized Safety of Ship work items are listed. If any additional items are to be worked, a formal change to the SOSMIL will be required.
- g. Following review and signature, the Ship's Force Availability Coordinator will provide the original copy to the ship's Duty Officer. Reproduced copies for distribution shall be made from the "original document" only. Copies will be provided to:
- (1) Each Production Meeting attendee listed below:
 - (a) FMA Division Officers
 - (b) FMA Repair Duty Officer/Repair Duty Chief Petty Officer
 - (c) FMA Regional Maintenance Team Leader. He/she shall receive enough copies to make further distribution to the FMA Duty Officers and each FMA Division Officer having work listed on the SOSMIL.
 - (d) Supply Repair Other Vessel Officer
 - (e) Ship's Force Availability Coordinator
 - (f) ISIC Material/Squadron Representative
 - (g) FMA Availability Coordinator
 - (2) The ship's Engineering Duty Officer.
 - (3) The ship's Below Decks Watch.
 - (4) The ship's Petty Officer of the Deck.
 - (5) Naval Submarine Support Center Representative.
- h. SOSMIL Use and Pre-Job Briefs. None of the evolutions or maintenance specified in paragraph 10.4.8.b of this chapter shall commence unless it is scheduled on the current SOSMIL. The activity performing any maintenance or evolutions listed on the SOSMIL is responsible for a pre-job brief prior to commencing work. A pre-job brief is required for all items listed on the SOSMIL and will be attended by all parties involved as desired by the Ship's Duty Officer.

10.4.9 Ship in Dry Dock (Submarines Under Joint Fleet Maintenance Manual Controls).

- a. When the ship is in dry dock, Chapter 0872 of Navy Regulations requires the closing of all valves and other openings in the ship at the end of working hours when such closing is practical. In situations where there is extensive disruption of watertight integrity, making daily closing impracticable, it is prudent to protect the dry dock, rather than the ship, from inadvertent flooding. To this end, shipyards shall maintain dry docks in accordance with reference (c).
- b. Temporary fluid systems shall be considered a controlled constant fluid supply provided the following conditions exist:
 - (1) The temporary fluid supply contains two in-line isolation valves external to the ship between the source and the ship.
 - (2) The two isolation valves shall be located to facilitate rapid isolation (e.g., close to the ship).
 - (3) The temporary fluid system, including both off hull isolations, shall be formally transferred to, including operation of, Ship's Force.
 - (4) The supplied ship system shall be tested to the temporary system operating pressure.
- c. Dry dock simulated waterborne conditions exist when water is introduced to the dry dock and kept at a level below that necessary to lift the vessel off the blocks. During this condition the following minimum requirements shall apply:

- (1) The event shall be authorized on the SOSMIL, contained in section 10.4.8 of this chapter (Submarines only).
 - (2) Hull openings shall be maintained in accordance with reference (a).
 - (3) Seawater valves should normally be operated using ship's systems. A temporary system may be used to operate seawater valves after obtaining Commanding Officer's permission.
 - (4) Ship's dewatering capability meets the requirements of references (d) through (f).
- d. Dewatering capability. Each compartment shall be capable of being dewatered at a rate of at least 200 GPM with pumping started within three minutes of the flooding being called away. Ship's Force will demonstrate adequate dewatering capability by planning and scheduling flooding drills to be observed by the ISIC and Lead Maintenance Activity Representative at the following times:
- (1) Within seven days of docking and temporary systems being delivered.
 - (2) Just prior to undocking, normally within 30 days.

10.5 FINAL CERTIFICATION, CLOSE-OUT AND RE-ENTRY OF SUBMARINE SPACES, TANKS AND VOIDS.

10.5.1 Purpose. To establish procedures for the final certification, close-out and re-entry of submarine spaces, tanks and voids.

10.5.2 Discussion. Historically during space, tank or void close-out, a large number of diverse and inconspicuous items have been overlooked. These items have, at times, seriously degraded both material readiness and acoustic signature of submarines. This section establishes a procedure to ensure a thorough certification of all spaces prior to final close-out and provides a check-off list when re-entry is required. The check-off list/sheet is not all inclusive. Common sense and effective use of personnel experience and knowledge must be used to ensure complete and thorough inspections. Non-steel damping and acoustic restraining covers are not required to be painted. Accidental overspray is acceptable. Full paintout of damping restraining covers and acoustic tile covers is not the intent. If damping and acoustic tiles are painted they must be checked to ensure that the paint will not bridge the gap between the rubber and the restraining cover more than 75% over an area. Degradation of the performance of tiles is possible. A suggested way to repair the area is to score the gap between the restraining cover and the damping tile and between the acoustic tile covers and the rubber. Previously painted serviceable tiles may remain in service. Reference (g) allows paint on piping.

NOTE APPENDIX G MAY BE USED AS AN AID FOR ENTERING SUBMARINE SPACES, TANKS AND VOIDS.

10.5.3 Action.

- a. The Damage Control Assistant (DCA) is designated the coordinator for the close-out of all spaces. As such he is responsible for the following:
 - (1) Assigning responsible personnel to close-out or assist in closing out specific spaces, tanks and voids.
 - (2) Providing personnel designated to conduct tank, void, or space close-outs with a copy of Appendices G or H as applicable.
 - (3) Ensuring personnel performing close-outs are aware of their responsibilities and are adequately trained. He shall provide, by periodic notice, a list of personnel qualified to perform close-out inspections.
 - (4) Maintaining a folder for completed copies of Appendix H. This folder will serve as a space, tank and void close-out certification record. Only the most recent copies of these Appendices are required to be retained. This folder should also include an index of all spaces, tanks and voids applicable to close-out certification and their status.

- (5) Keeping the Commanding Officer and the Engineer Officer informed as to the status of close-outs and significant deficiencies noted.
- b. Personnel performing tank, void and space close-out or entry are responsible for:
 - (1) Obtaining a copy of Appendix G and Appendix H.
 - (2) Forwarding to the DCA completed copies of Appendix H.
- c. Responsibility for Re-Entry Controls (REC) and final certification is as follows:
 - (1) In cases where entry is required to be made for production work by both Ship's Force and FMA personnel, the FMA will be responsible for REC and Ship's Force will be responsible for final certification close-out.
 - (2) For cases where only FMA work is anticipated, the FMA will be responsible for REC and Ship's Force will be responsible for final certification close-out. For the cases in which only the maintenance activity has access (e.g., waterborne entry into mud tanks or ballast tanks by divers) the maintenance activity will be responsible for final certification close-out.
 - (3) For cases where only Ship's Force work is anticipated, Ship's Force will be responsible for REC and final certification close-out.

10.5.4 Applicability. All SSN and SSBN/SSGN Class submarines and FMAs.

(This Page Intentionally Left Blank)

INSTRUCTIONS FOR COMPLETING WORK AUTHORIZATION FORM

Block 1. USS: Enter name or the hull number.

Block 2. SYSTEM: Enter the system noun name, abbreviation or identification number.

Block 3. WAF NO.: Enter the WAF serial number.

Block 4. JSN: Enter the Job Sequence Number or job order.

Block 5. DIVISION/Lead Work Center (LWC)/REPAIR ACTIVITY (RA): Enter ship's Division, LWC or repair activity Point of Contact responsible for conducting the maintenance.

Block 6. TECHNICAL WORK DOCUMENT: Enter the TWD (e.g., Controlled Work Package (CWP)/Formal Work Package (FWP), Task Group Instruction (TGI)) number(s) or enter "see attached TWD Record Sheet". If a TWD Record Sheet is used, it shall be referenced in Block 6.

Block 7. JOB DESCRIPTION: Enter a description of work to be performed detailed enough for the Authorizing Officer and/or RAR to understand the scope of the work boundary and prepare/concur in the isolation established for this work. If necessary, use of an additional Continuation Sheet per Appendix C is authorized. Description of work can contain either a description of work boundaries or a description of components (see paragraph 10.4.3a of this chapter).

Block 8. POST WORK TESTING IS AS SPECIFIED: Check BELOW and identify test requirements when retest is not contained in a TWD or formal test program. Check FORMAL TEST PROGRAM if retesting will be tracked or completed in a program administered by the repair activity. If FORMAL TEST PROGRAM or NO TEST REQUIRED is checked, Block 17 is N/A.

Block 9. RESTRICTIONS/PRECAUTIONS/REMARKS (OPENING): Enter any restrictions or precautions associated with the work item. If any information is entered in this block, the person making the entry must enter name, organization and date. If necessary, use of an additional Continuation Sheet per Appendix C is authorized.

Block 10. DIVISION/REPAIR ACTIVITY READY TO COMMENCE WORK: Signature by Leading Petty Officer/Division Officer for Ship's Force work or repair activity indicates that sufficient prerequisites are met to commence isolation for production work.

NOTE: SHIPYARDS IMPLEMENTING SAFETY OF SHIP REQUIREMENTS FOR SURFACE FORCE SHIPS PER LOCAL MOAS MAY MODIFY AND USE BLOCK 11 TO DOCUMENT SHIP SAFETY DETERMINATIONS.

Block 11. SAFETY OF SHIP: For submarines, when required by paragraph 10.4.8 of this chapter and/or reference (a), check YES.

- (1) If the SPOD is used, the Repair Activity's Ships Safety Officer will sign concurrence.
- (2) If the SOSMIL is used, the qualified Watch/Duty Officer will verify that work is listed on the SOSMIL for that day and sign the block. **NON-SAFETY OF SHIP WORK CONTROLS.** Check NO. When safety of ship qualified RA or Ship's Force work control personnel process their respective WAFs, they may sign concurrence for non-safety of ship maintenance.

Block 12. CONCURRENCES: Concurrence signatures may be entered as necessary (e.g., nuclear/non-nuclear interface, assist work center(s), two cognizant department heads). The Authorizing Officer or RAR should define any needed concurrences by noting the concurring organization beneath the signature line in Block 12 and obtain the concurrences. Enter N/A if no concurrences are required.

Block 13. TAGOUT REQUIRED: If tagout is required, mark YES. When tagout is hung, enter tagout number(s) (Log Serial Number/Shift Operations Management System line item number) and Watch/Duty Officer will sign block. If no tagout is required, mark NO. Enter N/A in TAGOUT NO., and Watch/Duty Officer will sign block.

Block 14. PLANT/SHIP CONDITIONS (e.g., drained, de-pressurized, de-energized) SET, FMA/DIVISION/REPAIR ACTIVITY ARE AUTHORIZED TO START WORK: The Watch/Duty Officer signs in all cases for authorizing the start of all work. Note any restrictions and/or precautions in Block 9. If

Block 11 is checked YES, the Watch/Duty Officer shall ensure the work of the WAF is listed on the SOSMIL/Ship's Plan of the Day prior to authorization of the WAF. RAR signs for authorizing the start of work when the WAF is for repair activity work.

Block 15. RESTRICTIONS/PRECAUTIONS/REMARKS: Enter any general conditions (e.g., outstanding work) that may affect system restoration. If any information is entered in this block, the person making the entry must enter name, organization and date. If necessary, use of an additional Continuation Sheet per Appendix C is authorized.

Block 16. WORK IS COMPLETE: A signature by Ship's Force or the repair activity is entered when the work described in Block 7 is verified complete and tags may be cleared with any exceptions listed in Block 15.

Block 17. TESTING IS COMPLETE: A signature by the activity performing the retest is entered when testing of Block 8 is completed. Block 17 is marked N/A if Formal Test Program is in effect or no test required.

Block 18. WAF CLOSED OUT: When work specified in Block 7 and testing as specified in Block 8 is completed, including all exceptions listed in Block 15, repair activity signature is entered to indicate the WAF is closed out. Ship's Force signature indicates acceptance of the work and testing and that appropriate system status has been set (e.g., clear tags and perform valve lineups as appropriate for the situation). Block 18 may be signed prior to completion of testing covered by a formal test program. A copy of the closed out WAF shall be provided to Ship's Force if the repair activity is maintaining the original WAF.

(This Page Intentionally Left Blank)

TECHNICAL WORK DOCUMENT RECORD SHEET COMPLETION INSTRUCTIONS

NOTE: THE ACTIVITY USING THE TWD RECORD SHEET SHALL FILL IN ALL BLOCKS.

<u>BLOCK</u>	<u>INFORMATION REQUIRED</u>
SYSTEM/COMPONENT	Enter system or component.
WAF SERIAL NO.	Enter WAF serial number.
TWD LINE ITEM NO.	Enter next sequential number (1, 2, 3, etc.).
TWD (TGI, DEFICIENCY LOG, DEFICIENCY REPORT, CWP, FWP)	Enter TWD (e.g., TGI, Deficiency Log, Deficiency Report or other unique document identification.)
BRIEF DESCRIPTION	Enter brief description.
1 ST CHECK	Initials of 1 st person who reviews and ensures the line item is within the WAF work description and tagout boundaries. (NOTES 1 and 2)
2 ND CHECK AND AUTHORIZATION	Initials of 2 nd person (independent from 1 st) who reviews and ensures work is within the WAF work description, tagout boundaries, that the WAF is in an authorized status and authorizes the line item. (NOTES 1 and 2)
DATE AUTH	Date line item was authorized. (NOTE 1)
STATUS	
LINE ITEM BLOCK (C/T/X)	Status of line item.
(INI) & DATE	Initials and date of person that verifies a line item is complete, transferred to another WAF or canceled.
REMARKS	Write any pertinent information (may be left blank).

NOTE 1: 1st and 2nd checks of TWD Record Sheet will be based on a review of the issued TWD. All TWDs not reviewed (i.e., left blank) at time of WAF authorization are not authorized until reviews are completed.

NOTE 2: Activities which choose to use the TWD Record Sheet shall track and status only the TWDs approved and executed by their activity.

APPENDIX C
WORK AUTHORIZATION FORM CONTINUATION SHEET

1. USS	3. WAF NO.	REV

CHECK IF CONTINUED ON ANOTHER SHEET

Sheet _____

(This Page Intentionally Left Blank)

WORK AUTHORIZATION FORM REVISION SHEET

1. USS	3. WAF NO.	REV
9. RESTRICTIONS/PRECAUTIONS/REMARKS		
AUTHORIZATION TO WORK		
11. SAFETY OF SHIP (Submarine Only): <input type="checkbox"/> YES <input type="checkbox"/> NO RA SSO (if SPOD used) or QUALIFIED WATCH/DUTY OFFICER (if SOSMIL used) _____ DATE _____		
12. CONCURRENCES: _____ DATE _____ DATE _____ DATE _____		
13. TAGOUT REQUIRED: <input type="checkbox"/> YES <input type="checkbox"/> NO SYSTEM/COMPONENT IS LINED UP FOR WORK, A TAGOUT IS HUNG, VERIFIED AND SIGNED BY THE REPAIR ACTIVITY (IF REQUIRED) AND SHIP.		
	TAGOUT NO. _____	
	WATCH/DUTY OFFICER _____	DATE _____
14. PLANT/SHIP CONDITIONS (E.G., DRAINED, DE-PRESSURIZED, DE-ENERGIZED) SET. DIVISION/RA IS AUTHORIZED TO START WORK.		
	WATCH/DUTY OFFICER _____	DATE _____
	REPAIR ACTIVITY _____	DATE _____

CHECK IF CONTINUED ON ANOTHER SHEET

Sheet _____

(This Page Intentionally Left Blank)

APPENDIX D

BARRIER CRITERIA FOR HULL PENETRATIONS

1. SYSTEMS WHICH PENETRATE THE HULL. Commanding Officers will review tag-outs and work procedures for systems which penetrate the hull to the detail considered necessary for safety. Any required work or testing which violates the requirements below should not commence without prior specific approval of the Commanding Officer.

2. HULL PENETRATIONS BELOW THE WATERLINE. The principle of double closure applies to all hull penetrations except for those mechanical and electrical penetrations (such as the secondary propulsion motor shaft and cable penetrations) which are designed for single closure. Double closure is accomplished by using installed valves, blank flanges, outside closure plates or shaft seals. Positive control shall be exercised by Ship's Force to maintain closure through the use of danger tags and interlocks, gagging devices, chains, mechanical locks, hydraulic locks, blanks etc., until the work, including the required testing, on the associated system has been completed.

- a. Single closure can be used only with the specific permission of the Commanding Officer. If single closure is approved, the barrier must be verified by a satisfactory leak check of the single closure before opening the system for maintenance as follows:
 - (1) The system should be isolated using the single closure barrier.
 - (2) If the system has not been drained, open the closest system high-point vent to conduct a controlled leak check of the single closure.
 - (3) If the system has been drained, open the closest low-point drain to conduct a controlled leak check of the single closure.
- b. Prior to undocking:
 - (1) If undocking becomes necessary prior to completing all sea connected system maintenance and testing, obtain double closure through reassembly, then satisfactorily hydrostatic test all pressure boundary joints outboard of the backup valve seat and verify the integrity of the hull and backup valve seats by performing a hydrostatic seat leakage check of both valves.
 - (2) Where schedule, resources or other constraints prevent accomplishment of the above at the time of undocking, a blank flange(s) shall be installed, tested and identified external to the hull penetration to provide double closure. This condition shall be identified both internally and externally to prevent inadvertent removal. The installation of the blank flange shall be approved by the Commanding Officer. Removal of these blank flange(s) shall not commence until the required valve(s) and associated local Valve Position Indicator(s) have been reinstalled and tested to support removal of the blank and blank removal has been approved by the Commanding Officer.

3. HULL PENETRATIONS ABOVE THE WATERLINE. These penetrations/openings will also be protected by double closure or as follows:

NOTE: THE DETERMINATION OF LESS THAN OR GREATER THAN FOUR FEET FROM THE WATERLINE WILL BE DETERMINED BY A MEASUREMENT FROM THE LOWEST LIP OF OPENINGS IN A PENETRATION TO THE ACTUAL WATERLINE.

- a. Hull penetrations less than four feet above the waterline.
 - (1) Cofferdams shall be installed around all open hull access openings, including temporary hull cuts, which have less than four feet of freeboard at the opening. Cofferdams shall be constructed and tested in accordance with reference (a) to maintain watertight integrity to at least four feet above the waterline. A hull opening such as an electrical cable penetration need not have a cofferdam installed if it is adequately blanked or plugged while the system is under repair. Cofferdams will be designed to permit personnel access, temporary services and equipment shipping, as applicable, without violating the required watertight integrity. The

ship's topside freeflood structure may be used to achieve the four foot requirement, however, the opening must be controlled in the same manner as a cofferdam. Positive control to maintain closure through the use of danger tags, and gagging devices, mechanical locks and/or blanks must be exercised for all hull access openings not in an as-built condition. Removal or changes in status shall be approved by the Commanding Officer.

- (2) Other penetrations/openings which do not meet the above criteria or which cannot be isolated by some type of single closure will be attended at all times by personnel with access to equipment capable of securing flooding, should it ever occur. Exceptions require specific permission of the Commanding Officer. Single closure may be affected by any suitable temporary watertight closure.
- b. Hull penetrations greater than four feet above the waterline. Penetrations/openings not in their normal as-built condition are not required to be watertight but should be provided with protection against unwanted fluid entry.

4. INADVERTENT OPERATION OF HYDRAULIC ACTUATORS. For those conditions when the ship is waterborne with a hull and/or backup valve below the waterline installed but the associated inboard piping is not complete and the hull and/or backup valve hydraulic actuator lines are disconnected, the following guidance is provided for reconnecting the hydraulic actuators (which may cause valve movement):

- a. If an external blank flange is installed, any additional precautions should be determined by the Commanding Officer.
- b. If an external blank flange is not installed, then the hull and backup valves should be installed, hydrostatically tested and local valve position indication proven correct and reliable. Additional safety precautions such as not working the actuators for a particular hull/backup combination concurrently, shutting and danger tagging both valves at all times, isolating and danger tagging the hydraulic pressure source to the control valve for the specific actuator being worked and not pressurizing or operationally testing the actuators until the seawater system integrity has been reestablished, should be employed to provide the additional assurance required to preclude the need for an external blank.

5. INSTALLATION OF HULL FITTINGS/FLANGES. When maintenance is to be performed which requires a hull fitting/flange to be installed, the following actions will be taken:

- a. Ship's Force will identify the hull opening by noun name, docking plan number, frame number, side and distance off centerline and item number (as obtained from the ship's docking plan) and provide this information to the FMA.
- b. The FMA planning division will verify the data provided by Ship's Force and calculate the circumferential distance from the centerline.
- c. The FMA LWC will provide the verified data and the fitting/flange, including the required installation hardware, to the diving supervisor.
- d. Ship's Force shall mark the fitting location using a weighted and marked line, referenced from frame marks topside.
- e. The Ship's Duty Officer shall authorize the installation of the fitting/flange and coordinate the pre-brief for the installation evolution. As a minimum, the brief shall be attended by the Ship's Duty Officer, LWC Supervisor and Diving Supervisor. The mechanism for authorizing the hull blank installation shall be the Work Authorization Form (Appendix A), in accordance with this chapter.
- f. The divers, in conjunction with Ship's Force and the LWC Supervisor shall verify the location of the hull opening and weighted/weighted line prior to the divers entering the water.
- g. A diver accompanied by Ship's Force shall tap on the internal hull opening until the in-water diver acknowledges the location by returning the signal except where permanent markings identifiable by a diver uniquely identify a specific hull fitting/penetration (markings such as a fitting name or number welded as raised characters on/adjacent to the fitting/penetration).
- h. After installation, the hull fitting/flange location and installation shall be independently verified by a second diver.

- i. Divers, assisted by the LWC and Ship's Force, shall verify the hull fitting/flange integrity with a 100 psig air test.
- j. Divers and the LWC Supervisor shall mark the hull fitting/flange by attaching a tether from the fitting/flange to topside. At the topside attachment point the tether shall be labeled "Hull Fitting (Noun Name) Installed".
- k. Positive verification from inboard of the hull fitting/flange placement and integrity must be achieved for each installed fitting/flange prior to proceeding with any maintenance. The verification shall be accomplished using the method for testing a single closure described in paragraph 2.a of this Appendix. If either of the leak check methods of paragraphs 2.a.(2) or (3) of this Appendix are not possible, the Commanding Officer shall be notified and give specific permission for continuing/conducting the maintenance.
- l. If internal verification of hull fitting/flange integrity is not possible due to system configuration, the fasteners shall not be fully removed from the pressure boundary being disassembled until the system is fully drained and hull fitting/flange integrity has been verified.
- m. If a hull fitting/flange is left installed for system and/or at sea operations, the guidance of Volume V, Part I, Chapter 8 of this manual concerning Departure From Specification shall be followed.

6. **REMOVAL OF HULL FITTINGS/FLANGES.** Prior to removal, divers, in conjunction with Ship's Force, shall verify the label of the tether of the fitting/flange to be removed and check for the presence of danger or caution tags. The divers shall then follow the tether to the fitting/flange to ensure the removal of the correct fitting/flange.

7. **BULKHEAD VENTILATION VALVES.** Bulkhead ventilation valves shall either be operational and capable of being shut or made water tight with a blank. Bulkhead penetrations shall either be in their normal condition or be rendered watertight if unattended. Temporary closures are permitted.

8. **FABRICATION OF NON-NUCLEAR PIPING BLANKS.** For fabrication of non-nuclear piping blanks to be used during hydrostatic testing and maintenance on submarine piping systems, the following general guidelines apply:

- a. The material must be the identical type, level and pedigree required for the system application in accordance with reference (h) or as required by NAVSEA drawings.
- b. Blanks must be constructed such that the design sealing surface dimensions and fitup characteristics of the system are maintained.
- c. Dimensions of blanks will be in accordance with reference (h).
- d. Applicable hydrostatic strength and porosity testing will be performed as required by system test pressure drawings.
- e. All blanks shall be marked in accordance with reference (h). Maximum allowable pressure will be the hydrostatic test pressure (e.g. 6750 psi for a 4500 psi application, 4500 psi for a 3000 psi application, etc.). Additionally, mark piece with nominal operating pressure and material used. Ensure pressure markings are annotated "MAX" and "NOM" as appropriate.
- f. Blanks installed for maintenance or testing will be identified by a plain tag stating the purpose of the blank. This tag will be in addition to any danger tags used.

(This Page Intentionally Left Blank)

APPENDIX E

SAFETY OF SHIP MAINTENANCE ITEM LIST EXAMPLE

Ship name: USS Bigcity Hull #: SSN-799	Upkeep #: 802	Maximum expected draft: Fore: 32'0" aft: 34'6"	Actual Morning Draft: Fore: 32'0" aft: 32'0"	Date Wednesday prepared: 23 SEP 98
---	---------------	---	---	---------------------------------------

NOTE: THE MAXIMUM EXPECTED DRAFT SHALL IN NO WAY BE CONSTRUED AS LIMITING ACTIONS BY THE DUTY OFFICER OR NOTIFICATION OF THE SHIP'S CO OF SMALLER DRAFT CHANGES. ANY UNEXPECTED DRAFT CHANGE SHOULD BE THOROUGHLY INVESTIGATED AND UNDERSTOOD.

JCN/ WAF #	Job Description Reason on SOSMIL	Days work planned							Scheduled end date	Remarks
		28 Mon	29 Tue	23 Wed	24 Thurs	25 Fri	26 Sat	27 Sun		
EA01-2345/ WAF #	TD-101 repair (1,3)			testing	Remove flange				24SEP98	Restoration in progress
EM01-3456/ WAF #	Divers: inspect screw for fouling (2,10)			Brief 0830					23SEP98	
WQ01-1986/ WAF #	Inspect sonar dome/ (11)			Pump down dome, brief 0830					23SEP98	Draft change expected: 1' up fore 1.5' down aft
EA01-3509/ WAF #	TD-1 ball/seat repair (4,5)	Trim system restored					Stage temp firefighting	Testing	28SEP98	Valve worked in place; temporary firefighting capability staged
WK01-4568/ WAF #	Off-loading countermeasures (7)					Off-load			25SEP98	through weapons shipping hatch
EA01-3525/ WAF #	LP Blower MRC M-2, change oil on LP Blower (2)	Down for 1 hour at 1300							28SEP98	

The following items are Safety of Ship:

- | | | |
|---|---|---|
| 1. Single closure from sea | 8. EAB system maintenance | 15. Refrigerant on/off load |
| 2. MBT blow removed | 9. Fueling or defueling | 16. Evolutions with an expected draft change of >3 inches (e.g., ballasting, lead load, etc.) |
| 3. Belly bands, hull blanks, cofferdams | 10. Diver operations | 17. Securing the Emergency Diesel Generator |
| 4. Dewatering ability removed | 11. Pumping or flooding sonar dome | 18. Pressure hull watertight bulkhead/doors maintenance |
| 5. Firefighting capability removed | 12. Special coordination btwn S/F and FMA | 19. Bilge alarm/emergency announcing circuit maintenance |
| 6. Bleeding charging Oxygen banks | 13. Battery charges | 20. Normal/emergency lighting maintenance |
| 7. Weapons handling | 14. Nitrogen load | |

Review and approval (all parties must sign):

ISIC Rep:	FMA Rep:	Ship's Force DH:
-----------	----------	------------------

IV-10E-1

COMUSFLTFORCOMINST 4790.3 REV C CH-2

(This Page Intentionally Left Blank)

(This Page Intentionally Left Blank)

APPENDIX G**PROCEDURES AND SAFETY PRECAUTIONS FOR ENTERING
SUBMARINE SPACES, TANKS AND VOIDS**

NOTE: IN ADDITION TO THE PRECAUTIONS NOTED IN THE STEPS BELOW, SHIP'S FORCE SHALL COMPLY WITH SAFETY PRECAUTIONS IDENTIFIED IN REFERENCES (i) THROUGH (n).

1. Prior to entry into any free-flood area or main ballast tank, check with the Engineering Duty Officer to ensure radiological surveys have been conducted to determine the radiological controls, if required.
2. Verify REC requirements, if any.
3. Obtain permission from the Duty Officer prior to entering any tank.
4. Ensure atmosphere surveys have been completed and adequate ventilation is available prior to entering the tank.
5. Obtain the necessary tools and equipment (i.e., rubber mallet, explosion proof flashlight or drop light, hardhat, wrenches, screwdrivers, etc.) required to enter or close-out the space, tank or void.
6. Wear a hard hat when entering any Main Ballast Tank or free-flood area.
7. Use the buddy system with one man external to the tank or void at all times.
8. No smoking in any tanks or voids. Do not carry any naked lights or sparking electrical apparatus. Ensure all drop lights are inspected and approved by the Electrical Division.
9. While inside the tank, make maximum use of ladders and walkways provided. Do not step on valves and piping.
10. Ensure positive measures are taken to identify the access to the tank or void to be opened (ship's plans, two-man check, label plate identification).
11. Ensure all system penetrations to the tank or void are isolated and all sources of potential pressurization danger tagged out in accordance with reference (b), to include gravity drain funnels, and the tank or void is vented to the atmosphere.
12. Ensure the tank or void fasteners are loosened to permit breaking the gasket seal. Remove fasteners only after the seal has been broken.
13. Use lanyards on tools and tethered sealable parts pouches.
14. Prior to entering a tank or void, remove all unnecessary items from your person (i.e., combs, lighters, wallets, etc.).
15. Take an inventory of all tools and materials with which you entered the tank or void. Have a second person verify the inventory before and after each entry.
16. A rubber mallet should be used to investigate for sound shorts, rattles, etc.

(This Page Intentionally Left Blank)

APPENDIX H
CLOSE-OUT INSPECTION CHECK-OFF LIST

Name of tank, void or space _____

	DESCRIPTION	PETTY OFFICER/ OFFICER INITIAL
1.	PAINT	
	a. Painted items and structures are completely covered.	
	b. No cracking or bubbling.	
	c. No evidence of rust under paint.	
	d. Zincs, transducers and hydrophones are not painted.	
2.	FRAMEWORK AND FOUNDATIONS	
	a. Inspect space framing and shell welds for visual defects.	
	b. Ensure nuts are lock-tight type or lockwired and screw engagement allows for at least one thread protrusion.	
3.	PIPING	
	a. Inspect all pipes for visual weld or sil-brazed joint defects. Ensure pipe walls have not been cut by grinding, denting, or struck or burned by welding equipment.	
	b. Check pipe penetrations for properly installed sleeves and weld fillets.	
	c. Pipe hangers should:	
	- prevent vibration when pipe is struck with mallet.	
	- have studs and nuts painted.	
	- have proper insulation between pipe and hanger.	
	- have stud nuts lockwired/locking cabled or have self-locking nuts used as required.	
	d. If blanks have been installed and will remain in-place following a preliminary close-out inspection, ensure the configuration has been evaluated for impact on ship conditions, system operation and are properly tracked to ensure removal during the final close-out inspection.	
4.	TRANSDUCERS, HYDROPHONES, CABLES AND CABLE WAYS	
	a. Ensure all rubber elements are not gouged, cut, scraped or painted.	
	b. Ensure all sonar transducers and hydrophones and corresponding cables are installed in accordance with ship's plans.	
	c. Ensure only CRES banding and rubber channel insulation is used on cableways.	
	d. Ensure cableways and cable are properly supported.	
	e. Ensure electrical coamings are made and tight.	
	f. Ensure cable loop boxing covers (at hull fittings) are installed with appropriate plastic spacers such that vibration does not occur when struck with a mallet.	
	g. Ensure electrical hull penetrations are properly labeled.	
5.	BAFFLE PLATES AND SOUND DAMPENING TILES	
	a. Sound dampening tiles are the proper type in accordance with reference (k).	
	b. Tiles are not cut, gouged or loosely secured.	
	c. Baffle plates are properly bolted such that they are free from vibration when struck with a mallet.	
6.	MECHANISMS	
	a. Dynamic mechanisms are installed, hooked up, and unpainted, with no evidence of damage or scraping of components.	
	b. Tank level floats, if applicable, are free to operate and have no visual defects.	

	DESCRIPTION	PETTY OFFICER/ OFFICER INITIAL
	c. Grease lines, if applicable, are installed properly with mechanical fittings tight and no evidence of leakage.	
7.	VENTS AND DRAINS	
	a. Adequate draining exists from each bay.	
	b. Vents are clear of loose gear and rags.	
	c. Ensure that vents/drains have no installed blanks.	
8.	GALVANIC PROTECTION	
	a. Zincs are properly located and installed such that vibration does not occur when struck with a rubber mallet.	
	b. Mounting straps and bolts are painted.	
	c. Surfaces behind zincs are properly painted. Sacrificial anode surfaces shall not be painted. Sacrificial anode surfaces shall not have any coatings, sealants or fairing compounds added to the backside unless approved by NAVSEA. Painting of anode straps and hardware is recommended for all sacrificial anode applications. Coatings for zinc anode straps and hardware may be omitted due to galvanizing of the strap. Painting of aluminum anode straps and hardware is required for all alternate immersion applications (e.g., Main Ballast Tanks or bilges).	
9.	CLEANLINESS	
	a. Check space clear of loose gear and rags.	
	b. Check space clean and free of dirt.	
10.	COMPLETION	
	a. All interior inspection items are clear of any discrepancies.	
	b. Take an inventory of all tools and materials with which you entered the tank or void. Verify all items carried into the tank or void have been removed.	
	c. All personnel are clear of the tank or void.	
	d. Tank or void cover gasket and gasket seat areas are in acceptable condition.	
	e. Tank or void cover studs and nuts are torqued to the specified values required and the lock tabs are properly engaged or spot welded.	
	f. Inspect the exterior for incomplete work that would require a reinspection.	
	g. Ensure that all temporary services are removed from tank.	

Signature of Senior Enlisted Inspector

Date

Signature of Officer Inspector

Date

Reviewed by DCA

Date

VOLUME IV

CHAPTER 11

TECHNICAL DATA AND INFORMATION MANAGEMENT

REFERENCES.

- (a) TL130-A1-HBK-010 MSC Procedures Manual - Maintenance Support Center Library Procedures Manual
- (b) COMNAVAIRFORINST 4700.23 - Aircraft Carrier Maintenance Support Centers (MSC) Policy and Procedures
- (c) NAVSUP P2003 - Navy Stock List of Forms and Publications
- (d) SECNAVINST 5510.36 - Department of the Navy Information Security Program Regulation
- (e) NAVSEA S8800-00-GIP-000 - NAVSEA Guidance Handbook for Intermediate Maintenance Activity Technical Library Personnel
- (f) NAVSEA S0005-AG-GYD-010 - Technical Manual Users Quick Reference Guide
- (g) SECNAVINST 5510.30 - Department of the Navy Personnel Security Program
- (h) NAVSEA SL720-AA-MAN-030 - Navy Modernization Program
- (i) NAVSEA S9040-AC-IDX-010 - Ships 3-M Reference Information CD
- (j) NAVAIR 00-25-100 - Naval Air System Command Technical Manual Program
- (k) NAVSEAINST 4160.3 - Technical Manual Management Program
- (l) NAVSEA S0005-AA-PRO-010/TMMP - NAVSEA Technical Manual Management Program Operations and Life Cycle Support Procedures
- (m) NAVSEAINST 9210.29 - Nuclear Powered Ships and Prototypes - Responsibilities of Holders of Reactor Plant and Related Manuals
- (n) NAVSEA S9086-CV-STM-010 - Naval Ship's Technical Manual Chapter 086 Command Technical Manual Management

11.1 PURPOSE. This chapter defines the responsibilities with respect to the management of technical documentation and data and requires the establishment and operation of technical libraries. Unless otherwise noted, Aircraft Carriers are governed by references (a) and (b).

11.1.1 Discussion. Technical data and information are critical for the proper operation, maintenance, troubleshooting and repair of all plant equipment. Improper maintenance or equipment remaining not repaired and inoperative can result from a lack of proper documentation in the form of technical manuals, ship's drawings and blueprints, Military Specifications and standards, etc.

11.2 SHIPBOARD TECHNICAL DOCUMENT MANAGEMENT. Ships shall maintain the Advanced Technical Information Support (ATIS) System up to date. ATIS updates are mailed out to the ship on Compact Disks (CD/DVD). An additional system available for use is the Technical Data Knowledge Management (TDKM) system. Ship technical document distribution is based on configuration and therefore relies upon the Configuration Data Managers Database - Open Architecture being maintained up to date to accurately assign documents to the ship. To ensure ships maintain up to date technical documents, the following requirements shall be met:

- a. The ship shall assign a senior Petty Officer (E-6 or above) as the Technical Librarian who will maintain the ATIS and TDKM systems up to date under the supervision of the 3M Systems Coordinator. Assignments as a Technical Librarian should be for a minimum of 12 months. Technical Librarians on Aircraft Carriers are assigned for 18 months in accordance with reference (b). For Aircraft Carriers, the point of contact is the Maintenance Support Center (MSC) Officer and the Maintenance Officer. At Submarine Fleet Maintenance Activities (FMA), ashore and afloat, the Technical Librarian will work under the supervision of the Planning and Estimating Officer for ATIS, TDKM and other databases maintained for FMA use.
- b. The Technical Librarian shall promptly apply ATIS changes within one week of being received on board.

- c. If TDKM is activated, the Technical Librarian shall synchronize and index TDKM once per week and report completion with received changes to the 3M Systems Coordinator. For Aircraft Carriers the point of contact is the MSC Officer and the Maintenance Officer.
- d. 3M System Coordinator shall report completion of ATIS and/or TDKM updates to the Executive Officer. For Aircraft Carriers the point of contact is the MSC Officer and the Maintenance Officer.

11.3 TECHNICAL LIBRARIES. Technical Library personnel maintain a complete master technical library including electronic or hard copies of technical manuals, drawing/aperture cards, Coordinated Shipboard Allowance Lists, provisioning Allowance Parts Lists (APL), computerized databases and any other technical documents or aids which support maintenance functions. The appropriate IT system computer programs will be used to maintain the library. In general, the technical library serves the following basic functions:

- a. Acquisition of new documents and data and the updating of existing materials.
- b. Cataloging, indexing and filing all documents, data and information materials to allow for effective use of library technical information.
- c. Accountability and control to ensure continuous integrity of the library collection and to enhance periodic inventories.
- d. Central control point for all technical documents received, held, used, transferred or disposed of by the repair department (FMA only) or command. For FMAs having a Nuclear Support Facility (NSF), all Naval Sea Systems Command Nuclear Propulsion Directorate (NAVSEA 08) controlled documents shall be controlled by the NSF. For MSCs aboard aircraft carriers, all NAVSEA 08 controlled documents shall be controlled by the Reactor Department Technical Publication Library. All aircraft maintenance related documents shall be controlled by the Aircraft Intermediate Maintenance Department.
- e. Maintain access to the following computer networks/websites whenever possible.
 - (1) Technical Data Management Information System (TDMIS).
<https://mercury.tdmis.navy.mil/default.cfm>
 - (2) Military Engineering Drawing Asset Locator System.
<https://www.dlis.dla.mil/medals>
 - (3) Naval Surface Forces, Atlantic Planning and Execution of Alterations and Repair (FMA and COMNAVSURFLANT and COMNAVSURFPAC commands only)
<https://www.spear.navy.mil> click on SPEAR info.
 - (4) Maintenance and Modernization IT Systems.
 - (5) **TMDER/ACN Report Tool**.
<https://mercury.tdmis.navy.mil>
 - (6) ASSIST Quick Search <http://quicksearch.dla.mil>

11.3.1 Technical Library Supervisor. The Technical Library Supervisor is responsible for keeping current plans, prints, specifications, manuals and all other technical documents and information needed by ship and FMA departments and for managing the daily operation of the library. The Technical Library Supervisor shall:

- a. Have a sufficient understanding of technical library organization requirements in references (a) through (n) (as applicable) to supply the necessary technical information.
- b. Have a **minimum** security clearance equal to the highest security classification of any document held within the library.
- c. Supervise personnel assigned to library.
- d. Operate the technical library in the following manner:

- (1) Schedule and carry out a frequent and recurring on the job training program for all personnel assigned to the technical library staff or to satellite librarian positions. As a minimum, training shall include topics that provide guidance for performing each library or satellite library function. Satellite librarian training may be tailored to cover only those areas applicable to satellite libraries. Lesson plans shall be developed for each topic.
- (2) Maintain and provide applicable and current plans, prints, specification, manuals and all other technical documents and information needed by the cognizant department. FMAs will also provide technical documents to tended units, other FMAs, non-FMA government activities or qualified Department of Defense contractor personnel.
- (3) Maintain an inventory of technical publications/manuals and manufacturer instruction books and other technical/repair documents available in the technical library and/or any satellite libraries (Work Centers/division offices, etc.).
- (4) Develop a system for checking out/in and recall of library technical publications issued to individuals in order to maintain the integrity of the library and ensure revisions/changes are made as received and also to minimize lost materials due to unaccountability. The system should include a recall capability that would allow for the location and recall/reissue of materials after 90 days. FMAs issuing technical publications/documents to tended units should establish a 90-day or end of fleet maintenance availability recall whichever comes first.
- (5) Requisition technical documentation needed for maintenance and repair procedures but not already available on board. Maintain a separate file of material on order. Track the status of requisitioned documents until received. Initiate follow-up action for those documents where supply status has not been received for a 30-day period, unless previous supply status indicates no follow-up is required.
- (6) Ensure proper security for the contents of the technical library.
- (7) Exercise positive control over access to the Library Management or TDMIS database functions using locally generated procedures.
- (8) Maintain written procedures which describe how to perform each function carried out by the technical library (i.e., check-out/check-in of technical documents, updating library document files, operating reproduction equipment, performing updates, requisitioning, inventories and audits of library documents, etc.).
- (9) Ensure maintenance calls/contracts are made for all viewing, reproduction, computer and powered document retrieval systems/equipment used to carry out library functions. The program shall include devices associated with this equipment.
- (10) Perform an inventory of technical publications/manuals and manufacturer's instruction books.
 - (a) Ships are to perform an annual inventory of technical publications/manuals and manufacturer's instruction books and other maintenance/repair documents available in the technical library and satellite libraries (work center/division offices).
 - (b) Shore facilities and submarine tenders are to perform an inventory of technical publications/manuals and manufacturer's instruction books and other maintenance/repair documents available in the technical library and satellite libraries (work center/division offices) every 12 months.
- (11) Ensure manuals within library's inventory contain applicable Advance Change Notices (ACN), or Interim Rapid Action Changes (IRAC). Verify each manual against the ACN report available from Naval Systems Data Support Activity (NSDSA), Port Hueneme, CA, and the NATEC IRAC Tracker Report.
- (12) Perform an annual data verification (configuration audit) of technical manuals and other repair documents available in the technical library and satellite libraries. Afloat libraries should perform verifications as often as operational constraints permit, within 6 months of major deployments, is recommended if verifications are not conducted annually.

- (a) Verify each NAVSEA/Space and Naval Warfare Systems Command technical manual held with the data listed in TDMIS using LMD for manual or automated verification. Verify Naval Supply Systems Command (NAVSUP) manuals with the modem Internet access.
 - (b) Verify NAVSUP manuals against reference (c) (i.e., NAVSUP 600 CD) or by performing a process verification file with LMD/TDMIS.
 - (c) Compare each technical manual held with the ACN Report provided from NSDSA, Port Hueneme, CA. This should be performed monthly.
 - (d) Compare each technical manual held with TDMIS (Index of Technical Publications) to ensure library is receiving the technical manual automatically.
 - (e) Compare each technical manual held with the Technical Manual Deficiency Evaluation Report file to make sure information received from Technical Manual Deficiency Evaluation Report submissions is reflected in applicable technical manuals.
 - (f) Make sure each technical manual is in good material condition (i.e., does not have loose or unrepaired torn pages, is readable and has an outside cover).
 - (g) For Naval Air Systems Command manuals, submit an Automatic Distribution Requirements List annually to NATEC to update distribution and verify manuals in accordance with reference (a).
- (13) Keep a record of annual inventories for 24 months. The annual inventories should include an assessment of recorded deficiencies in the technical data management program to determine areas that require improvement.
 - (14) Establish procedures to incorporate changes/revisions to technical documents held within library or satellite libraries as soon as practical after receipt. Updates involving the safety of personnel or equipment (ACNs) shall be entered within 48 hours of receipt. Routine changes shall be installed before publication use or within 30 days of receipt, whichever occurs first.
 - (15) Establish procedures that assure positive control of all technical documents held by the library. If Process Instructions or documents listed in ASSIST Quick Search <http://quicksearch.dla.mil> or any alteration text documents are held in Satellite library inventories, verify that these documents are up-to-date at least semiannually.
 - (16) Establish procedures for issuing technical documents to Department of Defense contractor personnel using guidance provided in references (d) (FMA only).
 - (17) Be the department point-of-contact for the Integrated Logistics Overhaul team with respect to technical documentation.
 - (18) Ensure all superseded technical documentation is removed and disposed of in accordance with local procedures.

11.3.1.1 Technical Library Non-Supervisory Personnel. The Technical Library non-supervisory personnel will carry out the daily operations of the technical library as directed by the Technical Library Supervisor. The Technical Library non-supervisory personnel shall:

- a. Be a reliable and motivated petty officer (E5 or above for FMA/MSC or full time civilian equivalent).
- b. Military should be assigned for at least 12 months. On Aircraft Carriers they are assigned for 18 months in accordance with reference (b).
- c. Personnel assigned as satellite librarians will be reliable and motivated petty officers appointed in writing and assigned for at least 9 months. Satellite librarians will have a **minimum** security clearance equal to the highest security classification of any document held within the library in accordance with reference (n).

11.3.2 Technical Library Materials. The technical library has a wide variety of technical information and data in many different forms and formats. For FMA Technical Libraries eight broad categories of information exist which are described in reference (e).

11.3.2.1 Indices. Indices serve as reference or information sources that name systems, supplies and other information sources. Examples of indices include:

- a. Ships Drawing Index (SDI).
- b. Index of Technical Publications (ITP).
- c. TDMIS.
- d. Navy publications, forms and instructions (Reference (c)).
- e. ASSIST Quick Search **Error! Hyperlink reference not valid.**quicksearch.dla.mil
- f. ATIS Systems

11.3.2.2 Technical Manuals. Technical manuals outline inspection and repair procedures for shipboard systems. Examples of technical manuals include:

- a. Ship's Information Books.
- b. General Information Books.
- c. Naval Ships' Technical Manual (NSTM).
- d. Propulsion Operating Guide.
- e. General Specifications for Overhaul.
- f. Equipment Technical Manuals.
- g. Organizational Maintenance and Management System - Next Generation (OMMS-NG).
- h. Ordnance Publications.
- i. Ordnance Data.

11.3.2.3 Drawings. Drawings have engineering and design requirements needed to repair equipment to original specifications. Drawings are also used to find the location of shipboard systems and system equipment and components. Drawings stored in technical libraries include:

- a. Ship's construction drawings.
- b. Ship Alteration installation drawings.
- c. Selected Record Drawings.
- d. Ship's Equipment Drawings.
- e. Vendor/Manufacturer's Drawings.
- f. Booklet of General Drawings.

11.3.2.4 Handbooks and Cataloging. Handbooks have detailed information about specific systems or equipment and may also list equipment repair procedures. Examples of handbooks include the following:

- a. Micro-Electronic Device Date Handbook.
- b. Identification Markings for Fasteners.
- c. Gasket Material (Non-metallic).
- d. Guide for Sampling Inspections.
- e. Shipyard welding procedures.

11.3.2.5 Military Specifications and Standards. Military specifications and standards are specific, detailed requirements for equipment or material. ASSIST Quick Search <http://quicksearch.dla.mil>

11.3.2.6 Documents and Lists. Documents and lists are catalogs of parts, equipment or publications and alteration records. The following are examples of documents and lists typically found in technical libraries:

- a. Navy Management Data List (NAVSUP Publication 4100).
- b. Navy Directive List.
- c. Introduction to Federal Supply Catalogs and Related Publications (NAVSUP Publication 4400).
- d. Ship Changes.
- e. Planning Yard Work Instructions.

11.3.2.7 Instructions, Technical Publications and Bulletins. These publications give guidelines for the operation of equipment, introduce new equipment and may have lists of available items. Instructions, technical publications and bulletins commonly stocked in technical libraries include:

- a. General Services Administration Supply Catalog.
- b. Electronics Information Bulletins.
- c. Field Change Bulletins.
- d. N AVSEA Instructions.
- e. Type Commander Instructions.
- f. Technical Directives.

11.3.2.8 Repair Standards. These standards are detailed repair procedures for the troubleshooting and overhaul of specific equipment and guidance for standard processes. Examples of repair standards include:

- a. Technical Repair Standard.
- b. Maintenance Standard.
- c. Intermediate Maintenance Standard.
- d. Unified Industrial Process Instruction.

11.4 INDEX OF TECHNICAL PUBLICATIONS AND SHIP'S DRAWING INDEX. Due to the wide variety of types of materials that may be included in a technical library, it may be confusing as to what are the minimum titles and requirements needed for a particular ship. The ITP and SDI have been developed for each ship and list the titles and drawings applicable to the ship.

11.4.1 Index of Technical Publications. The ITP is a guide to facilitate the identification of technical manuals used on board a ship. The ITP is tailored to the configuration of a specific ship and lists technical manuals needed to operate, maintain and repair ship systems and equipment. It also lists any other general and ship related manuals needed by Ship's Force. The ITP will:

- a. Contain a list of the technical manuals needed on board a ship.
- b. Identify technical manuals for specific systems and equipment.
- c. List the systems and equipment supported by a specific technical manual.
- d. Include information about each technical manual.
- e. Be in electronic (EXCEL) format and sorted by APL/Repairable Identification Code and Hierarchical Structure Code.

11.4.2 Ship's Drawing Index. The SDI is a list of ship drawings and related design reference information that shows the actual current configuration of the ship. SDIs are required by General Specifications for Shipbuilding for all ships over 200 feet in length.

- a. The original SDI is prepared by the shipbuilder and approved by Supervisor of Shipbuilding. After acceptance of the ship by the Navy, the SDI is sent to the selected planning yard which is assigned as custodian of the index.
- b. Corrections to the SDI are submitted by the industrial activity to reflect work performed during Chief of Naval Operations maintenance availabilities and Fleet maintenance availabilities. Original SDIs are to be corrected by the planning yard to reflect changes reported by the ship or other activities when changes are made between regular overhauls.
- c. SDI information includes:
 - (1) Drawing title.
 - (2) NAVSEA drawing number and revision.
 - (3) Builder or contractor drawing numbers of Hull Mechanical and Electrical drawings applicable to the individual ship.

11.5 MAINTENANCE SUPPORT CENTERS (AIRCRAFT CARRIERS ONLY).

- a. MSCs provide a centralized support facility to aid work center technicians in Integrated Logistics Support processing and problem resolution services. The MSC provides shipboard management of technical documentation and libraries in support of ship's maintenance and material requirements. The MSC will function within the policy and procedural guidelines of references (a) and (b).
- b. The MSC manages and maintains an accurate equipment/component configuration database, identification of required technical support (e.g., repair part APLs, drawings, technical manuals, test equipment, Planned Maintenance System, etc.), and facilitates resolution of repair part support problems.

(This Page Intentionally Left Blank)

VOLUME IV
CHAPTER 12
HULL INSPECTION OF SHIPS AND CRAFT

REFERENCES.

- (a) NAVSEA S9086-DA-STM-000 - NSTM Chapter 100 (Hull Structures)
- (b) ABS Guide for Building and Classing High Speed Naval Craft (2007)
- (c) NAVSEA T9074-AS-GIB-010/271 - Requirements for Nondestructive Testing Methods

LISTING OF APPENDICES.

- A Sample Layout of Inspection Areas
- B Hull Reporting Format

12.1 **PURPOSE.** To provide general guidance for the inspection of ship's hulls to detect structural defects or hull thickness degradation and to establish supplemental procedures and periodicities for the conduct of hull inspections of thin hulled ships and craft for the timely detection of corrosion or erosion.

12.1.1 **Scope.** Thin hull ships are defined as those ships and craft with hull plating less than 1/2 inch design thickness at any location below the waterline. Hull Inspections and repair for wooden hulled ships and craft are addressed in Chapter 24 of this volume. Guidance contained in this chapter applies to all thin steel hull ships and craft.

- a. Detailed direction for thin hull assessment can be found in reference (a) for the following classes of surface force ships:
 - (1) DDG 51
 - (2) FFG 7
 - (3) CG 47
 - (4) LPD 17
- b. The following classes of surface force ships were built to reference (b), therefore reference (a) does not apply:
 - (1) LCS
 - (2) PC

12.1.2 **Discussion.**

- a. All ship's hulls must be inspected in accordance with Planned Maintenance System (PMS). Reference (a) contains additional guidance and check lists for conducting a thorough internal and external visual hull inspection. Should visual hull inspections reveal suspect areas, these areas should be ultrasonically tested to determine the need for repairs.
- b. Hull inspections will reveal the ship's hull condition through self-inspection of inner shell structure by Forces Afloat. These inspections will permit detection of structural defects and hull thickness degradation resulting from the cumulative effects of unarrested corrosion, and identify any areas in need of repair and/or preservation. Shell plating areas which are inaccessible can be measured ultrasonically by divers from outside the hull.
- c. Besides verbal descriptions of damage, graphical layouts of hull structure for some ship classes are available for use in the inspection. These schematics are for the purpose of plotting damage locations, as well as assisting the inspector in orientation and report analysis in assessing damage effects.

- d. Main machinery spaces are most prone to corrosion due to the severe environmental extremes of temperature and humidity arising from continuous operation of the propulsion machinery and supporting systems. This alternate wetting and drying of the interior hull surfaces resulting from normal ship's operations and shutdowns over a long period produces oxidation cycles which lead to corrosion.
- e. Inspections should take place inport during a period when the machinery plant will be secured for at least one week. During the work definition period, prior to a scheduled dry-dock availability, an inspection should be scheduled so that it precedes the availability in enough time to permit the identification of all hull structure in need of repair (i.e., approximately nine to ten months prior to the scheduled availability). The ISIC/TYCOM will coordinate and schedule the inspections as requested by the ship's Commanding Officer.
- f. The inspection is primarily intended for areas which are subject to both high stress and heavy corrosion, namely, bottom shell structure in the main machinery spaces of the ship. Accordingly, all fire rooms and engine rooms must be surveyed for structural deterioration, with emphasis on the following areas:
 - (1) Under boilers and turbines, where access is difficult and environmental extremes are most severe.
 - (2) Around boiler feedwater tanks, which are continuously wet from "sweating".
 - (3) Around the various overboard intakes and discharges, where external turbulence often produces erosion.
 - (4) Along the interior of the side shell in way of the exterior waterline. Here the design thickness of the shell plating is thinnest, and exterior corrosion from wave action is always present.
 - (5) Around "wet" equipment, which continuously operate with steam/water emission (e.g., pumps, condensers, evaporator, etc.).
 - (6) Areas of the bottom shell which are subject to the corrosive action of bilge water.
- g. Items such as deck plating in way of uptake spaces, pump rooms, refrigeration spaces, heads, etc., are omitted from this inspection. These "wet" areas are considered to be "housekeeping" items and will be surveyed during the pre-overhaul hull inspection. All tank and void spaces, which are in proximity to the machinery spaces being surveyed, are also omitted from this inspection, as these compartments do not meet the above criteria. The interiors of these spaces are inspected during industrial availabilities.
- h. Procedures regarding hull inspections which are associated with Pre-CNO Maintenance Availability planning, are issued separately for each availability as determined by the requirements for each ship.

12.2 **ACTION.** Both internal and external hull inspections shall be accomplished in accordance with reference (a) and (c) on all ships and craft identified in paragraph 12.1.1 of this chapter. Periodicities shall be as specified by the TYCOM or as required by PMS.

- a. At the beginning of any dry-docking period, (regular overhaul, Docking Selected Restricted Availability, interim dry-docking, etc.) an extensive hull survey will be conducted using the ship's plans and a sampling plan similar to that shown in Appendix A of this chapter. The inspection shall be conducted using ultrasonic techniques, drill testing or caliper method as appropriate.
- b. A pre-overhaul inspection of the hull should be conducted prior to a dry-docking availability to ensure known hull repairs are included in the planned work package and to ensure unexpected costs are kept to a minimum. Dry-docking is not required for a pre-overhaul inspection; however, maximum use should be made of available tools and techniques to accurately determine the condition of the hull.
- c. A minimum of one hull reading every other frame, and every other strake (as shown in Appendix A of this chapter) up to the waterline, shall be taken and the results recorded in the inspection report of Appendix B of this chapter. Suspect areas, as determined by visual inspection, shall have several readings taken and the least thickness recorded. Any area showing a reading less than the minimum allowable shall have additional readings taken in an expanding fashion to determine the actual extent of the excessive deterioration.

- d. In locations where there is an inner hull, such as bilge area tank tops, inside readings shall be taken in addition to those readings taken on the hull. These readings shall be taken every other frame, port and starboard, recorded in the format of Appendix B of this chapter, and submitted with the hull inspection report.
- e. In general, hull sections and structures which have suffered 25 percent or greater reduction in cross-sectional area from their original thickness, should be cut out and replaced. Scattered pits of depth at least 25 percent, but not greater than 45 percent of the original thickness, may be repaired by clad welding.
- f. An engineering analysis considering current and probable future corrosion may be performed to determine if the corroded structure is within allowable stress levels, rather than performing an automatic repair when corrosion has resulted in a 25 percent or greater reduction of cross sectional area. The repair criteria shall be based on the applicable General Specifications for Overhaul.

12.3 REPORTS. The results of all hull inspections shall be forwarded to the ship, with an information copy to the TYCOM/ISIC, using the format of Appendix B of this chapter. Areas having unsatisfactory results shall be superficially noted in the report cover letter. Unsatisfactory areas shall be defined by size in feet and inches and location in relation to strake and frames.

(This Page Intentionally Left Blank)

**APPENDIX A
SAMPLE LAYOUT OF INSPECTION AREAS**

STRAKE	G	1	3	4	2	1	3	4	2	1	3
	F	4	2	1	3	4	2	1	3	4	2
	E	1	3	4	2	1	3	4	2	1	3
	D	4	2	1	3	4	2	1	3	4	2
	C	1	3	4	2	1	3	4	2	1	3
	B	4	2	1	3	4	2	1	3	4	2
	A	1	3	4	2	1	3	4	2	1	3
	18	19	20	21	22	23	24	25	26	27	

FRAME

Numbers denote the areas to be tested on each inspection (i.e., the first inspection consists of all number 1 - Requirements for Nondestructive Testing Methods, the second inspection, all number 2's, etc).

(This Page Intentionally Left Blank)

(This Page Intentionally Left Blank)

VOLUME IV
CHAPTER 13

WEIGHT HANDLING EQUIPMENT TESTING AND INSPECTION

REFERENCES.

- (a) NAVFAC P-307 - Management of Weight Handling Equipment
- (b) NAVSEA 0989-LP-043-0000 - Commissioned Surface Ship General Reactor Plant Overhaul and Repair Specification
- (c) NAVSEA 0989-LP-037-2000 - Commissioned Submarine General Reactor Plant Overhaul and Repair Specifications
- (d) NAVSEA 0989-LP-058-0000 - AS/AD Tender Nuclear Support Facilities Preventive Maintenance Index
- (e) NAVSEA S9086-XG-STM-010 - NSTM Chapter 700 (Shipboard Ammunition Handling and Stowage)
- (f) NAVSEA S9086-TX-STM-010 - NSTM Chapter 583 (Boats and Small Craft)
- (g) NAVSEA S9086-T4-STM-010 - NSTM Chapter 589 (Cranes)
- (h) NAVSEA S9086-T3-STM-010 - NSTM Chapter 588 (Aircraft Elevators)
- (i) NAVSEA STD DWG 803-5959209 - Aircraft Deck Tiedown Fittings
- (j) NAVSEA STD DWG 805-1916300 - Aircraft Securing and Engine Run-up Fittings
- (k) NAVSEA S9086-TV-STM-010 - NSTM Chapter 581 (Anchoring)
- (l) NAVSEA SG420-AP-MMA-010 - Periodic Testing Arrangements for Ordnance Handling Equipment
- (m) NAVAIR 17-1-127 - Periodic Proofload Testing of Weapons Support Equipment W/IPB
- (n) NAVSEA OP 4098 - Handling Ammunition, Explosives and Hazardous Material with Industrial Materials Handling Equipment
- (o) NAVSEA OP 3347 - Ordnance Safety Precautions, U.S. Navy
- (p) NAVORD OP 4 - Ammunition Afloat
- (q) NAVSEA S9086-TM-STM-000 - NSTM Chapter 573 (Booms)
- (r) NAVSEA S9086-ZN-STM-000 - NSTM Chapter 772 (Cargo and Weapons Elevators)
- (s) NAVSEA STD DWG 805-2276338 - Cleats
- (t) NAVSEA STD DWG 803-5000902 - Safety Net, Deck Edge, Steel Frame and Nets
- (u) NAVSEA STD DWG 803-5184097 - Safety Net, Deck Edge, Aluminum Frame and Nylon Nets
- (v) NAVSEA STD DWG 805-1639000 - Deck Screw Reversible Eyebolts
- (w) NAVSEA S9086-TL-STM-000 - NSTM Chapter 572 (Shipboard Stores and Provision Handling)
- (x) NAVSEA S9086-UF-STM-010 - NSTM Chapter 600 (Structural Closures)
- (y) NAVSEA STD DWG 805-1645271 - Portable Davits
- (z) NAVSEA S9AA0-AB-GOS-010/020 - General Specifications for Overhaul of Surface Ships (GSO)
- (aa) NAVSEA STD DWG 804-5184163 - Trunk Safety Nets
- (ab) NAVSEA S9086-TK-STM-010 - NSTM Chapter 571 (Underway Replenishment)
- (ac) NAVSEA STD DWG 804-1213717 - Vehicle Tiedown Deck Fittings
- (ad) NAVSEA STD DWG 709-5549373 - Weapons Handling Equipment SSN 688 Class Test Loads/Methods and Inspection Procedures
- (ae) NAVSEA STD DWG 709-6633924 - Vertical Launch System Weapons Handling Equipment SSN 688 Class Test Loads/Methods and Inspection Procedures
- (af) NAVSEA STD DWG 709-5549374 - Weapons Handling Equipment SSN 726 Class Test Loads/Methods and Inspection Procedures
- (ag) NAVSEA STD DWG 709-6726350 - Weapons Handling Equipment SSN 21 Class Test Loads/Methods and Inspection Procedures
- (ah) NAVSEA S9086-UU-STM-010 - NSTM Chapter 613 (Wire and Fiber Rope and Rigging)
- (ai) NAVSEA 0989-LP-030-7000 - Lifting Standard

13.1 **PURPOSE.** To ensure Weight Handling Equipment (WHE) is capable of continued reliable and safe operation.

- a. WHE shall be of sufficient rated capacity to safely handle the calculated load; including, all slings, shackles, turnbuckles, strongbacks and chain hoists.

- b. The WHE selected shall be inspected before each use for obvious material deficiencies, equipment capacity markings, and load test expiration date (as applicable).

13.1.1 Scope. The following guidance has been utilized to incorporate both Naval Sea Systems Command (NAVSEA) and Naval Facilities Engineering Command requirements:

- a. For shipboard WHE used both afloat and ashore, including Floating Drydocks, NAVSEA technical requirements are cited and invoked as the top-level guidance.
- b. For shore based WHE used only ashore, Naval Facilities Engineering Command and the Code of Federal Regulations technical requirements are cited and invoked as the top-level guidance.
- c. For general purpose lifting and rigging, shore based rigging gear and portable hoists meeting the requirements of reference (a) may be used aboard ship when the ship is pier-side.
- d. For Reactor Plant Lifting and Handling Equipment and lifts of major reactor plant components, additional guidance is provided in Section 9400-0 of reference (b) and in reference (c). Reference (d) provides guidance for lifting radioactive material or reactor plant components when NAVSEA approved lifting equipment is not available (i.e., use of the B & M crane to lift portable effluent tanks or radioactive waste). These requirements apply to all commissioned ships, shipyards and Naval shore-based activities.

13.2 NAVAL SEA SYSTEMS COMMAND AFLOAT REQUIREMENTS.

13.2.1 Definitions.

- a. **Dynamic Load Test.** An operational overload test conducted to verify the ability of the lifting equipment to operate with rated load while being subjected to dynamic conditions associated with ship motions.
- b. **Load Bearing Members.** Those members of the lifting and handling equipment which support the load and upon failure could cause dropping, uncontrolled shifting, or movement of the load.
- c. **No-Load Test.** A test which verifies equipment functional performance without a load.
- d. **Rated Load.** The maximum permissible load carried during use (also called "Safe Working Load" (SWL)). The weights of handling gear; such as slings, strongbacks, handling dolly, which are not an integral part of the equipment being tested, shall be considered as part of the rated load.
- e. **Rated Load Test.** A load test at 100 percent of the rated load, conducted at rated speed through the complete range of operating limits. The test is performed to determine the proper operation of the equipment, repeatability of functions and heat dissipation ability.
- f. **SWL.** See Rated Load.
- g. **Factor of Safety.** The ratio of the yield stress load on a structure to the estimated maximum load in ordinary use.

$$\text{Factor of Safety} = \frac{\text{Actual Yield Strength}}{\text{Required Strength}}$$

- h. **Static Load Test.** A stationary overload test conducted to verify the structural and mechanical integrity of the lifting equipment. The lifting equipment holds the test load for a short period of time while the test inspector checks the equipment for signs of brake slippage or damage.

13.2.2 Procedure. Fabrication, repair and testing of Shipboard Weight Handling and/or Weapons Handling and Stowage Equipment will be conducted using a Controlled Work Package developed in accordance with Volume V, Part I, Chapter 2 of this manual. This requirement does not apply to periodic weight test of Shipboard Weight Handling and/or Weapons Handling and Stowage Equipment. Shipboard Weight Handling and/or Weapons Handling and Stowage Equipment requiring a weight test based on Planned Maintenance System (PMS) or other periodic testing requirements, excluding tests in conjunction with repair or manufacture, will be inspected and tested using Technical Work Documents, such as a pre-existing maintenance procedure, test load methods drawing, technical manual or Formal Work Package. Periodic weight testing must be witnessed by a qualified inspector.

- a. **Testing Sequence.** Newly installed/overhauled equipment shall be tested in the following order:

- (1) No-load Test.
 - (2) Static Load Test.
 - (3) Dynamic Load Test.
 - (4) Rated Load Test.
- b. Results of completed weight tests will be documented on QA form 17W, using the procedures of Volume V, Part I, Chapter 11 of this manual. The serial number (if known) of the equipment shall be recorded on the weight test record.
- c. Handling equipment that has satisfactorily passed the required inspections and load testing shall be so marked by the activity conducting the tests. As a minimum, this marking shall include the name of the testing activity, the date (year and month) tested, date of re-inspection due date, the rated load or SWL and a unique serial number that will allow it to be traced to its test and inspection documentation.
- (1) Where there is little available space for surface marking, such as on wire rope slings, the item may be marked with a Periodic Load Test Record Strap as shown in reference (e).
 - (2) Nylon webbing slings shall have etched leather tags sewn to each sling leg to identify the leg and indicate test results as described in reference (f).
 - (3) Stamped, etched or engraved metal tags, which are attached to the tested item with mechanical fasteners or adhesives, may also be used.
 - (4) Color coding, for local control only, may be used in addition to, but not as an alternate to, one of the authorized marking methods.
 - (5) Wire rope (1/32" through 3/16" diameter) may be used to attach metal tags to WHE provided that the wire rope is secured using mechanical fasteners designed to secure wire rope such as swedges. Metal tags attached using lockwire style twisted wires are prohibited.
- d. A permanent log, written or electronic, shall be maintained to record the following information:
- (1) Equipment identification.
 - (2) Date of the test or inspection.
 - (3) Description of the test or inspection.
 - (4) Weight used for the test, in pounds.
 - (5) Testing activity.
- e. New hooks, blocks, sheaves, wire rope, fiber rope, and other loose hardware or gear need not be load tested after installation if it has not been modified and has been purchased to Military Specifications (MILSPEC) or NAVSEA standard drawings through the Naval Supply System. Any load carrying loose gear procured otherwise shall be tested prior to placing in-service to 200% of the SWL of the part in question. If any sheave, block or hook assembly is received that does not bear the manufacturer's test stamp, it shall be tested to 200% of the SWL.
- f. Unless otherwise specified, load test capacity tolerance shall be +5%, -0%.

13.2.3 Load Test Types and Duration. For each test, the equipment shall withstand the load test for a minimum of two minutes (10 minutes for hoists, cranes and crane structures) with no permanent deformation. For hoists, trolleys and other moving machinery, lift (travel) through three cycles of all moving parts at maximum rated speed.

13.2.3.1 Static Load Test.

- a. Unless otherwise specified, all arrangements for handling and supporting weights (including weights of personnel), all arrangements for taking heavy strains, and all parts upon which the safety of the ship or life depend, shall be given a static load test equal to twice the rated load. In cases where the rated load is not specified, the test load shall be based on the expected duty of the auxiliary, appliance, or fitting. For hoisting arrangements, the static test load shall be suspended clear of all supports and held

suspended for a sufficient period to permit inspection of welds and other fastenings, but need not be lifted or moved by a gear under test. After relieving the static test load, there shall be no evidence of permanent deformation of structure.

- b. The equipment or system to be tested shall not be used to lift the total static test load. Static load tests shall be completed prior to performance of operational tests. Where static test loads exceed 40% of rope breaking strength, the ship's rope shall not be used for the static test.

13.2.3.2 Dynamic Load Test. Weight handling arrangements shall be tested to demonstrate capacity to withstand additional loads imposed on a system when operating under unfavorable sea conditions at reduced speed. The dynamic load test shall be conducted to demonstrate handling equipment load capabilities throughout the complete operating range. As far as practicable, test loads shall be moved completely through the equipment operating range, within the limits of all operating modes.

NOTE: IF THE EQUIPMENT USES HYDRAULIC POWER, THE SYSTEM RELIEF VALVES SHALL BE CHECKED FOR PROPER SETTINGS BEFORE PERFORMING A DYNAMIC LOAD TEST.

13.2.3.3 Rated Load Test. Following satisfactory completion of the dynamic load test, the rated load test shall be conducted to demonstrate capability to operate with a full load, at rated speed, through the complete range of operating limits. As far as practicable, test loads shall be moved completely through the equipment operating range, within the limits of all operating modes. Proper operational functions shall be demonstrated at each speed in all operating modes. The mechanical safety devices shall be tested for their ability to stop and hold when carrying rated load at rated speed.

13.2.4 Load Test Periodicity.

- a. In the interest of personnel safety and equipment protection, inspection and testing of all WHE not covered by PMS or other directives will be performed at intervals not to exceed four years. A PMS feedback will be submitted for each piece of WHE not covered by PMS.

NOTE: PER NAVSEA DIRECTION, STATIC, DYNAMIC AND RATED LOAD TESTING OF MAIN STORAGE BATTERY LIFTING GEAR INSTALLED IN SUBMARINE BATTERY COMPARTMENTS IS NOT REQUIRED UNLESS REPAIRS TO STRUCTURAL OR WEIGHT SUPPORTING COMPONENTS HAVE BEEN ACCOMPLISHED. FOLLOWING REPAIRS, LOAD TESTING WILL BE ACCOMPLISHED DURING BATTERY REPLACEMENT AFTER THE BATTERY CELLS HAVE BEEN REMOVED.

- b. Testing of the following components is required when newly installed or after major structure repair or modification.
 - (1) Accommodation ladders.
 - (2) Cleats.
 - (3) Gangplanks.
 - (4) Leadsman platform.

NOTE: LIFELINE STANCHIONS DO NOT REQUIRE WEIGHT TESTING FOLLOWING MANUFACTURE OR REPAIR.

- (5) Liferails/stanchions.
- (6) Lifelines.
- (7) Padeyes.
- (8) Portable davits.
- (9) Reversible eyebolts.
- (10) Slings.
- (11) Safety nets (not including deck edge safety nets).

(12) Vertical ladders.

13.2.5 Crane Certification Program.

- a. A Crane Certification Program shall be implemented in each ship with a crane installed or assigned, in accordance with reference (g).
- b. Guidelines for training and qualification of personnel responsible for shipboard crane operation and maintenance are contained in reference (g).

13.2.6 Daily Inspections. Daily, before use visual inspections shall be conducted as follows:

- a. Ammunition handling equipment.
 - (1) A daily, before use visual inspection shall be performed in accordance with PMS for the assigned equipment before any load handling operations.
 - (2) A no-load operational test shall be conducted by each shift prior to handling ammunition.
- b. All handling equipment selected (including slings, shackles, turnbuckles, strongbacks, chain hoists and taglines) shall be visually inspected before use for obvious material deficiencies, equipment capacity markings and load test expiration date (as applicable).
- c. Before beginning crane operations for each new day, a qualified crane operator shall perform an inspection of each crane to check for discrepancies in the crane's structure or operating controls using the crane Operator's Daily Check List provided in reference (g).

13.2.7 Use of Nylon Straps.

- a. The use of knotted nylon strapping as handling equipment is prohibited.
- b. Rigging with nylon straps is permitted only when nylon strapping is equipped with sewn (lifting) eyes and static load tested to 200 percent of rated load.
- c. When available handling equipment (for example, wire rope slings) cannot be properly attached, or load surface damage may occur, 6,000-pound (rated breaking strength) nylon strapping is permitted only for loads up to 1,000 pounds.
- d. Webbing slings shall be inspected for abrasions and fraying of the webbing and stitching, and broken stitches. Slings shall not be used if signs of deterioration are noted.

NOTE: REFERENCE (a) IS TO BE USED ONLY WHEN THE SHIP IS ACTUALLY PIERSIDE.

13.2.8 Weight Test Procedure Matrix. The following matrix provides sources of load test procedures for shipboard equipment/systems that may require periodic load testing or testing following fabrication or repair:

<u>EQUIPMENT/SYSTEM INSPECTIONS AND TESTING</u>	<u>GOVERNING DOCUMENT(S) FOR MAINTENANCE</u>
Aircraft Elevators	Reference (h), PMS
Aircraft Tiedowns	References (i) and (j)
Anchoring	Reference (k), PMS
Ammunition Handling	References (e), (l) through (p), PMS
Boats & Boat Davits	Reference (f), PMS
Booms	Reference (q), PMS
Cargo & Weapons Elevators	Reference (r), PMS

<u>EQUIPMENT/SYSTEM INSPECTIONS AND TESTING</u>	<u>GOVERNING DOCUMENT(S) FOR MAINTENANCE</u>
Cleats	Reference (s)
Cranes	Reference (g), PMS
Deck Edge Safety Nets	References (t) and (u)
Deck Screw Reversible Eyebolts	Reference (v)
Hoists	Reference (w), PMS
Hull Fittings	Reference (x), PMS
Portable Davits	Reference (y)
Reactor Plant Lifting and Handling Equipment	References (b) through (d)
Stores & Provision Handling	Reference (w), PMS
Temporary Padeyes	Reference (z), Section 611
Trunk Safety Nets	Reference (aa)
Underway Replenishment	Reference (ab), PMS
Vehicle Tiedowns	Reference (ac)
Weapons Handling Equipment SSN 688 Class	Reference (ad)
Vertical Launch System - Weapons Handling Equipment SSN 688 Class	Reference (ae)
Weapons Handling Equipment SSBN/SSGN 726 Class	Reference (af)
Weapons Handling Equipment SSN 21 Class	Reference (ag)
Wire and Fiber Rope and Rigging	Reference (ah)
Shipboard Crane and Miscellaneous Rigging Gear	Reference (g)

13.2.9 Identification of Equipment. (Submarines only) Following the weight test, ensure the Weapons Handling Equipment is properly marked as detailed in accordance with reference (e) section 4.

13.2.10 Witnessing Qualification. (Submarines only) Tended units Shipboard Weight Handling and/or Weapons Handling and Stowage Equipment requiring weight test based on PMS or other governing documents for periodic purposes must be witnessed by a qualified Weight Handling Test Inspector. The Weight Handling Test Inspector will be qualified in accordance with Quality Maintenance Personnel Qualification Standard (NAVEDTRA 43523) and certified by the Commanding Officer.

13.2.11 Record Keeping. (Submarines only) QA form 17W will be used to document Shipboard Weight Handling and/or Weapons Handling and Stowage Equipment weight testing. The Weight Handling Test Inspector will sign the Quality Assurance blocks of QA form 17W. The signed QA form 17W or a copy will be provided to the activity who maintains the Shipboard Weight Handling and/or Weapons Handling Equipment in all cases. QA form 17W will be retained by the end user and/or maintaining activity until superseded by successive testing for each piece of Shipboard Weight Handling and/or Weapons Handling and Stowage Equipment. QA form 17W used to document Shipboard Weight Handling and/or Weapons Handling and Stowage Equipment testing in a Controlled Work Package will be retained with the Controlled Work Package as prescribed by Volume V of this manual.

13.3 NAVAL FACILITIES ENGINEERING COMMAND ASHORE REQUIREMENTS. WHE assigned to naval shore activities and utilized only in ashore operations or aboard ships when the ship is pierside shall be certified, tested, inspected and operated in compliance with reference (a). For general purpose lifting and rigging, shore based rigging gear and portable hoists meeting the requirements of reference (a) may be used aboard ship when the ship is pierside (this does not apply to ordnance or radiological lifting and handling). Reference (a) covers line handling mechanisms on floating cranes, hoists and chainfalls which are used in multiple locations, and portable and adjustable gantry cranes and floor cranes. Material handling equipment is covered by Naval Supply Systems Command criteria.

13.3.1 Certification Program. The Commanding Officer is responsible for ensuring safety within the activity and shall designate a WHE certifying official who shall ensure the activity's WHE is inspected, tested and certified in accordance with reference (a).

13.3.2 Operator Licensing Program. All Navy civilian and military personnel assigned duties involving the operation of Navy shore based Category 1, 2, Cab Operated Category 3 or Category 4 WHE shall be qualified and licensed in accordance with the provisions of reference (a).

13.3.2.1 Operator Qualification and Testing. All applicants for Crane Operation Licenses shall meet the requirements of reference (a).

13.3.2.2 Licensing Procedures and Documentation. Reference (a) contains the necessary procedural requirements for licensing and documentation.

13.3.3 Inspections.

- a. Pre-Use Check (Category 1, 2, Cab Operated Category 3 and Category 4 Cranes). The operator shall perform an inspection of their assigned crane using a Crane Operator's Daily Checklist as required by reference (a).
- b. Reference (a) gives specific instructions for conducting and reporting the following inspections:
 - (1) Walk Around Inspection.
 - (2) Machinery House Inspection.
 - (3) Operator Cab Inspection.
 - (4) Operating Inspection.
- c. Pre-Use Check (Non-Cab Operated Category 3 Cranes) shall be performed in accordance with reference (a).

13.3.4 Test Procedures. Reference (a) contains instructions for performing crane test procedures.

13.3.5 Special Purpose Service. Activities using special purpose service cranes shall follow the requirements of reference (ai) in addition to criteria contained in reference (a).

13.4 SLINGS. Slings used in conjunction with other material handling equipment for the movement of material ashore by hoisting are covered by references (a) and (g).

- a. A sling is an assembly which connects the load to the material handling equipment.
- b. Slings include those made from alloy steel chain, wire rope, metal mesh, natural or synthetic fiber rope (conventional three strand construction), and synthetic web (nylon, polyester, and polypropylene).

13.4.1 Crane Rigging Gear and Miscellaneous Equipment. Reference (a) contains maintenance, inspection and test requirements for the following common rigging gear used ashore and reference (g) contains maintenance, inspection and test requirements for the following common rigging gear used shipboard. Reference (g) allows shore based rigging gear and portable hoists meeting the requirements of reference (a) to be used aboard ship with shipboard cranes when the ship is pierside.

- a. Slings.
- b. Shackles, links, rings, swivels, eye bolts, turnbuckles, hooks and swivel hoist rings.
- c. Tackle blocks.
- d. Portable load indicating devices (dynamometers, load cells, crane scales, etc.).
- e. Lashing (e.g., wire rope, synthetic rope, synthetic webbing).

VOLUME IV
CHAPTER 14
MAGAZINE SPRINKLER INSPECTION REQUIREMENTS

REFERENCES.

- (a) NAVSEA S9522-AA-HBK-010 - Description, Operation and Maintenance Handbook for Magazine Sprinkler Systems
- (b) NAVSEAINST 4790.8/OPNAVINST 4790.4 - Ships' Maintenance and Material Management (3-M) Manual

14.1 PURPOSE. To provide guidance for the performance of magazine sprinkler inspections.

14.2 RESPONSIBILITIES.

14.2.1 Commanding Officers.

- a. Ensure that sprinkler systems are tested in accordance with Planned Maintenance System.
- b. Ensure that magazine temperatures are checked and recorded daily.
- c. Ensure that magazines are properly maintained.
- d. Ensure that prior to acceptance of a sprinkler system in new construction or when design changes (Ship Changes) are made to a sprinkler system during construction or overhaul, the cognizant industrial activity provides written verification that each system is completely operational. A certified magazine inspector will perform the verification of system operability in accordance with reference (a).
- e. Ensure that magazine sprinkler system inspection requirements are conducted in accordance with reference (a) and when directed by Planned Maintenance System. These inspection requirements apply to both the thermo-pneumatic and hydraulic control systems. All tests will be in accordance with reference (a) and will be followed by a complete operational test by Ship's Force using the appropriate Maintenance Requirement Card. A certified magazine inspector will conduct all thermo-pneumatic tests.
- f. Ensure that a magazine sprinkler system verification inspection is scheduled prior to ordnance on-load (if required by paragraph d. or e. above). A certified magazine sprinkler inspector shall conduct the inspection.
- g. Take necessary action to correct all discrepancies noted during magazine sprinkler inspections. Within 30 days following receipt of the magazine sprinkler discrepancy list, report the status to the Immediate Superior In Command (ISIC) with information copy to the Type Commander via message, identifying corrective action(s) taken and/or applicable Plan of Action and Milestones.
- h. Ensure that design discrepancies are reported to the Type Commander and submitted into the Current Ships' Maintenance Project. Procedures for reporting discrepancies are included in reference (b) and Type Commander instructions.

14.2.2 Verification Activity.

- a. Ensure Magazine Sprinkler System Inspector has completed applicable qualifications of the Magazine Sprinkler Systems Inspector Course (Course Number: K041-2137).
- b. Provide a sprinkler system discrepancy list by the categories **SAFETY, MAJOR, MINOR** and **INSTALLATION** to the Ship's Commanding Officer and ISIC.
- c. Provide written recommendations to the Ship's Commanding Officer and ISIC to continue or discontinue thermo-pneumatic certification until correction of any discrepancies and completion of satisfactory sprinkler system operational tests.

14.2.3 Immediate Superior In Command.

- a. Ensure that Shipboard Explosive Safety Inspection is scheduled in accordance with reference (a).
- b. Follow-up on all discrepancies reported by the verification activity. Those items that are discrepancies as a result of design problems should be reviewed by the cognizant Naval Engineering Agency and recommended corrective actions should be performed at the earliest convenient availability.
- c. Shall act as sole grantor of all magazine sprinkler systems re-certification via message. Re-certification is based on verifying activity's recommendation.

VOLUME IV
CHAPTER 15
CIRCUIT BREAKERS

REFERENCES.

- (a) NSWC Philadelphia ltr 9320, Ser 934/010 dated 19 Mar 2001, titled Shipboard Circuit Breaker Maintenance and Overhaul Policy

15.1 PURPOSE. To promulgate the Naval Sea Systems Command (NAVSEA) policy on maintenance and overhaul of Navy shipboard shock-hardened circuit breakers of both ACB and AQB types specified in reference (a).

15.2 CIRCUIT BREAKER FUNCTION AND ACQUISITION ON NAVY SHIPS. Circuit breakers onboard Navy ships and submarines are used primarily to provide electrical system protection against disruptive and sometimes destructive abnormal currents. This protection is so precise that it selectively removes only the cause of the abnormal current (such as electrical system damage acquired in battle) while continuing to power other unaffected weapons, electronics and electrical systems. This continuous supply of electrical power is also ensured by the unique ability of these circuit breakers to maintain proper position during severe impacts produced by missiles, bombs, mines, torpedoes and other detonation sources. Due to the unique nature and critical function of Navy shock-hardened circuit breakers, their acquisition is controlled through a Qualified Products List (QPL) governed by requirements set forth in appropriate military specifications. There is no equivalent commercial requirement.

15.3 CIRCUIT BREAKER OVERHAUL FACILITIES AND PART PROCUREMENT. Type AQB circuit breakers with non-replaceable trip units (100 amp and smaller sizes) are not repairable. All other circuit breakers are classified as Depot Level Repairable. NAVSEA has designated Puget Sound Naval Shipyard and the Original Equipment Manufacturer (OEM) as Designated Overhaul Points (DOP) for these items. The current OEMs offering overhaul service for their products are SPD Technologies, Inc., Whipp & Bourne, and Eaton/Cutler-Hammer (for Westinghouse breakers). Other (obsolete) ACB and AQB circuit breakers are overhauled by the Navy DOP. The ability to repair and refurbish circuit breakers is a "core" Naval Shipyard and TRIDENT Refit Facility (TRF) function, with all Naval Shipyards expected to maintain and execute this capability. This does not imply all Naval Shipyards or the TRFs will be appointed DOP status. The single Navy DOP at Puget Sound Naval Shipyard along with the OEMs and their service centers provide production capability and capacity to meet the requirements for restoration of stock assets to Ready For Issue condition and meet other routine circuit breaker overhaul requirements. Prior to the initial listing of a vendor's circuit breaker on the QPL, the OEM must successfully demonstrate by appropriate tests and inspections that the circuit breaker passes all the requirements contained in the military specification. To maintain the integrity of the circuit breaker as a qualified product, NAVSEA prohibits the local manufacture or fabrication of certain (restricted) parts during repair or overhaul. Due to the critical nature and stringent materials and manufacturing requirements, the Navy restricts the manufacture of these parts to the OEM listed for the particular circuit breaker. Specifically, all replacement parts for circuit breakers, except fasteners and general hardware items, are restricted parts. Non-restricted parts include nuts, bolts, screws, washers, lockwashers, cotter pins, O-rings, indicator lights, and indicator light globes (colored and clear). The restricted replacement parts shall be obtained from the Federal Stock System, the OEM or approved material diversion.

15.3.1 Submarines. NAVSEA has established a pool of circuit breakers removed from inactivated SSN 688 Class submarines to support SSN 688 and SSBN/SSGN 726 Class submarine's lifecycle requirements. The OEM has designated some circuit breakers still in use as obsolete and may no longer readily support them with parts. For obsolete breakers no longer supported by the Federal Stock System, Puget Sound Naval Shipyard and in some cases Ship's Maintenance Monitoring Support Performance Monitoring Teams (PMT), may be a source of parts. The ship must obtain the parts by approved material diversion. This will allow Puget Sound Naval Shipyard to either make parts or purchase parts from the OEM. The OEM can still manufacture the obsolete parts but the cost could be excessive. Even after the shipboard repairs are complete, the pay back is critical to ensure the lifecycle pool is maintained. If the lifecycle pool is allowed to deteriorate, circuit breakers for future requirements may not be available.

15.4 NAVY POLICY ON SHIPBOARD CIRCUIT BREAKER MAINTENANCE AND OVERHAUL.

- a. Not Repairable Circuit Breakers. Type AQB circuit breakers with non-replaceable trip units (100 amp and smaller) are not repairable. Any attempt to open and repair this type of circuit breaker results in an unacceptable risk to subsequent performance, even if retest is performed.
- b. Overhauls shall be performed by the Navy DOP at Puget Sound Naval Shipyard or the OEM. Class A and B overhauls are defined below:
 - (1) Class A Overhaul. An extensive overhaul that involves complete disassembly and refurbishment, such as re-plating mechanical and electrical parts, and replacing the wire harness. The "most recent" design and technical specifications will be met. The end product shall be in "like new" condition in appearance, operation and performance. All manufacturers' and technical manual performance standards and specifications, and all technical documentation, unless superseded by proper authority, shall be met. The repair activity shall demonstrate that the end product successfully meets all performance criteria of the governing specifications. Defining an overhaul as Class "A" means that all actions required to meet the definitions are authorized.
 - (2) Class B Overhaul. A less extensive overhaul that re-uses most of the existing parts to restore the operating and performance characteristics of a circuit breaker to its original design and technical specifications. Machinery Alterations, field changes and modifications, even if applicable, are not to be accomplished unless specified by proper authority. The repair activity shall demonstrate that the end product successfully meets all performance criteria of the governing specifications.
- c. Non-OEM Vendors. When commercial repair facilities other than the OEM express an interest in performing repair and overhaul work, they must demonstrate to NAVSEA the capability to perform the work. Capability to perform circuit breaker overhaul and repair work includes having the facilities, trained mechanics, and access to the OEM's qualified parts and repair procedures. Use of nonqualified, restricted parts violates the integrity of the circuit breaker, nullifying the breaker's prior qualification under the QPL process. Restricted parts must be obtained from the OEM either directly or via the Federal Stock System (with the exceptions as noted above). If a restricted part is replaced with an unqualified part, the qualification of the particular circuit breaker is revoked until the full set of QPL required tests are repeated and submitted to NAVSEA for approval.
- d. Fleet Maintenance Activities and Organizational Level Maintenance and Repair. Maintenance and repair of circuit breakers by Organizational and Fleet Maintenance Activities includes cleaning, inspection, lubrication, accomplishment of technical manual specified corrective maintenance, and operational testing and replacement of the bolt-on parts (obtained from qualified sources). Bolt-on parts include charging motors, arc chutes, auxiliary switches, closing relays, electronic trip units (only units that are adjustable with a portable trip unit calibration test set), indicator lights and indicator light transformers, rectifier units and resistors, secondary disconnects, shunt trip units, transformers, undervoltage trip units, and wiring and connections. Repairs which alter the breaker calibration, require major disassembly of the operating mechanism, or require re-plating must be performed at either a depot level activity or a TRF. Repairs of this type conducted by a non-depot level activity (other than a TRF) to meet operational commitments, must be certified at the earliest available opportunity by an authorized depot activity (DOP, TRF, or Naval Shipyard with demonstrated circuit breaker repair and retest capability). Type Commanders should ensure a Departure From Specification is processed for the above types of emergent repairs.
- e. (Submarines Only) Performance Monitoring Teams. PMTs are permitted to perform in-depth circuit breaker maintenance and repairs as an augmentation to Forces Afloat maintenance when the PMT member is designated, trained, certified, and provided with the proper equipment. The PMT shall not make calibration repairs or adjustments that require shop verification by primary current injections. These types of calibration and certification adjustments shall only be accomplished by an authorized depot activity. NAVSEA 08 has authorized the Ship's Maintenance Monitoring Support PMTs to conduct repairs on NAVSEA 08 cognizant circuit breakers similar to those on non-nuclear applications.

- f. NAVSEA 08 cognizant circuit breakers. If questions or technical issues arise regarding NAVSEA 08 cognizant circuit breakers which cannot be resolved by consulting the applicable technical manual, prepare a Trouble Record or Liaison Action Request and submit to Assistant NAVSEA Technical Representative, Schenectady, NY in accordance with the Commissioned Submarine/Surface Ship General Reactor Plant Overhaul and Repair Specification.

(This Page Intentionally Left Blank)

VOLUME IV
CHAPTER 16

AIRCRAFT LAUNCH AND RECOVERY SYSTEMS FOR AIRCRAFT CARRIERS ONLY

REFERENCES.

- (a) NAVSEAINST 4790.8/OPNAVINST 4790.4 - Ships' Maintenance and Material Management (3-M) Manual
- (b) OPNAVINST 4790.15 - Aircraft Launch and Recovery Equipment Maintenance Program (ALREMP)
- (c) COMNAVAIRLANTINST 4790.40/COMNAVAIRPACINST 4790.39 - Aircraft Launch and Recovery Equipment Maintenance Program (ALREMP) Management Teams
- (d) OPNAVINST 3120.28 - Certification of the Aviation Capability of Naval Ships Operating Aircraft
- (e) COMLANTFLTINST 3500.18 - Certification and Readiness of Aviation Facilities in Naval Ships Operating Aircraft
- (f) NAVAIRINST 3120.1 - Lead Systems Command Procedures and Responsibilities for Certification of Aviation Facilities and Equipment in Naval Ships Operating Aircraft

16.1 **PURPOSE.** To provide guidance concerning the maintenance policies, procedures and responsibilities for Aircraft Launch and Recovery Equipment (ALRE) throughout the ship's operating cycle.

16.1.1 **Scope.** The Aircraft Launch and Recovery Equipment Maintenance Program (ALREMP) is sponsored and directed by the Chief of Naval Operations, and is administered through the chain of command to provide material and technical support by the cognizant Systems Command. The ALREMP provides an integrated system for performing maintenance and related support functions on ship's installed aircraft launching and recovery systems and associated peripheral support systems and equipment.

16.2 **AIRCRAFT LAUNCH AND RECOVERY EQUIPMENT MAINTENANCE PROGRAM.**

16.2.1 **Applicability.** The ALREMP encompasses all Navy activities concerned with the operation, rework, repair, production and support of Aircraft Carrier ALRE, including catapults, arresting gear, Visual Landing Aids (VLA), and associated deck gear and accessories.

16.2.2 **Objectives.** The ALREMP establishes standard procedures to control maintenance, provide quality assurance performance verification, and provide for a more effective ship's Maintenance and Material Management system in compliance with reference (a).

16.2.3 **Responsibilities.**

- a. Naval Air Systems Command (NAVAIR) shall provide overall ALREMP management through the ALRE Program Manager (PMA 251).
- b. The ALRE Program Manager, or his direct representative, shall establish and chair the ALREMP Working Committee.
- c. The Naval Air Warfare Center (NAVAIRWARCEN) Aircraft Division, Lakehurst will provide technical services and act as the technical manager for the ALREMP.
- d. The Type Commanders (TYCOM) shall provide ALRE Maintenance Management Teams to conduct assist visits and annual audits of all units, per the requirements of reference (b). These assist visits and annual audits will ensure operation and maintenance of ALRE is conducted within the guidelines of the ALREMP as directed by reference (b).

16.2.4 **Management Team.** The ALREMP Management Team consists of a qualified ALRE Maintenance Officer, and an experienced Senior/Master Chief Aviation Boatswains Mate (ABECS/ABCM), assigned to Commander Naval Air Force Atlantic (COMNAVAIRLANT) N433/Commander Naval Air Force Pacific (COMNAVAIRPAC) N435. Audit assistance may be provided to the TYCOMs by the ALRE Program Office (PMA 251) Fleet Programs Team. The ALREMP Management Team provides the following services.

- a. Pre-implementation training for the ALREMP.

- b. Assistance to ships during the ALREMP implementation phase.
- c. Assist visits during industrial availabilities.
- d. Assist visits following an industrial availability or during a ship's work-up cycle.
- e. Formal audits, in accordance with references (c), prior to or during mid-deployment.

16.2.5 Assist Visits. Assist visits will be advisory in nature and will normally be scheduled to follow a ship's Selected Restricted Availability or during the work-up cycle. Units visited are encouraged to discuss maintenance/material quality assurance problems with team members. Upon completion of the visit, the team will debrief the Air Department Officer and designated Air Department personnel. An informal report of noted problems and recommendations will be provided at the debrief. The Commanding Officer will be debriefed at the discretion of the team leader. The ALREMP Management Team may be requested for additional assist visits at the ship's discretion via the applicable TYCOM.

16.2.6 Audits.

- a. Formal audits will be conducted upon completion of a Chief of Naval Operations availability, annually or prior to deployment, and will evaluate the overall ALREMP and quality assurance management procedures, including compliance with current OPNAV and TYCOM instructions.
 - (1) The Commanding Officer shall be debriefed by the ALREMP Team Leader at the completion of the audit.
 - (2) A formal report listing all discrepancies will be forwarded to the Commanding Officer within fifteen days of the audit completion. A report of corrective actions taken will be submitted to the TYCOM no later than thirty days after receiving the formal audit report. Updates will be submitted monthly until all discrepancies are corrected.
- b. Semi-annually, the TYCOMs will provide the ALRE Program Office PMA 251 with an ALREMP status report detailing their respective carrier's performance. Reports will be used to evaluate overall ALREMP program effectiveness.

16.3 AVIATION CERTIFICATION. Aviation Certification, including ALRE certification, responsibilities, procedures, and waiver guidance are provided in references (d), (e) and (f).

16.4 CARRIER AND FIELD SERVICE UNIT.

- a. Carrier And Field Service Unit (CAFSU) is a branch of the NAVAIRWARCEN Lakehurst, ALRE Fleet Technical Support Competency. The organization is comprised of civilian technicians highly skilled and thoroughly qualified in the operation, maintenance, repair, installation, and testing of both shipboard and shore based ALRE and VLA systems. They are geographically located in field offices to provide instant technical assistance to Fleet personnel and industrial activities throughout the Fleet operating areas. CAFSU Field Offices are located at:

- Naval Aviation Depot, JAX, Norfolk, VA Voyage Repair Team (VRT) Detachment
 - Naval Station, Mayport, FL
 - Naval Aviation Depot North Island, CA
 - Puget Sound Naval Shipyard Bremerton, WA
 - Ship Repair Facility Yokosuka, Japan
 - Supervisor of Shipbuilding Newport News, VA
 - Norfolk Naval Shipyard Portsmouth, VA

- b. The CAFSU Supervisor is located at TYCOM headquarters. Technicians are under the operational control of the Ship Installation Officer, TYCOM (N433/N435). CAFSU functions as the technical representatives of NAVAIR, the TYCOM and NAVAIRWARCEN in all matters which concern launch, recovery, and VLA equipment. CAFSU is required to maintain technical liaison with the above commands and is responsible for the completion of work to the satisfaction of these commands and for providing all interested parties with timely information as required. CAFSU will provide technical assistance during Chief of Naval Operations Maintenance Availabilities and other availabilities, and to ships not in a repair status. All industrial activity repairs, modifications, and operational tests of

shipboard, launching, recovery and VLAs will be monitored by a CAFSU representative. All technical questions concerning the equipment may be directed to the local CAFSU representative. CAFSU shall recommend approval or disapproval of work after consultation with the TYCOM. CAFSU will submit timely written reports concerning repairs, alterations and work accomplished to the Commanding Officer NAVAIRWARCEN for appropriate action and distribution.

16.4.1 Responsibilities.

16.4.1.1 Aircraft Carrier Commanding Officer.

- a. Request CAFSU technical assistance when required, by message, letter, or informal means from the TYCOM. In the case of a formal request direct an information copy to the local CAFSU field office.
- b. Provide appropriate berthing and messing facilities for CAFSU representatives when embarked.
- c. Pass to the TYCOM (N433/N435) any comments concerning meritorious or substandard performance of CAFSU representatives.
- d. Upon completion of the CAFSU assignment at sea, ensure timely departure from the ship.

16.4.1.2 Industrial/Repair Activity.

- a. Provide support to the CAFSU representative, as appropriate to allow for accomplishment of the objectives set forth in paragraph 16.2.2 of this chapter.
- b. Refer technical questions concerning the launching, recovery, and VLA equipment to the local CAFSU representative for timely resolution.

16.5 NAVAL AVIATION DEPOT.

- a. The Naval Aviation Depots maintain and operate facilities to perform:
 - (1) A complete range of industrial level rework operations on designated weapon systems, accessories, and equipment.
 - (2) Manufacturing of parts and assemblies as required.
 - (3) Engineering services in the development of change hardware design.
 - (4) Technical and other professional services for Aircraft Carrier maintenance and logistic problems.
 - (5) Other levels of Aircraft Carrier maintenance for eligible activities upon specific request or assignment.
 - (6) Other functions as directed by NAVAIR.
- b. In order to meet the material support needs of the operating forces, by accomplishment of the above mission, the following specific functions are assigned:
 - (1) Perform depot maintenance functions for aircraft, engines, and their components and accessories. Ground Support Equipment trainers, and training equipment as specified in appropriate Aircraft Maintenance Program directives.
 - (2) Provide engineering, technical, and professional services in support of rework of specific aircraft, engines, aeronautical components, Peculiar Ground Support Equipment, trainers, and training equipment.
 - (3) Perform shipwork designated as Ship Installations Equipment and systems with the same priority as aircraft rework.
 - (4) Serve as the major maintenance, repair, and modification point for assigned missiles.
 - (5) Provide calibration services as assigned by higher authority.

- (6) Perform as the NAVAIR Weapons System Support Officer for the overall management of the NAVAIR Engineering Support Office, Weapon Systems Management Office for assigned weapons, and Integrated Logistic Support Office.
- (7) Perform as a Cognizant Field Activity for assigned aircraft, equipment, and Peculiar Ground Support Equipment.

16.6 NAVAL AVIATION DEPOT VOYAGE REPAIR TEAM.

- a. Naval Aviation Depot Operations Instruction 13800.1 denotes organizational relationships between the TYCOM and the VRT and defines the TYCOM's responsibility, authority for workloading, and operational control of the VRT. Control is exercised through the TYCOM (N433/N435).
- b. To provide industrial level support for Ship Installation Equipment (ALRE) the VRT is used to support the following:
 - (1) Casualty Reports.
 - (2) Enroute maintenance/Underway repairs.
 - (3) Miscellaneous repairs beyond Ship's Force capability.
 - (4) Rotatable spare overhaul.
 - (5) Special reports.
 - (6) Preparation for Overseas Movement repairs.
 - (7) Service Change installations.
 - (8) Modernization/repair of components in conjunction with Chief of Naval Operations Maintenance Availabilities and Planned Maintenance System availabilities.
- c. The capabilities of the VRT are such that almost any task related to launch and recovery equipment is feasible, assuming adequate support from Ship's Force is available. The following ship's support for the VRT is required:
 - (1) Timely Current Ship's Maintenance Project deferral submission for the Maintenance Manager and TYCOM screening/programming.
 - (2) Providing sufficient V-2 Division personnel to assist the team, in such areas as providing forklifts, obtaining necessary parts, gaining machine shop assist and space access, etc.

VOLUME IV
CHAPTER 17
STEAM CATAPULT INSPECTION

REFERENCES.

- (a) OPNAVINST 9220.3 - Propulsion and Auxiliary Plant Inspection and Inspector Certification Program
- (b) NAVSEA S9587-B1-MMA-010 - Catapult Steam Support Systems for CV/CVN Class Ships; Description, Operation and Maintenance
- (c) NWP 1-03.1 - Naval Warfare Publication Operational Report
- (d) OPNAVINST 5100.19 - Navy Occupational Safety and Health (NAVOSH) Program Manual for Forces Afloat
- (e) NAVSEA S9086-CH-STM-030 - NSTM Chapter 074 V3 (Gas Free Engineering)
- (f) NAVSEA S6470-AA-SAF-010 - Gas Free Engineering Manual
- (g) NAVSEA S9086-RK-STM-010 - NSTM Chapter 505 (Piping Systems)
- (h) NAVSEA S9587-AT-MMA-010 - Electronic Controls Charging System Tech Manual

LISTING OF APPENDICES.

- A Sample Catapult Accumulator Inspection Request
- B Sample Inspection Confirmation Letter
- C Summary of Catapult Accumulator Inspection Scheduling and Responsibilities
- D₁ Sample Catapult Accumulator Inspection Report Cover Letter
- D₂ Sample 5 Year Strength and Integrity Catapult Accumulator Inspection Report Cover Letter
- D₃ Sample Other Catapult Accumulator Inspection Report Cover Letter
- E Sample Catapult Accumulator Inspection RBO-Deficiencies Message
- F Sample 30 Day Update Message
- G Sample Catapult Accumulator Rescission Message

17.1 **PURPOSE.** To establish policy and provide procedures and inspection requirements for Steam Catapult Accumulators and support systems including:

- a. Inspection scheduling.
- b. Required preparations.
- c. Inspection guidelines.
- d. Reporting requirements.

17.1.1 **Policy.** Periodic standardized inspections are required of all steam catapult accumulators and associated support systems including steam fill and blowdown systems, feed water fill and drain systems, steam piping and accumulator drain systems, control and indicating systems associated with the fill, pressurization and blowdown of the steam catapult accumulators, and steam supply and drain piping for the trough heating system. Inspections shall be conducted by a certified Steam Generating Plant Inspector (SGPI) and/or Naval Surface Warfare Center, Carderock Division (NSWCCD) Life Cycle Engineering Manager (LCEM), as applicable in accordance with the requirements of reference (a). The maximum interval between inspections and other occasions requiring inspections, as well as responsibilities for continuation and standardization of the inspection program, are formally assigned in reference (a). Specific inspection criteria, attributes and intervals are detailed in reference (b).

17.2 TYPES OF INSPECTIONS.

- a. Routine Inspection.
- b. Pre-start of Availability Inspection (PSAI).
- c. Start of Availability Inspection (SAI).
- d. Strength and Integrity Inspection.

- e. Industrial Support Visit (ISV).
- f. Completion of Availability Inspection (CAI).
- g. Inactivation or Reactivation inspection.
- h. Special Inspections.

17.3 RESPONSIBILITIES.

17.3.1 Naval Sea Systems Command. Naval Sea Systems Command (NAVSEA) shall provide Technical Authority oversight over all steam catapult accumulators and associated equipment. The designated NAVSEA Technical Warrant Holder shall:

- a. Assure safe and reliable system operation.
- b. Set and enforce all technical requirements.
- c. Be the approval authority for all major Departure from Specifications (DFS).
- d. Provide technical oversight and management of the SGPI and NSWCCD LCEM programs.
 - (1) Establish and enforce requirements for SGPI certification and recertification.
 - (2) Ensure periodic SGPI Seminars are conducted.
 - (3) Ensure periodic technical audits of all Integrated Logistics Support documentation and training.
 - (4) Maintain the Steam Catapult Inspection and Repair Management Information System (SCIRMIS).
 - (5) Routinely evaluate and ensure state of the art inspection, maintenance and repair tools and techniques are used.

17.3.2 Naval Surface Warfare Center, Carderock Division.

- a. Provide support to NAVSEA for the SGPI and NSWCCD LCEM programs. Ensure that the required technical documentation to support the SGPI/NSWCCD LCEM Inspector programs is maintained current.
- b. Establish and monitor the requirements and standards for routine and industrial inspections of steam catapult accumulators.
- c. Develop, implement and maintain a program to train and certify NSWCCD LCEM Inspectors in accordance with reference (a).
- d. Ensure that inspection of ships undergoing major overhaul and/or conversion are conducted in accordance with this instruction.
- e. Conduct periodic technical audits of the SGPI Training Course per reference (a).
- f. Provide management of technical data, SCIRMIS accumulator history associated repair management information database system.
- g. Provide technical support to the semi annual SGPI seminars.
- h. Maintain a roster of all Certified SGPIs by name, rating, duty station, date of certification and expiration date of certification. Recommend inspector certification and initiate action to decertify inspectors who fail to comply with the requirements of reference (a).
- i. Ensure that the requirements for SGPI certification, recertification and certification extensions are met prior to final approval.
- j. Conduct PSAI, SAI, ISV, Strength and Integrity Inspections, CAI and Special Inspections as specified in section 17.6 of this chapter and reference (b).

17.3.3 Type Commander.

- a. Provide or arrange for certified SGPIs to perform inspections in accordance with the requirements of reference (b).
- b. Schedule inspections of all catapult accumulators and support systems required by reference (b). Coordinate the inspections with the appropriate technical activities to avoid unnecessary opening of accumulators.
- c. Assist Commanding Officers in arranging for the corrective action of deficient items which are beyond the capability of Ship's Force to perform. Monitor the follow-up action required to correct these deficiencies.
- d. Review the SCIRMIS to ensure deferred inspection deficiencies are entered into the Current Ship's Maintenance Project (CSMP) and are planned/programmed for repair.

17.3.4 Regional Support Group/Regional Maintenance Center/Fleet Maintenance Activity Commanding Officers. Maintenance Activity Commanding Officers shall provide a certified SGPI, when requested by the ship, Immediate Superior in Command (ISIC) or Type Commander (TYCOM), to conduct the accumulator inspections.

17.3.5 Ship Commanding Officer.

- a. Request inspections via Naval Message with the desired primary and alternate dates to the TYCOM with info copies to Cognizant Regional Maintenance Center (RMC) and NSWCCD for accomplishment of the inspections using the format in Appendix A.
- b. Prepare for the scheduled inspections in accordance with references (a) and (b).
- c. Conduct Ship's Force responsible inspections and provide reports required by reference (b).
- d. Review inspection results and initiate corrective action for those deficiencies within Ship's Force capability. Initiate requests for those corrective actions beyond Ship's Force capability. If any discrepancies of paragraph 17.9.2 of this chapter cannot be corrected within 72 hours following completion of the inspection, or if said discrepancies will impact ship's operational schedule, initiate a Casualty Report for the affected catapult accumulator(s) in accordance with reference (c).
- e. Assess the impact of corrective actions (if any) on the ship's operating schedules and advise the TYCOM and operational commanders of any adverse effects.
- f. Submit reports per paragraph 17.7.2 of this chapter.
- g. Schedule catapult accumulator inspections as required by appropriate Planned Maintenance System (PMS)/Class Maintenance Plan items.

17.3.6 Regional Maintenance Center Senior Inspector. RMC Senior Inspector shall:

- a. Ensure all assigned SGPIs maintain current SGPI certificates per reference (a).
- b. Perform catapult accumulator inspections per reference (a).
- c. Review and submit reports per paragraph 17.7.2 of this chapter.
- d. Coordinate inspections in cognizant maintenance areas.
- e. Send inspection confirmation messages using Appendix B of this chapter.
- f. Maintain an up to date list of required catapult accumulator inspections which shall include the latest inspection for all ships assigned to the RMCs in their geographic area of responsibility.

17.3.7 Steam Generating Plant Inspector.

- a. Maintain certification per the requirements of reference (a).
- b. Perform inspections in accordance with the requirements of reference (a), (b) and section 17.9 of this chapter when directed.

- c. SGPIs are part of the technical authority chain-of-command and are accountable to the NAVSEA Technical Warrant Holder for the performance of their inspection duties.

17.4 INSPECTION SCHEDULING. Commands will initiate inspection requests in a timely manner to assist with inspection scheduling coordination. Commands shall ensure inspection scheduling complies with reference (b) and the following:

- a. Commanding Officers/Officers In Charge of ships shall request inspections by message. In addition, OPNAV 4790/2-Kilo shall be submitted to the RMC requesting a certified SGPI/NSWCCD LCEM inspector as required to conduct inspections.
- b. Inspections should coincide with the required routine waterside maintenance.
- c. Inspection services shall be coordinated by geographic areas for optimum utilization of SGPIs/NSWCCD LCEM Inspectors.
- d. The TYCOM may utilize PSAIs and CAIs, which are documented in SCIRMIS to satisfy the pressure vessel portion of a routine inspection. This will reduce the number of catapult accumulator openings. A Routine Inspection will not be considered completed until an SGPI has certified all items required have been accomplished.

17.5 SAFETY PROCEDURES. The safety of personnel must be given the highest priority. Observance of good engineering practices will reduce the frequency of pressure vessel entry.

- a. Ensure idle accumulator condition is accomplished in accordance with the provisions of the Catapult Engineering Operational Sequencing System and reference (b) in preparations for the inspection. Where conflicts occur, an Engineering Operational Sequencing System feedback form should be submitted for resolution.
- b. Ensure the idle catapult accumulator is tagged out (valves wired shut and danger tagged). Observe two-valve protection per Chapter 10 of this volume. Open to the atmosphere the drain connections on all dead interconnecting piping to observe drainage.
- c. Place signs warning at the catapult control console/central charging panel that personnel are working in the accumulator and in conspicuous places in the accumulator room and in rooms containing fill/blowdown isolation valves. The signs shall remain there until the work has been completed and personnel are clear of the secured accumulator.
- d. Ensure all precautions cited in Section 5.3 of reference (b) are followed before entering an accumulator.
- e. Do not enter any part of the accumulator until it has been fully ventilated and certified by a Naval Maintenance Facility Gas Free Engineer/National Fire Protection Agency Marine Chemist as safe for entry. Ensure all safety precautions associated with entry into sealed tanks, voids and/or pressure vessels including gas-free certification are performed in accordance with the requirements of references (d), (e) and (f), as applicable, and Chapter 25 of this volume.
- f. The use of unshielded or non approved lighting in an open accumulator is prohibited. Portable lighting shall be watertight (National Stock Number (NSN) 9S-6230-00-701-2947).
- g. Station an attendant outside the accumulator to provide assistance when any personnel are working inside the accumulator.
- h. Maintain accountability of all items taken into an accumulator. Foreign Material Exclusion closures will be used to the maximum extent practical to prevent tools or other foreign materials from being inadvertently left in the accumulator or associated ship's systems.
 - (1) Personnel entering accumulators will remove all jewelry and empty their pockets of all unnecessary items.
 - (2) Removal of all items and foreign material exclusion closures from the accumulator will be verified and accounted for prior to conducting a final close-out inspection. Final close-out inspection of the catapult accumulator shall be accomplished by the Chief Engineer or his designated representative.

17.6 CATAPULT ACCUMULATOR INSPECTIONS AND REQUIREMENTS. Catapult accumulator inspections conducted in accordance with the requirements of reference (b) shall fulfill all other catapult accumulator inspection requirements. When practical, various inspections should be scheduled for coincidental performance. Appendix C of this chapter is a summary of inspection scheduling and responsibilities.

17.6.1 Routine Inspection. Routine inspections will be conducted at least once every 18 months not to exceed 24 months from its last inspection. For newly constructed ships, the 24 month period shall begin at the completion of the Board of Inspection and Survey Acceptance Trials. The normal interval between routine inspections shall be 18 months. The 18 month period begins with the first warm-up of the catapult accumulator to normal operating temperature and pressure following the previous routine inspection. To provide scheduling flexibility, inspections may be performed as early as 12 months not to exceed 24 months after the previous inspection. Inspections that exceed the 18 month interval will require a minor Departure From Specification to the TYCOM with concurrence from NSWCCD-SSES. Any catapult accumulator which exceeds the inspection interval shall be placed out of commission until inspected by a certified SGPI or a Major DFS is approved by the NAVSEA Technical Warrant Holder to operate beyond 24 months without a Routine inspection.

- a. The catapult accumulator inspection will be scheduled by the TYCOM.
- b. The catapult accumulator inspection will be performed by a certified SGPI.
- c. The TYCOM may utilize PSAIs, CAIs and Strength and Integrity Inspections which are documented in SCIRMIS, to satisfy the pressure vessel portion of a routine accumulator inspection. This will reduce the number of boiler openings. A Routine Inspection will not be considered completed until an SGPI has certified all items required have been accomplished. Once completed, this resets the periodicity required for the next inspection to 18 months not to exceed 24 months.

17.6.2 Pre-Start of Availability Inspection. The PSAI may be required at the discretion of the TYCOM to support early bid specification and work package development.

- a. The PSAI will be scheduled by the TYCOM.
- b. The PSAI will be performed by the NSWCCD LCEM Inspector and an SGPI.

17.6.3 Start of Availability Inspection. The SAI is required to be accomplished at the beginning of an availability to better define or re-evaluate the accumulator bid specification and identify those major repair items which may impact ship's operational schedule.

- a. The SAI will be scheduled by the TYCOM, Industrial Activity or Supervising Activity as applicable.
- b. The SAI will be performed by the NSWCCD LCEM Inspector and an SGPI.

17.6.4 Strength and Integrity Inspection. The normal interval between strength and integrity inspections shall be 60 months. Strength and Integrity Inspections may be conducted as early as 48 months not exceed 72 months after the last Strength and Integrity Inspection to provide flexibility in scheduling. Inspections that exceed the 60 month interval will require a minor DFS to the TYCOM with concurrence from NSWCCD-SSES. Any catapult accumulator which exceeds the inspection interval shall be placed out of commission until inspected by a certified SGPI, or a Major DFS is approved by the NAVSEA Technical Warrant Holder to operate beyond 72 months without a Strength and Integrity Inspection.

17.6.5 Industrial Support Visit Inspection. The ISV inspection shall be scheduled during the availability, but may be waived by the TYCOM for availabilities of short duration.

- a. The ISV inspection will be scheduled by the industrial activity or Supervising Authority, as applicable.
- b. The ISV inspection will be performed by an NSWCCD LCEM Inspector and an SGPI.

17.6.6 Completion of Availability Inspection. The CAI will be conducted prior to final close-out of the catapult accumulator.

- a. The CAI will be scheduled by the industrial activity or Supervising Authority, as applicable, and may be conducted in conjunction with a Routine inspection.
- b. The CAI will be performed by an NSWCCD LCEM Inspector and an SGPI, preferably the same SGPI who conducted the SAI.

17.6.7 Inactivation or Reactivation Inspection. This Inactivation or Reactivation inspection shall use the attributes of a strength and integrity inspection and shall be conducted prior to the final action (in the case of inactivation) unless a strength and integrity inspection has been conducted in the last 18 months. In this instance, the last inspection report may be used to document accumulator lay-up condition. For reactivations, a strength and integrity inspection shall be scheduled by the cognizant activity and conducted by NSWCCD and a cognizant RMC SGPI prior to reactivation of the unit.

17.6.8 Special Inspections. Additional catapult accumulator inspections, arranged by Ship's Force in coordination with the TYCOM and performed by an SGPI, will be conducted in accordance with the requirements of reference (a) whenever the following conditions exist:

- a. Variations in end speed exist. Whenever variations in catapult end speed are experienced, a special inspection will be accomplished by an NSWCCD LCEM Inspector and an SGPI.
- b. Re-inspection of replaced manifold gasket. Whenever the internal steam charging flanged joint gasket is replaced, the joint shall be re-inspected on a not to interfere with operations basis, upon the first cool down following initial operations. This Inspection is accomplished by the Engineering Officer.
- c. Whenever major work as defined below by reference (b) is accomplished, the inspection is arranged by Ship's Force in coordination with the TYCOM and performed by a NSWCCD-SSES LCEM inspector and an SGPI.
 - (1) Repair or adjustments to safety devices or remote isolation devices.
 - (2) Repairs to the accumulator pressure vessel, including nozzles, circumferential welds, shell and head plates, manhole plate and attachment hinge welds which exceed reference (b), section 5.8 criteria.
 - (3) Repairs to or replacement of pressure vessel piping and valves.
 - (4) Repairs to the internal charging manifold.
- d. When the TYCOM desires to assess the material condition, the inspection is arranged by Ship's Force in coordination with the TYCOM and performed by a NSWCCD-SSES LCEM inspector and or an SGPI.

17.7 INSPECTION GUIDELINES AND REPORTS.

17.7.1 Guidelines.

- a. All inspections will be conducted using the requirements of reference (b). The catapult accumulator, including the support systems identified in paragraph 17.1.1 of this chapter will be inspected and the results documented in the SCIRMIS.
- b. Routine Inspection of catapult accumulators and associated systems will be conducted by an SGPI.
- c. All Repair Before Operate (RBO) deficiencies shall be corrected and re-inspected by a certified SGPI or NSWCCD LCEM inspector and preferably the same SGPI/NSWCCD-SSES/LCEM inspector who originally identified the discrepancy prior to warm-up of the catapult accumulator. As RBOs are safety related, all inspector-designated RBO discrepancies discovered in accordance with reference (b) and section 17.9.2 of this chapter shall be corrected prior to catapult operation and reinspected by a certified SGPI or NSWCCD LCEM Inspector, as applicable, and preferably the same SGPI/NSWCCD LCEM Inspector who originally inspected the accumulator. RBO discrepancies include those for which continued unrestricted operation could endanger personnel. RBOs may not be departed via DFS. If there is not an immediate or near future danger to personnel, the discrepancy shall be assigned as SEVERELY DEGRADED with major operational restrictions.
- d. All catapult accumulator related DFSs will be verified by the SGPI during the inspection for conformance with JFMM requirements prior to placing the accumulator into operation.

17.7.2 Reports. The inspector(s) conducting the inspection shall personally debrief and provide a preliminary report of the inspection results to the ship's Commanding Officer (or designated representative) following completion of the inspection. The results shall also be entered into the SCIRMIS database. A copy of the final report will be provided to the TYCOM, Regional Maintenance Center/Fleet Maintenance Activity and NSWCCD no later than 10 days after the completion of all repairs identified during the inspection using the Appendix D₁, D₂ or D₃ cover letter format, as appropriate.

- a. The inspector conducting the inspection shall report RBO deficiencies discovered during the inspection to the TYCOM by message within 24 hours using the format in Appendix E of this chapter.
- b. The SGPI shall report by message to the TYCOM, using the format in Appendices F and G of this chapter, the correction and re-inspection of all RBO deficiencies prior to close-out and warm up of the accumulator.
- c. The ship's Engineering Officer shall report corrected deficiencies, by message, using the format in Appendix F of this chapter within 30 days of the completed inspection and at 30 day intervals thereafter until all deficiencies are corrected.

17.8 CATAPULT ACCUMULATOR INSPECTION PREPARATION.

- a. Demonstrate the performance of the catapult electronic controls, including the uninterruptible power source and the safety devices of the fill and blowdown valves.
- b. Prepare the accumulator in accordance with reference (b) paragraph 5.6.1 for routine inspections and paragraph 5.6.2 for strength and integrity inspections.
- c. Wire shut and danger tag all steam and water valves to the catapult accumulator per the Ship's Tag-Out Instruction and the Tag-Out Users Manual. Post warning signs, PERSONNEL WORKING IN ACCUMULATOR, in accordance with reference (a).
- d. The ship's Engineering Officer shall ensure all Ship's Force responsibilities are complete.

17.9 CATAPULT ACCUMULATOR INSPECTION.

17.9.1 Catapult Accumulator Inspection Forms. Catapult accumulator inspections will be conducted using the appropriate SCIRMIS forms. Include specific comments on the state of preservation and material condition of the accumulator and all support systems.

17.9.2 Catapult Accumulator Inspection Areas. A discrepancy is classified as "Repair Before Operating" if left uncorrected it could cause injury to personnel. All RBO items shall be corrected prior to operation and re-inspected by a certified SGPI or NSWCCD LCEM inspector, as applicable, and preferably the same inspector who originally inspected the accumulator. RBO discrepancies may include but are not limited to the following:

- a. Inoperative/misadjusted safety devices.
- b. Fire/Safety hazards, oil soaked lagging, oil leaks or other fire hazards such as inoperative or missing fire fighting equipment.
- c. Inoperative electronic controls (Fairmont controllers, Smars transmitters, uninterruptible power source).
- d. Non-deferrable defects, defects indications within the pressure vessel boundary.
- e. Ultra-sonic test results of pressure vessel piping that are below minimum requirements, out of periodicity or inspectors discretion of piping of questionable service.
- f. Improperly assembled internal steam charging flanged joint.
- g. Improperly assembled flanged joints (mixed fasteners, undersized flexitallic gaskets, non level in Level I systems).
- h. In-operative system remote isolation devices.
- i. Out of periodicity, in-operative temperature or pressure measuring instruments.
- j. Valve tightness integrity which limits its ability to perform intended function and exceeds the criteria of reference (g).

- k. Non-conformance of electrical safety and deteriorated or damaged wiring or components.

17.9.3 Completion of Inspection. A debrief and a preliminary inspection report, including a summary of restrictive deficiencies, will follow the inspection. Paragraph 17.7.2 of this chapter identifies official reporting requirements.

17.9.4 Automatic Controls Systems Inspection Guidelines. The automatic control system consists of a series of transmitters, controllers, interface devices, control valves and positioners. Inspection, calibration and alignment of this equipment is detailed in reference (h) and applicable system PMS for test and inspection guidelines.

17.9.5 Operating and Casualty Procedures. Each ship with steam catapults will have approved Operating Procedures in the format prescribed by their respective TYCOM. They shall contain detailed procedures and precautions for:

- a. Normal operations including startup and shutdown.
- b. Infrequent operations such as initial charging following an availability.
- c. Operating parameters, limitations, alarms and set points.
- d. Casualty conditions including indications, immediate and supplementary actions.
- e. Quality Assurance requirements for repairs.

APPENDIX A

SAMPLE CATAPULT ACCUMULATOR INSPECTION REQUEST

FM USS (SHIPS NAME AND HULL NO)//
TO (RMC)//
INFO COMNAVAIRPAC SAN DIEGO CA/COMNAVAIRLANT NORFOLK VA (as applicable)//
NAVSURFWARCEN SHIPSYSENGSTA PHILADELPHIA PA//
COMNAVSEASYCOM WASHINGTON DC //

BT

UNCLAS//

MSGID/GENADMIN/ USS (SHIPS NAME HULL NO)//
SUBJ/REQUEST FOR ROUTINE CATAPULT ACCUMULATOR INSPECTION//
REF/A/DOC/COMUSFLTFORCOMINST 4790.3//
AMPN/REF A IS THE JOINT FLEET MAINTENANCE MANUAL//
RMKS/1. PER REF A REQUEST RMC PROVIDE A CERTIFIED SGPI TO
ACCOMPLISH ROUTINE CATAPULT ACCUMULATOR INSPECTION OF (NUMBER
CATAPULT).

2. REQUEST PRIMARY INSPECTION START DATE OF (PROVIDE DATE) AND AN
ALTERNATE START DATE OF (PROVIDE DATE).

3. AWR ENTERED IN SHIP'S CSMP (JSN NUMBER).//

BT

**NOTE: ENSURE MESSAGES ARE IN ACCORDANCE WITH CURRENT MESSAGE FORMAT AND
CURRENT PLAIN LANGUAGE ADDRESS DIRECTORY (PLAD) IS UTILIZED.**

(This Page Intentionally Left Blank)

APPENDIX B

SAMPLE INSPECTION CONFIRMATION LETTER

FM (RMC)//
TO USS (SHIPS NAME AND HULL NUMBER)//
INFO COMNAVAIRPAC SAN DIEGO CA/COMNAVAIRLANT NORFOLK VA (as applicable)//
COMNAVSEASYCOM WASHINGTON DC //
NAVSURFWARCEN SHIPSYSENGSTA PHILADELPHIA PA//
RMC//
BT
MSGID/GENADMIN//
SUBJ/INSPECTION DATE CONFIRMATION//
REF/A/ (INSPECTION REQUEST MESSAGE DTG)//
REF/B//DOC//COMUSFLTFORCOMINST 4790.3//
NARR/REF A IS REQUESTING CATAPULT INSPECTION. REF B IS COMUSFLTFORCOMINST
4790.3 DEFINING CATAPULT INSPECTION CRITERIA AND PROCEDURES.//
POC/ (SENIOR INSPECTOR NAME/ RATE/UIC/LOC: CITY/TEL: DSN//
SUBJ/INSPECTION DATE CONFIRMATION//
RMKS/1 IN RESPONSE TO REF A, A CATAPULT INSPECTION WILL BE CONDUCTED
IAW REF B BEGINNING (DATE) ON NUMBER () CATAPULT. ONE OR MORE OF THE
FOLLOWING CERTIFIED INSPECTORS ARE ASSIGNED TO CONDUCT THE INSPECTIONS.
INSPECTOR/NAME/RATE/LAST FOUR/CLEARANCE.//
BT

**NOTE: ENSURE MESSAGES ARE IN ACCORDANCE WITH CURRENT MESSAGE FORMAT AND
CURRENT PLAD IS UTILIZED.**

(This Page Intentionally Left Blank)

APPENDIX C
SUMMARY OF CATAPULT ACCUMULATOR INSPECTION
SCHEDULING AND RESPONSIBILITIES

Type Inspection	Schedule Date	Scheduling Responsibility	Responsibility for Inspections
Routine	Every 18 Months	TYCOM	Certified SGPI
Start of Availability Inspection	At start of availability with strength and integrity inspection	TYCOM	NSWCCD INSPECTOR and Certified SGPI
Strength and Integrity Inspection	Once every 60 months	TYCOM	NSWCCD LCEM INSPECTOR and Certified SGPI
ISV	During availability	Industrial Activity Supervisory Authority	NSWCCD INSPECTOR and Certified SGPI
CAI	To be conducted prior to final close-out	Industrial Activity Supervisory Authority	NSWCCD INSPECTOR and Certified SGPI
Inactivation or Reactivation	Prior to final action	Industrial Activity Supervisory Authority Inactive Ship Facility	NSWCCD INSPECTOR and Certified SGPI
Special	Variations in end speed	TYCOM	NSWCCD INSPECTOR and Certified SGPI
Special	Replacement of Steam Charging Flange Gasket	Ship's Force	Engineer Officer
Special	Major Repairs/Mechanical casualty	TYCOM	NSWCCD Inspector and Certified SGPI
Engineering Officer	PMS Requirements	Engineering Officer	Engineering Officer

(This Page Intentionally Left Blank)

APPENDIX D₁

SAMPLE CATAPULT ACCUMULATOR INSPECTION REPORT COVER LETTER

From: Commanding Officer, Regional Maintenance Center

To: Commanding Officer, USS (Ship's name and Hull No.)

Subj: Routine Inspection of Catapult(s) Number(s)

Ref: (a) COMUSFLTFORCOMINST 4790.3, Joint Fleet Maintenance Manual

(b) NAVSEA S9587-B1-MMA-010, Catapult Steam Support System CV/CVN Class Ships; Description, Operation and Maintenance

Encl: (1) Catapult Inspection Report of Catapult(s) Number(s)

(2) Catapult Operational Test sheets (Figure 5-5 of Ref (b))

1. (Parent Command) Steam Generating Plant Inspector(s) (Inspector's Name) inspected Catapult(s) Number(s) in USS (Ships Name and Hull No) on (date) while (ship's location).

2. Discrepancies, which require corrective action, are outlined in enclosures (Number of Enclosures).

3. Catapult operational test results are outlined in (Number of Enclosure).

4. Advance copies of Enclosure(s) have been delivered to the Ship's Commanding Officer.

5. (Command) point of contact is (Senior Inspector), Code (Number), commercial telephone (Number), DSN (Number) e-mail address is: (Address).

COPY TO (W/ENCL):

CNAP/CNAL N43 (as applicable)

USS (Name Hull Number)

COPY TO (W/O ENCL):

NSWCCD-SSES (C922)

(This Page Intentionally Left Blank)

APPENDIX D₂

**SAMPLE 5 YEAR STRENGTH AND INTEGRITY CATAPULT ACCUMULATOR INSPECTION
REPORT COVER LETTER**

From: Commanding Officer, Regional Maintenance Center

To: Commanding Officer, USS (Ship's name and Hull No.)

Subj: 5 Year Strength and Integrity Inspection of Catapult(s) Number(s)

Ref: (a) COMUSFLTFORCOMINST 4790.3, Joint Fleet Maintenance Manual

(b) NAVSEA S9587-B1-MMA-010, Catapult Steam Support System CV/CVN Class Ships; Description, Operation and Maintenance

Encl: (1) Catapult Inspection Report of Catapult(s) Number(s)

(2) Catapult Operational Test sheets (Figure 5-5 of Ref (b))

1. NSWCCD-SSES Inspector(s) (Inspector's Name) inspected Catapult(s) Number(s) in USS (Ship's Name and Hull No.) on (date) while (ship's location).
2. Discrepancies, which require corrective action, are outlined in enclosures (Number of Enclosures).
3. Catapult operational test results are outlined in (Number of Enclosure).
4. Advance copies of enclosure(s) have been delivered to the Ship's Commanding Officer.
5. NSWCCD-SSES point of contact is (Senior Inspector), Code (Number), commercial telephone (Number), DSN (Number) e-mail address is: (Address).

COPY TO (W/ENCL):

CNAP/CNAL N43 (as applicable)

USS (Name Hull Number)

COPY TO (W/O ENCL):

NSWCCD-SSES (C922)

(This Page Intentionally Left Blank)

APPENDIX D₃

SAMPLE OTHER CATAPULT ACCUMULATOR INSPECTION REPORT COVER LETTER

From: Commanding Officer, Regional Maintenance Center

To: Commanding Officer, USS (Ship's name and Hull No.)

Subj: (Special, etc.) Inspection of Catapult(s) Number(s)

Ref: (a) COMUSFLTFORCOMINST 4790.3, Joint Fleet Maintenance Manual

(b) NAVSEA S9587-B1-MMA-010, Catapult Steam Support System CV/CVN Class Ships; Description, Operation and Maintenance

Encl: (1) Catapult Inspection Report of Catapult(s) Number(s)

(2) Catapult Operational Test sheets (Figure 5-5 of Ref (b))

1. (Parent Command) Steam Generating Plant Inspector(s) (Inspector's Name) inspected Catapult(s) Number(s) in USS (Ship's Name and Hull No.) on (date) while (ship's location).
2. Discrepancies, which require corrective action, are outlined in enclosures (Number of Enclosures).
3. Catapult operational test results are outlined in (Number of Enclosure).
4. Advance copies of enclosure(s) have been delivered to the Ship's Commanding Officer.
5. (Command) point of contact is (Senior Inspector), Code (Number), commercial telephone (Number), DSN (Number) e-mail address is: (Address).

COPY TO (W/ENCL):

CNAP/CNAL N43 (as applicable)

USS (Name Hull Number)

COPY TO (W/O ENCL):

NSWCCD-SSES (C922)

(This Page Intentionally Left Blank)

APPENDIX E

**SAMPLE CATAPULT ACCUMULATOR INSPECTION
RBO/SEVERELY DEGRADED DEFICIENCIES MESSAGE**

FM Commander, Regional Maintenance Center//
 TO USS (Ship Name and Hull Number)//
 INFO COMNAVAIRPAC SAN DIEGO CA/COMNAVAIRLANT NORFOLK VA (as applicable)//
 NAVSURFWARZEN SHIPSYSENGSTA PHILADELPHIA PA//
 PEO CARRIERS WASHINGTON DC//
 (REPAIR ACTIVITY)/(Code)//
 COMNAVSEASYS COM WASHINGTON DC//
 BT
 UNCLASS//N09537//
 MSGID/GENADMIN/(REGIONAL MAINTENANCE CENTER/CODE) //
 SUBJ/(Type) INSPECTION REPAIR BEFORE OPERATE (RBO) DEFICIENCIES OF NUMBER ()
 CATAPULT ABOARD USS (Ship Name Hull Number)//
 REF/A/DOC/COMUSFLTFORCOMINST 4790.3//
 REF/B/DOC/OPNAVINST 4790.4//
 NARR/REF A IS JOINT FLEET MAINTENANCE MANUAL VOLUME IV CHAPTER 17 AND
 PROVIDES GUIDANCE FOR CATAPULT INSPECTIONS. REF B IS 3-M MANUAL AND
 PROVIDES GUIDANCE FOR CSMP DOCUMENTATION.//
 POC/(Senior Inspector) (UIC)/LOC: (City, State)/TEL:(Number)/TEL:DSN (Number)//
 RMKS/1. CATAPULT NUMBER (s) ROUTINE/STRENGTH AND INTEGRITY (AS
 APPROPRIATE) INSPECTION CONDUCTED (DATE) BY (INSPECTORS NAME) WHILE
 (SHIPS LOCATION). RBO DEFICIENCIES AND PROPOSED CORRECTIVE ACTION ARE
 REPORTED IAW REF A AS FOLLOWS:
 (SCIRMIS ITEM NO, DEFICIENCY, REPAIR, ETC)
 A.
 B.
 C.
 2. CATAPULT NUMBER() SHALL NOT BE OPERATED UNTIL ALL ABOVE LISTED
 DEFICIENCIES ARE CORRECTED AND A REINSPECTION IS CONDUCTED IAW REF A.
 3. SEVERLY DEGRADED DEFICIENCIES AND PROPOSED CORRECTIVE ACTION ARE REPORTED IAW
 REF A AS FOLLOWS:
 A.
 B.
 C.
 4. SEVERELY DEGRADED DEFICIENCIES ARE REQUIRED TO BE CORRECTED PRIOR TO CATAPULT
 CHARGING OR MUST BE SUBMITTED FOR MAJOR DEPARTURE FROM SPECIFICATION (DFS).
 5. IAW REF A DEFICIENCIES COMPLETED SHALL BE REPORTED EVERY 30 DAYS USING THE
 GUIDANCE PROVIDED IN REF A APPENDIX F.//
 BT
**NOTE: ENSURE MESSAGES ARE IN ACCORDANCE WITH CURRENT MESSAGE FORMAT AND
 CURRENT PLAD IS UTILIZED.**

(This Page Intentionally Left Blank)

APPENDIX F

SAMPLE 30 DAY UPDATE MESSAGE

FM USS (SHIP'S NAME AND HULL NO)//
TO (RMC)//
INFO COMNAVAIRPAC SAN DIEGO CA/COMNAVAILANT NORFOLK VA (as applicable)//
NAVSURFWARCEN SHIPSYSENGSTA PHILADELPHIA PA//
COMNAVSEASYS COM WASHINGTON DC//
TYCOM//
BT
MSGID/GENADMIN/USS (SHIPS NAME AND HULL NO)//
SUBJ/ USS (SHIP'S NAME AND HULL NO.) NR () CATAPULT ACCUMULATOR INSPECTION.//
REF/A/DOC/SCIRMIS REPORT FROM (RMC AND DATE)//
REF/B/DOC/COMUSFLTFORCOMINST 4790.3//
REF/C/DOC/OPNAVINST 4790.4//
NARR/REF A IS SCIRMIS REPORT FROM COMMANDER (RMC). REF B IS
COMUSFLTFORCOMINST 4790.3 JOINT FLEET MAINTENANCE MANUAL AND PROVIDES
GUIDANCE FOR CATAPULT INSPECTIONS. REF C IS OPNAVINST 4790.4 3-M
MAINTENANCE MANUAL AND PROVIDES DIRECTION FOR CSMP DOCUMENTATION.//
RMKS/ NR () CATAPULT(S) ROUTINE INSPECTION WAS CONDUCTED
(DATE) BY (SGPI INSPECTOR NAME) ITEMS CORRECTED ARE REPORTED IAW REF B AS
FOLLOWS.
1. (CATAPULT NUMBER)
2. SCIRMIS ITEM (I.E., A41/01) JOB SUBMITTED JSN (NUMBER).//
BT

**NOTE: ENSURE MESSAGES ARE IN ACCORDANCE WITH CURRENT MESSAGE FORMAT AND
CURRENT PLAD IS UTILIZED.**

(This Page Intentionally Left Blank)

APPENDIX G

SAMPLE CATAPULT ACCUMULATOR RESCISSION MESSAGE

FM RMC//
TO USS (SHIPS NAME AND HULL NO)//
INFO/COMNAVAIRPAC SAN DIEGO CA/COMNAVAIRLANT NORFOLK VA (as applicable)//
USS (SHIPS NAME AND HULL NO)//
NAVSURFWARCEN SHIPSYSENGSTA PHILADELPHIA PA//
PEO CARRIERS WASHINGTON DC//
COMNAVSEASYS COM WASHINGTON DC//

BT

//SUBJ/USS (SHIPS NAME AND HULL NUMBER) NUMBER ()CATAPULTS/REPAIR
BEFORE OPERATE (RBO) RESCISSION// REF/A/ (ORIGINATING RBO MESSAGE DTG)//
NARR/REF A ADDRESSES RBO DEFICIENCIES FOUND DURING STEAM CATAPULT
INSPECTIONS CONDUCTED ON (Date)//

RMKS/1. REF A RESTRICTIONS RESCINDED BASED UPON RE-INSPECTION.
2. FOR FURTHER INFO, CONTACT UNCLASSIFIED E-MAIL (Senior Inspector).//

BT

**NOTE: ENSURE MESSAGES ARE IN ACCORDANCE WITH CURRENT MESSAGE FORMAT AND
CURRENT PLAD IS UTILIZED.**

(This Page Intentionally Left Blank)

VOLUME IV
CHAPTER 18
SUBMARINE SALVAGE INSPECTION

REFERENCES.

- (a) NWP 1-03.1 - Naval Warfare Publication Operational Report

LISTING OF APPENDICES.

- A SSN 21 Class Submarine Salvage Inspection Check-Off List
 B SSN 688 Class Submarine Salvage Inspection Check-Off List
 C SSBN/SSGN 726 Class Submarine Salvage Inspection Check-Off List
 D SSN 774 Class Submarine Salvage Inspection Check-Off List
 E Sample Pre-Inspection Information/Certification
 F Sample Report of Salvage Inspection Forwarding Letter

18.1 **PURPOSE.** To ensure the continued readiness and quality of maintenance performed on submarine rescue and salvage equipment.

18.2 INSPECTIONS.

18.2.1 **Periodicity.** The readiness of submarine rescue and salvage equipment is determined by periodic salvage inspections. Salvage inspections will be conducted within a 72 month interval, or as listed below:

- a. Whenever requested by the submarine.
- b. Prior to initial builder's trials for new construction ships, prior to initial sea trials for ships in Chief of Naval Operations (CNO) Maintenance Availabilities, and prior to initial sea trials for ships in Interim Dry Docking.
- c. A partial salvage inspection will be completed for all items worked during an availability (i.e., hatches, salvage air valves, etc.).
- d. Once **every five years for SSBNs/SSGNs.**
- e. Prior to Sea Trials for repairs of damage from collision or grounding where deformation is observed to be in the hull integrity envelope or supporting structure.

18.2.2 **Procedures and Reports.** The specific rescue and salvage items to be inspected and the type of submarines to which they are applicable are identified in Appendices A through D of this chapter. Appendix E of this chapter is a sample pre-inspection form to be completed by the submarine prior to the salvage inspection. Appendix F of this chapter is a sample Submarine Salvage Inspection forwarding letter. Inspection attributes or elements of Appendices A through D may not be locally waived or have equipment substituted. Temporary changes to the attributes or elements of Appendices A through D will only be revised by the Type Commander (TYCOM) and the revision must be documented in formal correspondence. Any attributes or elements of Appendices A through D as applicable to the respective ship class not met or which fails inspection is underway limiting until corrected or waived by the TYCOM.

NOTE: IF NO QUALIFIED INSPECTORS ARE AVAILABLE, CONTACT THE TYPE COMMANDER FOR DIRECTION.

18.2.3 **Inspection Resources.** The hatch and watertight door portion of this inspection will be conducted by members of the local Ship's Maintenance Monitoring Support Performance Monitoring Team (PMT) (i.e., personnel who have successfully completed Submarine Structural Closure Inspection course or personnel designated by NAVSEA). Other portions of the inspection should be conducted by personnel who, by their rate and experience, are qualified in that particular section. Inspection teams are to be assembled, as required, from the following sources in order of the priority shown:

- a. Undersea Rescue Commands.
- b. Submarine Fleet Maintenance Activities.
- c. Immediate Superior In Command (ISIC) Staffs.
- d. Submarines of the same class.
- e. Other submarines.
- f. Salvage ships (ARS).

18.3 RESPONSIBILITIES. Responsibility for the preparation, conduct, and completion reporting for a salvage inspection is as follows:

18.3.1 Immediate Superior In Command.

- a. Schedule salvage inspections for assigned submarines as specified in paragraph 18.2.1 of this chapter. The inspection should be conducted early enough in the availability to allow for the correction of deficiencies prior to Fast Cruise.
- b. Designate the inspecting team using the guidance provided in paragraph 18.2.3 of this chapter to conduct the salvage inspection.

18.3.2 Commanding Officer/Officer In Charge.

- a. Request the ISIC to conduct a salvage inspection in accordance with the periodicity set forth in paragraph 18.2.1 of this chapter.
- b. Coordinate support requirements as may be needed by the inspecting team to fulfill the requirements of the applicable Appendix of this chapter.

NOTE: HATCHES THAT ARE FOULED WILL PREVENT THE SATISFACTORY COMPLETION OF THIS INSPECTION. COORDINATION BETWEEN THE SHIP, INSPECTING TEAM AND MAINTENANCE ACTIVITY IS THE RESPONSIBILITY OF THE COMMANDING OFFICER/OFFICER IN CHARGE.

- c. Complete and forward a pre-inspection information letter to the Senior Inspecting Officer using the sample provided in Appendix E of this chapter as a guideline. Modify Appendix E as necessary to align required attributes with the applicable class-specific checklist.
- d. Assemble all ship's data indicated in the applicable Appendix of this chapter prior to the inspection for ease of reference by the inspecting team.
- e. Upon receipt of the Senior Inspecting Officer's report, take action to correct the discrepancies found and report by letter or message their corrections to the ISIC with a copy to the TYCOM and Supervising Authority (when assigned) prior to commencement of Fast Cruise.
- f. Submit a Casualty Report (CASREP), if applicable, in accordance with reference (a) for each item which degrades the Submarine Rescue Chamber (SRC) and/or Submarine Rescue Diving Recompression System (SRDRS) capability.

18.3.3 Senior Inspecting Officer.

- a. Assemble the inspecting team designated by the ISIC.
- b. Conduct the salvage inspection in accordance with the applicable Appendix of this chapter. Ensure Appendix E of this chapter is received prior to commencement of the inspection. The inspection should be completed at least 14 days prior to commencement of Fast Cruise, or for new construction ships and ships in a CNO Maintenance Availability, at least 28 days and no sooner than 60 days, prior to the scheduled commencement of Sea Trials. This examination should normally be performed close to Phase I crew certification, if possible.
- c. At the completion of the salvage inspection, report the following to the Commanding Officer/Officer In Charge of the inspected ship:

- (1) Completion of the inspection. When ships are in a CNO availability, the shipyard and the Project Team must be formally notified of the scheduled date of the Salvage Inspection and any deficiencies identified.
 - (2) Which, if any, systems or equipment have not been restored to normal operating conditions (due to maintenance or required repairs, etc.).
 - (3) That an advance copy of the inspection results has been provided to the ship to facilitate early correction of deficiencies found.
- d. Submit the inspection report to the Commanding Officer/Officer In Charge of the inspected ship in the format of Appendix F of this chapter within three working days following the completion of the inspection, with a copy to the cognizant ISIC.

(This Page Intentionally Left Blank)

APPENDIX A
SSN 21 CLASS SUBMARINE SALVAGE INSPECTION
CHECK-OFF LIST

General Information

1. Items pertaining to rescue vehicle seating surfaces and buoy cable angle tests require substantial support equipment and are designated for industrial activity accomplishment.
2. Configuration differences are noted as comments in the reference column.
3. Portions of the Salvage Inspection (as specified by the maintenance activity) may be conducted prior to the start of CNO availabilities as “pre-availability inspections” to support planning of the availability. These items need not be re-inspected provided no work was performed during the availability which affects their status. When specified, these items will be performed by Ship’s Force and written certification by the Commanding Officer provided to the maintenance activity, the ISIC and the Senior Inspecting Officer.
4. The user is directed to use the most current revision of the Planned Maintenance System (PMS) maintenance requirement.

PART I: SALVAGE

INSPECTION TEAM (SSN 21 CLASS)	Reference Note	Sat	Unsat	Submarine Inspector Signature	Inspection Team Member Signature
<p>1. <u>Salvage Drawings:</u></p> <p style="padding-left: 20px;">a. Verify salvage drawings:</p> <p style="padding-left: 40px;">(1) Have been updated during ship’s new construction period/last CNO Maintenance Availability or</p> <p style="padding-left: 40px;">(2) Latest revision is identified in ship’s plan index.</p> <p style="padding-left: 40px;">(3) Have correct distribution.</p> <p style="padding-left: 40px;">(4) Are identified as Selected Record Drawings</p> <p>2. <u>High/Low Salvage Connections:</u></p> <p style="padding-left: 20px;">a. Verify deck touch plate markings are installed and per plan.</p> <p style="padding-left: 20px;">b. Check that each valve is free to operate with the inspecting command’s salvage wrench.</p>	<p>Navy Modernization Process Management and Operations Manual NAVSEA SL720-AA-MAN-030</p> <p>Ship Dwg. Consolidated Index Number 594 or 845</p> <p>Ship’s Plans</p> <p>Notes 1 and 2</p>				

An asterisk (*) will be used in addition to a check mark (✓) in the unsat column to identify any exceptions. An explanation of the exception will be provided with the Salvage Inspection Report, Appendix F of this chapter.

PART II: DISABLED SUBMARINE (DISSUB) 7-DAY SURVIVAL, ESCAPE AND RESCUE

INSPECTION ITEM (SSN 21 CLASS)	Reference Note	Fwd		Aft		Submarine Inspector Signature	Inspection Team Member Signature
		Sat	Unsat	Sat	Unsat		
<p>1. <u>Submarine Rescue Chamber (SRC)/Submarine Rescue Diving and Recompression System (SRDRS) Fittings:</u></p> <p>a. Verify four rescue vehicle holddown sockets are installed per plan or authorized alteration on all escape trunk seating surfaces. From one socket per hatch, remove capscrew and plug; demonstrate guide is free. (SSN 23 and SSN 21 Class with S/A 4274.) Verify 4 padeyes installed for rescue vehicle in upper hatch free flood areas (SSN 21 Class prior to S/A 4274).</p> <p>b. Remove plug from hatch fairing. Check condition of SRC downhaul shackle. Verify downhaul shackle is free of corrosion and can be operated by hand. Use of plastisol on downhaul shackle is not authorized as it prevents visual inspection of shackle for corrosion and promotes corrosion. The shackle must be powder coated white.</p> <p>c. AN/BQN-13.</p> <p>(1) Inspect AN/BQN-13 Beacon to ensure that:</p> <p>(a) Cable is free of abrasions, cuts or damage.</p> <p>(b) Cable plug and encapsulation are free of defects.</p> <p>(c) Unit has no physical damage.</p> <p>(d) Transducer is free of oil leaks, bubbles and paint.</p> <p>(2) Verify from ship's records that all applicable AN/BQN-13 PMS has been performed and witness satisfactory performance of all procedures (except R-1).</p> <p>(3) Inventory allowance of spare batteries for AN/BQN-13. Ensure shelf life of batteries has not been exceeded.</p>	<p>Naval Ships' Technical Manual (NSTM) S9086-T9-STM-010 Chapter 594</p> <p>Ship's Plans Note 8</p> <p>Ship's Plans Note 8</p> <p>MIP SO-104/902</p> <p>Ship's COSAL Note 9</p>						

An asterisk (*) will be used in addition to a check mark (✓) in the unsat column to identify any exceptions. An explanation of the exception will be provided with the Salvage Inspection Report, Appendix F of this chapter.

INSPECTION ITEM (SSN 21 CLASS)	Reference Note	Fwd		Aft		Submarine Inspector Signature	Inspection Team Member Signature
		Sat	Unsat	Sat	Unsat		
<p>2. <u>Escape Trunks, Logistics Escape Trunks and Forward Lockout Trunks:</u></p> <p>a. Escape trunk hatch fairings must be maintained in a condition to be easily disassembled to support submarine rescue. Verify Planned Maintenance has been completed within the required periodicity on all escape trunk hatches. Visually inspect escape trunk hatch fairings for compliance with the specifications called out in MRC HOQN. Paint fouling or corrosion of fairing fasteners must be immediately corrected. Demonstrate the ability to remove one fastener in each fairing piece required to be removed in the fairing disassembly procedure.</p> <p>b. Demonstrate that each access hatch operates satisfactorily with all respects of locking/unlocking, opening/shutting from below/above (with salvage wrench/handwheel as applicable).</p> <p>c. Demonstrate that each access hatch can be opened with 5th percentile swing force operability criteria for surfaced emergency egress (SSN 23 and SSN 21 Class with S/A 4149).</p> <p>d. Demonstrate satisfactory operation of the escape hatch closing mechanisms in accordance with the installed instruction plates and equipment.</p> <p>(1) Demonstrate satisfactory installation of Improved Powered Hatch Operator with intensifier and compensator as one mode of hatch operation of Logistics Escape Trunks (SSN 23 and SSN 21 Class with S/A 4149).</p> <p>(a) Verify inventory of all parts.</p> <p>(b) Verify periodic pressure testing of hoses.</p> <p>(c) Verify proper operation of sensing line and trunk gage.</p>	<p>Note 10</p> <p>MIP 1671/921MR C HOQN</p> <p>Ship's Drawing MIP 1671/921 MRCs E4PH, E4PK</p>						

An asterisk (*) will be used in addition to a check mark (✓) in the unsat column to identify any exceptions. An explanation of the exception will be provided with the Salvage Inspection Report, Appendix F of this chapter.

INSPECTION ITEM (SSN 21 CLASS)	Reference Note	Fwd		Aft		Submarine Inspector Signature	Inspection Team Member Signature
		Sat	Unsat	Sat	Unsat		
<p>(d) Verify assembly of intensifier and gearbox to upper hatch operator.</p> <p>(e) Verify installation of upper hatch operator compensator.</p> <p>(f) Demonstrate satisfactory operational check of intensifier pump and gears.</p> <p>e. Demonstrate satisfactory operation and examine the condition of the following equipment:</p> <p>(1) Vent valves (trunk and compartment).</p> <p>(2) Blow valves (trunk and compartment).</p> <p>(3) Flood and drain valves (including remote operation mechanisms and strainer installations).</p> <p>(4) Demonstrate satisfactory operation and examine the condition of the following equipment: Conduct Hood Inflation System/Stole Charging Valve operational check to confirm valves operate properly and verify watertight caps installed.</p> <p>(5) Pressure proof lights checked to ensure correct globe sealing, and verified that globe is free from cracks.</p> <p>(6) Electric lantern screened lenses and pressure relief hole sealed with plastic (MIL-I-3064) and mounted above waterline.</p> <p>(7) 31MC installed above waterline.</p> <p>(8) Verify accomplishment of PMS to clear sea pressure sensing lines.</p> <p>f. Verify the following equipment installed:</p> <p>(1) Diver's knife.</p> <p>(2) Ballpeen hammer.</p> <p>(3) Persuader (crows foot).</p>	<p>MIP 5940/905, MRC 7DKE</p> <p>MIP 5641/921 MRC F3XS, F3XT</p> <p>Note 11</p> <p>Note 11</p>						

An asterisk (*) will be used in addition to a check mark (✓) in the unsat column to identify any exceptions. An explanation of the exception will be provided with the Salvage Inspection Report, Appendix F of this chapter.

INSPECTION ITEM (SSN 21 CLASS)	Reference Note	Fwd		Aft		Submarine Inspector Signature	Inspection Team Member Signature
		Sat	Unsat	Sat	Unsat		
<p>g. Check Flood Line Orifice Size (For SSN 23 and SSN 21 Class after S/A 4149, orifice size is 1.37" for initial trials only.)</p> <p>h. Verify valve handwheels are properly color coded and labeled in accordance with Ship's Drawing Index, Ship's placards and Posted Information Plates.</p> <p>i. Verify gages are in calibration as indicated on calibration label.</p> <p>j. Verify upper watertight hatch cavity drain valve operation is satisfactory.</p> <p>k. Witness satisfactory rigging and operation of escape trunk portable skirt, verify ability to remove the bubble skirt with the upper hatch shut within 5 minutes without the use of tools. (N/A if A&I N3486 has been accomplished.)</p> <p>3. <u>Emergency Communications Equipment:</u></p> <p>a. Inventory allowance of the following equipment and confirm proper stowage as indicated:</p> <p>(1) SEPIRB Model T-1630/SRT (2 FWD, 2 aft with Launch Hardware each compartment).</p> <p>b. Verify from ship's records that all applicable PMS has been performed and witness satisfactory performance of indicated MRCs.</p> <p>(1) SEPIRB.</p> <p>4. <u>Life Saving and Safety Equipment:</u></p> <p>a. Inventory allowance (randomly, type and quantity as applicable) and witness satisfactory performance of PMS procedures on the following: (PMS procedures are to be demonstrated on one representative candidate from each of the sub groups listed below).</p>	<p>Installed</p> <p>NSTM S9086-RK-STM-010 Chapter 505</p> <p>Ship's Plans</p> <p>Ship Configuration and Logistics Support Information System (SCLSIS) & COSAL</p> <p>AEL 7-00000A434</p> <p>MIP 4413/015</p> <p>Ship's COSAL Note 12</p>						

An asterisk (*) will be used in addition to a check mark (✓) in the unsat column to identify any exceptions. An explanation of the exception will be provided with the Salvage Inspection Report, Appendix F of this chapter.

INSPECTION ITEM (SSN 21 CLASS)	Reference Note	Fwd		Aft		Submarine Inspector Signature	Inspection Team Member Signature
		Sat	Unsat	Sat	Unsat		
(1) Life preservers.	MIPs 5832/SUB and 5832/030						
(2) Man overboard bag.	Note 13 MIP 5832/021						
(3) Qualified swimmer designated for man overboard.	Note 14 MILPERS MAN Art. 1414-010 Series						
(4) Safety harness (belts).	MIP 6231/001 MRC 2EA0						
(5) Safety track.	MIP 6111/R06 NAVSEA Dwg. 612-6408578						
(6) Distress marker lights.	MIP 5832/010						
(7) Life lines and stanchions.	MIP 6121/SUB						
(8) SEIE Suits.	MIP 5940/005						
(9) Crash Bags.	MIP 5940/005, MRC 1SC3 and AEL 2-330023072						
(10) Guard Book (Stored in same locker as Crash Bag).	Latest Revision per AEL 2-330023072						
(11) OP 61-1.							
(12) OI 638-3 (Not applicable to SSN23)							
(13) OI 638-4.							
5. <u>Escape Training:</u>							
a. Verify that all hands are trained in SEIE escape.							
6. <u>DISSUB 7-Day Survival:</u>	Note 8.						
a. Portable desalinators (2 FWD & 2 aft)	AEL 2-360033003						
(1) Verify Portable desalinator PMS has been completed within required periodicity.	MIP 5940/003						
b. <u>Atmosphere Control:</u>							
(1) Inventory quantity onboard and inspect condition of the following:							

An asterisk (*) will be used in addition to a check mark (✓) in the unsat column to identify any exceptions. An explanation of the exception will be provided with the Salvage Inspection Report, Appendix F of this chapter.

INSPECTION ITEM (SSN 21 CLASS)	Reference Note	Fwd		Aft		Submarine Inspector Signature	Inspection Team Member Signature
		Sat	Unsat	Sat	Unsat		
<p>(a) CO₂ absorbent canisters.</p> <p>Amount onboard for DISSUB FWD: _____ Aft: _____</p> <p>Amount onboard for NON-DISSUB: _____</p> <p>Required _____</p> <p>Comment on condition and ship's record for DISSUB/NON-DISSUB segregation: _____</p>	<p>AELs 2-3300230 or 2-3300232 series for LiOH product.</p> <p>NON-DISSUB; (e.g., for CO-H₂ After-filter & DQA</p> <p>Note 15</p>						
<p>(b) DISSUB LiOH Deployment Kits.</p> <p>Amount onboard _____ FWD: _____ Aft: _____</p> <p>Required: _____</p> <p>Comment on condition _____</p>	<p>AEL 2-330023035 or 2-330023205 for LiOH Deploy Kits</p> <p>Note 16</p>						
<p>(c) O₂ candles.</p> <p>Amount onboard for DISSUB: FWD: _____ Aft: _____</p> <p>Amount onboard for NON-DISSUB: _____</p> <p>Required: _____</p> <p>Comment on condition and ship's record for DISSUB/NON-DISSUB segregation: _____</p>	<p>AEL 1-230013100</p> <p>NON-DISSUB - e.g., for O₂ generator or Low Pressure Electrolyzer (LPE) backup.</p> <p>Note 17</p>						

An asterisk (*) will be used in addition to a check mark (✓) in the unsat column to identify any exceptions. An explanation of the exception will be provided with the Salvage Inspection Report, Appendix F of this chapter.

INSPECTION ITEM (SSN 21 CLASS)	Reference Note	Fwd		Aft		Submarine Inspector Signature	Inspection Team Member Signature
		Sat	Unsat	Sat	Unsat		
<p>(d) O₂ candle furnace. Candle furnaces onboard: FWD: _____ Aft: _____ Required: _____ Comment on condition (include location - FWD and/or aft compartments). _____</p> <p>(e) Emergency Air Breathing masks (test random 5% for proper operation per applicable MRC).</p> <p>(2) Verify CO₂ absorbent canister PMS has been completed within required periodicity. Additionally, randomly select 10% of canisters onboard and weigh them in accordance with the applicable MRC.</p> <p>(3) Inspect ten percent per compartment of emergency air breathing manifold in-line filters and filter housing for presence of corrosion.</p> <p>c. <u>Atmosphere Monitoring:</u></p> <p>(1) Inventory quantity onboard and inspection condition of the following:</p> <p>(a) DISSUB O₂/CO₂ Gas Monitors (Analox). Amount onboard (include location) _____ Required: (minimum) <u>1 FWD, 1 aft compartment</u></p> <p>(2) Verify Analox PMS has been completed within required periodicity.</p> <p>(3) Inventory allowance of spare batteries for Analox. Ensure shelf life of batteries has not been exceeded.</p> <p>7. <u>Launchers:</u></p> <p>a. Demonstrate satisfactory operation of each launcher manually and hydropneumatically as applicable.</p>	<p>Ship's COSAL</p> <p>Note 18</p> <p>Ship's COSAL MIP 5519/600 MRC G8CL</p> <p>MIP 5151/001 MRC B6CW</p> <p>AEL: 2-870003101 Stored in same locker as Crash Bag</p> <p>MIP 5940/002 MRC 9TFF</p> <p>NSN 6135-01-538-3507 (4 FWD, 4 aft)</p>						

An asterisk (*) will be used in addition to a check mark (✓) in the unsat column to identify any exceptions. An explanation of the exception will be provided with the Salvage Inspection Report, Appendix F of this chapter.

INSPECTION ITEM (SSN 21 CLASS)	Reference Note	Fwd		Aft		Submarine Inspector Signature	Inspection Team Member Signature
		Sat	Unsat	Sat	Unsat		
b. Verify a minimum of six Red Submarine Emergency Identification Signals and Submarine Floating Signal pyrotechnics stowed in compartment with launcher. c. Operational verification shall include a demonstrated launch (water slug) from both remote and local operating stations.							

An asterisk (*) will be used in addition to a check mark (✓) in the unsat column to identify any exceptions. An explanation of the exception will be provided with the Salvage Inspection Report, Appendix F of this chapter.

NOTES
(SSN 21 CLASS)

1. All high/low salvage valves are to be tested for freedom of operation at the frequency specified, except during the salvage inspection conducted incident to an overhaul. Salvage Air valve testing completed up to one year prior to the start of an availability will satisfy the salvage inspection requirements provided that certified records verifying the tests are available. Written certification by the Commanding Officer that specified external salvage valves have been overhauled by the industrial activity or Ship's Force and have been successfully hydrostatically tested will constitute certification that the valve operates freely, providing all inspections (Part I, items 2.b. and 2.c. of this Appendix) for each valve so certified are satisfactory. If the results of the inspection of operating gear are not satisfactory, or doubt exists concerning freedom of operation, the specific valves in question shall be checked. Provide appropriate container for collecting anti-freeze drained from salvage piping when hull valve is cycled. Ensure controlled re-assembly in accordance with Quality Assurance requirements is performed when installing salvage caps. Exercise caution to prevent liquid in salvage air piping from impinging on nearby equipment when hull valve is cycled. Ensure anti-freeze is added to piping after inspection to prevent freezing.
2. The inspected ship's, vice the inspecting command's, salvage wrench shall be used if the inspecting command is another submarine. Discrepancies in the actual, versus plan, number of turns which are greater than one full turn shall be noted in addition to the number of actual turns recorded.
3. Discrepancies between physical installation and salvage plans are to be reported to the TYCOM with an information copy to all plan holders.
4. Exercise extreme caution when testing operation of 4500 psi compartment pressurization valves.
5. When inspecting the gagging gear for the inboard ventilation exhaust valve and the inboard ventilation induction valve, the valve linkages shall be inspected and the valves shall be adjusted in accordance with the requirements in the Non-Primary Plant Valves Technical Manual or individual ship's valve drawing.
6. Prior to testing Outboard Diesel Exhaust Valve, ensure replacement spring loaded locking pin is available onboard.
7. On some designs, operation of the gagging device overrides the regular operating gear of the valve indicator in such a manner that the entire mechanism must be reset/readjusted before the normal operating gear or the valve position indicator will function as intended. If the gagging mechanism is operated or used for any reason, the mechanism shall be reset and the valve subsequently opened and closed by the normal operating gear in every manner in which the gear is designed to function to ensure the valve is in proper operating condition.
8. Unsatisfactory conditions degrade the SRC and/or SRDRS capability and require a CASREP be submitted in accordance with reference (a).
9. Shelf life is computed from date of manufacture which is printed in code on the battery. For example, a battery code "1187" means the battery was manufactured in the 11th month of 1987. For expiration dates, see Naval Supply Systems Command Publication 4105, List of Items Requiring Special Handling.
10. One or more of the Logistics and Escape Trunks (LET) will be removed during refit. When removed, the LET is isolated from service air and electric power. Communications circuits, electrical power, and charging manifold tests should be conducted prior to LET removal to ensure piping and electrical system continuity, and tested again upon reinstallation.
11. Diver's knife, timer and ball peen hammer may be stored in secure stowage in escape compartment.
12. The allowance of escape appliances for submarines with two escape compartments consists of 110 percent of complement in each compartment. Compliment for distribution shall be based on most stressing operational scenario compartment manning which is typically normal underway forward and general quarters in the aft compartment.
13. Man overboard bags to be equipped as specified in Man Overboard Casualty Procedures.
14. Man overboard swimmer to be competent as a swimmer/qualified diver as designated by Commanding Officer.
15. Lithium Hydroxide (LiOH) canister quantity, location, type and use impacts inspection acceptance criteria. The minimum number of LiOH canisters shall be obtained from the ship's COSAL and the below additional requirements:

- a. Canisters reserved for Disabled Submarine (DISSUB) use only:
 - (1) Forward LiOH canisters shall not be less than 460 - SSN21/22 (462 - SSN23) Granular (NSN 6810-00-559-3261).
 - (2) Any expected crew and/or riders above normal crew manning requires additional DISSUB survivability stores as determined by calculations provided in the applicable Ship Systems Manual (SSM) once updated. General guidance is to add four (4) additional Granular LiOH canisters for each additional crew or rider beyond normal crew manning. Additional canisters shall be stowed in the same compartment (FWD or aft) rider would be stationed during normal underway (FWD) and general quarters (aft), as applicable.
- b. A minimum of 40 Granular LiOH canisters are required onboard to support NON-DISSUB applications and may be stowed forward or aft. There is no minimum number of LiOH canisters required aft.

EXCEPTION: REDUCE TO 30 LIOH CANISTERS FOR CO-H₂ BURNER MAINTENANCE IF DIVER QUALIFIED AIR IS NOT APPLICABLE.

- c. LiOH canisters reserved for DISSUB shall be segregated from NON-DISSUB canisters with quantities and location(s) logged by the crew. Note 15 requirements do not authorize total onboard LiOH canisters reserved for DISSUB and NON-DISSUB to be less than the ship's COSAL requirement.
16. The minimum number of LiOH DISSUB deployment kits shall be obtained from the ship's COSAL and the below additional requirements for granular LiOH canisters reserved for DISSUB use only (if applicable):
- a. A minimum ten (10) LiOH curtain kits - SSN21/22 (11 - SSN23) are required to be stowed in the forward compartment.
 - b. Four (4) additional LiOH curtains are required in the forward compartment for crew or riders exceeding normal crew manning of 153 - SSN21/22 (166 - SSN23).

NOTE: EACH KIT CONTAINS 50 CURTAINS WITH DEPLOYMENT HARDWARE. PARTIAL OR OPENED KITS ARE UNSAT.

17. Sodium chlorate oxygen candle quantity and location impacts inspection acceptance criteria. The minimum number of candles shall be obtained from the below requirements:

- a. Oxygen candles reserved for DISSUB use only:
 - (1) Forward candles shall not be less than 192 - SSN21/22 (196 - SSN23) for normal crew manning of 153 - SSN21/22 (166 - SSN23).
 - (2) Aft candles shall not be less than 18 - SSN21/22/23 for normal crew manning of 153 - SSN21/22 (166 - SSN23).
 - (3) Any expected crew and/or riders above normal crew manning requires additional DISSUB survivability stores as determined by calculations provided in the applicable SSM once updated. General guidance is to add one and a half (1.5) additional candles for each additional crew or rider beyond normal crew manning. Additional candles shall be stowed in the same compartment (FWD or aft) the rider would be stationed during normal underway (FWD) and general quarters (aft), as applicable.

NOTE: STOWAGE OF AN OPENED OR DAMAGED CANDLE OR IGNITER IS UNSAT.

- b. Mission appropriate oxygen candle quantities reserved for NON-DISSUB shall be in excess of quantities reserved for DISSUB. Normal OPs requires a minimum of 10 days of candles, while arctic OPs require a minimum of 20 days. Oxygen candles supporting NON-DISSUB applications may be stowed forward or aft.
- c. Oxygen candles reserved for DISSUB shall be segregated from NON-DISSUB candles with quantities and location(s) logged by the crew. Note 17 requirements authorize total onboard candles reserved for DISSUB and NON-DISSUB to be less than the ship's COSAL requirement if mission and Note 17 requirements are otherwise met.

- d. Oxygen candle igniters shall be of a quantity and location (FWD or aft) that supports onboard candle load-out at least one for one.

18. Oxygen candle furnace quantity and location impacts inspection acceptance criteria. The minimum number of furnaces shall be obtained from the ship's COSAL and the below additional requirements:

- a. Furnaces maintained in clean and fully operating condition are necessary for both DISSUB and NON-DISSUB applications as follows:
 - (1) Forward furnaces shall not be less than two (2) for normal crew manning of 153 - SSN21/22 (166 - SSN23).
 - (2) Aft furnaces shall not be less than one (1) for normal crew manning of 153 - SSN21/22 (166 - SSN23).
- b. Note 18 requirements do not authorize total onboard furnaces to be less than the ship's COSAL requirement.

**APPENDIX B
SSN 688 CLASS SUBMARINE SALVAGE INSPECTION
CHECK-OFF LIST**

General Information

- 1. Items pertaining to rescue vehicle seating surfaces and buoy cable angle tests require substantial support equipment and are designated for industrial activity accomplishment.**
- 2. Configuration differences are noted as comments in the reference column.**
- 3. Portions of the Salvage Inspection (as specified by the maintenance activity) may be conducted prior to the start of CNO availabilities as "pre-availability inspections" to support planning of the availability. These items need not be re-inspected provided no work was performed during the availability which affects their status. When specified, these items will be performed by Ship's Force and written certification by the Commanding Officer provided to the maintenance activity, the ISIC, and the Senior Inspecting Officer.**
- 4. The user is directed to use the most current revision of the PMS maintenance requirement.**

PART I: SALVAGE

INSPECTION TEAM (SSN 688 CLASS)	Reference Note	Sat	Unsat	Submarine Inspector Signature	Inspection Team Member Signature
<p>1. <u>Salvage Drawings:</u></p> <p>a. Verify salvage drawings:</p> <p>(1) Have been updated during ship's new construction period/last CNO Maintenance Availability or</p> <p>(2) Latest revision is identified in ship's plan index.</p> <p>(3) Have correct distribution.</p> <p>(4) Are identified as Selected Record Drawings.</p> <p>2. <u>High/Low Salvage Connections:</u></p> <p>a. Verify deck touch plate markings are installed and per plan.</p> <p>b. Check that each valve is free to operate with the inspecting command's salvage wrench.</p>	<p>Navy Modernization Process Management and Operations Manual NAVSEA SL720-AA-MAN-030</p> <p>Ship Dwg. Consolidated Index Number 513 or 845</p> <p>Ship's Plans</p> <p>Notes 1 and 2</p>				

An asterisk (*) will be used in addition to a check mark (✓) in the unsat column to identify any exceptions. An explanation of the exception will be provided with the Salvage Inspection Report, Appendix F of this chapter.

INSPECTION TEAM (SSN 688 CLASS)	Reference Note	Sat	Unsat	Submarine Inspector Signature	Inspection Team Member Signature
<p>c. Perform a "J" pressure and a low pressure 100 psi seat tightness test from the sea side. No leakage is allowed.</p> <p>d. External salvage system caps:</p> <p>(1) Verify the ship's salvage system arrangement plan contains a note that Roylyn type fittings are installed.</p> <p>(2) Remove cap assembly, test connect/disconnect with the inspecting command's female fitting.</p> <p>(3) Inspect all Roylyn caps. Ensure cap operates properly and is free of paint and/or debris. Reinstall cap with safety wire, where applicable.</p> <p>e. Verify strainers are properly installed on all compartment low salvage lines and are clear of debris.</p> <p>3. <u>Internal Air Salvage:</u></p> <p>a. Test satisfactory operation of all internal salvage air valves.</p> <p>b. Verify all compartment pressure gages are in calibration as indicated on calibration label.</p> <p>4. <u>Bulkhead Flappers:</u></p> <p>a. Test satisfactory local and remote (as applicable) operation of all ventilation system bulkhead flappers.</p> <p>5. <u>Hull Access Hatches, Watertight Doors and Torpedo Loading Hatches:</u> Inspection performed by local PMT.</p> <p>a. Perform/witness maintenance required by Planned Maintenance System (PMS) Maintenance Index Page (MIP) to complete salvage inspection and reference the PMT annual inspection.</p> <p>6. <u>External Gagging Devices:</u></p>	<p>Note 1</p> <p>Note 3</p> <p>Kaiser Aero Space & Electronics Dwg. 9495 (Formally Roylyn Inc.)</p> <p>Note 4</p> <p>MIP 1671/905, MRCs 7BYE and 7BBB</p>				

An asterisk (*) will be used in addition to a check mark (✓) in the unsat column to identify any exceptions. An explanation of the exception will be provided with the Salvage Inspection Report, Appendix F of this chapter.

INSPECTION TEAM (SSN 688 CLASS)	Reference Note	Sat	Unsat	Submarine Inspector Signature	Inspection Team Member Signature
<p>a. Witness demonstration that all valves with external gagging devices can be gagged from open to shut with the inspecting command's salvage wrench and with the number of turns specified on the ship's salvage system arrangement plan. Record number of turns to operate. _____</p> <p>b. Witness resetting of each gagging device and demonstrate satisfactory operation of the valves by normal means.</p> <p>7. <u>Air Bank Dew Points:</u></p> <p>a. Verify air samples from all air banks and verify High Pressure Air Compressors are in specification and in periodicity.</p> <p>8. <u>Towing Equipment</u></p> <p>a. <u>Perform Inspection of Towing Equipment.</u></p>	<p>Notes 2 and 5</p> <p>Note 6</p> <p>MIP 5542/911 MRC 7BDB</p> <p>(MIP) 5821/688</p>				

An asterisk (*) will be used in addition to a check mark (✓) in the unsat column to identify any exceptions. An explanation of the exception will be provided with the Salvage Inspection Report, Appendix F of this chapter.

PART II: DISSUB 7-DAY SURVIVAL, ESCAPE AND RESCUE

INSPECTION ITEM (SSN 688 CLASS)	Reference Note	Fwd		Aft		Submarine Inspector Signature	Inspection Team Member Signature
		Sat	Unsat	Sat	Unsat		
<p>1. <u>Submarine Rescue Chamber (SRC) and/or Submarine Rescue Diving Recompression System (SRDRS) Fittings.</u></p> <p>a. Verify four rescue vehicle holddown sockets are installed per plan or authorized alteration on all escape trunk seating surfaces. From one socket per hatch, remove capscrew and plug; demonstrate guide is free.</p> <p>b. Remove plug from hatch fairing. Check condition of SRC downhaul shackle. Verify downhaul shackle is free of corrosion and can be operated by hand. Use of plastisol on downhaul shackle is not authorized as it prevents visual inspection of shackle for corrosion and promotes corrosion. The shackle must be powder coated white.</p> <p>c. AN/BQN-13.</p> <p>(1) Inspect AN/BQN-13 Beacon to ensure that:</p> <p>(a) Cable is free of abrasions, cuts or damage.</p> <p>(b) Cable plug and encapsulation are free of defects.</p> <p>(c) Unit has no physical damage.</p> <p>(d) Transducer is free of oil leaks, bubbles and paint.</p> <p>(2) Verify from ship's records that all applicable AN/BQN-13 PMS has been performed and witness satisfactory performance of all procedures (except R-1).</p> <p>(3) Inventory allowance of spare batteries for AN/BQN-13. Ensure shelf life of batteries has not been exceeded.</p>	<p>Naval Ships' Technical Manual (NSTM) S9086-T9-STM-010 Chapter 594</p> <p>Ship's Plans Note 7</p> <p>Ship's Plans Note 7</p> <p>MIP SO-104/902</p> <p>Ship's COSAL Note 8</p>						

An asterisk (*) will be used in addition to a check mark (✓) in the unsat column to identify any exceptions. An explanation of the exception will be provided with the Salvage Inspection Report, Appendix F of this chapter.

INSPECTION ITEM (SSN 688 CLASS)	Reference Note	Fwd		Aft		Submarine Inspector Signature	Inspection Team Member Signature
		Sat	Unsat	Sat	Unsat		
<p>(5) Pressure proof lights checked to ensure correct globe sealing, and verified that globe is free from cracks.</p> <p>(6) Electric lantern screened lenses and pressure relief hole sealed with plastic (MIL-I-3064).</p> <p>(7) 31MC installed above waterline.</p> <p>(8) Verify accomplishment of PMS to clear sea pressure sensing lines.</p> <p>f. Verify the following equipment installed:</p> <p>(1) Diver's knife.</p> <p>(2) Ball peen hammer.</p> <p>(3) Persuader (crows foot).</p> <p>g. Check Flood Line Orifice Size (1.25" for SSN 688 Class with S/A 4142 installed.)</p> <p>h. Verify valve handwheels are properly color coded and labeled in accordance with Ship's Drawing Index, Ship's placards and Posted Information Plates.</p> <p>i. Verify gages are in calibration as indicated on calibration label.</p> <p>j. Verify upper watertight hatch cavity drain valve operation is satisfactory.</p> <p>k. Witness satisfactory rigging and operation of escape trunk portable skirt, verify ability to remove the bubble skirt with the upper hatch shut within 5 minutes without the use of tools. (N/A if A&I N3485 has been accomplished.)</p> <p>l. Demonstrate that escape trunk upper hatch maximum hydraulic closing pressure is satisfactory. Demonstrate that the hydraulic accumulator maintains the nitrogen pre-charge as specified in OP 61-1 (rig-for-dive) and that the hand pump operates satisfactory (after S/A 4189 completed).</p>	<p>MIP 5641/9R2 MRC 9MAY and 9MAZ</p> <p>Note 9</p> <p>Note 9</p> <p>Installed</p> <p>NSTM S9086- RK-STM-010 Chapter 505</p> <p>Ship's Plans</p>						

An asterisk (*) will be used in addition to a check mark (✓) in the unsat column to identify any exceptions. An explanation of the exception will be provided with the Salvage Inspection Report, Appendix F of this chapter.

INSPECTION ITEM (SSN 688 CLASS)	Reference Note	Fwd		Aft		Submarine Inspector Signature	Inspection Team Member Signature
		Sat	Unsat	Sat	Unsat		
<p>3. <u>Emergency Communications Equipment:</u></p> <p>a. Inventory allowance of the following equipment and confirm proper stowage as indicated:</p> <p>(1) SEPIRB Model T-1630/SRT (2 FWD, 2 aft with Launch Hardware each compartment).</p> <p>b. Verify from ship's records that all applicable PMS has been performed and witness satisfactory performance of indicated MRCs.</p> <p>(1) SEPIRB.</p>	<p>Ship Configuration and Logistics Support Information System (SCLISIS) & COSAL</p> <p>7-00000A434</p> <p>MIP 4413/015</p>						
<p>4. <u>Life Saving and Safety Equipment:</u></p> <p>a. Inventory allowance (randomly, type and quantity as applicable) and witness satisfactory performance of PMS procedures on the following: (PMS procedures are to be demonstrated on one representative candidate from each of the sub groups listed below).</p> <p>(1) Auto-Inflatable life preservers.</p> <p>(2) Inherently Buoyant life preservers.</p> <p>(3) Man overboard bag.</p> <p>(4) Qualified swimmer designated for man overboard.</p> <p>(5) Safety harness (belts).</p> <p>(6) Safety track.</p> <p>(7) Distress marker lights.</p> <p>(8) Life lines and stanchions.</p> <p>(9) SEIE Suits.</p>	<p>Ship's COSAL Note 10</p> <p>MIP 5832/SUB</p> <p>MIP 5832/030</p> <p>Note 11 MIP 5832/021</p> <p>Note 12MILPERS MAN Art. 1414-010 Series</p> <p>MIP 6231/001 MRC 2EA0</p> <p>Note 13 MIP 6111/R06</p> <p>MIP 5832/010</p> <p>MIP 6121/SUB</p> <p>MIP 5940/005</p>						

An asterisk (*) will be used in addition to a check mark (✓) in the unsat column to identify any exceptions. An explanation of the exception will be provided with the Salvage Inspection Report, Appendix F of this chapter.

INSPECTION ITEM (SSN 688 CLASS)	Reference Note	Fwd		Aft		Submarine Inspector Signature	Inspection Team Member Signature
		Sat	Unsat	Sat	Unsat		
<p>(10) Crash Bags.</p> <p>(11) Guard Book (Stored in same locker as Crash Bag)</p> <p>(12) OP 61-1</p> <p>(13) OI 638-4</p> <p>5. <u>Escape Training</u>:</p> <p>a. Verify that all hands are trained in SEIE escape.</p> <p>6. <u>DISSUB 7-Day Survival</u>:</p> <p>a. <u>Atmosphere Control</u>:</p> <p>(1) Inventory quantity onboard and inspect condition of the following:</p> <p>(a) CO₂ absorbent canisters.</p> <p>Amount onboard for DISSUB: FWD: _____ Aft: _____</p> <p>Amount onboard for NON-DISSUB: _____</p> <p>Required _____</p> <p>Comment on condition and ship's record for DISSUB/NON-DISSUB segregation: _____</p> <p>(b) DISSUB LiOH Deployment Kits.</p> <p>Amount onboard FWD: _____ Aft: _____</p> <p>Required: _____</p> <p>Comment on condition _____</p>	<p>MIP 5940/005, MRC 1SC3 and AEL 2-330023072</p> <p>Latest Revision per AEL 2-330023072</p> <p>Note 7</p> <p>AELs 2-3300230 or 2- 3300232 series for LiOH product.</p> <p>NON-DISSUB; (e.g., for CO-H₂ After- filter & DQA) Note 14</p> <p>Per AEL 2-330023035 or 2-330023205 for LiOH Deploy kits.</p> <p>Note 15</p>						

An asterisk (*) will be used in addition to a check mark (✓) in the unsat column to identify any exceptions. An explanation of the exception will be provided with the Salvage Inspection Report, Appendix F of this chapter.

INSPECTION ITEM (SSN 688 CLASS)	Reference Note	Fwd		Aft		Submarine Inspector Signature	Inspection Team Member Signature
		Sat	Unsat	Sat	Unsat		
<p>(c) O₂ candles.</p> <p>Amount onboard for DISSUB: FWD: _____ Aft: _____</p> <p>Amount onboard for NON-DISSUB: _____</p> <p>Required: _____</p> <p>Comment on condition and ship's record for DISSUB/NON-DISSUB segregation: _____</p> <p>(d) O₂ candle furnace. Candle furnaces onboard: FWD: _____ Aft: _____ Required: _____</p> <p>Comment on condition (include location - FWD and/or aft compartments). _____</p> <p>(e) Emergency Air Breathing masks (test random 5% for proper operation per applicable MRC).</p> <p>(2) Verify CO₂ absorbent canister PMS has been completed within required periodicity. Additionally, randomly select 10% of canisters onboard and weigh them in accordance with the applicable MRC.</p> <p>(3) Inspect ten percent per compartment of emergency air breathing manifold in-line filters and filter housing for presence of corrosion.</p> <p>b. <u>Atmosphere Monitoring:</u></p> <p>(1) Inventory quantity onboard and inspect condition of the following:</p>	<p>AEL 1-230013100</p> <p>NON- DISSUB - (e.g., for O₂ generator backup)</p> <p>Note 16</p> <p>Ship's COSAL</p> <p>Note 17</p> <p>Ship's COSAL MIP 5519/600 MRC G8CL</p> <p>MIP 5151/001 MRC B6CW</p>						

An asterisk (*) will be used in addition to a check mark (✓) in the unsat column to identify any exceptions. An explanation of the exception will be provided with the Salvage Inspection Report, Appendix F of this chapter.

INSPECTION ITEM (SSN 688 CLASS)	Reference Note	Fwd		Aft		Submarine Inspector Signature	Inspection Team Member Signature
		Sat	Unsat	Sat	Unsat		
<p>(a) DISSUB O₂/CO₂ Gas Monitors (Analox).</p> <p>Amount onboard (including location)</p> <hr/> <p>Required: (minimum) <u>1 FWD, 1 aft compartment</u></p> <p>(2) Verify Analox PMS has been completed within required periodicity.</p> <p>(3) Inventory allowance of spare batteries for Analox. Ensure shelf life of batteries has not been exceeded.</p> <p>7. <u>Launchers:</u></p> <p>a. Demonstrate satisfactory operation of each launcher manually and hydro pneumatically as applicable.</p> <p>b. Verify a minimum of six Red Submarine Emergency Identification Signals and Submarine Floating Signal pyrotechnics stowed in compartment with launcher.</p> <p>c. Operational verification shall include a demonstrated launch (water slug) from both remote and local operating stations.</p>	<p>AEL 2-870003101 Stored in same locker as Crash Bag</p> <p>MIP 5940/002 MRC 9TFF</p> <p>NSN 6135-01-538-3507 (4 FWD, 4 aft)</p>						

An asterisk (*) will be used in addition to a check mark (✓) in the unsat column to identify any exceptions. An explanation of the exception will be provided with the Salvage Inspection Report, Appendix F of this chapter.

NOTES
(SSN 688 CLASS)

1. All high/low salvage valves are to be tested for freedom of operation at the frequency specified, except during the salvage inspection conducted incident to an overhaul. Salvage Air valve testing completed up to one year prior to the start of an availability will satisfy the salvage inspection requirements provided that certified records verifying the tests are available. Written certification by the Commanding Officer that specified external salvage valves have been overhauled by the industrial activity or Ship's Force and have been successfully hydrostatically tested will constitute certification that the valve operates freely, providing all inspections (Part I, items 2.b. and 2.c. of this Appendix) for each valve so certified are satisfactory. If the results of the inspection of operating gear are not satisfactory, or doubt exists concerning freedom of operation, the specific valves in question shall be checked. Provide appropriate container for collecting anti-freeze drained from salvage piping when hull valve is cycled. Ensure controlled re-assembly in accordance with Quality Assurance requirements is performed when installing salvage caps. Exercise caution to prevent liquid in salvage air piping from impinging on nearby equipment when hull valve is cycled. Ensure anti-freeze is added to piping after inspection to prevent freezing.
2. The inspected ship's, vice the inspecting command's, salvage wrench shall be used if the inspecting command is another submarine. Discrepancies in the actual, versus plan, number of turns which are greater than one full turn shall be noted in addition to the number of actual turns recorded.
3. Discrepancies between physical installation and salvage plans are to be reported to the TYCOM with an information copy to all plan holders.
4. Exercise extreme caution when testing operation of 4500 psi compartment pressurization valves.
5. When inspecting the gagging gear for the inboard ventilation exhaust valve and the inboard ventilation induction valve, the valve linkages shall be inspected and the valves shall be adjusted in accordance with the requirements in the Non-Primary Plant Valves Technical Manual or individual ship's valve drawing.
6. On some designs, operation of the gagging device overrides the regular operating gear of the valve indicator in such a manner that the entire mechanism must be reset/readjusted before the normal operating gear or the valve position indicator will function as intended. If the gagging mechanism is operated or used for any reason, the mechanism shall be reset and the valve subsequently opened and closed by the normal operating gear in every manner in which the gear is designed to function to ensure the valve is in proper operating condition.
7. Unsatisfactory conditions degrade the SRC and/or SRDRS capability and require a CASREP be submitted in accordance with reference (a).
8. Shelf life is computed from date of manufacture which is printed in code on the battery. For example, a battery code "1187" means the battery was manufactured in the 11th month of 1987. For expiration dates, see Naval Supply Systems Command Publication 4105, List of Items Requiring Special Handling.
9. Diver's knife and ballpeen hammer may be stored in secure stowage in escape compartment.
10. The allowance of escape appliances for submarines with two escape compartments consists of 110 percent of complement in each compartment. Compliment for distribution shall be based on most stressing operational scenario compartment manning which is typically normal underway forward and general quarters in the aft compartment.
11. Man overboard bags to be equipped as specified in Man Overboard Casualty Procedures.
12. Man overboard swimmer to be competent swimmer/qualified diver as designated by Commanding Officer.
13. Safety track inspection shall be performed as specified by MIP 6111/R06 (MRC 3JTK).
14. Lithium Hydroxide (LiOH) canister quantity, location, type and use impacts inspection acceptance criteria. The minimum number of LiOH canisters shall be obtained from the ship's COSAL and the below additional requirements:
 - a. Canisters reserved for Disabled Submarine (DISSUB) use only:
 - (1) Forward LiOH canisters shall not be less than 429 Granular (NSN 6810-00-559-3261).

- (2) Any expected crew and/or riders above normal crew manning requires additional DISSUB survivability stores as determined by calculations provided in the applicable Ship Systems Manual (SSM) once updated. General guidance is to add four (4) additional Granular LiOH canisters for each additional crew or rider beyond normal crew manning. Additional canisters shall be stowed in the same compartment (FWD or aft) rider would be stationed during normal underway (FWD) and general quarters (aft), as applicable.

- b. A minimum of 40 Granular LiOH canisters are required onboard to support NON-DISSUB applications and may be stowed forward or aft. There is no minimum number of LiOH canisters required aft.

EXCEPTION: REDUCE TO 30 LIOH CANISTERS FOR CO-H2 BURNER MAINTENANCE IF DIVER QUALIFIED AIR IS NOT APPLICABLE.

- c. LiOH canisters reserved for DISSUB shall be segregated from NON-DISSUB canisters with quantities and location(s) logged by the crew. Note 14 requirements do not authorize total onboard LiOH canisters reserved for DISSUB and NON-DISSUB to be less than the ship's COSAL requirement.

15. The minimum number of LiOH DISSUB deployment kits shall be obtained from the ship's COSAL and the below additional requirements for granular LiOH canisters reserved for DISSUB use only (if applicable):

- a. A minimum nine (9) LiOH curtain kits are required to be stowed in the forward compartment.
- b. Four (4) additional LiOH curtains are required in the forward compartment for crew or riders exceeding normal crew manning of 154 onboard.

NOTE: EACH KIT CONTAINS 50 CURTAINS WITH DEPLOYMENT HARDWARE. PARTIAL OR OPENED KITS ARE UNSAT.

NOTE: STOWAGE OF AN OPENED OR DAMAGED CANDLE OR IGNITER IS UNSAT.

16. Sodium chlorate oxygen candle quantity and location impacts inspection acceptance criteria. The minimum number of candles shall be obtained from the below requirements:

- a. Oxygen candles reserved for DISSUB use only:
 - (1) Forward candles shall not be less than 200 for normal crew manning of 154.
 - (2) Aft candles shall not be less than 18 for normal crew manning of 154.
 - (3) Any expected crew and/or riders above normal crew manning requires additional DISSUB survivability stores as determined by calculations provided in the applicable SSM once updated. General guidance is to add one and a half (1.5) additional candles for each additional crew or rider beyond normal crew manning. Additional candles shall be stowed in the same compartment (FWD or aft) the rider would be stationed during normal underway (FWD) and general quarters (aft), as applicable.
- b. Mission appropriate oxygen candle quantities reserved for NON-DISSUB shall be in excess of quantities reserved for DISSUB. Normal OPs requires a minimum of 10 days of candles, while arctic OPs require a minimum of 20 days. Oxygen candles supporting NON-DISSUB applications may be stowed forward or aft.
- c. Oxygen candles reserved for DISSUB shall be segregated from NON-DISSUB candles with quantities and location(s) logged by the crew. Note 16 requirements authorize total onboard candles reserved for DISSUB and NON-DISSUB to be less than the ship's COSAL requirement if mission and Note 16 requirements are otherwise met.
- d. Oxygen candle igniters shall be of a quantity and location (FWD or aft) that supports onboard candle load-out at least one for one.

17. Oxygen candle furnace quantity and location impacts inspection acceptance criteria. The minimum number of furnaces shall be obtained from the ship's COSAL and the below additional requirements:

- a. Furnaces maintained in clean and fully operating condition are necessary for both DISSUB and NON-DISSUB applications as follows:

- (1) Forward furnaces shall not be less than two (2) for normal crew manning of 154.
 - (2) Aft furnaces shall not be less than one (1) for normal crew manning of 154.
- b. Note 17 requirements do not authorize total onboard furnaces to be less than the ship's COSAL requirement.

(This Page Intentionally Left Blank)

APPENDIX C

**SSBN/SSGN 726 CLASS SUBMARINE SALVAGE INSPECTION
CHECK-OFF LIST**

General Information

1. Items pertaining to rescue vehicle seating surfaces and buoy cable angle tests require substantial support equipment and are designated for industrial activity accomplishment.
2. Configuration differences are noted as comments in the reference column.
3. Portions of the Salvage Inspection (as specified by the maintenance activity) may be conducted prior to the start of CNO availabilities as "pre-availability inspections" to support planning of the availability. These items need not be re-inspected provided no work was performed during the availability which affects their status. When specified, these items will be performed by Ship's Force and written certification by the Commanding Officer provided to the maintenance activity, the ISIC, and the Senior Inspecting Officer.
4. The user is directed to use the most current revision of the PMS maintenance requirement.

PART I: SALVAGE

INSPECTION TEAM (SSBN/SSGN 726 CLASS)	Reference Note	Sat	Unsat	Submarine Inspector Signature	Inspection Team Member Signature
<p>1. <u>Salvage Drawings:</u></p> <p>a. Verify salvage drawings:</p> <p>(1) Have been updated during ship's new construction period/last CNO Maintenance Availability or</p> <p>(2) Latest revision is identified in ship's plan index.</p> <p>(3) Have correct distribution.</p> <p>(4) Are identified as Selected Record Drawings</p> <p>2. <u>High/Low Salvage Connections:</u></p> <p>a. Verify deck touch plate markings are installed and per plan.</p> <p>b. Inspect external valve operating gear for conditions of the salvage valve; i.e., excessive paint, lack of lubrication, distortion, damaged or missing grease boots.</p>	<p>Navy Modernization Process Management and Operations Manual NAVSEA SL720-AA-MAN-030</p> <p>Ship Dwg. Consolidated Index Number 513 or 845</p> <p>Ship's Plans</p> <p>Note 1</p>				

An asterisk (*) will be used in addition to a check mark (✓) in the unsat column to identify any exceptions. An explanation of the exception will be provided with the Salvage Inspection Report, Appendix F of this chapter.

INSPECTION TEAM (SSBN/SSGN 726 CLASS)	Reference Note	Sat	Unsat	Submarine Inspector Signature	Inspection Team Member Signature
<p>c. Check that each valve is free to operate with the inspecting command's salvage wrench.</p> <p>d. Perform a "J" pressure and a low pressure 100 psi seat tightness test from the sea side. No leakage is allowed.</p> <p>e. External salvage system caps:</p> <p>(1) Verify the ship's salvage system arrangement plan contains a note that Roylyn type fittings are installed.</p> <p>(2) Remove cap assembly, test connect/disconnect with the inspecting command's female fitting.</p> <p>(3) Inspect all Roylyn caps. Ensure cap operates properly and is free of paint and/or debris. Reinstall cap with safety wire, where applicable.</p> <p>f. Verify strainers are properly installed on all compartment low salvage lines and are clear of debris.</p> <p>3. <u>Internal Air Salvage:</u></p> <p>a. Test satisfactory operation of all internal salvage air valves.</p> <p>b. Verify all compartment pressure gages are in calibration as indicated on calibration label.</p> <p>4. <u>Bulkhead Flappers:</u></p> <p>a. Test satisfactory local and remote (as applicable) operation of all ventilation system bulkhead flappers.</p> <p>5. <u>Hull Access Hatches (Upper and Lower if installed), Watertight Doors and Torpedo Loading Hatches:</u> Inspection performed by local PMT.</p> <p>a. Perform/witness maintenance required by Planned Maintenance System (PMS) Maintenance Index Page (MIP) to complete salvage inspection and reference the PMT annual inspection.</p>	<p>Notes 2 and 3</p> <p>Note 2</p> <p>Note 4</p> <p>Kaiser Aero Space & Electronics Dwg. 9495 (Formally Roylyn Inc.)</p> <p>Note 5</p> <p>For SSBN use MIP 1671/900MRCs 7BYJ, 7CKQ</p> <p>For SSGN use MIP 1671/901 MRCs 7DEQ, 7DSG, 7DSW</p>				

An asterisk (*) will be used in addition to a check mark (✓) in the unsat column to identify any exceptions. An explanation of the exception will be provided with the Salvage Inspection Report, Appendix F of this chapter.

PART II: DISSUB 7-DAY SURVIVAL, ESCAPE AND RESCUE

INSPECTION ITEM (SSBN/SSGN 726 CLASS)	Reference Note	Fwd		Mid		Aft		Submarine Inspector Signature	Inspection Team Member Signature
		Sat	Unsat	Sat	Unsat	Sat	Unsat		
<p>1. <u>Submarine Rescue Chamber (SRC) and/or Submarine Rescue Diving Recompression System (SRDRS) Fittings.</u></p> <p>a. Verify 4 padeyes installed for rescue vehicle in upper hatch free flood areas (prior to TZ 0840). Verify four rescue vehicle holddown sockets are installed per plan or authorized alteration on all escape trunk seating surfaces. From one socket per hatch, remove capscrew and plug; demonstrate guide is free. (After TZ-0840).</p> <p>b. Remove plug from hatch fairing. Check condition of SRC downhaul shackle. Verify downhaul shackle is free of corrosion and can be operated by hand. Use of plastisol on downhaul shackle is not authorized as it prevents visual inspection of shackle for corrosion and promotes corrosion. The shackle must be powder coated white.</p> <p>2. <u>Escape Trunks, Logistics Escape Trunks and Forward Lockout Trunks:</u></p> <p>a. Escape trunk hatch fairings must be maintained in a condition to be easily disassembled to support submarine rescue. Verify Planned Maintenance has been completed within the required periodicity on all escape trunk hatches. Visually inspect escape trunk hatch fairings for compliance with the specification called out in the Maintenance Standard (MS). Paint fouling or corrosion of fairing fasteners must be immediately corrected. Demonstrate the ability to remove one fastener in each fairing piece required to be removed in the fairing disassembly procedure.</p>	<p>Naval Ships' Technical Manual (NSTM) S9086-T9-STM-010 Chapter 594</p> <p>Ship's Plans Note 9</p> <p>Ship's Plans Note 9</p> <p>Note 10</p> <p>MS 1670-081-011</p>								

An asterisk (*) will be used in addition to a check mark (✓) in the unsat column to identify any exceptions. An explanation of the exception will be provided with the Salvage Inspection Report, Appendix F of this chapter.

INSPECTION ITEM (SSBN/SSGN 726 CLASS)	Reference Note	Fwd		Mid		Aft		Submarine Inspector Signature	Inspection Team Member Signature
		Sat	Unsat	Sat	Unsat	Sat	Unsat		
<p>b. Demonstrate that each access hatch operates satisfactorily with all respects of locking/unlocking, opening/shutting from below/above (with salvage wrench/handwheel as applicable).</p> <p>c. Demonstrate satisfactory operation of the escape hatch closing mechanisms in accordance with the installed instruction plates and equipment.</p> <p>(1) Demonstrate satisfactory installation of Improved Powered Hatch Operator with intensifier and compensator as one mode of hatch operation of Logistics Escape Trunks.</p> <p>(a) Verify inventory of all parts.</p> <p>(b) Verify periodic pressure testing of hoses.</p> <p>(c) Verify proper operation of sensing line and trunk gage.</p> <p>(d) Verify assembly of intensifier and gearbox to upper hatch operator.</p> <p>(e) Verify installation of upper hatch operator compensator.</p> <p>(f) Demonstrate satisfactory operational check of intensifier pump and gears.</p> <p>d. Demonstrate satisfactory operation and examine the condition of the following equipment:</p> <p>(1) Vent valves (trunk and compartment).</p> <p>(2) Blow valves (trunk and compartment).</p> <p>(3) Flood and drain valves (including remote operation mechanisms and strainer installations).</p>	<p>MIP 1671/900 or 1671/901 MRC E4PH</p> <p>Ship's Drawing</p> <p>MIP 1671/900 or 1671/901 MRC E4PK</p>								

An asterisk (*) will be used in addition to a check mark (✓) in the unsat column to identify any exceptions. An explanation of the exception will be provided with the Salvage Inspection Report, Appendix F of this chapter.

INSPECTION ITEM (SSBN/SSGN 726 CLASS)	Reference Note	Fwd		Mid		Aft		Submarine Inspector Signature	Inspection Team Member Signature
		Sat	Unsat	Sat	Unsat	Sat	Unsat		
<p>(4) Demonstrate satisfactory operation and examine the condition of the following equipment: Conduct Hood Inflation System/Stole Charging Valve operational check to confirm valves operate properly and verify watertight caps installed.</p> <p>(5) Electric lantern screened lenses and pressure relief hole sealed with plastic (MIL-I-3064) and mounted above waterline.</p> <p>(6) 31MC installed above waterline.</p> <p>(7) Verify accomplishment of PMS to clear sea pressure sensing lines.</p> <p>e. Verify the following equipment installed:</p> <p>(1) Diver's knife.</p> <p>(2) Ball peen hammer.</p> <p>(3) Persuader (crows foot).</p> <p>f. Verify valve handwheels are properly color coded and labeled in accordance with Ship's Drawing Index, Ship's placards and Posted Information Plates.</p> <p>g. Verify gages are in calibration as indicated on calibration label.</p> <p>h. Verify upper watertight hatch cavity drain valve operation is satisfactory.</p> <p>i. Witness satisfactory rigging and operation of escape trunk portable skirt, verify ability to remove the bubble skirt with the upper hatch shut within 5 minutes without the use of tools. (N/A if A&I T0165 has been accomplished.)</p>	<p>MIP 5940/905 MRC 7DKE</p> <p>MIP 5641/9R3 or 5641/9R6 MRCs 9MAW, 9MAX</p> <p>Note 11</p> <p>Note 11</p> <p>NSTM S9086- RK-STM-010 Chapter 505</p> <p>Ship's Plans</p>								

An asterisk (*) will be used in addition to a check mark (✓) in the unsat column to identify any exceptions. An explanation of the exception will be provided with the Salvage Inspection Report, Appendix F of this chapter.

INSPECTION ITEM (SSBN/SSGN 726 CLASS)	Reference Note	Fwd		Mid		Aft		Submarine Inspector Signature	Inspection Team Member Signature
		Sat	Unsat	Sat	Unsat	Sat	Unsat		
<p>3. <u>Emergency Communications Equipment:</u></p> <p>a. Inventory allowance of the following equipment and confirm proper stowage as indicated:</p> <p>(1) SEPIRB Model T-1630/SRT (2 FWD, 2 mid, 2 aft with Launch Hardware each compartment).</p> <p>b. Verify from ship's records that all applicable PMS has been performed and witness satisfactory performance of indicated MRCs.</p> <p>(1) SEPIRB.</p> <p>(2) AN/BQQ-6 Emergency Communications and Distress Beacon Groups.</p> <p>c. Inventory allowance of spare batteries for AN/BQQ-6. Ensure shelf life of batteries has not been exceeded.</p> <p>(1) Check that the AN/BQQ-6 Emergency Communications Group receptacle is marked "61/62/63 Receptacle/Emergency Communications for AN/BQQ-6."</p> <p>4. <u>Life Saving and Safety Equipment:</u></p> <p>a. Inventory allowance (randomly, type and quantity as applicable) and witness satisfactory performance of PMS procedures on the following: (PMS procedures are to be demonstrated on one representative candidate from each of the sub groups listed below).</p> <p>(1) Auto-Inflatable life preservers.</p> <p>(2) Inherently Buoyant life preservers.</p>	<p>Ship Configuration and Logistics Support Information System (SCLSIS) & Consolidated Shipboard Allowance List (COSAL)</p> <p>AEL 7-00000A434</p> <p>MIP 4413/015</p> <p>MIP SO-405/902 or MIP SO-404/901</p> <p>Ship's COSAL Note 12</p> <p>Ship's COSAL Note 13</p> <p>MIP 5832/SUB</p> <p>MIP 5832/030</p>								

An asterisk (*) will be used in addition to a check mark (✓) in the unsat column to identify any exceptions. An explanation of the exception will be provided with the Salvage Inspection Report, Appendix F of this chapter.

INSPECTION ITEM (SSBN/SSGN 726 CLASS)	Reference Note	Fwd		Mid		Aft		Submarine Inspector Signature	Inspection Team Member Signature
		Sat	Unsat	Sat	Unsat	Sat	Unsat		
(3) Man overboard bag.	Note 14 MIP 5832/021								
(4) Qualified swimmer designated for man overboard.	Note 15 MILPERS MAN Art. 1414-010 Series								
(5) Safety harness (belts).	MIP 6231/001 MRC 2EA0								
(6) Safety track.	Note 16 MIP 6111/R06								
(7) Distress marker lights.	MIP 5832/010								
(8) Life lines and stanchions.	MIP 6121/SUB								
(9) SEIE Suits.	MIP 5940/005 MRC 9LQX								
(10) Crash Bags.	MIP 5940/005, MRC 1SC3 and AEL 2-330023072								
(11) Guard Book. (Stored in same locker as Crash Bag.)	Latest Revision per AEL 2-330023072								
(12) OP 61-1									
(13) OI 638-3									
(14) OI 638-4									
5. <u>Escape Training:</u> a. Verify that all hands are trained in SEIE escape.									
6. <u>DISSUB 7-Day Survival:</u> a. Portable desalinators (2 FWD, 2 mid & 2 aft) (1) Verify Portable desalinator PMS has been completed within required periodicity.	Note 9 AEL 2-360033003 MIP 5940/003								
b. <u>Atmosphere Control:</u> (1) Inventory quantity onboard and inspect condition of the following:									

An asterisk (*) will be used in addition to a check mark (✓) in the unsat column to identify any exceptions. An explanation of the exception will be provided with the Salvage Inspection Report, Appendix F of this chapter.

INSPECTION ITEM (SSBN/SSGN 726 CLASS)	Reference Note	Fwd		Mid		Aft		Submarine Inspector Signature	Inspection Team Member Signature
		Sat	Unsat	Sat	Unsat	Sat	Unsat		
<p>(a) CO₂ absorbent canisters.</p> <p>Amount onboard for DISSUB: FWD: _____ Mid: _____ Aft: _____</p> <p>Amount onboard for NON-DISSUB: _____</p> <p>Required: _____</p> <p>Comment on condition and ship's record for DISSUB/NON-DISSUB segregation: _____</p> <p>(b) DISSUB LiOH Deployment Kits.</p> <p>Amount onboard: FWD: _____ Mid: _____ Aft: _____</p> <p>Required: _____</p> <p>Comment on condition _____</p>	<p>AELs 2-3300230 or 2-3300232 series for LiOH product.</p> <p>NON- DISSUB; (e.g., for CO-H₂ After- filter & DQA</p> <p>Note 17</p> <p>AEL 2-330023035 or 2-330023205 for LiOH Deploy kits.</p> <p>Note 18</p>								

An asterisk (*) will be used in addition to a check mark (✓) in the unsat column to identify any exceptions. An explanation of the exception will be provided with the Salvage Inspection Report, Appendix F of this chapter.

INSPECTION ITEM (SSBN/SSGN 726 CLASS)	Reference Note	Fwd		Mid		Aft		Submarine Inspector Signature	Inspection Team Member Signature
		Sat	Unsat	Sat	Unsat	Sat	Unsat		
<p>(c) O₂ candles.</p> <p>Amount onboard for DISSUB: FWD: _____ Mid: _____ Aft: _____</p> <p>Amount onboard for NON-DISSUB: _____</p> <p>Required: _____</p> <p>Comment on condition and ship's record for DISSUB/NON-DISSUB segregation. _____</p> <p>(d) O₂ candle furnace.</p> <p>Candle furnaces onboard: FWD: _____ Mid: _____ Aft: _____</p> <p>Required: _____</p> <p>Comment on condition (include location - FWD, mid and/or aft compartments). _____</p> <p>(e) Emergency Air Breathing masks (test random 5% for proper operation per applicable MRC).</p> <p>(2) Verify CO₂ absorbent canister PMS has been completed within required periodicity. Additionally, randomly select 10% of canisters onboard and weigh them in accordance with the applicable MRC.</p> <p>(3) Inspect ten percent per compartment of emergency air breathing manifold in-line filters and filter housing for presence of corrosion.</p> <p>c. <u>Atmosphere Monitoring:</u></p> <p>(1) Inventory quantity onboard and inspect condition of the following:</p>	<p>AEL 1-230013100</p> <p>NON-DISSUB - (e.g., for O₂ generator or Low Pressure Electrolyzer (LPE)).</p> <p>Note 19</p> <p>Ship's COSAL</p> <p>Note 20</p> <p>Ship's COSAL MIP 5519/600 MRC G8CL</p> <p>MIP 5151/001 MRC B6CW</p>								

An asterisk (*) will be used in addition to a check mark (✓) in the unsat column to identify any exceptions. An explanation of the exception will be provided with the Salvage Inspection Report, Appendix F of this chapter.

NOTES
(SSBN/SSGN 726 CLASS)

1. Reach rods, universal joints, and connecting links in the superstructure should be secured with non-corrosive pins. Inspect valve stems for misalignment and ensure that reach rod connection is one of square socket design with the non-corrosive pin used only to secure the reach rod to the universal.
2. All high/low salvage valves are to be tested for freedom of operation at the frequency specified, except during the salvage inspection conducted incident to an overhaul. Salvage Air valve testing completed up to one year prior to the start of an availability will satisfy the salvage inspection requirements provided that certified records verifying the tests are available. Written certification by the Commanding Officer that specified external salvage valves have been overhauled by the industrial activity or Ship's Force and have been successfully hydrostatically tested will constitute certification that the valve operates freely, providing all inspections (Part I, items 2.b., 2.c., and 2.d. of this Appendix) for each valve so certified are satisfactory. If the results of the inspection of operating gear are not satisfactory, or doubt exists concerning freedom of operation, the specific valves in question shall be checked. Provide appropriate container for collecting anti-freeze drained from salvage piping when hull valve is cycled. Ensure controlled re-assembly in accordance with Quality Assurance requirements is performed when installing salvage caps. Exercise caution to prevent liquid in salvage air piping from impinging on nearby equipment when hull valve is cycled. Ensure anti-freeze is added to piping after inspection to prevent freezing.
3. The inspected ship's, vice the inspecting command's, salvage wrench shall be used if the inspecting command is another submarine. Discrepancies in the actual, versus plan, number of turns which are greater than one full turn shall be noted in addition to the number of actual turns recorded.
4. Discrepancies between physical installation and salvage plans are to be reported to the TYCOM with an information copy to all plan holders.
5. Exercise extreme caution when testing operation of 4500 psi compartment pressurization valves.
6. When inspecting the gagging gear for the inboard ventilation exhaust valve and the inboard ventilation induction valve, the valve linkages shall be inspected and the valves shall be adjusted in accordance with the requirements in the Non-Primary Plant Valves Technical Manual or individual ship's valve drawing.
7. Prior to testing Outboard Diesel Exhaust Valve, ensure replacement locking pin is available onboard.
8. On some designs, operation of the gagging device overrides the regular operating gear of the valve indicator in such a manner that the entire mechanism must be reset/readjusted before the normal operating gear or the valve position indicator will function as intended. If the gagging mechanism is operated or used for any reason, the mechanism shall be reset and the valve subsequently opened and closed by the normal operating gear in every manner in which the gear is designed to function to ensure the valve is in proper operating condition.
9. Unsatisfactory conditions degrade the SRC and/or SRDRS capability and require a CASREP be submitted in accordance with reference (a).
10. One or more of the Logistics and Escape Trunks (LET) will be removed during refit. When removed, the LET is isolated from service air and electric power. Communications circuits, electrical power, and charging manifold tests should be conducted prior to LET removal to ensure piping and electrical system continuity, and tested again upon reinstallation.
11. Diver's knife, timer and ball peen hammer may be stored in secure stowage in escape compartment.
12. Shelf life is computed from date of manufacture which is printed in code on the battery. For example, a battery code "1187" means the battery was manufactured in the 11th month of 1987. For expiration dates, see Naval Supply Systems Command Publication 4105, List of Items Requiring Special Handling.
13. The allowance of escape appliances for submarines with three escape compartments consists of 55 percent of complement in the forward and aft compartments and 110 percent of complement in the midships escape compartment. Complement for distribution shall be based on most stressing operational scenario compartment manning which is typically general quarters for forward/aft and normal underway in the missile compartment.
14. Man overboard bags to be equipped as specified in Man Overboard Casualty Procedures.
15. Man overboard swimmer to be competent swimmer/qualified diver as designated by Commanding Officer.

16. Safety track inspection shall be performed as specified by MIP 6111/R06 (MRC 3JTK) and applicable ship's drawings.

17. Lithium Hydroxide (LiOH) canister quantity, location, type and use impacts inspection acceptance criteria. The minimum number of LiOH canisters shall be obtained from the ship's COSAL and the below additional requirements:

- a. Canisters reserved for Disabled Submarine (DISSUB) use only:
 - (1) Forward LiOH canisters shall not be less than 273 -SSBN (330 - SSGN) Granular (NSN 6810-00-559-3261).
 - (2) Mid LiOH canisters shall not be less than 325 (358 - SSGN) Granular.
 - (3) Any expected crew and/or riders above normal crew manning requires additional DISSUB survivability stores as determined by calculations provided in the applicable Ship Systems Manual (SSM) once updated. General guidance is to add four (4) additional Granular LiOH canisters for each additional crew or rider beyond normal crew manning. Additional canisters shall be stowed in the same compartment (FWD, mid or aft) rider would be stationed during normal underway crew at rest (mid) and general quarters (FWD & aft), as applicable.
 - (4) Forward and mid Compartment LiOH canister count reserved for DISSUB shall be either all Granular.
- b. A minimum of 40 Granular LiOH canisters are required onboard to support NON-DISSUB applications and may be stowed forward, mid or aft. There is no minimum number of LiOH canisters required aft.

EXCEPTION: REDUCE TO 30 LIOH CANISTERS FOR CO-H₂ BURNER MAINTENANCE IF DIVER QUALIFIED AIR IS NOT APPLICABLE.

- c. LiOH canisters reserved for DISSUB shall be segregated from NON-DISSUB canisters with quantities and location(s) logged by the crew. Note 17 requirements do not authorize total onboard LiOH canisters reserved for DISSUB and NON-DISSUB to be less than the ship's COSAL requirement.

18. The minimum number of LiOH DISSUB deployment kits shall be obtained from the ship's COSAL and the below additional requirements for granular LiOH canisters reserved for DISSUB use only (if applicable):

- a. A minimum six (6) LiOH curtain kits - SSBN (7 - SSGN) are required to be stowed in the forward compartment.
- b. A minimum seven (7) LiOH curtain kits (8 - SSGN) are required to be stowed in the mid compartment.
- c. Four (4) additional LiOH curtains are required in the forward compartment for crew or riders exceeding normal crew manning of 165 - SSBN (166 - SSGN).

NOTE: EACH KIT CONTAINS 50 CURTAINS WITH DEPLOYMENT HARDWARE. PARTIAL OR OPENED KITS ARE UNSAT.

19. Sodium chlorate oxygen candle quantity and location impacts inspection acceptance criteria. The minimum number of candles shall be obtained from the below requirements:

- a. Oxygen candles reserved for DISSUB use only:
 - (1) Forward candles shall not be less than 116 - SSBN (140 - SSGN) for normal crew manning of 165 - SSBN (166 - SSGN).
 - (2) Mid candles shall not be less than 140 - SSBN (152 - SSGN) for normal crew manning of 165 - SSBN (166 - SSGN).
 - (3) Aft candles shall not be less than six (6) for normal crew manning of 165 - SSBN (166 - SSGN).
 - (4) Any expected crew and/or riders above normal crew manning requires additional DISSUB survivability stores as determined by calculations provided in the applicable SSM once updated. General guidance is to add one and a half (1.5) additional candles for each additional crew or rider beyond normal crew manning. Additional candles shall be stowed in the same compartment (FWD, mid or aft) rider would be stationed during normal underway, crew at rest (mid) and general quarters (FWD & aft), as applicable.

NOTE: STOWAGE OF AN OPENED OR DAMAGED CANDLE OR IGNITER IS UNSAT.

- b. Mission appropriate oxygen candle quantities reserved for NON-DISSUB shall be in excess of quantities reserved for DISSUB. Normal OPs requires a minimum of 10 days of candles, while arctic OPs require a minimum of 20 days. Oxygen candles supporting NON-DISSUB applications may be stowed forward, mid or aft.
 - c. Oxygen candles reserved for DISSUB shall be segregated from NON-DISSUB candles with quantities and location(s) logged by the crew. Note 19 requirements authorize total onboard candles reserved for DISSUB and NON-DISSUB to be less than the ship's COSAL requirement if mission and Note 19 requirements are otherwise met.
 - d. Oxygen candle igniters shall be of a quantity and location (FWD, mid or aft) that supports onboard candle load-out at least one for one.
20. Oxygen candle furnace quantity and location impacts inspection acceptance criteria. The minimum number of furnaces shall be obtained from the ship's COSAL and the below additional requirements:
- a. Furnaces maintained in clean and fully operating condition are necessary for both DISSUB and NON-DISSUB applications as follows:
 - (1) Oxygen furnaces shall not be less than one (1) in each compartment (FWD, mid and aft) for normal crew manning of 165 - SSBN (166 - SSGN).
 - (2) A second furnace is required forward and/or mid respectively if more than 130 crew and riders are assigned forward or 137 crew and riders assigned mid. An assignment is defined as where crew member and rider would be stationed during normal underway, crew at rest (mid) and general quarters (FWD), as applicable.
 - b. Note 20 requirements do not authorize total onboard furnaces to be less than the ship's COSAL requirement.

APPENDIX D
SSN 774 CLASS SUBMARINE SALVAGE INSPECTION
CHECK-OFF LIST

General Information

1. Items pertaining to rescue vehicle seating surfaces and buoy cable angle tests require substantial support equipment and are designated for industrial activity accomplishment.
2. Configuration differences are noted as comments in the reference column.
3. Portions of the Salvage Inspection (as specified by the maintenance activity) may be conducted prior to the start of CNO availabilities as "pre-availability inspections" to support planning of the availability. These items need not be re-inspected provided no work was performed during the availability which affects their status. When specified, these items will be performed by Ship's Force and written certification by the Commanding Officer provided to the maintenance activity, the ISIC, and the Senior Inspecting Officer.
4. The user is directed to use the most current revision of the PMS maintenance requirement.

PART I: SALVAGE

INSPECTION TEAM (SSN 774 CLASS)	Reference Note	Sat	Unsat	Submarine Inspector Signature	Inspection Team Member Signature
<p>1. <u>Salvage Drawings:</u></p> <p>a. Verify salvage drawings:</p> <p>(1) Have been updated during ship's new construction period/last CNO Maintenance Availability or</p> <p>(2) Latest revision is identified in ship's plan index.</p> <p>(3) Have correct distribution.</p> <p>(4) Are identified as Selected Record Drawings</p> <p>2. <u>High/Low Salvage Connections</u></p> <p>a. Verify deck touch plate markings are installed and per plan.</p> <p>b. Check that each valve is free to operate with the inspecting command's salvage wrench.</p>	<p>Navy Modernization Process Management and Operations Manual NAVSEA SL720-AA-MAN-030</p> <p>Ship Dwg. Consolidated Index Number 594 or 845</p> <p>Ship's Plans</p> <p>Notes 1 and 2</p>				

An asterisk (*) will be used in addition to a check mark (✓) in the unsat column to identify any exceptions. An explanation of the exception will be provided with the Salvage Inspection Report, Appendix F of this chapter.

INSPECTION TEAM (SSN 774 CLASS)	Reference Note	Sat	Unsat	Submarine Inspector Signature	Inspection Team Member Signature
<p>c. Perform a "J" pressure and a low pressure 100 psi seat tightness test from the sea side. No leakage is allowed.</p> <p>d. External salvage system caps:</p> <p>(1) Verify the ship's salvage system arrangement plan contains a note that Roylyn type fittings are installed.</p> <p>(2) Remove cap assembly, test connect/disconnect with the inspecting command's female fitting.</p> <p>(3) Inspect all Roylyn caps. Ensure cap operates properly and is free of paint and/or debris. Reinstall cap with safety wire, where applicable.</p> <p>e. Verify strainers are properly installed on all compartment low salvage lines and are clear of debris.</p> <p>3. <u>Internal Air Salvage:</u></p> <p>a. Test satisfactory operation of all internal salvage air valves.</p> <p>b. Verify all compartment pressure gages are in calibration as indicated on calibration label.</p> <p>4. <u>Bulkhead Flappers:</u></p> <p>a. Test satisfactory local and remote (as applicable) operation of all ventilation system bulkhead flappers.</p> <p>5. <u>Hull Access Hatches, Watertight Doors and Torpedo Loading Hatches:</u> Inspection performed by local PMT.</p> <p>a. Perform/witness maintenance required by Planned Maintenance System (PMS) Maintenance Index Page (MIP) to complete salvage inspection and reference the PMT annual inspection.</p> <p>6. <u>External Gagging Devices:</u></p>	<p>Notes 1 and 16</p> <p>Note 3</p> <p>Kaiser Aero Space & Electronics Dwg. 9495 (Formally Roylyn Inc.)</p> <p>Note 4</p> <p>MIP 1671/974, MRCs 7CZF, 7CZG and 7CZH</p>				

An asterisk (*) will be used in addition to a check mark (✓) in the unsat column to identify any exceptions. An explanation of the exception will be provided with the Salvage Inspection Report, Appendix F of this chapter.

INSPECTION TEAM (SSN 774 CLASS)	Reference Note	Sat	Unsat	Submarine Inspector Signature	Inspection Team Member Signature
<p>a. Witness demonstration that all valves with external gagging devices can be gagged from open to shut with the inspecting command's salvage wrench and with the number of turns specified on the ship's salvage system arrangement plan. Record number of turns to operate.</p> <p>b. Witness resetting of each gagging device and demonstrate satisfactory operation of the valves by normal means.</p> <p>7. <u>Air Bank Dew Points:</u></p> <p>a. Verify air samples from all air banks and verify High Pressure Air Compressors are in specification and in periodicity.</p> <p>8. <u>Towing Equipment</u></p> <p>a. Perform Inspection of Towing Equipment.</p>	<p>Notes 2, 5, and 6</p> <p>Notes 6 and 7</p> <p>For SOF hulls: MIP 5542/974 MRC 7CVM (Banks 1 and 2) MRC 7CVN (Banks 3 and 4)</p> <p>For non-SOF hulls: MIP 5542/975 MRC 7AAC</p> <p>(MIP) 5821-774</p>				

An asterisk (*) will be used in addition to a check mark (✓) in the unsat column to identify any exceptions. An explanation of the exception will be provided with the Salvage Inspection Report, Appendix F of this chapter.

PART II: DISSUB 7-DAY SURVIVAL, ESCAPE AND RESCUE

INSPECTION ITEM (SSN 774 CLASS)	Reference Note	Fwd		Aft		Submarine Inspector Signature	Inspection Team Member Signature
		Sat	Unsat	Sat	Unsat		
<p>1. <u>Submarine Rescue Chamber (SRC) and/or Submarine Rescue Diving Recompression System (SRDRS) Fittings:</u></p> <p>a. Verify four rescue vehicle holddown sockets are installed per plan or authorized alteration for all escape trunk seating surfaces. From one socket per hatch, remove capscrew and plug; demonstrate guide is free.</p> <p>b. Remove plug from hatch fairing. Check condition of SRC downhaul shackle. Verify downhaul shackle is free of corrosion and can be operated by hand. Use of plastisol on downhaul shackle is not authorized as it prevents visual inspection of shackle for corrosion and promotes corrosion. The shackle must be powder coated white.</p> <p>c. AN/BQN-13.</p> <p>(1) Inspect AN/BQN-13 Beacon to ensure that:</p> <p>(a) Cable is free of abrasions, cuts or damage.</p> <p>(b) Cable plug and encapsulation are free of defects.</p> <p>(c) Unit has no physical damage.</p> <p>(d) Transducer is free of oil leaks, bubbles and paint.</p> <p>(2) Verify from ship's records that all applicable AN/BQN-13 PMS has been performed and witness satisfactory performance of all procedures (except R-1).</p> <p>(3) Inventory allowance of spare batteries for AN/BQN-13. Ensure shelf life of batteries has not been exceeded.</p>	<p>Naval Ships' Technical Manual (NSTM) S9086-T9-STM-010 Chapter 594</p> <p>Ship's Plans Note 8</p> <p>Ship's Plans Note 8</p> <p>MIP SO-104/902</p> <p>Ship's COSAL Note 9</p>						

An asterisk (*) will be used in addition to a check mark (✓) in the unsat column to identify any exceptions. An explanation of the exception will be provided with the Salvage Inspection Report, Appendix F of this chapter.

INSPECTION ITEM (SSN 774 CLASS)	Reference Note	Fwd		Aft		Submarine Inspector Signature	Inspection Team Member Signature
		Sat	Unsat	Sat	Unsat		
<p>2. <u>Escape Trunks, Logistics Escape Trunks and Forward Lockout Trunks:</u></p> <p>a. Escape trunk hatch fairings must be maintained in a condition to be easily disassembled to support submarine rescue. Verify Planned Maintenance has been completed within the required periodicity on all escape trunk hatches. Visually inspect escape trunk hatch fairings for compliance with the specifications called out in MRC G7YM. Paint fouling or corrosion of fairing fasteners must be immediately corrected. Demonstrate the ability to remove one fastener in each fairing piece required to be removed in the fairing disassembly procedure.</p> <p>b. Demonstrate that each access hatch operates satisfactorily with all respects of locking/unlocking, opening/shutting from below/above (with salvage wrench/handwheel as applicable).</p> <p>c. Demonstrate that each access hatch can be opened with 5th percentile swing force operability criteria for surfaced emergency egress.</p> <p>d. Demonstrate satisfactory operation of the escape hatch closing mechanisms in accordance with the installed instruction plates and equipment.</p> <p>(1) Demonstrate satisfactory installation of Improved Powered Hatch Operator with intensifier and compensator as one mode of hatch operation of Logistics Escape Trunks.</p> <p>(a) Verify inventory of all parts.</p> <p>(b) Verify periodic pressure testing of hoses.</p> <p>(c) Verify proper operation of sensing line and trunk gage.</p> <p>(d) Verify assembly of intensifier and gearbox to upper hatch operator.</p>	<p>Note 10</p> <p>MIP 1671/974, MRC G7YM</p> <p>MIP 1671/974 MRC E4PH</p> <p>Ship's Drawing</p> <p>MIP 1671/974 MRC E4PK</p>						

An asterisk (*) will be used in addition to a check mark (✓) in the unsat column to identify any exceptions. An explanation of the exception will be provided with the Salvage Inspection Report, Appendix F of this chapter.

INSPECTION ITEM (SSN 774 CLASS)	Reference Note	Fwd		Aft		Submarine Inspector Signature	Inspection Team Member Signature
		Sat	Unsat	Sat	Unsat		
<p>(e) Verify installation of upper hatch operator compensator.</p> <p>(f) Demonstrate satisfactory operational check of intensifier pump and gears.</p> <p>e. Demonstrate satisfactory operation and examine the condition of the following equipment:</p> <p>(1) Vent valves (trunk and compartment).</p> <p>(2) Blow valves (trunk and compartment).</p> <p>(3) Flood and drain valves (including remote operation mechanisms and strainer installations).</p> <p>(4) Conduct Hood Inflation System/Stole Charging Valve operational check to confirm valves operate properly. Verify watertight caps installed.</p> <p>(5) Pressure proof lights checked to ensure correct globe sealing, and verified that globe is free from cracks.</p> <p>(6) Electric lantern screened lenses and pressure relief hole sealed with plastic (MIL-I-3064) and mounted above waterline.</p> <p>(7) 31MC installed above waterline.</p> <p>(8) Verify accomplishment of PMS to clear sea pressure sensing lines.</p> <p>f. Verify the following equipment installed:</p> <p>(1) Diver's knife.</p> <p>(2) Ballpeen hammer.</p> <p>(3) Persuader (crows foot).</p> <p>g. Check Flood Line Orifice Size (orifice size is 1.37" for initial trials only).</p>	<p>MIP 5940/905MRC 7DKE</p> <p>MIP 5641/974 MRCs E2PT and E2PU</p> <p>Note 11</p> <p>Note 11</p> <p>Installed</p>						

An asterisk (*) will be used in addition to a check mark (✓) in the unsat column to identify any exceptions. An explanation of the exception will be provided with the Salvage Inspection Report, Appendix F of this chapter.

INSPECTION ITEM (SSN 774 CLASS)	Reference Note	Fwd		Aft		Submarine Inspector Signature	Inspection Team Member Signature
		Sat	Unsat	Sat	Unsat		
<p>(d) Reinstall the protective cap ensuring proper fit.</p> <p>3. <u>Emergency Communications Equipment:</u></p> <p>a. Inventory allowance of the following equipment and confirm proper stowage as indicated:</p> <p>(1) SEPIRB Model T-1630/SRT (2 FWD, 2 aft with Launch Hardware each compartment).</p> <p>b. Verify from ship's records that all applicable PMS has been performed and witness satisfactory performance of indicated MRCs.</p> <p>(1) SEPIRB.</p> <p>4. <u>Life Saving and Safety Equipment:</u></p> <p>a. Inventory allowance (randomly, type and quantity as applicable) and witness satisfactory performance of PMS procedures on the following: (PMS procedures are to be demonstrated on one representative candidate from each of the sub groups listed below).</p> <p>(1) Auto-Inflatable life preservers.</p> <p>(2) Inherently Buoyant life preservers.</p> <p>(3) Man overboard bag.</p> <p>(4) Qualified swimmer designated for man overboard.</p> <p>(5) Safety harness (belts).</p> <p>(6) Safety track.</p> <p>(7) Distress marker lights.</p> <p>(8) Life lines and stanchions.</p> <p>(9) SEIE Suits.</p>	<p>Ship Configuration and Logistics Support Information System (SCLSIS) & COSAL</p> <p>AEL 7-00000A434</p> <p>MIP 4413/015</p> <p>Ship's COSAL Note 12</p> <p>MIP 5832/SUB</p> <p>MIP 5832/030</p> <p>Note 13 MIP 5832/021</p> <p>Note 14 MILPERS MAN Art. 1414-010 Series</p> <p>MIP 6231/001 MRC 2EA0</p> <p>Note 15 MIP 6111/R06</p> <p>MIP 5832/010</p> <p>MIP 6121/SUB</p> <p>MIP 5940/005 MRC 9LQX</p>						

An asterisk (*) will be used in addition to a check mark (✓) in the unsat column to identify any exceptions. An explanation of the exception will be provided with the Salvage Inspection Report, Appendix F of this chapter.

INSPECTION ITEM (SSN 774 CLASS)	Reference Note	Fwd		Aft		Submarine Inspector Signature	Inspection Team Member Signature
		Sat	Unsat	Sat	Unsat		
<p>(10) Crash Bags.</p> <p>(11) Guard Book. (Stored in same locker as Crash Bag.)</p> <p>5. <u>Escape Training:</u></p> <p>a. Verify that all hands are trained in SEIE escape.</p> <p>6. <u>DISSUB 7-Day Survival:</u></p> <p>a. <u>Atmosphere Control:</u></p> <p>(1) Inventory quantity onboard and inspect condition of the following:</p> <p>(a) CO₂ absorbent canisters.</p> <p>Amount onboard for DISSUB:</p> <p>FWD: _____</p> <p>Aft: _____</p> <p>Amount onboard for NON-DISSUB: _____</p> <p>Required: _____</p> <p>Comment on condition and ship's record _____</p> <p>(b) DISSUB LiOH Deployment Kits.</p> <p>Amount onboard:</p> <p>FWD: _____</p> <p>Aft: _____</p> <p>Required: _____</p> <p>Comment on condition _____</p>	<p>MIP 5940/005, MRC 1SC3 and AEL 2-330023072</p> <p>Latest Revision per AEL 2-330023072</p> <p>Note 8</p> <p>AELs 2-3300230 or 2-3300232 series for LiOH product.</p> <p>NON-DISSUB; (e.g., for CO-H₂ After-filter & DQA)</p> <p>Note 17</p> <p>AEL 2-330023035 or 2-330023205 for LiOH Deploy kits.</p> <p>Note 18</p>						

An asterisk (*) will be used in addition to a check mark (✓) in the unsat column to identify any exceptions. An explanation of the exception will be provided with the Salvage Inspection Report, Appendix F of this chapter.

**NOTES
(SSN 774 CLASS)**

1. All high/low salvage valves are to be tested for freedom of operation at the frequency specified, except during the salvage inspection conducted incident to an overhaul. Salvage Air valve testing completed up to one year prior to the start of an availability will satisfy the salvage inspection requirements provided that certified records verifying the tests are available. Written certification by the Commanding Officer that specified external salvage valves have been overhauled by the industrial activity or Ship's Force and have been successfully hydrostatically tested will constitute certification that the valve operates freely, providing all inspections (Part I, items 2.b. and 2.c. of this Appendix) for each valve so certified are satisfactory. If the results of the inspection of operating gear are not satisfactory, or doubt exists concerning freedom of operation, the specific valves in question shall be checked. Provide appropriate container for collecting anti-freeze drained from salvage piping when hull valve is cycled. Ensure controlled re-assembly in accordance with Quality Assurance requirements is performed when installing salvage caps. Exercise caution to prevent liquid in salvage air piping from impinging on nearby equipment when hull valve is cycled. Ensure anti-freeze is added to piping after inspection to prevent freezing.
2. The inspected ship's, vice the inspecting command's, salvage wrench shall be used if the inspecting command is another submarine. Discrepancies in the actual, versus plan, number of turns which are greater than one full turn shall be noted in addition to the number of actual turns recorded.
3. Discrepancies between physical installation and salvage plans are to be reported to the TYCOM with an information copy to all plan holders.
4. Exercise extreme caution when testing operation of 4500 psi compartment pressurization valves.
5. When inspecting the gagging gear for the inboard ventilation exhaust valve and the inboard ventilation induction valve, the valve linkages shall be inspected and the valves shall be adjusted in accordance with the requirements in the Non-Primary Plant Valves Technical Manual or individual ship's valve drawing.
6. Prior to testing Outboard Diesel Exhaust Valve, ensure replacement locking pin is available onboard.
7. On some designs, operation of the gagging device overrides the regular operating gear of the valve indicator in such a manner that the entire mechanism must be reset/readjusted before the normal operating gear or the valve position indicator will function as intended. If the gagging mechanism is operated or used for any reason, the mechanism shall be reset and the valve subsequently opened and closed by the normal operating gear in every manner in which the gear is designed to function to ensure the valve is in proper operating condition.
8. Unsatisfactory conditions degrade the SRC and/or SRDRS capability and require a CASREP be submitted in accordance with reference (a).
9. Shelf life is computed from date of manufacture which is printed in code on the battery. For example, a battery code "1187" means the battery was manufactured in the 11th month of 1987. For expiration dates, see Naval Supply Systems Command Publication 4105, List of Items Requiring Special Handling.
10. One or more of the Logistics and Escape Trunks (LET) will be removed during refit. When removed, the LET is isolated from service air and electric power. Communications circuits, electrical power, and charging manifold tests should be conducted prior to LET removal to ensure piping and electrical system continuity, and tested again upon reinstallation.
11. Diver's knife and ballpeen hammer may be stored in secure stowage in escape compartment.
12. The allowance of escape appliances for submarines with two escape compartments consists of 110 percent of complement in each compartment. Complement for distribution shall be based on most stressing operational scenario compartment manning which is typically normal underway forward and general quarters in the aft compartment.
13. Man overboard bags to be equipped as specified in Man Overboard Casualty Procedures.
14. Man overboard swimmer to be competent swimmer/qualified diver as designated by Commanding Officer.
15. Safety track inspections shall be performed as specified by MIP 6111/R06 (MRC 3JTK) and applicable ship's drawings.
16. "J" pressure and/or seat tightness testing is not required for new construction ships.

17. Lithium Hydroxide (LiOH) canister quantity, location, type and use impacts inspection acceptance criteria. The minimum number of LiOH canisters shall be obtained from the ship's COSAL and the below additional requirements:

- a. Canisters reserved for Disabled Submarine (DISSUB) use only. Prior to Ship Alt SSN4558K completion on SSN 774 - 781, these boats will maintain at least 5-day onboard survivability provisions. After Ship Alt SSN4558K completion, these boats will maintain at least 7-day onboard survivability provisions. SSN 782 and later boats shall be constructed with 7-day onboard survivability provisions.
 - (1) For SSN 774 - 781 prior to Ship Alt SSN4558K, forward LiOH canisters shall not be less than 257 Granular (NSN 6810-00-559-3261) or not less than 166 ExtendAir® (NSN 6810-01-560-3015) for normal crew manning of 132 onboard under the following assigned stations: 120 FWD (Condition: Normal underway) and 15 aft (Condition: General quarters). Relocate DISSUB stores accordingly if assigned stations requires otherwise.
 - (2) For SSN 774 - 781 after Ship Alt SSN4558K completion and boats after SSN 781, forward LiOH canisters shall not be less than 293 ExtendAir®. This provisioning requirement supports crew and Direct Support Element (DSE) riders up to a maximum of 149 onboard personnel under the following assigned stations: 141 FWD (Condition: Normal underway) and 16 aft (Condition: General quarters). Relocate DISSUB stores accordingly if assigned stations requires otherwise.
 - (3) Any expected crew and/or riders exceeding above paragraphs (1) and (2) manning, requires additional DISSUB survivability stores as determined by calculations provided in the applicable Ship Systems Manual (SSM) once updated. General guidance is to add four (4) additional Granular LiOH canisters or three (3) ExtendAir® LiOH canisters for each additional crew or rider that exceeds above paragraphs (1) and (2) manning, as applicable. Additional canisters shall be stowed in the same compartment (FWD or aft) rider would be stationed during normal underway (FWD) and general quarters (aft), as applicable.
 - (4) Forward LiOH canister count reserved for DISSUB shall be either all Granular or all ExtendAir® canisters - no mix.
- b. A minimum of 40 Granular LiOH canisters are required onboard to support NON-DISSUB applications and may be stowed forward or aft. There is no minimum number of LiOH canisters required aft.

EXCEPTION(S): REDUCE TO 30 LIOH CANISTERS FOR CO-H₂ BURNER MAINTENANCE IF DIVER QUALIFIED AIR IS NOT APPLICABLE. FOR SALVAGE INSPECTIONS SUPPORTING SEA TRIALS ONLY: ANY AND ALL ONBOARD LIOH NORMALLY SUPPORTING NON-DISSUB AND NOT SCHEDULED FOR USE DURING SEA TRIALS, MAY BE RE-DESIGNATED/RESERVED FOR DISSUB USE.

- c. LiOH canisters reserved for DISSUB shall be segregated from NON-DISSUB canisters with quantities and location(s) logged by the crew. Note 17 requirements do not authorize total onboard LiOH canisters reserved for DISSUB and NON-DISSUB to be less than the ship's COSAL requirement.

18. The minimum number of LiOH DISSUB deployment kits shall be obtained from the ship's COSAL and the below additional requirements:

- a. For granular LiOH canisters reserved for DISSUB use only (if applicable):
 - (1) For SSN 774 - 781 prior to Ship Alt SSN4558K, forward LiOH curtain kits shall not be less than six (6) for normal crew manning of 132 onboard under the following assigned stations: 120 FWD (Condition: Normal underway) and 15 aft (Condition: General quarters). Relocate DISSUB stores accordingly if assigned stations requires otherwise.

NOTE: A SPARE LIOH CURTAIN KIT IS ALSO STOWED AFT ON THESE BOATS.

- (2) For SSN 774 - 781 prior to Ship Alt SSN4558K, any expected crew and/or riders exceeding above paragraph (1) manning, requires additional DISSUB survivability stores as determined by calculations provided in the applicable SSM once updated. General guidance is to add four (4) additional LiOH curtains for each additional crew or rider that exceeds paragraph (1) manning. LiOH curtain kits

containing these additional curtains shall be stowed in the same compartment (FWD or aft) rider would be stationed during normal underway (FWD) and general quarters (aft), as applicable. Relocate DISSUB stores accordingly if assigned stations requires otherwise.

NOTE: EACH KIT CONTAINS 50 CURTAINS WITH DEPLOYMENT HARDWARE. PARTIAL OR OPENED KITS ARE UNSAT.

- (3) For SSN 774 - 781 after Ship Alt SSN4558K completion and boats after SSN 781, LiOH curtain kits are not applicable. See Note 18b for appropriate DISSUB CO₂ scrubbing assets.
 - b. For ExtendAir® LiOH canisters reserved for DISSUB use only (if applicable):
 - (1) For SSN 774 - 781 prior to Ship Alt SSN4558K, forward ExtendAir® DISSUB Deployment kits (NSN 4460-01-560-1105) shall not be less than three (3) for normal crew manning of 132 onboard under the following assigned stations: 120 FWD (Condition: Normal underway) and 15 aft (Condition: General quarters). Relocate DISSUB stores accordingly if assigned stations requires otherwise.
 - (2) For SSN 774 - 781 after Ship Alt SSN4558K completion and boats after SSN 781, forward ExtendAir® DISSUB Deployment kits shall not be less than six (6). This provisioning requirement will support up to 360 onboard ExtendAir® LiOH canisters located forward.
 - (3) A minimum of one (1) ExtendAir® DISSUB Deployment kit is required to be stowed in the forward or aft compartment for each multiple of 60 ExtendAir® LiOH canisters onboard in those locations (FWD and aft).
19. Sodium chlorate oxygen candle quantity and location impacts inspection acceptance criteria. The minimum number of candles shall be obtained from the below requirements:

- a. Oxygen candles reserved for DISSUB use only:
 - (1) For SSN 774 - 781 prior to Ship Alt SSN4558K, forward candles shall not be less than 108 for normal crew manning of 132 onboard under the following assigned stations: 120 FWD (Condition: Normal underway) and 15 aft (Condition: General quarters). Relocate DISSUB stores accordingly if assigned stations requires otherwise.
 - (2) For SSN 774 - 781 after Ship Alt SSN4558K completion and boats after SSN 781, forward candles shall not be less than 189. This provisioning requirement supports crew and DSE riders up to a maximum of 149 onboard personnel under the following assigned stations: 141 FWD (Condition: Normal underway) and 16 aft (Condition: General quarters). Relocate DISSUB stores accordingly if assigned stations requires otherwise.
 - (3) Aft candles shall not be less than 10 for manning including DSE riders up to a maximum of 149 onboard personnel under the following assigned stations: 141 FWD (Condition: Normal underway) and 16 aft (Condition: General quarters). Relocate DISSUB stores accordingly if assigned stations requires otherwise.
 - (4) Any expected crew and/or riders exceeding above paragraphs (1), (2) and (3) manning, requires additional DISSUB survivability stores as determined by calculations provided in the applicable SSM once updated. General guidance is to add one and a half (1.5) additional candles for each additional crew or rider that exceeds above paragraphs (1), (2) and (3) manning, as applicable. Additional candles shall be stowed in the same compartment (FWD or aft) the rider would be stationed during normal underway (FWD) and general quarters (aft), as applicable.

NOTE: STOWAGE OF AN OPENED OR DAMAGED CANDLE OR IGNITER IS UNSAT.

- b. Mission appropriate oxygen candle quantities reserved for NON-DISSUB shall be in excess of quantities reserved for DISSUB. Normal OPs requires a minimum of 10 days of candles, while arctic OPs require a minimum of 20 days. Oxygen candles supporting NON-DISSUB applications may be stowed forward or aft.

EXCEPTION: FOR SALVAGE INSPECTIONS SUPPORTING SEA TRIALS ONLY: ANY AND ALL ONBOARD OXYGEN CANDLES NORMALLY SUPPORTING NON-DISSUB AND NOT SCHEDULED FOR USE DURING SEA TRIALS, MAY BE RE-DESIGNATED/ RESERVED FOR DISSUB USE.

- c. Oxygen candles reserved for DISSUB shall be segregated from NON-DISSUB candles with quantities and location(s) logged by the crew. Note 19 requirements authorize total onboard candles reserved for DISSUB and NON-DISSUB to be less than the ship's COSAL requirement if mission and Note 19 requirements are otherwise met.
 - d. Oxygen candle igniters shall be of a quantity and location (FWD or aft) that supports onboard candle load-out at least one for one.
20. Oxygen candle furnace quantity and location impacts inspection acceptance criteria. The minimum number of furnaces shall be obtained from the ship's COSAL and the below additional requirements:
- a. Furnaces maintained in clean and fully operating condition are necessary for both DISSUB and NON-DISSUB applications as follows:
 - (1) For SSN 774 - 781 prior to Ship Alt SSN4558K, forward furnaces shall not be less than one (1) for normal crew manning of 132 onboard under the following assigned stations: 120 FWD (Condition: Normal underway) and 15 aft (Condition: General quarters). A second furnace is required forward if more than 127 crew and/or riders shall be forward during normal underway.
 - (2) For SSN 774 -781 after Ship Alt SSN4558K completion and boats after SSN 781, forward furnaces shall not be less than two (2). This provisioning requirement supports crew and DSE riders up to a maximum of 149 onboard personnel under the following assigned stations: 141 FWD (Condition: Normal underway) and 16 aft (Condition: General quarters).
 - (3) Aft furnaces shall not be less than one (1) for manning including DSE riders up to a maximum of 149 onboard personnel under the following assigned stations: 141 FWD (Condition: Normal underway) and 16 aft (Condition: General quarters).
 - b. Note 20 requirements do not authorize total onboard furnaces to be less than the ship's COSAL requirement.

(This Page Intentionally Left Blank)

APPENDIX E

SAMPLE PRE-INSPECTION INFORMATION/CERTIFICATION

From: Commanding Officer, USS (Ship's Name and Hull No.)
 To: Senior Inspecting Officer
 Subj: SUBMARINE SALVAGE INSPECTION OF USS (Ship's Name and Hull No.)
 Ref: (a) COMUSFLTFORCOMINST 4790.3; Joint Fleet Maintenance Manual, Volume IV, Chapter 18
 Encl: (1) SSN 688 Class Submarine Salvage Inspection Check-Off List

1. The overall responsibility for the coordination and assembly of reference plans and publications in support of our submarine salvage inspections is assigned to (preferably the XO, 1st Lt, or Weapons Officer). Our Topside Coordinator is (Name), and our Below Decks Coordinator is (Name).
2. The following information/certification is presented in accordance with reference (a): _____.

Reference:	Inspected Item:	Certification of Ship's Representative:
(a) Encl (1), Part I, para. 2	<u>High and Low Salvage Connections.</u> External Salvage Valves have been overhauled & seat tightness tested.	Date: _____ Tested by: _____ (Overhauling Activity)
(b) Encl (1), Part I, para. 3.b., Part II, para. 2.i.	<u>Gages</u> have been tested or calibrated within the past 12 months. (list any discrepancies in para. 3)	_____ Ship's Force Representative
(c) Encl (1), Part I, para. 6.	<u>External Gagging Devices.</u> Valves will be lined up & reset by:	_____ Qualified Eng. Petty Officer
(d) Encl (1), Part II, para. 1.	<u>SRC/SRDRS.</u> Flatness Test applicability for this scheduled inspection. Submitted for review and verification.	_____ Yes, if applicable
(e) Encl (1), Part II, para. 2.	Escape Trunks. Ship's representative for escape trunk will be:	_____ Ship's Representative
(f) Encl (1), Part II, para. 3.	<u>Emergency Communications Equipment</u> Operational and stowed with the following exceptions:	_____ Yes, or list exceptions in paragraph 2.

Reference:	Inspected Item:	Certification of Ship's Representative:	
(g) Encl (1), Part II, para. 4.	<u>Life Saving & Safety Equipment PMS</u> procedures last conducted on: (List discrepancies in paragraph 3.)	_____	
		Date	
	Inventories are as follows:	Amount on Board	Required (COSAL)
	Number of escape or SEIE valises.	_____	_____
	Location	_____	_____
		(Forward/Aft)	
		Amount on Board	Required (COSAL)
	Inflatable life preservers	_____	_____
	Number of non-inflatable life preservers	_____	_____
		Amount on Board	Required (COSAL)
	Life Rafts (if applicable)	_____	_____
	Number of safety harnesses	_____	_____
	Distress Marker Lights	_____	_____

NOTE: MUST CONFORM TO CURRENT PMS SCHEDULE.

(h) Encl (1), Part II, para. 5.	<u>Escape Training.</u> All hands are qualified in SEIE escape.	_____	
		Yes, or list discrepancies in paragraph 3.	

Reference:	Inspected Item:	Certification of Ship's Representative:
(i) Encl (1), Part II, para. 6.	<u>DISSUB 7-Day Survival</u>	_____
	a. Portable desalinators (Required: 2 FWD and 2 aft):	Amount
	b. Atmosphere Control. The following amount of absorbent is aboard:	_____
	The allowance is:	Type and Amount
	O ₂ candles applicable	_____
	The following number of O ₂ candles are onboard:	Amount
	The allowance is:	Yes or No

		Number or N/A

	Number or N/A	
(j) Encl (1), Part II, para. 7.	c. Atmosphere Monitoring DISSUB O ₂ /CO ₂ Gas Monitors (Analox - Required: 1 FWD and 1 aft):	_____
	<u>Signal Ejector/Launcher</u> operation and Red Submarine Emergency Identification Signal inventory will be accomplished by:	Amount
	Signal Ejector/launcher operation cannot be demonstrated as muzzle is above waterline or ship is in dry-dock. The signal ejector was last operated on:	_____
		Ship's Representative

		(Date)

NOTE: IF EJECTOR WAS NOT OPERATED IN PAST THIRTY DAYS, OPERATION MUST BE DEMONSTRATED BY FLOODING THROUGH MUZZLE WITH FIRE HOSE.

3. Discrepancies.

- a. Discrepancies are as follows:
- b. The following items were not inspected for the reasons given and a waiver is requested:

<u>Nomenclature</u>	<u>Paragraph</u>	<u>Reason</u>
---------------------	------------------	---------------

Commanding Officer
(or By Direction Authority)

(This Page Intentionally Left Blank)

APPENDIX F

SAMPLE REPORT OF SALVAGE INSPECTION FORWARDING LETTER

From: Senior Inspecting Officer
To: Commanding Officer, USS (Ship's Name and Hull No.)

Subj: REPORT OF SUBMARINE SALVAGE INSPECTION OF USS (SHIP'S NAME AND HULL NO.)

Ref: (a) COMUSFLTFORCOMINST 4790.3; Joint Fleet Maintenance Manual, Volume IV, Chapter 18

Encl: (1) Submarine Salvage Inspection Check Off List

1. A (new construction/post CNO Maintenance Availability/Interim Dry-Docking) Salvage Inspection of USS (Ship's Name and Hull No.) was conducted on (Date) using the procedures of reference (a).
2. The following provides amplifying information concerning the (exceptions/discrepancies) identified in enclosure (1). (all exceptions will be discussed)

(Signed)

Copy to: (as appropriate)
COMSUBGRU
COMSUBRON
SUBMEPP (1814)
NAVSHIPYD
SUPSHIP
NAVSEA Program Manager

(This Page Intentionally Left Blank)

VOLUME IV
CHAPTER 19

**RETENTION OF MATERIAL DEFICIENCY REPORTS AND
RECORDS OF EQUIPMENT CHARACTERISTICS AND TESTS**

REFERENCES.

- (a) NAVSEA S9086-G9-STM-000 - NSTM Chapter 231 (Propulsion and SSTG Steam Turbines)
- (b) NAVSEA S9086-HK-STM-010 - NSTM Chapter 241 (Propulsion Reduction Gears, Couplings, Clutches and Associated Components)
- (c) NAVSEA S9086-HN-STM-010 - NSTM Chapter 244 (Propulsion Bearings and Seals)

LISTING OF APPENDICES.

A Bearing Log (Submarines Only)

19.1 PURPOSE. This chapter provides a listing of the inspection reports and equipment records, including the retention requirements, which must be maintained by each ship.

19.2 INSPECTION REPORTS. A copy of each of the following inspection reports will be retained until superseded by a subsequent report:

- a. Board of Inspection and Survey Inspection Reports.
- b. Hull Surveys.
- c. Salvage Inspections.
- d. Docking Reports (CNO Maintenance Availability to CNO Maintenance Availability).
- e. Turbine Lifting and Repair Reports.
- f. Technical Assistance Reports by System Commands, Naval Sea Systems Command Technical Representatives, etc.
- g. Boiler Inspection Reports (retained until equipment is transferred or vessel is stricken. May be discarded if old data is incorporated in a new report).
- h. Battery Inspection Reports.
- i. Diesel Engine Inspection Reports.
- j. Main and Air Ejector Condenser Eddy Current (Probalog) Reports.

19.3 RETENTION OF RECORDS OF EQUIPMENT CHARACTERISTICS AND TESTS. The following records will be maintained onboard until superseded:

- a. Anti Submarine Warfare Test Program Reports.
- b. Structureborne, Airborne and Waterborne Noise Reports.
- c. (Submarine Force surface units only) Radar, Radio and Acoustic Radiation Patterns.
- d. Equipment Calibration and Alignment Graphs and Charts.
- e. Antenna and Superstructure Arrangement Photographs.
- f. Record of Shipboard Tests.
- g. Lube Oil and Trend Analysis Reports.
- h. Battery Record Book (test discharges, etc.).
- i. Diesel Trend Analysis Records.

- j. (Submarines only) Remote Temperature Element (RTE) Alarm Setpoint, Bearing Maximum Operating Temperature, Proximity to RTE Alarm, Installed Bearing Clearance, Actual Bearing Clearance, Bearing Replacement Clearance, Stamped Depth/Thrust Constant, Depth Micrometer Reading, and calculated bearing Wear for Main Thrust Bearings, Main bearings and Journals (required by reference (a) 231-7.2.1) for:
 - (1) Main Propulsion Shafting.
 - (2) Main and Auxiliary Engines.
 - (3) Main Propulsion Motors and Generators.
 - (4) Ship Service Turbine Generators.
 - (5) Reduction Gear (RTE Alarm Setpoint and Bearing Maximum Operating Temperature only).Appendix A will be used to record data.
- k. Readings and Clearances for Main Bearings and Journals:
 - (1) Rudder and Diving Planes.
 - (2) Diesel Generator Bearings.
- l. Navigational Light Certification.
- m. Equilibrium Diagram.
- n. Panama Canal Tonnage Certification.
- o. Aviation Helicopter Certification.
- p. Weight Handling Equipment Certification.
- q. Cavitation Curves.
- r. Machinery/Vibration Survey Results.
- s. (SSN/SSBN/SSGNs only) Resistance Test Records shall be maintained for the following equipment in the Electrical Work Centers PMS Space Manual:
 - (1) Ship's Service Turbine Generators.
 - (2) Ship's Service Motor Generators.
 - (3) 400 Hz Motor Generators.
 - (4) Emergency Diesel Generators.
 - (5) Emergency Propulsion Motors.
 - (6) Secondary Propulsion Motors.
 - (7) Trim/Drain Pump Motors.
 - (8) Main and Shaft Lube Oil Pump DC Motors.
 - (9) High Pressure Brine Pump Motors.
 - (10) Low Pressure Blower Motors.

BEARING LOG

Bearing: _____

Ship: _____

Data Taker		Assembly Documentation			Measured Wear			RTE Alarms			Approval		
1	2	3	4	5	6	7	8	9	10	11	12	13	14
Date	Data Taker (Print Name)	Data Taker (Print Rate)	Data Taker Signature	Max Allowable Wear (Wmax)	Stamped Depth Constant (DC)	Depth Mic Reading (MR)	Measured Wear (=7-6) (W) (=MR-DC)	RTE Alarm Setpoint (ASP)	Max Operating Temperature (from logs) (Tmax)	Safety Margin (=9-10) (20°F min) (ASM) (=ASP-Tmax)	MLPO (initials)	MPA (initials)	ENG (initials)

Notes:

1. For thrust bearings, record the measured thrust clearance in column 7 and maximum thrust specification in column 5.
2. RTE Setpoints are:
 - 270°F for Main propulsion turbine and SSTG thrust bearings.
 - 250°F for Main propulsion turbine and SSTG journal bearings.
 For remaining propulsion plant bearings, 30°F higher than the maximum observed during Sea Trials or the applicable HM&E Test Procedure (i.e., SUBMEPP Test Procedure or annual MRC to verify Setpoints).

IV-19A-1

APPENDIX A
BEARING LOG (SUBMARINES ONLY)

COMUSFLTFORCOMINST 4790.3 REV C

Date	Comments
	<p>Comments: Date each entry. Note the serial number (if any) of this bearing, date of any bearing replacement, nonstandard dimensions, applicable Liaison Action Requests, Departure From Specification if approved, unusual conditions of journal or bearing (if opened), any additional/abnormal readings taken, recent temperatures for this bearing, temperature of lube oil cooler outlet used to set RTE alarm, or any other notes that may be helpful in the future.</p>

BEARING LOG INSTRUCTIONS

Fill out for each Main Engine, Reduction Gear, Line Shaft, and SSTG Bearing.

A logbook should have a section for each piece of equipment (Port/Stbd SSTG, Port/Stbd Main Engine, Reduction Gear, and Line Shaft). To fill out the log, complete the following entries:

1. **Name of ship and hull #:** i.e., USS SEAWOLF, SSN21
2. **Bearing Name/location:** i.e., #1 Propulsion turbine forward journal bearing.
3. **Name and date:** Print the data takers name and the date data was recorded.
4. **Data Taker Signature:** Signature of data taker.
5. **Max Allowable Bearing Wear (Wmax):** The maximum increase in depth micrometer measurement above the stamped depth constant.
6. **Stamped Depth/Thrust Constant (DC) or Bearing Constant:** The depth micrometer reading taken when this bearing was installed, aligned and bolted down. It is found stamped on the bearing bracket near the depth micrometer hole. Thrust constants are normally not stamped. These must be obtained from builders new construction completed test procedures on microfiche or repair activity work documents when replaced.
7. **Depth Micrometer Reading (MR):** Depth measurement taken between machined surface of bearing bracket and top of rotor journal.
8. **Measured Wear (W):** Measured bearing wear. Calculated as $W = MR - DC$. (MR = Depth micrometer reading, DC = Stamped depth constant.) If the measured bearing wear (W) is greater than the maximum allowable wear (Wmax) or wear limit per applicable PMS MRC, then the bearing must be disassembled, inspected and repaired/replaced.
9. **RTE Alarm Setpoint (ASP):** As determined by reference (a) (231-3.10.3.4.3, 231-3.10.3.4.4, and Table 231-3-2) and ships operating logs or by approved shipyard/repair activity test procedure meeting the requirements of the Naval Ships' Technical Manual (NSTM) or SUBMEPP test procedure.
10. **Bearing Full Load Maximum Operating Temperature (Tmax):** The maximum operating temperature noted on the bearing during Post Construction/Overhaul Sea Trial testing in accordance with SUBMEPP/Shipyard test procedure or the latest performance of RTE testing per appropriate NSTM or PMS MRC. The temperature should be compared to observed temperatures during normal ships operations for abnormalities.
11. **Alarm Safety Margin (ASM):** Calculated as $ASM = ASP - Tmax$ (ASP = Alarm Setpoint, Tmax = Maximum normal operating temperature). If the alarm setpoint does not meet the requirements of NSTM references (a), (b) or (c), as applicable, reset the alarms in accordance with the NSTM or SUBMEPP test procedure or PMS MRC, as required, following the guidance of the NSTM.
12. **Comments:** Date each entry. Note the serial number (if any) of this bearing, date of any bearing replacement, nonstandard dimensions, applicable Liaison Action Requests, Departure From Specification if approved, unusual conditions of journal or bearing (if opened), any additional/abnormal readings taken, installed (assembled clearances) and maximum clearances if the bearing is installed by Ship's Force, recent temperatures for this bearing, temperature of lube oil cooler outlet used to set RTE alarm, or any other notes that may be helpful in the future and applicable PMS MRC. Installed assembly documentation is not required to be retained in this log if bearing removal and installation was performed by an IMA, IMF, Regional Maintenance Facility or a Shipyard since data is maintained by those installations and can be obtained by the ship, if required, via ISIC. Ship's are required to obtain initial depth micrometer readings to ensure stamped depth constant is updated any time a bearing is rolled out.

(This Page Intentionally Left Blank)

VOLUME IV
CHAPTER 20

**DIVER LIFE SUPPORT SYSTEMS, SUBMARINE RESCUE CHAMBER AND
DRY DECK SHELTER MAINTENANCE AND CERTIFICATION**

REFERENCES.

- (a) NAVSEA SS521-AA-MAN-010 - U.S. Navy Diving and Manned Hyperbaric Systems Safety Certification Manual
- (b) NAVSEA SS800-AG-MAN-010/P-9290 - System Certification Procedures and Criteria Manual for Deep Submergence Systems
- (c) OPNAVINST 3150.27 - Navy Diving Program
- (d) NAVSEA SS750-AA-MMA-010 - Submarine Rescue Chamber (SRC), Modernized 850 Ft
- (e) NAVSEA S9592-B3-MAN-010 - Dry Deck Shelter Systems Scope of Certification Notebook Volume I

LISTING OF APPENDICES.

- A System Certification Requirements
- B Submarine Rescue Chamber Scope of Certification Items

20.1 PURPOSE. To provide guidance for the proper administration of a uniform maintenance program in support of the certification requirements for Diver Life Support Systems (DLSS), Submarine Rescue Chambers (SRC), Dry Deck Shelters (DDS), VIRGINIA Class Lock-Out Trunks, SSGN Lock-Out Chambers.

20.2 DIVER LIFE SUPPORT SYSTEM MAINTENANCE AND CERTIFICATION.

20.2.1 General. The DLSS maintenance program is split into two distinct categories. The first category consists of portable, surface ship afloat and shore-based surface supplied dive systems, recompression chamber systems and saturation dive systems which are certified by Naval Facilities Engineering Command (NAVFAC) Code 07F and Naval Sea Systems Command (NAVSEA) 00C4 in accordance with reference (a). The second category consists of submarine and Deep Submergence System based DLSS such as the DDS, VIRGINIA Class Lock-Out Trunks and SSGN Lock-Out Chambers which are certified in accordance with reference (b) by NAVSEA 07Q.

20.2.2 Objective. The objective of the certification process is to verify that all dive systems provide acceptable levels of personnel safety throughout the specified operating range when used with approved operating and maintenance procedures. This chapter provides procedures by which repairs, maintenance, and alterations can be accomplished to those systems within the Scope Of Certification (SOC) and in compliance with reference (a).

20.2.3 United States Navy Diving and Manned Hyperbaric Systems Safety Certification. The requirements, procedures, and guidance for the administration of the certification program for all portable, surface ship afloat and shore-based DLSS shall be in accordance with references (a), (c) and (d). Reference (a) provides a single document which:

- a. Identifies the administrative and technical requirements leading to the initial dive system material and system certification.
- b. Documents the requirements for maintaining satisfactory material and operability conditions to support continued Unrestricted Operation to design depth.
- c. Identifies the responsibilities for implementing and executing the certification program policies and procedures.
- d. Provides procedures for requesting waivers to approved operating and maintenance procedures, and for departures from approved system design.

20.2.4 System Certification.

- a. System certification is required for all U.S. Navy diving systems in accordance with reference (c). System certification is a procedure for ensuring the adequacy of the dive system to safely operate over its intended mission range. System certification is accomplished through technical reviews and periodic on-site inspections. Quality Assurance (QA) procedures are used to provide support for System certification through documented maintenance and repair procedures, on-site surveys and material audits.
- b. System certification is required for all dive systems used by the U.S. Navy, except SCUBA. System certification procedures and criteria shall be in accordance with reference (a) or (b), depending on the type of system. Appendix A of this chapter provides a listing of system certification requirements for diving systems and equipment.
- c. The SOC contains a list of all primary, secondary and emergency systems that are required to ensure diver safety. The SOC also includes documentation such as system drawings, operating and emergency procedures, maintenance procedures, and various quality assurance documents required to repair and maintain the DLSS.

20.2.5 Maintenance Guidelines.

- a. Appendix I of reference (a) contains the technical and administrative QA requirements for maintenance of SOC components, performed by Forces Afloat, and shall be used when planning all maintenance.
- b. Technical specifications shall be complied with at all times. For example, when new fasteners are being installed in a system and the applicable plan requires monel fasteners, then substituting stainless steel or any other material type fasteners is not authorized. Temporary repairs with substituted material shall be documented through an approved Departure From Specification (DFS) in accordance with Appendix I of reference (a), and promptly restored to plan specifications.
- c. The following areas of the QA Program are applicable to all dive systems:
 - (1) In-process control of fabrication and/or repair.
 - (2) Procedure preparation.
 - (3) Testing, including retesting.
 - (4) Calibration.
 - (5) DFS.
 - (6) Waivers and deviations.
 - (7) Audits and deficiency corrective action.
 - (8) QA forms and records.

20.2.6 Formal System Surveys.

- a. As the System Certification Authority (SCA) for afloat and portable DLSS, NAVSEA (Code 00C4) shall issue a DLSS certification letter specifying the parameters under which the system shall be operated and maintained. For permanently installed shore-based DLSS, NAVFAC, Code 07F performs this function. The certification letter is renewed periodically after NAVSEA has conducted a formal survey of the system, including; a review of operating and emergency procedures, maintenance records, Re-Entry Control procedures and documentation, Planned Maintenance System (PMS) records, system plans, and on station observation of diving and recompression chamber evolutions. Upon completion of this survey, the NAVSEA/NAVFAC SCA representative will document all identified deficiencies on System Certification Survey Cards (SCSC). These deficiencies require completed corrective action prior to:
 - (1) Category IA Manned use.
 - (2) Category IB System certification.

- (3) Category IC Date indicated to sustain certification.
 - (4) Category ID Must be accomplished on a specified component prior to its use, but the overall system retains its certification.
 - (5) Category II (Desirable) Deficiencies may be corrected at applicant's option.
- b. Corrected Category IA, IB, IC, and ID SCSCs shall be forwarded to NAVSEA Code 00C4, via formal correspondence, with a copy to the Type Commander (TYCOM). The corrected SCSC must be accompanied by the appropriate supporting documentation for clearing the deficiency. The DLSS certification letter will not be issued until all Category IA and Category IB SCSCs are cleared. Diving in pursuit of certification, which includes any manned use of the diving or recompression chamber systems, will not take place until all Category IA cards are cleared, and authorization is received from NAVSEA Code 00C4, or NAVFAC Code 07F. Operational utilization of these systems will not take place until all Category IA and Category IB SCSCs have been cleared, and NAVSEA/NAVFAC has issued a Certificate of Certification. Upon the recommendation of NAVSEA and the TYCOM, the CNO may issue an Operational Waiver to permit diving a system beyond its certification limits in support of high priority operations, if all Category IA cards have been cleared and the outstanding Category IB deficiencies will not compromise personnel or system operational safety. To preclude decertification of a DLSS, all diving commands will conduct and document periodic internal audits. Additionally, the Immediate Superiors In Command (ISIC) will conduct regular monitoring audits and Diving Operational Readiness Assessments of all diving activities under their cognizance, using the attributes contained in Volume V, Part I, Chapter 9 of this manual, and Chapter 2 of this volume. Temporary repairs shall be documented through an approved DFS in accordance with reference (a), Appendix I.

20.2.7 Certification Maintenance Requirements. Requirements for sustaining certification of surface supported diving and recompression chambers are as follows:

- a. Maintain written maintenance, inspection, repair, and replacement records for all SOC items. Re-Entry Control procedures must be followed.
- b. Report any material casualty to equipment within the SOC to the SCA concurrent with the ISIC and TYCOM.
- c. Obtain SCA approval prior to modifying any system or equipment within the SOC. If the systems are permanently installed on board a U.S. Navy vessel, TYCOM approval is required prior to forwarding the request to the SCA.
- d. Maintain a log of all chamber pressurizations including chamber treatments and oxygen and pressure tolerance testing. Report any chamber pressurization beyond 165 feet to the TYCOM and the SCA. Include the circumstances which necessitated such pressurization. This excludes saturation, deep dive and experimental chambers such as the Naval Experimental Diving Unit Ocean Support Facility and Naval Diving and Salvage Training Center Pressure Vessel Assemblies.
- e. Immediately report any diving operations conducted to a depth in excess of the depths authorized in the applicable DLSS certification letter, by message, to the TYCOM and NAVSEA or NAVFAC, with an information copy to the cognizant ISIC. This message will include the circumstances which resulted in exceeding authorized SOC depth.

20.2.8 Action. To maintain the DLSSs in satisfactory material condition and to provide assurance that they will be fully operational, the following is required:

- a. Perform all planned maintenance in accordance with the applicable Maintenance Index Page (MIP)/Maintenance Requirement Cards (MRC). Information contained in applicable equipment technical manuals will be used in conjunction with existing MRCs for accomplishment of PMS.
- b. Accomplish corrective maintenance in a manner which returns the components to the specifications shown by the applicable drawing. Material used in completing any maintenance action shall be as specified in the NAVSEA/NAVFAC approved system/component drawings, technical manuals or other approved documents. Material shall be certified in accordance with Appendix K of reference (a).

NOTE: IF THE VENDOR OR MANUFACTURER SPECIFIED IN THE NAVSEA/NAVFAC DRAWING OR DOCUMENT CANNOT PROVIDE THE REQUIRED SPECIFIC COMPONENT, THEN USE OF A SUBSTITUTE COMPONENT OR MANUFACTURER MUST BE APPROVED BY NAVSEA/NAVFAC, VIA THE TYCOM, USING A DFS. A DFS IS ALSO REQUIRED WHEN MATERIAL OTHER THAN THAT SPECIFIED IN APPROVED DRAWINGS OR DOCUMENTS IS USED.

- c. Document all work performed on SOC items using the applicable forms and procedures provided in Appendix I of reference (a). This applies regardless of whether the work is a planned or corrective maintenance action. Documentation will, as a minimum, include the following:
 - (1) Authorization of Re-entry request.
 - (2) Reason for work.
 - (3) Description of work accomplished, including specific boundaries breached, manufacturing operations performed and retest requirements.
 - (4) System isolation, test boundaries and specific isolations.
 - (5) Information concerning when, where, why and by whom the work was accomplished.
 - (6) Objective Quality Evidence, including new material acceptance and in-process testing and results.
 - (7) Quality assurance validation.
 - (8) Compliance with applicable specifications, drawings, procedures and instructions.
- d. Maintain all work documents as official records in accordance with Section I-7.3 of reference (a). The Documents will be available for inspection by the SCA and QA auditors during this period.
- e. Obtain NAVSEA or NAVFAC Program Manager and SCA approval prior to accomplishing any alteration or modifications to DLSSs. Unauthorized alterations or modifications will automatically revoke NAVSEA certification. In the case of a system which has been refurbished, but not yet certified, unauthorized alterations or modifications could negate previous steps accomplished by the certification process. Alterations or modifications proposed by Forces Afloat will be prepared and forwarded to NAVSEA or NAVFAC via formal correspondence.
- f. When emergency situations occur during DLSS operations that require immediate corrective action and are beyond the scope of a corrective maintenance action, a message shall be sent to the TYCOM, info NAVSEA/NAVFAC, advising of the situation.
- g. Semiannual requalification dives, required to maintain diver qualification, shall be scheduled and completed as required. This serves to exercise the various components as well as to maintain the proficiency of the divers and support personnel.

20.2.9 Commanding Officer/Officer In Charge Responsibilities.

- a. Maintain certification of the DLSS through satisfactory maintenance and material management and accomplishment of all required certification dives.
- b. Ensure all deficiencies identified during a recertification inspection are corrected in an expeditious manner. Category IA and IB deficiencies must be corrected prior to manned use of the DLSS. Category IC deficiencies must be corrected prior to the date on the SCSC. If a deficiency cannot be corrected by the date required on the SCSC, a formal request for an extension of the SCSC Corrective Action date shall be submitted to SCA, with a copy of the request sent to the TYCOM (where applicable).
- c. Maintain diver proficiency, verify completeness of required equipment, and readiness of the DLSS to meet operational requirements.
- d. Establish and maintain a QA program and Re-Entry Control procedures in accordance with reference (a).

20.3 SUBMARINE RESCUE CHAMBER MAINTENANCE AND CERTIFICATION.

20.3.1 Certification.

- a. To meet the intent of references (c), (d), and Volume V, Part III of this manual, and to allow manned operations of SRCs to their designed depth capability, NAVSEA has established a formal certification program. Reference (b) and Appendix B of this chapter provide a listing of items and components NAVSEA has identified as being within the SOC program. Included is the refurbishment of SRCs and the upgrading of the supporting technical documentation. To maintain the SRCs, a formal maintenance program is required to be implemented by Forces Afloat.
- b. SRC maintenance is based on the prevention or correction of system and equipment degradation caused by the effects of exposure and normal use. The maintenance instructions of reference (d) do not cover major repair items such as, structural work on the pressure hull, replacement of seawater piping or penetrations. Work of this magnitude is not routine and should not be performed without NAVSEA concurrence and technical instructions issued to correct the specific problem.
- c. Continued certification of the SRC is based on satisfactory maintenance and compliance with the dive requirements identified in paragraph 20.3.2.h of this chapter. Compliance with these requirements and with the material condition of the SRC will be verified during periodic NAVSEA inspections. The results of these inspections are promulgated by a NAVSEA letter of certification which will identify the requirements to maintain certification and, if required, forward System Certification Cards identifying deficiencies and corrective actions necessary for continued certification.

20.3.2 Action. To maintain SRCs in satisfactory material condition and to provide assurance they will be fully operational in the event of a submarine casualty, the following is required:

- a. Meet the requirements of the NAVSEA certification letter.
- b. Perform all planned maintenance in accordance with the applicable MIP/MRCs. Information contained in Chapter 4 of reference (b) will be used in conjunction with existing MRCs for accomplishment of planned maintenance.
- c. Accomplish corrective maintenance in a manner which returns the components to the specifications shown by the applicable drawing. Material used during any maintenance action shall be as specified in the NAVSEA approved system/component drawings or other approved technical documents. Material shall be certified in accordance with Volume V, Part I, Chapter 6 of this manual.

NOTE: IF THE VENDOR OR MANUFACTURER SPECIFIED IN THE NAVSEA DRAWING OR DOCUMENT CANNOT PROVIDE A SPECIFIC COMPONENT, THEN USE OF A SUBSTITUTE COMPONENT OR MANUFACTURER MUST BE APPROVED BY NAVSEA, VIA THE TYCOM, USING A DFS. A DFS IS ALSO REQUIRED WHEN MATERIAL OTHER THAN THAT SPECIFIED IN APPROVED DRAWINGS OR DOCUMENTS IS USED.

- d. Document all work performed on SOC items using the applicable forms and procedures provided in Volume V, Part III of this manual. This applies regardless of whether the work is a planned or corrective maintenance action. Documentation will, as a minimum, include the following:
 - (1) Name of the person performing the work.
 - (2) Date the work was performed.
 - (3) Reason for accomplishing the work.
 - (4) Applicable drawing number or reference document.
 - (5) Brief description of the work performed.
 - (6) Description of the testing performed and test results.
 - (7) Signature of the officer/Chief Petty Officer responsible for assuring quality of work.
- e. Maintain all work documents as official records for a three year period following completion of SRC refurbishment or in accordance with Volume V of this manual, whichever is longer. The documents will be available for inspection by the SCA and QA auditor during this period.

- f. Obtain NAVSEA approval prior to accomplishing any alteration or modifications to SRCs. The accomplishment of unauthorized alterations or modifications will automatically revoke NAVSEA certification. In the case where an SRC has been refurbished, but not yet certified, unauthorized alterations or modifications could negate previous steps accomplished by the certification process. Alterations or modifications proposed by Forces Afloat will be prepared and forwarded to NAVSEA in accordance with Volume VI, Chapter 3 of this manual.
- g. When emergency situations occur during SRC operations that require immediate corrective action and are beyond the scope of a corrective maintenance action, send a message to the TYCOM, info NAVSEA, advising of the situation.
- h. All SRC operations will be conducted using the procedures provided in chapter 3 of reference (d).
- i. All SRC specific equipment, specialized tool kits for SSN 688/SSN 21/SSBN/SSGN 726 Class submarines, and equipment required to support SRC operations will be maintained in an operationally ready condition.
- j. Commanding Officers/Officers In Charge are responsible for maintaining the certification of the SRC through satisfactory maintenance and material management of the SRC and accomplishment of all required certification dives. Additionally, they shall ensure all deficiencies identified during a recertification inspection are corrected in an expeditious manner. If a deficiency cannot be corrected by the date required, a request for an extension of the dive date shall be submitted to NAVSEA via the TYCOM.

20.4 DRY DECK SHELTER MAINTENANCE AND CERTIFICATION.

20.4.1 Certification.

- a. To meet the intent of references (b), (e), and Volume V, Part III of this manual, and to allow manned operations of DDSs to their designed depth capability, NAVSEA has established a formal certification program.
- b. Maintenance is based on the prevention or correction of degradation caused by the effects of exposure and normal use of the DDS.
- c. Continued certification of the DDS is based on satisfactory maintenance. Compliance with the maintenance and material requirements of the DDS is verified during periodic NAVSEA inspections. The results of these inspections are promulgated by a NAVSEA letter of certification which identifies the requirements for maintaining certification and, if required, will forward System Certification Cards which identify deficiencies and the corrective actions required to maintain certification.

20.4.2 Action. To maintain the DDS in satisfactory material condition and to provide assurance they will be fully operational in the event of a national tasking, the following is required:

- a. Meet all of the requirements of the NAVSEA certification letter.
- b. Accomplish corrective maintenance in a manner which returns the components to the specifications shown by the applicable drawing. Material used during any maintenance shall be as specified in NAVSEA approved system/component drawings, technical manuals or other approved technical documents. Material shall be certified in accordance with Volume V, Part III, Chapter 6 of this manual.

NOTE: IF THE VENDOR OR MANUFACTURER SPECIFIED IN THE NAVSEA DRAWING OR DOCUMENT CANNOT PROVIDE A SPECIFIC COMPONENT, THEN USE OF A SUBSTITUTE COMPONENT OR MANUFACTURER MUST BE APPROVED BY NAVSEA, VIA THE TYCOM, USING A DFS. A DFS IS ALSO REQUIRED WHEN MATERIAL OTHER THAN THAT SPECIFIED IN APPROVED DRAWINGS OR DOCUMENTS IS USED.

- c. Document all work performed on SOC items using the applicable forms and procedures provided in Volume V, Part III of this manual. This applies regardless of whether the work is a planned or corrective maintenance action. Documentation will, as a minimum, include the following:
 - (1) Name of the person performing the work.

- (2) Date the work was performed.
 - (3) Reason for accomplishing the work.
 - (4) Applicable drawing number or reference document.
 - (5) Brief description of the work performed.
 - (6) Description of the testing performed and test results.
 - (7) Signature of the officer/Chief Petty Officer responsible for assuring quality of work.
- d. Maintain all work documents as official records for a three year period following completion of DDS refurbishment or in accordance with Volume V of this manual, whichever is longer. The documents will be available for inspection by the SCA and QA auditors during this period. The parent DDS Sustaining Activity shall maintain custody over these work documents.
- e. Certification of the DDS is the responsibility of the parent DDS Sustaining Activity. It is the responsibility of both the team and the host unit to maintain certification when the DDS is installed on the host unit. Specifics of material and certification maintenance are covered in the applicable Memoranda of Agreement.

(This Page Intentionally Left Blank)

APPENDIX A
SYSTEM CERTIFICATION REQUIREMENTS

Equipment Type	Service Approved	Authorized For Navy Use	Certify
Deep Dive Systems			X
Hyperbaric Research Facilities			X
Recompression Chamber System	Note 1		X
Diving Bells	Note 2		X
Shipboard Surface Supported Diving Air Systems			X
Underwater Breathing Apparatus Used with Deep Dive Systems	X		X
Mixed Gas and O ² Scuba	X		X
Open Circuit Air Scuba		X	
Lightweight Surface Supplied Outfits (Air, HeO ²)	X		Note 3
Deep Sea (Hard Hat) Outfits (Air, HeO ²)	X		Note 3
Diver Life Vests	X		
Diver Operated Tools	Note 4	Note 4	
Diver Held Sonar, Navigation, etc.		X	
Diver Communications		X	
Wet Suits	Note 4	Note 4	
Variable Volume (Dry) Suits		X	
Air Compressors, Filters, etc.		X	Note 5
Diving Accessories (Mask, Fins, Watches, Knives, Compass, Depth Gauges, Weight Belts, etc.)	Note 4	Note 4	

Notes:

1. Service approval shall be obtained for transportable recompression chamber systems procured for fleet use.
2. Service approval shall be obtained for diving bells procured for fleet use.
3. Certification shall be obtained for each type of outfit. Individual outfits need not be individually certified.
4. Requirements are determined by NAVSEA and are based on the potential for hazard to divers, procurement quantities, and Logistic Support considerations.
5. When compressor/diving air systems are permanently installed as components of a diving or recompression system, they shall be included in the SOC. The Commanding Officer/Officer In Charge must ensure that compressors and diving equipment are properly installed and maintained in accordance with reference (a).

(This Page Intentionally Left Blank)

APPENDIX B**SUBMARINE RESCUE CHAMBER SCOPE OF CERTIFICATION ITEMS**

1. Pressure Hull.
2. Ballast Tank.
3. Appurtenances.
 - a. Deadlights.
 - b. Hatches.
 - c. Hull Inserts.
 - d. Padeyes.
4. Seawater Ballast System.
5. Jettison System - Downhaul Cable Cutter.
6. Life Support System - Air Supply and Exhaust System (to certification boundary at ship's SRC air manifold connection).
7. Non-Compensated Equipment Subject to Implosion - Lower Compartment Lights.
8. Downhaul Winch.
9. Communications Systems.
 - a. Sound Powered Telephone.
 - b. Underwater Telephone.
10. Depth Detectors.
 - a. Depth Gage.
 - b. Compartment Pressure Gage.
 - c. Secondary Depth Detecting (Support Ship Fathometer, Umbilical Pay-out Markings).
11. Accessibility to Vital Equipment.
12. Chamber Stability and Buoyancy.
13. Electric Power Systems.
 - a. Normal Power System (to certification boundary at ship's SRC power supply fuse panel).
 - b. Battle Lanterns.
14. Operating and emergency procedures (Reference (d)).
15. Lifting Pendant.

(This Page Intentionally Left Blank)

VOLUME IV
CHAPTER 21
SUBMARINE OXYGEN GENERATING
PLANTS

REFERENCES.

- (a) NAVSEA S9515-AA-MMO-010/021/022/030/040 - 6L16 Electrolytic Oxygen Generator (EOG) Technical Manual, Volumes 1 through 4
- (b) NAVSEA S9515-A1-MMO-010/020/030 - Automated Electrolytic Oxygen Generator (AEOG) Treadwell Corporation Preliminary Technical Manual, Volumes 1, 2 and 3
- (c) NAVSEA S9515-A4-MMA-010/020 - Low Pressure Electrolyzer (LPE) Oxygen Generator Technical Manual Volumes 1 and 2
- (d) NAVSEA S9515-AL-MMA-010/020 - Integrated Low Pressure Electrolyzer (ILPE) Preliminary Technical Manual, Volumes 1 and 2
- (e) NAVPERS 18068 - Manual of Navy Enlisted Manpower and Personnel Classifications and Occupational Standards
- (f) COMNAVSUBFORINST 5400.25 - Standard Submarine Supply Department Organization and Regulations Manual
- (g) COMNAVSUBFORINST 5400.29 - Standard Submarine Navigation/Operations Department Organization and Regulations Manual
- (h) COMNAVSUBFORINST 5400.40 - Standard Submarine Combat Systems Department Organization and Regulations Manual (SSN)
- (i) COMNAVSUBFORINST 5400.41 - Standard Submarine SSBN 726 Class Weapons Department Organization and Regulations Manual
- (j) COMNAVSUBFORINST 5400.47 - Standard Submarine Combat Systems Department Organization and Regulations Manual (SSGN)

21.1 **PURPOSE.** To establish the prerequisites and procedures for qualification of personnel, operation and maintenance of shipboard submarine oxygen generating plants designated 6L16 Electrolytic Oxygen Generators (EOG), 6L16 Automated Electrolytic Oxygen Generators (AEOG), Low Pressure Electrolyzers (LPE) and Integrated Low Pressure Electrolyzers (ILPE).

21.1.1 **Policy.** Type Commander (TYCOM) policy regarding the operation and maintenance is:

- a. All current technical documentation shall be available at the oxygen generator for operator use. As a minimum, the on hand documentation will include reference (a), (b), (c) or (d), as required, and the MRCs that support the installed unit.
- b. Planned Maintenance System (PMS) shall be maintained current to the latest Periodic Force Revision and all scheduled/situational planned maintenance requirements must be accomplished.

NOTE: OXYGEN GENERATOR OPERATORS AND MAINTENANCE TECHNICIANS SHALL BE LIMITED TO THOSE INDIVIDUALS HOLDING THE NAVY ENLISTED CLASSIFICATIONS (NEC) REQUIRED BY REFERENCE (e) FOR THE TYPE OF OXYGEN GENERATOR PLANT OPERATED AND/OR MAINTAINED. REFERENCE (e) REFERS.

- c. At least two qualified operators and one qualified technician shall be onboard during oxygen generator operation. Two qualified operators meet this requirement if at least one of the operators is also a qualified maintenance technician.
- d. **Safety related deficiencies must be corrected prior to oxygen generator operation.**
- e. There shall be a minimum of two qualified Oxygen Clean Workers on board to conduct maintenance on oxygen systems and the oxygen generator (except submarines with LPEs and ILPEs).

- f. For VIRGINIA Class submarines, the following hulls shall be required to maintain a minimum of two qualified Oxygen Clean Workers on board: SSN 776, SSN 777, SSN 778, SSN 779, SSN 782 and SSN 784 or as determined by TYCOM.

21.1.2 Background.

- a. Oxygen generator casualties result primarily from improper maintenance, operation or insufficient operator familiarization with current operating instructions and safety precautions. The recurring nature of these casualties necessitates that positive action be taken to ensure operating and maintenance personnel are properly trained and qualified. Additionally, technical documentation must be continuously updated for use by the ship's oxygen generator operating, maintenance and support personnel.
- b. Naval Sea Systems Command (NAVSEA) and TYCOM Technical Notices and Advance Change Notices (ACN) provide the Fleet with the latest technical information and operating instructions concerning oxygen generators. These Notices and ACNs will remain in effect until cancelled by a subsequent Notice or ACN, or are incorporated as a revision to the applicable technical manual.

21.2 RESPONSIBILITIES.

21.2.1 Immediate Superior In Command.

- a. Ensure assigned units are in compliance with the policy stated in paragraph 21.1.1 of this chapter.
- b. Conduct periodic inspections and audits to ensure that:
 - (1) Operating and maintenance personnel proficiency is being maintained.
 - (2) Technical manuals, operating and maintenance notices and PMS documentation are current.
 - (3) Operation and maintenance is in accordance with this chapter, reference (a), (b), (c) or (d), as required, and the supporting PMS.
- c. Ensure Performance Monitoring Team (PMT) inspectors perform material inspections of the ship's oxygen generators approximately 90 days prior to entry and departure from a Chief of Naval Operations (CNO) Maintenance Availability. The material inspection, prior to the availability, will identify material deficiency corrective actions which must be corrected prior to completion of the availability.

21.2.2 Performance Monitoring Team.

- a. Conduct periodic and pre/post-CNO Maintenance Availability material inspections. Ensure a review of the inspected units Material Maintenance Log is part of the material inspection.
- b. Initiate a quarterly monitoring program for those units receiving an unsatisfactory grade during the material inspection. Maintain the units on the quarterly monitoring program until two consecutive satisfactory evaluations, with no safety related deficiencies noted.
- c. Provide copies of all reports following material inspections, monitoring periods and On Site Analysis Reports to the TYCOM and the ISIC.
- d. Ensure appropriate TYCOM personnel are contacted regarding safety related issues.
- e. Conduct an operational inspection in accordance with the applicable PMS prior to Fast Cruise during a CNO Maintenance Availability. Conduct oral interviews with all oxygen generator qualified personnel to determine individual knowledge levels and training effectiveness. The operational inspection will include:
 - (1) Start up checks.
 - (2) Power-Off maintenance check out.
 - (3) Start up.
 - (4) Operation to maximum allowable amperage.
 - (5) Performance of operational PMS.

- (6) Shutdown.
- (7) Placement in a static condition and restarted.
- (8) Shutdown and purge complete.

21.2.3 Commanding Officer.

- a. Report reduced status in accordance with established procedures any time the personnel requirements stated in paragraphs 21.1.1.c and 21.1.1.e of this chapter cannot be met.
- b. Implement and execute a shipboard training program to qualify and maintain oxygen generator personnel qualifications.
- c. Prohibit operation of the oxygen generators if shipboard procedures are not in compliance with this chapter and reference (a), (b), (c) or (d), as required.
- d. Ensure the Oxygen Generator Material Maintenance Log is maintained and correctly reflects **all** corrective and planned maintenance performed.
- e. Ensure periodic reviews of the Oxygen Generator Material Maintenance Logs are conducted by the Division Leading Petty Officer, Division Officer and Engineer Officer.
- f. Ensure all safety related deficiencies are promptly entered into the Equipment Status Log.
- g. Prior to a CNO Maintenance Availability, ensure the PMT conducts a material inspection of the oxygen generators. Ensure oxygen generators are placed into Lay Up and adequately protected in accordance with Inactive Equipment Maintenance requirements.
- h. Ensure PMT conducts a Post-CNO Maintenance Availability material inspection prior to placing the oxygen generators in electrolysis.
- i. Ensure the PMT conducts an operational inspection in accordance with paragraph 21.2.2.e of this chapter prior to commencing Fast Cruise during a CNO Maintenance Availability. Oxygen generators will be operated by Ship's Force qualified operators as described in paragraph 21.1.1 of this chapter. The oxygen generators will be in a static shutdown condition, pressurized with nitrogen and meet the 3000 PSIG testing requirements of reference (a), (b), (c) or (d), as required.
- j. Ensure electrolysis is secured and units are placed in a safe condition prior to commencing any training drill which may cause a "loss of power" casualty (either normal or alternate power). If the oxygen generators are to be placed in a static condition for the duration of the training drill, ensure normal power will be restored to restart electrolysis, or alternate power will be available to conduct a complete purge, prior to the expiration of the 45 minute hold limitations of reference (a), (b), (c) or (d), as required.

21.3 REQUIREMENTS FOR SHIPBOARD PERSONNEL QUALIFICATION.

21.3.1 Training. Oxygen generator operators and maintenance technicians must be graduates of the training courses required for the appropriate NEC in accordance with the requirements of reference (e).

NOTE: PERSONNEL QUALIFIED TO PERFORM MAINTENANCE ON THE OXYGEN GENERATOR MUST ALSO BE GRADUATES OF OXYGEN CLEAN WORKER SCHOOL (EXCEPT SUBMARINES WITH LPEs AND ILPEs).

- a. The NECs required for EOG installations:
 - (1) NEC 4252: An individual certified to this NEC will have successfully completed EOG Operator/Maintenance Course A-852-0050.
 - (2) NEC 4752: An individual certified to this NEC will have successfully completed EOG Operator/Technician Course A-623-0039.
- b. The NECs required for AEOG installations:
 - (1) NEC 4208: An individual certified to this NEC will have successfully completed AEOG Operation and Mechanical Maintenance Course A-652-0087.

- (2) NEC 4708: An individual certified to this NEC will have successfully completed AEOG Electrical/Electronic Maintenance Course A-623-0008.
- c. The NECs required for LPE installations:
 - (1) NEC 4253: An individual certified to this NEC will have successfully completed LPE Operation and Mechanical Maintenance Course A-652-0190.
 - (2) NEC 4653: An individual certified to this NEC will have successfully completed LPE Electrical/Electronic Maintenance Course A-623-0050.
- d. The NECs and/or course completion required for ILPE installations:
 - (1) An individual certified by either holding NEC 4234 and/or successful completion of ILPE Operation and Mechanical Maintenance Course A-652-0093.
 - (2) NEC 4641: An individual certified to this NEC will have successfully completed ILPE Electrical/Electronic Maintenance Course A-623-0132.

21.3.2 Watchstanding Prerequisites. Prior to being certified as qualified for oxygen generator watches the following watchstander prerequisites must be met:

- a. For 6L16 NEC 4252: Stand watches, under instruction, for a minimum of three (3) six (6) hour watches underway, with the oxygen generator(s) in operation.
- b. For 6L16 NEC 4752: Stand watches, under instruction, for a minimum of one (1) start-up, one (1) shutdown and purge, and one (1) three (3) hour watch underway with the oxygen generator(s) in operation. For technicians, this is a familiarization watch only; technicians qualifying as operators, are governed by paragraph 21.3.2.a of this chapter.
- c. For AEOG NEC 4208: Stand watches, under instruction, for a minimum of three (3) six (6) hour watches underway with the oxygen generator(s) in operation.
- d. For AEOG NEC 4708: Stand watches, under instruction, for a minimum of one (1) start-up, one (1) shutdown and purge, and one (1) three (3) hour watch underway with the oxygen generator(s) in operation. For technicians, this is a familiarization watch only; technicians qualifying as operators are governed by paragraph 21.3.2c of this chapter.
- e. For LPE NEC 4253: Stand watches, under instruction, for a minimum of three (3) six (6) hour watches underway with the oxygen generator(s) in operation.
- f. For LPE NEC 4653: Stand watches, under instruction, for a minimum of one (1) start-up, one (1) shutdown and purge, and one (1) three (3) hour watch underway with the oxygen generator(s) in operation. For technicians, this is a familiarization watch only; technicians qualifying as operators are governed by paragraph 21.3.2e of this chapter.
- g. For ILPE NEC 4234 and/or successful completion of course A-652-0093: Stand watches, under instruction, for a minimum of three (3) six (6) hour watches underway with the oxygen generator(s) in operation.
- h. For ILPE NEC 4641: Stand watches, under instruction, for a minimum of one (1) start-up, one (1) shutdown and purge, and one (1) three (3) hour watch underway with the oxygen generator(s) in operation. For technicians, this is a familiarization watch only; technicians qualifying as operators are governed by paragraph 21.3.2g of this chapter.
- i. Demonstrate an understanding of the approved NAVSEA Oxygen Generator Log Sheets, including the significance of data recorded and operational limits.
- j. Demonstrate a knowledge of corrective action(s) to be taken in the event of sudden changes in equipment operating parameters.
- k. Successfully complete qualifications for the oxygen generator and support systems in accordance with references (f) through (j).

VOLUME IV
CHAPTER 22
SUBMARINE ANTENNA TESTING

REFERENCES.

- (a) NAVSEA S9425-CG-STD-010 - Installation Standards for Submarines

22.1 PURPOSE. To provide Type Commander policy with respect to pressure testing submarine communication antennas and Photonics systems. This policy is not applicable to periscopes, radar antennas and other non-communication masts and cabling. Amplifying information is contained in reference (a).

22.2 BACKGROUND. Submarine antenna and Photonics systems associated cable connections between the antenna and electrical hull fitting are sensitive to seawater intrusion. In the event that seawater enters an electrical hull fitting, radome or other powered component and the system is subsequently powered-on or used for transmission, significant component damage may occur.

22.3 POLICY.22.3.1 Hydrostatic Pressure Testing.

- a. Hydrostatic pressure testing of submarine antennas with cables attached prior to initial installation is mandatory except for buoys and floating wires. This pre-installation test is intended solely to verify the correctness of the final assembly and does not equal or replace the more elaborate acceptance testing required for various individual manufactured components. Submarine communications antennas that are required to be hydrostatic pressure tested are:
- (1) Multifunction Masts, OE-538 (SSNs) and OE-592 (SSBNs/SSGNs).
 - (2) Submarine High Data Rate Mast, OE-562 (SubHDR).
- b. Buoys that are excluded are:
- (1) Submarine Launched One-Way Tactical (SLOT) Buoys (AN/BRT-1 and AN/BRT-1A).
 - (2) Submarine Emergency Position Indicating Radio Beacon (SEPIRB) Buoy (T-1630/SRT).
- c. Floating wires that are excluded are the Buoyant Cable Antenna (AS-3434B(V)3/BRC).

NOTE: THE TOWED BUOY ANTENNA, AN/BRR-6 (SSBN 730 - 738) AND THE AN/BRR-6B (SSBN 739 - 743) WILL BE HYDROSTATIC TESTED BEFORE INSTALLATION ACCORDING TO THE MAINTENANCE MANUAL.

22.3.2 Fleet Maintenance. Maintenance actions conducted by Fleet Maintenance Activities or Ship's Force regarding the watertight integrity test requirements between submarine antennas and their respective hull connectors, shall be as follows:

- a. When the antenna or cable is disconnected or replaced shipboard, the Technical Work Document will include the checks below in the assembly procedure to reconnect the cable to the base of the antenna and/or electrical hull fitting:
- (1) Craftsman verification that surface finishes of O-ring seating surfaces are in accordance with applicable specifications.
 - (2) Craftsman verification that the O-ring is properly installed and in accordance with applicable specifications.
 - (3) For submarine SubHDR and Photonics systems outboard cable removal and replacement, accomplish in accordance with Volume V, Part I, Chapter 7, Appendix B, NOTE 31 of this manual.

- b. Prior to performing a deep dive certification after a maintenance action, passive and/or pre-energize testing shall be performed in accordance with the system specific Technical Manual, SUBMEPP approved Maintenance Standard, SUBMEPP approved Standard Test Procedure or Maintenance Requirement Card (MRC) to ensure the system is not grounded prior to use.
- c. Upon completion of a deep dive certification for a maintenance action, passive and/or pre-energize testing shall be performed in accordance with the system specific Technical Manual, SUBMEPP approved Maintenance Standard, SUBMEPP approved Standard Test Procedure or MRC to ensure the system is not grounded prior to use.

22.4 PROCEDURE.

- a. Upon completion of maintenance and before underway for submerged operations, the ship shall place CAUTION tags on the Main Power Switch or transmit keys for the affected antennas. The Amplifying Instructions for the CAUTION tags will state - "DO NOT OPERATE/TRANSMIT ON THIS ANTENNA UNTIL COMPLETION OF PASSIVE CHECKS FOLLOWING A DIVE TO TEST DEPTH. PASSIVE CHECKS MUST BE PERFORMED PRIOR TO EACH USE UNTIL THE DEEP DIVE IS COMPLETE."
- b. It is understood that in some cases, due to water depth restrictions, the deep dive may not be performed for quite some time. In these cases, the ship should dive to the maximum depth possible and conduct passive checks. Provided the checks are satisfactory, the CAUTION tag may be replaced with one stating - "DO NOT OPERATE/TRANSMIT ON THIS ANTENNA FOLLOWING OPERATIONS GREATER THAN (enter max depth obtained). PASSIVE CHECKS MUST BE PERFORMED PRIOR TO EACH USE UNTIL THE DEEP DIVE IS COMPLETED."
- c. The tag(s) may be removed following completion of a deep dive to test depth and completion of satisfactory passive testing performed in accordance with the system specific technical manuals or Maintenance Index Pages/MRCs to ensure the system is not grounded.

VOLUME IV
CHAPTER 23

GAS TURBINE ENGINE INSPECTION FOR SURFACE FORCE SHIPS

REFERENCES.

- (a) OPNAVINST 9220.3 - Propulsion and Auxiliary Plant Inspection and Inspector Certification Program
- (b) NSWCCD-SSES 9332-GGTB 11 - General Gas Turbine Bulletin Number 11 (Gas Turbine Fleet Representatives)
- (c) NAVSEA S9086-HC-STM-000 - NSTM Chapter 234 (Marine Gas Turbines)
- (d) NSWCCD-SSES 9352-GGTB 0 - General Gas Turbine Bulletin Number 0 (Technical Directive Zero Index)
- (e) NSWCCD-SSES 933-GGTB 3 - General Gas Turbine Bulletin Number 3 (Marine Gas Turbine Logbook and Service Records)
- (f) OPNAVINST 3120.32 - Standard Organization and Regulations of the U.S. Navy

23.1 **PURPOSE.** The Marine Gas Turbine Inspector (MGTI) program is intended to provide for the timely identification of discrepancies prior to Planned Major Maintenance Availabilities, deployments, when mandated by operating hour requirements and to provide technical assistance to operational units when so directed by the Type Commander (TYCOM). This chapter provides the guidance for Marine Gas Turbine inspection requirements, including preparation, procedures, criteria and reporting and is applicable to all gas turbines on fleet surface, amphibious and auxiliary platforms and craft.

23.1.1 **Discussion.** It has long been the Navy's practice for Ship's Force to accomplish as many repairs as possible at the organizational or intermediate levels. This maintenance philosophy requires trained and experienced personnel, capable of identifying problems so that planned and corrective measures can be recommended, planned for and accomplished in a timely manner. To address the need for experienced personnel the MGTI program has been developed. Reference (a) provides the details for the MGTI program.

23.2 **MARINE GAS TURBINE INSPECTOR.**

23.2.1 **Certification.** MGTI inspector certification and recertification requirements outlined in reference (a) are amplified as follows:

- a. MGTI's function as the Naval Sea Systems Command (NAVSEA) Technical Representatives. All their technical decisions and recommendations are made in concert with and fully supported by their appropriate Regional Maintenance Center (RMC).
- b. Upon verification of competency, Naval Surface Warfare Center, Carderock Division – Ship System Engineering Station (NSWCCD-SSES) will issue a 36 month certification. Certification will remain valid provided the MGTI conducts at least two (any combination) of the following: Gas Turbine Readiness Reviews (GTRR), Assessments, pre-deployment inspection, pre-Planned Major Maintenance Availability inspection and attends one MGTI seminar during the previous 12 months.
- c. MGTI certifications will be extended in 18 month intervals. Requests for extension shall be submitted to NSWCCD-SSES with info to NAVSEA 05Z via the TYCOM. By endorsement, the Commanding Officer will certify that the MGTI meets the requirements of paragraph 23.2.1.b of this chapter. A MGTI whose certification has lapsed or been suspended will be required to recertify, under procedures established by NSWCCD-SSES, on a case-by-case basis.
- d. Commanding Officers will ensure MGTIs are afforded the opportunity to attend MGTI seminars and maintain certification. Commanding Officers are also encouraged to nominate to the TYCOM motivated and capable technicians for certification as MGTIs as outlined in reference (a).
- e. A MGTI assigned as ship's company cannot perform inspections as described in section 23.3 of this chapter on that ship. (No inspector will be permitted to inspect himself.)

23.2.2 Authorized Functions and Responsibilities.

23.2.2.1 Naval Sea Systems Command. NAVSEA shall provide technical authority oversight over all marine gas turbines and associated equipment. The designated NAVSEA Technical Warrant Holder shall:

- a. Assure safe and reliable system operation.
- b. Set and enforce all technical requirements.
- c. Approve all major Departures from Specifications (DFS).

23.2.2.2 Naval Surface Warfare Center, Carderock Division. NSWCCD shall:

- a. Provide support to NAVSEA for the MGTI programs. Ensure that the required technical documentation to support the MGTI Inspector programs is maintained current.
- b. Establish and monitor the requirements and standards for routine and industrial inspections of marine gas turbine systems.
- c. Develop, implement and maintain a program to train and certify MGTIs.
- d. Ensure that inspections of newly constructed ships and ships undergoing major overhaul and/or conversion are conducted in accordance with this instruction.
- e. Conduct periodic technical audits of the MGTI Training Course.
- f. Provide management of technical data, gas turbine history and the associated repair management information database system.
- g. Conduct the semi annual MGTI seminars.
- h. Maintain a roster of all certified MGTIs by name, rating, duty station, date of certification and expiration date of certification. Revoke inspector certification and initiate action to decertify inspectors who fail to comply with requirements of reference (a).
- i. Ensure that the requirements for MGTI certification, recertification and certification extensions are met prior to final approval.
- j. Provide technical oversight and management of the MGTI and NSWCCD Life Cycle Engineering Manager programs:
 - (1) Establish and enforce requirements for MGTI certification and recertification.
 - (2) Ensure periodic MGTI seminars are conducted.
 - (3) Ensure periodic technical audits of all Integrated Logistics Support documentation and Training.
 - (4) Maintain the Gas Turbine Management Information System WEBLOG.
 - (5) Routinely evaluate and ensure state of the art inspection, maintenance and repair tools and techniques are used.

23.2.2.3 Fleet Commander. The Fleet Commander shall:

- a. Identify and designate those fleet activities which have inspection responsibilities and maintain a base of certified MGTIs within those activities.
- b. Ensure the availability of “school ships” to support MGTI Inspector training.
- c. Host the semi-annual MGTI seminars on an alternating coast basis.

23.2.2.4 Regional Maintenance Center. The RMC shall:

- a. Provide certified MGTIs to perform inspection.
- b. Review the guidelines and inspection requirements for all gas turbine inspections required by this instruction and ensure that each inspection report is recorded and updated into the Gas Turbine Management Information System.

- c. Schedule and coordinate inspections of all marine gas turbine systems required by this instruction with the appropriate technical activities to avoid the unnecessary opening of gas turbines.
- d. Provide a qualified MGTI when requested by the ship, Immediate Superior In Command (ISIC) or TYCOM.

23.2.2.5 Regional Maintenance Center Commanding Officers. RMC Commanding Officers shall:

- a. Coordinate inspections in cognizant maintenance areas.
- b. Maintain an up-to-date status of required marine gas turbine system inspections which shall include the latest inspection for all ships assigned to RMCs in their respective area of responsibility.

23.2.2.6 Immediate Superior In Command. The ISIC shall:

- a. Monitor the follow-up action required to correct noted discrepancies by randomly sampling the ship's deferred maintenance action file and most recent gas turbine inspection report.
- b. Assist Commanding Officers in arranging for the corrective action of items beyond the capability of Ship's Force, when requested.

23.2.2.7 Ship Commanding Officer/Officer In Charge/Maintenance Team. Ship Commanding Officers/Officers In Charge/Maintenance Team shall:

- a. Request gas turbine inspections.
- b. Prepare for scheduled inspections to include required operational testing.
- c. Review inspection results and initiate corrective action for those items within Ship's Force capability. Initiate requests for the correction of items beyond Ship's Force capability. If any of the discrepancies cannot be corrected within 72 hours following completion of the inspection, or if said discrepancies will impact the ship's operational schedule, initiate a Casualty Report for the affected gas turbine(s).
- d. Assess the impact (if any) of corrective action on operating schedules and advise the operational commanders. Decide (with repair activities) the optimum timing of repair actions to minimize impact on operating schedules.
- e. Submit reports.
- f. Schedule gas turbine inspections as required by appropriate Planned Maintenance System (PMS)/Class Maintenance Plan item.

23.2.2.8 Marine Gas Turbine Inspectors. MGTIs are authorized and responsible for, but not limited to, performing the following:

- a. Perform periodic intermediate level inspections per Gas Turbine Bulletins (GTB) and Ancillary Equipment Bulletins.
- b. Perform GTRR, Assessments, post casualty investigations, pre-deployment inspections and pre-Planned Major Maintenance Availability inspections.
- c. Provide troubleshooting assistance to ships and Fleet Maintenance Activities (FMA).
- d. Oversee in-place gas turbine repairs if currently qualified for the specific repair.
- e. Oversee Gas Turbine Technical Directive installations.
- f. Monitor compliance with configuration status accounting and technical directive reporting requirements.
- g. Make engine changeout recommendations to NSWCCD-SSSES via the RMCs.
- h. Act as team leader (if currently qualified for specific repairs) for in-place gas turbine repairs and gas turbine changeout if attendant FMA does not have a team leader qualified for the specific repair.
- i. MGTIs are part of the technical authority chain-of-command and are accountable to the NAVSEA Technical Warrant Holder for the performance of their inspection duties.

NOTE: THE SHIP'S FORCE MGTI CAN ONLY ACCOMPLISH SPECIAL INSPECTIONS AND OPERATIONAL ASSESSMENTS ON THEIR OWN SHIP. THE SHIP'S FORCE MGTI WILL ASSIST THE RMC MGTI DURING ROUTINE AND AVAILABILITY RELATED INSPECTIONS. THE SHIP'S FORCE MGTI MAY NOT INDEPENDENTLY CONDUCT ROUTINE, STRENGTH AND INTEGRITY INSPECTIONS ON THEIR OWN SHIP.

23.3 GAS TURBINE INSPECTIONS AND REQUIREMENTS.

23.3.1 Applicability.

- a. All gas turbine engines on surface, amphibious or auxiliary platforms or craft of the force will be inspected as prescribed in this section.
- b. Frequency of inspections of gas turbine installations by a certified MGTI will be scheduled by the Commanding Officer and conducted in accordance with references (a), (b) and (c), established PMS and GTB Inspection requirements as listed in reference (d). ISIC/TYCOM guidance may be solicited to avoid scheduling conflicts.

23.3.2 Pre-Planned Major Maintenance Availability.

- a. Prior to planned Depot level maintenance availabilities, a routine inspection should be performed on all ship's gas turbine engines to determine maintenance or overhaul requirements. Where possible TYCOM/ISIC should ensure there is adequate time set aside in the ships employment schedule to support these inspections.
- b. Results of this inspection will be entered into the ship's Current Ship's Maintenance Project (CSMP) and will enable the ship to submit work requests for work accomplishment by FMAs/industrial activities during Planned Major Maintenance Availabilities.

23.3.3 Pre-Deployment.

- a. Gas turbine engines shall be inspected by a certified MGTI prior to deployment. A deployment is defined as scheduled operational commitments of 90 days or greater away from a ship's homeport.
- b. Discrepancies resulting from this inspection will be entered into the ship's CSMP. Noted discrepancies provide the basis for but do not limit the work to be accomplished by Ship's Force and/or FMAs prior to deployment. A follow-up inspection may be scheduled 30 to 60 days before deployment or as operational commitments dictate to verify the status of repairs. The requirement to conduct a follow-up inspection will be determined by the MGTI. Follow-up inspections will be conducted when possible by the same MGTI who conducted the initial inspection.

23.3.4 Gas Turbine Bulletin Inspections.

- a. GTB Inspections are determined by engine operating hours and require scheduling 60 days prior to the inspection. Operating hours updated monthly in the Marine Gas Turbine Information System WEBLOG via reference (e), are the engine hours used to determine inspections.
- b. Reference (d) lists all Technical Directives and their revisions/amendments.
- c. When GTB inspections are required coincidence with pre-availabilities or pre-deployments, they should be coordinated with pre-availability or pre-deployment inspections to minimize duplicate effort and optimize inspections.
- d. Any ship not able to complete required GTB Inspections within the required periodicity will request a DFS from the TYCOM.

23.3.5 Casualties. Ship's Force shall conduct the initial investigation after a casualty in accordance with current directives. If Ship's Force is unable to identify the cause of the casualty or repairs required, a certified MGTI or an RMC Technical Representative shall be requested to verify the nature of the casualty, investigate for cause and make recommendations for repairs. This may be a partial inspection covering failed areas only. However, the MGTI must ensure the inspection is sufficient in scope to determine the full extent of damage and necessary repairs.

23.4 REQUESTING PROCEDURES.

- a. Gas turbine inspections are to be scheduled by the ship in accordance with PMS, GTBs or ISIC/TYCOM directives.
- b. Requests for scheduling of routine inspections shall be submitted utilizing Automated Work Requests with primary and alternate dates provided. Inspections normally take three to seven working days to complete. Requests for non-routine inspections may be submitted by naval message, Automated Work Request, or telephone, as the situation requires, to the ISIC or TYCOM.
- c. Scheduling requests should be submitted a minimum of 60 days prior to the desired dates of routine inspections.
- d. Gas turbine inspections may be conducted in conjunction with assessment programs scheduled by the ISIC or TYCOM.

23.5 PREPARATION FOR INSPECTION. The MGTI shall send out a preparation package 30 days prior to the inspection.

23.6 INSPECTION PROCEDURES.

23.6.1 Post Casualty Inspections. For post casualty inspections, the Commanding Officer, Engineer Officer, Main Propulsion Assistant (MPA) and leading Gas Turbine Technician (GS) should meet with the inspector on his arrival and, where possible, the Engineer Officer, MPA and leading GS should accompany the MGTI during the inspection.

23.6.2 Pre-Availability Inspections. For pre-availability inspections, pre-deployment inspections, GTRR and Assessments, the MPA and the leading GS should meet and where possible, accompany the MGTI during the inspection.

23.7 INSPECTION CRITERIA. Deficiencies and out-of-specification readings or observances noted should be immediately corrected or recorded as specified in the applicable bulletin(s) and reinspections scheduled. Three categories of deficiencies shall be recorded as follows:

23.7.1 Repair Before Operating. A Repair Before Operating (RBO) is any condition existing that if left unattended, would definitely pose a hazard to personnel safety. Only a MGTI that is currently certified may issue a RBO. RBO deficiencies require reinspection by a MGTI that is currently certified after repairs and before the gas turbine engine is operated. DFS will not be approved for RBOs. If there is not an immediate or near future danger to personnel, the discrepancy shall be assigned as SEVERELY DEGRADED with major operational restrictions. Any condition which is designated as SEVERELY DEGRADED and is considered for a DFS submission, is a Major DFS and must be brought to the attention of the NAVSEA Gas Turbine Technical Warrant. A Major DFS must be forwarded for NAVSEA review and approval with accompanying engineering analysis recommendations from the originator. A gas turbine with a SEVERELY DEGRADED condition cannot be operated until it is corrected/repared and reinspected unless it has been properly approved as a Major DFS. The following items are examples of RBO items and **are not to be construed as a complete list.**

- a. Conditions existing that if left uncorrected would definitely result in an uncontained failure of the engine.
- b. Lube oil leaks that exceed maximum limits in GGTB 17.
- c. Exhaust duct crack(s) that may allow exhaust leaks into ship compartments.
- d. Fuel Oil leaks that pose risk of ignition.
- e. Loss of structural integrity in intake or exhaust ducts which may result in personnel injury.

23.7.2 Major Deficiencies. Conditions exist that if left unattended would result in significant damage to equipment. A Major DFS must be submitted for continued operation and discrepancies **must** be entered in CSMP and scheduled for correction at earliest opportunity. The following items are examples of major items and are not to be construed as a complete list.

- a. Bent/broken/binding VSV vane actuation arms.
- b. Improperly rigged or worn VSVs and bushings.

- c. Chafed fuel oil or lube oil lines. (Beyond serviceable limits of GGTB 6)
- d. Stall (tip clang)
- e. Bent or damaged blades.
- f. Loose/missing casing split line bolts.
- g. GTB inspection periodicity/time limits exceeded.
- h. Combustor liner out of specifications.
- i. Eroded turbine section beyond serviceable limits.
- j. Vertical and/or side mount out of specifications.
- k. Fuel nozzles not maintained in accordance with PMS.
- l. Broken cannon plugs.
- m. Foreign Object Damage screen with cracks or missing wires that are beyond serviceable limits.

23.7.3 Minor Deficiencies.

- a. Deficiencies exist which do not adversely effect reliability, performance or safety of the engine or operating personnel. These deficiencies, if not corrected, could result in gradual deterioration of the engine, reduced efficiency and eventually major repairs.
- b. Gas turbine engine can be operated with no restrictions. Discrepancies shall be entered in the CSMP and scheduled for correction at earliest opportunity.

23.8 INSPECTION RESULTS. Upon completion of inspections, the MGTI will brief the Commanding Officer, Engineer Officer, MPA and senior GS of the results. Provide information for inclusion into the ships CSMP.

- a. Any RBO will be noted in Block 35 of the OPNAV 4790/2K.
- b. The engine cannot be started until RBO repairs are complete and re-inspected by an MGTI.
- c. A formal GTRR report shall be submitted to the TYCOM Code N434 via the Navy Propulsion website (<https://propulsion.navsses.navy.mil>). All Gas Turbine GTRR reporting to be in compliance with the latest revision of reference (b).

VOLUME IV
CHAPTER 24
WOOD HULLED SHIPS AND CRAFT

REFERENCES.

- (a) NAVSEA S9086-DA-STM-000 - NSTM Chapter 100 (Hull Structures)
- (b) NAVSEA S9086-VG-STM-010 - NSTM Chapter 634 (Deck Coverings)
- (c) MIL-S-24340 - Polyurethane (Polyether Base) Deck Sealing Compound
- (d) NAVSEA STD DWG 805-921806 - Installation of Planking on Deck Plating
- (e) NAVSEA S9086-VD-STM-010 - NSTM Chapter 631 (Preservation of Ships In-Service - General)

24.1 **PURPOSE.** This chapter contains procedures for the inspection, repair and maintenance of wood decks and structures on wood hulled ships and craft.

24.2 **WOOD DECAY.**

24.2.1 **Primary Causes.** Wood decay is caused by a fungus growth which breaks down the cell structure within the wood. This fungus thrives in fresh water but its growth is significantly retarded by salt water. Wood decay generally occurs in those spaces which are poorly ventilated and where fresh water has gained access. Poor drainage, allowing fresh water to stand, even in small amounts, is particularly hazardous. The primary causes of wood decay found in ships using wood for hulls, decking and structures are identified below.

- a. Insufficient ventilation and air circulation especially in spaces plagued by dampness and high humidity (i.e., chill room platforms, and areas around fresh water tanks).
- b. Obstructed drain pipes, scuppers, limbers, and drain holes.
- c. Uncaulked or poorly maintained deck seams, especially around plywood decking and deckhouse areas.
- d. Washing down with fresh water.
- e. Depressions in the deck from sanding which allows fresh water to stand.
- f. Leaking plumbing especially in heads, water closets, and food preparation areas.

24.2.2 **Recognition.** Decay in the deck and hull structure is often concealed and hard to detect. It is usually not recognizable by visible fungus except in joints between surfaces. Decay may be suspected if paint coating is discolored or the wood surface is cupped. The affected wood has a pronounced stringy, fibrous appearance. Thoroughly decayed wood is brittle which, when dry, breaks easily across the grain with a distinct brash fracture and may crumble into powder. Black stains spreading along the grain from ferrous metal fastenings are usually a result of chemical reactions instead of from decay fungi. Testing procedures for suspected decay areas are detailed in reference (a).

24.2.3 **Preventive Measures.** Detailed preventive measures are described in reference (a). General preventive measures for the reduction of wood decay are identified in the following paragraphs, and should be accomplished by Ship's Force.

- a. Correct/remove all interference with complete water run off.
- b. Repair fresh water leaks in plumbing drains and fresh water supply systems.
- c. Maintain ventilation system in proper operation. Ensure ventilation system filters are kept clean, maintained clear of all foreign material, and ventilation terminals remain open.
- d. Carefully caulk and maintain deck seams, especially around plywood decking, deckhouse, hull fittings and foundation areas.
- e. In fair weather, open hatches and deck plates to supplement the air circulation.
- f. Remove wet dunnage or shoring in below deck spaces and permit to dry.

- g. Avoid washing down with fresh water. Use only salt water due to its preservation values.
- h. Wash down the ship/craft with salt water following periods of inclement weather to eliminate fresh water and restore salt washed away by the rainfall.
- i. Avoid heavy build up of paint.
- j. Check MCM bilges and accessible voids for standing fluids once each watch. Identify and correct any leaks and promptly remove any fluids. MCMs are designed to operate with dry bilges. Prolonged contact with fluids will result in wood swell, which can lead to external glass reinforced plastic delamination, planking damage, and machinery misalignment.

24.2.4 Corrective Measures.

- a. Treat new wood, used during new construction or in repaired areas, with a copper naphthenate preservative. This product is produced in a clear and colorless form or in a bright green color. The green preservative has a higher level of copper and is considered to be the more durable and efficient of the two preservatives. If the treated wood is to be varnished, finished with light-colored paints or left bare, use the clear preservative since the green color will bleed through varnishes and light-colored paints.
- b. Build up a heavy concentration of the preservative with a series of three or more heavy applications using a brush, spray or immersing the wood in a preservative filled tank. On-going protection requires periodic application of the preservative to bare wood structures at about five-year intervals. Wood treated on this basis will last indefinitely.
- c. Early identification of decayed areas will allow damaged wood to be treated with an anti-decay product that will harden up the soft wood and prevent the further spread of decay. The product, available commercially, is a two-part mixture with deep penetrating properties that fills wood pores with a capillary action.
- d. Before a wood structure is so badly decayed that its replacement is necessary, a possible long lasting repair is made by drilling a series of 1/4" to 3/8" diameter holes in and around the affected areas and gravity feeding the anti-decay mixture in sufficient quantity to allow total penetration of the damaged area. A guide for proper application of this product is provided with each repair kit. Avoid removing or disturbing bad wood during repairs, since the original wood, whether good or bad, serves as a container for the product and preserves the shape and size of the affected member. Initial curing of the product takes place about one hour after application. Total curing takes place after one week, at which time the treated wood resembles petrified wood and the growth of rot in the treated area is effectively stopped. Repairs should be accomplished by Ship's Force during regular maintenance periods.

24.3 DECK AND HULL MAINTENANCE.

24.3.1 Inspection Requirements. With reasonable care, wood hulled ships can give many years of economical service. Make frequent inspections to detect any leaks beneath the covering board, around the deckhouse areas and seams in the deck planking. Reference (a) lists general maintenance requirements for wood hulled ships.

24.3.2 Maintenance Policies. Specific maintenance policies and repair practices are described in the following paragraphs.

- a. As a general policy, because of the ever present risk of decay developing beneath any wood coating, leave wood strip planked decks uncoated and unpainted.
- b. Limit the cleaning of wood decks to scrubbing with mild detergents and salt water. Never use fresh water for wash-downs since it encourages growth of decay producing fungi. Do not use strong detergents, acids, and bleaches for deck cleaning. Do not sand decks.
- c. Set up a routine of daily wetting down of wood strip planked decks with salt water. This wetting down causes strip deck planking to remain swollen and creates a tighter fit between planks. Wetting down is especially necessary during warm weather periods when the sun's heat will quickly dry out the deck planking. Do not allow water to accumulate in deck recesses for any length of time.

- d. Cover all plywood decks with a coating in accordance with the application and deck preparation procedures of reference (b).
- e. Planking renewal will be approved by the TYCOM only on the basis of a technical survey that has positively shown specific need and complete justification for such renewal. Often used general terms such as "Rotten and Worn" are not considered sufficient justification. The technical basis for planking renewal shall be formed in the following manner:
 - (1) Drill test bore holes in weather deck areas to find planking thickness in specific areas where plank wear is suspected. If the planking is not worn beyond the limits set forth in reference (b), the planking will not be renewed unless other extenuating and justifiable circumstances dictate, and replacement is authorized by the TYCOM.
 - (2) Take boring plug samples of planking suspected of being decayed. Notify the TYCOM of inspection results.
 - (3) Once planking has reached the maximum wear limits (found by bore test), the TYCOM will determine the need to replank or apply a deck coating.
- f. So far as practicable, repair deck leaks by recaulking deck seams.
- g. When deck planking wear limits have been reached, and other factors such as extensive deck leaks suggest use of a deck covering, a coating of polyurethane deck overlay may be used. Non-skid material must be Naval Sea Systems Command approved material compatible with the deck overlay as defined in reference (b).
- h. Reset metallic planking fasteners when fastener heads are level with, or protrude above, deck level. Where the planking level is within 1/4" or less of fastener head, filling with seam filler vice wooden plugging is authorized. Where bung plugs are installed, they shall be set in black polyurethane seam filler per the requirements of reference (c).
- i. Ships currently having polysulfide or polyurethane coated strip deck planking in good condition shall continue to use the applied covering. Make minor repairs to this polyurethane coating as necessary using either a polysulfide or polyurethane repair kit. When the polysulfide covering is no longer economically repairable, replace it with a polyurethane type coating. Repairing cracks and holes in impervious deck coatings shall be accomplished as soon as practical. Failure to do so will lead to deck rot and costly repairs.

24.3.3 Deck Covering Repairs. Interior and exterior deck covering material is prescribed by Military Specifications and will be installed only as approved by the TYCOM. Repair previously installed deck coverings as necessary. Reference (b) prescribes approved materials and preparation procedures for wooden decks.

24.3.4 Caulking Techniques. Removal of old caulking from leaking seams and recaulking is the standard method for repairing deck leaks. Fill the caulked seams with a black polyurethane seam filler, per the requirements of reference (c). Before filling, caulk the seams with sufficient cotton. Seam out gaging (beveling) as specified in reference (d). Detailed instructions concerning equipment used, the preparation of seams, the method of application and primers to be used are described in reference (b).

24.3.5 Weather Deck/Planked Deck Repair.

- a. Remove all loose or decayed cotton or oakum caulking after removing all seam filler. In areas where caulking is found to be in good condition, set this material deeper into the seam opening, ensuring it is driven in solidly to make room for additional caulking.
- b. Small, tight seams will require a new single thread of cotton. The size of the seam in width and depth determines the amount of cotton or oakum required. Install sufficient cotton and/or oakum so that the level of the top of the caulking is 1/4" to 3/8" below the surface of the decking. This will allow room for the seam filler.
- c. Unless marine glue (pitch) is used as a seam filler, seal the surface of the caulked cotton or oakum with a special seam primer that is compatible with the seam filler. Do not use a rubber type seam filler over oakum.

- d. Prime or fill newly caulked seams at the end of each day's caulking to keep moisture out of the caulking material and to protect the dry surface of the deck plank seams.
- e. Rubber type seam fillers that are installed in seams with a caulking gun must also be hand worked into the seam with a putty knife. This is necessary to eliminate air pockets and voids in the seam. Hand working of the seam filler must be in one single direction to avoid air pockets.

24.3.6 Underwater Planking Repairs.

- a. The forward and after rabbet shall receive a thorough inspection. The rabbet seam in the stern area is covered with an anchor chafe plate and is not available for inspection or repair unless the anchor chafe plate is removed. Slack or rotten caulking allows for infestation of marine burrowers and decay which, in the case of the rabbet seams forward, goes undetected.
- b. Inspect and test caulked plank seams covered with bottom sheathing for soundness whenever areas are exposed due to the removal of sheathing. In most cases the seams have been covered for many years and have not been available for periodic maintenance. These seams, although covered with sheathing, do eventually waste away or become slack. The seams at the planking butts are more susceptible to slackening and erosion due to movement at the joints. Under normal conditions, it is necessary to recaulk these joints every 10 to 15 years.
- c. If the outer strand of oakum caulking appears to be satisfactory, then the seam may be repaired by setting the existing caulking deep into the seam and adding more strands of oakum to fill the seam depth. If the old caulking is wasted away or decayed, clean out the seam and remove all caulking and residue to make room for the new material.
- d. Before filling the newly caulked seam with a seam compound, paint the oakum and seam with anti-fouling paint. Painting the seam protects the oakum from marine burrowers and primes the wood in the way of the seam filler. Painting the oakum produces a hard surface finish which also makes a water barrier necessary for the protection of the oakum.

24.4 SURFACE PREPARATION AND PAINTING.

24.4.1 General Techniques. The greatest single factor affecting the performance of any paint system is the method and care used in the preparation of the surface to be coated. The preservation of wooden ships presents some unique problems not encountered in other types of ships. Reference (e) provides guidance for surface preparation materials and methods of application, techniques, and general safety precautions for painting.

24.4.2 Preparation and Painting Policies. Specific TYCOM policies pertaining to the preparation and paint application are identified in the following paragraphs:

- a. The use of torches to blister the existing paint coating for removal is authorized; however, care shall be taken to guard against damage to other items or equipment in the vicinity. Avoid application of heat on or near items such as electric wiring, plastics, gaskets, and all flammable materials. Use only enough heat as required to blister the paint. Excessive heat chars the wood fibers and removal of the charred wood results in an uneven surface. Remove all interferences that can reasonably be removed before applying heat. This includes all label plates, brackets, clips, etc.
- b. Scraping tools used to remove blistered paint must be kept sharp to be effective. Do all scraping in the direction of the wood grain to prevent shredding of wood fibers and gouging of the bare wood surface. This phase of paint removal is important in preparing the surface for sanding.
- c. All areas stripped as previously described are now ready for sanding before priming. Hand sanding, with wooden blocks where practicable, using the correct grit paper, is the prescribed final step. Careful dusting before paint application is absolutely necessary to achieve a good primer bond, or bond between subsequent paint coats.
 - (1) Power disc sanders are not authorized for use in surface preparation. Improper use of the disc sander is the biggest cause of uneven surfaces and damage.
 - (2) Belt sanders and vibrating sanders are authorized for use in preparing the hull freeboard for priming and top-coating.

24.5 WOODEN HULL BOTTOM SHEATHING. For bottom sheathing to be effective and to provide protection to the underlying hull planking, the sheathing must fit the shape of the vessel's contoured bottom, be securely fastened, and be faired to the level of adjoining pieces of sheathing. The sheathing shall be installed per the requirements of reference (a).

- a. Sheathing the bottoms of wood vessels serves to protect the hull from burrowers, especially if the vessels are to endure long periods between dry-dockings.
- b. For vessels that are active and are dry-docked annually, the use of sheathing is not required.

24.6 WOODEN SEA CHEST FOUNDATIONS.

- a. To prevent overheating of the wood filler blocks and wood cap blocks in sea chests, the wood must be insulated from the metal fittings. Use of delron sleeves or bushings around the body of the through-hull fitting and around the bolt fastenings is one approved method.
- b. A Cathodic Corrosion Control system using an impressed current through anodes installed on boat bottoms isolates the anode fittings with the use of delron bushings and by the application of a mastic material applied over bare wood in a 36" diameter area around the anode.
- c. Replace wood fillers and caps that are badly decayed. If repairs cannot be made immediately, then treat the bad wood with a preservative or decay inhibitor to slow up the rate of deterioration until the bad wood can be replaced. When new fillers in the form of blocks and caps are fabricated, they should be treated with preservative prior to installation and after the wood has been finally shaped and fitted.

(This Page Intentionally Left Blank)

VOLUME IV
CHAPTER 25
GAS FREE ENGINEERING INSPECTIONS

REFERENCES.

- (a) NAVSEA S6470-AA-SAF-010 - Gas Free Engineering Manual
- (b) NAVSEA S9086-CH-STM-030 - NSTM 074 V3 (Gas Free Engineering)
- (c) OSHA 29 CFR 1915 - Confined and Enclosed Spaces and Other Dangerous Atmospheres in Shipyard Employment
- (d) OPNAVINST 5100.23 - Navy Occupational Safety and Health (NAVOSH) Program Manual

LISTING OF APPENDICES.

A Gas Free Engineering Program Assessment Sheet

25.1 **PURPOSE.** To define Fleet Gas Free Engineering (GFE) inspection policy and oversight policy.

25.2 **SCOPE.** This chapter is applicable to all Gas Free service provided by all personnel (military and civilian) assigned to a Naval Maintenance Facility (NMF) or Navy ship/submarine.

25.3 **DISCUSSION.** The correct application of GFE programs is varied and may be confusing to individuals unfamiliar with references (a) through (d). Table 25-1 cross references requirements.

Table 25-1

	NAVSEA Gas Free Engineering Manual	NSTM 074 V3	OSHA 29 CFR 1915	OPNAVINST 5100.23F - Para 2702D
Ship or Submarine located at an NMF (Notes 1 & 5)	X	X		
Ship/Submarine pierside, not at an NMF (Note 4 & 5)	X	X		
Ship/Submarine Underway		X		
Tender working on Ship/Submarine not at a NMF (Note 6)		X		
Tender working on Tender not at an NMF (Note 6)		X		
Tender working on other Surface Ship not at an NMF		X		
Non-Department of Defense (DoD) Contractors (including foreign contractors) (Note 2 or 7)		X - Note 2	X - Note 7	
Fleet Shore Activities which are not an NMF but conduct ship repair (Note 3)				X

Notes:

1. NMF is defined as Regional Maintenance Center (RMC), Regional Support Group, Ship Repair Facility, Department of the Navy Shipyards.
2. Contractor work onboard naval vessels outside U.S. territorial waters: Provisions in reference (b) allow the shipboard Gas Free Engineer to provide GFE services to contractor personnel when the ship is located outside U.S. territorial waters. These provisions are intended solely as a last resort to accomplish mission and time critical work and are not intended to relieve contractors of the obligation to provide their own certified GFE services whenever and wherever possible. Until this distinction can be formally addressed, the contracting

office shall notify Ship's Force whenever a contractor cannot provide their own GFE services. Ship's Force will then seek applicable Type Commander/Echelon III N43 approval on a case-by-case basis prior to providing GFE services to contractor personnel (both foreign and U.S. nationals) outside U.S. territorial waters.

3. Example: An Assault Craft, conducting landing craft repair work at its shore repair activity.
4. When an RMC is conducting work on a naval vessel that is located pierside, NMF personnel shall follow reference (a) requirements.
5.
 - a. Ship's Force should follow reference (b) requirements or may obtain NMF GFE/National Fire Protection Agency (NFPA) marine chemist services, if necessary, when pierside for Ship's Force entry into confined and enclosed spaces for inspections, preventive maintenance, and access to stowage.
 - b. Ship's Force should follow reference (b) requirements or obtain NMF GFE/NFPA marine chemist services, if necessary, when pierside for hot work certifications for Ship's Force work in confined and enclosed spaces, except as noted in paragraph c. of this note. Ship's Force will not provide hot work certification following reference (b) requirements to conduct work where DoD civilians or contractors are working in the same space or may be affected by work conducted by Ship's Force. The afloat Gas Free Engineer shall coordinate hot work aboard ship with NMF Gas Free Engineers and/or NFPA marine chemists aboard ship in advance of specific Ship's Force evolutions to ensure awareness and coordination of Ship's Force work. The afloat Gas Free Engineer shall follow NMF Gas Free Engineer and NFPA marine chemist guidance as appropriate.
 - c. Ship's Force, when pierside, shall not certify hot work operations within, on or immediately adjacent (through heat transfer, spark or hot slag contact) to:
 - (1) Spaces that contain or last contained combustible or flammable liquids or gases.
 - (2) Fuel tanks that contain or last contained fuel.
 - (3) Pipelines, heating coils, pump fittings or other accessories connected to spaces that contain or last contained fuel.
 - d. Ship's Force, when pierside, shall obtain support services for hot work operations listed in paragraph c. of this note through the local supporting NMF. When pierside in a private shipyard, optional GFE services for operations in paragraphs a. and b. of this note and required GFE services for operations in paragraph c. of this note will be obtained from an NFPA marine chemist by Ship's Force through the governing contract with the private shipyard. If such support services are not provided for in the contract, Ship's Force shall obtain required GFE services through the local supporting NMF.
 - e. When in a port location without services from NMF GFE or NFPA marine chemist, the afloat Gas Free Engineer will seek approval to conduct certification for emergent hot work operations referenced in paragraph c. of this note from the applicable Type Commander/echelon III N43. Ship's Force afloat Gas Free Engineer shall not provide GFE services to DoD or contractor civilian personnel under these circumstances.
 - f. With permission of the local supporting NMF, if conditions remain unchanged from the environment described on the confined space entry tag, afloat Gas Free Engineer may maintain certificates initially issued by NMF Gas Free Engineer or NFPA certified marine chemist referenced in paragraphs a., b. and d. of this note. If conditions change, immediately evacuate space and obtain recertification by originating NMF Gas Free Engineer or NFPA marine chemist.
 - g. Submarine personnel shall obtain GFE services from the local supporting NMF while pierside.
6. Tenders shall follow reference (b) for all repair work, on the tender itself or ships/submarines, except when the work is conducted while the vessel (tender/ship/submarine) is at an NMF at which point reference (a) becomes the governing instruction. Locations where in port GFE services are not available ensure that entry into, or hot work in or on fuel tanks, spaces in which fuel tank vents terminate, piping or equipment servicing such spaces or other confined spaces known to contain flammable fuels or fuel vapors is permitted only if approved by the Commanding Officer (CO) for each occasion as specified in paragraph 074-19.4.b of reference (b). Treat tanks as Immediately Dangerous to Life or Health and follow procedures in paragraph 074-19.14 of reference (b).

7. Non-DoD (contractor) personnel: contractor personnel conducting ship repair work on ships located inside U.S. territorial waters are required to follow reference (c) requirements whether the ship is in a government or privately owned ship repair facility. RMCs shall ensure all contracts include reference (c) requirements and ensure contractor compliance.

25.4 **OVERSIGHT.** To ensure compliance with reference (b), the afloat GFE program on surface ships, aircraft carriers and submarines shall be evaluated using the following requirements:

- a. The CO shall require the safety officer to evaluate the GFE program at least annually as outlined in reference (b). The safety officer, Damage Control Assistant, and submarine Medical Department Representative shall use Appendix A, Gas Free Engineering Program Assessment Sheet, to conduct the annual evaluation. A copy of this report will be sent to the Type Commander (TYCOM) Safety Officer.
- b. The TYCOM Safety Officer shall perform an annual evaluation of the afloat GFE program and provide a report to the Fleet N43 during the first quarter of the calendar year.
 - (1) TYCOM as part of the annual evaluation, shall collect and analyze data from assessment results from Safety Center Surveys, Board of Inspection and Survey (INSURV) material inspections, Afloat Training Group (ATG) program assessments, crew certification and Immediate Superior In Command (ISIC) assessments.
 - (2) TYCOM shall also spot check afloat GFE programs using Appendix A to include in the annual self evaluation.
- c. Submarine ISICs, INSURV, ATG, and TYCOM may use Appendix A to support scheduled assessments of afloat GFE programs. Table 25-2 outlines applicable sections to be assessed. Each assessing agent will have the option of expanding their assessment to other sections, if they deem necessary, based on any developing deficiency trends during the assessment. The assessing agent may elect to accept satisfactory results of another recent assessment, if it was performed within the last 3 to 6 months. Section 9 of Appendix A is the performance section that can be observed as a stand-alone event or in conjunction with planned unit drills.

Table 25-2

Periodicity	Assessing Agent	Section
Basic Phase of the Fleet Response Training Plan	ATG	Section 1, 2, 3, 5, 6, 9
Material Inspection (36 Months)	INSURV	Section 1, 2, 3, 5, 6, 9
Follow up based on assessment results	TYCOM/ISIC	All Sections

- d. Suggested changes or updates can be made to the TYCOM Safety Officer.

(This Page Intentionally Left Blank)

APPENDIX A
GAS FREE ENGINEERING PROGRAM
ASSESSMENT SHEET

Purpose: This assessment tool is comprehensive because it reviews the GFE administrative requirements, training records, equipment usage, GFE personnel performance and gas free evolutions.

Directions: This evaluation will take approximately 4 to 6 hours to complete. Review the assessment sheet in its entirety before starting. To ensure a complete and thorough assessment, applicable reference material, training records, 3-M documentation, equipment and coordinated drill observation with Ships Force personnel should be pre-arranged prior to starting the evaluation.

- If a line item requirement is met, annotate “yes” in the appropriate block.
- If a line item is not met, annotate “no” in the appropriate block.
- If a line item does not apply on the check sheet, depending on ship configuration, place not applicable (N/A) in the appropriate block.

REFERENCES.

- (a) S9086-CH-STM-030/CH-074V3 - Gas Free Engineering
- (b) COMNAVSUBFORINST 6000.2C - Standard Submarine Medical Procedures Manual
- (c) AEL 2-880044260 - Applied Equipment List
- (d) MIP 6641/007 - Detection Equipment (for submarines)
- (e) MIP 6641/030 - Detection Equipment (for surface ships)
- (f) MIP 5519/015 - Supplied Air Respirator (for surface ships)
- (g) COMNAVSURFORINST 3502.1 - Surface Force Training Manual

Ships Name: _____ Date: _____

Reference (a)	Section 1: GFE Personnel	Surface Ship	Aircraft Carrier	Submarine
(074-18.6)	Does the command have at least 1 person trained and qualified as the Afloat Gas Free Engineer?			
(074-18.8) and (074-18.11)	Review members service record. Is the designation letter signed by the CO? Is a copy of the letter in the GFE notebook?			
	What is the date of the certification/recertification letter? Date: _____			
(074-18.9)	Is the Gas Free Engineer a graduate of one of the following courses: K-495-0051, A-4G-0020, or Navy Undersea Medical Institute?			

Reference (a)	Section 1: GFE Personnel (Cont'd)	Surface Ship	Aircraft Carrier	Submarine
(074-18.8)	Did the Gas Free Engineer receive 40 hours On the Job Training (OJT) under the supervision of an official Afloat Maritime Gas Free Engineer or Navy Undersea Medical Institute?			
	Is the 40 hours of OJT documented?			
(074-18.8)	If the unit did not have a qualified Gas Free Engineer on board, did the CO waive (in writing) the 40 hour OJT requirement?			
	If 40 hour OJT is waived, did the Gas Free Engineer graduate from a Gas Free Engineer Course of Instruction within the last 36 months?			
(074-18.8, 074-18.9 and 074-18.11)	Does the command have an Assistant Gas Free Engineer? If so, is the Gas Free Engineer Assistant an E-6 or above and have satisfactorily completed one of the formal Gas Free Engineer training courses?			
	Review members service record. Is the designation letter signed by the CO to perform GFE functions? A copy in the GFE notebook?			
	What is the date of the certification/recertification letter? Date: _____			
(074-18.8 and 18.9)	Does the command have GFE Petty Officers (GFEPO)?			
	Is the GFEPO an E-4 or above and satisfactorily completed the formal Gas Free Engineer and Gas Free Engineering Petty Officer for Surface (Afloat) Operations Course K-495-0051?			
	Did the GFEPO complete NAVEDTRA 43704 (series) watchstation 316, under the supervision of the shipboard Gas Free Engineer?			

Reference (a)	Section 1: GFE Personnel (Cont'd)	Surface Ship	Aircraft Carrier	Submarine
(074-18.8 and 18.9) (Cont'd)	Does the GFEPO(s) have a designation letter signed by the CO to perform gas free engineering functions? (Review service record) A copy in the GFE notebook?			
(074-18.6)	Are there enough GFEPOs to include at a minimum, one GFEPO per ship's import/at sea fire party?			
Reference (a)	Section 2: Recertification of Gas Free Engineering Personnel (GFEP)	Surface Ship	Aircraft Carrier	Submarine
(074-18.10 and 074-18.11)	Were GFEP recertified annually? Is a copy of certification/recertification in the GFE notebook? Proof of certification/recertification during Medical Readiness Inspection in accordance with reference (b).			
(074-18.10)	Did GFEP demonstrate that they have satisfactorily engaged in gas free engineering evolutions during the year? (At least 10 certificates)			
(074-18.10)	If GFEP were not actively engaged in gas free engineering (as defined above) did they complete a minimum of five gas free evolutions OJT under the direct supervision of a certified Gas Free Engineer?			
(074-18.10) Review how this was documented and if the method used was adequate and not over simplified just to recertify GFEP.	If the OJT recertification methods were not feasible, did GFEP recertify based on a practical and oral or written examination, both of which sufficiently demonstrate capability?			
(074-18.10)	Did all GFEP complete refresher training in emergency rescue procedures prior to recertification? Review training records.			

Reference (a)	Section 2: Recertification of Gas Free Engineering Personnel (GFEP) (Cont'd)	Surface Ship	Aircraft Carrier	Submarine
(074-18.10) (Cont'd)	Was the periodicity of CPR refresher training in accordance with the requirements of the American Heart or American Red Cross Associations? Review members CPR record/card.			
Reference (a)	Section 3: GFE Annual Program Evaluation	Surface Ship	Aircraft Carrier	Submarine
(074-18.10)	Does the Safety Officer evaluate the Gas Free Engineering program annually?			
(074-18.10)	Did the evaluation include recertification of GFEP?			
(074-18.10)	Did the Safety Officer evaluate the CPR program for compliance and effectiveness?			
(074-18.10)	Does the Gas Free Engineer and Safety Officer maintain a record of annual evaluation results?			
Review annual evaluations. Safety Officer and Afloat Gas Free Engineer shall have copies of these evaluations.	Did the evaluation identify deficiencies of the program? If so, was a plan of action developed to rectify the deficiencies?			
Reference (a)	Section 4: Gas Free Certification	Surface Ship	Aircraft Carrier	Submarine
(074-18.15)	Is a gas free certificate issued for all confined space inspections or testing?			
(074-18.16)	Are the certifications maintained for a period no less than 12 months?			
(074-18.16) Appendix C of 074	Is the Gas Free Engineering notebook being maintained?			

Reference (a)	Section 4: Gas Free Certification (Cont'd)	Surface Ship	Aircraft Carrier	Submarine
<p>(Section 20) Appendix D of 074</p> <p>If hot work was performed during the gas free evolution, validate through site visits and/or review a random sampling of certificates maintained by the Gas Free Engineer to assess hot work compliance.</p>	<p>Is the gas free certification accurately filled out?</p> <p>Does the certification contain the following information at a minimum:</p> <ul style="list-style-type: none"> - Date and time of test - Date and time of certificate expiration - Date and time of retesting and update of certificate - Signature of GFEP performing tests or retests, as applicable. - Name of the command - Location and identification of the space - The type of operation for which the certificate is requested such as hot work, spray painting, etc. - Category of conditions found to exist (e.g., "Safe for Personnel - Not Safe for Hot Work") - Requirements for conditions or operations within the space - Special conditions, as appropriate - Results of the test performed 			
(074-20.5)	<p>Are there any abnormalities of testing results? Have follow-up actions been taken on the results?</p>			
(074-20.2, 074-20.3 and 074-20.4)	<p>Are GFEP issuing certificates for work they are authorized to? Did the GFE/GFEA delegate testing to GFEPOs? Were all the requirements for delegating met?</p>			
(074-18.12.B)	<p>While inport did S/F use a NMF Gas Free Engineer or NFPA Marine Chemist to certify hot work operations within, on or immediately adjacent to (review GFE certificates):</p> <ol style="list-style-type: none"> (1) Spaces that contain or last contained combustible or flammable liquids or gases. (2) Fuel tanks that contain or last contained fuel. (3) Pipelines, heating coils, pump fittings or other accessories connected to spaces that contain or last contained fuel. 			

Reference (a)	Section 4: Gas Free Certification (Cont'd)	Surface Ship	Aircraft Carrier	Submarine
(074-18.12.B) (Cont'd)	Did S/F seek support services from local NMF for hot work operations on these spaces?			
(074-18.12.C)	Did the afloat Gas Free Engineer consult with NMF Gas Free Engineers and/or NFPA marine chemists where DoD civilians/contractors are working in the same space or may be affected by work conducted by Ship's Force?			
(074-19.14)	Has the command ever entered into Immediate Danger to Life and Health space? If so, was it under emergency conditions?			
	Did the CO authorize the opening and entry into Immediate Danger to Life and Health spaces?			
(074-19.5)	Did personnel working in a confined space have an observer or an attendant outside the space?			
	Did outside attendants maintain communication with personnel entering or working inside confined spaces?			
Reference (a)	Section 5: Command Training	Surface Ship	Aircraft Carrier	Submarine
(074-18.9)	Have all hands received gas free engineering program familiarization upon reporting aboard and annually thereafter?			
(074-18.9)	Are training records maintained by the division officer or in R-ADM? MDR?			
Appendix B	Does the lesson plan cover the key elements of Appendix B for command personnel on the GFE program?			
(074-25.7) Review drill packages	Does the Gas Free Engineer/Gas Free Engineer Assistant provide confined space rescue training to personnel participating in confined space rescue at least semi-annually?			

Reference (a)	Section 6: Gas Free Engineering Equipment	Surface Ship	Aircraft Carrier	Submarine
Reference (c) (Refer to ships Damage Control Repair Station Applied Equipment List (AEL) and equipment AEL for total number of kits required.)	Is the gas free equipment quantity in accordance with ships/subs AEL? (Compare the Damage Control Repair Station shortage list against inventory list.) Document shortage in remarks section.			
Submarine: Refer to equipment AEL	Does the shortfall list have current requisition numbers assigned?			
(074-27.14.b) Spot check calibration gas canisters/cylinders	Is the calibration gas within the expiration date?			
Spot check chemical detection tubes.	Are there any expired chemical detection tubes?			
Detection Equipment (reference (d)) for submarines and reference (e) for surface ships.)	Review PMS 13 week file. Was the S-1/S-11 (surface ship) or Q-25 (submarine) performed? Any documented discrepancies?			
SAR/SCBA (reference (f))	Review PMS 13 week file. Has the M-1R, S-3R and A-2R been performed within periodicity and when required? Any documented discrepancies?			
Review SAR/SCBA ASA DC Material Check Sheet (reference (g))	Is the ASA check sheet filled out and is there evidence of a quarterly review by DCA/LCPO? Are there any UNSAT marks, if so, is there any corrective action(s) documented (i.e., CSMP entry, 8 o'clock report entries)?			
Reference COMUSFLTFORCOMINST 4790.3	Section 7: JFMM Requirements for Inport GFE Operations	Surface Ship	Aircraft Carrier	Submarine
Reference (a) Or COMUSFLTFORCOMINST 4790.3 (Volume IV Chapter 25)	Did SF conduct GFE services for contractor personnel when the unit was outside U.S. territorial waters? Was this specified in the contract? Did the unit obtain TYCOM/Echelon III N43 approval prior to conducting GFE services?			

Reference COMUSFLTFORCOMINST 4790.3	Section 7: JFMM Requirements for Inport GFE Operations (Cont'd)	Surface Ship	Aircraft Carrier	Submarine
Reference (a) Or COMUSFLTFORCOMINST 4790.3 (Volume IV Chapter 25) (Cont'd)	When in a port location without services from NMF Gas Free Engineer or NFPA marine chemist, did the afloat Gas Free Engineer seek approval to conduct certification for emergent hot work operations from the Type Commander/echelon III N43?			
	Did submarine personnel obtain GFE services from the local supporting NMF while pierside?			
	Did the tender, in a port where GFE services are not available, ensure that entry into, or hot work in or on fuel tanks, spaces in which fuel tank vents terminate, piping or equipment servicing such spaces or other confined spaces known to contain flammable fuels or fuel vapors was approved by the Commanding Officer?			
Reference (a)	Section 8: Hot Work Annex	Surface Ship	Aircraft Carrier	Submarine
(074-22.3) Cleaning/ventilating for Hot Work (Field observation or certificate review)	Check for confined spaces where hot work is being performed, was the space tested, inspected, emptied of flammable cargo, cleaned and ventilated and certified Safe for Hot Work?			
	Are hot work sites always inspected for combustible or flammable materials before hot work is authorized?			
	If combustible materials cannot be removed from a hot work site, what is done?			
	What method of venting is used to prevent explosions?			

Reference (a)	Section 8: Hot Work Annex (Cont'd)	Surface Ship	Aircraft Carrier	Submarine
(074-22.4) Fire Watch (Field observation or certificate review)	Was there a fire watch? Was the fire watch equipped with extinguishing equipment? Did the fire watch have the right personal protective equipment? Was the fire watch properly staged to extinguish a fire if it was to occur? Was there adequate number of fire watches?			
(074-22.6) Boundary Spaces (Field observation or certificate review)	Prior to hot work, how are potential adjacent space hazards controlled?			
(074-22.6.2) Pipes, Tubes, Coils (Field observation or certificate review)	Are pipes, tubes, coils or similar items which service, enter or exit a confined flushed, blown, purged or otherwise cleaned and certified Safe for Hot Work before the performance of hot work on such items?			
	Are valves to pipes, tubes or similar items closed, pipes blanked off and tagged out?			
(074-22.6.3) Hot work on Closed Containers or Structures (Field observation or certificate review)	Are hollow structures, drums, containers, jacketed vessels or similar items cleaned, flushed, purged, inerted, filled with water or otherwise made safe prior to hot work?			
	Are the items inspected, cleaned, tested and certified before performing hot work?			
	Before hot work, are items which are closed and subject to pressure build-up vented from any application of heat?			

Reference (a)	Section 8: Hot Work Annex (Cont'd)	Surface Ship	Aircraft Carrier	Submarine
(074-22.6.3) Hot work on Closed Containers or Structures (Field observation or certificate review) (Cont'd)	Is the method of venting selected to prevent ignition or explosion during the venting process?			
(074-24.3)	Are the requirements for Gas Inerting operations met? Are the requirements of 074-24.3.1 followed when vent holes must be drilled?			
Reference (a)	Section 9: Gas Free Engineering Performance (This can be assessed as a stand alone event or in conjunction with planned drills.)	Surface Ship	Aircraft Carrier	Submarine
(074-27.9.1) Pre-Check of the Four Gas Analyzer	Was the four gas analyzer's battery charged and all the components inspected before use?			
	Was the sampling probe visually inspected to verify that the water barrier, filter, and O-ring in place?			
(074-27.13) Four Gas Analyzer Calibration	Before calibration, is the Four Gas Analyzer zeroed in a fresh air environment?			
	Were the four gas analyzers calibrated before each day's use?			
(074.L.4) Dreager Pump	Was the rapid opening time test performed?			
	Was the 30 minute leak test performed for model 21/31 or 15 minutes for Accuro? Was the counter zeroed?			
(Section 25) Emergency Rescue Procedures (This will require a review of the section to determine if requirements were met.)	Were the procedures followed as outlined in Section 25? Annotate specific discrepancies in Remarks section.			

Reference (a)	Section 9: Gas Free Engineering Performance (This can be assessed as a stand alone event or in conjunction with planned drills.) (Cont'd)	Surface Ship	Aircraft Carrier	Submarine
(074.19.11 Testing Procedures	Was initial testing performed from outside the space by drop test or by insertion of sample probe or hoses?			
	Were the following tests conducted in the below order (may be some simultaneously depending on the instrument used)? 1. Oxygen 2. Combustible vapors/gases 3. Toxic gases			

VOLUME IV
CHAPTER 26
BOARD OF INSPECTION AND SURVEY
INSPECTIONS POLICY

REFERENCES.

- (a) OPNAVINST 4730.5 - Trials and Material Inspection (MI) of Ships Conducted by the Board of Inspection and Survey
- (b) OPNAVINST 4770.5 - General Policy for the Inactivation, Retirement and Disposition of United States Naval Vessels
- (c) NAVSEAINST 4790.8/OPNAVINST 4790.4 - Ships' Maintenance and Material Management (3-M) Manual
- (d) NWP 1-03.1 - Naval Warfare Publication Operational Report
- (e) OPNAVINST 4700.8 - Trials, Acceptance, Commissioning, Fitting Out, Shakedown, and Post Shakedown Availability of U.S. Naval Ships Undergoing Construction or Conversion
- (f) INSURVINST 4730.2 - Trials and Material Inspections of Submarines
- (g) INSURVINST 4730.1 - Material Inspections (MI) of Surface Ships
- (h) INSURVINST 4730.11 - Preparation of Deficiency Forms
- (i) INSURVINST 4730.8 - Reports of Trials, Material Inspections and Survey Conducted by INSURV
- (j) INSURVINST 4730.3 - Trials of Surface Ships

LISTING OF APPENDICES.

- A INSURV Plan of Action and Milestones

26.1 PURPOSE. To define the responsibilities and provide guidance for the preparation and conduct of a Board of Inspection and Survey (INSURV) Inspection.

26.1.1 Scope. The policies and actions required by this chapter are applicable to all ships of the U.S. Navy.

26.1.2 Background. INSURV was established by Title 10, U.S. Code, Section 7304, as a board of Naval Officers to make recommendations to the Secretary of the Navy as to which vessels, if any, should be stricken from the Naval register. Additionally, per reference (a), INSURV has been tasked with providing assurance to the Chief of Naval Operations (CNO) regarding the ship's material readiness and command's self-assessment effectiveness.

26.1.3 Discussion.

- a. INSURV is charged with conducting four basic types of inspections.

NOTE: COMBINED TRIALS AND GUARANTEE MATERIAL INSPECTIONS (MI) ARE CONDUCTED ON SUBMARINES ONLY. ACCEPTANCE TRIALS AND FINAL CONTRACT TRIALS ARE CONDUCTED ON ALL OTHER SHIPS.

- (1) Combined Trials/Acceptance Trials for new construction or conversion ships. Details are discussed in Volume I, Chapter 4 of this manual.
- (2) Guarantee Material Inspection/Final Contract Trials for new construction or conversion ships. Details are discussed in Volume I, Chapter 4 of this manual.
- (3) MIs are conducted on U.S. Navy commissioned ships and submarines as discussed in this chapter and reference (a).
- (4) Surveys for ships scheduled for decommissioning, Retention/Mobilization or as a Foreign Military Sale. Refer to reference (b) for additional information.

- b. Detailed procedures for reporting MI deficiencies in the Maintenance and Material Management (3-M) system are contained in reference (c).
- c. Milestones for inspections are shown in Appendix A of this chapter.

26.1.4 Policy.

- a. As designated in reference (a), material inspections are to provide assurance to Commanding Officers and higher authority that mechanisms to identify, document and resolve material deficiencies are adequate. To this end the ship will establish a program to complete administrative and organizational preparations for the INSURV inspection commencing approximately 12 months prior to the scheduled inspection. Ships shall utilize the guidance shown in Appendix A of this chapter.
- b. Adequate preparation for an INSURV inspection does not imply that all deficiencies must be corrected. The goal is to present a ship that is fully aware of all existing deficiencies. All deficiencies must be properly documented and those which are considered to be mission degrading must be reported by Casualty Report (CASREP) in accordance with reference (d). Administrative preparations, in addition to deficiency documentation, must be complete and comprehensive.

26.2 RESPONSIBILITIES.

26.2.1 Type Commander. The Type Commander (TYCOM) shall:

- a. Act as the cognizant authority for the conduct of INSURV inspections for all ships of the force (including new construction ships and submarines) and maintain a schedule of inspections due.
- b. Nominate ships and submarines for inspections and surveys by INSURV. Promulgate schedules of inspections to be conducted by INSURV on ships of the force.
- c. Schedule accomplishment of Class Maintenance Plan maintenance assessments in accordance with Volume VI, Chapter 42 of this manual.
- d. Review Safety Survey results and corrective action status report provided by the ship's Commanding Officer.
- e. Track and work to resolve historical issues with systems, equipment and processes identified by INSURV.
- f. Coordinate with the Immediate Superior In Command (ISIC) to disseminate the best practices and lessons learned.

26.2.2 Immediate Superior In Command. The ISIC shall (TYCOM responsible if ISIC is not assigned):

- a. For Surface Force Ships only, if the ISIC is deployed, the ISIC will request the numbered fleet commander assign non-deployed local Squadron to assist with inspection preparations.
- b. Monitor Ship's Force preparation for the inspection.
- c. Send reports per Appendix A. Surface Ships ISIC will conduct an inspection readiness assessment prior to submitting. Develop and disseminate a standardized Schedule of Events for assigned ships.
- d. Ensure preparation for the sequence of accomplishing inspection underway demonstrations is conducted in advance of inspection.
- e. Ensure post inspection reporting procedures are followed.
- f. Attend post-INSURV inspection critiques.
- g. Ensure supporting subordinate commands are prepared for the scheduled INSURV.
- h. Ensure that the ship is prepared to discuss Current Ship's Maintenance Project (CSMP) deficiencies which have not been corrected, and those items which have been removed from the CSMP and passed to history.
- i. Monitor the reporting and correction of inspection deficiencies through the CSMP.

26.2.3 Ship Commanding Officer. The Commanding Officer shall:

- a. Ensure that the ship is prepared for the inspection.
- b. Promulgate a ship wide Plan of Action and Milestones (POAM) in preparation for INSURV.
- c. Be prepared to discuss with the senior member of the board any item from the previous INSURV Inspection which is still on the CSMP, all items which were determined to be not correctable and designated "pass to history", or those for which reporting had been deferred by the TYCOM, including supporting rationale and reference material.
- d. Designate an officer as INSURV Coordinator and a Chief Petty Officer, preferably the 3-M Coordinator, as his assistant.
- e. Assign a senior coordinator for each INSURV functional area as defined in paragraph 26.4.2.b of this chapter.
- f. (Surface Force Ships Only) Submit a letter of concern to INSURV/TYCOM/ISIC.

26.2.4 INSURV Coordinator. The INSURV Coordinator shall:

- a. Brief all Department Heads on the review of the CSMP, confirm existing Job Control Numbers as valid, and report any existing deficiencies which are not in the CSMP.
- b. Review the Automated Work Request (AWR)/CSMP package with the TYCOM/ISIC Maintenance Document Control Office to ensure quality (e.g., readability, proper printing and page-break by Work Center).
- c. Segregate the AWR originals by INSURV departmental designations for turnover to the INSURV team.
- d. Provide the original of the complete CSMP Report to the INSURV team.
- e. Retain a copy of the AWRs and the CSMP for use during the inspection.
- f. Distribute copies of the AWRs to Department Heads and Work Centers.
- g. Collect and track all INSURV deficiencies identified during the inspection.
- h. Coordinate Work Center updating of the CSMP and the processing of updated OPNAV 4790/2Ks or AWRs.

26.2.5 Regional Maintenance Centers. In support of the tasking and funding, the Regional Maintenance Centers (RMC) will:

- a. Provide RMC support coordination for INSURV in each home port.
- b. Upon TYCOM direction, provide a weekly or, if required, daily update for critical path inspection repairs.
- c. Provide or obtain subject matter experts with the experience and system knowledge for assessment to accomplish INSURV approved procedures based on the tasking, schedule and funding provided by INSURV.
- d. Provide documented subject matter experts findings to, and formatted for, INSURV.
- e. Utilize subject matter experts resources in the most cost effective manner to support the tasking.
- f. Develop annual INSURV budget estimate based on projected INSURV schedule. Mid-Atlantic Regional Maintenance Center INSURV Support Coordinator will correlate individual estimates for transmittal to INSURV.

26.3 INSPECTION SCHEDULING.

26.3.1 Combined Trial/Acceptance Trial Inspections. The scheduling of these trials for new construction or conversion ships will be coordinated by the TYCOM and Program Executive Officer (PEO) Submarines in accordance with Volume I, Chapter 4 of this manual and reference (e).

26.3.2 Guarantee Material Inspection/Final Contract Trials. The scheduling of the Guarantee Material Inspection or Final Contract Trials will be coordinated by the PEO Ships or PEO Aircraft Carriers in accordance with Volume I, Chapter 4 of this manual and reference (e).

26.3.3 Material Inspections. Scheduling the INSURV MI at a consistent time in the Fleet Response Training Plan will provide invaluable independent assessments of how well our maintenance processes perform.

- a. An INSURV MI will be included in a unit's five-year plan. The desired outcome is for INSURV's MIs to be conducted at a consistent time within the Fleet Response Training Plan, and in a manner not to interfere with carrier strike group or amphibious readiness group operations. In achieving this end state, TYCOMs will avoid scheduling INSURV MIs in the time frame between the numbered fleet commander deployment certification event (e.g., Composite Training Unit Exercise, Joint Warrior, etc.) and the end of post-deployment stand down.
 - (1) Surface Force Ships. The MI will optimally be conducted after the Unit Level Training phase and prior to the start of the Integrated Level Training phase, after every other deployment, not to exceed 54 months. With these scheduling considerations, the overall average time between examinations for surface ships will be about 48-54 months.
 - (2) Aircraft Carriers. The optimal time to conduct MIs is 60 to 90 days following the completion of the CNO maintenance availability. Avoid conducting MIs after the air wing is embarked for carrier qualification. With these scheduling considerations, the overall average time between examinations for carriers will be about 48-54 months, not to exceed 60 months.
 - (3) Submarines. INSURV MIs are integrated into the submarine engineered operating cycle per reference (f). MIs should be scheduled post major availability and at mid-cycle. With these scheduling considerations, the overall average time between examinations for submarines will be about 65-70 months, not to exceed 84 months.
- b. Conduct of INSURV MIs outside of these time frames requires approval from Commander US Fleet Forces Command/PACFLT (N43). Material inspections of surface ships and aircraft carriers that cannot be conducted within 60 months, and submarines that cannot be conducted within either 84 months or within 180 days of completion of a major CNO availability planned for greater than 180 days in duration require a formal waiver of periodicity requirements from CNO per reference (a).
- c. Scheduling the INSURV inspection at a consistent time in the Fleet Response Training Plan will provide invaluable independent audits of our maintenance processes. Coordinating these inspections with TYCOM assessment events reduces the burden on our Sailors and saves money.
- d. Assessment planning shall be in accordance with Volume VI, Chapter 42, paragraph 42.5.4 of this manual.

26.4 PREPARATION FOR INSURV INSPECTION.

26.4.1 Active Preparation. Ships routinely must maintain their CSMP in accurate condition and continuously monitor and accurately report their own material readiness posture per reference (d). However, due to outside agency assessments/audits/inspections/certifications the scheduling of an inspection should occur at an optimum time when full material condition awareness is maximized. Active preparation for the INSURV inspection will commence upon receipt of the TYCOM approved proposed INSURV inspection schedule. The TYCOM will notify the Commanding Officer (via the ISIC if applicable) of the proposed dates with specific guidance for the preparation and execution of the inspection. Direct and early liaison with the INSURV is essential to ensure agenda approval, facilitate travel arrangements, berthing and other similar items. Ships shall make use of the information and data available at the INSURV website (<http://www.public.navy.mil/fitfor/insurv>) to better understand and prepare for an inspection. Ships are strongly encouraged to liaison with INSURV regarding current material problem areas that may exist within the fleet and to actively resolve them as appropriate within their own command.

26.4.2 Ship's Internal Organization. The ship will establish an internal organization for the INSURV. While the details of such an organization will vary from ship to ship, two key elements must be addressed:

- a. Specific personnel assignments shall be made to ensure that all necessary logistic and support arrangements for the INSURV are adequately covered (e.g., transportation, berthing, laundry, clerical assistance).
- b. INSURV inspects by functional areas, which may not exactly correspond to the standard ship's organization. For purposes of the inspection, the ship will assign one-to-one correspondence for each inspector, with a senior coordinator for each INSURV functional area. Assigned individuals should be thoroughly familiar with each CSMP deficiency, show the inspector exactly where the deficiency is, be able to explain why it has not been corrected and answer questions about related items in the same category, etc. Knowledgeable ship's representatives are essential for a successful inspection.

26.4.3 Updating the Current Ship's Maintenance Project.

- a. The CSMP must be reviewed, updated and purged of all completed maintenance actions. All outstanding corrective maintenance should be documented as a deferral. This evolution is important since the CSMP is the primary source of deficiencies that will be presented to INSURV. A vital part of the review is to ensure that deficiencies are properly assessed and documented.
- b. Any deficiencies noted during the pre-inspection audit will be entered in the CSMP and reissued for final INSURV documentation.

26.5 BOARD OF INSPECTION AND SURVEY INSPECTION CONDUCT AND DOCUMENTATION.

26.5.1 Inspection Conduct. The inspection will be conducted as specified in reference (g) for surface ships and reference (f) for submarines.

- a. Flight operations (if applicable) and other ship evolutions will not be scheduled during the conduct of the inspection, except when scheduled in direct support of the inspection or when specifically requested by INSURV.
- b. A proposed "open and inspect" list will be submitted to the ship's assigned senior coordinator for each INSURV functional area no later than the start of the underway portion of the inspection. The senior INSURV member may modify the "open and inspect" list at any time.

26.5.2 Deficiency Documentation.

- a. Preparation of INSURV deficiency forms will be in accordance with references (c), (h) and this instruction.
- b. INSURV will provide the ship with a copy of new deficiencies found during the inspection.
- c. The final forms generated by INSURV will be screened by the TYCOM following the inspection. Whenever an item is considered not cost-effective to correct or is inconsistent with reference (c), the TYCOM will authorize passing the item to the history file.
- d. Deficiencies corrected while INSURV is on board are still required to be properly documented.

26.6 POST BOARD OF INSPECTION AND SURVEY INSPECTION ACTIONS.

26.6.1 Deficiency Processing and Resolution.

- a. INSURV deficiencies will be reported by entering them into the ship's CSMP within 30 days following completion of the inspection (90 days for Naval Air Force ships).
- b. Upon completion of the INSURV inspection, Ship's Force shall take the following actions:
 - (1) With TYCOM assistance, screen all INSURV deficiencies. Identify those which are mission degrading or safety items.
 - (2) Initiate prompt action on all mission degrading and safety items. All Part I "Mission Degrading" items and any additional items that are deemed to significantly degrade the ability of the ship to carry out its assigned mission shall be documented by an appropriate CASREP in accordance with reference (d).

- (3) Correct all deficiencies within the capability of Ship's Force as soon as possible. Deficiencies corrected within seven days shall be documented as completed maintenance actions. All other outstanding deficiencies originated by INSURV shall be incorporated into the CSMP as soon as possible but no later than 30 days following the inspection.
- (4) Modify deficiencies previously identified and processed to include the assigned INSURV number and any modifications, in accordance with the requirements of reference (c).
- (5) Comply with the requirements of reference (c) if instances occur where INSURV enters multiple deficiencies under a single INSURV number.

26.6.2 Post INSURV Inspection Reports. INSURV will issue a final report in accordance with reference (i). The report will contain a recommendation on the material condition of the ship in accordance with reference (a).

26.6.3 Unsatisfactory Finding. Upon a finding of "Unsatisfactory" by the Board of Inspection and Survey:

- a. The ship shall submit by message to the ISIC/TYCOM, an analysis of the causes of the Part I deficiencies found during the INSURV inspection and a plan of corrective actions within one week after completion of the inspection. This plan should include estimated completion dates for the corrective actions that will be performed by the ship. For corrective actions that are deferred to a Fleet Maintenance Activity, the Naval Supervising Activity Lead Maintenance Activity shall provide to the ship and the TYCOM estimates or recommended dates for the corrective actions that will be performed by the Fleet Maintenance Activity.
- b. The TYCOM will coordinate and direct all actions associated with restoring the ship to operational readiness for those Part I deficiencies judged unsatisfactory or incomplete by INSURV. The TYCOM shall submit to the appropriate chain of command a POAM to correct these Part I deficiencies and restore the ship to operational readiness. In addition, the TYCOM shall:
 - (1) Evaluate the ship's and ISIC preparations for the INSURV inspection.
 - (2) Review corrective actions and training plans submitted by the ship. Ensure these plans not only correct the specific deficiencies noted by INSURV, but that they also address the fundamental underlying causes of the deficiencies.
 - (3) Take action as required to assist in correcting the Part I deficiencies (e.g., scheduling, outside technical assistance, training, etc.).
 - (4) Re-examine those areas that were judged unsatisfactory or incomplete within 60 days of the completion of the INSURV inspection. Report the results to the appropriate chain of the command and to INSURV.
 - (5) Report by message to the appropriate Fleet Commander when the ship is adequately restored to operational readiness.

APPENDIX A
INSURV PLAN OF ACTION AND MILESTONES

<u>MILESTONE</u>	<u>DUE</u>	<u>RESPONSIBLE ACTIVITY</u>
Notify Ship of Scheduled INSURV	I-365 days	TYCOM
(Naval Surface Forces) Maintenance Team define and schedule assessments desired prior to INSURV	I-365 days	Ship/RMC
Develop Departmental/Ship's Plan of Action and Milestones (POAM) for INSURV Preparation	I-330 days	Ship
Begin Review and Update of Current Ship's Maintenance Project	I-180 days	Ship
(Naval Air Forces) Download applicable INSURV instructions and check sheets and distribute to Ship's Force	I-180 days	Ship
Review Previous Inspection Reports (INSURV, Initial Assessment/Underway Demonstration, etc.)	I-180 to I-90 days	ISIC/Ship
Update Ship's POAM verify on track	I-180 days	Ship
Identify Ship's INSURV Coordinator to INSURV	I-180 days	Ship
Develop program to conduct/practice INSURV material checks and identify/correct training deficiencies	I-180 days	Ship
Schedule INSURV pre-brief	I-120 days	Ship
Download applicable INSURV instructions and check sheets and distribute to Ship's Force	I-120 days	Ship
INSURV Package delivered to Ship	I-120 days	INSURV
(Naval Air Forces) Develop and send linked events request message from TYCOM to INSURV	I-120 days	TYCOM/Ship
Provide hull baseline tasking to RMC	I-90 days	INSURV
Update Ship's POAM verify on track	I-90 days	Ship
Conduct INSURV pre-brief	I-90 to I-60 days	INSURV/Ship
Conduct Pre-Trial Self Audit	I-60 days	(TYCOM/ISIC)/Ship
Update CSMP following Self Audit	I-60 to I-45 days	Ship

<u>MILESTONE</u>	<u>DUE</u>	<u>RESPONSIBLE ACTIVITY</u>
Send 45-DAY INSURV readiness status message to TYCOM. Message should describe the ship's level of preparedness for INSURV, significant issues and CASREPs, significant preparations and grooms, and the ISIC's determination of the ship's readiness for the inspection	I-45 days	ISIC/Ship
Utilizing INSURV proposed trial/inspection Summary of Events agenda listed in references (f) and (g) (reference (j) for new construction), submit trial/inspection Summary of Events agenda to INSURV/RMC	I-45 days	Ship
INSURV tasking requirements to RMC locked	I-45 days	INSURV/RMC
For all surface ships, complete and deliver CO letter of concerns to INSURV (copy to TYCOM)	I-45 days (Naval Surface Forces)I-30 days (For Naval Air Forces)	Ship
INSURV tasking requirements to RMC locked	I -45 days	INSURV/RMC
(Naval Air Forces) Develop and send readiness to conduct inspection message from TYCOM to INSURV including embarkation points, security clearance forwarding data, and other pertinent event notices such as time of check in for underway personnel.	I-30 days	TYCOM/Ship
Send update 14-DAY INSURV readiness status message to TYCOM N43. Message should describe the ship's level of preparedness for INSURV, significant issues and CASREPs, significant preparations and grooms, and the ISIC's determination of the ship's readiness for the inspection	I-14 days	ISIC
RMCs provide subject matter expert names to ship/INSURV	I-7 days	RMC
RMC ensure timely subject matter expert support	I-0	RMC
Submit CASREPs as appropriate; Enter all Mission Degrading and Safety Deficiencies into CSMP	I+1 day	Ship
Report the ship's return to port and any significant results to TYCOM N43	I+1 day	ISIC/TYCOM Rep

<u>MILESTONE</u>	<u>DUE</u>	<u>RESPONSIBLE ACTIVITY</u>
Report the time ship cleared for underway to TYCOM N43	I+2days	ISIC
Enter all Deficiencies into CSMP	I+30 days	Ship
Report status of INSURV Part I and Part I Safeties to RMCs and TYCOM	I+30 days	Ship/ISIC
Screen Remaining Deficiencies and assign Responsible Actions	I+45 days	ISIC/Ship
Submit Lessons Learned to TYCOM	I+45 days	ISIC
Submit Pass to History Items	I+120 days	Ship
Report status of all of Part I and Part I-S Safeties to RMCs and TYCOM until all deficiencies are completed	15 Jun and 15 Dec	Ship/ISIC

(This Page Intentionally Left Blank)

VOLUME IV
CHAPTER 27
REBOILER INSPECTION

REFERENCES.

- (a) NAVSEA S9534-AD-MMA-010 - Steam Reboiler Maintenance
- (b) OPNAVINST 9220.3 - Propulsion and Auxiliary Plant Inspection and Inspector Certification Program
- (c) NAVSEA STD DWG 514-8316912 - CVN 68 Reboiler Strength and Integrity Inspection
- (d) NWP 1-03.1 - Naval Warfare Publication Operational Report
- (e) OPNAVINST 5100.19 - Navy Occupational Safety and Health (NAVOSH) Program Manual for Forces Afloat
- (f) NAVSEA S9086-CH-STM-030 - NSTM Chapter 074 V3 (Gas Free Engineering)
- (g) NAVSEAINST 9254.1 - Eddy Current Inspection of Condensers and Reboilers on Nuclear Vessels

LISTING OF APPENDICES.

- A Sample Steam Reboiler Inspection Request
- B Sample Inspection Confirmation Message
- C Sample Steam Reboiler Inspection Report Cover Letter
- D Sample Boiler Inspection RBO/Severely Degraded Deficiencies Message

27.1 **PURPOSE.** To establish policy and provide procedures and inspection requirements for Steam Reboilers and support systems, including:

- a. Inspection scheduling.
- b. Required preparations for inspections.
- c. Inspection guidelines.
- d. Reporting requirements.

27.1.1 **Policy.** Periodic standardized inspections are required of all Steam Reboiler and associated support systems including outlet and inlet steam piping, safety devices, feed water and drain systems, control and indicating systems associated with maintaining system pressure and water level controls. Specific inspection criteria, attributes and intervals are detailed in references (a) and (b). Inspections will be conducted by a certified Steam Generating Plant Inspector (SGPI), Naval Surface Warfare Center, Carderock Division (NSWCCD) inspector and Ship's Force in accordance with the requirements of references (a) and (b). Responsibilities for standardization of Steam Reboiler inspections will closely parallel those requirements and responsibilities of the boiler inspection program described in reference (b), as modified by references (a) and (c).

27.2 TYPES OF INSPECTIONS.

- a. First six months operating.
- b. Second six months operating.
- c. Third six months operating.
- d. Annually.
- e. Eddy current inspections.
- f. Routine.
- g. Start of Availability Inspection (SAI).
- h. Strength and Integrity.
- i. Completion of Availability Inspection (CAI).

- j. Special.
- k. Industrial Support Visit (ISV).
- l. Inactivation or Reactivation Inspection.
- m. Post Shakedown Availability New Construction.

27.3 RESPONSIBILITIES.

27.3.1 Naval Sea Systems Command. Naval Sea Systems Command (NAVSEA) shall provide Technical Authority oversight for all Steam Reboilers and associated equipment. The designated NAVSEA Technical Warrant Holder shall:

- a. Approve all major Departure From Specifications (DFS).
- b. Provide technical oversight and management of the SGPI and NSWCCD Life Cycle Engineering Manager (LCEM).
- c. Establish and enforce requirements for SGPI certification and recertification.
- d. Ensure periodic SGPI seminars are conducted.
- e. Maintain the Steam Reboiler Inspection and Repair Management Information System (RIRMIS).
- f. Routinely evaluate and ensure state of the art inspection, maintenance and repair tools and techniques are used.

27.3.2 Naval Surface Warfare Center, Carderock Division.

- a. Provide support to NAVSEA for the SGPI and NSWCCD-LCEM programs. Ensure that the required technical documentation to support the SGPI/NSWCCD-LCEM Inspector program is maintained current.
- b. Establish and monitor the requirements and standards for routine and industrial inspections of Steam Reboilers.
- c. Develop, implement and maintain a program to train and certify NSWCCD-LCEM inspectors in accordance with reference (b).
- d. Ensure that inspection of newly constructed ships and ships undergoing major overhaul and/or conversion are conducted in accordance with this instruction.
- e. Conduct periodic technical audits of the SGPI Training Course per reference (b).
- f. Provide management of technical data, Reboiler history and the associated repair management information database.
- g. Provide technical support to the SGPI seminars.
- h. Maintain a roster of all certified SGPIs by name, rating, duty station, date of certification and expiration date of certification. Recommend inspector certification and initiate action to decertify inspectors who fail to comply with the requirements of reference (b).
- i. Ensure that the requirements for SGPI certification, recertification and certification extensions are met prior to final approval.
- j. Conduct SAI/ISV, Strength and Integrity Inspections, CAI and special inspections as specified in section 27.5 of this chapter and reference (b).

27.3.3 Type Commander.

- a. Arrange for certified SGPIs to perform inspections in accordance with the requirements of references (a) and (b).
- b. Schedule inspections of all Steam Reboilers and support systems required by reference (a). Coordinate the inspections with the appropriate technical activities to avoid unnecessary opening of Steam Reboilers.

- c. Assist Commanding Officers in arranging for the corrective action of deficient items which are beyond the capability of Ship's Force to perform. Monitor the follow-up action to correct these deficiencies.
- d. Review the RIRMIS to ensure deferred inspection deficiencies are entered into the Current Ships Maintenance Project (CSMP), and are planned/programmed for repair.

27.3.4 Regional Maintenance Center Commanding Officer. Provide certified SGPIs to perform inspections per paragraph 27.6.1 of this chapter.

27.3.5 Ship's Commanding Officer.

- a. Request inspections via Naval Message with desired primary and alternate dates to the Type Commander (TYCOM) with info copies to cognizant Regional Maintenance Center (RMC) and NSWCCD for accomplishment of inspections using the format in Appendix A.
- b. Prepare for the scheduled inspections.
- c. Conduct Ship's Force responsible (Annual) inspections as required by references (a) and (b).
- d. Review inspection results and initiate corrective action for those deficiencies within Ship's Force capability. Initiate requests for those actions beyond Ship's Force capability and those items that are identified as being deferred. Submit a Casualty Report in accordance with reference (d) for any discrepancies that will impact operational schedule.
- e. Assess the impact of corrective actions on the ship's operating schedules and advise the TYCOM and operational commanders of any adverse effects.
- f. Submit reports per paragraph 27.7.2 of this chapter.

27.3.6 Regional Maintenance Center Senior Inspector. RMC Senior inspectors shall:

- a. Ensure all assigned SGPIs maintain current SGPI certificates per reference (b).
- b. Perform Steam Reboiler inspections per references (a) and (b).
- c. Review and submit reports per paragraph 27.7.2 of this chapter.
- d. Coordinate inspections in cognizant maintenance areas.
- e. Send inspection confirmation message using Appendix B of this chapter.
- f. Maintain an up to date list of required Steam Reboiler inspections which shall include the latest inspections for all ships assigned to their geographic area of responsibility.

27.3.7 Steam Generating Plant Inspector.

- a. Maintain certification per the requirements of reference (b).
- b. Perform inspections in accordance with the requirements of references (a) and (b) assigned.

27.4 INSPECTION SCHEDULING. Commands will initiate inspection requests to assist with inspection coordination. Commands shall ensure that the inspection scheduling complies with reference (b) and Commanding Officers shall request Steam Reboiler inspections by message using the format in Appendix A. In addition, an OPNAV 4790/2K shall be submitted to the RMC requesting a certified SGPI/NSWCCD-LCEM inspector as required to conduct inspections.

27.5 SAFETY PROCEDURES.

- a. Ensure idle Steam Reboiler condition is accomplished in accordance with the provisions of the Steam Plant Manual and reference (a) in preparation for the inspection.
- b. Ensure all safety precautions associated with entry into sealed tanks, voids and/or pressure vessels including gas-free certification are performed in accordance with the requirements of references (e), (f), and Chapter 23 of this volume.
- c. Ensure proper maintenance barriers are established per the requirements of Chapter 10 of this volume.

- d. Station an attendant outside the Steam Reboiler to provide assistance when maintenance and inspections are performed on the Steam Reboiler internals.
- e. Ensure all precautions and warnings cited in Chapter 5 of reference (a) are followed when conducting maintenance and inspections.
- f. Maintain accountability of all items taken into the Steam Reboiler. Foreign material exclusion enclosures will be used to the maximum extent practical to prevent tools or other foreign materials from being inadvertently left in the Steam Reboiler or associated ship's systems.
 - (1) Personnel entering Steam Reboilers will empty their pockets of all unnecessary items.
 - (2) Removal of all items and foreign material exclusion enclosures from the Steam Reboiler will be verified and accounted for prior to conducting a final close-out inspection.
 - (3) Final close-out inspection of the Steam Reboiler shall be accomplished by the Reactor Officer or his designated assistant.

27.6 STEAM REBOILER INSPECTIONS AND REQUIREMENTS. Steam Reboiler inspections conducted in accordance with references (a) and (b) shall fulfill all other Steam Reboiler inspection requirements. All boiler inspections, including pre- and post-operational assessments, should be scheduled for coincidental performance.

27.6.1 Eddy Current Inspection. Eddy Current Inspection (ECI) shall be accomplished at Post Shakedown Availability and every 32 months, in accordance with reference (g).

- a. The ECI will be scheduled by Planned Maintenance System (PMS) 312.
- b. The ECI will be performed by personnel trained and qualified in the use of ECI equipment and ECI data interpretation.

27.6.2 Routine Inspection. Routine visual inspections are required after the first 30 months of operation, and every 30 months after a Strength and Integrity Inspection, not to exceed 36 months. Any extension beyond 36 months requires an approved major DFS which must be brought to the attention of NSWCCD and the NAVSEA Boiler and Condenser Technical Warrant Holder.

- a. The Routine inspection will be scheduled by the TYCOM.
- b. The Routine inspection will be performed by a certified SGPI.
- c. The Routine inspection will be conducted concurrent with ECI or tube renewals.

27.6.3 Start of Availability Inspection. The SAI will be accomplished at the beginning of an availability to better define or re-evaluate the Steam Reboiler bid specification and identify those major items which may impact ship's operational schedule.

- a. The SAI will be scheduled by the TYCOM and/or PMS 312.
- b. The SAI will be performed by the NSWCCD Inspector accompanied by a certified SGPI.

27.6.4 Strength and Integrity Inspection. The interval between strength and integrity inspections will be 64 months, not to exceed 72 months. The 64 month period commences with the first lite-off of the Steam Reboiler following the previous strength and integrity inspection. Any extension beyond 72 months requires an approved major DFS and must be brought to the attention of NSWCCD and the NAVSEA Boiler and Condenser Technical Warrant Holder.

- a. The Strength and Integrity inspection will be scheduled by PMS 312.
- b. The Strength and Integrity inspection will be performed by an NSWCCD inspector accompanied by a certified SGPI.
- c. The Strength and Integrity inspection will be conducted concurrent with ECI or tube renewals.

27.6.5 Industrial Support Visit Inspection. The ISV inspection shall be scheduled during the availability but may be waived by the TYCOM for availabilities of short duration.

- a. The ISV inspection will be scheduled by the industrial activity or supervising authority as applicable.

- b. The ISV inspection will be performed by an NSWCCD inspector accompanied by a certified SGPI.

27.6.6 Completion of Availability Inspection. The CAI will be conducted prior to final close out of the Steam Reboiler.

- a. The CAI inspection will be scheduled by the industrial activity or supervising authority as applicable.
- b. The CAI will be performed by an NSWCCD inspector accompanied by a certified SGPI, preferably the SGPI who conducted the SAI.

27.6.7 Inactivation or Reactivation. The Inactivation/Reactivation inspection shall be conducted on all Steam Reboilers prior to the completion of the inactivation/reactivation.

- a. The Inactivation/Reactivation inspection will be scheduled by the industrial activity, Supervising Authority and Inactive Ship Facility as applicable.
- b. The Inactivation/Reactivation inspection will be performed by an NSWCCD inspector and the cognizant SGPI.

27.6.8 Special Inspection. An additional Steam Reboiler inspection when the TYCOM desires to assess the material condition of the Steam Reboilers.

27.6.9 Annual Inspection. An Annual inspection of the Reboiler (shell side) will be conducted, as directed by references (a) and (b), by Ship's Force.

27.6.10 Operational Assessments. An operational assessment shall be accomplished prior to and at the completion of all Chief of Naval Operations scheduled maintenance availabilities. These assessments are part of the Routine Strength and Integrity inspection requirements. These assessments will include both cold and hot plant in-port safety checks and an operational evaluation. Detailed assessment requirements are specified in MRC 5173/001.

27.7 REBOILER INSPECTION GUIDELINES AND REPORTS.

27.7.1 Guidelines.

- a. Inspections conducted under paragraph 27.6.3 of this chapter normally encompasses the pressure vessel portion of the Steam Reboiler and associated piping connections as outlined by reference (c) and is conducted by NSWCCD-Ship System Engineering Station (SSES) inspectors accompanied by a certified SGPI. Other areas such as, Steam Reboiler controls and Steam Reboiler appurtenances, must be inspected as part of the Routine inspection prior to Steam Reboiler lite-off by a certified SGPI. Inspections to coincide with ECIs or tube renewals.
- b. Routine inspections of Steam Reboilers will be conducted by certified SGPIs.
- c. All Repair Before Operating (RBO) items shall be corrected and re-inspected by a certified SGPI or NSWCCD-LCEM inspector, and preferably by the same SGPI/NSWCCD-LCEM inspector who originally identified the discrepancy prior to operation of the Reboiler. RBO discrepancies include those for which continued unrestricted operation could endanger personnel. RBOs may not be departed via DFS. If there is not an immediate or near future danger to personnel, the discrepancy shall be assigned as SEVERELY DEGRADED with major operational restrictions.
- d. Whenever Steam Reboilers are in a stand down status for routine maintenance or disassembly, an inspection should be conducted simultaneously. Prepare the Steam Reboiler as described in section 27.8 of this chapter for inspection of the Steam Reboiler shell watersides and Steam Reboiler controls and appurtenances.
- e. All deficiencies should be corrected as soon as possible, consistent with good engineering practices.

27.7.2 Reports.

- a. The SGPI shall provide an oral critique and preliminary report to the ship's Commanding Officer or his designated representative. The report will contain the findings of the inspection, with note of recurring discrepancies from previous inspections.

- b. The Senior inspector will forward a copy of the RIRMIS report with cover letter per sample shown in Appendix C to the ship's Commanding Officer no later than ten days after completion of all discrepancies.
- c. The SGPI shall report all RBO deficiencies discovered during the inspection to the TYCOM and ship's Commanding Officer by message, using the format in Appendix D, within 24 hours.
- d. The SGPI shall report by message to the TYCOM the correction and re-inspection of all RBO deficiencies prior to lighting off an inspected Steam Reboiler.
- e. The ship's Engineering Officer shall report corrected deficiencies, by message, to the TYCOM within 30 days of the completed inspection. A corrected RIRMIS report will be provided to the ship after the RIRMIS status codes are updated.
- f. The ship's Commanding Officer shall notify the TYCOM when a scheduled Steam Reboiler inspection cannot be conducted by submitting a DFS request. State the reason why the inspection cannot be conducted and recommend a revised date.

27.8 STEAM REBOILER INSPECTION PREPARATION.

- a. Demonstrate the performance of the controls to the SGPI assigned to conduct the inspection. Conduct this demonstration when engineering status can support.
- b. Wire shut and danger tag all steam and water valves to the Steam Reboiler using the Steam Plant Manual and reference (a) as guidance.
- c. Open manway, ventilate and gas free. Notify SGPI that watersides are available for inspection. The purpose of this inspection is to assess the effectiveness of the Steam Reboiler chemistry control procedures. Detailed waterside inspection will be conducted after completion of cleaning if determined by the inspector that a cleaning is necessary. Mechanically clean watersides to be inspected.
- d. Install temporary plugs in all nozzles, to prevent foreign debris from entering piping systems.

27.9 STEAM REBOILER INSPECTION.

27.9.1 Steam Reboiler Inspection Forms. Steam Reboiler inspections will be conducted using the appropriate RIRMIS forms. Include specific comments on the state of preservation and material condition of the Steam Reboiler.

27.9.2 Steam Reboiler Inspection Areas. The following areas are closely inspected for possible RBO deficiencies. RBO deficiencies may include but are not limited to the following:

- a. Inoperative/misadjusted safety devices.
- b. Lube oil contamination of control systems.
- c. Control equipment inoperable in their automatic mode or failed cold checks.
- d. Steam Reboiler that does not pass design hydrostatic test.
- e. Non-deferrable defects/indications in the pressure vessel boundary.
- f. Ultra-sonic tests on pressure vessel piping that are below minimum requirements, or when visual inspection dictates replacement.
- g. Tube leakage or unsatisfactory ECI results.

27.9.3 Completion of Inspection. An oral critique and a preliminary inspection report, including a summary of restrictive deficiencies, will follow the inspection. Paragraph 27.7.2 of this chapter identifies official reporting requirements.

27.10 STEAM REBOILER CONTROL SYSTEMS/ONLINE VERIFICATION GUIDELINES. Control systems which include steam pressure and water level controls have been designed and installed for the purpose of maintaining a steady pressure and volume of low pressure steam throughout the hotel steam piping system.

- a. Ships shall use controls at all times while the reboiler is in operation. Manual operation shall be used when the reboiler is lit-off and while securing. When the Automatic Boiler Control system cannot be operated in automatic, this fact shall be reported by a Casualty Report message. Prior to operating the reboiler, all applicable testing shall be completed.
- b. Maintenance and calibration of the Automatic Boiler Control systems shall be accomplished by qualified technicians in accordance with the direction provided in applicable PMS and the manufacturer's technical manual.

(This Page Intentionally Left Blank)

APPENDIX A

SAMPLE STEAM REBOILER INSPECTION REQUEST

FM USS (SHIP'S NAME AND HULL NO)//

TO: RMC//

INFO//

COMNAVAIRPAC/COMNAVAIRLANT//

NSWCCD//

COMNAVSEASYCOM WASHINGTON DC//

PEO CARRIERS WASHINGTON DC//

BT

UNCLAS//

MSGID/GENADMIN/USS (SHIP'S NAME HULL NO)//

SUBJ/REQUEST FOR ROUTINE REBOILER INSPECTION//

REF/A/DOC/COMUSFLTFORCOMINST 4790.3//

AMPN/REF A IS THE JOINT FLEET MAINTENANCE MANUAL//

GENTEXT/REMARKS/1. PER REF A REQUEST RMC PROVIDE A CERTIFIED SGPI TO ACCOMPLISH ROUTINE REBOILER INSPECTION OF (NUMBER) REBOILER.

2. REQUEST PRIMARY INSPECTION START DATE OF (PROVIDE DATE) AND AN ALTERNATE START DATE OF (PROVIDE DATE).//

BT

NOTE: ENSURE MESSAGES ARE IN ACCORDANCE WITH CURRENT MESSAGE FORMAT AND CURRENT PLAIN LANGUAGE ADDRESS DIRECTORY (PLAD) IS UTILIZED.

(This Page Intentionally Left Blank)

APPENDIX B
SAMPLE INSPECTION CONFIRMATION MESSAGE

FM RMC (COMMAND)//
TO USS (SHIP'S NAME HULL NUMBER)//
INFO COMNAVSURFFOR//
COMNAVAIRPAC/COMNAVAIRLANT//
ISIC//
COMNAVSEASYS COM WASHINGTON DC//
NAVSURFWAR CEN SHIPSYSENGSTA PHILADELPHIA PA//
BT
MSGID/GENADMIN/
SUBJ/INSPECTION DATE CONFIRMATION//
REF/A/MSG/USS (SHIPS NAME HULL NUMBER)/DTG REQUEST//
REF/B/DOC/COMUSFLTFORINST 4790.3//
NARR/REF A IS REQUESTING REBOILER INSPECTION. REF B IS COMUSFLTFORCOMINST 4790.3 VOL
IV, CHAP 27 DEFINING JOINT FLEET REBOILER INSPECTION CRITERIA AND PROCEDURES.//
POC/SENIOR SGPI/RATE/UIC/LOC:CITY /TEL:/DSN//
RMKS/1. IN RESPONSE TO REF A, AN (TYPE) REBOILER INSPECTION WILL BE CONDUCTED IAW
REF B BEGINNING (DATE) ON NUMBER () REBOILER. ONE OR MORE OF THE FOLLOWING
CERTIFIED INSPECTORS ARE ASSIGNED TO CONDUCT THE INSPECTIONS:
INSPECTOR NAME/RATE//LAST 4//CLEARANCE.
2. POC E-MAIL ADDRESS IS: SENIOR SGPI//
BT

**NOTE: ENSURE MESSAGES ARE IN ACCORDANCE WITH CURRENT MESSAGE FORMAT AND
CURRENT PLAD IS UTILIZED.**

(This Page Intentionally Left Blank)

APPENDIX C

SAMPLE STEAM REBOILER INSPECTION REPORT COVER LETTER

From: Commander, (Regional Maintenance Center)

To: Commanding Officer, USS (Ship's name and Hull No.)

Subj: (Routine, etc.) Inspection of Catapult(s) Number(s)

Ref: (a) COMUSFLTFORCOMINST 4790.3, Joint Fleet Maintenance Manual

Encl: (1) RIRMIS Report (Number Steam Reboiler)

1. (Parent Command) Steam Generating Plant Inspector(s) (Inspector's Name) inspected Steam Reboiler(s) Number(s) in USS (Ships Name and Hull No) on (date) while (ship's location).
2. Discrepancies, which require corrective action, are outlined in enclosures (Number of Enclosures).
3. Advance copies of Enclosure(s) have been delivered to the Ship's Commanding Officer
4. (Command) point of contact is (Senior Inspector), Code (Number), commercial telephone, (Number), DSN (Number) e-mail address is: (Address)

COPY TO (W/ENCL):
COMNAVAIRPAC
COMNAVAIRLANT
USS (Name Hull Number)

COPY TO (W/O ENCL):
NSWCCD-SSES (C922)

(This Page Intentionally Left Blank)

APPENDIX D
SAMPLE REBOILER INSPECTION
RBO/SEVERELY DEGRADED DEFICIENCIES MESSAGE

FM COMMANDING OFFICER, REGIONAL MAINTENANCE CENTER//
 TO USS (SHIP'S NAME AND HULL NO.)//
 INFO TYCOM//(AS APPROPRIATE)//
 ISIC//(AS APPROPRIATE)//
 COMNAVSEASYS COM WASHINGTON DC//
 NAVSURFWAR CEN SHIPSYSENGSTA PHILADELPHIA PA//
 BT
 UNCLAS//N09221//
 MSGID/GENADMIN/COMMANDING OFFICER, REGIONAL MAINTENANCE CENTER//
 SUBJ/USS (SHIP'S NAME AND HULL NO.) NR (1, 2) ROUTINE/STRENGTH AND INTEGRITY
 INSPECTION (AS APPROPRIATE)//
 REF/A/DOC/COMUSFLTFORCOMINST 4790.3//
 REF/B/DOC/NAVSEAINST 4790.8/OPNAVINST 4790.4//
 NARR/REF A IS JOINT FLEET MAINTENANCE MANUAL VOL IV CH 27 AND PROVIDES GUIDANCE
 FOR REBOILER INSPECTIONS. REF B IS 3-M MANUAL AND PROVIDES GUIDANCE FOR CSMP
 DOCUMENTATION//
 RMKS/1. REBOILER NUMBER (1, 2) ROUTINE/STRENGTH AND INTEGRITY (AS APPROPRIATE).
 INSPECTION CONDUCTED (DATE) BY (INSPECTOR'S NAME) WHILE (SHIP'S LOCATION). RBO
 DEFICIENCIES AND PROPOSED CORRECTIVE ACTIONS ARE REPORTED IAW REF A AS FOLLOWS:
 A. (RIRMIS ITEM NO, DEFICIENCY, REPAIR, ETC.)
 B.
 C.
 2. REBOILER NUMBER (1, 2) SHALL NOT BE STEAMED UNTIL ABOVE LISTED DEFICIENCIES ARE
 CORRECTED AND A REINSPECTION IS CONDUCTED IAW REF A.
 3. SEVERELY DEGRADED DEFICIENCIES AND PROPOSED CORRECTIVE ACTION ARE REPORTED
 IAW REF A AS FOLLOWS:
 A.
 B.
 C.
 4. SEVERELY DEGRADED DEFICIENCIES ARE REQUIRED TO BE CORRECTED PRIOR TO STEAMING
 OR MUST BE SUBMITTED FOR MAJOR DEPARTURE FROM SPECIFICATION (DFS).
 5. IAW REF A, DEFICIENCIES COMPLETED SHALL BE REPORTED EVERY 30 DAYS USING THE
 GUIDANCE PROVIDED IN VOLUME 4, CHAPTER 3, APPENDIX F. ALL DEFICIENCIES HAVE BEEN
 DOCUMENTED IN THE SHIPS CSMP FOR CORRECTIVE ACTION IAW REF B.//
 BT

**NOTE: ENSURE MESSAGES ARE IN ACCORDANCE WITH CURRENT MESSAGE FORMAT AND
 CURRENT PLAD IS UTILIZED.**

(This Page Intentionally Left Blank)

JOINT FLEET MAINTENANCE MANUAL
VOLUME V
QUALITY MAINTENANCE
LIST OF EFFECTIVE PAGES

Page Numbers	Change in Effect	Page Numbers	Change in Effect
i thru iv	Change 5	V-I-1-1	Change 5
v thru vi	Change 1	V-I-1-2	Change 3
vii thru viii	Change 3	V-I-1-3	Change 5
ix	Change 4	V-I-1-4 thru V-I-1-6	Change 4
x thru xvi	Change 5	V-I-1-7 thru V-I-1-25	Change 5
xvii thru xviii	Change 4	V-I-1-26	Change 3
xix	Change 5	V-I-1A-1 thru V-I-1A-2	Change 3
xx thru xxii	Change 4	V-I-2-1 thru V-I-2-20	Change 5
V-I-FWD-1	REV C	V-I-2A-1 thru V-I-2A-2	REV C
V-I-FWD-2 thru V-I-FWD-3	Change 1	V-I-2B-1 thru V-I-2B-2	REV C
V-I-FWD-4	REV C	V-I-2C-1 thru V-I-2C-4	Change 5
V-I-FWD-A-1 thru V-I-FWD-A-4	Change 5	V-I-2D-1 thru V-I-2D-2	Change 5
V-I-FWD-B-1 thru V-I-FWD-B-2	REV C	V-I-2E-1 thru V-I-2E-2	Change 5
V-I-FWD-B-3 thru V-I-FWD-B-5	Change 1	V-I-3-1 thru V-I-3-5	Change 5
V-I-FWD-B-6 thru V-I-FWD-B-8	REV C	V-I-3-6	REV C
V-I-FWD-B-9	Change 1	V-I-3A-1 thru V-I-3A-2	Change 2
V-I-FWD-B-10 thru V-I-FWD-B-13	REV C	V-I-3B-1 thru V-I-3B-4	Change 2
V-I-FWD-B-14 thru V-I-FWD-B-15	Change 1	V-I-3B-5 thru V-I-3B-6	Change 5
V-I-FWD-B-16	REV C	V-I-3C-1	Change 2
V-I-FWD-B-17 thru V-I-FWD-B-18	Change 3	V-I-3C-2 thru V-I-3C-4	Change 5
V-I-FWD-B-19 thru V-I-FWD-B-20	Change 4	V-I-4-1	Change 4

Page Numbers	Change in Effect	Page Numbers	Change in Effect
V-I-4-2 thru V-I-4-6	REV C	V-I-7A-1	REV C
V-I-4-7	Change 4	V-I-7A-2	Change 2
V-I-4-8	REV C	V-I-7A-3	Change 1
V-I-5-1	Change 3	V-I-7A-4	REV C
V-I-5-2	Change 4	V-I-7B-1	Change 2
V-I-5-3 thru V-I-5-5	Change 3	V-I-7B-2	Change 4
V-I-5-6	Change 4	V-I-7B-3 thru V-I-7B-4	Change 3
V-I-5-7 thru V-I-5-34	Change 5	V-I-7B-5 thru V-I-7B-10	Change 4
V-I-5A-1 thru V-I-5A-2	Change 3	V-I-7C-1 thru V-I-7C-2	REV C
V-I-5A-3	REV C	V-I-8-1	Change 4
V-I-5A-4	Change 3	V-I-8-2 thru V-I-8-5	Change 3
V-I-5B-1	Change 1	V-I-8-6 thru V-I-8-10	Change 5
V-I-5B-2	REV C	V-I-8-11 thru V-I-8-14	Change 3
V-I-5C-1	Change 1	V-I-8A-1 thru V-I-8A-2	REV C
V-I-5C-2	REV C	V-I-8A-3 thru V-I-8A-4	Change 2
V-I-5D-1 thru V-I-5D-2	REV C	V-I-8B-1 thru V-I-8B-2	REV C
V-I-5E-1 thru V-I-5E-2	Change 3	V-I-9-1 thru V-I-9-4	Change 2
V-I-5F-1	Change 5	V-I-9-5 thru V-I-9-7	Change 5
V-I-5F-2	Change 3	V-I-9-8	Change 4
V-I-5G-1 thru V-I-5G-2	Change 3	V-I-9-9	Change 5
V-I-6-1 thru V-I-6-31	Change 4	V-I-9-10	Change 4
V-I-6-32 thru V-I-6-39	Change 5	V-I-9A-1	Change 1
V-I-6-40	Change 4	V-I-9A-2	REV C
V-I-7-1	Change 2	V-I-9B-1	Change 1
V-I-7-2 thru V-I-7-5	Change 3	V-I-9B-2	REV C
V-I-7-6 thru V-I-7-8	Change 2	V-I-9C-1 thru V-I-9C-2	REV C
V-I-7-9	Change 3	V-I-9D-1 thru V-I-9D-3	Change 1
V-I-7-10	Change 2	V-I-9D-4	Change 4
V-I-7-11 thru V-I-7-12	Change 3	V-I-9D-5 thru V-I-9D-6	Change 1

Page Numbers	Change in Effect	Page Numbers	Change in Effect
V-I-9E-1	Change 2	V-I-13A-1 thru V-I-13A-2	REV C
V-I-9E-2	Change 1	V-I-13B-1 thru V-I-13B-2	Change 5
V-I-10-1 thru V-I-10-4	Change 2	V-III-FWD-1 thru V-III-FWD-2	REV C
V-I-10-5 thru V-I-10-8	Change 3	V-III-FWD-A-1 thru V-III-FWD-A-2	Change 5
V-I-11-1 thru V-I-11-2	Change 5	V-III-FWD-B-1 thru V-III-FWD-B-3	Change 1
V-I-11-3	Change 1	V-III-FWD-B-4 thru V-III-FWD-B-5	REV C
V-I-11-4	REV C	V-III-FWD-B-6 thru V-III-FWD-B-7	Change 4
V-I-11-5	Change 5	V-III-FWD-B-8	Change 3
V-I-11-6	REV C	V-III-1-1 thru V-III-1-6	Change 5
V-I-11-7	Change 5	V-III-2-1	Change 1
V-I-11-8	REV C	V-III-2-2	REV C
V-I-11-9	Change 1	V-III-3-1	Change 5
V-I-11-10	REV C	V-III-3-2	REV C
V-I-11-11	Change 1	V-III-4-1 thru V-III-4-2	REV C
V-I-11-12 thru V-I-11-16	Change 2	V-III-5-1	Change 5
V-I-11-17	Change 4	V-III-5-2 thru V-III-5-8	Change 2
V-I-11-18 thru V-I-11-22	REV C	V-III-5-9 thru V-III-5-10	Change 5
V-I-11-23	Change 3	V-III-5A-1	Change 1
V-I-11-24 thru V-I-11-25	Change 5	V-III-5A-2	REV C
V-I-11-26	Change 3	V-III-5B-1 thru V-III-5B-2	REV C
V-I-11-27	REV C	V-III-5C-1 thru V-III-5C-2	REV C
V-I-11-28	Change 5	V-III-5D-1 thru V-III-5D-2	REV C
V-I-11-29 thru V-I-11-36	REV C	V-III-5E-1 thru V-III-5E-2	REV C
V-I-11-37 thru V-I-11-190	Change 5	V-III-6-1	Change 2
V-I-12-1 thru V-I-12-4	REV C	V-III-6-2 thru V-III-6-4	REV C
V-I-13-1	Change 5	V-III-6-5	Change 2
V-I-13-2	REV C	V-III-6-6	Change 1

Page Numbers	Change in Effect	Page Numbers	Change in Effect
V-III-6-7 thru V-III-6-11	REV C		
V-III-6-12	Change 1		
V-III-6-13	REV C		
V-III-6-14 thru V-III-6-16	Change 4		
V-III-7-1 thru V-III-7-2	REV C		
V-III-8-1 thru V-III-8-2	REV C		
V-III-9-1 thru V-III-9-6	REV C		
V-III-10-1 thru V-III-10-2	REV C		
V-III-11-1 thru V-III-11-8	REV C		
V-III-11-9 thru V-III-11-10	Change 3		
V-III-11-11	Change 1		
V-III-11-12	REV C		
V-III-11-13 thru V-III-11-17	Change 5		
V-III-11-18	REV C		
V-III-11-19	Change 5		
V-III-11-20	REV C		
V-III-11-21 thru V-III-11-23	Change 5		
V-III-11-24	REV C		

JOINT FLEET MAINTENANCE MANUAL
VOLUME V
QUALITY MAINTENANCE
RECORD OF CHANGES

CHANGE NO.	DATE	TITLE OR BRIEF DESCRIPTION	ENTERED BY (INITIALS)

(This Page Intentionally Left Blank)

JOINT FLEET MAINTENANCE MANUAL CHANGE REQUEST FORM
<p>FROM: ACTIVITY/SHIP _____ E-MAIL ADDRESS _____ CODE/DEPT/SHOP _____ DATE _____ ORIGINATOR _____ TEL EXT () _____</p>
<p>VOL-PART-PARA NO. _____ FIGURE _____ TABLE _____ PROCESSING NORMAL _____ URGENT* _____ * (Justify in rationale below if urgent is marked and transmit via e-mail as "High Importance") PROBLEM DESCRIPTION:</p>
<p>RECOMMENDED CHANGE: (Include any proposed text addition/deletion)</p>
<p>RATIONALE:</p>

E-mail to PTNH.SUBMEPP.JFMMMGR@Navy.Mil

(If mailing, fold on dotted line on reverse side and mail to Submarine Maintenance Engineering, Planning and Procurement (SUBMEPP) Activity or send facsimile to (207) 438-6210.)

FOLD

Commanding Officer

OFFICIAL BUSINESS

Commanding Officer
Submarine Maintenance Engineering,
Planning and Procurement (SUBMEPP) Activity
Attn: Code 1832JM
P.O. Box 2500
Portsmouth Naval Shipyard
Portsmouth, NH 03804-2500

FOLD

JOINT FLEET MAINTENANCE MANUAL**VOLUME V****QUALITY MAINTENANCE****TABLE OF CONTENTS**

	Page No.
LIST OF EFFECTIVE PAGES	i
RECORD OF CHANGES	v
JOINT FLEET MAINTENANCE MANUAL CHANGE REQUEST FORM.....	vii
PART I	
FOREWORD - QUALITY MAINTENANCE	
1.1 Purpose	V-I-FWD-1
1.2 Scope	V-I-FWD-1
1.3 Manual Organization	V-I-FWD-1
1.3.1 Basic Maintenance Principles.....	V-I-FWD-1
1.3.2 Special Circumstances and Maintenance Support	V-I-FWD-1
1.3.3 Order of Precedence	V-I-FWD-2
1.3.3.1 Operations.....	V-I-FWD-2
1.3.3.2 Maintenance and Technical	V-I-FWD-2
1.3.4 Advisories	V-I-FWD-3
1.4 Need for Quality Maintenance Processes	V-I-FWD-3
1.5 Changes and Corrections	V-I-FWD-4
1.6 Request for Copies of the Manual	V-I-FWD-4
Appendices	
A List of Acronyms	V-I-FWD-A-1
B Glossary of Terms.....	V-I-FWD-B-1
CHAPTER 1 - ORGANIZATIONAL RESPONSIBILITIES	
1.1 Purpose	V-I-1-1
1.1.1 Quality Assurance Organization	V-I-1-1
1.2 Fleet Responsibilities.....	V-I-1-1
1.2.1 Fleet Commander (Fleet).....	V-I-1-1
1.3 Type Commander Responsibilities	V-I-1-2
1.3.1 Type Commander	V-I-1-2
1.4 Immediate Superior In Command Responsibilities	V-I-1-3
1.4.1 Immediate Superior In Command.....	V-I-1-3
1.5 Ship Responsibilities	V-I-1-6
1.5.1 Ship's Commanding Officer.....	V-I-1-7
1.5.2 Ship's Executive Officer.....	V-I-1-7
1.5.3 Ship's Department Head.....	V-I-1-7
1.5.4 Ship's Supply Officer	V-I-1-8
1.5.5 Ship's Engineer Officer (Submarines only).....	V-I-1-9
1.5.6 Availability Coordinator (Submarines only).....	V-I-1-9
1.5.7 Ship's Maintenance Manager (Aircraft Carriers only)	V-I-1-10
1.5.8 Ship's Principal Assistant	V-I-1-10
1.5.9 Ship's Division Officer	V-I-1-10
1.5.10 Ship's Work Center Supervisor	V-I-1-10

1.5.11	Ship's Craftsman	V-I-1-11
1.5.12	Ship's Quality Assurance Officer	V-I-1-11
1.5.13	Ship's Assistant Quality Assurance Officer.....	V-I-1-13
1.5.14	Ship's Quality Assurance Supervisor	V-I-1-13
1.5.15	Ship's Quality Assurance Inspectors	V-I-1-13
1.5.16	Ship's Controlled Material Petty Officer.....	V-I-1-14
1.5.17	Ship's Cleanliness Inspector/Certifier	V-I-1-15
1.5.18	Ship's Nondestructive Test Examiner	V-I-1-15
1.5.19	Ship's Nondestructive Test Inspector	V-I-1-16
1.5.20	Engineering Department Master Chief	V-I-1-16
1.5.21	Ship's Maintenance Planner (Submarines and Aircraft Carriers only).....	V-I-1-16
1.6	Regional Maintenance Center/Fleet Maintenance Activity Responsibilities	V-I-1-16
1.6.1	RMC Commander/FMA Commanding Officer	V-I-1-16
1.6.2	RMC Deputy Commander/FMA Executive Officer	V-I-1-17
1.6.3	RMC Production Officer/FMA Repair Officer.....	V-I-1-17
1.6.4	FMA Supply Officer.....	V-I-1-18
1.6.5	FMA Nuclear Repair Officer.....	V-I-1-19
1.6.6	RMC/FMA Planning and Estimating Officer	V-I-1-19
1.6.7	RMC/FMA Division Officer	V-I-1-20
1.6.8	RMC/FMA Work Center Supervisor.....	V-I-1-20
1.6.9	RMC/FMA Craftsman	V-I-1-20
1.6.10	RMC Quality Assurance Department Head (Code 130) or Industry Management Department (Code 400 at Puget Sound Naval Shipyard and Intermediate Maintenance Facility).....	V-I-1-21
1.6.11	RMC Code 133 Division Head/FMA Quality Assurance Officer	V-I-1-21
1.6.12	RMC/FMA Assistant Quality Assurance Officer	V-I-1-23
1.6.13	RMC/FMA Quality Assurance Supervisor	V-I-1-23
1.6.14	RMC/FMA Quality Assurance Inspector	V-I-1-23
1.6.15	RMC/FMA Controlled Material Petty Officer/Controlled Material Handler	V-I-1-23
1.6.16	RMC/FMA Cleanliness Inspector/Certifier	V-I-1-24
1.6.17	RMC/FMA Command Examiner.....	V-I-1-24
1.6.18	Nondestructive Test Division Officer	V-I-1-24
1.6.19	RMC/FMA Nondestructive Test Inspector.....	V-I-1-25
1.7	Other Activity Responsibilities.....	V-I-1-25
Appendices		
A	Format for Submarine QA Pre-Underway Checklist.....	V-I-1A-1

CHAPTER 2 - QUALITY MAINTENANCE PROCESSES

2.1	Purpose	V-I-2-2
2.2	Technical Work Documents	V-I-2-2
2.2.1	Minimum Requirements for using Technical Work Documents	V-I-2-2
2.2.2	Maintenance Procedure.....	V-I-2-3
2.2.3	Formal Work Package	V-I-2-4
2.2.4	Controlled Work Package.....	V-I-2-4
2.2.5	Maintenance Certification Record/Controlled Work Package (Non-SUBSAFE).....	V-I-2-6
2.2.6	Sequencing Document	V-I-2-7
2.3	Formal Work Package Development.....	V-I-2-7
2.3.1	Responsibility for Preparation of Formal Work Packages/Controlled Work Packages.....	V-I-2-7
2.3.2	Security Classification	V-I-2-7
2.3.3	Formal Work Package Format	V-I-2-8
2.3.3.1	Formal Work Package Elements Defined	V-I-2-8
2.3.3.2	Use and Transcribing of Source Documents.....	V-I-2-12
2.3.4	Formal Work Package Approval	V-I-2-12
2.3.5	Controlled Work Package Approval.....	V-I-2-13
2.3.6	Formal Work Package In Process Use.....	V-I-2-13

2.3.7	Formal Work Package Changes.....	V-I-2-13
2.3.7.1	Pen and Ink Changes.....	V-I-2-13
2.3.7.2	Rework Addendum.....	V-I-2-14
2.3.7.3	Revisions.....	V-I-2-14
2.3.7.4	Attachment.....	V-I-2-15
2.3.7.5	Supplement.....	V-I-2-16
2.3.7.6	Voiding.....	V-I-2-16
2.3.7.7	Formal Work Package Closeout.....	V-I-2-16
2.3.7.7.1	Completed Formal Work Packages.....	V-I-2-16
2.3.7.8	Controlled Work Package Closeout.....	V-I-2-16
2.3.7.9	Emergent Controlled Work.....	V-I-2-18
2.3.7.10	Standardized Formal Work Package.....	V-I-2-18
2.3.7.11	Lost Controlled Work Packages Following Controlled Work Package Approval.....	V-I-2-18
2.4	Troubleshooting.....	V-I-2-18
Appendices		
A	Technical Work Document Illustration.....	V-I-2A-1
B	Work Package Decision Process.....	V-I-2B-1
C	Certification Signature Requirements for Reactor Plant/Nuclear Support Facility/ Controlled Industrial Facility Work.....	V-I-2C-1
D	Formal Work Package Approval/Revision Sheet.....	V-I-2D-1
E	Technical Work Document Review and Approval Matrix.....	V-I-2E-1

CHAPTER 3 - PERSONNEL QUALIFICATION AND TRAINING

3.1	Purpose.....	V-I-3-1
3.2	General.....	V-I-3-1
3.2.1	Discussion.....	V-I-3-1
3.3	Qualification.....	V-I-3-1
3.3.1	Re-qualification.....	V-I-3-2
3.3.2	Required Service Record Entries.....	V-I-3-2
3.4	Qualification Requirements.....	V-I-3-2
3.4.1	Ship's Quality Assurance Officer.....	V-I-3-2
3.4.2	Ship's Assistant Quality Assurance Officer.....	V-I-3-2
3.4.3	Immediate Superior In Command.....	V-I-3-2
3.4.4	Regional Maintenance Center/Fleet Maintenance Activity Quality Assurance Officer.....	V-I-3-3
3.4.5	Regional Maintenance Center/Fleet Maintenance Activity Assistant Quality Assurance Officer.....	V-I-3-3
3.4.6	Quality Assurance Supervisor.....	V-I-3-3
3.4.7	Quality Assurance Inspector.....	V-I-3-3
3.4.8	Controlled Material Petty Officer/Controlled Material Handler.....	V-I-3-3
3.4.9	Steam Plant Cleanliness Inspector/Certifier.....	V-I-3-3
3.4.9.1	Qualification Requirements for Reactor Plant Cleanliness Inspector/ Certifier.....	V-I-3-3
3.4.10	Gas Systems Cleanliness Inspector/Certifier.....	V-I-3-4
3.4.11	Oxygen Clean Instructors.....	V-I-3-4
3.4.12	Ship's and Fleet Maintenance Activity Oxygen Clean Workers.....	V-I-3-4
3.4.13	Oxygen Calibration Technicians.....	V-I-3-4
3.4.14	Work Center Supervisors and Planners.....	V-I-3-4
3.4.15	Qualification Requirements for Submarine Nuclear Propulsion Plant Operator Welders (Navy Enlisted Classification Code 3351 and Supervisor Welders 3361).....	V-I-3-4
3.4.16	Qualification Requirements for Submarine Fly-By-Wire Ship Control System Maintenance Technician.....	V-I-3-4
3.5	Training.....	V-I-3-4
3.5.1	Maintenance Personnel Training.....	V-I-3-4
3.5.2	Requirements.....	V-I-3-5

3.5.3	Submarine Safety Awareness Training (Submarines and Submarine Repair Facilities only).....	V-I-3-5
-------	--	---------

Appendices

A	NAVEDTRA 43523 Qualification Matrix.....	V-I-3A-1
B	Outlines of Typically Effective Training Topics	V-I-3B-1
C	Recommended Training Topics for Selected Positions	V-I-3C-1

CHAPTER 4 - WELDER, BRAZER AND NONDESTRUCTIVE TESTING QUALIFICATIONS

4.1	Purpose	V-I-4-1
4.1.1	General Requirements.....	V-I-4-1
4.1.2	Training	V-I-4-1
4.2	General Requirements for Brazers and Welders.....	V-I-4-1
4.2.1	Eye Examination.....	V-I-4-2
4.2.2	Brazing and Welding Procedures.....	V-I-4-2
4.2.3	Brazing and Welding Personnel Knowledge	V-I-4-2
4.2.4	Brazer and Welder Identification Numbers	V-I-4-2
4.2.4.1	Brazer and Welder Identification Number Log.....	V-I-4-2
4.2.5	Validation of Qualification	V-I-4-2
4.2.6	Qualification Records	V-I-4-3
4.2.6.1	Individual Brazer/Welder Qualification File.....	V-I-4-3
4.2.6.1.1	Maintenance of Qualification	V-I-4-3
4.2.6.2	Method of Qualification Maintenance	V-I-4-3
4.2.6.3	Renewal of Qualification	V-I-4-3
4.2.7	Effective Date of Qualification.....	V-I-4-3
4.2.7.1	Qualification Results.....	V-I-4-4
4.3	Brazer Qualifications	V-I-4-4
4.3.1	Prerequisite	V-I-4-4
4.3.1.1	Qualification Test.....	V-I-4-4
4.3.2	Limitations.....	V-I-4-4
4.3.3	Test Assembly Evaluation	V-I-4-4
4.3.4	Maintenance of Qualification	V-I-4-4
4.3.5	Qualification Renewal	V-I-4-4
4.3.6	Transfer of Qualification	V-I-4-4
4.4	Qualification Requirements for Navy Enlisted Classification CODE 4955 Welders	V-I-4-4
4.4.1	Qualification Prerequisites.....	V-I-4-4
4.4.1.1	Navy Enlisted Classification Code Achievement	V-I-4-4
4.4.1.2	Specific Qualifications.....	V-I-4-4
4.4.2	Maintenance of Qualification	V-I-4-4
4.4.3	Qualification Renewal	V-I-4-4
4.4.4	Transfer of Qualification	V-I-4-4
4.4.5	Waiver of Qualification Tests.....	V-I-4-4
4.5	Non-Coded Hull Technicians	V-I-4-5
4.5.1	Authorization	V-I-4-5
4.5.2	Minor Structure Components.....	V-I-4-5
4.6	Qualification Requirements for Nondestructive Test Personnel.....	V-I-4-6
4.6.1	Purpose	V-I-4-6
4.6.2	Levels of Certification	V-I-4-6
4.6.3	Certification of Nondestructive Test Personnel	V-I-4-6
4.6.4	Renewal of Certification.....	V-I-4-6
4.6.5	Maintenance of Qualification	V-I-4-6
4.6.6	Qualification Administration	V-I-4-6
4.6.7	Approval of Nondestructive Testing Qualification Examinations.....	V-I-4-7
4.6.8	Transfer of Qualification	V-I-4-7
4.6.9	Nondestructive Testing Personnel Records	V-I-4-7
4.6.10	Nondestructive Testing Qualification Log.....	V-I-4-7

4.6.11	Qualification of Generic Material Identity Testing Personnel	V-I-4-7
4.6.12	Qualification Administration	V-I-4-7
4.6.12.1	Transfer of Qualification.....	V-I-4-7

CHAPTER 5 - IN-PROCESS CONTROL

5.1	Purpose	V-I-5-2
5.2	Test, Measurement and Diagnostic Equipment	V-I-5-2
5.2.1	General Requirements.....	V-I-5-2
5.2.2	Torque Wrenches.....	V-I-5-2
5.2.3	Gauges	V-I-5-4
5.3	Torque.....	V-I-5-5
5.3.1	General Requirements.....	V-I-5-5
5.4	Inspections	V-I-5-5
5.4.1	General Requirements.....	V-I-5-5
5.4.2	Inspection Records.....	V-I-5-5
5.4.3	Critical Inspections	V-I-5-5
5.4.4	Cleanliness Inspections.....	V-I-5-7
5.4.5	Nuclear Propulsion Plant and Nuclear Support Facility General Cleanliness Requirements.....	V-I-5-8
5.4.5.1	Reactor Plant.....	V-I-5-8
5.4.5.2	Steam Plant	V-I-5-8
5.4.5.3	Nuclear Support Facility	V-I-5-8
5.4.5.4	Standard Lubricants and Penetrating Fluid	V-I-5-8
5.4.6	General Shipboard Steam Plant Systems Cleanliness Requirements	V-I-5-8
5.4.6.1	Purpose	V-I-5-8
5.4.6.2	Applicability	V-I-5-8
5.4.6.3	Discussion.....	V-I-5-9
5.4.6.4	Requirements	V-I-5-9
5.4.7	Set Stud Inspection	V-I-5-10
5.5	Software.....	V-I-5-10
5.5.1	Determination of Acceptability and Use of Piping System Software	V-I-5-10
5.6	Submarine Safety Maintenance Certification/Re-Entry Control Nuclear and Non-Nuclear.....	V-I-5-12
5.6.1	Purpose	V-I-5-12
5.6.1.1	General.....	V-I-5-12
5.6.2	Re-Entry Control Program.....	V-I-5-12
5.6.3	Nuclear Submarine Safety System Re-Entry	V-I-5-13
5.6.3.1	Reactor Plant Planning Yard Liaison Action Requests.....	V-I-5-13
5.6.4	Re-Entry Control Administrative Procedures	V-I-5-13
5.6.5	Using a Controlled Dive Departure from Specification to Close a Maintenance Certification Record/Re-Entry Control.....	V-I-5-16
5.6.6	Voyage or At Sea Repairs.....	V-I-5-16
5.6.7	Exceptions to Re-Entry Control.....	V-I-5-17
5.6.8	Certification Continuity Report	V-I-5-18
5.7	Reactor Plant Work Accomplishment Report (Submarines Only)	V-I-5-19
5.7.1	Purpose	V-I-5-19
5.7.2	Specific Instructions for Completing Reactor Plant Work Accomplishment Report Cover Sheet.....	V-I-5-19
5.7.3	Specific Instructions for Completing Reactor Plant Certification When New or Previously Uncertified Material is Installed in a Submarine Safety Application	V-I-5-20
5.7.4	Specific Instructions for Completing Reactor Plant Certification When Previously Certified Material is Reinstalled	V-I-5-20
5.8	Material Condition Monitoring (Submarines Only)	V-I-5-20
5.8.1	Unrestricted Operations Maintenance Requirement Card Program.....	V-I-5-20
5.9	Submarine Fly-By-Wire Maintenance Certification.....	V-I-5-21

5.9.1	Purpose	V-I-5-21
5.9.1.1	General.....	V-I-5-21
5.9.1.2	Applicability	V-I-5-22
5.9.1.3	Submarine Flight Critical Component Boundary.....	V-I-5-22
5.9.2	Submarine Flight Critical Component Boundary Work Control Procedures.....	V-I-5-22
5.9.3	Submarine Flight Critical Component Boundary Work Control Closeout	V-I-5-22
5.9.4	Objective Quality Evidence to Support Controlled Work on Fly-By-Wire Ship Control System Submarine Flight Critical Component	V-I-5-23
5.10	Aircraft Carrier Maintenance Documents.....	V-I-5-23
5.10.1	Purpose	V-I-5-23
5.10.2	Non-Nuclear Deviations, Waivers and Departure from Specifications	V-I-5-23
5.10.2.1	During a Maintenance Action.....	V-I-5-23
5.10.2.2	During Operations.....	V-I-5-24
5.10.3	Liaison Action Requests - Nuclear Cognizant Areas	V-I-5-24
5.10.3.1	Technical Responsibilities	V-I-5-24
5.10.3.2	Technical Resolution	V-I-5-24
5.10.4	Nuclear Liaison Inquiry - Nuclear Cognizant Areas.....	V-I-5-25
5.10.5	Steam Plant Action Request - Non-Nuclear Cognizant Areas	V-I-5-25
5.10.5.1	Usage	V-I-5-25
5.10.5.2	Validation.....	V-I-5-26
5.10.5.3	Categories	V-I-5-26
5.10.5.4	Coordination	V-I-5-26
5.10.5.5	Routing	V-I-5-26
5.10.5.6	Status.....	V-I-5-26
5.10.5.7	Software	V-I-5-27
5.10.5.8	Process Map.....	V-I-5-27
5.10.6	Steam Plant Liaison Inquiry - Non-Nuclear Cognizant Areas	V-I-5-27
5.10.6.1	Process Manager	V-I-5-27
5.10.6.2	Amplifying Information.....	V-I-5-27
5.10.7	Reactor Plant Configuration Change Report.....	V-I-5-27
5.10.8	Technical Manual Deficiencies and Manual Change Requests	V-I-5-30
5.10.8.1	Technical Manual Maintenance	V-I-5-30
5.10.8.2	Technical Manual Deficiency/Evaluation Report	V-I-5-30
5.10.8.3	URGENT Deficiencies	V-I-5-30
5.10.8.4	Routine Deficiencies.....	V-I-5-30
5.10.8.5	Technical Manual Deficiency/Evaluation Report Process.....	V-I-5-30
5.10.9	Fleet COSAL Feedback Report	V-I-5-31
5.10.9.1	Usage	V-I-5-31
5.10.9.2	Misuse.....	V-I-5-31
5.10.9.3	Form Location.....	V-I-5-32

Appendices

A	Determining Software Usability	V-I-5A-1
B	Format for Submarine Certification Continuity Report	V-I-5B-1
C	Format for Fleet Maintenance Activity Certification Report to Tended Submarine.....	V-I-5C-1
D	Format for Non-Fleet Maintenance Activity Certification Report to Tended Submarine	V-I-5D-1
E	RPCCR Cover Letter for SHIPALTs (Sample)	V-I-5E-1
F	Technical Manual Deficiency Report (TMDER).....	V-I-5F-1
G	Fleet COSAL Feedback Report	V-I-5G-1

CHAPTER 6 - MATERIAL CONTROL

6.1	Purpose	V-I-6-1
6.1.1	Discussion.....	V-I-6-1
6.2	Nuclear.....	V-I-6-1
6.2.1	Controlled Material Determination.....	V-I-6-2
6.2.1.1	General Requirements.....	V-I-6-2
6.2.1.2	Determination of Required Repair Parts	V-I-6-2

6.2.1.3	Determination of Level of Control.....	V-I-6-2
6.2.1.4	Nuclear Material Level Determination	V-I-6-2
6.2.2	Controlled Material Procurement	V-I-6-2
6.2.2.1	General Requirements.....	V-I-6-3
6.2.2.2	Controlled Material Procurement.....	V-I-6-3
6.2.3	Receipt Inspection of Nuclear Controlled Material	V-I-6-3
6.2.3.1	General Requirements.....	V-I-6-3
6.2.3.2	Quality Assurance Forms for Receipt Inspections.....	V-I-6-4
6.2.3.3	Nuclear Receipt Inspection	V-I-6-4
6.2.3.3.1	Receipt Inspection of Nuclear Material	V-I-6-4
6.2.3.4	General Requirements for Nuclear Material	V-I-6-4
6.2.3.5	Nuclear Material Receipt Inspection Procedures	V-I-6-5
6.2.4	Marking of Nuclear Repair Parts	V-I-6-7
6.2.4.1	General Requirements.....	V-I-6-7
6.2.4.2	Marking Requirements for Nuclear Repair Parts	V-I-6-8
6.2.4.3	Assignment of Material Identification and Control Numbers for Items Manufactured from Certified Raw Materials	V-I-6-9
6.2.5	Nuclear Repair Parts Downgrading	V-I-6-9
6.2.5.1	Nuclear Controlled Material Downgrading.....	V-I-6-9
6.2.6	Storage, Issue and Handling of Nuclear Repair Parts	V-I-6-10
6.2.6.1	Storage Requirements	V-I-6-10
6.2.6.2	Staging Requirements	V-I-6-11
6.2.6.3	Issue of Nuclear Controlled Material.....	V-I-6-11
6.2.6.4	Handling of Nuclear Controlled Material	V-I-6-11
6.3	Non-Nuclear	V-I-6-16
6.3.1	Controlled Material Determination	V-I-6-16
6.3.1.1	General Requirements.....	V-I-6-17
6.3.1.1.1	Determination of Required Repair Parts.....	V-I-6-17
6.3.1.1.2	Determination of Level of Control	V-I-6-17
6.3.1.2	Non-Nuclear Material Level Determination	V-I-6-17
6.3.1.2.1	Systems and Components	V-I-6-17
6.3.1.2.2	Emergent Situation Upgrading	V-I-6-18
6.3.1.3	Non-Nuclear Level I Systems and Boundaries	V-I-6-18
6.3.1.4	Level I Components.....	V-I-6-19
6.3.2	Quality Assurance List (Submarines only)	V-I-6-21
6.3.3	Controlled Material Procurement	V-I-6-21
6.3.3.1	General Requirements.....	V-I-6-21
6.3.3.2	Controlled Material Procurement.....	V-I-6-22
6.3.4	Receipt Inspection of Controlled Material.....	V-I-6-23
6.3.4.1	General Requirements.....	V-I-6-23
6.3.4.2	Quality Assurance Forms for Receipt Inspections.....	V-I-6-24
6.3.4.3	Receipt Inspection and Certification of Valve Balls.....	V-I-6-24
6.3.4.4	Level I and Submarine Flight Critical Component Receipt Inspection.....	V-I-6-24
6.3.4.5	General Requirements for Level I and Submarine Flight Critical Component Material	V-I-6-24
6.3.5	Receipt Inspection of Open Purchase (Non-Supply System) or Locally Manufactured Material or Upgrading Supply System Material to Level I (Fleet Maintenance Activity only).....	V-I-6-29
6.3.5.1	Uncertified Material Required for Level I Applications	V-I-6-29
6.3.5.2	Uncertified Material Required for SUBSAFE Applications.....	V-I-6-30
6.3.5.3	Uncertified Material Required for Submarine Flight Critical Component Applications	V-I-6-30
6.3.6	Authorized Material Certification Activities	V-I-6-30
6.3.6.1	Currently or Previously Authorized Material Certification Activities	V-I-6-30
6.3.7	Marking of Level I Stock Program Material and Controlled Material.....	V-I-6-32
6.3.7.1	General Requirements.....	V-I-6-32
6.3.7.2	Level I Material.....	V-I-6-33

6.3.7.3	Assignment of Material Identification and Control Numbers for Items Manufactured from Certified Raw Materials	V-I-6-34
6.3.8	Level I Submarine Flight Critical Component Stock Program Material Downgrading	V-I-6-35
6.3.8.1	Material Downgrading	V-I-6-35
6.3.9	Storage, Issue and Handling of Level I/Scope of Certification/Submarine Flight Critical Component Stock Program Material	V-I-6-35
6.3.9.1	Storage Requirements	V-I-6-35
6.3.9.2	Staging Requirements	V-I-6-37
6.3.9.3	Issue of Level I/Scope of Certification/Submarine Flight Critical Component Controlled Material	V-I-6-37
6.3.9.4	Handling of Material	V-I-6-37
6.3.9.5	Maintaining Accountability	V-I-6-38

CHAPTER 7 - TESTING REQUIREMENTS

7.1	General.....	V-I-7-1
7.1.1	Testing Requirements for Systems, Portions of Systems and Components.....	V-I-7-2
7.2	Testing	V-I-7-3
7.2.1	Test Procedures.....	V-I-7-3
7.2.2	Test Requirements	V-I-7-4
7.2.3	Test Pressure Source References	V-I-7-5
7.2.4	Non-Nuclear Pressure Drop Tests	V-I-7-5
7.2.4.1	General Instructions	V-I-7-5
7.2.4.2	Calculations	V-I-7-6
7.2.4.3	Example	V-I-7-6
7.3	Weight Handling Equipment	V-I-7-7
7.3.1	Weight Handling Equipment	V-I-7-7
7.4	Exemptions/Alternative Test Requirements (Non-Nuclear)	V-I-7-8
7.4.1	General.....	V-I-7-8
7.4.2	Exemptions/Alternatives to Test Requirements (Non-Nuclear unless Specifically Addressed in Nuclear Technical Documents).....	V-I-7-9
7.5	Reactor Plant and Nuclear Support Facility Testing	V-I-7-11
7.5.1	Hydrostatic/Pneumatic Tests or Drop Tests.....	V-I-7-11
7.5.2	Mechanical Joint Fasteners	V-I-7-11
7.5.3	Valve Seat Leak Tests.....	V-I-7-12
7.6	Supplemental Test Criteria (Non-Nuclear)	V-I-7-12
7.6.1	Purpose	V-I-7-12
Appendices		
A	Testing Requirements for Surface Ship Systems.....	V-I-7A-1
B	Testing Requirements for Submarine Systems	V-I-7B-1
C	SUBMEPP Product Feedback	V-I-7C-1

CHAPTER 8 - DEPARTURE FROM SPECIFICATION (DFS/WAIVERS/NUCLEAR LIAISON ACTION REQUEST/STEAM PLANT ACTION REQUESTS)

8.1	Purpose	V-I-8-1
8.1.1	Background.....	V-I-8-1
8.1.2	Terminology	V-I-8-1
8.1.3	Specification	V-I-8-1
8.2	Departure From Specification.....	V-I-8-2
8.2.1	Reporting Departures from Specification	V-I-8-3
8.2.2	Types of Departures from Specification	V-I-8-3
8.2.3	Permanent and Temporary Approval of Departure from Specification	V-I-8-3
8.2.4	Major Departure from Specification.....	V-I-8-4
8.2.5	Minor Departure from Specification.....	V-I-8-6

8.3	Departure From Specification Procedures	V-I-8-7
8.3.1	General Administrative Requirements.....	V-I-8-7
8.3.2	Review of Outstanding Departures from Specification	V-I-8-8
8.3.3	Clearing of Departure from Specification by Exposing Sea Connected Systems and Hull Integrity Boundary Items to Submergence Pressure (Submarines only)	V-I-8-9
8.3.4	Incorporation of Departure from Specification in Selected Record Drawings/Data or Technical Variance Documentation.....	V-I-8-9
8.3.5	Preparations for Correction of Departure from Specification and Clearance During Depot Level Availabilities.....	V-I-8-9
8.3.6	Numbering of Departures from Specification.....	V-I-8-9
8.3.7	Submission and Approval of Departures from Specification.....	V-I-8-9
8.3.8	Departure from Specification Approval and Reporting for Ships While at Sea or at a Port Without a Fleet Maintenance Activity	V-I-8-11
	8.3.8.1 Evaluation	V-I-8-11
	8.3.8.2 Condition not Corrected.....	V-I-8-11
8.3.9	Extending a Temporary Departure.....	V-I-8-11
8.3.10	Electronic Non-Conformance Administration	V-I-8-12
8.4	Nuclear Cognizant Areas	V-I-8-13
8.4.1	Nuclear Powered Surface Ships.....	V-I-8-13
8.4.2	Reactor Plant Systems	V-I-8-13
8.4.3	Propulsion Plant Systems (Aircraft Carriers only)	V-I-8-14
Appendices		
A	Departure From Specification Request Message Format.....	V-I-8A-1
B	Departure From Specification Clearance/Cancellation Report Message Format.....	V-I-8B-1

CHAPTER 9 - AUDITS, SURVEILLANCE, EVALUATIONS AND ASSESSMENTS

9.1	Purpose	V-I-9-1
9.2	General.....	V-I-9-1
9.2.1	Audits.....	V-I-9-1
9.2.2	Surveillance	V-I-9-2
9.2.3	Evaluation	V-I-9-2
9.2.4	Assessments	V-I-9-2
9.2.5	Key Elements.....	V-I-9-2
9.2.6	Record Retention	V-I-9-2
9.3	Responsibilities and Procedures	V-I-9-2
9.3.1	Ship's Force Audits, Surveillance and Evaluation Program.....	V-I-9-2
9.3.2	Fleet Maintenance Activity Audit, Surveillance and Evaluation Program	V-I-9-3
9.3.3	Immediate Superiors in Command Assessments, Audits and Surveillance	V-I-9-4
9.3.4	Type Commander Assessments	V-I-9-6
9.4	Reporting Audit, Surveillance and Assessment Results and Corrective Action.....	V-I-9-7
9.4.1	Reporting Requirements for External Audits, Surveillances and Assessments	V-I-9-7
9.4.2	Correcting Deficiencies in Certified Controlled Work Packages or Objective Quality Evidence Records	V-I-9-8
Appendices		
A	Vertical Audits.....	V-I-9A-1
B	Horizontal Audits.....	V-I-9B-1
C	Surveillances.....	V-I-9C-1
D	Submarine Quality Assurance Assessment Evaluation Criteria	V-I-9D-1
E	Quality Assurance Audit/Assessments/Surveillance Discrepancy Form.....	V-I-9E-1

CHAPTER 10 - QUALITY ASSURANCE RECORDS

10.1	Purpose	V-I-10-1
10.2	General.....	V-I-10-1

10.2.1	Quality Assurance Record Requirements	V-I-10-1
10.2.2	Record Retention in General.....	V-I-10-1
10.3	Type Commander Quality Assurance Record Retention	V-I-10-3
10.3.1	Assessment Record Retention	V-I-10-3
10.3.2	Departure from Specification Record Retention.....	V-I-10-3
10.3.3	Material Certification Statement Retention (Submarines only).....	V-I-10-3
10.4	Immediate Superior In Command Quality Assurance Record Retention	V-I-10-3
10.4.1	Assessment and Surveillance Record Retention.....	V-I-10-3
10.4.2	Departure from Specification Record Retention.....	V-I-10-4
10.4.3	Material Certification Statement Retention (Submarines only).....	V-I-10-4
10.5	Ship's Quality Assurance Record Retention	V-I-10-4
10.5.1	Controlled Work Package Log	V-I-10-4
10.5.2	Completed Controlled Work Packages	V-I-10-4
10.5.3	Controlled Material Records.....	V-I-10-4
10.5.4	Qualification Records	V-I-10-5
10.5.5	Departure from Specification Records.....	V-I-10-5
10.5.6	Assessments, Evaluations and Audits.....	V-I-10-5
10.5.7	Training	V-I-10-5
10.6	Additional Submarine/Nuclear Unique Quality Assurance Record Retention Requirements	V-I-10-6
10.6.1	Submarine Safety/Nuclear/Level I/Submarine Flight Critical Component/Scope of Certification/Other Certification.....	V-I-10-6
10.6.1.1	Reactor Plant Work Accomplishment Report (Submarines only)	V-I-10-6
10.6.1.2	Submarine Safety Material Certification (Submarines only)	V-I-10-6
10.6.1.3	End of Fleet Maintenance Availability Certification (Submarines only).....	V-I-10-6
10.6.1.4	Certification Continuity Reports (Submarines only).....	V-I-10-6
10.6.1.5	Industrial Activity Certification Reports (Submarines only)	V-I-10-6
10.6.1.6	Other Certification Reports (Submarines only)	V-I-10-6
10.6.1.7	Controlled Material (Submarines only)	V-I-10-6
10.6.1.8	Nuclear Records.....	V-I-10-6
10.6.1.9	Nuclear Propulsion Plant Operator Welder Records (Submarines only)	V-I-10-6
10.6.1.10	Re-Entry Control/Maintenance Certification Record Exception Objective Quality Evidence and Other Controlled Assembly Records.....	V-I-10-6
10.6.1.11	Scope of Certification (Submarines only)	V-I-10-7
10.6.1.12	Unrestricted Operations (Submarines only).....	V-I-10-7
10.7	Fleet Maintenance Activity Quality Assurance Record Retention	V-I-10-7
10.7.1	Submarine Safety/Nuclear/Level I/Scope of Certification/Other Certification	V-I-10-7
10.7.2	Reactor Plant Work Accomplishment Report (Submarines only)	V-I-10-7
10.7.3	Controlled Work Package Log	V-I-10-7
10.7.4	Completed Controlled Work Packages	V-I-10-7
10.7.5	Controlled Material Records.....	V-I-10-7
10.7.6	Assessment, Audits, Surveillance and Evaluations.....	V-I-10-7
10.7.7	End of Fleet Maintenance Activity Certification Report to Tended Submarines (Submarines only).....	V-I-10-8
10.7.8	Nuclear/Submarine Safety/Scope of Certification Work.....	V-I-10-8
10.7.9	Qualification Record.....	V-I-10-8

CHAPTER 11 - QUALITY ASSURANCE FORMS AND FORM INSTRUCTIONS

11.1	Purpose	V-I-11-1
11.2	National Item Identification Number.....	V-I-11-1
11.3	List of Forms	V-I-11-1

CHAPTER 12 - SUBMARINE PRESERVATION

12.1 Purpose V-I-12-1
 12.1.1 Scope V-I-12-1
 12.2 General Preservation Requirements..... V-I-12-1
 12.3 Submarine Preservation Maintenance Processes V-I-12-1
 12.3.1 Maintenance Processes V-I-12-1
 12.3.2 Coating System Maintenance Authorization V-I-12-1
 12.4 Quality Assurance for Critical Coated Areas..... V-I-12-2
 12.4.1 Critical Coated Areas..... V-I-12-2
 12.4.2 Requirements for Critical Coated Areas V-I-12-2
 12.4.3 Test and Inspection Records V-I-12-2
 12.4.4 Blaster and Painter Certification..... V-I-12-2
 12.4.5 Coating Inspector Certification..... V-I-12-2
 12.4.6 Coating Inspector Responsibilities V-I-12-3
 12.4.6.1 Inspection of Storage and Receipt Inspection Facilities V-I-12-3
 12.4.6.2 In-Process Inspections V-I-12-3
 12.4.7 Inspection of Final Coating System..... V-I-12-3
 12.4.8 Review of Records for Final Coating Evaluation V-I-12-3
 12.4.9 Acceptance/Rejection of Final Coating Systems V-I-12-4

CHAPTER 13 - WIRE REMOVAL AND REPLACEMENT

13.1 Purpose V-I-13-1
 13.1.1 Discussion..... V-I-13-1
 13.2 Action V-I-13-1

Appendices

A Wire Removal/Replacement Form MAT-2 V-I-13A-1
 B Submarine Wire Removal/Replacement Form MAT-3 V-I-13B-1

PART III

FOREWORD - SCOPE OF CERTIFICATION

1 Purpose V-III-FWD-1
 2 Scope V-III-FWD-1
 3 Need For Scope of Certification Quality Maintenance Processes V-III-FWD-1

Appendices

A List of Acronyms V-III-FWD-A-1
 B Glossary of Terms..... V-III-FWD-B-1

CHAPTER 1 - ORGANIZATIONAL RESPONSIBILITIES

1.1 Purpose V-III-1-1
 1.1.1 Scope of Certification Organization V-III-1-1
 1.2 Responsibilities..... V-III-1-1
 1.2.1 Type Commander V-III-1-1
 1.2.2 Immediate Superior In Command..... V-III-1-2
 1.2.3 Sustaining Activity/User Activity..... V-III-1-4

CHAPTER 2 - QUALITY MAINTENANCE PROCESSES

2.1 Applicability V-III-2-1
 2.2 Controlled Work Package..... V-III-2-1

CHAPTER 3 - PERSONNEL QUALIFICATION AND TRAINING

3.1	Applicability	V-III-3-1
3.2	General.....	V-III-3-1
3.3	Discussion.....	V-III-3-1
3.4	Qualification Requirements	V-III-3-1
3.4.1	Qualifications.....	V-III-3-1
3.4.2	Scope of Certification Quality Maintenance Qualifications	V-III-3-1
3.5	Training	V-III-3-1
3.5.1	Scope of Certification Awareness Training (Submarines and Submarine Repair Facilities Only).....	V-III-3-1

CHAPTER 4 - WELDER, BRAZER AND NONDESTRUCTIVE TESTING QUALIFICATIONS

4.1	Applicability	V-III-4-1
-----	---------------------	-----------

CHAPTER 5 - IN PROCESS CONTROL

5.1	Purpose	V-III-5-1
5.2	Exceptions to Re-Entry Control.....	V-III-5-1
5.3	Planned Maintenance.....	V-III-5-1
5.4	Test, Measurement and Diagnostic Equipment	V-III-5-2
5.5	Torque.....	V-III-5-2
5.6	Inspections	V-III-5-2
5.6.1	General Requirements.....	V-III-5-2
5.6.2	Inspection Records.....	V-III-5-2
5.6.3	Critical Inspections	V-III-5-2
5.6.4	Cleanliness Inspections.....	V-III-5-3
5.7	Software.....	V-III-5-4
5.7.1	Determination of Acceptability and Use of Piping System Software	V-III-5-4
5.8	Scope of Certification Maintenance Certification/Re-Entry Control	V-III-5-4
5.8.1	Purpose	V-III-5-4
5.8.1.1	General	V-III-5-4
5.8.2	Re-Entry Control Program.....	V-III-5-4
5.8.3	Re-Entry Control Administrative Procedures.....	V-III-5-5
5.8.4	Using a Departure from Specification to Close a Maintenance Certification Record/Re-Entry Control.....	V-III-5-7
5.8.5	Voyage or At Sea Repairs.....	V-III-5-8
5.8.6	Exceptions to Re-Entry Control.....	V-III-5-8
5.8.6.1	Controlled Assembly Requirements for SOC REC Exceptions	V-III-5-9
5.8.7	Certification Continuity Report	V-III-5-9
5.9	Material Condition Monitoring (Submarines only)	V-III-5-9
5.9.1	Hull Integrity Procedures Program	V-III-5-9
5.10	Temporary Modifications	V-III-5-10
5.10.1	Temporary Modification Program	V-III-5-10
5.10.2	Configuration Control.....	V-III-5-10

Appendices

A	Message Format for Certification Continuity for DSS	V-III-5A-1
B	Letter Format for Certification Report to Tended DSS	V-III-5B-1
C	Message Format for DDS Transfer of Custody Certificate of Continuity for Off-loads	V-III-5C-1
D	Message Format for DDS Transfer of Custody Certificate of Continuity for On-loads	V-III-5D-1
E	Message Format for DDS Acceptance of Custody	V-III-5E-1

CHAPTER 6 - MATERIAL CONTROL

6.1	Purpose	V-III-6-1
6.1.1	Discussion.....	V-III-6-1
6.2	Controlled Material Determination.....	V-III-6-1
6.2.1	General Requirements.....	V-III-6-1
6.2.2	Scope of Certification Material Control Divisions	V-III-6-1
6.3	Receipt Inspection of Controlled Material.....	V-III-6-2
6.3.1	General Requirements.....	V-III-6-3
6.3.2	Quality Assurance Forms for Receipt Inspections.....	V-III-6-4
6.3.3	NAVSUP WSS DSS-SOC Stock Program Material.....	V-III-6-4
6.3.3.1	Material Objective Quality Evidence.....	V-III-6-4
6.3.4	General Requirements for Receipt of Scope of Certification Material.....	V-III-6-5
6.3.5	Verification of Completion of Required Testing	V-III-6-10
6.3.6	Authorized Material Certification Activities	V-III-6-10
6.3.7	Marking of DSS-SOC Stock Program Material.....	V-III-6-11
6.3.7.1	General Requirements.....	V-III-6-11
6.3.7.2	SMIC DSS-SOC Material Acceptance Identification.....	V-III-6-11
6.4	Storage, Issue and Handling of Scope of Certification Material.....	V-III-6-12
6.5	Re-use of Previously Certified Scope of Certification Material	V-III-6-12
6.5.1	Material Removed from a Deep Submergence System/Operating Ship	V-III-6-12
6.5.1.1	Non-Conforming Material	V-III-6-12
6.5.2	Reuse of Scope of Certification Material.....	V-III-6-13
6.5.3	Material Recertification Required.....	V-III-6-13
6.5.4	Material Recertification Following Transfer to Outside Agency (Excluding Naval Shipyards).....	V-III-6-14
6.5.5	Material Recertification Following Transfer to a Naval Shipyard.....	V-III-6-14

CHAPTER 7 - TESTING REQUIREMENTS

7.1	Purpose	V-III-7-1
7.2	Testing Requirements	V-III-7-1

CHAPTER 8 - DEPARTURE FROM SPECIFICATIONS

8.1	Purpose	V-III-8-1
8.2	Departure from Specification.....	V-III-8-1
8.2.1	Reporting Departures from Specification	V-III-8-1
8.2.2	Approval of Departures from Specification.....	V-III-8-1
8.2.3	Major and Minor Departure from Specification Classification	V-III-8-1
8.2.4	General Administrative Requirements.....	V-III-8-1
8.2.5	Submission and Approval of Departures from Specification.....	V-III-8-2
8.2.6	Departure from Specification Approval and Reporting for DSSs While at Sea	V-III-8-2

CHAPTER 9 - AUDITS, SURVEILLANCE, EVALUATIONS, ASSESSMENTS AND SURVEYS

9.1	Purpose	V-III-9-1
9.2	Responsibilities and Procedures	V-III-9-1
9.2.1	User Activity Surveillance and Evaluation Program	V-III-9-1
9.2.2	Sustaining Activity Audit, Surveillance and Evaluation Program.....	V-III-9-1
9.2.3	Immediate Superiors In Command Assessments, Audits and Surveillance.....	V-III-9-1
9.2.4	Type Commander Assessments	V-III-9-2
9.3	System Certification Authority Certification Surveys and Functional Audits.....	V-III-9-2

9.3.1 Certification Process V-III-9-2

9.3.2 Certification Survey Cards..... V-III-9-2

9.3.2.1 Categorization of Certification Survey Cards V-III-9-2

9.3.2.2 Categorization of Functional Audit Cards V-III-9-2

9.3.3 Administration of Survey/Audit Findings V-III-9-2

9.3.4 Administration of Surveys for Initial Certification or Reinstatement of Certification..... V-III-9-3

9.3.4.1 Actions to Support Surveys for Initial Certification
or Reinstatement of Certification V-III-9-3

9.3.4.2 Authorization of Operational Demonstration for Initial Certification
or Reinstatement of Certification V-III-9-4

9.3.4.3 Certification/Reinstatement of Certification V-III-9-4

9.3.5 Manned Use in Pursuit of Certification or Reinstatement of Certification..... V-III-9-4

9.3.6 Sustaining Certification Surveys..... V-III-9-5

9.3.6.1 Scheduling V-III-9-5

9.3.6.2 Actions to Maintain Certification V-III-9-5

9.3.6.3 Authorization for Manned Use Following a Sustaining Survey..... V-III-9-6

9.3.7 Continuation of Certification V-III-9-6

CHAPTER 10 - QUALITY ASSURANCE RECORDS

10.1 Purpose V-III-10-1

10.2 Departure from Specification Record Retention..... V-III-10-1

10.3 User/Sustaining Activity Quality Assurance Record Retention..... V-III-10-1

10.3.1 Miscellaneous Records V-III-10-1

CHAPTER 11 - QUALITY ASSURANCE FORMS AND FORM INSTRUCTIONS

11.1 Purpose V-III-11-1

11.2 List of Forms V-III-11-1

VOLUME V
PART I
FOREWORD
QUALITY MAINTENANCE

LISTING OF APPENDICES.

- A List of Acronyms
- B Glossary of Terms

1.1 PURPOSE. To provide procedures and guidance to ensure, with a reasonable level of confidence, that work performed on or for Navy ships is accomplished with first time quality. Further, it is to give the sailors who serve on our ships the confidence that their equipment and systems will operate reliably and safely, in peace or when in harms way.

1.2 SCOPE.

- a. The guidance contained in this volume is applicable to every ship and activity of the fleet. The requirements are applicable to Ship's Force when performing maintenance on their own ship, to each Fleet Maintenance Activity (FMA) when performing work on tended ships, and to outside organizations (shipyards, contractors, Regional Maintenance Centers) performing work on ships. This volume does not currently apply to outside organizations (shipyards, contractors) when an availability is conducted in a depot facility and the contract specifies the use of other specifications.
- b. This volume is directive in nature and may be cited as authority for action as the need dictates. Where higher authority imposes more stringent requirements or conflicts exist with previously issued Fleet directives, such requirements shall have precedence. When such conflicts are identified, they should be reported immediately to the Fleet and Type Commanders (TYCOM).

1.3 MANUAL ORGANIZATION.

1.3.1 Basic Maintenance Principles. In order for repairs to be conducted reliably and with first time quality, several principles must be adhered to:

- a. The worker must have a process that guides him or her in the performance of maintenance (see Part 1 Chapter 2 of this volume).
- b. The worker must be trained so that work can be done safely and effectively (see Part I Chapter 3 of this volume).
- c. The worker must have the proper technical direction (see Part I Chapter 5 of this volume).
- d. The worker must have the proper material (see Part I Chapter 6 of this volume).
- e. For essential and critical systems, confidence must be established by appropriate testing (see Part I Chapter 7 of this volume).

1.3.2 Special Circumstances and Maintenance Support. In the course of conducting maintenance, special actions are required if technical requirements cannot be met. Other actions not directly related to conducting maintenance are required to support the conduct of maintenance. Other chapters in this volume discuss these:

- a. Resources (Organization) (see Part I Chapter 1 of this volume).
- b. Departure from Specification (DFS/Waivers/Nuclear Liaison Action Request) (see Part I Chapter 8 of this volume).
- c. Audits and surveillance (see Part I Chapter 9 of this volume).
- d. Retention of records (see Part I Chapter 10 of this volume).
- e. Blank reproducible forms and form instructions (see Part I Chapter 11 of this volume).

1.3.3 Order of Precedence. Guidance documents originate from a variety of sources. When a conflict exists, the following tables are provided to assist in determining precedence of the governing document on a case-by-case basis. However, the tables may not be exact for a particular case and may require adjudication by your Immediate Superior In Command. Equipment and material under the cognizance of Naval Sea Systems Command Nuclear Propulsion Directorate (NAVSEA 08) is maintained in accordance with NAVSEA 08 directives.

NOTE 1: TABLE 1 AND 2 ESTABLISH THE ORDER OF PRECEDENCE FOR OPERATIONS AND MAINTENANCE TECHNICAL DOCUMENTATION GUIDANCE.

NOTE 2: THE EXAMPLES PROVIDED IN THE TABLES ARE NOT LISTED IN ANY PARTICULAR ORDER OF PRECEDENCE.

1.3.3.1 Operations. Table 1 identifies guidance for aligning, starting, stopping and changing modes of operation of systems and equipment.

Table FWD-1 Operating Systems and Equipment

	Precedence	Examples
1	Operating Setting Advisories Issued Before October 2009	Operating Advisories (Fleet Advisories, Class Advisories). Gas Turbine Technical Directives (GTBs, AYBs, etc.)
2	Operating Procedures	Operating Sequence Systems (EOSS, CSOSS, AFOSS, etc.) Reactor Plant Manual, Steam Plant Manual, Steam & Electric Plant Manual, Ships System Manuals
3	Technical Manuals	Component Technical Manuals, NSTM, OEM Technical Manual
4	Directives	SORM, EDORM, NAVORDS
5	Instructions	NAVSEA Letters
6	Locally Generated OSS	In accordance with Operating Sequencing Systems (OSS) Users Guide

1.3.3.2 Maintenance and Technical. Table 2 identifies guidance used for preventive maintenance, troubleshooting, assessment, alignment, calibration, non-permanent changes and TEMPALTs.

Table FWD-2 Maintenance and Technical Documents

	Precedence	Examples
1	DFS/Requirement Setting Advisories Issued before October 2009	DFS/LAR-Waiver, Fleet Advisories, Class Advisories, Gas Turbine Technical Directives (GTBs, AYBs, etc.)
2	PMS	MRCs, PMRs, Steam Plant Manual, Steam & Electric Plant Manual, Maintenance Requirements
3	Requirements	JFMM, P9290, 7010, 0010, SSCB, FBW, CRL, CMP, DDGOS, GSO, URO-MRC, SOC Notebook
4	Drawings	NAVSHIP drawings, BUSHIP Drawings, NAVAIR Drawings TVDs, SYSCOM Approved Vendor Drawings, DDS Approved Drawings
5	Technical Manuals	Component Technical Manuals, NSTMs
6	Directives	SORM, EDOM, NAVORD, SYSCOM Technical Bulletins, Type Commander Technical Notes
7	Instructions	NWPs, SYSCOM Instructions
8	Maintenance Procedures	FWPs, CWPs, TWDs, UIPIs, PPIs, Maintenance Standards, Handbooks

The following abbreviations are used in the table above:

0010	SUBSAFE Manual
7010	Material Control Standard
AFOSS	Aviation Fuels Operational Sequencing System
AYB	Ancillary Equipment Bulletin
CMP	Class Maintenance Plan
CRL	Calibration Requirements List
CSOSS	Combat Systems Operational Sequencing System
CWP	Controlled Work Package
DDGOS	Deep Diving General Overhaul Specifications
DDS	Dry Deck Shelter
DFS	Departures From Specification
EDOM	Engineering Department Organizational Manual
EOSS	Engineering Operational Sequencing System
FBW	Fly-By-Wire
FWP	Formal Work Package
GSO	General Specifications for Overhaul
GTB	Gas Turbine Bulletins
JFMM	Joint Fleet Maintenance Manual
LAR	Liaison Action Requests
NAVORD	Naval Ordinance
NSTM	Naval Ships Technical Manual
NWPs	Naval Warfare Publications
OEM	Original Equipment Manufacturer
OSS	Operational Sequencing System
P9290	System Certification Procedures and Criteria Manual for Deep Submergence Systems
PMR	Planned Maintenance Requirements
PPI	Portsmouth Process Instruction
SOC	Scope of Certification
SORM	Ships Organization Requirements Manual
SSCB	SUBSAFE Certification Boundary Book
SYSCOM	System Command
TVD	Technical Variance Document
TWD	Technical Work Document
UIPI	Uniform Industrial Process Instruction
URO MRC	Unrestricted Operations Maintenance Requirement Card

1.3.4 Advisories. Commencing with Revision B CH-2, advisories (bulletins, class advisories, Fleet advisories, In-Service Engineering Activity advisories, etc.) will no longer be used to change or set requirements. Any change to requirements will be done by an appropriate document change form (e.g., Advance Change Notice (ACN)).

1.4 NEED FOR QUALITY MAINTENANCE PROCESSES.

- a. Quality maintenance processes play a vital role in the mission capability and personnel safety of many organizations. The three examples below demonstrate how actions, which seem small and insignificant can result in severe consequences. In all cases, if a strong and effective quality process had been in effect, the tragic results may have been averted.

- (1) On April 10, 1963, while engaged in a sea trials deep dive off the coast of Maine, a flooding casualty occurred in the engine room of the USS THRESHER (SSN 593). A piping failure in one of the salt water systems was subsequently determined to be the most likely cause for the loss of the ship and all personnel onboard. The comprehensive investigation, which followed, recommended numerous changes in the design and maintenance processes for submarines resulting in the Submarine Safety (SUBSAFE) Program, as we know it today.
 - (2) On January 28, 1986 the space shuttle Challenger was launched from Cape Canaveral Florida. Seventy-three seconds into flight, the spacecraft exploded and seven astronauts lost their lives. Subsequently, on June 6, 1986 a Presidential Commission concluded that the cause of the Challenger accident was the failure of the pressure seal in the aft field joint of the right solid rocket motor. Neither the National Aeronautics Space Administration nor the rocket engine builder developed a solution to the unexpected occurrences of O-ring erosion and blow-by, even though this problem was experienced frequently during shuttle flight history. The commission further concluded that a quality program would have tracked and discovered the reason for increasing erosion and blow by. Additionally, the commission found that the pressure to fly a launch schedule of 24 flights a year created pressure throughout the agency that directly contributed to unsafe launch operations. In short, the syndrome of “we’ve operated with that problem before and the risk is small” prevailed. The safety and technical requirements became secondary to operational commitments.
 - (3) On October 30, 1990, a major steam leak occurred in the fire room on board USS IWO JIMA (LPH 2) resulting in the deaths of ten watch standers. The investigation determined the cause to be failure of the bonnet fasteners of a ship service turbine generator root valve. The valve had just been repaired by a shipyard where the bonnet fasteners were replaced with mismatched and incorrect material. The required fasteners were heat-treated steel studs and nuts. The fasteners installed during the maintenance were a mixture of bolts, studs and black oxide coated brass nuts. The high temperature and pressure placed on the fasteners during plant light off caused the brass nuts to fail catastrophically, which allowed the valve bonnet assembly to separate from the body. The replacement fasteners were furnished by Ship’s Force, but no one (ship or shipyard) checked the fasteners, prior to installation, to ensure that the requirements of the technical manual and drawings were met.
- b. The above examples clearly demonstrate that, with the technical complexity of present day surface ships and submarines, the need for special administrative and technical controls necessary to ensure conformance to technical specifications during maintenance and testing is necessary. The necessity to perform the work correctly and in accordance with technical specifications is paramount in order to preclude loss of life or loss of a ship. The quality program was developed to assure maintenance of the modern day Fleet is performed in accordance with technical specifications, thus ensuring the highest state of material readiness.
 - c. The fundamental rule for all maintenance is that technical specifications must be met at all times. If for some reason the specified technical requirements cannot be met, acceptable alternatives must be approved by the appropriate authority and documented as a Departure from Specification or Liaison Action Request (LAR) prior to the continued operation of the ship.

1.5 CHANGES AND CORRECTIONS. Changes, corrections and updates to this volume will be made by the Fleet as required to maintain the volume current with higher authority technical requirements. When higher authority directives are issued which impose more stringent requirements, the Fleet will issue implementing instructions. Comments and suggestions for improving this volume are encouraged from all users. Address comments, recommendations and proposed changes to Submarine Maintenance Engineering, Planning and Procurement Activity using the manual change request form in the front of this volume. If changes are submitted in electronic format, faxed or E-mail, each change request shall contain the information required on the Change Request Form.

1.6 REQUEST FOR COPIES OF THE MANUAL. Activities on distribution for the Joint Fleet Maintenance Manual that require additional copies or activities wanting to be added to distribution should submit a letter to their applicable TYCOM, identifying CD-ROM/paper requirements along with justification for the request. To the maximum extent possible, technical publication libraries at each activity will receive all copies of the manual for that activity and coordinate local distribution and updates.

APPENDIX A
LIST OF ACRONYMS

ACCOMP	Aircraft Carrier Class Maintenance Plan
AEL	Allowance Equipage List
AIT	Alteration Installation Team
APL	Allowance Parts List
AQAO	Assistant Quality Assurance Officer
ASW	Auxiliary Sea Water
AWP	Availability Work Package
CA	Coordinating Activity
CAD	Certifying Activity Designator
CD ROM	Compact Disc Read Only Memory
CET	Carrier Engineering Team
CI	Critical Cleanliness Inspection
CMH	Controlled Material Handler
CMPO	Controlled Material Petty Officer
COSAL	Coordinated Shipboard Allowance List
CRA	Chemistry and Radiological Controls Assistant
CSB	Certification Signature Block
CSMP	Current Ship's Maintenance Project
CWP	Controlled Work Package
DDGOS	Deep Diving General Overhaul Specifications
DFS	Departure from Specification
DL	Deficiency Log
DMAC	Diagnostic and Maintenance Computers
DMP	Depot Modernization Period
DPMA	Docking Phased Maintenance Availability
DSS	Deep Submergence System
DSW	Diesel Sea Water
ECD	Estimated Completion Date
eDFS	Electronic Departure from Specification
EDSRA	Extended Docking Selected Restricted Availability
EHF	Electrical Hull Fitting
EMBT	Emergency Main Ballast Tank
EOH	Engineered Overhaul
ERO	Engineered Refueling Overhaul
ET	Eddy Current Testing
FBR	Feedback Report
FBW SCS	Fly-By-Wire Ship Control System
FMA	Fleet Maintenance Activity
FRC	Federal Records Center
FWP	Formal Work Package
GSO	General Specifications for Overhaul of Surface Ships
HFP	Horizontal Fixed Pipe
ICAR	Immediate Corrective Action Report
ID	Identification
ISEA	In-Service Engineering Activity

ISIC	Immediate Superior in Command
JCN	Job Control Number
JFMM	Joint Fleet Maintenance Manual
JID	Joint Identification Number
JSN	Job Sequence Number
LAR	Liaison Action Request
LI	Level I
LOEP	List of Effective Pages
LPO	Leading Petty Officer
LWC	Lead Work Center
MB	Megabyte
MCD	Material Control Division
MCR	Maintenance Certification Record
METCAL	Metrology and Calibration
MIC	Material Identification and Control
MIL-SPEC	Military Specification
MIL-STD	Military Standard
MOA	Memorandum of Agreement
MP	Maintenance Procedure
MRC	Maintenance Requirement Card
MS	Maintenance Standard
MSW	Main Sea Water
MT	Magnetic Particle Testing
NA or N/A	Not Applicable
NACE	National Association of Corrosion Engineers
NAVAIR	Naval Air Systems Command
NAVICP	Naval Inventory Control Point
NAVIMFAC	Naval Intermediate Maintenance Facility
NAVSEA	Naval Sea Systems Command
NAVSEA 08	NAVSEA Nuclear Propulsion Directorate
NAVSEALOGCEN	Naval Sea Logistics Center
NAVSUP	Naval Supply Systems Command
NAVSUP WSS	Naval Supply Weapon Systems Support
NDT	Nondestructive Test
NEC	Navy Enlisted Classification
NIIN	National Item Identification Number
NNPI	Naval Nuclear Propulsion Information
NPS	Nominal Pipe Size
NRO	Nuclear Repair Officer
NRP	Nuclear Repair Part
NSDSA	Naval Systems Data Support Activity
NSF	Nuclear Support Facility
NSN	National Stock Number
NSTM	Naval Ships' Technical Manual
OOP	Out Of Position
OPNAV	Naval Operations
OQE	Objective Quality Evidence
OSIC	On Site Installation Coordinator
P&E	Planning and Estimating
PLAD	Plain Language Address Directory

PMS	Planned Maintenance System
POC	Point Of Contact
PPEA	Propulsion Plant Engineering Activity
PQS	Personnel Qualification Standard
PSA	Post Shakedown Availability
PT	Liquid Penetrant Testing
PTS	Pressure Test Station
Q Point	Critical Quality Control Point
QA	Quality Assurance
QAI	Quality Assurance Inspector
QAL	Quality Assurance Lists
QAO	Quality Assurance Officer
QAS	Quality Assurance Supervisor
QC	Quality Control
QM	Quality Maintenance
Ra	Roughness Average
RADCON	Radiological Control
RCI	Reactor Plant Cleanliness Inspector/Certifier
REC	Re-Entry Control
RFI	Ready for Issue
RFOH	Refueling Overhaul
RISIC	Rubber Insert Sound Isolation Coupling
ROH	Regular or Refueling Overhaul
RPM	Reactor Plant Manual
RPPY	Reactor Plant Planning Yard
RPWAR	Reactor Plant Work Accomplishment Report
RT	Radiographic Testing
SAED	Submarine Antenna Engineering Directorate
SAQAM	Submarine Antenna Quality Assured Material
SCI	Steam Plant Cleanliness Inspector
SCS	Ship Control System
SEOC	Submarine Engineered Operating Cycle
SFCC	Submarine Flight Critical Component
SHCS	Socket Head Cap Screw
SHIPALT	Ship Alteration
SMIC	Special Material Identification Code
SOC	Scope of Certification
SPAR	Steam Plant Action Request
SPLI	Steam Plant Liaison Inquiries
SRA	Selected Restricted Availability
SUBSAFE	Submarine Safety
SUBMEPP	Submarine Maintenance Engineering Planning and Procurement Activity
SUPSHIP	Supervisor of Shipbuilding
SW	SEAWOLF Class Component
TDMIS	Technical Data Management Information System
TDU	Trash Disposal Unit
TFBR	Technical Feedback Report
TGI	Task Group Instruction
TM	Technical Manual
TMDE	Test, Measuring and Diagnostic Equipment
TMDER	Technical Manual Deficiency/Evaluation Report
TMMA	Technical Manual Maintenance Activity

TPD	Test Pressure Drawing
TPS	Test Pressure Station
TRF	Trident Refit Facility
TRS	Technical Repair Standard
TWD	Technical Work Document
TYCOM	Type Commander
UIC	Unit Identification Code
URO	Unrestricted Operations
UT	Ultrasonic Testing
VDD	Version Description Document
VFP	Vertical Fixed Pipe
VT	Visual Testing
VU	VIRGINIA Class Component
WC	Work Center
WCS	Work Center Supervisor

APPENDIX B
GLOSSARY OF TERMS

<u>TERM</u>	<u>DEFINITION</u>
Acceptance Trials	Trials and material inspections conducted underway by the INSURV Board for ships constructed in a private industrial activity to determine suitability for acceptance of a ship by the Navy.
Accepting Authority	The officer designated by the Chief of Naval Operations (CNO) to accept a vessel for the Navy, normally NAVSEA.
Acid Spot Test	See Generic Material Verification/Identification.
Alpha Trial	Builders Propulsion Trial; Acceptance Trial for SSN/SSBN/SSGN Propulsion Plant; Initial Tightness Dive (SSN/SSBN/SSGN); Dive to Maximum Authorized Depth (Selected SSN platforms).
Assist Work Center	The Work Center or group on board ship or at a repair activity with responsibility for accomplishment of a work/maintenance procedure as assist to or under direction of a Lead Work Center.
Audit	A detailed analysis and evaluation of records to determine compliance with existing requirements.
Backup Valve	A valve which, when closed, provides, in part or in whole, the secondary isolation boundary to sea pressure.
Boundary	The specific limits of the physical area involved in work and testing accomplished. That line, point or location identified as the border between controlled and uncontrolled areas. Depending on the type of system involved, it means the system component nearest to the work area which is operated to regulate or shut off the flow of fluid or deenergize electricity to the portion of the system which is being worked.
Bravo Trial	Normally the initial Dive to Test Depth; Noise Trial (SSN/SSBN/SSGN); Strategic Weapons System Missile Testing (SSBN); Weapons testing (Surface Combatants).
Builder's Trials	Evaluation trials and inspections conducted underway by the builder to assure the builder and the Navy that the ship is, or will be, ready for Acceptance Trials. These trials should be a comprehensive test of all ship's equipment and be similar in scope to Acceptance Trials. For nuclear powered surface ships this is the Acceptance Trial for the Nuclear Propulsion plant.
Calibration	The comparison of a measurement system or device of unverified accuracy to a measurement system or device of known and greater accuracy to detect and correct any variation from required performance specifications of the unverified measurement system or device.
Casting	A part formed by pouring molten metal into a mold.
Certification	To provide assurance, in writing, that the component or system conforms to the technical requirements.

Certification (Material)	The process of receipt inspection of material received from the Naval Supply System which establishes the correct level of essentiality and acceptability of the material in accordance with the appropriate specifications and material control standard.
Certified Oxygen Clean	Certified Oxygen Clean applies to material which is intended for or installed in shipboard oxygen generating, storage and distribution systems. The Naval Sea Systems Command (NAVSEA) source document which governs certification of oxygen cleanliness is MIL-STD-1330, Standard Practice for Precision Cleaning and Testing of Shipboard Oxygen, Helium, Helium-Oxygen, Nitrogen and Hydrogen Systems.
Certifying Activity	The activity, approved by Systems Command, that is qualified to complete all of the necessary certifying requirements of the particular specification or standard.
Change In Configuration	Ship's configuration is defined by drawings and drawing revisions specified in the Ship's Drawing Index and by equipment technical manuals applicable to equipment installed in the ship in accordance with these drawings. Changes which do not conform to these documents are a change in configuration. For example: <ul style="list-style-type: none">a. Material substitutions.b. Pipe joint additions or deletions.c. Significant rerouting or relocation of piping, cabling and equipment.d. Seal welding of normally mechanically sealed assemblies.e. Changes in piece dimensions.
Charlie Trial	Combat Systems and retesting (SSN/SSBN/SSGN); Acceptance Trials (DDG).
Cleanliness	<ul style="list-style-type: none">a. Reactor Plant - Minimum reactor plant cleanliness requirements according to NAVSEA 0989-064-3000; Cleanliness Requirements For Nuclear Propulsion Plant Maintenance and Construction.b. Steam Plant - Minimum steam plant cleanliness requirements according to NAVSEA 0989-064-3000.c. Commercial Cleanliness - A term that is used to describe the minimum level of cleanliness which should be maintained during work on propulsion plant systems and equipment not covered by NAVSEA 0989-064-3000. Commercial cleanliness is the absence of foreign material which could, if present, interfere with the function of these systems and components.d. Oxygen System - Minimum oxygen system cleanliness requirements according to MIL-STD-1330, Standard Practice for Precision Cleaning and Testing of Shipboard Oxygen, Helium, Helium-Oxygen, Nitrogen and Hydrogen Systems.
Cleanliness Inspector/Certifier	Individuals trained and qualified to perform cleanliness inspections required by work procedures for systems/components requiring cleanliness controls.

Coaming (Submarine)	The structure surrounding holes in, and extending through one or both sides of the pressure hull structure. They are usually connected by a corner or tee weld. They provide complete or partial strength compensation for the hole. Coamings are used for items like manholes. Hull valves generally use an insert.
Combined Trials	Combined Trials are a combination of an Acceptance Trial with a Final Contract Trial. The INSURV Board normally conducts Combined Trials for nuclear powered submarines.
Component	A self-contained combination of parts, subassemblies, or assemblies which performs a distinctive function in the overall operation of an equipment.
Component Drawing	A vendor, NAVSEA, or shipbuilder drawing which shows the assembly and details of a component such as a valve or pump. Sometimes it is divided into two drawings, one showing the assembly and the other the details. The component drawing list of material usually has a column entitled Material Identification and Control (MIC) level. It is this column on the list of material that is the source of information on whether a piece has a non-nuclear designation of Level I or Level NA (Not Applicable). A material designation does not normally appear on a component drawing list of material. It is shown instead on a Quality Assurance List (QAL). If a component drawing list of material has no MIC level column, then drawing notes should be reviewed to determine if one or more parts are Level I.
Continuity of Submarine Safety Certification	A status defined by those procedures, tests, and inspections required when hardware is renewed or replaced within the Submarine Material Certification Boundary, as well as the periodic checks or inspections required to assure continued satisfactory material condition for certification.
Controlled Assembly	<p>Process used for Re-Entry Control (REC) Exceptions or Exceptions to Retest Requirements for Mechanical Joints and consists of:</p> <ol style="list-style-type: none"> a. Verification that surface finishes of gasket/O-ring sealing surfaces are in accordance with applicable specifications. b. Verification that fastener material and installation is in accordance with applicable specifications. c. Verification that gaskets/O-rings are properly installed and in accordance with applicable specifications. d. Assembly is documented on a Quality Assurance (QA) form 34. e. Inspected by a Quality Assurance Inspector (QAI) or Quality Assurance Supervisor (QAS).
Controlled Dive	Conduct of a dive in incremental stages by a submarine to maximum authorized operating depth as measured to the keel to accomplish inspections of those joints and penetrations worked within certified boundaries and not tested prior to ship's underway.
Controlled Material	Any material which must be identified, verified and regulated throughout the manufacturing, installation or repair process in order to meet the specifications required of the end product. Controlled material is comprised of the following:

Controlled Material (Cont'd)	<p>a. Three special classes of material requiring NAVSEA/Naval Inventory Control Point mandated controls while held in the supply system and control and certification by the end user by use of the procedures in Part I, Chapter 6 of this volume:</p> <ol style="list-style-type: none">1. Non-Nuclear Level I.2. Submarine Flight Critical Component.3. Nuclear Level I. <p>b. Material which NAVSEA considers to be of sufficient criticality to warrant basic receipt inspection by the end user and segregated storage while in supply or a work center, but not necessarily the control and certification required by Part I, Chapter 6 of this volume:</p> <ol style="list-style-type: none">1. Naval Nuclear Propulsion Plant Material stocked with SMIC X1, X3 or X5 (instrumentation drawers, low chloride lagging).2. Non-Nuclear Materials stocked with SMIC SQ, CP, DG, QA, SP or VG.3. HY-80/100/130 plate.
Controlled Material Handler	An individual at the TRIDENT Refit Facilities who is qualified to perform the duties of a Controlled Material Petty Officer.
Controlled Material Petty Officer	An individual responsible for the receipt inspection and control of SUBSAFE, Level I, SAED, SAQAM, Project Target, Nuclear Level I and Scope of Certification materials after issue from the supply system.
Controlled Work Package	The records that provide the Objective Quality Evidence (OQE) necessary to certify that the completed maintenance was authorized, required tests were completed and work was certified. This consists of the Formal Work Package (FWP) and OQE.
Craftsman	A mechanic or other individual trained in QA methods and procedures (i.e., inspections, cleanliness, testing, documentation) to perform maintenance on ship's systems or components.
Deep Dive	The first dive to maximum operating depth. This depth will not necessarily coincide with the design test depth of the hull. See definition of Maximum Operating Depth.
Defect	An imperfection that impairs completeness or quality or does not meet required specification.
Delivery	The date the Navy accepts the ship from the ship builder. This requires a recommendation from the INSURV Board to accept/deliver the ship. Delivery of the ship is based on Acceptance Trials and satisfactory correction or resolution of deficiencies.
Departure From Specification	A lack of compliance with any authoritative document, plan, procedure, instruction, etc. See Part I, Chapter 8 of this volume for more information.

Detrimental Material	A material which, when contacting hardware, may have a deleterious effect on the hardware.
Deviation	Any non-conformance of a component or product with specified requirements.
Dock Trial	Dock Trials are those ship trials conducted at the Industrial Activity to determine the ability of the ship, from a material standpoint, to conduct Sea Trials safely.
Documentation	The records of OQE establishing the requisite quality of the material, component or work accomplished. Documentation should be traceable from the item to the records and be filed in an auditable manner.
Downgrading	The formal process used to decertify (removal of MIC mark(s), general identification marks, and in some cases demilitarize) controlled material for general use or disposal.
Electrode	A consumable filler metal which fuses during the welding process and becomes an integral part of the material or non-consumable electrode that fuses the metal during the welding process, but does not become an integral part of the material (e.g., tungsten).
Emergent Work	A task identified shortly before sensitive underway operations which, without extraordinary actions, cannot be completed without causing delay of the ship.
Face Feeding	The manual addition of brazing alloy at the intersection of the fitting face and the pipe. Supplemental face feeding is the addition of brazing material to increase fillet size.
Fast Cruise	A period immediately prior to underway trials during which Ship's Force operates the ship for dockside training. Fast Cruise shall, as far as is practical, simulate at-sea operating conditions.
Final Contract Trials	Trials that are conducted prior to the end of the guarantee period to determine if there are any defects, failures, or deterioration other than that due to normal wear and tear.
Fleet Introduction Team	A team of personnel assembled to support a pre-commissioning crew by monitoring progress of construction and coordinating training and facilities. They provide administrative support in all facets of new construction.
Fleet Maintenance Activity	FMA's include tenders, shore based maintenance activities (Regional Maintenance Centers, Naval Ship Repair Facilities, Naval Submarine Support Facilities, Naval Intermediate Maintenance Facilities (NAVIMFAC), TRIDENT Refit Facilities, Weapons Repair Facilities and other activities of that type) and supporting activities (port services, etc. that perform maintenance on Fleet assets).
Fly-By-Wire Ship Control System	A Ship Control System in which the controls are actuated by electrical impulses, as from a computer.
Foreign Material	Any material or object that should not be on or within clean hardware. Examples include, grit, chips, particles, oil, slag, scale, fibers, tape, tools, and loose articles.

Forging	Defined as a part formed by hammering or pressing a piece of heated metal to form a shape.
Formal Work Package	Written instructions, prepared in accordance with Part I, Chapter 2 of this volume for use in production and repair, delineating all the essential elements and guidance necessary to produce acceptable and reliable products.
Gas System Cleanliness Inspector/Certifier	Any person qualified under the requirements of this manual to perform the tasks of initial, in-process and final Cleanliness Certification Inspections for Gas systems.
Generic Material Verification/Identification	A broad identification of materials by simple, direct and rapid analysis methods or a combination of methods (e.g., Color, Magnetic Properties Test, Acid Spot Tests, Metal Comparator Tests). These tests are designed for simple screening and identification of materials by alloy family (as opposed to classification of specific alloys within a family).
Guarantee Material Inspection	A material inspection, conducted in port prior to Post Shakedown Availability (PSA) by a Trial Board prior to the end of the guarantee period when CNO has authorized a Combined Trial to determine if contractor responsible equipment has operated satisfactorily during the guarantee period. It shall include the opening and inspection of equipment designated by the Board together with the operation and visual inspection of equipment and the review of material maintenance records.
Guarantee Period (New Construction)	The period of time immediately following preliminary acceptance (delivery), normally eight or nine months (six months for nuclear powered ships), for which the industrial activity is responsible for the correction of deficiencies.
Guarantee Period (Post Shakedown Availability)	The guarantee period following PSA varies with the type of contract. Historically, a “cost plus” type contract has had a guarantee period of six months and a “fixed price” type contract a period of 90 days. The Supervising Authority will advise at the time of PSA the guarantee that applies.
Homogeneous Lot	<ul style="list-style-type: none"> a. Nuclear: A lot of material in which each piece is manufactured from the same heat, batch, or melt or has the same vendor traceability code number. b. Non-Nuclear: A group of like items that are produced in a common heat or batch or are produced under continuous cast or pour process with the same vendor traceability numbers, are of the same nominal size, and are received in a single shipment. For batch or continuous cast/pour processes, samples for chemical and mechanical properties shall be taken no less than once in every 8 hours of operation. If additional production processes are used that alter the mechanical properties of the material (e.g., heat-treat, cold or hot forge, extrusion), then all items of the same “Heat” number and additionally processed under the same conditions at the same time shall be considered as a homogeneous lot.
Hull Integrity Boundary	Pressure hull plating (shell plate), pipe, components, etc., NPS 1/2 inch and larger, from the inboard joint of the backup valve (or equivalent) outboard to the hull.

Hull Integrity Fasteners	Hull Integrity Fasteners (HF) are male threaded type items such as bolts, socket head capscrews, studs and bolt studs which are loaded by the differential sea pressure and internal hull pressure, and which are a part of pressure hull integrity components or of systems penetrating the Pressure Hull Structure, from the pressure hull to and including the inboard joint of the backup valve or its equivalent. Nuts and lock-washers are specifically excluded.
Hull Valve	A valve which, when closed, provides, in part or in whole, the first isolation boundary to sea pressure. The hull valve may also be referred to as the primary closure.
Immediate Superior In Command	<p>The ISIC is defined as follows:</p> <ul style="list-style-type: none"> a. For Submarines - The Squadron/Group. b. For Aircraft Carriers - The TYCOM. The TYCOM may designate a representative in carrying out certain Immediate Superior in Command functions. c. For Surface Forces - The Command holding administrative control.
Industrial Activity	The activity responsible for accomplishing construction or repair of ships whether private or public. This includes Naval shipyards, private shipyards, shipbuilders, vendors, Naval Aviation Depots, Naval Ship Repair Facilities, and other Naval Repair/Technical Activities (i.e., Naval Underwater Weapons Center, Naval Ships Weapons Center, etc.).
Initial Dive	For purposes of seawater valve and system testing, as defined in NAVSEAINST C9094.2, the first dive to a depth not previously reached during the trials.
Initial Tightness Dive	First submergence (a submarine's Alpha Trial).
In-Process Surveillance	The review of work in progress by personnel not directly involved with the work to assess such attributes as tagging and installation of controlled material, compliance with technical procedures, and recording of required data.
In-Service	Nuclear powered ships are assigned an active status of In-Service approximately two to four weeks (two to four months for aircraft carriers) prior to the commencement of Sea Trials and maintain this status until commissioning.
Inspection	A certification conducted by a separate individual qualified as an inspector (QAS, QAI, Cleanliness Certifier/Cleanliness Inspector, Nondestructive Test (NDT), Radiological Controls Monitor, Radiological Controls Shift Supervisor) on any system or component, which by its nature, is critical to the successful completion of the task.
Inspection Record	Record data showing the results of an inspection with appropriate identifying information as to the characteristics inspected and item inspected.

INSURV	Prior to the acceptance and delivery of a new ship, whether built by a private or naval industrial activity, all machinery, electronics and weapons systems installed shall be subjected to acceptance trials to determine that the installations are capable of meeting performance specifications. Depending upon your platform, these trials are referred to as either Acceptance Trials, Combined Trials or INSURV. This independent verification of the ship's readiness for acceptance and recommendation for fleet introduction is the responsibility of the President, Board of Inspection and Survey.
Leading Petty Officer/Work Center Supervisor	That person as defined by the appropriate Organization and Regulations Manual, responsible for ensuring the quality of work performed by his/her work center.
Lead Work Center	The Work Center or group on board ship or at a repair activity with prime responsibility for accomplishment of a work/maintenance procedure.
Level I	A designation for systems and components for which the Navy requires a high degree of assurance that chemical composition and mechanical properties of the installed materials meet the specified requirements.
Level of Essentiality	<p>A range of controls in two broad categories representing a high degree of confidence that procurement specifications for piping system components have been met. These categories are:</p> <ul style="list-style-type: none">a. Verification of material, which ensures that the manufacturer has complied with procurement requirements for chemical composition and physical properties of the material.b. Confirmation of satisfactory completion of tests and inspections required by the ordering data (e.g., Liquid Penetrant Testing (PT), dimensions, hydrostatic strength and porosity).
Liaison Action Request	A request for technical concurrence from Planning Yard or NAVSEA. Procedures for requesting information from the Reactor Plant Planning Yard are contained in Commissioned Submarine General Reactor Plant Overhaul and Repair Specification (NAVSEA 0989-LP-037-2000), Nuclear Support Facilities Overhaul and Repair Specification (NAVSEA 0989-LP-058-1000), Commissioned Surface Ship General Reactor Plant Overhaul and Repair Specification (NAVSEA 0989-043-0000) and TYCOM instructions. For non-nuclear systems and components, the LAR can be in any format which is convenient for the user, provided that it is identified as a LAR, clearly defines the exact information needed, lists the drawings in question, and states the date by which a reply is requested to support ship schedules. Volume II of the Fleet Modernization Program Management and Operations Manual contains a format for a non-nuclear LAR which FMAs may adapt for their use.
Loss of Traceability	A situation in which controlled material cannot be positively traced to the results of chemical and physical testing performed to prove that the material is that required by the specification to which it was made or bought. In each instance of loss of traceability, the FMA or ship Quality Assurance Officer must initiate action to restore traceability or use alternate, traceable material.

Maintenance Certification Record	The record (QA form 9) used to document the physical work boundaries, define the work involved, specify the material control and fabrication control procedures, specify inspection and test requirements, list the certification records involved, and provide approval and acceptance signatures and dates for work within the SUBSAFE boundary, a nuclear system or a Level I system or component.																
Maintenance Manager	Those persons, such as Port Engineers, Ship Superintendents, Ship's Coordinators, and Maintenance Planning Managers, assigned to assist Ship's Force in the tracking of work candidates, development of work packages, and tracking of FMA/Industrial Activities assigned jobs.																
Maintenance Requirement Card	Defines maintenance inspections and actions associated with the Planned Maintenance System (PMS).																
Maintenance Standard	(Submarines only) A document which specifies minimum technical requirements for acceptable refurbishment of submarine components, including inspection and testing criteria and parts replacement information, in accordance with NAVSEA maintenance plans.																
Major Repair	<p>Non-nuclear major repairs are those repairs which:</p> <ol style="list-style-type: none"> a. Structurally affect the pressure-containing portion of a piping system or component through welding (except as defined under Minor Repair), brazing or other fabrication process, including new mechanical joints in which a flange or union tailpiece is replaced using a weld or braze. b. Involve installation of new pressure boundary parts or components which have not been previously strength tested. 																
Mapping Drawing	<p>A diagrammatic drawing, verified by ship check, that identifies and specifies the location of elements which must meet a SUBSAFE requirement of NAVSEA 0924-062-0010, SUBSAFE Requirements Manual. Pipe joints, flexible connections and castings are examples of items identified on the mapping drawing. Pipe joints are each numbered (e.g., MSW-56178) and the type of joint identified (e.g., WB - butt weld). The mapping drawing will also reference a QAL as applicable. Mapping drawings are discussed in the introductions of the SUBSAFE Certification Boundary Book. Most of the symbols seen on a mapping drawing are:</p> <table border="0" style="width: 100%;"> <tr> <td>BF - Brazed joint, face fed</td> <td>SL - Seal</td> </tr> <tr> <td>BP - Brazed joint, pre-inserted ring</td> <td>U - Threaded pipe union</td> </tr> <tr> <td>CN - Casting</td> <td>WA - Welded attachment</td> </tr> <tr> <td>F or FG - Flange</td> <td>WB - Butt weld</td> </tr> <tr> <td>FH - Flexible connection</td> <td>WF - Fillet weld</td> </tr> <tr> <td>HF - Hull Integrity Fastener</td> <td>WL - Seal weld</td> </tr> <tr> <td>IN - Pressure hull insert</td> <td>WM - Bimetallic weld</td> </tr> <tr> <td>PE - Penetration</td> <td>WN - Welded nozzle</td> </tr> </table>	BF - Brazed joint, face fed	SL - Seal	BP - Brazed joint, pre-inserted ring	U - Threaded pipe union	CN - Casting	WA - Welded attachment	F or FG - Flange	WB - Butt weld	FH - Flexible connection	WF - Fillet weld	HF - Hull Integrity Fastener	WL - Seal weld	IN - Pressure hull insert	WM - Bimetallic weld	PE - Penetration	WN - Welded nozzle
BF - Brazed joint, face fed	SL - Seal																
BP - Brazed joint, pre-inserted ring	U - Threaded pipe union																
CN - Casting	WA - Welded attachment																
F or FG - Flange	WB - Butt weld																
FH - Flexible connection	WF - Fillet weld																
HF - Hull Integrity Fastener	WL - Seal weld																
IN - Pressure hull insert	WM - Bimetallic weld																
PE - Penetration	WN - Welded nozzle																

Mapping Drawing (Cont'd)	<p>PF - Pressure hull fitting</p> <p>WR - Root connection (or boss)</p> <p>PM - Pressure hull penetrating mast</p> <p>WS - Socket weld</p>
Material Identification and Control Number/Marking	A unique number assigned to certified material by the Certifying Activity (for material) which provides traceability to OQE in accordance with the applicable Material Control Standard.
Maximum Operating Depth (Also Maximum Authorized Operating Depth)	The depth to the keel for a particular submarine which is authorized by Commander Submarine Forces Atlantic/Commander Submarine Forces Pacific upon the recommendation of NAVSEA, as the depth not to be exceeded in operations. This depth is normally the Test Depth but may be reduced in specific cases. The depth authorized may be less than, but in no case exceed, the depth recommended by NAVSEA.
Minor Repair	Minor repairs are operations that could be considered maintenance such as replacing packing and pressure seal ring, lubricating, lapping or grinding of seats, and replacing damaged parts such as stems and discs. For the purpose of this manual the definition in Naval Ships' Technical Manual Chapter 505 or NAVSEA S9074-AR-GIB-010/278, whichever is applicable, is used for the term "Minor" repair.
Moderate Speed	The range of speed that allows the submarine optimum recovery (as shown on applicable submerged operating envelope curves) if loss of stern plane control and/or flooding occurs. Normally 8-15 knots.
Naval Supervisory Authority/Supervisory Authority	The officer designated to represent the Navy Department at an industrial activity; normally a Supervisor of Shipbuilding (new construction), Regional Maintenance Center (Conversion and Repair) or the Commander of a Naval Shipyard.
New Mechanical Joint	A joint where either a flange or union is replaced. A new mechanical joint is a major repair and requires a hydrostatic test to the specific requirements of a particular system.
Nominal Operating Pressure	The approximate pressure at which an essentially constant pressure system operates when performing its normal function. This pressure is used for the system basic pressure identification.
Nondestructive Testing	<p>All methods of testing used to detect or measure the significant properties or performance capabilities or material, parts, assemblies, equipment, or structures which do not impair the service ability of the parts tested. These tests include:</p> <ol style="list-style-type: none"> a. Radiographic Testing (RT). b. Magnetic Particle Testing (MT). c. Liquid Penetrant Testing (PT). d. Ultrasonic Testing (UT). e. Visual Testing (VT). f. Eddy Current Testing (ET).

Nondestructive Testing (NDT) Supervisor	The NDT Supervisor is the individual designated by the respective Division Officer and is qualified in specific methods for which he is designated NDT Supervisor. (There may be more than one NDT Supervisor in an organization.)
Nuclear Regional Maintenance Department (NRMD)	NRMD performs intermediate level nuclear maintenance and repair work, consolidating efforts in a regional area, thus eliminating duplication of infrastructure and maximizing effective use of funds. This is accomplished by the use of military personnel integrated into the experienced nuclear production, radiological and engineering resources of the parent shipyard. NRMDs are an expansion of their parent shipyard.
Objective Quality Evidence	<p>Any statement of fact, either quantitative or qualitative, pertaining to the quality of a product or service based on observations, measurements, or tests which can be verified. (Evidence will be expressed in terms of specific quality requirements or characteristics. These characteristics are identified in drawings, specifications, and other documents which describe the item, process, or procedure).</p> <ul style="list-style-type: none"> a. Tests can be based on heat, batch, continuous cast or pour, or other manufacturing processes, providing the manufacturer can prove the test sample was representative of the material supplied. b. Material supplied will bear a unique traceability marking and report of supporting test quantitative data will bear an identical marking.
Oxygen Clean Inspector	A Cleanliness Inspector/Cleanliness Certifier qualified by the Oxygen Clean Instructor and certified by the Department Head or Commanding Officer to perform cleanliness inspections on systems under the requirements of MIL-STD-1330.
Oxygen Clean Instructor	An individual certified by his/her Commanding Officer to train and qualify personnel in the procedures and requirements of MIL-STD-1330.
Oxygen Clean Worker	An individual qualified by the Oxygen Clean Instructor and certified by the Department Head to perform maintenance on systems under the requirements of MIL-STD-1330.
Planning Yard	<p>The Naval Shipyard or other activity designated by NAVSEA to perform the following tasks pertaining to specifically assigned ships:</p> <ul style="list-style-type: none"> a. To provide, and/or coordinate the provision of technical and other services in design matters. b. To be responsible for the availability of a complete up-to-date file of working drawings, Selected Record Drawings, and Data. c. To provide a central repository, reproduction, and distribution services, or to coordinate such services, for working drawings, Selected Record Drawings, and Data. d. To provide these services to the fullest extent possible within the limits of the funds provided.
Positive Material Identification	Process by which the craftsman ensures that the material to be or being installed is the correct material as specified by the plan, technical manual, etc. This process is also referred to as "Positive Material Identification and Verification".

Post Shakedown Availability	An industrial activity availability following Final Contract Trials/Guarantee Material Inspection assigned to correct deficiencies found during the shakedown period or to accomplish other authorized improvements.
Pressure Boundary Part	An item which separates an internal fluid from the atmosphere (or another fluid at reduced pressure) or which joins two other pressure boundary parts.
Pressure Hull Fittings	All items and assemblies which penetrate the hull integrity boundary and are attached either mechanically or by welds to penetrations, inserts or plating. This includes structural, piping, mechanical and electrical pressure hull fittings and mechanical stuffing boxes; specifically excluded are all cables, O-Rings, V type packing or packing around mechanical shafts.
Procedure	Written instruction designed for use in production and repair, delineating all the essential elements and providing guidance necessary to produce acceptable and reliable products. The term "procedure" includes PMS Maintenance Requirement Card (MRC), technical manuals, reactor plant manuals, standard operating procedures, ship's instructions, etc.
Product Quality Deficiency Reporting	A method for reporting deficiencies in new or newly reworked material which may be attributable with contractual or specification requirements or substandard workmanship performed by depots, naval shipyards, contractors or subcontractors.
Q-Point	Critical Quality Control Point. A work process, regardless of type (maintenance, training, administrative, etc.), whose proper accomplishment overwhelmingly affects the ultimate first time quality success of the process.
Quality Assurance	A systematic review of Quality Maintenance records and all production actions which will provide adequate proof and confidence that work performed or material manufactured will perform as designed and that there is documentary evidence to this effect.
Quality Assurance Inspector	The designated individual(s) in FMA and ship work centers who inspect the work of other individuals, not their own work. Certified as qualified by the Commanding Officer or Repair Officer.
Quality Assurance List	(Submarines only) QAL on NAVSEA Drawings specify NDT requirements for items scheduled for installation within the SUBSAFE boundary during new construction. The QALs should only be utilized for guidance subsequent to ships' commissionings, since they will not necessarily reflect current NDT requirements.
Quality Assurance Officer	An individual assigned the responsibility for the organization, administration, training and execution of the QA Program.
Quality Assurance Supervisor/Specialists	Personnel assigned to the FMA Quality Assurance Officer to assist in implementing the QA Program. QASs are certified as qualified by the FMA Commanding Officer. A Quality Assurance Specialist is an individual at the TRIDENT Refit Facilities who is qualified to perform the duties of a QAS.
Quality Control	On the job supervision, management and inspection which identifies and ensures proper workmanship and/or materials are being produced.
Reactor Plant Cleanliness Inspector/Certifier	Any person qualified under the requirements of the manual to perform the tasks of initial, in-process and final Cleanliness Certification Inspections for Reactor Plant Systems.

Reactor Plant Work Accomplishment Report	A report submitted to the Reactor Plant Planning Yard by ships, FMAs and shipyards which certifies work accomplished by them on reactor plant hull integrity areas. These areas, identified on the ship specific Reactor Plant Work Accomplishment Report, are nuclear and are usually within the SUBSAFE boundary.
Re-Entry	Includes any and all work and testing in a SUBSAFE certified system including penetration of the pressure hull from the first breaching through final grooming, testing and return to final operation, (e.g., breaking a mechanical flange, a sil-braze, or welded joint, removal of a valve bonnet, repacking a gland).
Re-Entry Control	The controls used to document the re-entry and re-certification of SUBSAFE systems or components. The QA form 9 (Maintenance Certification Record) is used to document the acceptance of a completed SUBSAFE system Re-entry.
Reinstall	To use or install the previously installed item/component.
Re-Made Mechanical Joint	A flange or union joint which has been reassembled using existing or new threaded fasteners on which no brazing or welding was accomplished on the joint parts during the repair or modification process.
Repair	Refurbishment other than mere disassembly and/or cleaning.
Replace	To install a new item or component.
Rework	The unplanned repetition of a step or a series of steps in a Formal Work Package.
Sample	One or more units of a product selected at random from the material or process represented.
Selected Record Data	Tables, charts, drawing indices, allowance lists, damage control books and other data (excluding drawings) specifically selected for their reference value and maintained current throughout the life of the ship.
Selected Record Drawing	A designated group of drawings made applicable to an individual ship by illustrating final shipboard installations of important features, systems and arrangements that must be maintained up to date and correct throughout the life of the ship.
Ship	Any submarine, surface ship, tender, or other vessel assigned to the Fleet.
Ship's Drawing Index	A list of drawings, normally on microfiche, or Compact Disc Read Only Memory (CD ROM) which applies to each ship. It lists ship construction drawings, ship modification drawings and manufacturer (vendor) component drawings. It is here that system diagrams, mapping drawings and in some cases, QALs are identified by drawing title or by a code in a column after the drawing title and number.
Small Item	Items that have a marking surface less than 3/8 of a square inch area.
Software	Gaskets, packing and seals used in mechanical flange or union joints in piping systems.

Special Cleanliness	A requirement for components used in oxygen and nitrogen systems to prevent combustion of contaminants and maintain purity of the gas. The cleaning requirements are discussed in Naval Ships' Technical Manual Chapter 550, Industrial Gases: Generating, Handling and Storage.
Special Material Identification Code	<p>A two-digit letter or number code at the end of the National Stock Number or Navy Item Control Number to provide visibility to designated items to ensure maintenance of their technical integrity. The following SMICs from Appendix C of SPCCINST 4441.170 or Appendix B of SPCCINST 4441.176 are for material commonly used in the Fleet.</p> <p>CP An item that requires special cleaning and packaging for oxygen/nitrogen service (e.g., valves, piping system, generators).</p> <p>C1 An item that requires special cleaning and packaging for oxygen/nitrogen service (e.g., valves, piping system, generators) which also must meet the requirements of Level I.</p> <p>DG An item that requires special cleaning and packaging for oxygen/hydrogen service (e.g., valves, piping system, generators).</p> <p>D1 An item that requires special cleaning and packaging for oxygen/hydrogen service (e.g., valves, piping system, generators) which also must meet the requirements of Level I.</p> <p>LI (Level I) An item that supports either a SUBSAFE or Level I system that has undergone the extreme material control/QA techniques that provide OQE of its acceptance for its appropriate application. Each item has certification papers (or special markings that provide traceability to the certification) that pedigree its material and physical properties, provide traceability to manufacturer, contract list and lot, and document the QA system/test requirements applied to the item.</p> <p>NT Annular ball bearings for quiet operation applicable to submarine usage (noise tested bearings).</p> <p>QA Equipment and/or parts requiring special material control and QA which supports surface ship or submarine applications.</p> <p>Q3 Items that support a Level I or SUBSAFE critical component/system that has undergone QA during the acquisition process (e.g., a ball and seat assembly utilized in a Level I or SUBSAFE ball valve based on ship system application). This, however, does not include Trash Disposal Unit, Signal Ejector, Salvage Air, and open ended applications which are procured as Level I or SUBSAFE. "Q3" SMIC invokes chemical and mechanical certifications traceable to the heat code permanently marked on the material. It should be noted that "Q3" SMIC coded material is not receipt inspected or MIC marked by the receipt inspection activities.</p>

Special Material
Identification Code
(Cont'd)

- SP An item which is unique to the Navy Strategic Systems Program Office controlled fleet ballistic missile weapon system. The SMIC SP establishes a weapons system relationship but does not signify the technical considerations as described in definition X2, X3 and LI.
- SQ SAQAM, which is administered by the SAED of the Naval Ship System Engineering Station, Mechanicsburg Detachment. It includes whole components and repair parts.
- SW SEAWOLF Class Ship Control System approved Ships Flight Critical Components.
- S1 An item which is unique to surface ship applications which also meets the requirements of Level I.
- TR TRIDENT Ship's Program.
- VG Equipment and/or parts requiring special material control and QA which support surface ship or submarine applications. Special cleaning and packaging for oxygen/hydrogen service is required.
- VU VIRGINIA Class Ship Control System approved Ships Flight Critical Components.
- X1 NAVSEA Nuclear Propulsion Directorate (08) controlled material identified as "2S" cognizance material with an "X1" SMIC.
- X2 Naval Reactor Plant material which is specially designed, manufactured and/or treated for use in a Naval Reactor Plant. In addition, this material is inspected (or sample inspected) by a Naval shipyard prior to being placed in Navy Supply System Stock.
- X3 Naval Reactor Plant material specially designed, manufactured and/or treated for use in a Naval Reactor Plant.
- X4 Naval Reactor Plant valves and auxiliary equipment used in secondary Nuclear Level I applications which are technically receipt inspected and certified as ready for use by a receipt inspection activity.
- X5 Naval Reactor Plant component level items not qualifying for X1, X2, X4 or X6 SMIC assignment. This material is not inspected by a Naval shipyard prior to being placed in Naval Supply Stock and will not have a Ready-For-Issue tag attached.

Special Material Identification Code (Cont'd)	X6 Naval Reactor Plant items specifically designed, manufactured and/or treated for use in Level I Naval Reactor Plant applications. All Level I items which do not qualify for SMIC X1, X2 or X4 assignment are assigned SMIC X6. Since the outer packaging of material received from the Naval Supply System may not be marked with an X6 SMIC, end users should consult applicable logistics information (e.g., the Q Coordinated Shipboard Allowance List, FEDLOG, Haystack, etc.) to determine the current applicable SMIC assignment. If an X6 SMIC is currently assigned in any of the applicable logistics information, the material is considered pre-certified Level I material and does not require a Ready-For-Issue tag.
Specification	Any directive, whether technical or administrative, in any format, such as instruction, technical manual, drawing, standard or publication.
Steam Plant Cleanliness Inspector/Certifier	Any person qualified under the requirements of this manual to perform the tasks of initial, in-process and final Cleanliness Certification Inspections for Steam Plant Systems.
Submarine Antenna Engineering Directorate - Submarine Antenna Quality Assured Material	Submarine antenna material which is quality assured by the SAED, (formerly the Submarine Antenna Quality Assurance Division) and marked/recorded to ensure proper documentation and traceability
Submarine Safety Certification	Investigative effort and corrective action developed under the certification requirements for safety of submarine operations which has as its specific aim an order of magnitude increase in the safety of submarine operations. Accomplishment provides reasonable assurance that the integrity of defined critical systems and components, and the casualty recovery capabilities are adequate to permit unrestricted operations to test depth.
SUBSAFE	The acronym for Submarine Safety which applies to all submarine classes. The SUBSAFE program provides a high level of confidence in the material condition of the hull integrity boundary and in the ability of submarines to recover from flooding and control surface (e.g., bow, rudder, stern plane) casualties.
SUBSAFE Attribute	Test and inspection requirements for SUBSAFE systems and components.
SUBSAFE Certification	That area within which the requirements of the SUBSAFE Requirements Manual apply. It includes those inboard piping and mechanical systems maintaining watertight integrity and recovery capability from a flooding casualty.
SUBSAFE Certification Boundary Book	A book presenting simplified diagrams or sketches which show the hull non-nuclear integrity and certified system boundaries for a specific submarine, class of submarine or group of submarines within a class.
SUBSAFE System	A submarine system or component designed, installed and maintained to: <ol style="list-style-type: none"> a. Prevent flooding of the submarine (e.g., failure would cause flooding of ship). b. Enhance recovery in the event of flooding (e.g., flood control). c. Ensure reliable submerged ship control (e.g., certain parts of the steering and diving system).

SUBSAFE System (Cont'd)	d. SUBSAFE systems are shown in the SUBSAFE Certification Boundary Book.
Surveillance	Observations and analysis of actual work procedures and methods to verify compliance with technical requirements.
System	All components, piping, fittings, including electrical and mechanical items, which together form and contribute to the operation of an integrated functional arrangement. The "system" as used in this manual is not limited to piping only unless "piping" is specified. Any part which receives the fluid, controls, or is controlled by the fluid is included.
System Design Pressure (Non-Nuclear)	System design pressure is the pressure used in the calculation of piping and piping components minimum wall thickness and will not be less than the maximum system pressure (for general guidance, design pressure may be estimated within 2 to 3% by multiplying maximum operating pressure by 112%).
Target Material or Project Target Material	As defined in NAVSEA S9213-45-MAN-000 and SPCCINST 4440.376. All material issued with a "Project Target Ready-For-Issue" tag for use as Nuclear Level I is either X1, X2 or X4 SMIC coded.
Technical Data	Recorded information (regardless of the form or method of recording) of a scientific or technical nature (including computer databases and computer software documentation). This term does not include computer software or financial, administrative, cost or pricing, or management data or other information incidental to contract administration. The term includes recorded information of a scientific or technical nature that is included in computer databases. For these purposes, technical data includes the characteristic of a particular science, trade or profession.
Technical Repair Standard	See Maintenance Standard. Document which provides minimum requirements for the acceptable repair and refurbishment of submarine equipment and components and identifies planned and contingency material necessary to ensure satisfactory operation until the next planned maintenance action.
Technical Variance Documentation	Technical Variance Documentation is documentation used to document configuration changes made during an overhaul or refit that influence a maintenance, alteration and repair, but will not be incorporated in a revision to a drawing as accomplished on the ship (SSN 688 Class, SSBN/SSGN 726 Class, and S5W Reactor Plant).
Technical Work Document	The work procedure that will provide the craftsman with clear, concise and technically correct instructions to complete the maintenance task while conforming to technical specifications. Technical Work Documents consist of three general types: Maintenance Procedures, Formal Work Packages and Controlled Work Packages.
Test Depth	For the purpose of the proper method of measuring and specifying Test Depth, the following applies: Test Depth shall be measured to the bottom of the keel for all types of submarine operations. Builders trials and trials following major industrial activity availabilities greater than six months, shall be at a tolerance of plus zero (0), minus twenty (20) feet of Test Depth when specified. All other trials can be conducted at 95% to 100% of Test Depth to satisfy all the requirements specified for 100% Test Depth.

Test-Drop	A pressure test used to determine the integrity of a system. It is performed upon satisfactory completion of the strength and porosity hydrostatic test and is accomplished by pressurizing the system to its system working pressure while it is arranged for normal operation. Pressure is applied using either air or an inert gas as applicable. The test is held and monitored for a specified period of time and the system tightness is determined by correcting the pressure drop for temperature change.
Test Equipment/Working Level Instruments	For purposes of this manual, test equipment will be interpreted as comprising all general purpose equipment (standard measuring instruments), special testing equipment, including such classes as checkout equipment, acceptance equipment, inspection equipment, gauges and associated accessories.
Test-Hydrostatic	A test where the system or a portion of the system is filled with fluid and pressurized above normal operating pressure to a specified hydrostatic test pressure and inspected for leaks and visible permanent deformation.
Test-Joint Completion	See Test-Mechanical Joint Tightness.
Test-Mechanical Joint Tightness	A pressure test where a portion of a system or the entire system is pressurized to its system nominal operating pressure or “J” test pressure to determine leak tightness after closing a mechanical joint where leak tightness is obtained by gaskets, seal welding or threads.
Test-Operational	(Non-Nuclear) <ul style="list-style-type: none"> a. A test of a system to nominal operating pressure using the system fluid, pumps and installed system gages vice test instrumentation to determine leak tightness; and/or b. A test of a system to assure that all items, components, controls and indications function as designed and in accordance with specifications.
Test-Pneumatic	A test where a portion of the system or the entire system is pressurized with gas and inspected for leaks.
Test Pressure Drawing	Drawings which have been developed from system diagrams for classes of submarines and contain strength and mechanical joint tightness pressures for all portions of piping systems. These pressures are displayed in “indicators” which contain two test pressure values as illustrated in the Submarine Non-Nuclear Piping Systems Test Manual, NAVSEA S9505-AF-MMA-010/PIPING SYSTEMS.
Test-Shop	A test performed on a section of piping or a system by an FMA work center when the subassembly piping or component is not installed in an onboard system.
Test-Soap	A method of determining the tightness of a system by applying a soap and water solution to the system joints while the system is being either pressure or vacuum tested. The test is held a sufficient length of time to permit a thorough examination for leaks. When vacuum testing the leak, the testing solution should be compatible with the system to preclude contamination and will be specified on the applicable Test Pressure Drawings.
Test-Strength and Porosity	A hydrostatic test conducted at a specified strength test or “H” pressure that is above nominal/system operating pressure.

Torque	<p>The twisting force exerted multiplied by the distance through which the force acts. In the Navy, torque is usually measured in foot-pounds or inch-pounds.</p> <ol style="list-style-type: none"> a. Breakaway Torque. The torque required to start the self-locking fastener moving when the locking element is fully engaged and with no axial load. b. Final Torque. The required torque plus the running torque, when a self-locking fastener is being used. c. Required Torque. The torque in accordance with the design drawing or technical manual requirements, the torque from appropriate torque tables in Submarine Fastening Criteria (Non-Nuclear), Description, Design, and Maintenance, NAVSEA S9505-AM-GYD-010 or the torque in accordance with an applicable approved process instruction. d. Running Torque. The torque required to continue turning a self-locking fastener prior to contact with the seating surface.
Traceability	<p>A positive capability of finding all objective evidence, including receipt inspection data, for a particular piece of material given only the piece of material, marked in accordance with applicable material control standards.</p>
Unrestricted Operation Maintenance Requirement Card	<p>Unrestricted Operations Maintenance Requirement Card for continued unrestricted submarine operations to design test depth. Refer to the SUBSAFE Requirements Manual, NAVSEA 0924-062-0010.</p>
Upgrading	<p>The process of conducting the certification of open-purchased material to controlled material in accordance with the appropriate military and material control standard.</p>
Valve Repair/Restoration/Overhaul	<ol style="list-style-type: none"> a. Repair. Any work done to improve the material condition or operation of the valve correcting deficient conditions such that the component may be returned to service, but which, in total does not meet the full intent of the applicable restoration/overhaul technical standard, is considered a repair. b. Restoration/Overhaul. All valve parts replaced or restored to the requirements of the applicable technical standard (e.g., the full intent of the restoration/overhaul technical standard is invoked).
Verification	<p>Certification required to be performed by the craftsman.</p>
Waterline	<p>The term “waterline” in this manual refers to where the hull of a ship meets the surface of water when afloat.</p>
Welded Fabrication or Weldment	<p>The construction, alteration or repair of any welded assembly, or parts thereof, by welding and allied processes. Included are all operations such as pre-heat and post-heat treatments, forming, fairing and NDT that must be controlled to obtain weldments suitable for intended service.</p>
Work	<ol style="list-style-type: none"> a. Any action that actually or potentially changes (including disassembly for the purposes of inspection or repair) the approved configuration of any part, component or ship’s system. b. Any action that removes or affects the ship’s ability to operate ship’s systems or components in accordance with ship’s systems/operating manuals or reactor plant manuals.

c. Any testing or inspections required to establish, maintain or reestablish certification.

Work (Cont'd)

d. Any design, engineering, planning or configuration management functions that involve the final review and/or approval of technical information.

Examples of work include the following:

1. Action which disassembles or removes any part, component or ship's system.
2. Action specified in a Technical Work Document.
3. Any action that removes or affects the ship's ability to operate ship's systems or components in accordance with ship's systems manuals, operating manuals or reactor plant manuals, excluding tagout in accordance with the Tagout Users Manual, including but not limited to:
 - (a) Component or system tests.
 - (b) Intrusive inspections (such as breaking the plane of electrical panels requiring electrical safety).
 - (c) Valve line ups that alter the normal system line up not governed by operating procedures.
 - (d) Removing valve hand wheels, disconnecting of reach rods.

Work Center

For FMAs, the individual shops within divisions of the Repair, Weapons Repair Departments, etc. (e.g., 38A, 91A, 72A, 25A). For ships, usually the divisions within a department (e.g., Machinery Division, Sonar Division).

Working Standards
(Calibration)

These standards comprise a wide variety of equipment used throughout the laboratory in support of all measurements performed in the laboratory. These standards are used day-by-day in performing calibrations in the Fleet Electronic Calibration Laboratory or Mechanical Instrument Repair and Calibration Shop. Contrast, reference and transfer standards are used less frequently to support and assure the accuracy of working standards within the Fleet Electronic Calibration Laboratory, Mechanical Instrument Repair and Calibration Shop, Fleet Meter Calibration Laboratory or Field Calibration Activity.

VOLUME V
PART I
CHAPTER 1
ORGANIZATIONAL RESPONSIBILITIES

REFERENCES.

- (a) NAVSEA T9044-AD-MAN-010 - Requirements Manual for Submarine Fly-By-Wire Ship Control Systems
- (b) COMSUBLANT/COMSUBPACINST 3502.1 - Submarine Force Internal Monitoring and Critiques
- (c) NAVSEA SS800-AG-MAN-010/P-9290 - System Certification Procedures and Criteria Manual for Deep Submergence Systems
- (d) NAVEDTRA 43523 - Personnel Qualification Standard for Quality Maintenance Program
- (e) NAVSEAINST 4790.23 - Baseline Project Management Plan (BPMP)
- (f) COMSUBFORINST C5400.30 - Engineering Department Organization Manual
- (g) NAVSEA 0948-LP-045-7010 - Material Control Standard
- (h) NAVSEA S9086-CH-STM-020 - NSTM Chapter 074 V2 (Nondestructive Testing of Metals Qualification and Certification Requirements for Naval Personnel (Non-nuclear))
- (i) NAVSEA T9074-AS-GIB-010/271 - Requirements for Nondestructive Testing Methods
- (j) SECNAVINST 4855.3 - Product Data Reporting and Evaluation Program (PDREP)
- (k) NAVSEA S9074-AQ-GIB-010/248 - Welding and Brazing Procedures and Performance Qualification
- (l) NAVSEA 0924-062-0010 - Submarine Safety (SUBSAFE) Requirements Manual
- (m) NAVSEANOTE 5000 - Activities Authorized to Perform SUBSAFE, FBW-SCS and DSS-SOC Work
- (n) CNRMCIINST 4700.3 - Unplanned Events, Critiques and Trouble Reports
- (o) OPNAVINST 4790.15 - Aircraft Launch and Recovery Equipment Maintenance Program (ALREMP)

LISTING OF APPENDICES.

- A Format for Submarine QA Pre-Underway Checklist

1.1 **PURPOSE.** To provide a list of responsibilities and duties of key personnel within the organizations that are involved in the Fleet Quality Assurance (QA) Program. Responsibilities and/or duties listed in this section are further amplified in other sections of this volume.

1.1.1 **Quality Assurance Organization.** The QA Program for the Fleet is organized into five levels of responsibility:

- a. Fleet.
- b. Type Commander (TYCOM).
- c. Immediate Superior in Command (ISIC).
- d. Ship Commanding Officer/Officer in Charge.
- e. Regional Maintenance Center (RMC) Commander/Fleet Maintenance Activity (FMA) Commanding Officer.

1.2 **FLEET RESPONSIBILITIES.**

1.2.1 **Fleet Commander (Fleet).** The Fleet is responsible to provide policy and direction for the implementation and operation of the QA program as follows:

- a. Promulgate the QA program through the guidelines and procedures of Volume V (Quality Maintenance) of the Joint Fleet Maintenance Manual.
- b. Promote effective and consistent use of Volume V (Quality Maintenance) of the Joint Fleet Maintenance Manual by TYCOMs.

- c. Ensure the scope of training through fleet schools provides the necessary skills for maintenance and management personnel to successfully support the QA program.
- d. Jointly authorize changes to this volume after evaluation and analysis of proposed changes by each TYCOM.
- e. Review TYCOM QA program by sponsoring an annual Quality Assurance Officer (QAO) Conference/Symposium, inviting TYCOM QAO and Naval Sea Systems Command (NAVSEA) technical authorities. The stated purpose should be to establish common trends, discussions of various QA concerns, improvements, and required actions.
- f. Ensure assessments of FMAs and RMCs occur in accordance with Volume IV, Chapter 2, paragraph 2.1.1 of this manual.

1.3 TYPE COMMANDER RESPONSIBILITIES.

1.3.1 Type Commander. TYCOMs are responsible for the following:

- a. (Submarines only) Obtain NAVSEA approval for exception to Re-Entry Control (REC) requirements.
- b. Administer a Departure from Specification (DFS) system to:
 - (1) Establish and maintain an auditable method of processing requests for approval of DFS.
 - (2) Review and evaluate DFS requests and obtain clarification of technical specifications from NAVSEA where appropriate.
 - (3) Approve or disapprove DFS requests.
 - (4) Obtain NAVSEA approval of DFS when required by the appropriate NAVSEA technical specification or manual.
 - (5) Keep NAVSEA informed of all major DFS requests.
 - (6) Provide a periodic status report of all outstanding major DFS to ISIC Material Officers for their action to ensure their records agree with TYCOMs and to pursue DFS clearance.
 - (7) Conduct liaison with NAVSEA on outstanding major DFS requiring NAVSEA action. Provide a periodic status report to NAVSEA of those DFS for which NAVSEA action is overdue.
 - (8) Ensure outstanding DFS for deploying/returning ships are passed between parent and deployed ISICs as required by paragraph 1.4.1.g.(6) of this chapter.
 - (9) (Surface Force Ships/Aircraft Carriers only) Maintain a file of all outstanding DFSs.
- c. Perform assessments of nuclear FMAs annually, not to exceed 18 months.
- d. (Submarines only) Perform assessments of ISICs annually not to exceed 18 months.
- e. Perform assessments of FMAs non-nuclear programs annually not to exceed 18 months.
- f. At the discretion of the TYCOM perform random, unannounced ISIC, FMA and ship QA assessments and monitor visits.
- g. Review and evaluate FMA and ISIC reports of corrective action taken on QA assessments to ensure compliance with this program.
- h. (Submarines only) Maintain a system to provide Submarine Safety (SUBSAFE) certification for submarines.
- i. Perform an annual self evaluation of the QA program and provide a copy to the Fleet QAO. For Submarine TYCOMs, the self assessment will also include SUBSAFE, Submarine Fly-By-Wire Ship Control System (FBW SCS) and Deep Submergence Systems programs and a copy of the assessment should be forwarded to NAVSEA.
- j. Evaluate and analyze proposed changes to this volume.

- k. (Submarines Only) Perform annual SUBSAFE/Scope of Certification (SOC)/FBW SCS awareness training for staff members that routinely review SUBSAFE/SOC/FBW SCS Objective Quality Evidence, make determinations on SUBSAFE/SOC/FBW SCS DFSs and perform other SUBSAFE/SOC/FBW SCS work oversight functions.
- l. (Submarines only) For FBW SCS, develop and implement the necessary instructions and procedures to meet the requirements of reference (a) and to ensure these requirements are adhered to during the life cycle of the ship.
- m. (Submarines only) Maintain FBW SCS certification in accordance with reference (a). In relation to the planning and performance of post Upgrade/Alteration or Major Repair Work Sea Trials for maintaining FBW SCS certification of previously certified submarine FBW SCS, TYCOM shall:
 - (1) Approve at-sea testing developed by the In-Service Engineering Activity (ISEA) following Upgrade/Alteration or Major Repair Work and apply appropriate restrictions and in each message state that ship's speed is restricted to 20 knots or less when an FBW SCS fault condition results in a major nonconformance affecting control of ship's pitch, heading, depth and control surfaces. The ship's speed is restricted to 20 knots or less until satisfactory resolution of the major non-conformance and TYCOM approval to operate the FBW SCS to previously authorized conditions is granted, unless specifically addressed in the Sea Trial agenda or as stated in Departure From Specifications/Deviations/Waivers.
 - (2) Following verification from the ISIC of satisfactory completion of all at-sea testing, correction of all mandatory deficiencies, receipt of certification that the FBW SCS material condition of those parts of the ship installed, repaired and/or tested by the ISEA/activity performing the work is satisfactory, and upon confirmation that FBW SCS certification was not affected for those portions of ship FBW SCS not affected by the ISEA/activity performing the work, issue a message to the ship, with copies to Chief of Naval Operations (CNO), ISIC and NAVSEA, certifying the FBW SCS and authorizing FBW SCS unrestricted use in support of submarine unrestricted operations or specifically identify any operating restrictions of the ship and/or system.
- n. (Submarines only) For assigned activities, provide NAVSEA 07Q informational copies of critiques, trouble reports and incident reports for SUBSAFE/FBW SCS/Deep Submergence System (DSS)/SOC issues that result in a problem severity level of Level 1 (critical) as defined in reference (b).

1.4 IMMEDIATE SUPERIOR IN COMMAND RESPONSIBILITIES.

NOTE: (SUBMARINES ONLY) WHEN ISIC FUNCTIONS ARE DELEGATED OUTSIDE OF THE SQUADRON (NAVAL SUBMARINE SUPPORT COMMAND, SUBMARINE SQUADRON SUPPORT CENTER, ETC.) THERE MUST BE A FORMAL TRANSFER OF RESPONSIBILITY VIA A MEMORANDUM OF AGREEMENT (MOA) OR OTHER FORMAL METHOD.

1.4.1 Immediate Superior in Command. ISICs are responsible to the TYCOM for the following:

- a. Organize and implement a QA program to carry out the provisions of this volume.
- b. (Submarines only) Organize and implement a program to verify performance of required maintenance to sustain the material condition necessary to support Unrestricted Operations (URO) to authorized operating depth in accordance with the applicable class URO Maintenance Requirement Card (MRC) manual, and this volume.
- c. (Submarines, Aircraft Carriers, Readiness Support Groups and RMCs only) Organize and implement a work request screening process such that those jobs requiring special controls are recognized and the supporting technical documentation is provided to the maintenance activity as required by this volume.
- d. (Submarines only) Review Ship's Force Controlled Work Packages (CWP) for FMA accomplished nuclear work as required by Part I, Chapter 2, Appendix E, Technical Work Document (TWD) Review and Approval matrix, of this volume.

- e. (Submarines only) Ensure ship's certification continuity report, when required by this volume, is received before the ship is underway. Review the ship's underway certification continuity report to ensure that it is in the proper format and includes all reports required. In particular, the ISIC will ensure all URO planned maintenance is up to date. Discrepancies noted must be resolved prior to underway.
- f. Review and sign the MOA required by Volume II, Part I, Chapters 3 and 4, of this manual. This agreement will list the responsibilities and actions of each party before start of any availability (e.g., unscheduled availabilities, Tiger Team repairs, technical assist visits) that involves work within SUBSAFE, FBW SCS, nuclear or Level I certification boundaries to ensure responsibilities for recertification of work performed is not split between maintenance activities and that each activity is responsible to certify the work they performed.
- g. (Submarines only) Administer a DFS system to:
 - (1) Establish and maintain system of processing requests for DFSs.
 - (2) Review and evaluate DFS requests and obtain clarification of technical specifications from TYCOM/NAVSEA where appropriate.
 - (3) Approve or disapprove DFS requests.
 - (4) Obtain TYCOM/NAVSEA approval of DFS when required by the appropriate TYCOM/NAVSEA directive, technical specification or manual.
 - (5) Ensure the deployed ISIC directing the supporting FMA will act as the cognizant ISIC for those actions required to approve, review and track DFSs for ships deployed. The parent ISIC, with concurrence from the deployed ISIC, may, on a case by case basis, perform these functions. In such cases, the parent ISIC will inform the deployed ISIC when such action(s) concurred upon is/are complete.
 - (6) The parent ISIC will provide a complete file of all outstanding DFSs to the deployed ISIC, prior to any ship deployment. The deployed ISIC will provide a complete file of all outstanding DFSs to the parent ISIC at the end of deployment.
 - (7) Specify procedures for:
 - (a) Submission of OPNAV form 4790/2K for DFS that require a future maintenance action to clear the departed condition.
 - (b) Submission of OPNAV form 4790/CK for permanent repair DFS which result in new Allowance Parts List and Coordinated Shipboard Allowance List support requirements.
 - (8) Keep parent ISIC apprised on the status of DFSs for deployed units.
 - (9) Maintain files of outstanding DFSs.
 - (10) Aggressively pursue clearing of DFSs.
- h. Monitor the QA program and procedures of assigned FMA periodically and monitor corrective actions on discrepancies noted during the last TYCOM audit. (Submarines only) Naval Submarine Support Command New London will monitor Naval Submarine Support Facility New London.
- i. Schedule and conduct a QA Program assessment in conjunction with the Fleet Readiness Training Plan (or as determined by each TYCOM) of all assigned ships to ensure the repair actions undertaken by Ship's Force conform to the provisions of the QA Program as well as pertinent technical requirements.
- j. Review and endorse TYCOM audit report of assigned FMA(s).
- k. Conduct periodic monitoring of Ship's Force work and QA program on all assigned ships during maintenance periods.
 - (1) Perform at least one surveillance during each refit/upkeep/FMA availability.

- (2) Conduct monitoring during industrial availabilities (e.g., Selected Restricted Availability, Drydocking Selected Restricted Availability, Extended Refit Period, Post Shakedown Availability, Phased Maintenance Availability, Docking Phased Maintenance Availability, Depot Modernization Period, Engineered Refueling Overhaul and Regular or Refueling Overhaul).
- l. (Submarines only) Perform annual SUBSAFE/SOC/FBW SCS awareness training for staff members (Submarine Squadrons and associated Naval Submarine Support Centers and Performance Monitoring Teams to include Weapons, Combat Systems and Material Departments with the associated Chain of Command) that routinely review SUBSAFE/SOC/FBW SCS objective quality evidence, make determinations on SUBSAFE/SOC/FBW SCS DFSs, perform other SUBSAFE/SOC/FBW SCS work oversight functions.
- m. (Submarines only) Conduct an oral interview of relieving Ship's Force QAO which covers the following topics as a minimum:
 - (1) URO Program Management including a review of the ship's current URO Schedules and Inventories and completion procedures.
 - (2) DFS Program Management including a review of all outstanding departures.
 - (3) QA Training and Qualification Program.
 - (4) QA Surveillance and Assessment Program including a review of the ship's last ISIC QA Assessment and corrective actions.
 - (5) CWP opening and closing review processes.
- n. Ensure fact-finding critiques are held to establish underlying causes and pursue corrective actions when necessary. When major errors or problems occur during maintenance that affect Nuclear, Level I, FBW SCS/Submarine Flight Critical Components (SFCC), DSS/SOC or SUBSAFE work, a critique may be necessary. Examples include when significant problems or trends occur or those that did result or could result in incidents, significant unplanned rework, serious equipment damage, malfunction or personnel injury. Minor problems are isolated deficiencies with minimal overall impact and no significant consequences; these should normally be corrected on the spot and without expending much time and effort.
 - (1) (Submarines only) Contact the **ISIC** immediately for issues which will result in a SUBSAFE/FBW SCS/DSS/SOC critique, SUBSAFE/FBW SCS/DSS/SOC trouble report, and/or SUBSAFE/FBW SCS/DSS/SOC fact-finding.
 - (2) (Submarines only) Additional guidance and direction for critiques is contained in reference (b).
 - (3) (Submarines only) Copies of critiques and incident reports for SUBSAFE/FBW SCS/DSS/SOC issues that result in a problem severity level of Level 1 (critical) will be sent to the TYCOM electronically.

NOTE: THE ISIC IS ONLY RESPONSIBLE TO AUDIT FBW WORK PERFORMED BY FORCES AFLOAT/TYCOM MANAGED ACTIVITIES.

- o. (Submarines only) ISIC responsibilities. Maintain FBW SCS certification in accordance with reference (a). In relation to the planning and performance of post Upgrade/Alteration or Major Repair Work Sea Trials, for maintaining FBW SCS certification of previously certified submarine FBW SCS, the ISIC shall:
 - (1) Provide sufficient time for crew training during the Upgrade/Alteration or Major Repair Work period to permit Ship's Force to attain a level of knowledge and proficiency of the FBW SCS adequate to ensure proper operation and safety of the ship and its personnel during Sea Trials. ISIC shall also ensure crew has proper number of trained operators.

- (2) Conduct FBW SCS Certification Audits of Upgrade/Alterations or Major Repair Work and issue report to the activity. Audits shall be conducted using the TYCOM provided FBW Certification Audit Checklist at a minimum. Provide a copy of the FBW SCS Certification Audit Report to the Supervising Authority, ship's Commanding Officer, TYCOMs, Fleet Commanders and NAVSEA.
 - (3) Following Upgrade/Alteration or Major Repair Work report, by message, crew readiness and prior to each underway until certified, verification from the ISEA/activity performing the work that all work performed by the ISEA/activity performing the work necessary for at-sea testing or Sea Trials has been completed, including resolution of ISIC FBW SCS Certification Audit Deficiencies recommendations and status of incomplete ISIC FBW SCS Certification Audit Category Deficiencies, and that the material condition of those parts of the ship installed, repaired, and/or tested by the ISEA/activity performing the work is satisfactory, certify to the TYCOM, with information copies to the CNO, the appropriate Fleet Commander and NAVSEA, that the FBW SCS material condition of those parts of the ship installed, repaired and/or tested by the ISEA/activity performing the work is satisfactory for Sea Trials in accordance with approved at-sea tests or Sea Trial agenda.
 - (4) Following verification from the ISEA/activity performing the work of satisfactory completion of all at-sea testing or trials, completion of controlled dives, correction of all mandatory Sea Trial deficiencies, and resolution of all ISIC FBW SCS Certification Audit Category IA recommendations, certify to the TYCOM, with information copies to CNO, the appropriate Fleet Commander and NAVSEA, the FBW SCS material condition of those parts of the ship installed, repaired, and/or tested by the ISEA/activity performing the work is satisfactory, and recommend authorization for FBW SCS unrestricted use in support of submarine unrestricted operations, subject to ISIC verification that FBW SCS certification of areas outside ISEA/activity performing the work tasking has been sustained, or specifically identify any operating restrictions of the ship and/or system.
- p. (Submarines only) The ISIC will transmit a Submarine Material Transfer Message to the gaining ISIC for deploying/deployed submarines when the unit out chops to include the following:
- (1) Status of outstanding Casualty Reports.
 - (2) Status of outstanding ZOZZ.
 - (3) Status of outstanding (SUBS).
 - (4) Status of active DFS actions.
 - (5) Status of Periodic Maintenance Requirements (Integrated Maintenance and Modernization Plans and UROs) for accomplishment.
 - (6) Status of Alterations for accomplishment.
 - (7) Status of Pre-Overhaul Tests/Pre-Availability Testing for ships within 12 months of a scheduled CNO availability.
 - (8) Current Operational Interval/Operational Cycle expiration dates.
 - (9) Status of Material Condition Assessment if in progress.
- q. (Submarines only) At the end of every scheduled FMA upkeep, verify all SUBSAFE deficiencies documented in the ship's Current Ship's Maintenance Project have been corrected or have an appropriate DFS.
- r. (Submarines only) Prior to submerged underway operations when submarines are in a port with an ISIC, or when a submarine is in an availability such as Continuous Maintenance Availability, Interim Drydocking, Emergent Availability or CNO Availability, the ISIC QAO shall complete a QA Pre-Underway Checklist. Appendix A of this chapter provides the minimum requirements for the QA Pre-Underway Checklist.

1.5 SHIP RESPONSIBILITIES.

1.5.1 Ship's Commanding Officer. Commanding Officer is responsible to:

- a. Designate a QAO in writing who will have sufficient time on board to maintain program continuity.
- b. Approve Technical Work Document (TWD) as required in Part I, Chapter 2, Appendix E, TWD Review and Approval matrix, of this volume.
- c. (Submarines only) Provide the ISIC a written report of ship's certification continuity prior to underway, as specified in Part I, Chapter 5, paragraph 5.6.8 of this volume.
- d. (Submarines only) Organize and implement a program to ensure performance of required maintenance to sustain the material condition necessary to support URO to authorized operating depth in accordance with the applicable class URO MRC manual and Volume VI of this manual.
- e. (Submarines only) Organize and implement a program to ensure performance of required maintenance to sustain the material condition necessary to support FBW unrestricted operations in accordance with reference (a).
- f. (Submarines only) Organize and implement a program to ensure performance of required maintenance to sustain the material condition necessary to support DSS-SOC certification (if required) in accordance with reference (c).
- g. (Submarines only) Approve and sign all recertification Reactor Plant Work Accomplishment Reports (RPWAR) and ensure these documents are forwarded to the Reactor Plant Planning Yard with copy to NAVSEA Nuclear Propulsion Directorate (08), TYCOM and ISIC.
- h. Certify all QA personnel qualifications (respective Department Head on Aircraft Carriers).
- i. Review and sign with the shipyard or other industrial activity, RMC/FMA and ISIC, an MOA on responsibilities and action of each party with respect to work accomplishment prior to start of SUBSAFE, nuclear, FBW SCS or Level I work in accordance with this manual.
- j. Approve DFSs in accordance with Part I, Chapter 8 of this volume.

1.5.2 Ship's Executive Officer. Executive Officer is responsible for the following:

- a. Monitoring the QAO's administration of the ship's QA Audit, surveillance, training and qualification programs.
- b. Providing senior command level authority to backup the QAO in the performance of the QAO's duties.
- c. Spot checking performance of QA training by attending/monitoring training periodically.
- d. Assigning an Assistant Quality Assurance Officer (AQAO) who is an E-6 or above to be an administrative assistant to the QAO.

1.5.3 Ship's Department Head. Department Heads are responsible to:

- a. Ensure area(s) in or adjacent to their work centers/divisions/spaces are designated for the stowage of controlled material in accordance with Part I, Chapter 6 of this volume.
- b. Review or approve Formal Work Package (FWP) and TWD as required in Part I, Chapter 2, Appendix E, TWD Review and Approval matrix, of this volume.
- c. Ensure personnel in their departments involved in performing, planning, approving or supervising shipboard maintenance on SUBSAFE, nuclear, FBW SCS and Level I systems participate in QA training.
- d. Verify the department maintains sufficient numbers of qualified Quality Assurance Inspectors (QAI) and Controlled Material Petty Officers (CMPO).
- e. Participate in oral examination of shipboard QAI and Quality Assurance Supervisor (QAS) assigned to their departments.
- f. Ensure personnel within their departments perform QA surveillance, qualification, training, etc. as defined in this volume.

- g. Review and approve information submitted to the FMA for identification of controlled work. This information must include a TWD serial number when required by Part I, Chapter 2 of this volume. This review will also ensure that the work request identifies specific categories applicable in each of the following situations as required by this volume:
 - (1) SUBSAFE.
 - (2) Level I.
 - (3) Submarine Antenna Engineering Directorate (SAED).
 - (4) Nuclear.
 - (5) Special cleanliness requirements.
 - (6) Special testing requirements.
 - (7) Special fabrication requirements.
 - (8) DFS.
 - (9) SOC.
 - (10) SFCC.
- h. Ensure fact-finding critiques are held to establish underlying causes and pursue corrective actions when necessary. When major errors or problems occur during maintenance that affect Nuclear, Level I, FBW SCS/SFCC, DSS/SOC or SUBSAFE work, a critique may be necessary. Examples include when significant problems or trends occur or those that did result or could result in incidents, significant unplanned rework, serious equipment damage, malfunction or personnel injury. Minor problems are isolated deficiencies with minimal overall impact and no significant consequences; these should normally be corrected on the spot and without expending much time and effort.
 - (1) (Submarines only) Contact the ISIC immediately for issues which will result in a SUBSAFE/FBW SCS/DSS/SOC critique, SUBSAFE/FBW SCS/DSS/SOC trouble report, and/or SUBSAFE/FBW SCS/DSS/SOC fact-finding.
 - (2) (Submarines only) Additional guidance and direction for critiques is contained in reference (b).
 - (3) (Submarines only) Copies of critiques and incident reports for SUBSAFE/FBW SCS/DSS/SOC issues that result in a problem severity level of Level 1 (critical) will be sent to the TYCOM electronically.
- i. Review DFS for technical accuracy and sign.
- j. Spot check performance of QA training by attending/monitoring training at least quarterly.
- k. (Aircraft Carriers only) Certify QA qualifications for personnel assigned to their department by signing the applicable Personnel Qualification Standard cover sheet of reference (d).

1.5.4 Ship's Supply Officer. The Supply Officer is responsible to:

- a. Ensure procurement, receipt and stowage of Nuclear, SOC, SFCC, SAED - Submarine Antenna Quality Assured Material and Level I materials are in compliance with this volume, applicable material control standards and instructions.
- b. Designate and maintain areas for stowage of Level I (LI) and SOC stock program material, SFCC and Nuclear Repair Parts (NRP) in the custody of the supply department.
- c. File the Supervisor of Shipbuilding letter of certification for Level I, SFCC and NRP which are in the custody of the supply department.

- d. Turn over the material certification documentation (or copy of, when only partial issue of lot) for LI/SOC/SEAWOLF Class Component (SW)/VIRGINIA Class Component (VU) stock program material and NRP to the customer.
- e. Send LI/SOC stock program material, NRP, SW, VU and copies of material certification documents to FMA work centers when the ship is providing the material.
- f. Ensure copies of the material certification documents are forwarded to the requesting activity, when LI/SOC stock program material, SFCC and NRP items are removed from own ship's systems or from onboard repair parts.
- g. Return defective LI/SOC stock program material, SW, VU and NRP to the Navy supply system and submit defective material reports in accordance with supply department procedures.
- h. Ensure appropriate supply department personnel receive training on nuclear and non-nuclear controlled material certification, procurement, receipt inspection and LI/SOC stock program material, SW, VU and NRP stowage requirements.

1.5.5 Ship's Engineer Officer (Submarines only). The Engineer Officer is responsible to:

- a. Submit blank RPWAR forms to the FMA with each work request and CWP serial number, when FMA assistance is necessary for reactor plant SUBSAFE work. Ensure all work requests requiring special reactor plant SUBSAFE work controls are properly identified.
- b. Verify continuity of reactor plant SUBSAFE certification by controlling and documenting work and tests performed for each Re-Entry.
- c. Review and sign the necessary recertification information on the applicable RPWAR pages for repairs requiring RPWAR submission and forward the original to the Reactor Plant Planning Yard with a copy to NAVSEA 08, TYCOM and ISIC.
- d. Maintain current the reactor plant hull integrity records using the completed RPWAR, filed in an auditable manner with the latest revision of the NAVSEA drawing "Status of Reactor Plant Work Accomplishment Reports for (individual ship)". Reproducible blank RPWAR will also be maintained in this same file to support future maintenance. Documentation of the actual maintenance performed and testing accomplished by Ship's Force is to be maintained in the ship's completed CWP file required by this volume.
- e. Review or approve Oxygen, Nuclear and SUBSAFE CWPs as required by Part 1, Chapter 2, Appendix E of this volume.
- f. Coordinate with the Ship's QAO and Engineering Department Master Chief to incorporate QA training as required by Part I, Chapter 3 and Part III, Chapter 3 (as applicable) of this volume and reference (a) (as applicable) into the Engineering Department Training Plan.

1.5.6 Availability Coordinator (Submarines only). A submarine served, nuclear trained Limited Duty Officer will be assigned to augment the normal ship's complement during Depot Modernization Periods, Engineered Refueling Overhauls, or Engineered Overhauls and will act as the Availability Coordinator for the ship. The Availability Coordinator's responsibilities include:

- a. Become a knowledgeable member of the availability project team.
- b. To support these requirements, the Availability Coordinator will be assigned as early as possible during the pre-availability test and inspection period, nominally 15 months before the availability starts. Prior to reporting to the submarine, the Availability Coordinator will be trained in shipyard processes and Availability Work Package requirements in accordance with reference (e), Appendix H. After reporting to the submarine, the Availability Coordinator should spend a significant portion of his time working with the shipyard project team prior to the start of the availability. This may require that he remain ashore during key pre-availability planning phases while the submarine is at sea. Finally, to prevent interference with his responsibilities for availability planning and execution, the Availability Coordinator should not be assigned routine watch standing duties. He should maintain proficiency

requirements (about two watches per month), but his watch standing duties should not interfere with daily project management routine or the increased pace of coordination associated with major key events (e.g., undocking).

- c. Educate/train Ship's Force on shipyard tools and processes to be used during the availability. This responsibility does not circumvent the requirements placed on the industrial activity to train Ship's Force, but the Availability Coordinator will coordinate and complement the training provided by the industrial activity.
- d. Coordinate the integration and execution of Ship's Force responsibilities during the availability planning and execution.
- e. Act as the primary liaison between Ship's Force and the shipyard project team.

1.5.7 Ship's Maintenance Manager (Aircraft Carriers only). Maintenance Manager is responsible to establish and maintain a Quality Deficiency Reporting Program for resolving quality issues for work performed by outside activities and to ensure that each work request/job order is screened for Quality Control/QA requirements and marked up or stamped as to specific category applicable in each of the following situations as required by this volume:

- a. Nuclear.
- b. Level I.
- c. Special cleanliness requirements.
- d. Special testing requirements.
- e. Special fabrication requirements.

1.5.8 Ship's Principal Assistant. Principal Assistants will be responsible for duties as assigned by the Engineer/Reactor Officer.

1.5.9 Ship's Division Officer. Division Officers are responsible to:

- a. Review TWD as required in Part I, Chapter 2 Appendix E, TWD Review and Approval matrix, of this volume.
- b. Review the FWP as required in Part I, Chapter 2, paragraph 2.3.4 of this volume.
- c. Verify controlled work is accomplished in accordance with an approved CWP.
- d. Ensure personnel assigned to their divisions perform QA surveillance, qualification, training, etc. as defined in this instruction.
- e. Supervise QA training of division personnel.
- f. Provide timely response to QA 14, indicating root cause analysis and actions taken.
- g. Issue unique identification numbers for brazers and welders.
- h. Maintain a log of unique identification numbers assigned to brazers/welders.
- i. Ensure annual validation of qualification is performed for brazers/welders and entries are entered into the individual service records.
- j. Maintain an auditable file for each brazer/welder assigned.
- k. Maintain an auditable log of each brazer/welder for proper maintenance of qualification.

1.5.10 Ship's Work Center Supervisor. Work Center Supervisor is responsible to:

- a. Review the FWP as required in Part I, Chapter 2, paragraph 2.3.4 of this volume.
- b. Have TWD prepared, when designated the Lead Work Center (LWC), and as required by Part I, Chapter 2, paragraph 2.2 of this volume:

- (1) Verify the FWP provides the correct written instructions both in sequence and requirements to satisfactorily accomplish the controlled work.
 - (2) Verify the FWP contains/lists the correct technical specifications or requirements (e.g., torque values, dimensions, Nondestructive Testing (NDT) inspection, special cleanliness, recertification test) for certification attributes to be documented on the appropriate QA form.
 - (3) Ensure signatures for repair work attributes are annotated as requiring Certification Signature Block (CSB) or signature, as applicable, on the QA form and in the FWP as discussed in Part I, Chapter 2 of this volume by use of (R), (S), (C), (I), (Q) and (V) in the margin by the appropriate step.
- c. Ensure all controlled work is accomplished in accordance with approved CWP.
 - d. Ensure proper work authorizations have been obtained prior to starting work.
 - e. Ensure tools, measuring and test equipment used during maintenance and testing are of proper range, scale and in calibration.
 - f. Conduct QA training of work center personnel.
 - g. Ensure work center personnel are properly trained and qualified, if required, prior to assignment to tasks requiring QA and/or special cleanliness (e.g., oxygen, hydrogen, reactor plant, steam plant) certifications.
 - h. Ensure only material specified by the applicable drawings, standards, or specifications is ordered and installed.
 - i. Submit request for use of rejected material using a Reject Tag (QA form 3).
 - j. Obtain written permission from the QAO to downgrade LI stock program material, NRP, or controlled material for non-level use.
 - k. Supervise QA programs within assigned work centers.
 - l. Review work for satisfactory completion.
 - m. Ensure CWPs for completed controlled work are complete, properly reviewed and forwarded with all certifying documents.
 - n. Initiate a DFS for non-nuclear or Liaison Action Request (LAR) for nuclear tests, inspections, material or other requirements of any maintenance action in which the requirements were not met.

1.5.11 Ship's Craftsman. Craftsman is responsible to:

- a. Perform all maintenance actions in accordance with the approved procedure. If that guidance is either incorrect, incomplete or unclear, stop and seek clarification from the work center or shift supervisor.
- b. Ensure QA forms associated with the maintenance are correctly completed in accordance with the applicable sections of this volume.
- c. Enter signature, printed name and date on all QA data forms completed.
- d. Initiate a DFS for non-nuclear or LAR for nuclear tests, inspections, material or other requirements of any maintenance action in which the requirements were not met.
- e. Ensure only Test, Measuring and Diagnostic Equipment (TMDE) (i.e., measuring devices, instruments, inspection tools, gauges, jigs or fixtures), which have current calibration stickers/records attached or available, are used for production, acceptance and testing. Uncalibrated/untested TMDE will be tagged and removed from service immediately.

1.5.12 Ship's Quality Assurance Officer. QAO is responsible to:

- a. Administer the ship's QA program.
- b. Review TWD as required in Part I, Chapter 2, Appendix E, TWD Review and Approval matrix, of this volume.

- c. Review the FWP as required in Part I, Chapter 2, paragraph 2.3.4 of this volume.
- d. Verify the FWP, in the CWP, specifies the correct OQE that is to be generated to prove recertification of the system or component.
- e. Verify the testing requirements for controlled work, called out in the FWP, are correct and in accordance with the latest applicable specifications as required by Part I, Chapter 2, paragraph 2.3 of this volume.
- f. Verify completed test results for controlled work fully satisfy test requirements, or corrective action is taken.
- g. Review and close out all TWDs for work on systems or components required for reactor plant startup, propulsion plant startup or ship's underway operations (e.g., if the work is on a spare component it may not be necessary to close the TWD) prior to startup or getting underway.
- h. Maintain the following record files in accordance with Part I, Chapter 10, paragraph 10.5 of this volume:
 - (1) Completed CWPs.
 - (2) QA Assessments, audits, surveillance and deficiency correction.
 - (3) Controlled material.
- i. Determine suitability for use of Level I, SOC, SFCC or Nuclear Level I material from another ship in own ship's system, when the transfer is directly from the donating ship.
- j. Provide disposition instructions for material rejected at receipt inspection.
- k. Obtain chemical analysis, NDT, destructive testing and generic materials identity testing results as required by Part I Chapter 6 of this volume to certify material for use in a certified (e.g., Level I, SUBSAFE, Nuclear, Scope of Certification) system.
- l. Provide technical services to the Supply Officer for determining material requirements.
- m. Authorize downgrading of LI stock program material, NRP or controlled material for non-level use.
- n. Review requests for DFS for accuracy and technical merit, and forward to Department Head.
- o. Maintain an auditable file of outstanding DFS and the record of DFS numbers assigned. Prior to each underway following any scheduled Fleet/CNO Maintenance Availability, the ship's QAO will audit active DFSs against associated Job Control Numbers to verify a current up to date entry in the Current Ship's Maintenance Project exists.
- p. Maintain a file of DFS which have been approved as permanent repairs and result in change in configuration until they are reflected in ship's drawings.
- q. Verify ship's mapping plans and selected records and drawings are updated (marked up) when approved DFS authorize a change in configuration as a permanent repair.
- r. Submit DFS clearance reports, using Departure Clearance Report (QA form 12A) to the approving authority when the work was done which corrects specific DFS. If unable to use a QA form 12A, use the message format of Part I, Chapter 8, Appendix B, of this volume.
- s. Manage the ship's internal QA Audit and Surveillance program as required by Part I Chapter 9 of this volume. Coordinate with the ship's Executive Officer to resolve surveillance scheduling and accomplishment problems.
- t. Ensure that QA training is conducted as required by Part I, Chapter 3 and Part III, Chapter 3 (as applicable) of this volume and reference (a) (as applicable). The QAO will coordinate with the Ship's Engineer and Engineering Department Master Chief to incorporate these requirements into the Engineering Departmental Training Plan. The QAO will attend QA training when practical.
- u. Assess QA training and provide input to Engineering Department Master Chief and Ship's Engineer for incorporation into the periodic Engineering Department Training assessment as required by reference (f).

- v. Implement a formal qualification program for QAIs, CMPOs, Cleanliness Inspector/Certifiers, QASs, Work Center Supervisors and Maintenance Planners (if assigned).
- w. Conduct oral qualification interviews for QAIs/QASs/CMPOs/Cleanliness Inspector/Certifiers, Work Center Supervisors and Maintenance Planners.
- x. Maintain a current master list of qualified CMPOs/Controlled Material Handlers (CMH), Cleanliness Inspectors, QAIs, QASs (if assigned), Oxygen Clean Workers, Oxygen Clean Instructors, Work Center Supervisors and Maintenance Planners as specified in Part I, Chapter 10 of this volume.
- y. (Submarines only) Verify all reactor plant hull integrity area maintenance is accomplished in accordance with appropriate directives.
- z. (Submarines only) Verify **the appropriate work control** is initiated for work within the SUBSAFE, **SOC and FBW** boundary.
- aa. (Submarines only) Maintain SUBSAFE **and SOC REC and FBW**/CWP records including the CWP log.
- ab. (Submarines only) Coordinate with the ISIC and the FMA to ensure the administration, scheduling and reporting of the URO MRC program is in accordance with the applicable class URO MRC manual, and this volume.
- ac. (Submarines only) Retain any QA form 34 generated in connection with controlled assembly performed as a REC exception in accordance with Part I, Chapter 5, paragraph 5.6.7, Note 3 of this volume.
- ad. Review in detail as many non-nuclear NDT weld records as possible (minimum of 10 percent per year) to ensure that all of the requirements of the applicable fabrication documents have been and are continuously being met.
- ae. Verify an active Job Control Number exists for all active temporary DFSs at the completion of all scheduled Fleet Maintenance Activity Availabilities, major or minor, CNO availabilities or at least quarterly and maintain an auditable record of the verification until superseded.
- af. (Submarines only) At the end of a scheduled FMA upkeep, verify all SUBSAFE deficiencies documented in the ship's Current Ship's Maintenance Project have been corrected or have an appropriate DFS.

1.5.13 Ship's Assistant Quality Assurance Officer. A QAO is responsible to perform duties as assigned by the QAO.

1.5.14 Ship's Quality Assurance Supervisor. QAS, if assigned, will perform the duties as specified in paragraph 1.6.13 of this chapter.

1.5.15 Ship's Quality Assurance Inspectors. QAIs are responsible for coordinating and administering the QA Program within their respective work centers. The QAI will:

- a. Develop a thorough understanding of the QA program.
- b. After verifying work completed, enter initials or signature (as required by the form, tag or procedure), and the date on all applicable QA forms/tags and CWP steps.
- c. Verify QA form 2 is filled out correctly and attached to items removed from a controlled system for transfer to another Fleet activity and ensure items received from another ship have QA form 2 tags attached.
- d. As LWC QAI, review each CWP prepared which requires QAI CSBs to verify inspection requirements are adequately addressed before submission to QAO and/or Department Head as required by Part I, Chapter 2, Appendix **E**, of this volume.
- e. Verify all work inspected meets the minimum requirements set forth in latest applicable plans, specifications and directives of higher authority as stated in the FWP.
- f. Perform QA inspections of certification attributes as required by Part I, Chapter 5, of this volume.
- g. Ensure all inspections beyond the capability of the QAI are performed by FMA inspectors prior to final acceptance/installation of the product by the ship.

- h. Ensure only TMDE (i.e., measuring devices, instruments, inspection tools, gauges, jigs or fixtures), which have current calibration stickers/records attached or available, are used for production, acceptance and testing. Uncalibrated/untested TMDE will be tagged and removed from service immediately.
- i. Ensure items removed from controlled systems are tagged with QA form 2 when required by Part I, Chapter 6 of this volume. Tags are not required if material is nuclear non-Level (Level N/A) or non-nuclear non-level.
- j. Ensure controlled material (Level I, Nuclear Level I, **Material Control Division A & B, SFCCs**) delivered to a RMC/FMA work center for work is tagged with a QA form 2.
- k. Report all work and testing discrepancies/deficiencies to the department head and the QAO via chain of command. Ensure the deficiency is resolved before work continues.
- l. Sign QA form 2 when controlled material is installed for SUBSAFE and nuclear systems.
- m. As LWC QAI, review all completed QA forms and data sheets for accuracy, completeness and technical correctness.
- n. Reject untraceable, damaged, or unclean controlled material using a material reject tag (QA form 3).
- o. Witness controlled assemblies, as a second party not involved in the actual work.
- p. (Submarines only) Complete the necessary recertification information for maintenance performed by Ship's Force; for material changes/replacement, material generic identification (if not previously documented) or fastener torque on the applicable blank RPWAR pages and submit to the Engineer Officer for review prior to approval by the Commanding Officer. The general notes for report preparation and use, supplied with each RPWAR, will be used in completing the recertification form.
- q. Review certification testing as part of CWP preparation.
- r. Witness and document results of tests (hydrostatic, drop, joint tightness). Work center tests of components conducted by the FMA need not be witnessed, unless directed by the Department Head or FMA CWP. Promptly inform supervisors of unsatisfactory test results. Ensure test documentation is complete and accurate.
- s. Review DFS/LAR prepared by the work center for accuracy and technical merit, and forward to the Division Officer and QAO.

1.5.16 Ship's Controlled Material Petty Officer. CMPOs are responsible to:

- a. Ensure all material under their cognizance is stored and controlled to the requirements of references (a) or (e).
- b. Receipt inspect all LI stock program material, SFCC and NRP received by work center/division.
- c. Request disposition instructions for rejected material.
- d. Remove QA form 3 from previously rejected and now accepted controlled material, annotate the material acceptance on the QA form 2 and file the QA form 3 with the CWP.
- e. Maintain custody of controlled material in segregated stowage in accordance with reference (g).
- f. Inspect controlled material storage areas of their work center semi-annually, as a minimum in accordance with Part I, Chapter 6 of this volume.
- g. Ensure controlled material is properly stowed and handled so the identification of the subject material and its certification are always maintained.
- h. Ensure nuclear material received without Ready for Issue tags is certified to the required "Level of Essentiality".
- i. Reject unsatisfactory material. Fill out and attach QA form 3 and request disposition instructions.
- j. Send any material certification documents for material which has been provided by the ship to the RMC/FMA QA office. Ship should retain original.

- k. Perform receipt inspection of package alteration kits that contain controlled material when ready for use.
- l. Ensure controlled material markings are on all pieces when cutting a smaller piece from a larger one.
- m. Ensure controlled material markings are moved to an unaffected area, if the controlled material item will lose the markings due to a fabrication process (e.g., welding, machining) prior to the fabrication process.
- n. Ensure all controlled material is identified, color coded, marked and tagged as required by this volume and the applicable material control standard.

1.5.17 Ship's Cleanliness Inspector/Certifier. Cleanliness Inspectors/Certifiers are responsible to perform initial, in process and final cleanliness inspections during maintenance/repairs for those systems requiring cleanliness controls per Part I, Chapter 5, paragraph 5.4, of this volume.

1.5.18 Ship's Nondestructive Test Examiner. The ship's NDT Examiner shall be appointed in writing by the Commanding Officer and shall be responsible for all aspects of the command's Nondestructive testing program. NDT Examiner qualification and certification requirements are specified in reference (h). The following shall comprise the core responsibilities of the ship's NDT Examiner:

- a. Coordinate the efforts of other assigned NDT examiners at the activity.
- b. Act as the command's point of contact for NDT technical issues. In addition, act as the command's point of contact with NAVSEA for NDT issues.
- c. Develop the command's NDT examiner guidelines, to include the command's written practice for NDT certification when required by reference (i) utilizing the input of all participating NDT examiners.
- d. Ensure submittal of required reports of certification or recertification to higher authority as required by reference (j).
- e. Review all requests for NDT training courses and examiner certification services. Provide recommendations to the chain of command regarding eligibility of the requestor, and the need for such training or certification based on current and projected NDT personnel resources.
- f. Approve examination material for all NDT methods utilized at the activity for which they are certified. Ensure examination material reflects changes made to applicable fabrication documents.
- g. Approve, and qualify NDT procedures for each method utilized at the activity. Revise and approve procedures as necessary when changes are made to applicable fabrication documents.
- h. Schedule and perform NDT Inspector surveillance. Maintain records of surveillance in order to perform trend analysis of inspector abilities and program effectiveness.
- i. Schedule and administer NDT examinations. Maintain records of examinations sufficient to trace inspector qualifications to original examination material. Maintain a matrix of high miss questions in order to assess inspector knowledge and program effectiveness.
- j. Train, certify and monitor NDT Inspectors as required by applicable specifications and Part I, Chapter 3 paragraph 3.2.2 of this volume.
- k. Schedule eye examinations for NDT Inspectors.
- l. Ensure each NDT Inspector's service record is kept updated with qualification status.
- m. Maintain individual records of qualification for NDT inspectors.
- n. Monitor the welder/brazer qualification and training per reference (k).
- o. Review all welder/brazer qualification records for completeness, semi-annually.
- p. Review completed NDT inspection reports for technical completeness and accuracy and sign, where indicated on the report, on completion of work.
- q. Review, approve and monitor the command's welder/brazer training and qualification program as required by reference (k).

- r. Prepare and execute the training and qualification program for each NDT method that leads to inspector certification in each method and maintains inspector competency in each method.

1.5.19 Ship's Nondestructive Test Inspector. NDT Inspectors are responsible to:

- a. Verify CWP's which include NDT inspections properly identify the inspection requirements and acceptance criteria.
- b. Ensure NDT inspections are completed correctly and in accordance with the applicable requirement and inspection reports are technically complete and accurate.
- c. Ensure use of only TMDE (i.e., measuring devices, instruments, inspection tools, gauges, jigs or fixtures), which have current calibration stickers/records attached or available, for production, acceptance and testing. Uncalibrated/untested TMDE will be tagged and removed from service immediately.
- d. When no NDT Examiner is assigned, monitor the welder/brazer qualification and training per reference (k).

1.5.20 Engineering Department Master Chief. The Engineering Department Master Chief is responsible to coordinate with the Ship's Engineer and QAO to incorporate the QAO provided training as required by Part I, Chapter 3 and Part III, Chapter 3 (as applicable) of this volume and reference (a) (as applicable) into the Engineering Department Training Plan.

1.5.21 Ship's Maintenance Planner (Submarines and Aircraft Carriers only). Maintenance Planners are responsible to:

- a. Prepare the FWP/CWP as required in Part I, Chapter 2, paragraph 2.3.1.b of this volume.
- b. Perform ship check/job check to verify equipment configuration supports work package development.
- c. Develop FWPs/CWPs with the correct written instructions both in sequence and requirements to satisfactorily accomplish the work.
- d. Develop FWPs/CWPs with the correct technical specifications or requirements (e.g., torque values, dimensions, NDT inspection, special cleanliness, recertification test) for certification attributes to be documented on the appropriate QA form. Fill in all preplaced data required by QA form instructions prior to routing CWP.
- e. Ensure signatures for repair work attributes are annotated as requiring CSB or signature, as applicable, on the QA form and in the FWP as discussed in Part I, Chapter 2 of this volume by use of (R), (S), (C), (I), (Q) and (V) in the margin by the appropriate step.
- f. Ensure correct materials, spare parts and special test equipment to be used during maintenance and testing are called out in the materials section of the FWP.
- g. Initiate revisions to FWPs/CWPs when requirements of Part I, Chapter 2, paragraph 2.3.7.3.b(2)(b) and (d) of this volume are met.
- h. Maintain file of Standardized FWPs in accordance with Part I, Chapter 2, paragraph 2.3.7.10.e. of this volume, for their respective divisions. Submit Standardized FWPs to LWC Supervisor for approval prior to use.
- i. Initiate procurement of material specified by the applicable drawings, standards or specifications to complete the designated repairs.
- j. Prepare and route a DFS for non-nuclear or LAR for nuclear tests, inspections, material or other requirements of any maintenance action in which the requirements were not met.

1.6 REGIONAL MAINTENANCE CENTER/FLEET MAINTENANCE ACTIVITY RESPONSIBILITIES.

1.6.1 RMC Commander/FMA Commanding Officer. Responsible for QA in the maintenance, repair and alteration of fleet ships as follows:

- a. Designate the RMC/FMA QAO in writing.

- b. (Submarines only) Provide a written report of certification to the tended ship, at the conclusion of a maintenance period and prior to a tended ship's next underway.
- c. Certify the qualifications of QA personnel.
- d. Ensure the RMC/FMA has an effective audit and surveillance program capable of assessing work performance and identifying areas of poor performance.
- e. Initiate a semi-annual evaluation of the RMC/FMA QA Program by the QAO.
- f. (Submarines only) Implements all aspects of the SUBSAFE and FBW-SCS programs as delineated by references (a), (c), (I) and (m).

1.6.2 RMC Deputy Commander/FMA Executive Officer. Responsible for the following:

- a. Monitoring the QAO's administration of the RMC/FMA's QA surveillance, training and qualification programs.
- b. Providing senior command level authority to backup the QAO in the performance of the QAO's duties.
- c. Spot checking performance of QA training by attending/monitoring training periodically.
- d. Assigning an AQAO who is an E-7 or above or a senior civilian to be an administrative assistant to the QAO.
- e. Assigning sufficient QASs and QAIs to the QA Division.

1.6.3 RMC Production Officer/FMA Repair Officer. Production Officer/Repair Officer is responsible to:

- NOTES:
- 1. AT TRIDENT REFIT FACILITIES SOME OF THESE RESPONSIBILITIES MAY BE UNDER THE COGNIZANCE OF THE PLANNING OFFICER. HOWEVER, THEY WILL NOT BE DELEGATED TO A LEVEL LESS THAN A DEPARTMENT HEAD.
 - 2. WHERE NOTED, SOME OF THESE RESPONSIBILITIES MAY BE UNDER THE COGNIZANCE OF THE ENGINEERING DEPARTMENT HEAD AT AN RMC.
- a. Implement a work request screening process such that jobs requiring special controls are recognized.
 - b. Implement a QA Program that ensures all work accomplished by the Production/Repair Department meets the material and workmanship requirements of approved plans and specifications.
 - c. Provide liaison with other department heads when their functions are directly or indirectly related to the QA requirements of the Production/Repair Department.
 - d. Review and approve TWD as required in Part I, Chapter 2, Appendix E, TWD Review and Approval matrix, of this volume.
 - e. Review and approve the FWP as required in Part I, Chapter 2, paragraph 2.3.4 of this volume.
 - f. (Submarines only) Approve and sign all recertification RPWAR and ensure these documents are forwarded to the Reactor Plant Planning Yard with copy to NAVSEA 08, TYCOM and tended ship's parent ISIC.
 - g. Review all DFS initiated by the RMC/FMA.
 - h. (Submarines only) Review and approve all LARs initiated by the FMA.
 - i. Maintain a sufficient number of qualified personnel to adequately staff the QA Division. At RMCs this may be performed by the Quality Assurance Department Head.
 - j. Implement a formal training and qualification program for all personnel assigned to the Production/Repair Department who perform, plan, and/or supervise controlled work, covering QA requirements and practices.
 - k. Designate nuclear/non-nuclear Metallographic Test Method Examiner and Generic Material Alloy Identification Examiners (as applicable). At RMCs this may be performed by the Quality Assurance Department Head.

- l. Verify the RMC/FMA has an effective audit and surveillance program capable of assessing work performance and identifying areas of poor performance. At RMCs this may be performed by the Quality Assurance Department Head.
- m. Ensure fact-finding critiques are held to establish underlying causes and pursue corrective actions when necessary. When major errors or problems occur during maintenance that affect Nuclear, Level I, FBW SCS/SFCC, DSS/SOC or SUBSAFE work, a critique may be necessary. Examples include when significant problems or trends occur or those that did result or could result in incidents, significant unplanned rework, serious equipment damage, malfunction or personnel injury. Minor problems are isolated deficiencies with minimal overall impact and no significant consequences; these should normally be corrected on the spot and without expending much time and effort. At RMCs this may be performed by the Engineering or Quality Assurance Department Head.
 - (1) (Submarines only) Contact the ISIC immediately for issues which will result in a SUBSAFE/FBW SCS/DSS/SOC critique, SUBSAFE/FBW SCS/DSS/SOC trouble report, and/or SUBSAFE/FBW SCS/DSS/SOC fact-finding.
 - (2) (Submarines only) Additional guidance and direction for critiques is contained in reference (b).
 - (3) (Submarines only) Copies of critiques and incident reports for SUBSAFE/FBW SCS/DSS/SOC issues that result in a problem severity level of Level 1 (critical) will be sent to the TYCOM electronically.
- n. Ensure that each work request/job order is screened for Quality Control/QA requirements and marked up or stamped as to specific category applicable in each of the following situations as required by this manual:
 - (1) SUBSAFE.
 - (2) Level I.
 - (3) SAED.
 - (4) Nuclear.
 - (5) Special cleanliness requirements.
 - (6) Special testing requirements.
 - (7) Special fabrication requirements.
 - (8) SOC.
 - (9) SFCC.
- o. (Submarine Repair Facilities) Oversees the implementation of the SUBSAFE, DSS-SOC and FBW-SCS programs as directed by references (a), (c), (l) and (m).

1.6.4 FMA Supply Officer. Supply Officer is responsible to:

- a. Designate area(s) for stowage of LI/SOC/SW/VU stock program material and NRP in the custody of the supply department.
- b. Ensure procurement, stowage, and issue of SAED – Submarine Antenna Quality Assured Material, Nuclear, SOC, SFCC and Level I materials are in compliance with the applicable material control standards, instructions and this volume.
- c. Ensure accompanying certification documents remain with the LI/SOC stock program material, SW, VU and NRP for which the supply department has custody.
- d. Turn over material certification documentation (or copy, if issuing other than the entire lot) for LI/SOC stock program material, SFCC and NRP to the customer.
- e. Return defective LI/SOC stock program material, SW, VU and NRP to the Navy supply system in accordance with supply department procedures. Submit defective material reports.

- f. Ensure appropriate supply personnel receive training on nuclear and non-nuclear material covering material certification, material procurement, receipt inspection, and LI/SOC stock program material, SW, VU and NRP stowage requirements.
- g. Ensure semiannual inventories of supply's LI/SOC stock program material, SW, VU and NRP are conducted.

1.6.5 FMA Nuclear Repair Officer. When assigned, the Nuclear Repair Officer is responsible to:

- a. Determine and specify the material requirements and the certification requirements for the NRP to be used in nuclear controlled work.
- b. Initiate procurement action for NRP required for accomplishment of nuclear tasks.
- c. Review and approve the FWP as required in Part I, Chapter 2, paragraph 2.3.4 of this volume.
- d. Prepare and promulgate the CWP, when OQE is required at the conclusion of the nuclear work and as required by Part I, Chapter 2 of this volume.
 - (1) Verify the FWP is the correct procedure both in sequence and requirements to satisfactorily accomplish the controlled work.
 - (2) Verify the CWP contains/lists the correct technical specifications or requirements (e.g., torque values, dimensions, NDT inspections, special cleanliness, test) for certification attributes to be documented on the appropriate QA form.
 - (3) Ensure test requirements for controlled work comply with the latest applicable specifications.
 - (4) Ensure signatures for repair work attributes are annotated as requiring CSB or signature, as applicable, on the QA form and in the FWP as discussed in Part I, Chapter 2 of this volume by use of (R), (S), (CI), (G), (C), (I), (Q) and (V) in the margin by the appropriate step.
- e. (Submarines only) Review and sign the necessary recertification RPWAR pages, as required by Part I, Chapter 5, paragraph 5.11, of this volume for repair/maintenance actions performed in Reactor Plant SUBSAFE/Hull Integrity areas by the FMA and forward to the QAO for review.
- f. (Submarines only) Maintain copies of approved RPWAR forwarded to the Reactor Plant Planning Yard in an auditable fashion.
- g. Provide the tended ship the test requirements and joints/components to be tested for recertification of FMA work prior to commencing work on the tended ship.
- h. Conduct oral examinations for qualification of personnel as reactor plant Cleanliness Inspector/Certifier.
- i. Ensure only appropriately trained and/or qualified personnel perform nuclear work.

1.6.6 RMC/FMA Planning and Estimating Officer. Planning and Estimating Officer is responsible to:

- a. Determine and specify the material requirements and the certification requirements for the LI/SFCC and other materials to be used in non-nuclear controlled work.
- b. Initiate procurement action for LI/SFCC stock program material and other materials required for accomplishment of non-nuclear tasks assigned.
- c. Review the FWP as required in Part I, Chapter 2, paragraph 2.3.4 of this volume.
- d. Prepare and promulgate the CWP when OQE is required at the conclusion of the non-nuclear controlled work and as required by Part I, Chapter 2 of this volume.
 - (1) Verify the FWP is the correct procedure both in sequence and requirements to satisfactorily accomplish the controlled work.
 - (2) Verify the CWP contains/lists the correct technical specifications or requirements (e.g., torque values, dimensions, NDT inspections, special cleanliness, tests) for certification attributes to be documented on the appropriate QA form.
 - (3) Ensure test requirements comply with the latest applicable specifications.

- (4) Ensure signatures for repair work attributes are annotated as requiring CSB or signature, as applicable, on the QA form and in the FWP as discussed in Part I, Chapter 2, paragraph 2.3 of this volume by use of (R), (S), (CI), (G), (C), (I), (Q) and (V) in the margin by the appropriate step.
- e. Provide the tended ship the test requirements and joints/components to be tested for recertification of FMA work prior to commencing work on the tended ship.

1.6.7 RMC/FMA Division Officer. Division Officers are responsible to:

- a. Supervise and direct QA program within work centers under their cognizance.
- b. Ensure divisional personnel understand the requirements for/of a CWP.
- c. Ensure all repair actions performed by their division conform to applicable specifications and any deviation from specifications is reported as a DFS for non-nuclear work or LAR for nuclear work.
- d. Ensure CMPOs are assigned, qualified and executing their duties for each work center handling or stowing controlled material.
- e. Ensure areas are designated and are appropriate for proper stowage of controlled material.
- f. Review the FWP as required in Part I, Chapter 2, paragraph 2.3.4 of this volume.
- g. Review each TWD as required in Part I, Chapter 2, Appendix E, of this volume.
- h. Conduct/monitor divisional and work center QA training.
- i. Obtain written permission from the QAO to downgrade LI Stock Program Material or NRP for non-level use.

1.6.8 RMC/FMA Work Center Supervisor. Work Center Supervisors are responsible to:

- a. Ensure controlled and non-controlled material to be installed is correct per plan, drawing or other specification.
- b. Review each TWD for the work center as required in Part I, Chapter 2, Appendix E, of this volume.
- c. Review the FWP as required in Part I, Chapter 2, paragraph 2.3.4 of this volume.
- d. Supervise QA programs within assigned work centers.
- e. Review work for satisfactory completion.
- f. Ensure CWPs for completed controlled work are complete, properly reviewed and forwarded with all certifying documents, when work is completed.
- g. Ensure work center personnel are properly trained and qualified, if required, prior to assignment to tasks requiring QA and/or special cleanliness (e.g., oxygen, hydrogen, reactor plant, steam plant) certifications.
- h. Ensure all personnel use only TMDE (i.e., measuring devices, instruments, inspection tools, gauges, jigs or fixtures), which have current calibration stickers/records attached or available, for production, acceptance and testing. Uncalibrated/untested TMDE will be tagged and removed from service immediately.
- i. Prepare DFS or LAR for non-conforming conditions found or caused by the work center, sign, and forward to QAO.

1.6.9 RMC/FMA Craftsman. Craftsman is responsible to:

- a. Perform all maintenance actions in accordance with the FWP. If that guidance is either incorrect, incomplete or unclear, **stop** and seek clarification from the work center or shift supervisor.
- b. Ensure QA forms associated with the maintenance are correctly completed as required by the applicable sections of this volume.
- c. Enter signature, printed name and date on all QA data forms completed.

- d. Ensure only TMDE (i.e., measuring devices, instruments, inspection tools, gauges, jigs or fixtures), which has current calibration stickers/records attached or available, is used for production, acceptance and testing. Uncalibrated/untested TMDE will be tagged and removed from service immediately.

1.6.10 RMC Quality Assurance Department Head (Code 130) or Industry Management Department (Code 400 at Puget Sound Naval Shipyard and Intermediate Maintenance Facility). (For NAVSEA managed RMCs) These departments are responsible to:

- a. Implement a QA program in accordance with this volume that ensures all work accomplished by the Production/Repair Department meets the material and workmanship requirements of approved plans and specifications.
- b. Provides liaison with other department heads when their functions are directly or indirectly related to the QA requirements of the Production/Repair Department.
- c. Provide the Commander/Commanding Officer with a semi-annual evaluation of the overall adequacy and effectiveness of the RMC's QA program.
- d. Verify the RMC/FMA has an effective audit and surveillance program capable of assessing work performance and identifying areas of poor performance.
- e. Maintain sufficient number of qualified personnel to adequately staff the QA Department.
- f. Designate nuclear/non-nuclear Metallographic Test Method Examiner and Generic Material Alloy Identification Examiners (as applicable) (Code 130 responsibility at Puget Sound Naval Shipyard and Intermediate Maintenance Facility).
- g. Ensure fact-finding/critiques (as applicable) are held to establish underlying causes and pursue corrective actions when major errors, mistakes or problems occur during maintenance, or result in serious damage to equipment or injury to personnel. Notify Commander Navy Regional Maintenance Center of critiques and trouble reports in accordance with reference (n).
- h. Assign a qualified Quality Assurance Officer to the Code 133 division (RMC) or Code 450 (Puget Sound Naval Shipyard and Intermediate Maintenance Facility).

1.6.11 RMC Code 133 Division Head/FMA Quality Assurance Officer. Code 133/QAO is responsible to:

- a. Organize and implement a QA program within the RMC/FMA to carry out provisions of this volume.
- b. Provide guidance and evaluate efforts to produce work of acceptable standards.
- c. Prepare QA procedures, where necessary, to implement the provisions of this volume.
- d. Assist the TYCOM/ISIC as requested in performing QA audits on tended ships.
- e. Assist the TYCOM/ISIC as requested in providing indoctrination training on the QA program to the Engineer Officers and QAOs of assigned ships. Provide QA training for tended ship's personnel qualifying as CMPO/CMH, QAS and QAI.
- f. Approve downgrading of controlled material.
- g. Determine suitability for use of controlled material received from one ship, for use on another ship, when the transfer is via an RMC/FMA work center.
- h. Provide disposition instructions for rejected material.
- i. Institute a formal qualification program for QA personnel.
- j. Train and qualify work center CMPOs/CMHs. Inform the appropriate Division Officer and the Production/Repair Officer in writing of those qualified and any changes.
- k. QAO will review FMA generated DFS for accuracy and technical merit, sign and forward to the Repair Officer. At an RMC, this function will be the responsibility of the NAVSEA Technical Authority Warrant Holder in Engineering Department.

- l. Obtain chemical analysis, NDT and destructive testing required to upgrade or certify material for nuclear and non-nuclear applications for both the RMC/FMA and tended ships.
- m. Establish and coordinate RMC/FMA procedures for material control as delineated in this volume.
- n. Review, open and close out TWDs as required in Part I, Chapter 2, Appendix E, TWD Review and Approval matrix of this volume. Establish positive controls to ensure that repairs which are not in conformance with specification are not accepted without an approved DFS for non-nuclear systems or LAR for nuclear systems.
- o. Review the FWP as required in Part I, Chapter 2, paragraph 2.3.4 of this volume.
- p. (Submarines only) Review and sign RPWAR.
- q. Develop a QA training program, in conjunction with the Training Officer, which includes training for personnel who perform, plan and/or supervise controlled work.
 - (1) Supervise training and qualification of:
 - (a) QAS.
 - (b) QAIs.
 - (c) CMPOs/CMHs.
 - (d) Cleanliness Inspectors/Certifiers.
 - (2) Review and evaluate training of all personnel performing controlled work. Ensure that the continuing training is in sufficient detail and depth to provide effective training in all topics and areas specified in Part I, Chapter 3 of this volume.
- r. Maintain a current master list of qualified QASs (if assigned), QAIs, CMPOs/CMHs, Cleanliness Inspectors, Oxygen Clean Workers and Oxygen Clean Instructors as specified in Part I, Chapter 10 of this volume.
- s. Establish and administer a comprehensive RMC/FMA QA audit and surveillance program capable of assessing the work performance, training and qualifications and identifying areas of poor performance. Enlist the assistance of other repair department officers and senior enlisted personnel for audits and surveillance in the repair and supply departments.
 - (1) Prepare and update a written surveillance and annual audit schedule.
 - (2) Provide the Quality Assurance Department Head (for RMC) and Commander/Commanding Officer (for FMA) with a semi-annual evaluation of the overall adequacy and effectiveness of the RMC's/FMA's QA program.
- t. Ensure record files are maintained for CWP, controlled material, audits, surveillance, audit deficiency corrections, qualifications and training.
- u. Ensure all testing required for completion of TWD is complete and reviewed prior to the tended ship reactor plant startup, propulsion plant startup, or getting underway or a DFS for non-nuclear systems or LAR for nuclear systems has been submitted and approved.
- v. Perform opening reviews of CWP as assigned to assure OQE generated will support work recertification. Perform closing reviews of CWP as assigned to assure technical accuracy and satisfactory OQE exists for record history.
- w. Supervise QASs, QAIs, Cleanliness Inspectors/Certifiers, CMPOs/CMHs and other personnel, involved in controlled work, in the performance of their QA duties.
- x. Conduct QA audits, surveillance and coordinate corrective actions to ensure compliance with specifications.
- y. Maintain QA records and files, which includes completed CWPs including radiography film (if radiography used for acceptance of work), controlled material records (e.g., QA form 1, certification papers received with the material), training and qualification, etc.

1.6.12 RMC/FMA Assistant Quality Assurance Officer. AQAO is responsible to perform duties as assigned by the QAO.

1.6.13 RMC/FMA Quality Assurance Supervisor. QAS is responsible to:

- a. Ensure all testing required for completion of CWP is complete and reviewed prior to the tended ship reactor plant startup, propulsion plant startup, or getting underway or a DFS for non-nuclear systems or LAR for nuclear systems has been submitted and approved.
- b. Perform opening reviews of CWP as assigned to assure OQE generated will support work recertification. Perform closing reviews of CWP as assigned to assure technical accuracy and satisfactory OQE exists for record history.
- c. Train and supervise QAIs, Cleanliness Inspectors/Certifiers, CMPOs/CMHs and other personnel, involved in controlled work, in the performance of their QA duties.
- d. Conduct QA audits, surveillance and coordinate corrective actions to ensure compliance with specifications.
- e. Maintain QA records and files including completed CWPs (including radiography film if radiography used for acceptance of work), controlled material records (e.g., QA form 1, certification papers received with the material), training and qualification, etc.
- f. Review DFS for accuracy and technical merit and forward to QAO (FMA only).

1.6.14 RMC/FMA Quality Assurance Inspector. QAIs are responsible to:

- a. Review steps in CWP which require QAI signatures to verify all requirements are adequately addressed.
- b. Ensure all work inspected meets the requirements set forth in the latest applicable plans, specifications and directives of higher authority as stated in the CWP.
- c. Perform QA inspections of certification attributes.
- d. Verify permanent markings on controlled material are properly transferred and new material control tags are affixed.
- e. Ensure all personnel use only TMDE (i.e., measuring devices, instruments, inspection tools, gauges, jigs or fixtures), which have current calibration stickers/records attached or available, for production, acceptance and testing. Uncalibrated/untested TMDE will be tagged and removed from service immediately.
- f. Sign QA form 2 as controlled material is correctly installed for SUBSAFE, SOC and nuclear systems.
- g. Witness and verify testing and inspections. Promptly inform supervisors of unsatisfactory test results.
- h. Ensure all test results are completed, properly documented and the QA forms are returned to the CWP except for those specifically designated as work center records.
- i. Review DFS for accuracy and technical merit and forward to QAO.

1.6.15 RMC/FMA Controlled Material Petty Officer/Controlled Material Handler. CMPO/CMHs are responsible to:

- a. Receipt inspect all controlled material received by their work center/division.
- b. Ensure all material under their cognizance is stored and controlled to the governing material control requirements.
- c. Inspect controlled material storage areas of their work center semi-annually, as a minimum, in accordance with Part I, Chapter 6 of this volume.
- d. Ensure controlled material is properly stowed and handled so the identification of the subject material and its certification are always maintained.
- e. Reject unsatisfactory material. Fill out and attach QA form 3 and request disposition instructions.

- f. Send any material certification documents for material which has been provided by a ship along with the QA form 1 to the QA office. Ship shall retain originals when the material has been issued for installation.
- g. Receipt inspect package alteration kits that contain controlled material when ready for use.
- h. Remove QA form 3 from previously rejected and now accepted controlled material, annotate the material acceptance on the QA form 2 and file the QA form 3 with the CWP.
- i. Retain custody of controlled material when it is not in the custody of a craftsman or in a controlled material storage area.
- j. Ensure controlled material markings are on all pieces when cutting a smaller piece from a large one.
- k. Ensure controlled material markings are moved to an unaffected area, if the controlled material item will lose the markings due to a fabrication process (e.g., welding, machining) prior to the fabrication process.

1.6.16 RMC/FMA Cleanliness Inspector/Certifier. Cleanliness Inspectors/Certifiers are responsible to perform initial, in process and final cleanliness inspections during maintenance/repairs for those systems requiring cleanliness controls per Part I, Chapter 5, paragraph 5.4 of this volume.

NOTE: THE FOLLOWING DUTIES WILL BE ACCOMPLISHED BY THE COMMAND EXAMINER OR THE DIVISION OFFICER. WHEN ACCOMPLISHED BY THE DIVISION OFFICER, A COMMAND EXAMINER IS NOT REQUIRED.

1.6.17 RMC/FMA Command Examiner. The Command Nondestructive Test (NDT) Examiner shall be appointed in writing by the Commander/Commanding Officer and shall be responsible for all aspects of the Command's Nondestructive testing program. The Command NDT Examiner will perform the responsibilities of the NDT Examiner per paragraph 1.6.17 of this chapter when a single Examiner is assigned to the RMC/FMA. The following shall comprise the core responsibilities of the FMA Command NDT Examiner:

- a. Coordinate the efforts of other assigned NDT Examiners at the activity.
- b. Act as the Command's point of contact for NDT technical issues. In addition, act as the Command's point of contact with NAVSEA for NDT issues.
- c. Develop the Command's NDT Examiner guidelines, to include the Command's Written Practice for NDT certification when required by reference (i) utilizing the input of all participating NDT examiners.
- d. Ensure submittal of required reports of certification or recertification to higher authority as required by reference (h).
- e. Review all requests for NDT training courses and examiner certification services. Provide recommendations to the chain of command regarding eligibility of the requestor and the need for such training or certification based on current and projected NDT personnel resources.

1.6.18 Nondestructive Test Division Officer. RMC/FMA NDT Examiner is responsible to:

- a. Approve examination material for all NDT methods utilized at the activity for which they are certified. Ensure examination material reflects changes made to applicable fabrication documents.
- b. Approve and qualify NDT procedures for each method utilized at the activity. Revise and approve procedures as necessary when changes are made to applicable fabrication documents.
- c. Schedule and perform NDT Inspector surveillance. Maintain records of surveillance in order to perform trend analysis of inspector abilities and program effectiveness.
- d. Schedule and administer NDT examinations. Maintain records of examinations sufficient to trace inspector qualifications to original examination material. Maintain a matrix of high miss questions in order to assess inspector knowledge and program effectiveness.
- e. Train, certify and monitor NDT Inspectors as required by applicable specifications and Part I, Chapter 3 paragraph 3.2.2 of this volume.

- f. Schedule eye examinations for NDT Inspectors.
- g. Ensure each NDT Inspector's service record is kept updated with qualification status.
- h. Maintain individual records of qualification for NDT inspectors.
- i. Monitor the welder/brazer qualification and training per reference (k).
- j. Review all welder/brazer records for completeness semi-annually. This review may be performed by the welding engineers at Trident Refit Facilities (TRF).
- k. Review completed NDT inspection reports for technical completeness and accuracy and sign, where indicated on the report on completion of work.
- l. Review, approve and monitor the commands' welder/brazer training and qualification program as required by reference (k).
- m. Prepare and execute the training and qualification program for each NDT method that leads to inspector certification in each method and maintains inspector competency in each method.
- n. Ensure submittal of required reports of certification or recertification to higher authority as required by reference (h).

1.6.19 RMC/FMA Nondestructive Test Inspector. NDT Inspectors are responsible to:

- a. Verify CWPs which include NDT inspections properly identify the inspection requirements and acceptance criteria.
- b. Ensure NDT inspections are completed correctly and in accordance with the applicable requirement and inspection reports are technically complete and accurate.
- c. Ensure use of only TMDE (i.e., measuring devices, instruments, inspection tools, gauges, jigs or fixtures), which have current calibration stickers/records attached or available, for production, acceptance and testing. Uncalibrated/untested TMDE will be tagged and removed from service immediately.
- d. Sign QA form 2 as controlled material is correctly installed.

1.7 OTHER ACTIVITY RESPONSIBILITIES. Activities other than RMC/FMAs will conform to the requirements of this volume through a formal MOA, as defined in Volume II, Part I of this manual, with the ISIC while conducting maintenance on fleet activities. This includes work performed by naval shipyards, government agents, civilian contractors and other activities not specifically mentioned in other sections of this instruction.

- a. Ship's Force is ultimately responsible for all work accomplished on board their ship.
- b. Ship's Force is responsible for the development of TWDs for use in technical assist visits.
- c. In some cases, technical assists may provide troubleshooting services or complete equipment changes. Technical representatives are expected to utilize approved QA procedures or observe the requirements of this manual. The contractor or representative shall be able to explain what controls he/she will place on a given job, including testing and documentation to be provided for OQE.
- d. Technical support agencies and contracted organizations may not perform work inside the SUBSAFE boundary. Only activities that are listed in reference (m) are authorized to perform SUBSAFE work. In cases where RMCs or other activities are assisting on maintenance inside the SUBSAFE, DSS-SOC and FBW boundary, paragraph 1.7.a and 1.7.b of this chapter will be strictly adhered to.
- e. Product Quality Deficiency Reporting shall be in accordance with reference (j), with the exception of Aircraft Launch and Recovery Equipment. Quality Deficiency Reporting associated with Aircraft Launch and Recovery Equipment is addressed in reference (o).

(This Page Intentionally Left Blank)

**APPENDIX A
FORMAT FOR SUBMARINE QA PRE-UNDERWAY CHECKLIST**

SSGN/SSBN/SSN _____		Date _____	
URO Review (*with ISIC) (48-24 Hours Prior to Underway)			
(init)			
	All URO Data for UROs done for periodicity received and reviewed, AWR turned in and signed as complete.		
	No URO will become due prior to next scheduled INPORT period with the exception of a scheduled URO-22 rise blow.		
	Plan approved to complete UROs due next INPORT/availability/underway (e.g. URO 022 rise blow).		
	* URO Schedules and Inventories are up to date.		
	Retests to certify URO parameter due to maintenance reviewed by QAO/Department Head.		
	* Latest URO MRC Change on hand and verified current. Latest Change _____.		
	* Review SUBMEPP URO/HIPs website and or the Schedules and Inventories to verify no URO/HIPs (as applicable) are due or will become due prior to return to port (This review is to be completed by the URO/PMR Coordinator and ISIC QAO).		
Other Reviews (48-24 Hours Prior to Underway)			
	REC Exception Binder updated for work performed this availability.		
	No CAT "A" A&I will become overdue prior to start of next availability or those that will become overdue have been adjudicated via an approved departure.		
	No underway limiting OSARs exist or any underway limiting OSAR has been adjudicated via an approved DFS.		
	No outstanding Audit/Assessment/Survey ICARS (CAT 1) exist _____. No overdue AS&E responses due. Next report of corrective actions due: _____.		
	DEI date_____, next DEI due date (18 months) _____ (DFS_____), Major Deficiencies corrected or not due (30 days and No RBOs).		
QA-11 Log Review (Within 24 Hours of Underway)			
	FMA QA-11 Log Closed		Ship's QA-11 Log Closed Out
			DDS QA-11 Log Received and Closed Out
Custody Transfers (Within 24 Hours of Underway)			
	DDS Custody Transfer Msg/letter Received/Issued.		
	Copy of DDS Continuity Message/Letter received following installation/removal received and reviewed.		

DFS Review (includes waiver and deviations) (Within 24 Hours of Underway)							
No active DFS will expire prior to start of next scheduled availability (except AT-SEA TESTING).							
All SUBSAFE/SOC/FBW-SCS AT-SEA TESTING departures verified against Continuity Letter.							
Ship has completed DFS to JCN audit.							
All identified non-conformances adjudicated (no outstanding DFS awaiting approval).							
After a Scheduled Availability verify all AWRs marked SUBSAFE/SOC/FBW-SCS are cleared or adjudicated on a DFS by review of RMAIS.							
Continuity Letters /Certification/Completion Letter Separate letters required from each activity performing SS, SOC, FBW-SCS SFCC work on ship system. For DDS installation/removal (only), Ship's Continuity Letter issued as USER and Sustaining Activity.							
	Lead NSA CERT (PHNSY/PSNS/PNSY/ NNSY)		EB/SOSG (SS/FBW)		NGNN/SOSN (SS/FBW)		OII/NWCCD (SS/FBW)
	Lead FMA/RMC		EB/SOSG (SOC)		NGNN/SOSN (SOC)		OII/NWCCD (SOC)
	FMA/RMC				Ship (SS/FBW) Continuity letter		Ship (SOC) Continuity letter

Blue text can be tailored to list the regional activities

VOLUME V
PART I
CHAPTER 2
QUALITY MAINTENANCE PROCESSES

REFERENCES.

- (a) OPNAVINST C9210.2 - Engineering Department Manual for Naval Nuclear Propulsion Plants
- (b) NAVSEA 389-0153 - Radiological Controls
- (c) NAVSEA S9213-33-MMA-000 - Radiological Controls for Ships
- (d) NAVAIR AD-700A1-MDB-000 - Recovery Assistance Traversing (RAST) System
- (e) NAVSEA T9044-AD-MAN-010 - Requirements Manual for Submarine Fly-By-Wire Ship Control Systems
- (f) NAVSEA S0300-B2-MAN-010 - Supervisor of Shipbuilding, Conversion and Repair Operations Manual
- (g) NAVSEA 389-0317 - Procedures for Maintenance and Repairs to Naval Reactor Plants
- (h) NAVSEA 0387-LP-046-8000 - System Hydrostatic Test Requirements
- (i) NAVSEA 0924-062-0010 - Submarine Safety (SUBSAFE) Requirements Manual
- (j) NAVSEA S9074-AR-GIB-010/278 - Requirements for Fabrication Welding and Inspection, and Casting Inspection and Repair for Machinery, Piping and Pressure Vessels
- (k) NAVSEA 0900-LP-001-7000 - Fabrication and Inspection of Brazed Piping Systems
- (l) NAVSEA S9086-CH-STM-010 - NSTM Chapter 074 V1 (Welding and Allied Processes)
- (m) NAVSEA S9AA0-AB-GOS-010 - General Specifications for Overhaul of Surface Ships (GSO) 1983 Edition
- (n) NAVSEA T9074-AD-GIB-010/1688 - Requirements for Fabrication, Welding and Inspection of Submarine Structure
- (o) NAVSEA S9086-T4-STM-010 - NSTM Chapter 589 (Cranes)
- (p) NAVSEA SS800-AG-MAN-010/P-9290 - System Certification Procedures and Criteria Manual for Deep Submergence Systems
- (q) NAVSEA SS521-AA-MAN-010 - U.S. Navy Diving and Manned Hyperbaric Systems Safety Certification Manual
- (r) COMSUBLANT/COMSUBPACINST 6470.5 - Submarine Radiation Health Manual
- (s) NAVSEAINST 9210.23 - Naval Nuclear Work at Naval Activities and Private Shipyards - Certification of Work Accomplishment and Data Retention of Associated Records and Retention of Design Records - Requirements for
- (t) NAVSEA 0989-LP-058-1000 - Tender Nuclear Support Facilities Preventive Maintenance Index
- (u) NAVSEA 0989-064-3000 - Cleanliness Requirements for Naval Nuclear Plant Maintenance and Construction
- (v) MIL-STD-2041 - Control of Detrimental Materials
- (w) NAVSEA 250-1500-1 - Welding Standard
- (x) NAVSEA 392-0755 - Seal Weld Manual (Nuclear)
- (y) NAVSEA 389-0288 - Radiological Controls
- (z) MIL-STD-1627 - Bending of Pipe or Tube for Ship Piping Systems
- (aa) NAVSEA 0348-LP-159-0000 - Freeze Sealing Manual (Nuclear)
- (ab) NAVSEA 0989-LP-037-2000 - Commissioned Submarine General Reactor Plant Overhaul and Repair Specification
- (ac) NAVSEA 0989-LP-043-0000 - Commissioned Surface Ship General Reactor Plant Overhaul and Repair Specification
- (ad) NAVSEA 0989-LP-040-6000 - Air Flask Inspection and Maintenance Requirements (Nuclear)
- (ae) NAVSEA T9074-AS-GIB-010/271 - Requirements for Nondestructive Testing Methods
- (af) MIL-STD-2132 - Nondestructive Testing Examination Requirements

LISTING OF APPENDICES.

- A Technical Work Document Illustration
- B Work Package Decision Process
- C Certification Signature Requirements for Reactor Plant/Nuclear Support Facility/Controlled Industrial Facility Work
- D Formal Work Package Approval/Revision Sheet
- E Technical Work Document Review and Approval Matrix

2.1 PURPOSE. To provide the requirements for generating work procedures that will provide the craftsman with clear, concise, and technically correct instructions to complete the maintenance task while conforming to technical specifications. The work instructions will vary in complexity depending on the type of work to be performed, the amount of existing guidance available, the extent of preparation and system restoration required, and the technical ability of the craftsman.

2.2 TECHNICAL WORK DOCUMENTS. Technical Work Documents (TWD) consist of three general types: Maintenance Procedures (MP), Formal Work Packages (FWP) and Controlled Work Packages (CWP). Refer to Appendices A and B to determine which type of TWD is required.

2.2.1 Minimum Requirements for using Technical Work Documents.

- a. Nuclear Propulsion plant maintenance as defined in reference (a).
- b. Repair or troubleshooting to Fleet Maintenance Activity (FMA) Nuclear Support Facility systems or components.
- c. Radioactive repair work as discussed in references (b) and (c). Major work accomplished in reactor compartments or high radiation areas as required by references (b) and (c).
- d. Manufacture and corrective maintenance of electrical/electronic nuclear support and test equipment (e.g., switchgear test equipment, scram breaker time response equipment).
- e. Propeller/propulsor replacement or repair.
- f. Any Freon systems including self-contained units when the gas path is penetrated.
- g. FMA work on tended ship's systems.
- h. Level I/Submarine Safety (SUBSAFE) system work.
- i. Tests for FMA non-nuclear controlled work, which requires hydrostatic testing for recertification.
- j. All flammable liquid shipboard systems.
- k. Electric motor rewind.
- l. (Submarines only) Repair of Masts and Antennas.
- m. Other Ship's Force repair or troubleshooting as determined by the Department Head.
- n. Troubleshoot and repair of Gas Turbines when:
 - (1) Repairs affect the gas path.
 - (2) Removal, repair and/or replacement of accessory gearbox and components.
 - (3) Repairs to bleed air piping.
- o. Troubleshoot and repair of Main Propulsion Turbines/Generator Turbines.
- p. Troubleshoot and repair of Propulsion and Generator Lube Oil systems.
- q. Troubleshoot and repair of Propulsion and Generator Reduction Gearing/Drive Train Assemblies.
- r. Troubleshoot and repair of Auxiliary Turbines and pumps in which disassembly is required.
- s. Troubleshoot and repair of Boilers, Diesel Engines and their support systems.
- t. Any work within the Scope of Certification boundary.

- u. Troubleshoot and repair to submarine towed array handling systems.
- v. Welding and brazing requiring a CWP per paragraph 2.2.4 of this chapter.
- w. Maintenance on Weight Handling Equipment.
- x. Maintenance on Recovery Assist, Securing and Traversing systems, per reference (d).
- y. Maintenance performed which invokes MIL-STD 1330 or MIL-STD 1622 cleanliness standards.
- z. Maintenance on Fly-By-Wire Ship Control Systems, per reference (e).
- aa. Steering Gear Systems
- ab. (Submarines only) Special Valves
- ac. (SSBN only) Troubleshooting and repair of Missile Gas, Missile Hydraulic and Missile Tube systems that remove the ability to inert and jettison the tube contents.

NOTE: THE HEX PLUGS (MS PLUGS) DISCUSSED IN THESE PARAGRAPHS ARE NOT EQUIVALENT TO THE MS PLUGS DESCRIBED IN TABLE 5-1, RE-ENTRY CONTROL EXCEPTIONS OF CHAPTER I-5 OF THIS VOLUME. THE FOLLOWING PARAGRAPHS REFER TO TABLE 2-1 BELOW.

Table 2-1 Types of PTS/TPS Fittings			
Style	Description	Ship/Class	Drawing/Specification
Style 1	Rectangular block assembly	SSN 688 Class	NGNN 2300-818
Style 2	Integral assembly or TRIDENT style fitting	SSBN 726 Class SSN 774 Class	NAVSEA 845-4687601
Style 3	Threaded boss assembly or Shroeder test fitting	SSN 21 Class SSN 774 Class	MIL-V-24695
Pressure Test Stations (PTS) and Test Pressure Stations (TPS) in the SUBSAFE boundary refer to components of different design that perform a similar function.			

- (1) Style 1 and 2 PTSs and TPSs hex plugs form part of the secondary pressure boundary and serve as contaminant protection. Removal and reinstallation of the hex plug requires a TWD but does not require Re-Entry Controls or controlled assembly. The TWD shall verify that seat leakage criteria and seating surface and hex plug inspections are performed in accordance with applicable technical specifications.
- (2) Re-Entry Controls are not required when operating Style 1 or 2 PTSs or TPSs associated needle valves in accordance with normal operating procedures identified in Ship Safety Manuals, Steam and Electric Plant Manuals or other NAVSEA-approved procedures. If a ship's operating procedure is unavailable, a locally prepared FWP will be generated to operate the valve.
- (3) Style 3 PTSs and TPSs have a Delrin cap. Removal and reinstallation of the Delrin cap requires a TWD but does not require Re-Entry Controls or controlled assembly. The TWD shall verify that seat leakage criteria and seating surface and Delrin cap inspections are performed in accordance with applicable technical specifications.
- (4) Any disassembly for major or minor repair of Style 1, 2 or 3 PTSs or TPSs requires a SUBSAFE Re-Entry Control CWP.

2.2.2 Maintenance Procedure. MPs may be fully usable in their existing form. The minimum requirements to perform any work are a valid MP and permission to perform maintenance.

- a. (Submarines only) If an approved NAVSEA Maintenance Standard (MS) is invoked to perform an emergent repair and there is no intention to reset the maintenance interval, then the MS can be used as a guide to the extent necessary to perform repair. Parts removed can be inspected in accordance with the MS. Inspection criteria for parts not addressed by the MS (e.g., those parts identified as mandatory

replacement parts) shall be inspected in accordance with general acceptance criteria or the system drawing or the component technical manual. Additionally, the torque, lubrication, and test criteria cited in the MS may provide revised values which differ from NAVSEA drawings and/or component technical manuals.

- b. The following are examples of existing MPs:
 - (1) Planned Maintenance System Maintenance Requirement Cards.
 - (2) MSs.
 - (3) Ship Systems Manuals.
 - (4) Component Technical Manuals.
 - (5) Shipyard Process Instructions.
 - (6) Ship Alteration Instructions.
 - (7) Reactor Plant Manual Operating Procedures, Operating Instructions, Maintenance and Replacement Instructions, and Reactor Maintenance Requirement Page.
 - (8) Alteration and Improvement Instructions.
 - (9) Naval Sea Systems Command (NAVSEA) Drawings which include disassembly/reassembly instructions.
 - (10) Shipyard Task Group Instructions (TGI).
 - (11) Steam and Electric Plant Manual.
 - (12) (Surface Force ships only) Reference (f) Appendix 4E specifications.

2.2.3 Formal Work Package. An FWP coordinates in a single document materials required, initial conditions, MP, test and inspections, and system restoration for the selected maintenance task. In some instances, the maintenance task will not have an existing MP. This will require the activity to develop an FWP in order to ensure first time quality accomplishment of the maintenance task. FWPs should be only as detailed as required by the complexity of the work, craftsman knowledge, technical requirements, extent of tests, and level of worker supervision required (see Appendix B).

2.2.4 Controlled Work Package. A CWP is required when higher authority requires a record (Objective Quality Evidence (OQE)) of repairs/maintenance for fabrication, repair, installation, inspection and testing process for specific systems/components, such as Level I, SUBSAFE, Submarine Flight Critical Components (SFCC) or nuclear. CWPs may be necessary when required by the level of work control of the system (nuclear, SUBSAFE, SFCC and Level I) or when other extensive and formal Quality Assurance (QA) or test requirements exist (weight test, crane repairs, etc.). In its simplest form a CWP will consist of, as a minimum, a MP and the required QA forms. Examples of required CWPs:

- a. Level I.
 - (1) Manufacture, installation, and repair of Level I components/systems except for the following actions, which may be controlled with TWDs other than CWPs.
 - (a) Software replacement (e.g., O-rings, packing glands, body to bonnet gaskets, silver seal replacements).
 - (b) Inspections to support routine maintenance programs or troubleshooting.
 - (c) Replacement of any non-pressure boundary parts which are non-Material Identification and Control (MIC) level pieces.
 - (2) Repair by welding, brazing, machining, lapping or manufacture of Level I fittings or components.
- b. Reactor Plant/Nuclear Support Facility/Controlled Industrial Facility.

- (1) Manufacture, installation, and repair of nuclear Level I systems and components. The following actions may be controlled with TWDs other than CWP provided all assembly procedures and inspections (Quality Assurance Inspector (QAI)) requirements specified in reference (g) are delineated in the procedure section of the FWP:
 - (a) Software replacement (e.g., O-rings, packing, body to bonnet gaskets, silver seal replacements).
 - (b) Inspections to support routine maintenance programs or troubleshooting.
 - (c) Replacement of any non-pressure boundary parts which are non-Material Identification and Control (MIC) level pieces.
 - (2) Hydrostatic testing as required by reference (h) to certify reactor plant work conducted.
 - (3) Welding and Nondestructive Testing (NDT) which provides OQE of the integrity of reactor plant piping, and structural welding.
 - (4) Work affecting the integrity of permanent shielding installations.
 - (5) Work affecting reactor plant brazed joints that are inaccessible during reactor operations.
 - (6) Manufacture and corrective maintenance of mechanical nuclear support and test equipment whose configuration is specified by NAVSEA technical manuals or drawings (e.g., brittle fracture pressure limit rigs, nitrogen sparging rigs).
 - (7) Ship's Force retests of FMA or Ship's Force performed nuclear work that requires hydrostatic testing or an external pressure source to perform the test or retest, including Pre-Overhaul Tests except a CWP is NOT required for routine gage or instrument calibrations.
- c. Work within SUBSAFE/hull integrity boundary.
- (1) Work within SUBSAFE/hull integrity boundary, identified in reference (i), including:
 - (a) Submarine pressure hull grinding, cutting and welding.
 - (b) Adjustments that affect valve timing associated within the flood control system components and/or Unrestricted Operations Maintenance Requirement Card affected components to include cap removal/reinstallation of hydraulic variable restrictors.
 - (c) Pressure testing salvage air valves via the external connection.
 - (2) Any disassembly for major or minor repair of PTSs or TPSs in the SUBSAFE boundary.
- d. Welding/Brazing.
- (1) P-1, P-LT, P-3a Special Category/Critical Piping Systems repair, alteration and/or fabrication, by welding and brazing in accordance with reference (j) and reference (k). (Small self-contained freon units, such as ice cream machines, ice machines, etc., are excluded.)
 - (2) Pressure Vessel Class A-F, A-1, A-2, A-3, A-LT, M-1, T-1 repair, alteration and/or fabrication by welding and brazing in accordance with reference (j).
 - (3) Permanent repairs and alterations of the primary structure of surface ships, including ballistic plating and superstructure designed for blast loading. Records shall be made and retained for category "C" repairs as required by references (l) and (m).
 - (4) Welding on submarine hull and structures in accordance with reference (n) as listed below:
 - (a) Pressure hull envelope.
 - (b) Pressure hull structure.
 - (c) Support structure.
 - (d) Containment structure.
 - (e) Extended pressure hull structure.

- (f) Interface structure.
- e. Weight Handling Equipment Manufacture and Repair except for cranes.
- f. Corrective maintenance within the certified boundaries (envelope) of cranes as defined in reference (o).
- g. (Submarines only) Performance of Category “A” (Safety of Ship) Alterations and Improvements.
- h. Maintenance within SUBSAFE boundaries of submarine antennas and masts.
- i. Maintenance on Recovery Assist, Securing and Traversing systems per reference (d).
- j. Maintenance on systems requiring cleanliness controls as defined by MIL-STD 1330 or MIL-STD 1622 (e.g., diver’s air, oxygen, nitrogen, hydrogen, helium-oxygen). For MIL-STD 1622 applications, only systems defined as “critical” require a CWP for cleanliness controls. If repair or replacement of any component requires a record of OQE (pressure testing, new Level I (LI) or Scope of Certification (SOC) material, welding, etc.), a Re-Entry Control (REC) or CWP as appropriate is required. However, the following exceptions apply:
 - (1) A CWP is not required for inspections specified in MIL-STD 1330 during maintenance of cleanliness when performed by Type Commander or Ship’s Force personnel on systems and equipment not certified by reference (i), reference (p) or reference (q).
 - (2) A REC or CWP is not required for maintenance performed in accordance with an approved Planned Maintenance System Maintenance Requirement Card by Ship’s Force personnel that states that performance of the maintenance does not require REC.
 - (3) A CWP is not required for inspections on systems defined as “critical” as specified in MIL-STD-1622 during maintenance of cleanliness when performed by Type Commander or Ship’s Force personnel and the maintenance of cleanliness is authorized to be performed as a REC Exception in the applicable Deep Submergence Systems SOC Notebook.
- k. Maintenance within the SFCC Boundary, per reference (e).

2.2.5 Maintenance Certification Record/Controlled Work Package (Non-SUBSAFE). Various sea water system components require frequent entry into the system boundary for routine operations or maintenance actions in order to enable the ship to carry out its mission. Table 2-2 of this paragraph includes certain systems and equipment which require Level I work controls that are frequently entered but shall be exempt from Maintenance Certification Record (MCR)/CWP Controls. The operational requirements for these systems and equipment have been reviewed. Inherent operational controls in the present system are considered adequate and the below listed items are considered safe exceptions to the formalized MCR/CWP system. The operational control which is considered as meeting the intent of the MCR/CWP requirements is listed beside each item and must be in effect in order to use the exception.

NOTE: MCR EXCEPTIONS ARE FOR SHIP’S FORCE USE ONLY AND ARE NOT AUTHORIZED FOR USE BY REPAIR ACTIVITIES. REPAIR ACTIVITIES SHALL NOT REQUEST THE SHIP TO INVOKE A MCR/CWP EXCEPTION IN CONJUNCTION WITH REPAIR ACTIVITY WORK.

NOTE: MCR EXCEPTIONS ARE NOT AUTHORIZED TO BE USED FOR THE INSTALLATION OF NEW LEVEL I HARDWARE WITHIN THE LEVEL I BOUNDARY.

Table 2-2 Submarine Seawater MCR EXCEPTION ITEM (Non-SUBSAFE)

Submarine Seawater MCR EXCEPTION ITEM	OPERATIONAL CONTROL REQUIREMENT	RECERTIFICATION TESTING
Cleaning Shaft Seal Cooling Water strainers or filters	Controlled assembly (Notes 1 and 2)	None
Cleaning of Auxiliary Sea Water system strainers	Controlled assembly (Notes 1 and 2)	None

Table 2-2 Submarine Seawater MCR EXCEPTION ITEM (Non-SUBSAFE) (Cont'd)

Submarine Seawater MCR EXCEPTION ITEM	OPERATIONAL CONTROL	RECERTIFICATION
	REQUIREMENT	TESTING
Cleaning evaporator, distilling plant and Reverse Osmosis supply water strainers	Controlled assembly (Notes 1 and 2)	None
Shaft Seal Cooling Water Cyclone Separators	Controlled assembly (Notes 1 and 2)	None

Notes:

- (1) An FWP, in accordance with paragraph 2.2.3 of this chapter, will be used to control and document all work performed as a MCR exception.
- (2) Controlled assembly requirements are:
 - (a) Verification that surface finishes of gasket/o-ring sealing surfaces are in accordance with applicable specifications.
 - (b) Verification that fastener material and installation is in accordance with applicable specifications.
 - (c) Verification that gaskets/o-rings are properly installed and in accordance with applicable specifications.
 - (d) Assembly is documented on a QA form 34.
 - (e) Inspected by a QAI or Quality Assurance Supervisor (QAS).

NOTE: EXCEPTIONS FROM MCRs OTHER THAN THOSE LISTED ABOVE ARE NOT AUTHORIZED.

2.2.6 Sequencing Document. A sequencing document is used to tie two or more TWDs together when a single TWD is insufficient (as determined by the Department Head or Principal Assistant for Aircraft Carriers) to complete a maintenance task. If the Department Head (Principal Assistant for Aircraft Carriers) determines a single TWD is insufficient to complete the task, a sequencing document should be developed, which provides the craftsman with directions for going from one TWD to another. Normally, this sequencing document will be in outline format. The sequencing document will be approved as directed by the Department Head (Principal Assistant for Aircraft Carriers).

2.3 FORMAL WORK PACKAGE DEVELOPMENT.

2.3.1 Responsibility for Preparation of Formal Work Packages/Controlled Work Packages.

- a. For Ship's Force work processes, the FWP/CWP is prepared by the work center responsible for accomplishing the work.
- b. For submarines and aircraft carriers, the FWP/CWP is to be prepared by a qualified Maintenance Planner. The FWP/CWP may also be prepared by any member of the work center as long as it is reviewed by a qualified Maintenance Planner in that work center.
- c. For FMA work processes, the FWP/CWP is prepared by the appropriate planning division.

2.3.2 Security Classification. Attention must be paid to proper classification, handling, and marking of an FWP. As initially prepared, the FWP itself or as used in a CWP, is frequently unclassified and becomes classified as data is recorded. FWPs for nuclear propulsion plant systems are frequently CONFIDENTIAL, and almost always contain Naval Nuclear Propulsion Information and should be marked and controlled as required by the appropriate NAVSEA, Naval Operations (OPNAV), and Department of Energy Security instructions (e.g., NAVSEAINST 5510.45 Series, OPNAVINST N9210.3, OPNAVINST 5510.11 Series, CG-RN-1).

2.3.3 Formal Work Package Format. The FWP format below identifies elements that may be beneficial when writing an FWP. Asterisk (*) elements are required for all FWPs. This format is a general guide and each element may not be required depending on the task being performed.

- a. List of References.
- b. List of Enclosures.
- c. List of Effective Pages (LOEP).
- d. General Information.
- e. Material. *
- f. Responsibilities.
- g. Precautions.
- h. Budgeted Man-Rem (if required by the Radiation Health Manual).
- i. Initial Conditions (plant/system conditions, prerequisites including tagouts). *
- j. Procedure. *
- k. Test and Inspection. *
- l. System Restoration. *

2.3.3.1 Formal Work Package Elements Defined.

- a. List of References. All references used shall be listed in a manner which will allow positive identification of the references and will state the current revision and advance change notice when the FWP was prepared.
- b. List of Enclosures. Enclosures are any technical documents which are not readily available to the craftsman and are used to provide information, direct or document work, or direct contingency work. Each enclosure page will contain, as a minimum, the FWP (file) number, enclosure number, and enclosure sheet number for traceability purposes. Enclosures are not required to be listed as references. Examples of enclosures are:
 - (1) Diagrams, prints or applicable portions of technical manuals.
 - (2) Necessary QA forms (CWP only).
 - (3) Contingency repair (predictable event).
- c. LOEP. The LOEP is an accounting of every page, including enclosures that make up the FWP. Each time a change/revision adds, modifies, or deletes a page of the FWP, the LOEP sheet must also be revised. Original pages will be marked "-". Subsequent changes/revisions will reflect latest change/revision number.
- d. General Information. This section is used to provide useful information, clarifying remarks, and sequencing allowances.

NOTE: NATIONAL ITEM IDENTIFICATION NUMBER (NIIN) MAY BE USED WHENEVER NATIONAL STOCK NUMBER (NSN) IS CALLED FOR, INCLUDING ALL QA FORMS. THE NATIONAL ITEM IDENTIFICATION NUMBER UNIQUELY IDENTIFIES MATERIAL IN SUPPLY SYSTEM AND IS ADEQUATE FOR OQE PURPOSES.

- e. Materials Required (required element). This section is used to list all material, spare parts, and special tools required to accomplish the job. Material listed in this section should be verified on hand prior to starting work. A Job Material List may be attached as a supplement to the Material List. Lead Work Center (LWC) Supervisor/Division Officer may add materials after the FWP is open that does not constitute a revision per paragraph 2.3.7.3 of this chapter using a non-technical pen and ink change. Example of a line in the materials required list or table:

<u>Item Name</u>	<u>Size/Class/Type</u>	<u>Qty</u>	<u>Matl</u>	<u>MIL-SPEC</u>	<u>Level</u>	<u>PC#/REF</u>	<u>Step/End Use</u>	<u>NSN/NIIN</u>
Bolt	½ -13UNCx2½	6ea.	Cr-Mo	MIL-S-1222	Level I	12/E	H.3/ASW-504	

NOTE: THE RESPONSIBILITIES SECTION OF THE FWP IS MANDATORY IF MORE THAN ONE REPAIR ACTIVITY IS INVOLVED IN THE WORK.

- f. Responsibilities. List the general responsibilities of all involved ship's divisions or FMA Work Centers and tended ship personnel. Examples are:
- (1) "38N will establish and maintain freeze seals as specified in the Freeze Seal Agreement."
 - (2) "51A will provide motor rewind and balancing services."
- g. Precautions. List precautions for personnel and equipment protection that are specific to the job. Three examples of precautions are:
- (1) Personnel: Hazards (e.g., toxic or explosive mixtures), stressors (e.g., high noise levels, high heat operations), and protective requirements needed to ensure personnel safety.
 - (2) Equipment: Safeguards, protective equipment, operating restrictions necessary to prevent equipment damage.
 - (3) Prevention of the loss of cleanliness: Specific precautions to prevent the loss of cleanliness for the task being performed.
- h. Budgeted Man-Rem. In this section, establish the Man-Rem estimate for accomplishment of the task. (See reference (r) for submarines.
- i. Initial Conditions (required element). This section contains those prerequisites and plant conditions that must be completed prior to commencing the MP. Examples are: material certification, job briefings and actions required for safety precautions listed in the Precautions Section.
- (1) Prerequisites must be completed prior to starting the MP and include actions necessary to certify the material, conduct briefings and state safeguards taken against hazards identified in the Precautions Section. Production work, other than shop work will not be performed as a prerequisite. Examples of prerequisites:
 - (a) "EM01 or 38A: Record name plate data from component to be worked. Verify the FWP is consistent with the name plate data."
 - (b) "Division Officer/Leading Petty Officer (LPO)/Nuclear Repair Officer (NRO)/Radiological Control (RADCON) Officer: Conduct a pre-work briefing. Complete attendance sheet provided as Enclosure ()."
 - (2) List the initial plant/system conditions required to properly and safely accomplish the work to be done. This should include work boundaries which will be specified by the Ship/FMA depending on the job. The isolation boundaries will be determined and established by the duty officer/tagout authorizing officer prior to authorizing commencement of the maintenance (this includes the isolation valve lineup, power isolation, etc.). The extent of this section will vary depending upon the type of job.
 - (a) For a Ship's Force job, this section should identify work boundaries and plant/system conditions (e.g., Pressure/Temperature Band, cold iron). The duty officer/tagout authorizing officer will determine and set the isolation boundaries.
 - (b) For an FMA ship to shop job, this element is not applicable.
 - (c) For an FMA job on a tended ship, the FMA must determine the work boundaries and identify to the ship any plant conditions that must be maintained during the work. The ship will determine and set the isolation boundaries.

j. Procedure (required element). This section contains the instructions on how to accomplish the work. Concentrate on putting the steps of the job in proper sequence. Don't describe technically how to do a step (unless past experience has shown some of this type of information is required). The following steps describe how to write this section of the FWP:

(1) Outline the various steps necessary to accomplish the work to be done. Whenever there is a need to provide information, or caution the reader, write the word (NOTE or CAUTION) in capital letters followed by a colon and the text of the note or caution in ALL CAPITAL LETTERS. The NOTE or CAUTION is to appear immediately before the step or section it is applicable to. NOTES and CAUTIONS do not perform work, but are used as the first sentence(s) in a work step. Where NOTES and CAUTIONS are used in the same work step, the CAUTION will be specified first.

(a) CAUTIONS should only be used whenever a specific danger to personnel, equipment, or the potential for loss of cleanliness exists.

1 CAUTION: THE ANTI-SEIZE COMPOUND USED IN THIS STEP IS A HAZARDOUS MATERIAL AND REQUIRES SPLASH PROOF GOGGLES AND RUBBER GLOVES TO BE WORN WHILE HANDLING OPEN CONTAINER OR USING THE MATERIAL.

2 CAUTION: ENSURE CLEANLINESS PLUGS ARE STAGED FOR USE PRIOR TO BONNET REMOVAL.

(b) NOTES should inform the reader about key information, sequence allowance or direct him/her to additional information.

1 NOTE: STEPS 8, 9, AND 10 MAY BE PERFORMED IN ANY SEQUENCE.

2 NOTE: STEPS 1 THROUGH 4 MAY BE PERFORMED SIMULTANEOUSLY.

(2) Work Center Designations. This is not mandatory for Ship's Force work if a single Work Center is performing all steps contained in the FWP. Otherwise, each work step of the procedure shall have a Work Center (i.e., 31A, EM01, etc.) designated responsible for performing that step. A specific designation (e.g., NRO, Engineering Officer of the Watch, Engineering Duty Officer, LPO/LWC Supervisor, LPO) may be substituted for Work Center designations where appropriate. More than one Work Center Designation may be used where dual responsibilities are needed. Examples of Work Center Designations:

(a) "38A/93B: Perform a final disc-to-seat blue check. Verify that a satisfactory final seat-to-disc blue check has been performed."

(b) "38N: NOTE: SEE FIGURE [1] OF ENCLOSURE (3) FOR CANOPY JOINT INFORMATION AND LOCATION. Fit-up the upper and lower body-to-bonnet canopy joints."

(3) Symbols. The symbols below are located in the margin of the FWP and indicate the following:

(a) (R) = Steps requiring verification/inspection as defined in references (b) and (c).

(b) (S) = Steps in an FMA procedure requiring verification by a member of Ship's Force.

(c) (C) = Steps requiring Cleanliness Inspection by craftsman.

(d) (I) = Steps requiring inspection by a QAI or NDT Inspector.

(e) (CI) = Steps requiring independent Cleanliness Inspectors (SCI, RCI).

(f) (Q) = Critical Quality Control Points (Q-Point).

- (g) (V) = Steps requiring verification by a craftsman.
 - (h) (G) = Government notification required.
- (4) Signature Requirements in FWPs and CWPs. Certain steps require positive assurance that the step was actually performed and/or completed in a prescribed manner. Signatures are also required for assurance of critical requirements, critical measurements, or requirements for OQE. If the step requires completion of a data form (e.g., inspection, NDT record, hydrostatic test data sheet), the signature block shall be on the data form, not the procedure step. The following is a list of typical steps/examples requiring signatures:
- (a) Steps which require performance of QA checks or NDT that are documented on a QA form in order to provide traceability of signatures. Personnel who sign QA forms or other OQE documents will print their name along with their signature, badge number (where applicable) and date. These types of steps must include a statement of satisfactory compliance adjacent to the signature block in the associated QA form.
 - (b) Completion of a strength test.
 - (c) Hull and backup valve blue checks of seat and disc and stack height measurements.
 - (d) Completion of Controlled Assembly steps.
- (5) For nuclear work, Certification Signature Blocks are required where specifically called out in NAVSEA technical documents **as defined in Appendix C**.

NOTE:

WHEN INVOKING A MS WHEN OTHER THAN A COMPLETE COMPONENT OVERHAUL IS PLANNED, THE MS MAY BE USED AS A GUIDE. THERE IS NO NEED TO INVOKE THE ENTIRE MS FOR SPECIFIC REPAIRS: E.G., PUMP MECHANICAL SEAL REPLACEMENT NEED NOT INVOLVE COMPLETE BREAKDOWN AND INSPECTION OF THE PUMP.

- (6) Procedure Detail. The procedure should be used to list the various tasks to be performed and the sequence in which they should be accomplished. Notes on proven craftsmanship skill techniques that significantly aid in first-time quality and are not addressed in other reference documents should be included. A well-written procedure is designed for use by trained personnel who have a requisite level of knowledge about their specialty and the work to be performed. A procedure must have sufficient detail to allow a determination of exactly what was done, material used, inspections required, and allow re-certification of the system or component.
- (7) Sequencing of Work. As the work package is being prepared, the steps of the job should be placed in a logical and proper sequence. In instances where work can be performed in parallel, identify those steps by use of a sequencing note.
- (8) Q-Points. Work processes, regardless of type (maintenance, training, administrative, etc.), have critical execution points whose proper accomplishment overwhelmingly affects the ultimate first-time quality success of the process. Quality Maintenance Program work processes identify these crucial work process points as Q-Points. The below concepts apply to Q-Points:
 - (a) Q-Points in a work process are typically characterized by requiring high level skills, proficiency, strong knowledge, working within narrow tolerances, and/or difficult environmental conditions which mandate close supervision.
 - (b) Q-Points are determined by the organizational unit (Work Center, division, command, etc.) having cognizance over the specific work process.
 - (c) Maintenance managers shall give strong focus to Q-Points in work scheduling, personnel assignments, and appropriate supervision.
 - (d) Scheduling a Q-Point to occur late at night, with tired, fatigued personnel or with less than adequate supervision places the successful execution of that Q-Point at a great risk and compromises first-time quality completion of the work process.

- (e) Q-Points are annotated in FWP's whether the FWP is used as a stand alone or as the core of CWP. Not all FWP's will require the use of Q-Points. Q-Points are process control aids and do not require signatures.
- k. Tests and Inspections (required element). Only tests that are required to recertify the system or component after the repair work is complete will be listed in the test and inspection section of the FWP. Repair process tests, such as seat leakage tests or joint tightness tests performed in the shop, will be considered part of in process work and will be contained within the procedure section. If the testing results are required for OQE, then the necessary QA forms will be enclosures to the FWP.
 - (1) Ship to shop work. For FMA work on tended units where components are removed from the ship and repaired in the shop:
 - (a) All testing that can be performed in the shop will be performed in the shop by the FMA. The FMA will write and conduct all shop tests and inspections.
 - (b) The FMA will provide the tended unit with all required testing and inspection requirements and QA forms for the shipboard testing needed to certify the work performed by the FMA. The FMA work package will specify the joints/components that require testing and the type of test(s) required that the tended unit must perform. The tended unit will review the test requirements and is responsible for writing the test FWP and conducting the test(s). The original completed test documents will be provided to the FMA for inclusion in their work package (FWP/CWP) for re-certification.
 - (2) Careful planning and review prior to beginning work is needed to ensure all tests and inspections are identified before starting work. Various TWDs include tests and inspections required. Further guidance is also provided in Volume IV, Chapter 9 (System Test Check List) and Volume IV, Chapter 18 (Submarine Salvage Inspection) of this manual, and should be consulted when preparing and performing this section for the FWP.
 - (3) The range, serial numbers and calibration due date of any calibrated measuring and test equipment used for conducting the test must be documented on the QA form.
- l. System Restoration (required element). This section contains those steps necessary to restore the system to normal operating status.
- m. (Submarines only) Ship's Force test FWP's for non-shipyard associated FMAs nuclear work will be provided to the Immediate Superior In Command (ISIC) for review.

2.3.3.2 Use and Transcribing of Source Documents. Retyping/scanning extensive step-by-step procedures from source documents into FWP's is discouraged. Ideally, the procedure should reference the source document. A reproduced copy of the appropriate section may be included in the work package as an Enclosure. If the source document steps are not lengthy, they may be written directly into the procedure. When work is per a referenced procedure or enclosure, specify the precise steps of the reference or enclosure that are to be performed. The applicable portion of an enclosure to be used by the craftsman shall be marked or highlighted and portions not used will be marked out.

2.3.4 Formal Work Package Approval.

- a. FWP's developed for a job are routed and approved prior to the performance of the work. The appropriate work authorization and reference material, (including QA documents for CWP's), to conduct the FWP shall accompany this routing.
- b. Review of the FWP by the Chemical RADCON Assistant or Quality Assurance Officer (QAO) may be appropriate.
- c. For FMAs, the FWP is reviewed by the Planning Officer, LWC and Assist Work Centers. The FWP can be approved by the Repair Officer as the standard FWP for that work process.
- d. Approval signatures are made on the FWP approval sheet (see Appendix D). Signature blocks not required will be marked NA. Signature blocks that are signed will be accompanied by a legible printed name and date.

- e. For Ship's Force standardized FWP's the LPO/LWC supervisor shall verify that all references are current. For FMA Standardized FWP's the Planning Officer shall perform the verification. If changes are required, the FWP must be revised and routed for approval.
- f. For FWP's that are part of a CWP, see CWP approval matrix, Appendix E.
- g. QAO will review all FWP's for components or systems assembled as a controlled assembly and performed as a REC/MCR exception per Part I, Chapter 5, paragraph 5.10.7, Note 3, Part I, Chapter 2, paragraph 2.2.5, Note 2 and Part III, Chapter 5, paragraph 5.11.6.1.b of this volume. REC/MCR exceptions will be tracked using the REC/MCR Exception Controlled Assembly Log QA form 11A located in Part I, Chapter 11 of this volume.

2.3.5 Controlled Work Package Approval. When the FWP has been prepared, the following actions are required to prepare and approve the CWP:

- a. For controlled (i.e., Level I, Nuclear, Scope of Certification, SFCC) or SUBSAFE work to be performed by Ship's Force only, the ship's QAO will issue the CWP/REC numbers sequentially for entry in Block 4 of the ship's QA form 9. For controlled or SUBSAFE work performed by the repair activity on, or for a tended ship, the ship's QAO will issue CWP/REC numbers sequentially to the repair activity for entry in Block 4 of the repair activity's QA form 9. For controlled or SUBSAFE work to be performed by the repair activity only (in repair activity shops and the repair activity does not work onboard the ship, examples include ship to shop work; rotatable pool assets), the repair activity's QAO will issue the CWP/REC numbers sequentially for entry in Block 4 of the repair activity's QA form 9. The format of the CWP/REC serial numbers will be the serial number followed by the year (e.g., 1-90, 123-01).
- b. An MCR/REC (QA form 9), will be prepared by the planner or CWP preparer. A QA form 10 may be required as a supplement to the QA form 9.
- c. CWP approval is in accordance with Appendix E.

2.3.6 Formal Work Package In Process Use. The FWP/TWD will be at the job site during the performance of work. For multiple work sites, the FWP may be copied but all signatures and data will be recorded on the original/master FWP.

2.3.7 Formal Work Package Changes.

2.3.7.1 Pen and Ink Changes. Pen and ink changes to an FWP may be made for minor administrative changes that do not change the scope and/or intent of the FWP. Changes of this nature include additions or deletions of a Work Center assigned to a step, typographical/editorial errors, amplifying additional information to clarify a step, or a change in the sequence of steps.

- a. Pen and ink changes to an FWP will be made with the approval of the LPO/LWC Supervisor or Division Officer responsible for the affected step in the FWP.
- b. Pen and ink changes to the QA forms in a CWP shall be made with the approval of QAO, QAS or QAI. Examples are: Additions or deletions of Work Centers assigned on a QA form, correction of typographical or editorial errors on a QA form, addition of information to clarify a QA form.
- c. Pen and ink changes shall be accomplished by drawing a single line through the portion to be changed, and entering the necessary change adjacent to that portion. The person making the change will initial, date, and print the name of the approving authority for the change. If the change is per verbal direction, the name or title of the person authorizing the change will be annotated (per telcon with Division Officer, Repair Officer, etc.).
- d. Technical pen and ink changes are used to correct a technical error and must be approved by the department head. The same process will be used as in a non-technical pen and ink change except that it is documented in the "instructions for entering revision" area of the FWP revision sheet.

2.3.7.2 Rework Addendum. Rework is the unplanned repetition of a step, or a series of steps in a CWP/FWP. A rework addendum specifies which steps must be repeated in a CWP/FWP and may be used in lieu of a revision when rework is required and the scope of the original work will not be changed. Any additional actions that were not included in the originally approved CWP/FWP constitute a change in scope or work boundaries and must be issued as a revision to the CWP/FWP. All rework must be documented.

- a. The craftsman doing the work must stop the work and notify the LPO/Work Center Supervisor (WCS) that rework is required.
- b. Clear directions on which steps are to be repeated must be provided. Reproducing QA forms may be required. All original and rework QA forms will be retained with the CWP. In addition to the page numbering format used in the TWD, documents and QA forms reproduced to perform rework will be annotated with the term "REWORK" and associated numbering or lettering used in the LOEP at the top of the documents/form(s) (for example - REWORK A, or REWORK 1.1).
- c. An updated LOEP is required when rework requires additional QA forms.
- d. A rework addendum is approved by the Division Officer (for CWPs, concurrence is obtained from the Production Officer/QA Officer).

2.3.7.3 Revisions. Revisions are any change to a CWP/FWP/TWD that meets the criteria listed below. Revisions require formal review and approval.

- a. Reasons requiring a revision to a FWP/TWD:
 - (1) Scope of the work changes (e.g., replace software changed to machine the valve).
 - (2) Boundary of the work changes (e.g., change location of or additional disconnected joints).
 - (3) Change in test requirements unless authorized by a Departure from Specification.
 - (4) Any change in material requirements, which result in a change in testing requirements.
 - (a) The LWC Division Officer or LWC Planner may add materials after the FWP is open that do not change testing requirements.
 - (b) For FWPs executed as a part of the CWP, the QAO/QAS will concur with the addition of material. Concurrence will be by initialing the new line item.
 - (c) At job completion the material list must accurately reflect new materials installed in the system or component.
 - (5) If RADCON is insufficient for the work, based on actual conditions at the worksite, and to change the type of contamination enclosure specified for the work (e.g., to use a drape in lieu of glove bag as specified in the FWP).
 - (6) MCR/REC must be revised.
- b. Steps for making a revision to a CWP/FWP/TWD:
 - (1) Work must stop immediately and the LPO/WCS must be notified when the need for a revision is identified.
 - (2) The revision is then initiated.
 - (a) For Surface Force Ships, an FWP revision is initiated by the originating Work Center and reviewed by the Division Officer responsible for the work associated with the revision.
 - (b) For submarines and aircraft carriers, an FWP revision is initiated by the originating Work Center Maintenance Planner and reviewed by the Division Officer responsible for the work associated with the revision.
 - (c) For Surface Force Ships, a CWP revision is initiated by the LWC and approved per the requirements of Appendix E of this chapter.

- (d) For submarines and aircraft carriers, a CWP revision is initiated by the LWC Maintenance Planner and approved per the requirements of Appendix E of this chapter.
- (3) A revision is normally made by page substitution. Revisions shall be lettered consecutively starting with "A" with the revision letter entered on all affected sheets of the FWP. Revised portions of the FWP shall be marked with a vertical line and the revision letter in the margin. New or replacement sheets may be added by labeling the added sheet with the number of the preceding page and a sub-letter (e.g., Page 5A of 15). Superseded pages (without signatures or recorded data) shall be retained until the FWP is closed out.
- (4) A cover sheet for the revision is attached. The FWP revision sheets will be placed on top of the previous cover sheet with the most current cover sheet on top.
- (5) Routing and authorization of the FWP/TWD is performed.
 - (a) The revised FWP/TWD must be routed only to and reviewed by the divisions affected by the revision process.
 - (b) For an FWP concurrence with the revision is obtained from the Department Head prior to executing the revision. A revision, as a minimum, must be approved by the same level of personnel who approved the original FWP.
 - (c) CWP revisions must be approved by the QAO and officer(s) who approved the original (e.g., Repair Officer, Department Head and Commanding Officer).
- c. Other guidance on making revisions to an FWP/TWD.
 - (1) Revisions to issued FWPs may include non-technical modifications (e.g., line outs) discussed above. In addition, the following instructions are those permitted to be made in the Instructions for Entering Revisions area of Appendix D.
 - (a) Remove: Physically take out the page(s) as specified in the change instruction.
 - (b) Replace: Physically take out the page(s) specified in the change instruction. Put the replacement page(s) provided by the revision in place of the removed page(s) as specified.
 - (c) Insert: Physically insert the page(s) specified in the change instruction into the FWP as specified.
 - (2) A revision will not remove pages with or QA forms from the CWP/FWP/TWD with signatures or recorded data. The portion not yet complete on pages with signatures or data, including QA forms, will be lined out.
 - (3) Each activity affected will ensure that revisions are made and accounted for in an exact manner. The following intent will be adhered to regarding the revision process:
 - (a) All revisions will be entered into the body of the original FWP or will be added as an enclosure or attachment to the original FWP.
 - (b) Revisions shall be numbered such that accountability is maintained.
 - (c) The LOEP will be modified each time a change is made.

2.3.7.4 Attachment. If additional work must be added to the FWP and it is relatively extensive but does not require a change in plant conditions or work boundary, it can be accomplished by using an attachment to the FWP. In this case, the attachment would be written and added to the FWP after the enclosures using the revision process (at a minimum, as a technical pen and ink change). This page would have an additional step that directs performance of the attachment. It would also indicate work sequence, for example whether the attachment would be worked in series or parallel with original FWP work. The composition of an attachment is identical to an addendum except it is prepared after the FWP is issued based on an unexpected problem.

Example: Upon disassembly of a valve it is determined the back seat of the bonnet must be repaired. This repair could be accomplished by attachment.

2.3.7.5 Supplement. Where additional work is required that is similar to or greater in scope to that on the original FWP or involves changes in plant conditions, testing, or major support equipment changes, a supplement could be used. A supplement is another stand-alone FWP containing detailed instructions to perform the additional work. A supplement will comply with the requirements of paragraph 2.2.3 of this chapter. The original FWP should indicate the additional work accomplished in the supplement, if required, to make the original FWP continue to stand alone.

Example: Recovery from loss of cleanliness where work boundaries are increased, additional components opened to obtain flush paths, etc. The original FWP would direct work to the supplemental FWP for recovery and then direct resumption of work per the original FWP. Once cleanliness is reestablished, the original work would continue. In this case, it is necessary to indicate satisfactory completion of the supplement, so that it is clear the condition is corrected.

2.3.7.6 Voiding. There are times during the performance of an FWP where events occur that render the rest of the FWP unnecessary. In this case, a revision would be issued to the FWP providing instructions such as directing work to a new FWP and would void the remainder of the original FWP. For a CWP traceability will be provided to the replacement REC. The document being voided must maintain traceability to the new activity's repair procedure when RECs are being transferred to another activity. Voided CWPs must retain traceability/continuity to the follow-on procedure.

Example: During the repair of a valve, defects are discovered that cannot be repaired, requiring the valve to be replaced instead of repaired as originally intended. Once it is determined the repair is no longer necessary, the repair instructions would be voided.

2.3.7.7 Formal Work Package Closeout. FWPs are reviewed and approved for closing by the LPO/LWC supervisor and designated assist LPO/WCSs for satisfactory completion. Signatures will be accompanied by a legibly printed name and date. The closeout review verifies the below attributes:

- a. Maintenance was completed as specified in the FWP.
- b. Required signatures were made and names printed.
- c. Cleanliness requirements were satisfactorily met.
- d. Correct materials were used.
- e. Post-maintenance testing was properly completed.
- f. Equipment and systems were restored to normal conditions and configurations.
- g. Data was recorded properly and within specifications.

2.3.7.7.1 Completed Formal Work Packages. FWPs executed as stand-alone documents are not required to be retained following:

- a. Completion of the availability in which the work was performed.
- b. Completion of closeout reviews as required by paragraph 2.3.7.7 of this chapter.
- c. Recording of all required data (e.g., Material History).

2.3.7.8 Controlled Work Package Closeout. Upon completion of the maintenance task, each of the cognizant work centers and the QAO will perform a comprehensive review of CWP documentation for correctness and completeness. Once a satisfactory review is completed, CWPs will be closed out subject to the following guidance:

- a. CWPs required to support reactor plant or propulsion plant startup, equipment startup or ship's underway will normally be closed prior to the event.
- b. CWPs for spare equipment, equipment requiring reactor plant or propulsion plant operations to test, equipment requiring retest at sea or for equipment not required for reactor plant, propulsion plant or at sea operations may be left open with the Department Head and Commanding Officer's concurrence.
- c. All nuclear CWPs shall be reviewed for compliance with requirements and closed out prior to reactor plant or propulsion plant startup or ship's underway unless the Department Head and Commanding Officer's concurrence has been obtained to keep the CWP open to perform a critical heat up or critical operations to accomplish system/component retest. Prior to reactor plant or propulsion plant startup or

ship's underway, any activities performing controlled maintenance on the ship will provide the status of the maintenance to the ship (and the ISIC for submarines). When critical operations or at sea testing is required to complete the task the following procedures will be used:

- (1) The testing must be required by an approved NAVSEA procedure (e.g., Maintenance and Replacement Instruction).
 - (2) All open CWPs will be logged and tracked in the CWP/REC Log as follows:
 - (a) All deferred (follow-on) actions will be annotated in the CWP/REC Log of the tended ship.
 - (b) The CWP must include documented transfer of responsibility for accomplishment of deferred actions from the FMA to the tended ship and must be signed by the Commanding Officer, Reactor Officer or Engineer Officer of the tended ship.
 - (c) The closeout review of the CWP will verify that the required documentation from above is contained in the CWP for all deferred actions.
 - (3) A copy of the test results will be provided to the FMA (as applicable) for final review and CWP closeout as soon as practical.
- d. In the event a CWP is prepared, the job is planned to be accomplished, but for some reason the job is cancelled or deferred the following actions should be taken:
- (1) If work was authorized to start, the CWP must be revised to reflect that no work was accomplished and then administratively closed. The QA form 11 log will be annotated to show that the job was "Cancelled".
 - (2) If work was not authorized to start, and the job was cancelled, annotate the remaining blocks of the QA form 9 with "N/A" and note that the CWP was cancelled and no work was accomplished. Blocks 20 (and 21 if the CWP has an REC) will be signed to formally cancel the CWP. If the CWP was prepared by a Repair Facility, a copy of the QA form 9 will be provided to the Tended unit. If a Certification Continuity Letter is required, the cancelled CWP shall be provided with the Certification Continuity Letter. The QA form 11 log will be annotated to show that the job was "Cancelled".
 - (3) If work was not authorized to start and the job is deferred to a future maintenance period, the CWP is not required to be cancelled. The QA form 11 log will be annotated as "Deferred". This is not considered to be an open CWP/REC.
- e. There are no retention requirements for a CWP if work was not authorized to start and the job was cancelled.
- f. The closed CWP will be retained by the QAO in accordance with Part I, Chapter 10 of this volume.

2.3.7.9 Emergent Controlled Work. On those occasions when a component fails and the normal practice of processing a CWP would preclude meeting the ship's operational commitment, work may begin without formal approval of the CWP, provided the concurrence of the FMA Repair Officer (if an FMA is involved), and the ship's Commanding Officer and ISIC (if an FMA is involved) is obtained. The following is required:

- a. The MCR/REC must be properly approved and, to the maximum extent possible, a CWP will be prepared prior to commencement of work.
- b. The task must be continuously monitored and all actions taken recorded by:
 - (1) QAS, if an FMA is involved or
 - (2) Ship's Work Center LPO and a QAI, if the LPO is not a qualified QAI.
- c. All OQE must be completed and inspected as required by Part I, Chapter 5 of this volume.
- d. All records must be reviewed and verified complete and correct.

- e. Departure from Specification will be processed in accordance with Part I, Chapter 8 of this volume for any specifications not met during the repair.

2.3.7.10 Standardized Formal Work Package.

- a. FWPs, which have been performed and proven, may be retained on file to lessen the effort in preparing for a future task of a similar nature.
- b. Standardized FWPs can be used to accomplish the same maintenance task without routing for approval provided the LPO/LWC supervisor and Planning Officer (if assigned) verify that no changes to the reference documents have been issued since initial approval. When initially routed for approval as a standardized FWP, the RADCON OFFICER/Chemistry and Radiological Controls Assistant (CRA) will determine the need for evaluating RADCON for future maintenance actions. If the RADCON OFFICER/CRA determined it is necessary to evaluate RADCON for each future maintenance action the RADCON OFFICER/CRA will check "YES" in CHOP FOR FURTHER USE?. When "YES" is checked RADCON personnel are required to review the standardized FWP prior to each instance of use to verify RADCON controls in the standardized FWP are appropriate for the work. If the RADCON OFFICER/CRA determined it is not necessary to evaluate RADCON for each future maintenance action the RADCON OFFICER/CRA will check "NO" in CHOP FOR FURTHER USE? When "NO" is checked no additional RADCON review is required prior to use of the standardized procedure. If the LPO/LWC supervisor or RADCON personnel (when required) determine the FWP requires a change, it must be routed for approval as a revision to the FWP.
- c. Standardized FWPs developed by FMAs may be used by Ship's Force. Implementation requires Division Officer recommendation and Department Head approval.
- d. Standardized FWPs developed by an FMA may be used at any FMA. Implementation requires Planning Officer recommendation and Department Head approval.
- e. Use of standardized FWPs requires a system to ensure the FWP is current.
 - (1) Maintain a master listing of standardized FWPs by name and revision number.
 - (2) Once approved as a standard FWP the cover sheet will be removed, the FWP will be annotated as the master copy, and retained on file.
 - (3) A copy of the approved master cover sheet will be attached to the standard FWP when work is in progress.
 - (4) All revision cover sheets will be retained with the previous master cover sheet.

2.3.7.11 Lost Controlled Work Packages Following Controlled Work Package Approval.

- a. Formally inform the ISIC and Type Commander.
- b. Conduct a formal critique for CWPs approved/opened and not closed, and provide a copy to the ISIC and Type Commander.
- c. Initiate corrective action using a QA form 14.

2.4 TROUBLESHOOTING.

- a. Troubleshooting a system which is being operated in accordance with the normal ship's operating procedures in normal operation in response to a request for on-site Fleet Technical Assistance does not require an FWP provided the troubleshooting is non-obtrusive (i.e., visual inspection/observations only) and intended to evaluate the nature of the reported problem. Any manipulation of the system outside normal operating conditions requires an FWP.
- b. Troubleshooting equipment normally controlled by using an FWP/TWD, whether done by Ship's Force or by an outside activity, can seldom be precisely defined at the start of corrective maintenance. An FWP for troubleshooting shall include well-defined initial conditions, boundaries and stop points within which troubleshooting can be accomplished. Detailed procedural steps are not required.

Troubleshooting procedure may require some form of trial and error process of elimination. In order to determine the proper tests following troubleshooting, a record of actions performed shall be kept. Once the problem is identified, the FWP shall be revised to properly repair and test the affected equipment.

(This Page Intentionally Left Blank)

APPENDIX A
TECHNICAL WORK DOCUMENT ILLUSTRATION

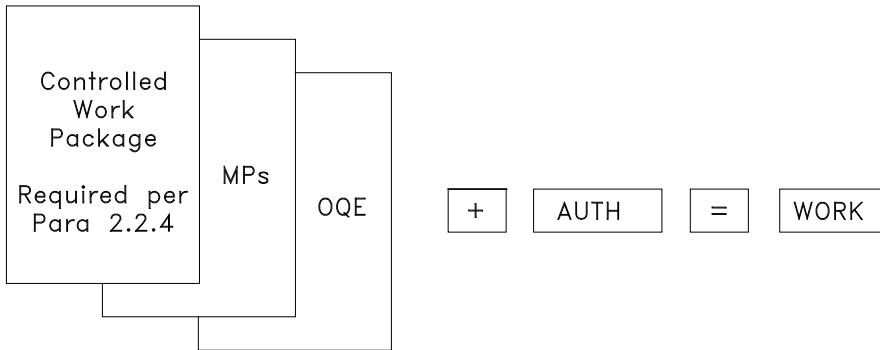
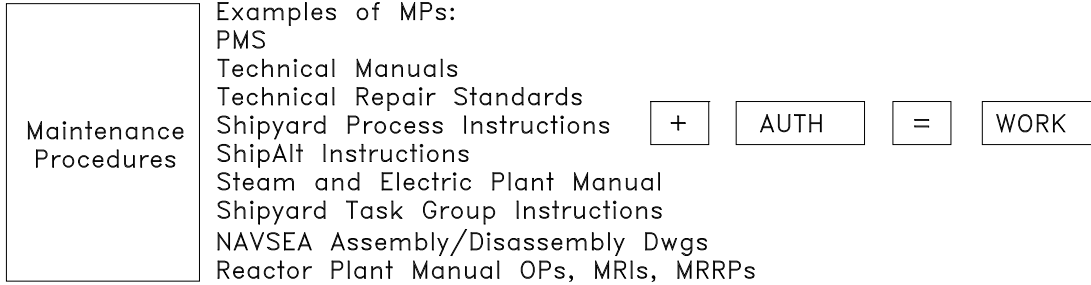

(This Page Intentionally Left Blank)

**APPENDIX B
WORK PACKAGE DECISION PROCESS**

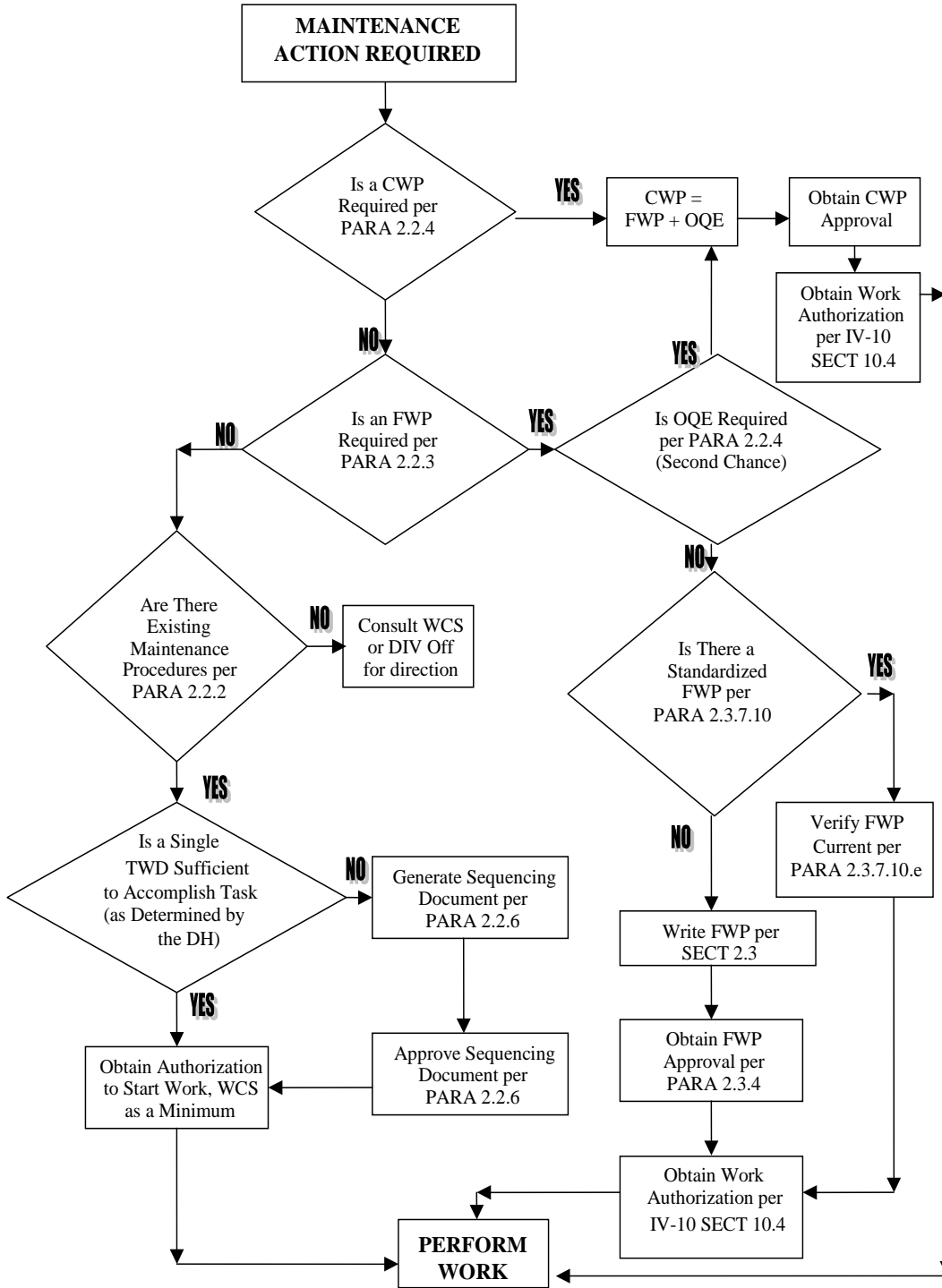

(This Page Intentionally Left Blank)

APPENDIX C**CERTIFICATION SIGNATURE REQUIREMENTS FOR REACTOR PLANT/
NUCLEAR SUPPORT FACILITY/CONTROLLED INDUSTRIAL FACILITY WORK**

1. General Requirements. This appendix lists the instances when a signature is required to certify data or accomplishment of maintenance items. All attributes will be certified by verification or inspection. Appendix C is meant to be comprehensive. However, there could be a maintenance item performed by forces afloat and not listed in this appendix where a NAVSEA document requires a verification with a certification signature; in that event, the certification signature requirement should be met in accordance with the NAVSEA document.

- a. Certifications that record OQE shall be documented on QA forms and kept as required by references (s) and (t), as applicable.
- b. Items that require inspection or verification without an associated record will require a signature only and are not OQE. Therefore, they do not need to be kept after the maintenance is complete and accepted.
- c. Where it is convenient to use a locally generated form to accomplish specific certifications, the CWP shall refer to the form and the signatures will be on the form. These forms need not be kept unless a record is required.
- d. Indicate the individual responsible for performing the certification and the specific attributes being certified at the signature block.
- e. Certification signature statements shall be referenced on each page where a certification signature is required using references (s) and (t), as applicable, for reactor plant and Nuclear Support Facility maintenance respectively:
 - (1) "Direct report from watchstanders" may be deleted from the second (**) Certification Signature Block statement for work where such an option would not be applicable.
 - (2) Single asterisk (*) or double asterisk (**) shall be used at each Certification Signature Block to indicate the type of certification that is expected.

2. Specific Requirements.

- a. Cleanliness. Nuclear propulsion plant cleanliness, foreign material, and detrimental material control shall be according to Table 2.4-a of reference (u).
 - (1) Reactor Plant:
 - (a) Inspection following entry into clean hardware where dirt producing (e.g., machining or grinding) or potentially dirt producing operations (e.g., clean cuts of pipes) are used.
 - (b) Inspection prior to final closure of each opening in clean hardware where the closure will prevent visual access to surfaces which contact system fluid.
 - (c) Inspection during any operation in which a loss of cleanliness could occur that is not easily detected and corrected.
 - (d) Inspection for re-verification of hardware cleanliness per section 2.6 of reference (u).
 - (e) Final inspection following fabrication of hardware or dirt producing modification to hardware.
 - (f) After removal of a controlled product as defined in reference (v) for internal surfaces of installed hardware and internal surfaces of hardware that contains crevices and inaccessible areas. (Applicable to shipyards and Nuclear Regional Maintenance Departments only.)
 - (g) Following the cleaning of internal surfaces when crevices or inaccessible areas are exposed.

- (h) During assembly or disassembly of joints with thread sealant downstream of cleanliness filters to verify there is no visible thread sealant on internal surfaces following assembly.
- (i) Following dirt producing modification to hardware with crevices and inaccessible areas.
- (j) The following inspections must be performed by personnel qualified to perform the verifications but do not require an independent inspection or a certification signature:
 - 1 Verification of cleanliness following entry into clean hardware, except entry that is dirt producing (e.g., machining, grinding) or potentially dirt producing (e.g., clean cuts of pipe).
 - 2 Verification of cleanliness prior to and during assembly (including assembly that creates crevices).
 - 3 Verification of cleanliness prior to thermal treatment.
 - 4 Verification of cleanliness after any test that uses soft metal probes or tips; for example, alloy identity testing.
 - 5 Verification of cleanliness following cleaning except when performed for paragraphs (a) through (d) above or when crevices or inaccessible areas are exposed.
 - 6 Verification of cleanliness following tape removal.
 - 7 Verification of cleanliness prior to closure of support system openings and connection of a clean support system to clean hardware.
 - 8 Verification of final review of the accountability log.
 - 9 Verification of cleanliness prior to installation of support equipment to any vent and drain valve, other than a pressurized discharge.
 - 10 Verification of final cleanliness of cleanliness plugs provided the plugs are assembled from clean parts or sub-assemblies without crevices or inaccessible areas and if the assembly occurs in a clean room or clean area.
- (2) Steam Plant. Verification of cleanliness whenever cleanliness has been lost.
- b. Welding and Brazing. The following signature requirements apply:
 - (1) Inspections where records are required by reference (w) with the exception of in-process visual inspections, which may be verifications. These inspections will be documented on QA forms.
 - (2) Inspections where records are required by reference (x) with the exception of in-process visual inspections, which may be verifications. Inspection that gaskets, O-rings, or seals are either removed or scored as required before welding, so that they no longer function as a seal. These inspections will be documented on QA forms.
 - (3) Inspections for parameters/data where records are required by sections of reference (w) involving welding, with the exception of in-process visual inspections, which may be verifications. This information will be documented on QA forms.
 - (4) Inspections, where records are required, associated with reactor plant welds on piping systems and on components which are nuclear Level I or non-level piping system applications when welds are qualified, performed and inspected according to NAVSEA Nuclear Propulsion Directorate (08) documents other than those included in paragraphs 2.b.(1), (2) and (3) above, with the exception of in-process visual inspections, which may be verifications. These inspections will be documented on QA forms.
 - (5) Inspections required by reference (k) for class P-3a brazed joints in nuclear Level I piping systems, where records are required. These inspections will be documented on QA forms.

- (6) Verification that proper purge path is established before welding, both inlet and exit.
- c. Shielding. Inspections to verify the proper replacement of permanent shielding according to reference (y) or (c), as applicable.
- d. Mechanical Joint Assembly.
 - (1) Verification of the following applicable attributes is required if maintenance is accomplished using a FWP/CWP.
 - (a) Joint identification.
 - (b) Condition of flange faces, O-ring grooves, and other sealing surfaces.
 - (c) Joint alignment.
 - (d) Installation of O-rings or gaskets.
 - (e) Lubrication of fasteners.
 - (f) Thread engagement and stand-out.
 - (g) Final torque on fasteners.
 - (h) Gasket compression and flange parallelism.
 - (2) For joints in Nuclear Level I systems, inspection of the following applicable attributes is required whether the maintenance is accomplished by a CWP or FWP.
 - (a) Final torque on fasteners when a torque is specified.
 - (b) Gasket compression and flange parallelism. (Gap measurement is only required when mating surfaces are not in contact).
- e. Pipe Bending. For pipe bending according to reference (z), the following signature requirements apply:
 - (1) Inspection (NDT) of bent pipe. These inspections will be documented on QA forms.
 - (2) Visual inspections of bent pipe.
- f. Freeze Seal Operations. For freeze sealing according to reference (aa) the following signature requirements apply:
 - (1) Verification of dimensional measurements before and after freeze seal operations.
 - (2) Verification that the variation between before and after dimensional measurements does not exceed the allowed tolerance.
 - (3) Verification that the freeze seal is established.
- g. Hydrostatic Testing. The following signature requirements apply: Inspections required during hydrostatic testing according to reference (h) and the applicable reactor plant manual. The results of these inspections will be documented on QA forms.
- h. Locking devices. The following signature requirements apply:
 - (1) Internal locking devices. The proper installation of locking devices inside the pressure boundary of components containing primary coolant and all locking devices (internal and external) associated with reactor vessels, closure heads, and control rod drive mechanisms shall be confirmed by inspection. The results of such inspection, including dimensions and clearances measured to confirm proper installation, will be documented on QA forms.
 - (2) Verification of the proper installation of other reactor plant component locking devices. This verification is by the craftsman unless the component drawing requires an inspector to perform the check.
- i. Valve Repair. The following signature requirements apply:

- (1) Inspection of the final measurement of the bellows restraint gap “x-dimension” of pilot actuated relief valves where required by applicable technical manuals.
 - (2) Verification of the final blue check of the disc-to-seat.
- j. Valve Testing. The following signature requirements apply to inspection during post installation testing and periodic testing of primary, steam generator, and charging pump relief valves:
- (1) Proper blocking (gagging) and subsequent return to normal service.
 - (2) Locking devices, if required, on manual lift mechanism, locked.
 - (3) Manual lift mechanism removed, if so designed, after testing.
- k. Miscellaneous. The following signature requirements apply:
- (1) Inspections required before, during, or after repair to remove surface discontinuities according to reference (ab), (ac) or (t), as applicable. Document these inspections on QA forms.
 - (2) Inspections required on reactor plant air flasks according to reference (ad).
 - (3) Inspections required for determining reactor plant material acceptability according to the specifications requirements when the inspections specify reference (ae) or reference (af).
 - (4) Inspection of penetrations in tanks to ensure all temporary plugs have been removed and the penetrations are free from obstruction, if maintenance has been performed in the tank.
 - (5) Inspections required by Article 242 of reference (y) or Appendix D of reference (c), as applicable.
 - (6) Verification of removal of installed temporary reactor plant support equipment.
 - (7) Verification of satisfactory completion of reactor compartment closure tests including tests on individual penetrations.
 - (8) Verification of the Reactor Plant Work Accomplishment Report by designated officers.

APPENDIX D

FORMAL WORK PACKAGE APPROVAL/REVISION SHEET

FWP NUMBER _____ REVISION _____

TASK _____

LEAD DIVISION/WORK CENTER _____ ORIGINATOR _____

REVIEWED BY:

WORK CENTER PLANNER (REQUIRED IF ORIGINATOR IS NOT A QUALIFIED PLANNER) _____

AWC LPO/SUPERVISOR _____ AWC DIVISION OFFICER _____

AWC LPO/SUPERVISOR _____ AWC DIVISION OFFICER _____

AWC LPO/SUPERVISOR _____ AWC DIVISION OFFICER _____

NRO _____ P&E OFFICER _____

RADCON OFFICER/CRA _____ CHOP FOR FURTHER USE? ____ YES ____ NO

DIVISION LPO/LWC SUPERVISOR _____ LWC DIVISION OFFICER _____

APPROVED: _____

DEPT HEAD

DATE

THIS STANDARDIZED FWP HAS BEEN VERIFIED TO BE THE LATEST REVISION AND CONTAINS THE CURRENT REFERENCES. THE RADCON OFFICER/CRA HAS/HAS NOT (CIRCLE ONE) VERIFIED THIS FWP FOR CURRENT RADIOLOGICAL CONDITIONS.

LWC SUPERVISOR/LPO _____ DATE

PLANNING OFFICER (IF APPLICABLE) _____ DATE

REVISIONS/CHANGES AND SUMMARY: (APPROVAL SHEET) OR INSTRUCTIONS FOR ENTERING REVISION
LTR: _____ DESCRIPTION _____ DATE ENTERED _____

REVIEWED FOR SATISFACTORY COMPLETION AND CLOSEOUT

AWC LPO/SUPERVISOR _____ LWC LPO/SUPERVISOR _____

(This Page Intentionally Left Blank)

APPENDIX E

TECHNICAL WORK DOCUMENT REVIEW AND APPROVAL MATRIX

TWD TYPE	Work Performed By	Opening (1)								Closing (1)					
		P&E OFF	AWC DIV OFF	LWC DIV OFF		QAO	DEPT HEAD (4)	SHIP ENG	SHIP CO	ISIC	AWC DIV OFF	LWC DIV OFF	QAO	DEPT HEAD	SHIP CO
MP	SF			R											
	FMA	R	R	R											
FWP	SF		R	R (2)		R (11)	A				R (8)	A (8)	R (11)		
	FMA	R (2)	R	R			A				R (8)	A (8)			
SF Prepared CWP	Other		R	R		R	A				R	R	R	A (4)	
	LI		R	R		R	A				R	R	R	A (4)	
	O2		R	R		R	R	A			R	R	R	A	
	NUC		R	R		R	R	A	A (3)	R (6) (10)	R	R	R	R (4)	A (3)
	SS/SOC		R	R		R	R	A			R	R	R	A (5)	S
	SFCC		R	R		R	R	A			R	R	R	A	S
RMC/FMA Prepared CWP	Other	R	R	R		R	A				R	R	R	A (4)	
	LI	R	R	R		R	A				R	R	R	A (4)	
	O2	R	R	R		R	A	S (7)			R	R	R	A (4)	S (7)
	NUC	R (9)	R	R		R	A	S (3)(7)		R (6) (10)	R	R	R	A (4)	S (3)(7)
	SS/SOC	R	R	R		R	A	S (7)			R	R	R	A (4)	S (7)
	SFCC	R	R	R		R	A	S (4)			R	R	R	A	S

Notes:

- R = Review (May require signature on FWP Cover Sheet and/or QA-9),
A = Approve (Approval Signified by signature on FWP Cover Sheet and/or QA Form 9),
S = Acknowledgement signature noting that the REC or CWP has been opened/closed by the approving authority. For opening, this signature also grants permission for work to be conducted. Review and/or Approval signifies the following:
 - The FWP is correct both in sequence and requirements to satisfactorily accomplish the maintenance.
 - The CWP provides the correct technical specifications or requirements (e.g., torque values, dimensions, NDT inspections, cleanliness requirements, critical inspections, recertification tests) for certification attributes on the appropriate QA form.
- For FWPs previously approved by the Department Head, the FWP may be authorized and issued as a standardized FWP per paragraph 2.3.7.10 of this chapter.
- (Nuclear aircraft carriers only) The Reactor Officer will sign.
- For items requiring Department Head approval the following signature requirements shall apply:
 - FMA - Repair Officer (unless formally delegated for Other and LI)
 - SF - Cognizant Department Head (Principal Assistant for aircraft carriers)
- Entries are to be signed by the Ship's Engineer only.
- (Submarines only) ISIC Material Officer will review SF CWPs for retesting FMA accomplished nuclear work.
- This block is not applicable for FMA only MCR/RECs.

8. Accomplished by WC Supervisor.
9. Nuclear Repair Officer if assigned.
10. Applicable to Fleet I-Level activities only. Does not apply to I-Level activities controlled by Naval Shipyards.
11. QAO will review opening and closing of all FWPs for components or systems assembled and performed as a REC/MCR exception.

VOLUME V
PART I
CHAPTER 3
PERSONNEL QUALIFICATION AND TRAINING

REFERENCES.

- (a) NAVEDTRA 43523 - Personnel Qualification Standard for Quality Maintenance Program
- (b) MIL-STD-1330 - Standard Practice for Precision Cleaning and Testing of Shipboard Oxygen, Helium, Helium-Oxygen, Nitrogen and Hydrogen Systems
- (c) OPNAVINST N9210.3 - Safeguarding Naval Nuclear Propulsion Information
- (d) NAVSEAINST 9210.39 - Submarine Nuclear Propulsion Plant Operator Welders: Procedures for Maintenance of Qualification
- (e) NAVSEA 389-0317 - Procedures for Maintenance and Repair of Naval Reactor Plants (Nuclear)
- (f) COMSUBFORINST C5400.30 - Engineering Department Organization Manual
- (g) NAVSEA T9044-AD-MAN-010 - Requirements Manual for Submarine Fly-By-Wire Ship Control Systems
- (h) NAVSEA SS800-AG-MAN-010/P-9290 - System Certification Procedures and Criteria Manual for Deep Submergence Systems
- (i) NAVSEA 0924-062-0010 - Submarine Safety (SUBSAFE) Requirements Manual
- (j) NAVSEANOTE 5000 - Activities Authorized to Perform SUBSAFE, FBW-SCS and DSS-SOC Work

LISTING OF APPENDICES.

- A NAVEDTRA 43523 Qualification Matrix
- B Outlines of Typically Effective Training Topics
- C Recommended Training Topics for Selected Positions

3.1 **PURPOSE.** To define the requirements and guidance necessary to establish a standard qualification and training program for personnel who plan, perform, inspect or supervise the maintenance tasks listed in Part I, Chapter 2, paragraph 2.2.1 of this volume.

3.2 **GENERAL.** Personnel who screen, plan, perform, inspect and supervise the maintenance performed to the following requirements shall be trained and qualified in accordance with this volume and reference (a).

- a. Maintenance requiring a Technical Work Document per Chapter 2, paragraph 2.2.1 of this volume.
- b. Maintenance listed as Material Certification Record (MCR) exceptions per Part I, Chapter 2, paragraph 2.2.5 of this volume.
- c. Maintenance listed as Re-Entry Control (REC) exceptions per Part I, Chapter 5, paragraph 5.6.7 of this volume.

3.2.1 **Discussion.** A continuing training and qualification program is essential for all maintenance personnel to achieve a maintenance program with high standards of quality. Personnel involved in the approval, supervision, planning or performance of shipboard maintenance will be participants in the training and qualifications associated with this volume.

3.3 **QUALIFICATION.** Qualification procedures established herein shall be formal, and designed to heighten awareness of those tasked with the responsibility of administering, managing and executing the Fleet Quality Maintenance (QM) program.

- a. Each organization shall maintain a personnel qualification list per Part I, Chapter 10, of this volume.
- b. Each organization shall maintain a list of personnel authorized to sign off portions of reference (a).

- c. Maintenance personnel shall be qualified through completion of formal qualification programs (e.g., Job Qualification Requirements/Personnel Qualification Standard (PQS), written exams, oral boards and formal schools). Reference (a) provides the standard PQS for the majority of QM qualifications. Appendix A provides a qualification matrix for maintenance personnel PQS requirements.
- d. All personnel performing the maintenance identified in Part I, Chapter 2, paragraph 2.2.1 of this volume shall be 3-M 301 qualified and Craftsman 301 qualified or an equivalent Quality Assurance (QA) qualification for non-naval personnel.

3.3.1 Re-qualification. Personnel with prior documented qualifications may be re-qualified by written exam and/or oral board as directed by Quality Assurance Officer (QAO) or Department Head. Personnel found to be deficient in level of knowledge will be required to complete an upgrade program established by the QAO prior to re-qualification.

3.3.2 Required Service Record Entries. Record of qualification will be inserted in the individual's service record.

3.4 QUALIFICATION REQUIREMENTS.

3.4.1 Ship's Quality Assurance Officer.

- a. Should be a commissioned officer with engineering/repair experience.
- b. (Submarines only) Submarine officer must have completed submarine qualification and for nuclear powered ships should be nuclear trained.
- c. Designated in writing by the Commanding Officer.
- d. QA Officer course requirements are as follows:
 - (1) A surface ship QAO shall be a qualified Quality Assurance Supervisor (QAS) and shall be a graduate of a QAO course.
 - (2) A submarine QAO shall be a graduate of the Submarine Officers' and Supervisors' Quality Maintenance course, F-4H-0182. No other formal PQS qualification is required. With a formal waiver (Naval message or letter) endorsed by the Immediate Superior In Command (ISIC) and approved by the Type Commander (TYCOM), this requirement can be temporarily waived by the TYCOM but the waiver may not exceed 6 months. The waiver must list the interim QAO and qualifications, the perspective QAO and graduation date from F-4H-0182 and/or the report date.
 - (3) An aircraft carrier QAO shall be a graduate of the 5-week Quality Assurance Officer Course (S-4H-0001) for CVN officers. No other formal PQS qualification is required. With a formal waiver (Naval message or letter) endorsed by the ISIC and approved by the TYCOM, this requirement can be temporarily waived but the waiver may not exceed 6 months. The waiver must list the interim QAO and qualifications, the perspective QAO and graduation date from S-4H-0001 and/or the report date.
- e. (Submarines only) Complete an oral interview with the ISIC or submarine support component QAO.

3.4.2 Ship's Assistant Quality Assurance Officer.

- a. Normally E-6 or above with engineering/repair experience.
- b. Designated in writing by the Commanding Officer.
- c. (Submarines only) Complete an oral interview with the ISIC or Submarine Support Component QAO.

3.4.3 Immediate Superior In Command.

- a. Quality Assurance Officer.
 - (1) Should be a commissioned officer, but may be a civilian with engineering/repair experience.
 - (2) Should be a graduate of a QAO course. No other formal PQS qualification is required.
 - (3) Designated in writing by the ISIC.

- b. Assistant Quality Assurance Officer.
 - (1) Normally E-7 or above, but may be a senior civilian with engineering/repair experience.
 - (2) Should be a graduate of a QAO course.
 - (3) Qualified as QAS. QAS qualification is not required if he/she is a graduate of the Norfolk Naval Shipyard Fleet Maintenance Support Branch QAO course.
 - (4) Designated in writing by the Commanding Officer. The duties assigned, including signature authority, shall be clearly delineated.

3.4.4 Regional Maintenance Center/Fleet Maintenance Activity Quality Assurance Officer.

- a. Should be a commissioned officer, but may be a civilian with engineering/repair experience.
- b. Will not be assigned collateral duties or responsibilities that divert attention from primary duties of QM.
- c. Should be a graduate of a QAO course. No other formal PQS qualification is required.
- d. Designated in writing by the Commanding Officer.

3.4.5 Regional Maintenance Center/Fleet Maintenance Activity Assistant Quality Assurance Officer.

- a. Normally E-7 or above, but may be a senior civilian with engineering/repair experience.
- b. Qualified as QAS or a graduate of a QAO course.
- c. Designated in writing by the Commanding Officer.

3.4.6 Quality Assurance Supervisor.

- a. Normally E-6 or above, but may be a civilian.
- b. Complete PQS for QAS, and pass a written examination and oral board.
- c. QAS is a mandatory qualification for Fleet Maintenance Activities (FMA). Qualification of QAS for ships is at the TYCOM's discretion.

3.4.7 Quality Assurance Inspector.

- a. Normally a petty officer, but may be a civilian.
- b. Complete PQS for Quality Assurance Inspector (QAI) and pass a written exam and oral board.
- c. The qualification card may be split into separate nuclear and non-nuclear QAI qualifications. If this is done, the command must ensure QAIs do not inspect areas excluded from their qualifications.

3.4.8 Controlled Material Petty Officer/Controlled Material Handler.

- a. Normally a petty officer, but may be a civilian.
- b. Complete PQS for Controlled Material Petty Officer (CMPO)/Controlled Material Handler (CMH), and pass a written exam and oral board.
- c. Activities may modify the qualification card to allow CMPO/CMH qualification for specific materials only. If this is done, commands must have a method to ensure CMPOs/CMHs do not handle material excluded from their qualification.

3.4.9 Steam Plant Cleanliness Inspector/Certifier.

- a. Normally a petty officer, but may be a civilian.
- b. Complete PQS for Steam Plant Cleanliness Inspector and pass a written exam and oral board.

3.4.9.1 Qualification Requirements for Reactor Plant Cleanliness Inspector/Certifier.

- a. Normally a petty officer, but may be a civilian.
- b. Complete PQS, per reference (a), for Reactor Plant Cleanliness Inspector, pass written exam and oral board.

3.4.10 Gas Systems Cleanliness Inspector/Certifier.

- a. Normally a petty officer, but may be a civilian.
- b. Satisfactorily complete an Oxygen Clean Worker course of instruction in accordance with reference (b).

3.4.11 Oxygen Clean Instructors. An Oxygen Clean Instructor will be certified in accordance with reference (b). Oxygen Clean Instructors will re-qualify every three years. If an individual is scheduled for transfer within six months after the expiration of qualification, it is permissible to extend the qualification until transfer. The local command may exempt the senior instructor from re-qualification.

3.4.12 Ship's and Fleet Maintenance Activity Oxygen Clean Workers. Oxygen Clean Workers will be certified in accordance with reference (b). Oxygen Clean Workers will re-qualify every three years. If an individual is scheduled for transfer within six months after the expiration of qualification, it is permissible to extend the qualification until transfer.

3.4.13 Oxygen Calibration Technicians. Oxygen Calibration Technicians qualify to perform oxygen instrument cleaning and calibration by satisfactory completion of Oxygen Calibration School **at the direction of the Naval Sea Systems Command (NAVSEA) Metrology and Calibration (METCAL) Quality Manager.** Naval Sea Systems Command certifies successful candidates for two years following a report of satisfactory completion of Oxygen Calibration School. Local Regional Maintenance Center re-certifies Oxygen Calibration Technicians during the calibration capability reviews of FMAs or Strategic Systems Program Office capabilities and proficiency evaluation of SSBN/SSGN FMAs.

3.4.14 Work Center Supervisors and Planners. The qualification of QA Maintenance Planners and QA Work Center Supervisors is required in all work centers that perform maintenance tasks outlined in Part I, Chapter 2, paragraph 2.2.1 of this volume. Work Center Supervisors and Maintenance Planners will, as a minimum, complete the applicable qualifications of reference (a) prior to performing any unsupervised maintenance tasks. QA Maintenance Planners prerequisite fundamentals (QAI and Cleanliness Inspector) may be deleted in work centers that do not perform controlled work. Activities with separate planning organizations are exempt from having planners assigned to individual work centers.

3.4.15 Qualification Requirements for Submarine Nuclear Propulsion Plant Operator Welders (Navy Enlisted Classification Code 3351 and Supervisor Welders 3361).

NOTE: INFORMATION ON THIS SUBJECT IS SAFEGUARDED IN ACCORDANCE WITH REFERENCE (c). **SPECIFIC PROGRAM REQUIREMENTS ARE IDENTIFIED IN REFERENCES (d) AND (e).**

3.4.16 Qualification Requirements for Submarine Fly-By-Wire Ship Control System Maintenance Technician. Shall be a graduate of the Ship Control System Maintenance Technician School (A-623-0118 for SSN 21 Class, A-623-0131 for SSN 774 Class).

3.5 TRAINING.

3.5.1 Maintenance Personnel Training. All personnel involved with planning, performing and supervising maintenance specified in Section 3.2 of this chapter will be trained using the following guidance:

- a. Appendices B and C of this chapter and Part II, Chapter 1, Appendix A of this volume (where applicable) provide information on program elements normally contained in effective maintenance training programs. Appendix B is applicable to Ship's Force whereas Appendix C is applicable to Fleet Maintenance Activities (e.g., mechanics, Nondestructive Test (NDT) technicians, welders and planners). All appendices identified in this paragraph are provided as information only and are not to be considered mandatory listings.
- b. Findings from QA form 14s, audits, assessments and surveillance should be included, when appropriate, to re-emphasize the most recent problems experienced in the department.
- c. Include the training with existing topics where possible (i.e., CMPO training held with Repair Parts Petty Officer training or Steam Plant Cleanliness training held in conjunction with Machinery Divisions training on the Steam Plant). However, some areas may require separate training to be held.

- d. Joint training between departments and organizations is acceptable. The Department Head will coordinate with the QAO on training concerning QM. It is not the intent to create a separate training program, nor is the intent to hold one annual training session that covers all of the topics.
- e. In order to assess the effectiveness of the training program, the QAO should:
 - (1) Periodically monitor training.
 - (2) Assess knowledge level retention in conjunction with the conduct of annual QA and welder training and qualification program audit required by reference (a), paragraph 9.3.1.

3.5.2 Requirements. The training topics of this chapter shall be fully integrated into the Engineering Department Training Plan in accordance with reference (f). The QAO shall provide a list of applicable training topics to the Engineer and Engineering Department Master Chief for all ship's departments for inclusion in the Engineering Department training plans.

- a. These topics shall be reviewed and updated annually or whenever a new long range training plan is generated.
- b. For maintenance personnel, the QAO shall provide a list of applicable training topics using Appendices B and C of this chapter as a guide.
- c. For personnel responsible for planning, approving, inspecting or supervising maintenance on systems/equipment included in the QM Program, the QAO shall submit a separate advanced training program. At a minimum, the following items shall be covered.
 - (1) Requirements and generation of a controlled work package and formal work package including objective quality evidence, required inspections and critical QM points.
 - (2) Material certification, control and stowage requirements.
 - (3) In-process control including torquing, controlled assembly, system cleanliness requirements for specific systems (e.g., air systems, hydraulic systems) and common mistakes noted in completed QA forms.
 - (4) Testing.
 - (5) Departure from specifications.

3.5.3 Submarine Safety Awareness Training (Submarines and Submarine Repair Facilities only). All hands shall receive Submarine Safety (SUBSAFE) awareness and Fly-By-Wire Ship Control (if assigned to, work on or oversee 21 Class or 774 Class submarines) training during initial indoctrination and annually thereafter. Personnel at Submarine Repair Facilities who supervise or manage SUBSAFE, Deep Submergence System-Scope of Certification or Fly-By-Wire-Ship Control System work will receive training on parent requirements to include (at a minimum) references (g), (h), (i) and (j). ISIC and TYCOM staff members that routinely review SUBSAFE objective quality evidence, make determinations on SUBSAFE Departures from Specifications and perform other SUBSAFE work oversight will receive annual SUBSAFE awareness training to keep knowledge and proficiency levels high.

(This Page Intentionally Left Blank)

APPENDIX A
NAVEDTRA 43523 QUALIFICATION MATRIX

WATCHSTATION	PRE-REQUISITE WATCHSTATIONS	PRE-REQUISITE FUNDAMENTALS
301 Craftsman	None	101 Quality Maintenance Safety Precautions 102 Quality Maintenance Administration 103 Quality Maintenance Program 104 Craftsman
302 Controlled Material Petty Handler (CMPO/CMH)	301 Craftsman	105 Controlled Material Petty Officer/Controlled Material Handler (CMPO/CMH)
303 Steam Plant Cleanliness Inspector/Certifier (SCI)	301 Craftsman	106 Steam Plant Cleanliness Inspector/Certifier (SCI)
304 Reactor Plant Cleanliness Inspector/Certifier (RCI)	303 Steam Plant Cleanliness Inspector/Certifier (SCI)	107 Reactor Plant Cleanliness Inspector/Certifier (RCI)
305 Quality Assurance Inspector (QAI)	301 Craftsman 302 Controlled Material Petty Officer/Controlled Material Handler (CMPO/CMH)** 303 Steam Plant Cleanliness Inspector/Certifier (SCI)** 304 Reactor Plant Cleanliness Inspector/Certifier (RCI)**	109 Quality Assurance Inspector (QAI)
306 Maintenance Planner	301 Craftsman	106 Steam Plant Cleanliness Inspector/Certifier (SCI) 107 Reactor Plant Cleanliness Inspector/Certifier (RCI) 108 Gas Systems Cleanliness 109 Quality Assurance Inspector 110 Planner
307 Work Center Supervisor (WCS)	301 Craftsman	105 Controlled Material Petty Officer/Controlled Material Handler (CMPO/CMH) ** 106 Steam Plant Cleanliness Inspector/Certifier (SCI) 107 Reactor Plant Cleanliness Inspector/Certifier (RCI) 108 Gas Systems Cleanliness 109 Quality Assurance Inspector 110 Planner 111 Work Center Supervisor
308 Quality Assurance Supervisor (QAS)	305 Quality Assurance Inspector (QAI)	108 Gas System Fundamentals 110 Planner 112 Quality Assurance Supervisor

** Noted in the PQS as Command/Specific. For these items the necessity for the pre-requisites will be determined by the type of work the individual/command performs and that individual's PQS should be tailored accordingly.

(This Page Intentionally Left Blank)

APPENDIX B
OUTLINES OF TYPICALLY EFFECTIVE TRAINING TOPICS

1. Work Authorization.
 - a. Topic.
 - (1) Work authorization forms.
 - (2) Tag-outs.
 - (3) Safety requirements.
 - (4) Ship responsibility for outside activity maintenance.
 - b. Reference: COMUSFLTFORCOMINST 4790.3; Joint Fleet Maintenance Manual, Volume V.
2. Formal Work Package/Controlled Work Package documentation.
 - a. Topic.
 - (1) Record retention requirements.
 - (2) Mandatory documents.
 - (3) Routing of documents and signature documents.
 - (4) Test requirements for FMA work.
 - b. Reference: COMUSFLTFORCOMINST 4790.3; Joint Fleet Maintenance Manual, Volume V.
3. In Process Control.
 - a. Topic.
 - (1) Torquing.
 - (2) Controlled assembly.
 - (3) Cleanliness requirements for:
 - (a) Air systems.
 - (b) Hydraulic systems.
 - (c) Reactor plant (nuclear powered ships only).
 - (d) Steam plant (non-nuclear and nuclear powered ships).
 - (e) Oxygen/Nitrogen systems.
 - (f) Seawater systems.
 - (g) Lubricating systems.
 - (h) Gas Turbine systems.
 - (i) Fuel systems.
 - (j) Diesel systems.
 - (4) Use of formal work packages.
 - (5) Control of fasteners. (Include avoidance of carbon steel in seawater systems.)
 - (6) Material control.
 - (7) Re-work.
 - (a) Administration.

- (b) Root cause and corrective action.
 - (8) Revisions: Administration.
 - (9) Critical QM points.
 - (10) Procedural compliance.
 - (11) Submarine antenna work including mast clamps.
 - (12) Departure from specifications.
 - (13) Submarine Flight Critical Components
- b. References.
- (1) COMUSFLTFORCOMINST 4790.3; Joint Fleet Maintenance Manual, Volume V.
 - (2) NAVSEA 0902-018-2010; General Overhaul Specifications for Deep Diving SSBN/SSN Submarines (DDGOS).
 - (3) NAVSEA S9505-AM-GYD-010; Submarine Fastening Criteria (Non-Nuclear), Description, Design and Maintenance.
 - (4) NAVSEA S9520-AA-MMA-010; Repair of Submarine Seawater Ball Valves (Non-Nuclear).
 - (5) Naval Ship's Technical Manuals (NSTM).
 - (6) MIL-STD 1330; Standard Practice for Precision Cleaning and Testing of Shipboard Oxygen, Helium, Helium-Oxygen, Nitrogen and Hydrogen Systems.
 - (7) NAVSEA 0900-LP-016-6080; QA Standard for Submarine Antenna and Mast Assemblies.
 - (8) NAVSEA S9AA0-AB-GOS-010/020/030; General Specifications for Overhaul of Surface Ships (GSO); AEGIS Supplement.
 - (9) NAVSEA T9044-AD-MAN-010 - Requirements Manual for Submarine Fly-By-Wire Ship Control Systems.

4. Testing.

- a. Topic.
- (1) Hydrostatic test rig requirements including calibration.
 - (2) Test pressure drawings.
 - (3) Air blast/vacuum and other tests.
 - (4) Use of FMA and shipyard test plans/procedures.
 - (5) Conducting hydrostatic tests and completing hydrostatic test forms (including common mistakes).
 - (6) NDT alternative in testing.
- b. References.
- (1) COMUSFLTFORCOMINST 4790.3 Joint Fleet Maintenance Manual, Volume V.
 - (2) Test Pressure Drawings.
 - (3) NAVSEA S9505-AF-MMA-010; Submarine Non-Nuclear Piping System Test Manual.
 - (4) NAVSEA 0902-018-2010; General Overhaul Specifications for Deep Diving SSBN/SSN Submarines (DDGOS).
 - (5) NAVSEA S9086-RK-STM-010; NSTM Chapter 505 (Piping Systems).
 - (6) NAVSEA S9AA0-AB-GOS-010/020/030; General Specifications for Overhaul of Surface Ships (GSO); AEGIS Supplement.

5. Material Certification.

a. Topic.

- (1) Level I material requirements.
- (2) Level I material exceptions.
- (3) Use of drawings for Quality Assurance Lists.
- (4) Submarine antenna material.
- (5) Upgraded systems to Level I requirements.
- (6) Upgrading components to meet Level I and SUBSAFE requirements.
- (7) Submarine Flight Critical Components requirements.

b. References.

- (1) SUBSAFE Certification Boundary Book.
- (2) Joint Identification Plans/Mapping Plans.
- (3) COMUSFLTFORCOMINST 4790.3; Joint Fleet Maintenance Manual, Volume V.
- (4) Ship's Coordinated Shipboard Allowance List (COSAL).
- (5) NAVSEA 0948-LP-045-7010; Material Control Standard (Non-Nuclear).
- (6) NAVSEA/NAVSUPINST 4855.1; Quality Assured Submarine Antenna Material: Policy and Procedures for Control and Implementation.
- (7) Applicable Class Material Identification and Control of Piping Systems Boundary Book.
- (8) NAVSEA T9044-AD-MAN-010 - Requirements Manual for Submarine Fly-By-Wire Ship Control Systems.

6. Material Procurement/Receipt Inspection.

a. Topic.

- (1) SUBSAFE/Level I/Submarine Flight Critical Component material.
- (2) Material substitution.
- (3) Stowage requirements for controlled material.
- (4) Ship's COSAL.

b. References.

- (1) COMUSFLTFORCOMINST 4790.3; Joint Fleet Maintenance Manual, Volume V.
- (2) NAVSEA 0948-LP-045-7010; Material Control Standard (Non-Nuclear).
- (3) NAVICPINST 4355.5; Receipt, Inspection, Storage and Issue of Level I Material.
- (4) NAVSEA 0948-LP-103-6010; Level I Stock Program Catalog, (Part I - Submarine Items, Part II - Surface Ship Items).
- (5) Applicable Class Material Identification and Control of Piping Systems Boundary Book.
- (6) NAVSEA T9044-AD-MAN-010 - Requirements Manual for Submarine Fly-By-Wire Ship Control Systems.

7. SUBSAFE.

a. Topic.

- (1) Determination of SUBSAFE/Hull Integrity boundaries.
 - (2) Use of QA forms and tags.
 - (3) Torquing of hull integrity fasteners.
 - (4) Generation of an MCR/REC.
 - (5) Unrestricted Operation/Periodic Maintenance Requirement.
 - (6) Departure from Specification requirements.
 - (7) REC exceptions.
 - (8) Positive material identification requirements for hull integrity fasteners.
- b. References.
- (1) SUBSAFE Certification Boundary Book.
 - (2) NAVSEA 0924-062-0010; Submarine Safety (SUBSAFE) Requirements Manual.
 - (3) COMUSFLTFORCOMINST 4790.3; Joint Fleet Maintenance Manual, Volume V.
 - (4) Applicable Unrestricted Operation Maintenance Requirement Card program technical manual.
8. Audit and Surveillance (for personnel performing).
- a. Topic.
- (1) Audit/surveillance requirements.
 - (2) Purpose of audit and/or surveillance program.
 - (3) Preparing for and conducting an audit including specific discussion of techniques to be used to make audits effective and useful to the organization.
 - (4) Preparing for and conducting a surveillance includes a specific discussion of techniques to be used to make surveillance effective and useful to the organization.
 - (5) Documenting an audit or surveillance.
 - (6) Root cause identification.
 - (7) Trends and trend analysis.
- b. Reference: COMUSFLTFORCOMINST 4790.3; Joint Fleet Maintenance Manual, Volume V.
9. Additional Training Topics.
- a. Weight handling equipment testing, use and safety.
 - b. Oxygen/Nitrogen plant maintenance.
 - c. Working aloft and Sail Safety.
 - d. Combat systems maintenance requirements.
 - e. Electrical safety.
 - f. Welding.
 - g. Brazing.
 - h. REC requirements on diving systems.
 - i. Cleanliness requirements for diving systems.
 - j. Controlled material requirements for diving systems.

10. Nuclear Training Topics.

NOTE: WHERE THERE ARE SIMILAR LECTURE TOPICS, IT IS SUGGESTED THAT THE TRAINING PRESENTED TO NUCLEAR TRAINED PERSONNEL CONSIST OF BOTH THE INFORMATION FROM TOPICS 1-9 ABOVE AND THE NUCLEAR SPECIFIC INFORMATION CONTAINED BELOW.

- a. Material Certification.
 - (1) This lecture should include discussion of: Nuclear Level I requirements.
 - (2) The following references provide information on this topic:
 - (a) NAVSEA 0948-LP-045-7010; Material Control Standard.
 - (b) NAVSEAINST C9210.34; Material Identification and Control Requirements for Naval Nuclear Reactor Plant Piping Systems.
 - (c) SPCCINST 4440.376; Supply Policies and Procedures for Naval Reactor Plant Repair Parts and Materials.
 - (d) NAVSEA 0989-LP-037-2000; Commissioned Submarine General Reactor Plant Overhaul and Repair Specification.
 - (e) NAVSEA 0989-LP-043-0000; Commissioned Surface Ship General Reactor Plant Overhaul and Repair Specification.
 - (f) NAVSEA 0989-LP-058-1000; Destroyer Tender and Submarine Tender Nuclear Support Facilities Overhaul and Repair Specification.
 - (g) NAVSEA 0989-064-3000; Cleanliness Requirements for Naval Nuclear Plant Maintenance and Construction.
 - (h) NAVSEAINST 9210.23; Naval Nuclear Work at Naval Activities and Private Shipyards - Certification of Work Accomplishment and Data, Retention of Associated Records and Retention of Design Records, Requirements for.
- b. Material Procurement/Receipt Inspection. This lecture should include discussion of:
 - (1) Nuclear Material.
 - (2) Material Substitutions. Certifying material for use to Nuclear Level I.
 - (3) The list of references in paragraph 10.a (2) of this appendix provides information on the above topic.
- c. In-Process Control.
 - (1) This lecture should include discussion of:
 - (a) Cleanliness requirement for:
 - 1 Reactor Plant (nuclear powered ships only).
 - 2 Steam Plant (fossil and nuclear powered ships).
 - (b) Requirements for a work package.
 - (c) Generation of a work package.
 - (d) Use of QA forms and tags.
 - (e) Setting plant conditions.
 - (f) Certification signature requirements.
 - (g) Use of material control tags.

- (h) Reactor Plant Work Accomplishment Reports (RPWAR).
 - (2) The list of references in paragraph 10.a.(2) of this appendix provides information on the above topic.
- d. Testing.
 - (1) This lecture should include discussion of:
 - (a) Hydrostatic test rig requirements including calibration.
 - (b) Hydrostatic test forms.
 - (c) Conducting hydrostatic test.
 - (d) Setting plant conditions.
 - (e) Use of Reactor Plant Manual for test requirements.
 - (f) Weight Handling Equipment Testing.
 - (2) The following references provide information on this topic:
 - (a) Reactor Plant Manual.
 - (b) NAVSEA 0989-028-5000; Manual for the Control of Testing and Plant Conditions.
 - (c) NAVSEA 0387-LP-046-8000; System Hydrostatic Test Requirements.
 - (d) NAVSEA 0989-LP-058-0000; AS/AD Tender Nuclear Support Facilities Preventive Maintenance Index.
 - (e) NAVSEA 0989-LP-037-2000 - Commissioned Submarine General Reactor Plant Overhaul and Repair Specification.
 - (f) NAVSEA 0989-LP-043-0000 - Commissioned Surface Ship General Reactor Plant Overhaul and Repair Specification.
- e. Final work package documentation. This lecture should include discussion of:
 - (1) Record retention requirements.
 - (2) Mandatory documents.
- f. Reactor Plant Fundamentals. This should be slanted toward the worker so that he/she understands the possible consequences of faulty workmanship, loss of cleanliness, etc., in the Reactor Plant.
- g. FMA Nuclear Planning Yard Basic Trade Skills Lesson Plans (when available).

APPENDIX C**RECOMMENDED TRAINING TOPICS FOR SELECTED POSITIONS**

1. Experience has shown that effective training should be related to job skills required by the individual.
 - a. Mechanical craftsmen should cover areas like:
 - (1) Tools and their uses.
 - (2) Shop safety.
 - (3) Work authorization.
 - (4) Material identification.
 - (5) Rework and their causes.
 - (6) Valve construction and methods to perform:
 - (a) Stack height measurements.
 - (b) Blue checks.
 - (c) Lapping of a valve seat.
 - (7) Pump construction and methods to perform:
 - (a) Mechanical seal replacement.
 - (b) Alignments.
 - (8) Testing requirements.
 - (9) Cleanliness requirements.
 - (10) Technical manuals and their usage.
 - (11) Drawings and their usage.
 - (12) Work packaging administration.
 - b. NDT inspectors and welders should cover the following areas:
 - (1) NAVSEA S9074-AR-GIB-010/278; Requirements for Fabrication Welding and Inspection, and Casting Inspection and Repair for Machinery Piping and Pressure Vessels.
 - (2) NAVSEA T9074-AD-GIB-010/1688; Fabrication, Welding and Inspection of Submarine Structures.
 - (3) MIL-STD-1689 (for Surface Ships only); Fabrication, Welding and Inspection of Ship's Structures.
 - (4) NAVSEA 0900-LP-001-7000; Fabrication and Inspection of Brazed Piping Systems.
 - (5) NAVSEA T9074-AS-GIB-010/271; Requirements for Nondestructive Testing Methods.
 - (6) MIL-STD-2132; Nondestructive Examination Requirements for Special Applications.
 - (7) Material control.
 - (8) Cleanliness.
 - (9) Work package administration.
 - c. Planners should cover the following areas:
 - (1) SUBSAFE program.
 - (2) Level I program.

- (3) QA forms.
- (4) Welding requirements.
- (5) Manufacturing specifications.
- (6) Cleanliness requirements and specifications.
- (7) Hydrostatic testing.
- (8) Material control.
- (9) Manufactured fittings specifications.
- (10) Plant conditions.
- (11) System flushes.
- (12) NDT requirements.
- (13) Testing requirements.
- (14) Index of technical publications.
- (15) Military standards and specifications.
- (16) Selected record drawings/ship's drawing index.
- (17) Maintenance data systems.
- (18) Blue print reading.
- (19) For activities involved in Scope of Certification maintenance:
 - (a) NAVSEA SS800-AG-MAN-010/P-9290, System Certification Procedures and Criteria Manual for Deep Submergence System.
 - (b) Scope of Certification material control classification.
 - (c) Implodability.
- (20) Submarine Flight Critical Components.

2. Proven training methods include the use of mockups and training aids that show practical application of the lecture material. Hands on mockup training, performed by the workers is the most highly effective method followed by the demonstration of skills by the instructor.

3. Nuclear Training Topics.

NOTE: WHERE THERE ARE SIMILAR LECTURE TOPICS, IT IS SUGGESTED THAT THE TRAINING PRESENTED TO NUCLEAR TRAINED PERSONNEL CONSIST OF BOTH THE INFORMATION FROM TOPICS 1-2 ABOVE AND THE NUCLEAR SPECIFIC INFORMATION CONTAINED BELOW.

- a. Job Skill Training. Each work center should determine the skill requirements and incorporate their own training requirements. Examples are:
 - (1) Nuclear planners should cover areas like:
 - (a) RPWAR.
 - (b) Manufactured fittings specifications.
 - (c) Freeze seal requirements.
 - (d) Plant conditions.
 - (e) Welding requirements.
 - (f) Radiological Controls.

- (g) System flushes.
 - (h) Nondestructive Testing (NDT) requirements.
 - (i) Hydrostatic testing requirements.
- (2) The following references provide information on the above topics:
- (a) NAVSEA 0387-LP-046-8000; System Hydrostatic Test Requirements.
 - (b) NAVSEA 0348-LP-159-1000; Freeze Sealing Manual.
 - (c) NAVSEA 0989-064-3000; Cleanliness Requirements for Naval Nuclear Plant Maintenance and Construction.
 - (d) Valve Manuals.
 - (e) NAVSEA 0989-LP-037-2000; Commissioned Submarine General Reactor Plant Overhaul and Repair Specification.
 - (f) Reactor Plant Manual.
 - (g) NAVSEA 0989-028-5000; Manual for the Control of Testing and Plant Conditions.
 - (h) NAVSEA 389-0317; Procedures for Maintenance and Repair of Naval Reactor Plants.
 - (i) NAVSEA 0989-LP-043-0000; Commissioned Surface Ship General Reactor Plant Overhaul and Repair Specification.
 - (j) NAVSEA 0989-LP-058-1000; Destroyer Tender and Submarine Tender Nuclear Support Facilities Overhaul and Repair Specification.

(This Page Intentionally Left Blank)

VOLUME V**PART I****CHAPTER 4****WELDER, BRAZER AND NONDESTRUCTIVE TESTING QUALIFICATIONS****REFERENCES.**

- (a) NAVSEA S9086-CH-STM-010 - NSTM Chapter 074 Volume 1 (Welding and Allied Processes)
- (b) NAVSEA S9074-AQ-GIB-010/248 - Welding and Brazing Procedures and Performance Qualification
- (c) NAVSEA 0900-LP-001-7000 - Fabrication and Inspection of Brazed Piping Systems
- (d) NAVSEA T9074-AS-GIB-010/271 - Requirements for Nondestructive Testing Methods
- (e) NAVPERS 18068 - Manual of Navy Enlisted Manpower and Personnel Classification and Occupational Standards
- (f) NAVSEA S9086-CH-STM-020 - NSTM Chapter 074 Volume 2 (Nondestructive Testing of Metals Qualification and Certification Requirements for Naval Personnel (Non-nuclear))
- (g) OPNAVINST 4790.4 - Ships' Maintenance and Material Management (3-M) Manual
- (h) NAVSEA 0948-LP-045-7010 - Material Control Standard
- (i) NAVSEA 389-0317 - Procedures for Maintenance and Repair of Naval Reactor Plants (Nuclear)

4.1 **PURPOSE.** This chapter provides the requirements for qualification of Shipboard and Fleet Maintenance Activity Welders, Brazers, and Nondestructive Testing (NDT) personnel. Also included are qualification record requirements. The provisions of references (a) through (i) are amplified and expanded herein to ensure that all provisions of higher authority are implemented.

NOTE: ALTHOUGH THIS CHAPTER COVERS THE REQUIREMENTS FOR NAVY WELDERS, BRAZERS AND NDT PERSONNEL, THE PERFORMANCE QUALIFICATIONS FOR CIVILIAN WELDERS, BRAZERS AND NDT PERSONNEL WILL BE IN ACCORDANCE WITH REFERENCES (b), (c) AND (d) RESPECTIVELY.

4.1.1 **General Requirements.** Each activity is responsible for establishing that each welder or brazer is qualified by demonstrating their ability to produce sound and satisfactory joints in accordance with references (a) through (c). References (a), (e) and (f) define welder and NDT qualifications by Navy Enlisted Classification (NEC) codes.

4.1.2 **Training.**

NOTE: NO WELDER SHALL PERFORM QUALIFICATION OR PRODUCTION FABRICATION UNTIL AFTER RECEIPT OF THIS TRAINING AND PASS A WRITTEN EXAMINATION WITH A SCORE OF AT LEAST 75%.

- a. Activities shall have a training program in accordance with references (b) and (d). Activities without a Level III examiner should obtain assistance from a Fleet Maintenance Activity.
- b. For those welds or brazes not frequently performed for production, proficiency should be demonstrated by satisfactory completion of a mock-up of the weld or braze prior to performing production work.

4.2 **GENERAL REQUIREMENTS FOR BRAZERS AND WELDERS.**

- a. The extent of welder qualification resulting from tests shall be governed by references (a) and (b). The extent of brazer qualification shall be governed by reference (c) for piping and pressure vessel applications.

NOTE: THE REQUIREMENTS ARE TAILORED TO THOSE OF REFERENCE (c), AS QUALIFIED PIPE BRAZERS ARE ALSO CONSIDERED QUALIFIED FOR ALL OTHER BRAZING WITHIN THE SCOPE OF THEIR PIPE QUALIFICATIONS (I.E., PROCESS, MATERIAL AND THICKNESS LIMITATIONS).

- b. To provide uniformity and enhance the effectiveness of the welder/brazer program the following conditions shall apply:

- (1) Once started, all qualifications shall be completed as expeditiously as possible. Therefore, personnel attempting to qualify shall be given ample opportunity to complete the qualification test in a timely manner. Qualification testing shall not be assigned if anticipated work load, leave schedules, shiftwork or other controllable factors will delay test assembly completion.
 - (2) No more than three qualification tests per welder or brazer will be in progress at any one time.
 - (3) For training purposes, the Welding or Brazing Shop Supervisor shall make arrangements with the NDT Supervisor to review the records (including radiographic film) of failed qualification test assemblies. The NDT Supervisor will discuss the results with the qualifier, focusing on the reasons for rejection, types and locations of defects found, and possible corrective actions. The arrangements should include welder/brazer observation of actual test results whenever possible.
 - (4) Because a welder or brazer meets the qualification requirements of a particular specification or standard does not always assure his/her proficiency in all phases of diversified production tasks for which he/she is qualified. To this end activities should strive for continual improvement, both in the qualification and proficiency of its welders and brazers.
- c. Stud or Spot Welders. NEC 4955 welder or welding operator qualification is not required for operators of stud or spot welding equipment.

4.2.1 Eye Examination. Annual vision tests shall be passed by each brazer and welder. Vision tests shall be conducted by the medical department, cognizant NDT Examiner or delegated personnel, using standard methods for determining visual acuity. The standard for acceptance shall be natural or corrected near distance acuity such that the brazer/welder is capable of reading J1 letters on a standard Jaeger type chart. Equivalent visual tests may be used. Corrective aids used during the visual test shall be worn during qualification testing and production fabrication. Reference (b) contains the color test requirement for Titanium welders.

4.2.2 Brazing and Welding Procedures. Brazing and Welding procedures, qualified in accordance with references (b) or (c), as applicable, shall be on hand for all applications for which performance qualification is intended. Although not specifically required, the brazer/welder should use the procedural requirements for training and familiarity purposes during qualification testing.

4.2.3 Brazing and Welding Personnel Knowledge. Each brazer and welder shall receive documented training on the workmanship and detailed visual inspection requirements of fabrication documents used by the activity.

4.2.4 Brazer and Welder Identification Numbers. Upon meeting the requirements of this section, brazers and welders receive a unique identification number, issued by the respective Division Officer, for identification of brazing or welding performance.

4.2.4.1 Brazer and Welder Identification Number Log. The Division Officer shall maintain a log of unique identification numbers assigned to brazers/welders. The number assigned shall be alphanumeric as illustrated in the following example:

A -12 -B or W.

Where: A = First letter in brazer's or welder's last name.

12 = Sequential number alphabetical in list of personnel.

B or W = B for brazer or W for welder.

Each entry shall contain the date the number was assigned, the brazer/welder's name and signature, the identification number, the date the brazer/welder completed the initial training specified in paragraph 4.2.3 of this chapter and the brazer/welder's projected rotation date.

4.2.5 Validation of Qualification. All brazer/welder qualifications, re-qualification, and maintenance of qualification shall be valid only if original qualification is recorded in the individual's service record in accordance with reference (a). A service record entry (NAVPERS 1070/613) shall be made upon initial qualification, annually

(not to exceed 12 months) and before transfer. This service record entry shall include all subsequent re-qualifications and the most current vision test results. The brazer/welder's Division Officer shall be responsible for ensuring these entries are made.

4.2.6 Qualification Records.

4.2.6.1 Individual Brazer/Welder Qualification File. In order to achieve proper monitoring of brazer/welder qualifications, the individual's Division Officer shall maintain an auditable file for each brazer/welder assigned. This file is to be maintained for each brazer/welder for as long as he/she is assigned to a command and transferred with the welder or brazer to their next command. These files shall include all information that is required by references (a), (b) and (c) and include the following:

- a. Brazer/Welder identification number (name, rate, individual identification number).
- b. Test date/Use of process date.
- c. Qualification test number, process, position, base material type, filler material type and size, or brazing alloy type and size.
- d. Test results (i.e., Accept/Reject). A statement as to the cause of rejection will be entered, if appropriate.
- e. Record of omission of space restriction when not used on pipe tests.
- f. Workmanship and visual inspection requirements examination results per reference (b).
- g. Certifying signature (Division Officer or designated representative).
- h. Vision test form:
 - (1) Identification.
 - (2) Test date.
 - (3) Test description.
 - (4) Test results.
 - (5) Corrective aids as required.
 - (6) Certifying signature (medical department, cognizant NDT Examiner or delegated personnel).

4.2.6.1.1 Maintenance of Qualification. Detailed records of maintenance of qualification need only be retained for the current and preceding quarter. In order to ensure proper maintenance of brazer/welder qualifications, a log shall be maintained by each Division Officer. This log shall include items a., b., d., and g. of paragraph 4.2.6.1 of this chapter. In addition, this log will also include the brazing or welding process (i.e., H-101, SMAW, GTAW, etc.) used during maintenance of qualification. This maintenance of qualification log may be a separate log from the brazer/welder file or it may be incorporated into the brazer/welder file as part of the file itself.

4.2.6.2 Method of Qualification Maintenance. Brazers and welders should maintain their qualifications on production jobs. If production work is unavailable, a brazing test assembly or test assembly weld joint meeting the requirements of reference (b) for welders and reference (c) for brazers may be used. Only joints meeting all applicable acceptance criteria will be used for this purpose. Surface Ships lacking NDT personnel may only allow the brazer/welder qualification to lapse with Type Commander approval. If a joint is assembled by personnel whose qualifications have lapsed or without the support of qualified NDT personnel, a Departure from Specification must be submitted and the joint must be reassembled using qualified personnel during the next maintenance support opportunity.

4.2.6.3 Renewal of Qualification. Renewal of qualification shall be in accordance with reference (b) for welders, and reference (c) for brazers.

4.2.7 Effective Date of Qualification. Effective date of qualification shall be from the date that the test assembly brazing/welding is complete. Initial qualification is effective only after the final NDT is completed but the date of qualification is the date the weld or braze was completed. For re-qualification the re-qualification is only effective after the final NDT is completed but the effective qualification date must be the day the weld or braze was completed.

4.2.7.1 Qualification Results. The NDT Supervisor shall ensure that:

- a. Qualification results are forwarded to the brazer/welder Division Officer.
- b. Each test assembly is marred, marked, or otherwise identified so as to preclude its re-use.

4.3 BRAZER QUALIFICATIONS.

4.3.1 Prerequisite. Prior to performing any qualification or production brazing the brazer must have successfully completed training in workmanship and detailed visual inspection requirements and passed a written examination with a grade of no less than 75%. The training and examinations for all brazers will be based on the requirements set forth in reference (c).

4.3.1.1 Qualification Test. A brazer qualification shall be in accordance with reference (c) for piping and pressure vessels.

4.3.2 Limitations. Limitations will be in accordance with reference (c).

4.3.3 Test Assembly Evaluation. Test assemblies shall be visually and ultrasonically inspected or a peel test may be conducted as specified in reference (c).

4.3.4 Maintenance of Qualification. A brazer maintains his/her qualifications by using the process(es) he/she used during initial qualification at least once in each calendar quarter subsequent to the quarter in which he/she qualified and four times in each subsequent calendar year.

NOTE: THE VERIFICATION OF PROOF OF PROCESS WILL BE DONE BY THE DIVISION OFFICER, OR HIS/HER REPRESENTATIVE, AND DOCUMENTED.

4.3.5 Qualification Renewal. A brazer must renew his/her qualifications in accordance with reference (c).

4.3.6 Transfer of Qualification. Qualifications may be transferred from one activity to another when the requirements of reference (c) are met.

4.4 QUALIFICATION REQUIREMENTS FOR NAVY ENLISTED CLASSIFICATION CODE 4955 WELDERS.

4.4.1 Qualification Prerequisites.

4.4.1.1 Navy Enlisted Classification Code Achievement. To achieve a welding NEC the welder must successfully meet all the requirements of reference (a). Welders shall attend welding school except for aluminum welding and brazing. Training for welding aluminum and brazing is conducted at parent commands.

4.4.1.2 Specific Qualifications. Qualifications for specific additional welding processes, filler metal groups and welding positions may be obtained as defined in reference (a).

4.4.2 Maintenance of Qualification. A welder maintains his/her qualifications by using the process(es) he/she used during initial qualification at least once during each three month period or calendar quarter. In addition, for titanium welders and welding operators, verification of process used on titanium base metal during each 6-month or two consecutive calendar quarters shall also be maintained.

NOTE: THE VERIFICATION OF PROOF OF PROCESS WILL BE DONE BY THE DIVISION OFFICER, OR HIS/HER REPRESENTATIVE, AND DOCUMENTED. FINAL ACCEPTANCE OF CONTROLLED WELDING STILL REQUIRES NDT PERSONNEL, BUT THE PROOF OF PROCESS FOR MAINTENANCE OF QUALIFICATION MAY BE DONE BY THE DIVISION OFFICER OR HIS/HER REPRESENTATIVE.

4.4.3 Qualification Renewal. A welder must renew his/her qualifications in accordance with reference (b).

4.4.4 Transfer of Qualification. Qualifications may be transferred from one activity to another when the requirements of reference (b) are met.

4.4.5 Waiver of Qualification Tests. Qualification tests of welders working on assemblies as described in reference (b) may be omitted provided this omission is permitted by the applicable fabrication document or is approved.

4.5 NON-CODED HULL TECHNICIANS.

4.5.1 Authorization. Non-coded Hull Technicians are authorized to perform welding on a Minor Structure designated as Category F. Category F welds are repairs performed on "minor structure" assemblies, where the possibility of failure is remote, and failure would not result in danger to ship's personnel or the ship. Minimum qualifications are:

- a. Be a qualified Hull Technician.
- b. Be a qualified Maintenance Worker in accordance with reference (g).
- c. Be a qualified Quality Assurance Craftsman in accordance with PQS 43523-B.
- d. Have completed Job Qualification Requirements.
- e. Have received documented training on the safety requirements associated with welding as outlined in reference (a).
- f. Will be qualified in accordance with reference (b) for Category F welds, except for being assigned a welding code NEC, and will maintain proficiency in accordance with reference (b).

4.5.2 Minor Structure Components.

- a. The following list identifies components which are considered "minor structure".
 - (1) Nonstructural joiner bulkheads/non-watertight bulkheads.
 - (2) Partitions, lockers and gratings.
 - (3) Non-ballistic wire way and ventilation trunks.
 - (4) Pipe Hanger Brackets not attached to hull and are non critical.
 - (5) Cableway Brackets not attached to hull and are non critical.
 - (6) Galley fixtures.
 - (7) Label plates, name plates.
 - (8) Furniture.
 - (9) Hand railings.
 - (10) Operating platforms.
 - (11) Hand-grabs and ladders.
 - (12) Weld fills for deck plates.
 - (13) Stuffing tubes above weather decks.
 - (14) Ventilation and air conditioning ducts.
 - (15) Protective covers for gear belts and chain drives.
 - (16) Vents, overflows and drains.
- b. Some specific examples are:
 - (1) Welding corners on lockers and rack pans fabricated by the sheet metal shop.
 - (2) Fabricating and weld framing for non-watertight doors, false bulkheads and office desks.
 - (3) Fabrication of collars for gas cylinders.
 - (4) Fabrication and welding of pipe hangers, cable hangers and ventilation hangers for systems which have operating pressures less than 50 psi or temperatures less than 200 degrees F.
 - (5) Brazing of funnels for later installation in shipboard gravity drain systems.

4.6 QUALIFICATION REQUIREMENTS FOR NONDESTRUCTIVE TEST PERSONNEL.

4.6.1 Purpose.

- a. To provide guidance on the procedures that must be followed to maintain NDT qualifications or attain NDT re-qualification in accordance with references (d) and (f).
- b. Naval NDT personnel are qualified by being examined by a NDT Examiner in accordance with references (d) and (f).

4.6.2 Levels of Certification. NDT personnel are certified in accordance with references (d) or (f). Military personnel certified in accordance with reference (f) will be assigned NECs per reference (e).

- a. Level I (NDT Operator): An individual certified to NDT level I is qualified to carry out NDT operations in accordance with written instructions and under the supervision of level II or level III personnel. The individual shall have the skills and knowledge to properly perform specific calibrations, specific tests, set up equipment, carry out specific inspections, record the results obtained, classify the results in accordance with written criteria and report the results. He/she shall not be responsible for the choice of the test method, technique to be used, or for the final assessment of the test results.
- b. Level II (NDT Inspector): An individual certified to NDT level II is qualified to perform and direct non-destructive testing in accordance with established or recognized techniques. The individual shall be competent to choose the test techniques to be used; to set up and calibrate equipment; to interpret and evaluate results in accordance with applicable codes, standards and specifications; to carry out all duties for which a level I individual is qualified; to organize and report the results of non-destructive tests. The individual shall also be familiar with the scope and limitations of the methods for which he/she is qualified, and be able to exercise assigned responsibility for on-the-job training and guidance of trainees and level I personnel.
- c. Level III (NDT Examiner): An individual certified to NDT level III shall be capable of assuming full responsibility for a test facility and staff; establishing techniques and procedures; interpreting codes, standards, specifications and procedures; and designating the particular test methods, techniques and procedures to be used. Shall develop NDT procedures in accordance with reference (d), adapted to the problems that are the subject of an NDT inspection; and to prepare written instructions. The individual shall have the competence to interpret and evaluate results in accordance with existing codes, standards and specifications; have a sufficient practical background in applicable materials, fabrication and product technology to select methods, establish techniques and to assist in establishing acceptance criteria where none are otherwise available; have general familiarity with other NDT methods and have the ability to train level I and level II personnel.

4.6.3 Certification of Nondestructive Test Personnel. Only those individuals who have successfully completed the Naval NDT of Metals course or commercial equivalent for civilian personnel can be certified by a NDT Examiner. NDT Inspectors will re-certify in accordance with reference (d) or (f).

4.6.4 Renewal of Certification. NDT Examiners will re-certify in accordance with reference (d) or (f).

4.6.5 Maintenance of Qualification.

- a. NDT personnel will maintain qualification in accordance with reference (d).
- b. NDT testing personnel must pass an annual vision test in accordance with reference (d).

4.6.6 Qualification Administration.

- a. Command NDT Examiners shall be designated in writing.
- b. Service Record Entries. Each NDT Inspector will have his/her service record updated to reflect current qualifications annually, as a minimum, and immediately prior to transfer. These periodic service record updates will be accomplished by entry on (NAVPERS 1070/613).
- c. NDT Examiner/Division Officer, as appropriate, will maintain an individual NDT personnel record in accordance with reference (d) for each NDT Examiner and Inspector.

4.6.7 Approval of Nondestructive Testing Qualification Examinations. A NDT Examiner shall approve the NDT Inspector Qualification Examinations and visual test materials.

4.6.8 Transfer of Qualification. Qualifications being transferred from one naval facility to another must be evaluated to the satisfaction of the NDT Examiner of the new facility.

4.6.9 Nondestructive Testing Personnel Records. NDT Inspector/Operator records will be maintained by the NDT Examiner in accordance with reference (d) and will consist of:

- a. All qualification documentation shall be in accordance with reference (d) (e.g., training and qualification documents).
- b. Copy of current eye examination.

4.6.10 Nondestructive Testing Qualification Log. The NDT Supervisor will maintain an NDT personnel qualification log that will be used to record and maintain qualifications for each individual assigned. Each operator/inspector will have a separate section in the NDT qualification log that satisfies the requirements of paragraph 4.6.9 of this chapter. The NDT Supervisor or designated representative will update the NDT personnel qualification log. This will be based upon the completion of NDT performed as shown by completed NDT reports. This log may be maintained either as a hard copy or electronic copy.

4.6.11 Qualification of Generic Material Identity Testing Personnel. Personnel who perform generic materials identity testing will be qualified as required by local procedure which will include the following minimum requirements:

- a. An eye examination satisfying the requirements of reference (a).
- b. Training on the procedures of reference (h).
- c. Training on the procedures for materials not in reference (h) used by the command.
- d. Training on standard requirements.
- e. Training on safety precautions associated with generic testing.
- f. Training on reagent requirements and shelf life.
- g. Testing requirements and designation of who performs the examinations.
- h. Certification by the Quality Assurance Officer.
- i. Re-qualification/qualification updating requirements.
- j. For other than chemical testing programs, qualification will be in accordance with reference (i) or other applicable equipment technical manuals.

4.6.12 Qualification Administration. Command Generic Material Identity Examiners shall be designated in writing and approve Generic Material Identity Test Inspectors qualification examinations and test materials.

4.6.12.1 Transfer of Qualification. Generic Material Identity Testing Personnel. Since qualification is by local procedure, testing personnel must perform at a level of proficiency which is satisfactory to the Test Examiner at the new activity.

(This Page Intentionally Left Blank)

VOLUME V
PART I
CHAPTER 5
IN-PROCESS CONTROL

REFERENCES.

- (a) NAVSEA S9510-AB-ATM-010/020 - Nuclear Powered Submarine Atmosphere Control Manual
- (b) NAVSEA S9086-RJ-STM-010 - NSTM Chapter 504 (Pressure, Temperature and other Mechanical and Electromechanical Measuring Instruments)
- (c) NAVSEA 389-0317 - Procedures for Maintenance and Repair of Naval Reactor Plants (Nuclear)
- (d) NAVSEA 0989-LP-043-0000 - Commissioned Surface Ship General Reactor Plant Overhaul and Repair Specification
- (e) NAVSEA 0989-LP-037-2000 - Commissioned Submarine General Reactor Plant Overhaul and Repair Specification
- (f) NAVSEA S9505-AM-GYD-010 - Submarine Fastening Criteria (Non-Nuclear), Description, Design and Maintenance
- (g) NAVSEA S9086-CJ-STM-010 - NSTM Chapter 075 (Threaded Fasteners)
- (h) MIL-STD-1330 - Standard Practice for Precision Cleaning and Testing of Shipboard Oxygen, Helium, Helium-Oxygen, Nitrogen and Hydrogen Systems
- (i) NAVSEA S9086-T4-STM-010 - NSTM Chapter 589 (Cranes)
- (j) NAVSEA MS 7650-081-091 - Submarine Hull Inspection
- (k) NAVSEA MS 6310-081-015 - Submarine Preservation
- (l) NAVSEA 0989-064-3000 - Cleanliness Requirements for Nuclear Propulsion Plant Maintenance and Construction
- (m) NAVSEA 0989-LP-058-1000 - Destroyer Tender and Submarine Tender Nuclear Support Facilities Overhaul and Repair Specification
- (n) MIL-STD-767 - Cleaning Requirements for Special Purpose Equipment, Including Piping Systems
- (o) NAVSEAINST 9210.41 - All Naval Nuclear Propulsion Plants - Use of Standard Lubricants and Penetrating Fluid; Requirements for
- (p) NAVSEA S9086-CM-STM-010 - NSTM Chapter 078 (Gaskets, Packing and Seals)
- (q) MIL-STD-413 - Visual Inspection Guide for Elastomeric O-Rings
- (r) NAVSEA 0924-062-0010 - Submarine Safety (SUBSAFE) Requirements Manual
- (s) COMSUBLANTNOTE C3120 - Submarine Operating Restrictions and Depth Authorizations
- (t) COMSUBPACNOTE C3120 - Submarine Operating Restrictions and Depth Authorizations
- (u) NAVSEA T9044-AD-MAN-010 - Requirements Manual for Submarine Fly-By-Wire Ship Control Systems
- (v) Fly-By-Wire Ship Control System Certification Boundary Book (ship specific)
- (w) NAVSEA SL720-AA-MAN-020 - Fleet Modernization Program (FMP) Management and Operations Manual
- (x) NAVICPINST 4441.170 - COSAL Use and Maintenance Manual

LISTING OF APPENDICES.

- A Determining Software Usability
- B Format for Submarine Certification Continuity Report
- C Format for Fleet Maintenance Activity Certification Report to Tended Submarine
- D Format for Non-Fleet Maintenance Activity Certification Report to Tended Submarine
- E RPCCR Cover Letter for SHIPALTS (Sample)
- F Technical Manual Deficiency Report (TMDER)
- G Fleet COSAL Feedback Report

5.1 PURPOSE. To provide the requirements or direct the user to the appropriate references to ensure that maintenance performed during the ship's life cycle (new construction through decommissioning) supports certification at all times. All material used within any nuclear and non-nuclear submarine pressure hull shall be certified for use in accordance with reference (a).

5.2 TEST, MEASUREMENT AND DIAGNOSTIC EQUIPMENT.

5.2.1 General Requirements. Test, Measuring and Diagnostic Equipment (TMDE) for in-process work must be properly selected and used. TMDE requiring periodic calibration must be within its calibration periodicity when in use. All TMDE should be selected ensuring the equipment is of the proper range to perform the test, inspection or repair. The craftsman and Quality Assurance Inspector (QAI) should inspect all TMDE prior to use and reject questionable equipment. When inspections or measurements using TMDE are performed with the results documented on a Quality Assurance (QA) form, the type of equipment, range, serial numbers and calibration due dates for TMDE used will be recorded on the QA form as part of the Objective Quality Evidence (OQE).

5.2.2 Torque Wrenches.

- a. Selection. Torque wrenches should be selected in such a manner that the required final torque falls within 20% to 90% of the torque wrench range. For example:
 - (1) A torque wrench with a scale range of 0-100 ft-lbs can be used for a maximum torque of 90 ft-lbs and a minimum torque of 20 ft-lbs.
 - (2) A torque wrench with a scale range of 50-250 ft-lbs can be used for a maximum torque of 225 ft-lbs and a minimum torque of 50 ft-lbs.
- b. Calibration. Calibration should be verified to be within the required periodicity (based on due date on the calibration label) prior to use. Most Navy torque wrenches are calibrated for use in one direction only. These tools will have a label affixed stating, "Use Clockwise Only" or "Use Counterclockwise Only". The tool can be used only in the direction indicated. Torque tools calibrated for bi-directional use will bear a yellow "SPECIAL CALIBRATION" tag or label indicating that the tool was calibrated for use in both directions. Navy torque wrenches can be calibrated for bi-directional use only if specifically authorized by model number in the latest Naval Sea Systems Command (NAVSEA) OD 45845.
- c. Micrometer adjustable torque wrenches. To ensure acceptable performance of micrometer adjusted torque wrenches, users must adhere to the following requirements:
 - (1) Exercise the wrench (apply pressure until snap mechanism activates) six times at approximately 60 percent of the rated maximum value before each use. This procedure minimizes the erratic readings often experienced with this type of wrench during the first few activations.
 - (2) Micrometer-type wrenches to be used in counterclockwise applications should be calibrated in the counterclockwise direction and marked as such.
 - (3) Some micrometer "click" type torque wrenches do not accommodate torque values down to 20 percent of the maximum rated capacity. Requests to use a specific torque wrench/meter, outside of the ranges specified above, require an engineering evaluation and written authorization from a technical warrant.
- d. Extensions/Adapters. Torque wrenches are calibrated based on the specific length of the wrench as established by the wrench manufacturer. Use of an extension changes the effective length of the wrench. The actual torque being applied to the fastener will be different than that indicated on the wrench dial. Any time extensions are used, the following mathematical formulas should be used to determine the wrench dial reading required for the required applied torque:

NOTE: EXTENSIONS CAN SIGNIFICANTLY AFFECT THE APPLIED TORQUE TO INDICATED TORQUE RELATIONSHIP. ANY EXTENSION OTHER THAN A DIRECT ATTACHMENT (I.E., CROWSFOOT) MUST BE TAKEN INTO ACCOUNT.

$$T_{ind} = \frac{T_{act} \times L_1}{L_1 + L_2}$$

Where:

T_{act}	=	Applied torque required
T_{ind}	=	Torque indicated on dial
L_1	=	Length of torque wrench
$L_1 + L_2$	=	Length of torque wrench plus length of extension

When an adapter or extension is used on a torque wrench it increases the torque range of the wrench. The formula for computing torque when using an adapter or extension is explained in Figure 5-1 of this chapter.

Figure 5-1 Use of Torque Wrench Adapters

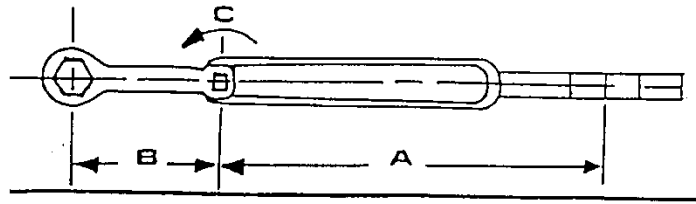

FORMULA FOR USING ADAPTERS

C = ACTUAL TORQUE APPLIED TO WRENCH A = DISTANCE FROM DRIVE TO PULLER'S HANDGRIP
 B = LENGTH OF ADAPTER T = TORQUE REQUIRED FOR FASTENER

FORMULA: $C = \frac{A \times T}{A + B}$ PROBLEM: $\frac{28 \times 200}{28 + 9} = \frac{5600}{37} \quad C = 150$

ADAPTER REQUIRING REVERSE CORRECTION

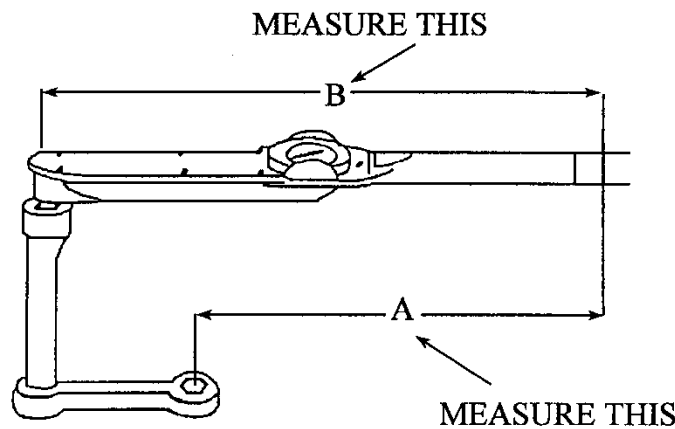

A = TOTAL LENGTH = 18" B = TORQUE WRENCH LENGTH = 24" C = CORRECTION FACTOR = A ÷ B = 18 ÷ 24 = 0.75
 T = TORQUE REQUIRED FOR FASTENER

FORMULA FOR USE OF CORRECTION FACTOR

D = Actual Torque Applied to Wrench C = Correction Factor = A ÷ B

Formula: $D = \frac{T}{C}$ Problem: $\frac{200}{.75} = 266$

5.2.3 Gauges.

- a. General. Gauges used for in-process functions, whether installed in the system or temporary, must be verified to be within calibration periodicity prior to use. Craftsmen should ensure the appropriate calibration information is recorded on the QA form.

- b. Non-Nuclear Hydrostatic Testing. Master test gauges and backup gauges used for hydrostatic testing shall be selected and the calibration verified current in accordance with reference (b) and Volume IV, Chapter 9 of this manual.

5.3 TORQUE.

5.3.1 General Requirements. Care must be used when torquing fasteners or plugs. Special attention is required to select the proper torque specification for a given application/specification as it is specifically selected to reduce the tendency for the fastener to loosen in service and to improve the fastener fatigue life. Torque requirements found in drawings, Maintenance Standards (MS) or technical manuals, etc. will be used in preference to general guides for torquing. If no specific torque requirement exists, references (c), (d), (e), (f) or reference (g) may be used as guidance but ensure that the information applies exactly to the system and fastener type being torqued.

5.4 INSPECTIONS.

5.4.1 General Requirements. This section provides the minimum requirements and guidance for the performance of inspections. Inspections during the performance of maintenance form one of the fundamental elements essential in assuring that the task is completed properly and in compliance with all specifications. Inspections occur during the in-process phase of repair/maintenance (disassembly, repair, and re-assembly) and the re-certification phase (testing). Inspections serve to provide a careful and critical examination of the areas being inspected and form one of the cornerstones of a successful QA Program. Use of inspections have and will continue to establish the OQE necessary for ensuring compliance to technical requirements.

5.4.2 Inspection Records. Inspection records provide a lasting record that the inspection was performed and completed according to the applicable specifications. Inspection records will be maintained when required for OQE and will be documented on appropriate QA forms contained in this volume, or as Certification Signature Blocks in the Formal Work Package (FWP).

5.4.3 Critical Inspections. An inspection on any system or component, which by its nature is so critical to the successful completion of the task, that the inspection requires verification by a separate individual, other than the craftsman, qualified as an inspector. These inspections will be annotated in the written work procedure by the presence of an (I) or circle I, or in the case of Cleanliness Inspections (CI) or circle CI in the margin next to the applicable paragraph requiring the inspection and will be documented either as a Certification Signature Block (for those nuclear work items in Part 2 Chapter 1 of this volume) or signature, as applicable, in the FWP or on the appropriate QA form.

NOTE: THESE ARE CONSIDERED MINIMUM REQUIREMENTS FOR USAGE OF AN INDEPENDENT INSPECTOR DURING THE PERFORMANCE OF CONTROLLED WORK. IT MUST BE UNDERSTOOD THAT THE REQUIREMENTS FOR AN INDEPENDENT INSPECTOR DO NOT NECESSARILY MEAN THAT THE DATA PROVIDED IS RETAINABLE AS OQE. VARIOUS SOURCE DOCUMENTS ADDRESS RECORD RETENTION AND SHALL BE FOLLOWED FOR ENSURING THE PROPER OQE IS RETAINED.

- a. Critical Inspections applicable to all platforms are as follows:
 - (1) Inspections performed for all acceptance testing (e.g., hydrostatic testing, drop tests, joint tightness tests, weight tests) for certification of work completed under a Controlled Work Package (CWP). (Nuclear and non-nuclear manually operated valves which have adjustable packing do not require certification by an independent inspector.)
 - (2) Inspections performed to verify permanent markings of Level I material (those which the Fleet Maintenance Activity (FMA) manufacture, upgrade, or transfer to smaller pieces of controlled material). These inspections may also be performed by a Controlled Material Petty Officer.
 - (3) Mechanical measurements used to verify wall thickness of components for work performed using a CWP.
 - (4) Inspections performed for post machining of any Level I component.
 - (5) All sealing surface inspections for work performed as a Controlled Assembly.

- (6) Inspections for oxygen, nitrogen, and hydrogen systems cleanliness as required by reference (h). These independent inspections are performed by personnel qualified as Oxygen Clean Workers in accordance with reference (h).
 - (7) Material receipt inspection. These inspections may also be performed by a Controlled Material Petty Officer.
 - (8) Weight testing to certify or re-certify shipboard cranes when repairs are performed in accordance with reference (i).
 - (9) Performance of Emergent Controlled Work in accordance with Part I, Chapter 2 of this volume.
 - (10) Verification of body bound stud standout measurements and break away torque for stud installations in Scope of Certification (SOC), Submarine Safety (SUBSAFE) and Level I systems.
- b. Additional Critical Inspections applicable to submarines and Deep Submergence Systems (DSS) only.
- (1) Sealing surface inspections for all SUBSAFE Hull Integrity joints and SOC bolted pressure boundary joints.
 - (2) Hull Integrity joint body bound stud inspections. For new stud installations, this includes stud standout measurements and break away torque verification. For studs that were not removed and are to be reused, this includes verification of markings of significance (.K. or KM) or completion of generic material identification check.
 - (3) Final torque verification of SUBSAFE Hull Integrity and SOC bolted pressure boundary joints.
 - (4) Verification of new controlled material installed into the SUBSAFE or SOC boundary.
 - (5) Verification of proper software installation in SUBSAFE Hull Integrity or SOC bolted pressure boundary joints.
 - (6) Stack height measurement verification for hull packing installation (e.g., periscope, rudder, planes).
 - (7) Seat tightness tests of SUBSAFE hull and backup valves. When seat tightness testing is impractical, verification of stack height and cavity dimensions or seat blue checks as applicable.
- c. Visual inspection of submarine structure in between Unrestricted Operations (URO) MRC 003 Inspections.

NOTE: NOT APPLICABLE TO SUBMARINES AT SEA OR SHIP'S FORCE MAINTENANCE ACTIONS OUTSIDE A SCHEDULED REFIT/FLEET MAINTENANCE AVAILABILITY/CHIEF OF NAVAL OPERATIONS AVAILABILITY. THE SHIP SHALL REPORT ANY UNUSUAL, UNEXPECTED OR POTENTIALLY DANGEROUS CONDITIONS AND/OR LARGE PRESERVATION FAILURES TO THE TYPE COMMANDER (TYCOM) AS SOON AS POSSIBLE. CURRENT SHIP'S MAINTENANCE PROJECT ENTRIES SHALL DOCUMENT DEFICIENCIES FOUND AND DEPARTURES FROM SPECIFICATION (DFS) SHALL BE WRITTEN IF SO DIRECTED BY TYCOM.

- (1) Submarine tanks and other areas not scheduled for a URO MRC 003 inspection and which are more than halfway to the next scheduled URO MRC 003 inspection based on the inspection periodicity, and which are opened/entered for other reasons, shall receive a visual examination in the vicinity of work being conducted and the path to the work by personnel qualified per reference (j). Any evidence of preservation systems breakdown, corrosion, thickness reduction, and/or deformation and cracking shall be evaluated in accordance with the requirements of references (j) and (k). Any unusual, unexpected or potentially dangerous conditions such as, but not limited to, large preservation failures, extensive early corrosion or severe damage shall be reported immediately to NAVSEA (SEA 07T12) via TYCOM by telefaxed letter or message to determine if there is a structural integrity problem.

- (2) Any normally wetted, previously obscured areas (i.e., areas not visible during normal operations) of the submarine pressure hull, non-pressure hull, tanks and/or supporting structure (interior or exterior) in way of any components, hull insulation, or damping or acoustic material which is removed for other reasons shall receive a visual examination by personnel qualified per reference (j) for any evidence of preservation systems breakdown, corrosion, thickness reduction, and/or deformation and cracking. Any evidence of the above shall be evaluated and corrected in accordance with the requirements of references (j) and (k). Results of examinations shall be submitted in accordance with the reporting format required by references (j) and (k). Any unusual, unexpected, or potentially dangerous conditions such as, but not limited to, large preservation failures, extensive early corrosion, or severe damage shall be reported immediately to NAVSEA (07T12) via TYCOM by telefaxed letter or message to determine if there is a structural integrity problem.

5.4.4 Cleanliness Inspections. Cleanliness controls are required to prevent the entry of foreign material which could interfere with the operation of any system or component. Cleanliness controls are essential during maintenance with the degree of control depending upon the system and work to be accomplished. Steam plant system cleanliness controls are necessary to minimize corrosion of steam plant materials and prevent the entry of foreign materials into the steam plant. Improper cleanliness controls can result in damage to operating machinery, chloride contamination, or fouling of system components. The time spent making sure the work site is clean and system openings are properly controlled will help prevent premature component failure and rework.

- a. Cleanliness Inspectors are individuals who are trained and qualified to perform CI required by work procedures for systems/components requiring cleanliness controls. At the TRIDENT Refit Facilities, they are called Cleanliness Certifiers.

NOTE: ALL SYSTEMS REQUIRE VARYING DEGREES OF CLEANLINESS CONTROLS, BUT MAY NOT REQUIRE AN INDEPENDENT INSPECTOR. CRITICAL QUALITY CONTROL POINT INSPECTIONS BY SUPERVISORY PERSONNEL SHOULD BE USED WHERE APPROPRIATE.

- b. Acceptance inspections of cleanliness by an independent inspector (Cleanliness Certifier/Inspector) are required for the following as a minimum:
- (1) Oxygen, nitrogen, and hydrogen systems per reference (h).
 - (2) Naval Nuclear Propulsion systems **as required by reference (l)**.
- c. Results of cleanliness acceptance inspections required by paragraph 5.4.4.b of this chapter shall be documented in the Technical Work Document and certified by a signature **for those inspections requiring independent inspection**.
- d. There are no specific requirements for independent CI/acceptance by a Cleanliness Certifier/Inspector, during steam plant (nuclear or fossil fuel) system maintenance. However, for maintenance involving steam plant (nuclear) systems, the cleanliness requirements for steam plant (nuclear) systems from Chapters 1 and 3 of reference (l) apply. For steam plant (fossil fuel) or general shipboard systems listed in paragraph 5.4.6 of this chapter, the cleanliness requirements shall be determined during the work planning phase. Many jobs may be performed using craftsman to verify cleanliness vice requiring independent Cleanliness Inspector presence. When the risk or consequence of loss of cleanliness is minimal during a maintenance action, such as work requiring bonnet removal from a small steam valve, maintenance of cleanliness may be verified by the craftsman. When the risk or consequences of loss of cleanliness is significant, such as when removing the bonnet from a main steam root valve, work involving opening of turbine throttles, or when the type or quantity of detrimental materials (e.g., cutting oils) pose a significant risk, the use of an independent inspector to verify maintenance of cleanliness should be considered by the Department Head, Quality Assurance Officer (QAO), and Planning Officer (if assigned).
- e. It is the responsibility of Ship's Force to ensure the appropriate cleanliness control requirements are incorporated in any maintenance for which clear responsibility for cleanliness is not assigned.

5.4.5 Nuclear Propulsion Plant and Nuclear Support Facility General Cleanliness Requirements.

5.4.5.1 Reactor Plant. For work involving the cleanliness requirements of Chapters 1, 2 and 3 of reference (1), inspector presence is required for initial opening of a reactor plant system when the opening is accomplished using a dirt producing procedure such as a butt weld cut or pipe cut. For non-dirt producing methods, such as socket weld cuts, cuts on canopy seals and the opening of a flange, the worker may verify cleanliness without the presence of a Cleanliness Inspector. For either case, the worker will first establish a clean area and then open the system. The system will then be inspected for cleanliness by the worker or inspector depending on the method used for opening the system. The worker will then install cleanliness plugs, disestablish the clean area and perform the required repair. Upon completion of the repair, the worker will clean the area and inspector presence is again required for system inspection prior to closure of the opening.

- a. Maintenance personnel and appropriate supervisors shall be briefed by a QAI on applicable requirements before starting work. The brief shall include at least the following:
 - (1) Inspection requirements.
 - (2) Acceptance criteria.
 - (3) Methods to maintain cleanliness.
 - (4) Required actions for a loss of cleanliness.
- b. Cleanliness plugs that are locally manufactured or procured through the Navy supply system shall meet the requirements of reference (1). A logbook shall be kept by the appropriate work center or work center supervisor recording all cleanliness plugs by serial number. Additionally, a QAI shall document that the requirements of Chapter 1 of reference (1) for Temporary Seals and Plugs have been met regardless of procurement method or each plug recorded in the logbook.
- c. If a loss of cleanliness occurs as explained in reference (1), then cleanliness shall be re-established according to the requirements and procedures of reference (1). Upon a loss of cleanliness, the Lead Work Center Division Officer, QAO and appropriate Department Head(s) will approve the recovery procedures.
- d. Use a Tool and Material Accountability Log to document the required accountability whenever foreign material exclusion controls are established. A formal written record shall be maintained for all material (e.g., tools, equipment, temporary plugs and seals and tape) taken inside the physical boundary that are small enough to fit inside the material openings in the hardware and do not have lanyards attached. The record shall describe the material, where it was introduced and when it was removed. Except for eyeglasses and goggles, accountability is required for all clear plastic material regardless of size.
- e. Control of tools shall be as specified in reference (1) and this volume. Work center supervisors will be responsible for control of handling equipment and metal removal and finishing tools. Additionally, the following requirements consistent with reference (1) apply for metal removal and finishing tools: Except for cutting tools (drills, bits, taps, etc.), metal removal and finishing tools (files, wire brushes, grinding wheels, etc.) used on corrosion-resistant or carbon steel materials will be segregated from general work center metal removal and finishing tools and fasteners.

5.4.5.2 Steam Plant. Reference (1) provides a list of applicable steam plant systems and the minimum steam plant cleanliness requirements. It applies to all steam plant work performed in naval nuclear powered ships when not at a shipyard. This chapter also applies to steam plant work performed by forces afloat when at a shipyard.

- a. Nuclear powered ship steam plant maintenance affecting those systems listed in Chapter 1 of reference (1) shall be assigned only to activities that have reference (1) in force.
- b. The Steam Plant Manual/Steam and Electric Plant Manual shall be consulted for cleanliness requirements when performing steam plant maintenance.
- c. If a loss of cleanliness occurs as explained in reference (1), then cleanliness shall be reestablished according to the requirements and procedures of reference (1). Additionally, upon a loss of cleanliness the QAO, the Lead Work Center Division Officer, and appropriate Department Head(s) will approve the recovery procedure.
- d. Control of tools and maintenance products will be per reference (1).

- e. Reference (l) cleanliness requirements for Nuclear Aircraft Carrier catapult steam and drain systems shall be complied with regardless of which Department Head has responsibility for the system.

5.4.5.3 Nuclear Support Facility.

- a. Reference (m) provides specific cases that invoke reference (l) and reference (n).
- b. Where the above references do not address a specific Nuclear Support Facility system or component, reference (l) may be used for guidance as determined to be appropriate. The component technical manuals and NSTMs should also be consulted for cleanliness requirements as appropriate.

5.4.5.4 Standard Lubricants and Penetrating Fluid. General overhaul specifications for reactor plants and Nuclear Support Facility Manuals for Submarine Tenders require the use of reference (o). Reference (l) contains requirements to control detrimental materials.

5.4.6 General Shipboard Steam Plant Systems Cleanliness Requirements.

5.4.6.1 Purpose. To define the general requirements for cleanliness controls during maintenance/repair of steam plant systems on Surface Force ships.

5.4.6.2 Applicability. The requirements of this paragraph are applicable to the following steam plant systems:

- a. Main Steam.
- b. Auxiliary Steam (Defined as steam which returns to the boiler).
- c. Feedwater.
- d. Condensate.
- e. High Pressure Drains.
- f. Reserve Feedwater.
- g. Heating steam and condensate return piping from distilling units.
- h. Steam drains.

5.4.6.3 Discussion. Significant contamination of boilers with chlorides and/or other detrimental materials has resulted from the introduction of foreign materials into steam plant systems during maintenance onboard conventionally powered ships. The guidance for foreign material exclusion and general cleanliness controls for steam plant system components (e.g., boilers, turbines, condensers) are formally promulgated by NSTMs. However, there is no definitive NAVSEA guidance for many of the steam plant systems piping on conventionally powered ships during maintenance and repair. Therefore, the guidance for cleanliness controls provided in the following paragraphs is for those instances where there is no definitive NAVSEA guidance.

5.4.6.4 Requirements. During general maintenance that breaks the system boundaries, the following cleanliness controls will be implemented:

- a. Maintenance of cleanliness.
 - (1) Temporary covers or plugs will be installed on all steam system piping, components, and tanks opened for work except during the time that the opening must actually be uncovered to perform the work. Covers and plugs will be designed to preclude loose pieces from entering the steam system. Covers and plugs will be rubber, metal, or rigid plastic and will be securely fastened to the component or piping.
 - (2) Following maintenance and prior to removing plugs or covers from inside piping or components, inspect and thoroughly clean the work area to ensure that no tools, rags, lubricants, or other foreign materials are left inside. This includes removal of loose scale and other easily removed corrosion products, as well as removal of residue from grinding, chipping, welding, or other maintenance.
- b. Control of foreign material introduction.

- (1) New or repaired components should be cleaned to the maximum extent practical without disassembly prior to installation into the system to ensure preservatives, desiccants, etc. are removed.
 - (2) Assembly and maintenance may require the use of lubricants, sealants, and other compounds. Those compounds should be used only as authorized and only applied in the flow path, if authorized by the process instruction.
 - (3) During all maintenance, ensure action is taken to ensure all foreign materials are removed following the maintenance and prior to system operations.
 - (4) Water used for cleaning or flushing steam plant systems must meet the criteria for steam plant makeup/feedwater.
- c. Verification of cleanliness. When verification of cleanliness is required, verification should be accomplished by visual inspection. If configuration of the system or component precludes visual inspection, and cleanliness has not been maintained, then flushing may be used to verify cleanliness.
- (1) Visual inspections will be conducted using normal reading level lighting. Mirrors and borescopes may be used provided resolution is sufficient to verify cleanliness.
 - (2) Components should not be disassembled just to conduct visual cleanliness verification. Instead a flush may be used to verify cleanliness. Valves may have the visual inspection performed on the accessible portions of the flow area.
 - (3) Flushes will be conducted for period of not less than five minutes.
 - (4) Visual inspection acceptance criteria.
 - (a) No grease, oil, or other foreign material.
 - (b) For uncoated surfaces, tightly adherent corrosion products typical for the type of material (e.g., carbon steel) are acceptable. No loose corrosion products may be present.
 - (c) For coated surfaces, the coating must be acceptable to the process instruction used to apply the coating. No loose corrosion products may be present.
 - (5) Flush acceptance criteria (Visual).
 - (a) For water flushing, the water sample must be free of foreign material.
 - (b) For steam flushing, a sample of condensate downstream of the area being flushed must be free of foreign material.
 - (c) For lines flushed with compressed gas, place a white filter cloth at the outlet to collect debris. After flushing, the cloth must contain only light speckling and/or staining due to rust and dirt and must contain no readily apparent quantities of foreign materials (e.g., metal shavings, abrasive grit, oil).
 - (d) For piping where direct sampling of the flush effluent is not possible, the following requirements apply:
 - 1 For lines that cannot be directly sampled during flushing (e.g., lines that discharge into a tank or condenser without drains or sample taps between the area being flushed and the tank), flush for five minutes. Sample the collected discharge from the tank, the water sample must be free of foreign material.
 - 2 Dead-ended piping in a line being flushed by opening a mechanical connection, will have water, steam, or gas (as applicable) flushed past the dead end connection to the main stream for a minimum of five minutes at the maximum practical flow rate. When cleanliness is verified for the main stream, it is also verified for the dead-ended piping.

- 3 For piping which cannot be sampled because it discharges overboard, flush for at least five minutes. No acceptance criteria are applicable.

NOTE: CLASS 3 STUDS KNOWN TO BE SET WITH ANAEROBIC SEALING COMPOUND BASED UPON DRAWINGS REQUIREMENTS OR OTHER OQE MAY USE THE "IN-SERVICE ANAEROBIC STUD ROTATION" CHECKS FROM QA FORM 34 TO DETERMINE THE ACCEPTABILITY FOR USE WITHOUT RESETTING.

5.4.7 Set Stud Inspection. During disassembly or reassembly, inspect set studs to ensure no rotation is exhibited during nut loosening and tightening. Where direct visual inspection is not possible, marking the top of the stud (e.g., felt tip marker) to a reference point on the assembly may be used. Rotation of any stud during disassembly is cause for rejection (except studs known to be class 3 studs set with anaerobic sealing compound) and the stud must be reset prior to final assembly. If marking is used, use care to not remove material markings such as material color coding during marking removal.

5.5 SOFTWARE

5.5.1 Determination of Acceptability and Use of Piping System Software. To assist in the determination of acceptability of non-metallic packing materials (e.g., O-Rings, wall seals) for installation in non-nuclear and nuclear systems, decision aids have been developed from reference (p) and are provided in Appendix A. In case of question or conflict the requirements of reference (p) apply. Additional guidance regarding non-metallic seals is provided in the following paragraphs.

- a. It is Fleet policy that software (e.g., O-Rings, gaskets) will be reused only as a last resort. If new software is not available, software may be used after satisfactory inspection for damage, resiliency, discoloration, or cracking in accordance with reference (p).
- b. In all cases, the guidance provided in applicable NAVSEA technical documents (e.g., drawings, component technical manuals, references (p) and (q) for nuclear and non-nuclear applications) will be followed.
- c. Reuse of software during daily Planned Maintenance System (PMS) or other specified situations. The practice of not reusing software does not apply to items of daily PMS (e.g., drain pump strainer, lubricating oil strainers) or the Logistics Escape Trunk on submarines and, therefore, the O-Ring or gaskets may be reused provided the software has been inspected and is not damaged.
- d. Software which have exceeded their recommended shelf life may be used in naval reactor plant applications provided the following criteria are met:
 - (1) The software has been properly stored in its original package.
 - (2) Software shall be inspected as part of issuing the software for a job or prior to installation. Inspection by a QAI or Controlled Material Petty Officer is not required. No certification signatures are required. The user activity shall define who shall test software with expired shelf lives to ensure they are adequately tested.
 - (3) Except for tubing, each surface of the material shall be examined. For tubing, only the outside surface shall be examined. The software shall be resilient and show no evidence of cracking, discoloration, flaking, tackiness, brittleness, surface contaminants, or other physical damage. Further, each surface shall be inspected and shall exhibit no cracks under 5X magnification when it is deformed as follows:
 - (a) For flat pieces, strips, and O-Rings, bend material onto itself over a rod of diameter (d) no greater than the cross sectional thickness (t) as illustrated in Figure 5-2 below:

Figure 5-2 Simple Software Deformation Inspection

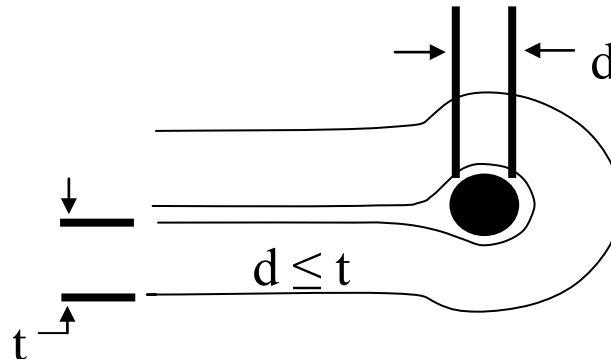

- (b) For complex shapes or parts with non-uniform cross section which closely resemble flat pieces, strips, or O-Rings, bend the material at least 90 degrees over a rod of diameter (d) no greater than the maximum cross sectional thickness (t or w) as illustrated in Figure 5-3 below.

Figure 5-3 Complex Software Deformation Inspection

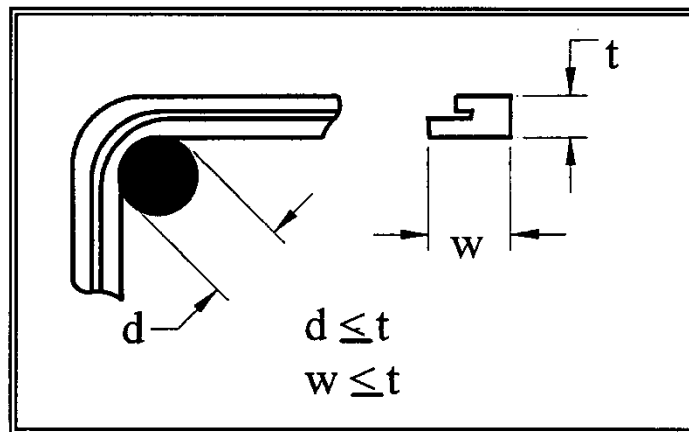

- (c) For parts which do not fall into the above categories and parts which are too stiff to be deformed as required, approval shall be obtained on a case basis from the respective Reactor Plant Planning Yard via a Liaison Action Request per Part I, Chapter 8, Section 8.4 of this volume.

5.6 SUBMARINE SAFETY MAINTENANCE CERTIFICATION/RE-ENTRY CONTROL NUCLEAR AND NON-NUCLEAR.

5.6.1 **Purpose.** To promulgate the policy and procedures for:

- a. Maintaining continuity of SUBSAFE certification during the operating cycle.
- b. General Maintenance Certification Record administrative requirements.

5.6.1.1 **General.**

- a. Reference (r) establishes the SUBSAFE certification criteria which must be accomplished on submarines in order for NAVSEA to recommend UROs to design test depth. Once the certification criteria are satisfied, NAVSEA will make a recommendation to the appropriate TYCOM that the

submarine be authorized for URO to design test depth. Based upon the NAVSEA recommendation, TYCOM will authorize the submarine to operate to design test depth, or some lesser depth depending upon specific conditions. Each TYCOM summarizes the authorized operating depths and restrictions for ships in reference (s) or (t).

- b. Continued URO to design test depth is dependent on:
 - (1) The positive control and re-certification of all re-entries into the SUBSAFE or hull integrity boundaries of the ship and
 - (2) The satisfactory and timely completion of URO MRC requirements.

5.6.2 Re-Entry Control Program.

- a. Applicability. This section is applicable whenever work is accomplished within a SUBSAFE boundary as defined by SUBSAFE Requirements Manual, reference (r), and as depicted in the SUBSAFE Certification Boundary Book.

NOTE: SUBSAFE REQUIREMENTS MANUAL IS THE FINAL AUTHORITY FOR DETERMINING IF AN ITEM IS WITHIN THE SUBSAFE BOUNDARY. THE SUBSAFE CERTIFICATION BOUNDARY BOOK IS AN ILLUSTRATED REFERENCE TO AID IN THE DETERMINATION OF WHETHER AN ITEM IS SUBSAFE OR NOT.

- b. General. The Re-Entry Control (REC) Program includes those elements associated with maintenance and/or repair necessary to maintain the certification established by NAVSEA. The program provides auditable OQE of the following:
 - (1) What work was accomplished, including material and components used, re-test requirements, tests performed, and test data.
 - (2) Why work was required.
 - (3) Who authorized and accepted the REC.
 - (4) Who did the work.
 - (5) When and where the work was accomplished, including the work and re-test boundaries.
- c. When it becomes necessary to re-enter a SUBSAFE certified system or structure, it will be accomplished in accordance with the requirements and procedures of paragraph 5.6.4 of this chapter. Specific direction on completing the Maintenance Certification Record (MCR) (QA form 9) is contained in the instructions for QA form 9.
- d. Some exceptions to RECs are allowed due to frequent entry into the certified boundary for routine operations or maintenance actions. These exceptions and administrative and/or operational control requirements are contained in paragraph 5.6.7 of this chapter.
- e. NAVSEA SUBSAFE Grams are not authorized for use by submarines or maintenance activities managed by the TYCOM. SUBSAFE Grams will be engineered into the Joint Fleet Maintenance Manual where appropriate.

5.6.3 Nuclear Submarine Safety System Re-Entry. When Re-Entry of a nuclear SUBSAFE system or a portion of a nuclear SUBSAFE system is necessary, the applicable Reactor Plant Manual, reference (e), and the ship's specific Reactor Plant Work Accomplishment Report (RPWAR) will be reviewed and used to provide technical guidance. Nuclear SUBSAFE Re-Entry will be in accordance with the requirements and procedures of Section 5.7 of this chapter. Nuclear SUBSAFE RECs shall be marked in Block 2 of the QA-9 as SUBSAFE and NUCLEAR. Approval to open and close the Nuclear REC will be in accordance with Part I, Chapter 2, Appendix E of this volume using the "NUC" review and approval matrix.

5.6.3.1 Reactor Plant Planning Yard Liaison Action Requests.

NOTE: INFORMATION ON THIS SUBJECT IS SAFEGUARDED IN ACCORDANCE WITHOPNAVINST N9210.3.

5.6.4 Re-Entry Control Administrative Procedures.

- a. General. REC procedures provide a continuous, auditable record of work done on fully certified systems to provide positive assurance that they remain “certified”. Continuity of Certification is mandatory throughout the operational life of the ship to ensure URO to design test depth.
- b. REC. When re-entry of a SUBSAFE system or a portion of a SUBSAFE system (or component) is necessary, the work and re-certification of the work will be documented using the MCR/REC, QA form 9.
 - (1) A MCR/REC will be used for each re-entry of the pressure hull and/or each certified system, certified component or portion thereof as defined by the SUBSAFE certification boundaries.
 - (2) A MCR/REC will be restricted to a single system within a single mapping plan, a single component removed from a system, or a single component removed/worked that requires multiple mapping plans (e.g., trash disposal unit, Main Sea Water hull/backup valves and hydraulic actuators, modified after signal ejectors).
 - (3) When a MCR/REC is opened by a ship to permit removal of a component by Ship’s Force for repair by an FMA as a “ship to shop” job, a MCR/REC must be opened by the FMA to cover the work and retesting of the work center work performed by the FMA.
 - (4) Where other certified systems must be re-entered to accomplish a MCR/REC, each system will have its own MCR/REC, except as described in paragraph 5.6.4.b.(2) above.
 - (5) The MCR/REC and records of MCR/REC will contain all of the OQE necessary to comply with paragraph 5.6.2.b above.
 - (6) The work procedures associated with a MCR/REC will contain sufficiently detailed instructions to assure that all requirements for certification are properly accomplished and documented.
 - (7) Work and test boundaries will be defined in terms that are unique and directly identifiable with the specific mapping plan and/or task involved.
 - (8) When work and test boundaries are different, both boundaries will be set forth. The work boundaries, test boundaries and pressure boundaries should be specified and should not be confused. Work boundaries define the limits to which work was performed. Test boundaries define the limits for testing to certify the work; these tests may involve actuators, indicators or components other than those actually repaired. Pressure boundaries define (perhaps by valve lineups) the limits of the system which were pressurized to hydrostatically test the work. The pressure boundaries and test boundaries may be the same.
 - (9) On a “ship to shop” job the work boundaries may be best described by system joint designators even though those joints were not “disturbed” by the FMA (e.g., rebuild a Rubber Insert Sound Isolation Coupling (RISIC), the work/test boundaries will be the end flanges that bolt up to the system, the joint identification numbers may be clearest identification of that boundary point).
 - (10) Previously certified hardware will be reused when certification is not affected by the re-entry, or when it can be recertified. The words “replace”, “repair”, and “re-install” should be used carefully. “Replace” means the use of a different/new component, while “re-install” indicates the use of the previously installed component, whether repaired or not. “Repair” indicates that some refurbishment, other than mere disassembly and/or cleaning, was performed.
 - (11) Associated supporting documents such as Nondestructive Testing (NDT) records, material certification, test data, etc., will be specifically identified and referenced on the MCR/REC.
 - (12) When it becomes necessary for an FMA to re-enter a certified component (periscopes, Auxiliary Sea Water pumps, Electronic Warfare Support Measures masts) which will not be returned to the ship from which it was removed, or when a component is re-entered when the ship on which it will be installed is not present, the FMA will control the work and document the re-entry using a QA form 9, MCR/REC. The MCR/REC will be initiated and closed out by the FMA. A copy of the completed MCR/REC will accompany the component when it is

installed in a certified SUBSAFE submarine or shipped to another activity as proof of certification. These controls are required whether the certified component is to be installed in a SUBSAFE certified ship or stored. Each component must retain its certification. These RECs are separate from and in addition to any MCR/REC required for removal of a component from SUBSAFE system and are only necessary whenever the original component will not be returned during the current availability to the ship from which it was removed.

- (13) The CWP/REC Log, QA form 11 will be established and maintained by the QAO in accordance with the detailed instructions for QA form 11 in Part I, Chapter 11 of this volume. The QA form 11 shall be reviewed by the QAO to verify all MCR/RECs are closed prior to submerged operations. The FMA QAO will maintain a log for the FMA only and one for each tended ship RECs. The QA form 11 shall be reviewed by the FMA QAO to verify all FMA MCR/RECs are closed prior to underway operations of each tended ship.
- (14) Revisions to the MCR/REC are required for the following:
- (a) Change in work boundaries (e.g., breaking additional or new mechanical joints not previously identified on the MCR/REC). A REC revision is not required to delete undisturbed joints. Deletion of joints must be authorized by cognizant technical authority and documented in the REC package. Block 13 must be annotated to reflect joint deletions prior to signing REC Block 16.
 - (b) Change in NDT or test requirements (e.g., “J” vice H hydrostatic test, when “H” was originally specified). This does not include a DFS for unaccomplished testing. A REC revision is not required for NDT incidental to minor repairs as defined in paragraph 5.6.4.b.(14) (d) below. NDT results must be documented in the REC package.
 - (c) Scope of work changes (e.g., originally replace software changed to weld repair sealing surfaces, originally replace software changed to metallic pressure boundary part replacement).
 - (d) The REC does not require revision in order to conduct minor repairs in support of the original scope of work. These minor repairs must be authorized by cognizant authority and documented in the REC package, with appropriate OQE generated and added to Block 16 prior to the signing of Block 17 of the QA form 9. Hot work is not classified as a minor repair. Minor repairs authorized to be performed without a revision are:
 - 1 Minor machining such that the machining is within the limits of the technical drawing, MS, or technical manual (e.g., taking a skim cut on an O-Ring groove such that the final machined dimensions are within the tolerances of the technical reference).
 - 2 Epoxy repairs.
 - 3 Electroplate repairs.
 - 4 Preventive coating application.
- (15) A revision cannot be used when a new MCR/REC is required (e.g., different system must be entered to conduct repair).
- (16) REC Cancellation and REC Administrative Closeout. In the event a CWP is prepared and the job is planned to be accomplished but for some reason it was cancelled or deferred the following actions should be taken:
- (a) If work was authorized to start, the CWP/REC must be revised to reflect that no work was accomplished and the REC was revised to close administratively. The QA form 11 log will be annotated that the job was “Cancelled”.

- (b) If work was not authorized to start, and the job has been cancelled, annotate the remaining blocks of the QA form 9 with NA and note that the REC was cancelled and no work was accomplished. Blocks 20 and 21 will be signed to formally close the REC. If the REC was prepared by a Repair Facility, a copy of the QA form 9 will be provided to the tended unit with the Certification Continuity Letter. QA form 11 log will be annotated that the job was "Cancelled".
- (c) If work was not authorized to start and the job has been deferred to a future maintenance period, the REC is not required to be cancelled. The QA form 11 log will be annotated as "Deferred". This is not considered an open REC.
- (17) Prior to every underway for submerged operations, all SUBSAFE RECs shall be closed. Commanding Officers of submarines will submit to Immediate Superior In Command (ISIC) a written report in accordance with paragraph 5.6.8 of this chapter. SUBSAFE certification letter is only required after an inport period in which SUBSAFE work was performed.
- (18) Ship's Force is responsible for providing "Buddy" SUBSAFE, FBW-SCS or DSS-SOC REC serial numbers to outside repair activities performing SUBSAFE, FBW-SCS or DSS-SOC work on shipboard SUBSAFE, FBW-SCS or DSS-SOC systems. The Buddy REC number is issued from ship's QA-11 log and will be documented on repair activities RE-ENTRY CONTROL FORM. The use of the Ship's Force Buddy REC number is NOT required for Chief of Naval Operations/TYCOM scheduled availabilities. The issue of the Ship's Force Buddy REC is an administrative tool to make REC Log keeping easier and ensure the required certification letters are received prior to underway. The Ship's Force Buddy REC does not result in a Ship's Force REC Form, does not require Ship's Force Record Retention and does not allow Ship's Force to participate in the assigned activities work or certification process, except performance of testing. Ship's Force will only issue Buddy RECs to SUBSAFE, FBW-SCS or DSS-SOC certified activities performing SUBSAFE Work.

5.6.5 Using a Controlled Dive Departure from Specification to Close a Maintenance Certification Record/Re-Entry Control. If a MCR/REC is closed by transferring at sea testing to a DFS (e.g., controlled dive to test depth for retest of a periscope hull gland, controlled dive for retest of a sea connected system in lieu of joint tightness test to "J" pressure of Test Pressure Drawing (TPD)), the ship will be restricted, as required by reference (r), as follows:

- NOTE: IF AN UNSATISFACTORY CONDITION OR SEAWATER LEAKAGE IN EXCESS OF THE SPECIFICATION IS FOUND DURING THE CONDUCT OF THE CONTROLLED DIVE TO TEST DEPTH, THE SHIP SHALL CONTINUE TO TEST DEPTH UNLESS THE COMMANDING OFFICER DETERMINES IT APPROPRIATE TO ABORT THE DIVE.**
- a. Except for the controlled dive to test depth to retest the system/component, ship's depth will be limited to one half test depth plus fifty feet until satisfactory completion of inspections during the controlled dive. The ship will stay at test depth for the time required as detailed in the normal retest procedure (i.e., 30 minutes if the normal joint tightness test is for 30 minutes) plus adequate time to permit inspections.
 - b. If inspections of the system/component during the controlled dive are satisfactory, the ship is released for UROs with no immediate report required. Clearance of the DFS will be reported as required by Part I, Chapter 8 of this volume.
 - c. If inspections of the system/component during the controlled dive are unsatisfactory, the ship is restricted to one half test depth plus fifty feet as indicated in paragraph 5.6.5a. above, unless specific authorization is received from TYCOM approving URO or changing the depth restriction. The DFS approved to perform the controlled deep dive shall be cancelled and a new major DFS for the failed testing shall be initiated by the ship. An immediate report of unsatisfactory inspections will be made to ISIC and, if required, a request, including Commanding Officer's evaluation of unsatisfactory conditions and justification for request, for approval to conduct operations at depths deeper than one half test depth plus fifty feet will be made to TYCOM with information copy to ISIC and NAVSEA (07T). Deficiencies discovered that are not joints specified for inspection in the MCR/REC and DFS are dispositioned as required by Part I, Chapter 8 of this volume and are not cause for depth restrictions unless the Commanding Officer deems necessary.

- d. Should the presence of an installed Dry Deck Shelter preclude a component requiring deep dive testing from seeing submergence pressure, the requirements of paragraph 5.6.5a. of this chapter shall apply upon removal of the Dry Deck Shelter and shall be so annotated in the approval comments of the deep dive DFS.

5.6.6 Voyage or At Sea Repairs. If emergent repairs or at-sea repairs involve REC work, the ship is limited to 200 feet or less until the ship’s Commanding Officer has signed for the closed REC.

- a. If equipment malfunctions (except for casualties affecting recoverability, salvage, watertight integrity, or operation of ship’s control surfaces), or seawater leakage in excess of the specification is found during the conduct of the initial tightness dive or the controlled dive to test depth, the ship should continue to the required depth and execute the sea trial agenda unless the Commanding Officer determines it appropriate to abort the dive. The Commanding Officer should be particularly circumspect in the case of leakage locations not isolable by flood control/other closures (e.g., electrical hull penetrators, periscope hoist rods, etc.).
- b. Following completion of the initial tightness dive and the controlled dive to test depth, SUBSAFE deficiencies which result in seawater leakage exceeding the specification for acceptance shall be reported to the TYCOM, NAVSEA and info to all concerned.
- c. If leakage is from an unisolable joint, ship’s depth will be limited to 1/2 test depth plus 50 feet until approval from the TYCOM is received to continue trials at depths greater than 1/2 test depth plus 50 feet.

5.6.7 Exceptions to Re-Entry Control. Table 5-1 of this chapter includes certain systems and equipment within the certified SUBSAFE boundary which require frequent entry into the certified boundary for routine operations or maintenance actions in order to enable the ship to carry out its mission. The operational requirements for these systems and equipment have been reviewed. Inherent operational controls in the present system are considered adequate and the below listed items are considered safe exceptions to the formalized REC system. The operational control which is considered as meeting the intent of the REC requirements is listed beside each item and must be in effect in order to use the exception. Some REC exceptions permit removal of material from the installed system to perform maintenance or testing. The original material must be reinstalled or a complete REC (controlled work package) must be used to capture the installation of new Level I material and/or certification testing for new material.

NOTE: MCR/REC EXCEPTIONS ARE FOR SHIP’S FORCE USE ONLY AND ARE NOT AUTHORIZED FOR USE BY REPAIR ACTIVITIES. REPAIR ACTIVITIES SHALL NOT REQUEST THE SHIP TO INVOKE A REC EXCEPTION IN CONJUNCTION WITH REPAIR ACTIVITY WORK.

NOTE: REC EXCEPTIONS ARE NOT AUTHORIZED TO BE USED FOR THE INSTALLATION OF NEW LEVEL I HARDWARE WITHIN THE SUBSAFE BOUNDARY.

Table 5-1 Re-Entry Control Exception List (SUBSAFE)

REC EXCEPTION ITEM	OPERATIONAL CONTROL REQUIREMENT	RECERTIFICATION TESTING
Operation of access hatches and watertight doors	Ship’s operating instructions (Note 1)	None
Operation of trash disposal unit	Ship’s operating instructions (Note 1)	None
Streaming and retrieving the floating wire antenna	Ship’s operating instructions (Note 1)	None
Normal operation of signal ejector/launcher and hand ram operations	Ship’s operating instructions (Note 1)	None
Operating of shore services trunk and hook-up and disconnect of shore power, including removal and replacement of shore power covers	Ship’s operating instructions (Note 1)	None
Normal operation of torpedo tube system	Ship’s operating instructions (Note 1)	None

REC EXCEPTION ITEM	OPERATIONAL CONTROL REQUIREMENT	RECERTIFICATION TESTING
Entry into Auxiliary Tanks modified for storage (Does not include changing tank from wet to dry or vice versa)	Ship's operating instructions (Note 1)	None
Streaming and retrieving of towed array sonar systems	Ship's operating instructions (Note 1)	None
Operation of dry sonar sphere access hatch	Ship's operating instructions (Note 1)	None
Removal/Reinstallation of MS plugs (9/16" and smaller) including test fittings for gauge test or hydrostatic test	FWP/Controlled assembly (Notes 2 and 3)	Note 4
Removal/Reinstallation external salvage pipe cap	FWP/Controlled assembly (Notes 2 and 3)	None
Operation of Electronic Warfare Support Measure nitrogen purge lines	Operation by qualified FMA Electronic Warfare Support Measure repair personnel	None
Operation of periscope gassing valve	Operation by qualified FMA or RMC periscope repair personnel	None
Cleaning Sea Water Injection Strainers	FWP/Controlled assembly (Notes 2 and 3)	None
Main closure regreasing on MOD 25 MSW pumps, SSN 21 and SSN 774 Class Sea Water Pumps	FWP/Controlled assembly (Notes 2 and 3)	None
Fresh Water Flushing of Towed Array Handling System Valve/Seal Assembly	FWP/Controlled assembly (Notes 2 and 3)	None
Removal/Reinstallation of the special test plug from MSW and ASW hull and backup valve body access covers	FWP/Controlled assembly (Notes 2 and 3)	None
Cleaning of Main or Auxiliary Sea Water Pump Cyclone Separator	FWP/Controlled assembly (Notes 2 and 3)	None

Notes:

- (1) Ship's operating instructions are procedures approved and signed by the Commanding Officer, or for SSN 688 and later classes of submarines, procedures promulgated in the Ship Systems Manual and Steam and Electric Plant Manual.
- (2) An FWP, in accordance with Part I, Chapter 2, paragraph 2.2.3 of this volume, will be used to control and document all work performed as a REC exception.
- (3) Controlled assembly requirements are:
 - (a) Verification that surface finishes of gasket/o-ring sealing surfaces are in accordance with applicable specifications.
 - (b) Verification that fastener material and installation is in accordance with applicable specifications.
 - (c) Verification that gaskets/o-rings are properly installed and in accordance with applicable specifications.
 - (d) Assembly is documented on a QA form 34.
 - (e) Inspected by a QAI or Quality Assurance Supervisor.
- (4) The re-certification test is an operational test to system operating pressure.

NOTE: EXCEPTIONS FROM REC OTHER THAN THOSE LISTED ABOVE ARE NOT AUTHORIZED.

5.6.8 Certification Continuity Report. In order to ensure continued certification of each submarine, periodic reports are required as follows:

- a. Prior to each underway for submerged operations, all SUBSAFE RECs/REC exceptions requiring a controlled assembly shall be closed. Commanding Officers of submarines will submit to ISIC (deployed ISIC, if deployed), a written certification continuity report, which addresses the status of Ship's Force SUBSAFE/Submarine Flight Critical Component (SFCC) CWPs/REC exceptions requiring a controlled assembly, testing of SUBSAFE/Fly-By-Wire Ship Control Systems (FBW SCS) systems, URO maintenance completed and RECs closed by transferring actions to a DFS. Appendix B provides the minimum requirements for the letter. If no SUBSAFE/SFCC controlled work/REC exceptions requiring a controlled assembly, testing or URO MRCs were accomplished, no report is required. Certification Continuity Reports may be delivered in person by a command representative, transmitted as a naval message, transmitted via email as an electronically signed PDF, transmitted via email as a signed letter scanned as a PDF.
- b. Prior to the ship's underway after an FMA availability, refit or inport period when SUBSAFE/SFCC work was performed, the FMA Commanding Officer will issue a letter report to each tended submarine, with a copy to parent ISIC, which addresses the status of SUBSAFE/SFCC CWPs, testing of SUBSAFE/FBW SCS systems, URO maintenance requirements completed and SUBSAFE non-conformances (i.e., DFS and LAR). Appendix C provides the minimum requirements for the letter.
- c. Prior to ship's underway, activities other than FMAs which perform SUBSAFE/SFCC maintenance on submarines will issue a letter report to the submarine with a copy to the parent ISIC, certifying that the maintenance performed meets the requirements of applicable specifications invoked by the governing document (e.g., unscheduled availabilities, contract) and the Memorandum of Agreement. Appendix D provides the minimum requirements for the letter.

5.7 REACTOR PLANT WORK ACCOMPLISHMENT REPORT (SUBMARINES ONLY).

5.7.1 Purpose.

- a. The RPWAR form is a listing of those pipe and components of the reactor plant which are SUBSAFE. It is specific for each ship and is provided by the Reactor Plant Planning Yard via the TYCOM. The RPWAR consists of:
 - (1) Status sheet.
 - (2) Cover sheet.
 - (3) RPWAR Master Pages.
 - (4) Addendum Sheet.
 - (5) RPWAR general notes.
- b. The reactor plant hull integrity area is comprised of those items on the RPWAR. Each ship must maintain the RPWAR current. Each completed RPWAR will be filed in an auditable manner along with the latest revision for the ship of the NAVSEA RPWAR status drawing. The reproducible blank RPWAR will be maintained in the same file. The ship will reproduce blanks as necessary to support reactor plant work.
- c. To properly complete the RPWAR, the preparer must review the general notes of the applicable RPWAR and the instructions in reference (e).
- d. To certify (or recertify) a nuclear SUBSAFE item, a RPWAR must be completed by the activity performing the maintenance (ship, FMA or shipyard) in accordance with reference (e) and forwarded as soon as possible to the Reactor Plant Planning Yard with copies to NAVSEA 08, TYCOM, ISIC and the ship. The RPWAR is to be signed in ink and the signed in ink copy should be forwarded to the Reactor Plant Planning Yard. Initials or typed signatures are not permitted. When work is complete, submit only those pages of the RPWAR line items that certify the work accomplished.
- e. The RPWAR does not, in any way, relieve the FMA or ship of its responsibility to comply with all applicable requirements specified in technical manuals, plans, and other NAVSEA documents.

- f. When the FMA works in an area covered by the RPWAR, the ship's Engineer Officer will provide the FMA with a reproduced RPWAR with the number filled in, notes, applicable certification forms and addenda sheet.
- g. Instructions contained in this section are in amplification of those included in reference (e) and the RPWAR drawing itself.

5.7.2 Specific Instructions for Completing Reactor Plant Work Accomplishment Report Cover Sheet.

- a. The ship's hull number must be specified in the space provided (if not already pre-printed).
- b. The reporting activity (ship, FMA or shipyard) must be listed.
- c. The report number must be included. The report number is the next consecutive number to that indicated on the latest completed RPWAR held by the ship.
- d. The report must be dated.
- e. The applicable block specifying when the work was accomplished must be checked.
- f. The signatures and titles of the personnel preparing, reviewing, and approving the RPWAR must be included. Each RPWAR submitted by ships is prepared by the Lead Work Center QAI, reviewed by the QAO and Engineer Officer, and approved by the Commanding Officer. Each RPWAR submitted by an FMA is prepared by the nuclear Planning and Estimating Work Center (10D), reviewed by the Nuclear Repair Officer and QAO, and approved by the Repair Officer.

5.7.3 Specific Instructions for Completing Reactor Plant Certification When New or Previously Uncertified Material is Installed in a Submarine Safety Application.

- a. The applicable revision of the drawing or plan must be referenced in the "DWG. NO. AND REV" block for each item worked on.

NOTE: IF A DRAWING OR PLAN OTHER THAN THAT REFERENCED IN THE "DWG. NO. AND REV" BLOCK IS USED BY THE REPORTING ACTIVITY, THE ACTUAL DRAWING OR PLAN USED SHOULD BE SPECIFIED IN EITHER THE "REMARKS" BLOCK OR ON THE ADDENDA SHEET AS A REFERENCED NOTE. THE REASON FOR USING A DIFFERENT DRAWING OR PLAN SHOULD ALSO BE SPECIFIED.

- b. The identification of the reporting activity's detailed record should be entered in the "DETAILED RECORD IDENTIFICATION" block if the inspections required by the applicable inspection category were performed by the reporting activity (ship or FMA).

NOTE: THE RECORD RETAINING ACTIVITY, IF OTHER THAN THE REPORTING ACTIVITY, SHOULD BE IDENTIFIED IN THIS BLOCK.

- c. Where sufficient space does not exist for entry of information, refer to the addenda sheet in the "REMARKS" block and enter the required information on the addenda sheet.
- d. The report number will be entered in "REMARKS" block for each line item worked on by the reporting activity.
- e. The signature block must be completed, indicating that the corresponding line item work has been satisfactorily completed and that records substantiating this are on file.
- f. Where SUBSAFE work is accomplished in accordance with an Alteration, the reporting activity will reference, for each work item, the applicable Alteration with revision number in the "REMARKS" block.
- g. Waiver, if any, previously granted for each item must be identified, including reference to the NAVSEA approval letter.

NOTE: IF THE WORK PERFORMED ON THE SUBSAFE ITEM IS SUCH THAT THE PREVIOUS CERTIFICATION IS VOIDED (SUCH AS REPLACEMENT OF A SUBSAFE VALVE TAILPIECE), THE REPAIRED OR ALTERED ITEM MUST BE CERTIFIED AS NEW MATERIAL.

5.7.4 Specific Instructions for Completing Reactor Plant Certification When Previously Certified Material is Reinstalled.

- a. Reinstallation of previously certified material does not require a RPWAR unless specifically called out as a line item on the RPWAR requiring torque or installation verification.
- b. The fastener torque sheet is filled out as follows:
 - (1) The inspection document is the QA form 34, the FWP or CWP serial number and job sequence number.
 - (2) The signature block is signed by the QAI who verified the torque.
 - (3) If sufficient space is not available in the QA form 34, the addenda sheet should be used with the appropriate line item listed.

5.8 MATERIAL CONDITION MONITORING (SUBMARINES ONLY).

5.8.1 Unrestricted Operations Maintenance Requirement Card Program.

- a. The URO MRC program provides the minimum material condition requirements for URO to design test depth, with an established periodicity to accomplish. It is one of the programs required to maintain SUBSAFE certification. Accomplishment of the URO MRC will identify changes within the SUBSAFE or hull integrity boundaries of the ship, which result from the degradation caused by the service environment.
- b. Administration, scheduling and reporting of the URO MRC program will be in accordance with the requirements of Chapter 25, Volume VI of this manual. A summary of URO MRC status will be reported by the submarine Commanding Officer in accordance with paragraph 5.6.8 of this chapter.
- c. When performing corrective maintenance the following guidance is provided with regard to URO MRC:
 - (1) When performing corrective maintenance, associated URO MRCs should be reviewed to determine if the URO MRCs should be accomplished concurrently ahead of scheduled periodicity to preclude having to disassemble equipment again to accomplish the URO MRCs. Ship's schedule or FMA resources may preclude concurrent, early accomplishment of URO MRCs.
 - (2) If URO MRC criteria are used, in total or in part, during corrective maintenance, and a measured parameter is found out of tolerance and not restored, a major DFS must be submitted, in accordance with Part I, Chapter 8 of this volume, even though the periodicity of the URO MRC has not expired.
 - (3) When performing corrective maintenance that does affect a URO MRC measured parameter, perform that portion of the applicable URO MRC. A URO MRC measured parameter is any parameter that is documented on the Data Report Form during the performance of the URO MRC. The following are examples of corrective maintenance that may affect a URO MRC measured parameter:
 - (a) When the retest of the corrective maintenance is a documented URO MRC measured parameter (i.e., Emergency Flood Control Accumulator Tightness Test - URO MRC 026).
 - (b) When maintenance (such as opening mechanical joints or replacing hardware, adjustments, tests) affects the operation of a system inspected/tested by a URO MRC (i.e., Emergency Flood Control - URO MRC 025).
- d. Following installation of an alteration (Ship Alteration (SHIPALT), Alteration and Improvement, Temporary Alteration) that modifies the structure of the Ship, such that access to vital equipment is or may be impacted, the Ship shall evaluate the need to perform URO MRC 029. If access to vital equipment could be restricted, the Ship shall perform URO MRC 029 and provide a copy to the

installing activity and the ISIC. Partial accomplishment of URO MRC 029 is acceptable if appropriate for the alteration. If partial accomplishment of the URO MRC is performed, provide a copy to the installing activity and the ISIC. If the complete URO MRC is accomplished, provide a copy to normal distribution.

5.9 SUBMARINE FLY-BY-WIRE MAINTENANCE CERTIFICATION.

5.9.1 Purpose. To promulgate the policy and procedure for:

- a. Maintaining continuity of the FBW SCS certification during the operating cycle.
- b. General Maintenance Certification Record administrative requirements.

5.9.1.1 General.

- a. Reference (u) establishes the FBW SCS certification criteria which must be accomplished on all applicable submarines in order to maintain system certification throughout the operating cycle of the ship. Once a submarine FBW SCS has been certified for unrestricted use or is accepted by the shipbuilder, all work within the SFCC Boundary and testing to support that work shall be accomplished, controlled, and documented in accordance with reference (u).
- b. All other Performance testing within the FBW SCS Boundary, for work within the FBW SCS Boundary shall be accomplished to support system certification and documented using the activity's normal work control processes.
- c. Work is defined as an action that actually or potentially changes (including disassembly and testing) the approved configuration of any part of the FBW SCS or SFCC Boundaries.
- d. The objective of this work control process for work within the SFCC Boundary is to provide maximum confidence that any work and all applicable testing is authorized, controlled, identifiable, and auditable. It provides positive assurance that all SFCC equipment and FBW SCS is restored and tested to a fully certified condition.

5.9.1.2 Applicability. The requirements in this section shall apply to SEAWOLF and VIRGINIA Class Submarine FBW SCSs.

5.9.1.3 Submarine Flight Critical Component Boundary. The Submarine FBW SCS Boundary shall consist of electronic hardware and software within the submarine FBW Boundary (see reference (v)) that process safety critical functions and data elements.

- a. Safety critical electronic components within the SFCC Boundary shall be determined per references (u) and (v) and shall be identified as SFCCs.
- b. Safety critical software units within the SFCC Boundary shall be determined per references (u) and (v). Safety critical software units shall require additional testing and/or analysis, be marked, configuration managed, and controlled per the requirements in reference (u).

5.9.2 Submarine Flight Critical Component Boundary Work Control Procedures.

- a. All fleet activities, In-Service Engineering Activity, repair activities or shipyards (public or private) must use CWPs, Task Group Instructions (TGI), or ripouts to document the accomplishment of work within the SFCC Boundary. CWPs/TGIs/ripouts shall provide greater assurance that any work accomplished is authorized, documented and executed in accordance with specifications and requirements, and is supported by OQE.
- b. Work control documents shall be clearly marked as SFCC for auditing purposes.
- c. Closed TGIs/CWPs/ripouts shall be retained by the work accomplishing activity and are subject to audit by cognizant activities (TYCOM, ISIC, shipyard, supervising authority or NAVSEA) during audits such as functional or certification audits.

5.9.3 Submarine Flight Critical Component Boundary Work Control Closeout.

- a. All CWPs/TGIs/ripouts for work in the SFCC Boundary shall be closed prior to the system being released for unrestricted use/Fast Cruise/Sea Trials. As part of the work control procedure closeout process, CWPs/TGIs/ripouts shall receive an independent review within the activity performing the work to verify:
 - (1) Work was authorized and approved.
 - (2) Work stayed within the authorized boundaries.
 - (3) Post work/maintenance testing was accomplished satisfactorily.
 - (4) Appropriate Quality Assurance Forms are included to document Certification of Maintenance, and all forms are completed with required signatures.
- b. All testing of the FBW SCS Boundary shall be verified closed prior to the system being released for unrestricted use/Fast Cruise/Sea Trials.
- c. As a policy, CWPs/TGIs/ripouts for work within the SFCC Boundary or test documents within the FBW SCS Boundary shall not be closed out until resolution of all actions necessary to verify certification has been maintained when any breach of the boundary has occurred. An acceptable alternative, however, is to close out a CWP/TGI/ripout or test documents within the FBW SCS Boundary by transferring remaining at sea testing actions to a separate auditable accountability system (e.g., Sea Trial Agenda). All CWPs/TGIs/ripouts closed in this manner shall be annotated by the activity with the reference documents that contained the transfer actions. This policy shall be verified by the activity accomplishing the work, supervising authority, submarine Commanding Officer and ISIC.
- d. Prior to each underway for submerged operations, Commanding Officers of FBW SCS submarines will submit to ISIC (deployed ISIC, if deployed), a written certification continuity report, which addresses the status of Ship's Force FBW SCS CWP, testing of FBW SCS, URO maintenance requirements in the format of Appendix B. If no FBW SCS controlled work or testing were accomplished, no report is required.

5.9.4 Objective Quality Evidence to Support Controlled Work on Fly-By-Wire Ship Control System Submarine Flight Critical Component. To standardize maintenance OQE, the following section provides guidance on the key elements needed to be documented to certify the work process, whether routine maintenance, major repairs, system upgrades or alterations. Reference (u) provides OQE requirements including additional attributes to be included as part of the SFCC Boundary work control process. This information should be used as follows:

NOTE: THE ISIC IS ONLY RESPONSIBLE TO AUDIT FBW WORK PERFORMED BY FORCES AFLOAT/TYCOM MANAGED ACTIVITIES.

- a. Activities performing work on FBW SCS within the SFCC Boundary should use this information, along with source documents, as a guide in developing OQE records that document work, inspections and tests performed within the SFCC Boundary.
- b. The elements listed are technical specifications and process documents required for a typical repair or system upgrade/alteration process.
- c. If Upgrades/Alterations or Major Repair Work of the FBW SCS was performed, the ISIC will accomplish a 100% audit, as defined in Part I, Chapter 9 of this volume, of the work. ISIC and TYCOM will use the FBW message reporting process for certification specified in Volume II, Part I, Chapter 3 of this manual, for availabilities of less than six months duration.

5.10 AIRCRAFT CARRIER MAINTENANCE DOCUMENTS.

5.10.1 Purpose. The purpose of this section is to provide amplifying/clarifying information on the processes involved and appropriate use of specific aircraft carrier maintenance related documents. Including:

- a. Request for Departure from Specification (DFS), Waivers or Deviation.
- b. Nuclear Liaison Action Request (LAR).
- c. Nuclear Liaison Inquiry (NLI).

- d. Steam Plant Action Request (SPAR).
- e. Steam Plant Liaison Inquiry (SPLI).
- f. Reactor Plant Configuration Change Report (RPCCR).
- g. Planned Maintenance System (PMS) Technical Feedback Reports (TFBR).
- h. Tech Manual Deficiencies & Manual Change Requests.
- i. Fleet Coordinated Shipboard Allowance List (COSAL) Feedback Reports.

5.10.2 Non-Nuclear Deviations, Waivers and Departure from Specifications. The terms “deviation” and “waiver” are often used synonymously. However, the principle difference is a deviation is requested prior to conducting work that will result in a non-conformance, where a waiver is requested after a non-conformance has been discovered. Requests for deviation and waivers shall be retained and tracked within the DFS system by Ship’s Force and the ISIC/TYCOM until permanent documentation is confirmed to reflect the specific non-conforming condition. Use of the Web Based Electronic Departure from Specification or Electronic Waiver and Deviation programs facilitate meeting these requirements. A DFS (non-nuclear system/components only) is used specifically to identify a lack of compliance with plans, procedures, instructions, or authoritative documents during a maintenance action or operations.

5.10.2.1 During a Maintenance Action. A DFS is required for any lack of compliance with cognizant documents or drawings. For an “as found” condition during maintenance, the TYCOM, the ship and the Regional Maintenance Center (if involved) must evaluate the non-compliance using the guidance of paragraphs 8.2.4 and 8.2.5, of Part I, Chapter 8 of this volume to determine if the nonconforming condition meets the criteria as a Major or Minor DFS.

NOTE: IF THE SHIP IS AT SEA THE GUIDANCE OF PARAGRAPH 8.3.8 OF PART I, CHAPTER 8 OF THIS VOLUME APPLIES.

5.10.2.2 During Operations. A DFS is required for any lack of compliance with cognizant documents or drawings. For any “as found” conditions or equipment failures that result in a non-compliance, the ship (and/or TYCOM if in port) must evaluate the condition or failure using the guidance of paragraphs 8.2.4 and 8.2.5 of Part I, Chapter 8 of this volume to determine if the nonconforming condition meets the criteria as a Major or Minor DFS.

- a. If the nonconforming condition does not meet the criteria as a Major or Minor DFS, no DFS is required and the nonconforming condition will be entered in the ship’s Current Ship’s Maintenance Project (CSMP).
- b. If a DFS is required, the request should be processed as soon as possible to enable an engineering evaluation of the non-conformance and subsequent approval or disapproval issued without disrupting ship’s operations.
- c. Requests for DFS will be submitted, approved and cleared in accordance with paragraph 8.3.7 or 8.3.8 of Part I, Chapter 8 of this volume. Use of the Web Based Electronic Departure from Specification and Electronic Waiver and Deviation programs are acceptable unless directed otherwise by TYCOM.
- d. If a DFS is approved as “temporary” and requires rework to correct the discrepant condition at a later date, a new CSMP entry for correction of the discrepant condition will be initiated by the ship. The ship’s QAO shall ensure this action is accomplished.
- e. The QAO shall verify that an active Job Control Number (JCN) exists for all active temporary DFSs at the completion of all scheduled maintenance availabilities or at least quarterly and shall ensure that an auditable record of such verification is maintained until superseded.
- f. For all DFSs, deviations or waivers that have been adjudicated, the approving activity is required to provide a copy of the DFS, deviation or waiver to the ship’s QAO for retention and tracking per Part I, Chapter 8, paragraph 8.3.1.e of this volume.

5.10.3 Liaison Action Requests – Nuclear Cognizant Areas.

5.10.3.1 Technical Responsibilities. A memorandum of agreement exists between NAVSEA Nuclear Propulsion Directorate (08) and NAVSEA PMS 312/335 that details the division of responsibilities within the propulsion plants of nuclear powered ships. If a nuclear powered ship is unable to comply with specifications for reactor plant

systems or components and also those systems identified as nuclear by the appropriate nuclear/non-nuclear interface diagram, then a review of NAVSEA 08 requirements shall be requested via a LAR. A formal resolution of all LARs is generally required prior to reactor plant or propulsion plant startup.

5.10.3.2 Technical Resolution. In general, technical resolution to questions or problems for reactor plant systems or components requires the submission of a LAR for nuclear powered surface ships in accordance with the requirements set forth in Appendix 4 (Liaison Services) of reference (d).

- a. Request for DFSs for nuclear systems will neither be requested nor approved. If a ship has a question, problem, or is unable to comply with any nuclear specification, a request for technical resolution will be made using a LAR.
- b. A LAR should not be submitted for cases of out of specification seat leakage of nuclear valves following repairs. The Reactor Plant Planning Yard and Reactor Plant Prime Contractors do not have the authority to waive valve leakage specifications. When valve seat leakage exceeds reactor plant manual specification after attempted Ship's Force/FMA repairs, the guidance of Part I, Chapter 8, paragraph 8.4.2.c. of this volume may be used to defer any rework to a later date and close out the CWP.
- c. A LAR is also never used for removing or reprogramming work, to or from, an Availability Work Package (AWP).
 - (1) AWP for Chief of Naval Operations availabilities are developed and/or changed in accordance with Section 5.1.1 and Appendix D or F of the Aircraft Carrier Class Maintenance Plan (ACOMP).
 - (2) The ACOMP can be found on the Carrier Team One website under "Resources/Library".
- d. An auditable LAR file shall be maintained by the originating activity. A copy of the status of all liaison actions LAR shall be kept as part of this file with a copy maintained in the applicable Controlled/ Formal Work Package, as required.

5.10.4 Nuclear Liaison Inquiry – Nuclear Cognizant Areas.

NOTE: INFORMATION ON THIS SUBJECT IS SAFEGUARDED IN ACCORDANCE WITH OPNAVINST N9210.3.

5.10.5 Steam Plant Action Request - Non-Nuclear Cognizant Areas. In 2003, the Propulsion Plant Engineering Activity (PPEA) was formed as an additional resource for assisting operational aircraft carriers with technical or operational issues, not associated with Ship Alteration Installation or configuration control.

- a. The Steam Plant Action Request (SPAR) is designed to allow the fleet and maintenance activities to submit requests for technical assistance on non-Ship Alteration related issues. The Carrier Engineering Team (CET) will assist in providing solutions which satisfy specification requirements, supply a technical evaluation or the basis for concurrence or non-concurrence with a deviation or proposed change. Where sufficient information is not available to resolve the problem, the CET may request additional information in a reply. Each SPAR will be categorized based on the type of action taken in the proposed reply.
- b. As with a LAR, if a ship or FMA has a question or technical problem or is unable to comply with a non-nuclear specification, technical assistance is available from the In-Service CET. CET Liaison services are requested using the SPAR discussed in detail in Appendix 4 of reference (d).

5.10.5.1 Usage. SPARs requesting changes or deviations from specification shall not be submitted or approved by the CET. The SPAR is not a substitute for a Request for DFSs described in Part I, Chapter 8 of this volume.

- a. SPAR should be submitted by the ship or FMA to the PPEA to address technical, logistical and/or operational problems with the steam and electric plant systems. It is the intent of these requirements to ensure consistency between fleet units and overhaul and repair activities in the content, format and completeness of SPAR submissions. The SPAR is not intended to replace Ship's Force and Overhaul/Repair Yard communication with the CVN68 class Engineering Configuration Manager for drawing and Ship Change Document/ShipAlt installation and configuration control issues using LARs prepared in accordance with reference (w).

- b. Examples of when generation of a SPAR is appropriate are:
 - (1) Receipt of spurious De-Aerating Feed Tank level alarms during maneuvering transients that the performance of available preventive maintenance and technical manual troubleshooting does not correct.
 - (2) Failure of the Emergency Diesel Generator to parallel across the Emergency Diesel Generator output breaker during a normal Emergency Diesel Generator feedback in accordance with the Steam Plant Manual and troubleshooting do not correct or identify the cause of the failure.
 - (3) Failure of a normal seeking Automatic Bus Transfer to transfer to its normal source upon a return of the normal power supply and Ship's Force is unable to identify the cause through available troubleshooting methods.
- c. The SPAR is not intended to replace:
 - (1) The CSMP for work requests/candidates.
 - (2) TFBRS for discrepancies with the PMS System.
 - (3) Technical Manual Deficiency/Evaluation Reports (TMDER) or Manual Change Requests for identifying discrepancies in technical manuals.
 - (4) Reporting changes to ship's configuration as a result of the Navy Modernization Program.
- d. A SPAR is also never used for removing or reprogramming work to or from an AWP.
- e. AWP's for Chief of Naval Operations availabilities are developed in accordance with Section 5.1.1 and Appendix D or F of the ACCMP. The ACCMP can be found on the Carrier Team One website under the "Resources/Library" tab.

5.10.5.2 Validation. Upon receipt of a SPAR, the PPEA makes a determination, with NAVSEA concurrence as needed, as to whether the SPAR is a valid request. Once validated, the PPEA will route the SPAR to the appropriate cognizant engineering activity for resolution. If the appropriate activity is not clear, i.e. in the case of overlapping areas of cognizance, NAVSEA 05V will determine which organization will provide resolution. SPAR responses meeting the criteria below, DO NOT require NAVSEA approval and the PPEA has the authority to provide a final resolution to the requesting activity.

- a. The request concerns a PPEA cognizant system or component as defined in Enclosure (1) to PPEA-1.
- b. The request does not change:
 - (1) Engineering System Diagrams.
 - (2) System diagram attributes, such as system design or performance characteristics, material, pipe size, etc.
 - (3) Steam Plant Manual.
 - (4) Component Procurement Specifications.
 - (5) Component Technical Requirement documents.
 - (6) Component technical manuals.
 - (7) System testing requirements.
 - (8) GSO requirements.
- c. The request has no impact on Reactor Plant systems or components.

5.10.5.3 Categories. Actionable SPARs fall into one of four categories: Emergency, Urgent, Routine, and Date Needed By. Informational SPARs typically do not require a response. Emergency, Urgent, Routine and Date Needed By SPARs require an approved response delivered to the originator as follows:

- a. Routine – within 20 business days.
- b. Urgent – within 5 business days.

- c. Emergency – within 1 business day (24 hours).
- d. Date Needed by: Date specified by the originating activity to support upcoming evolutions or ship's schedule.

5.10.5.4 Coordination. Once a CVN SPAR response is developed, it is subsequently forwarded to NAVSEA 05V for approval. NAVSEA 05V1 coordinates the review and approval process for the various NAVSEA agencies. Any NAVSEA comments to the SPAR response are communicated directly to the responding activity during the approval process and then adjudicated. The approved SPAR response is returned to PPEA, who distributes the response to the ships and appropriate activities. The PPEA provides record retention services for all SPAR responses.

5.10.5.5 Routing. In addition to preparing SPAR responses, the PPEA is tasked as the Process Manager for both the SPAR and SPLI Programs. This involves dispositioning SPARs received, routing to the appropriate activity for resolution, routing of responses to NAVSEA for approval and distribution of approved responses to the requestor and other activities as appropriate.

5.10.5.6 Status. The EFORMS application maintains the status of all SPARs. This application includes the date the SPAR was received, the date the responding activity approved the response, the date the SPAR response was sent to NAVSEA, the current responsible party and current routing status. Reports listing all outstanding and completed SPARs for a desired time period can be retrieved from the application via the search engine function.

5.10.5.7 Software. Naval Sea Logistics Center is responsible for maintaining the EFORMS application that tracks SPAR status from receipt to completion, maintaining a historical file of completed SPARs, and having the ability to provide CET and PPEA management with meaningful statistics on SPAR processing.

5.10.5.8 Process Map. The PPEA SPAR Process Map is shown in detail in Figure 5-4 of this chapter.

5.10.6 Steam Plant Liaison Inquiry – Non-Nuclear Cognizant Areas. SPLIs are the Steam Plant equivalent of an NLI. SPLIs are used by the CET to request information, disseminate technical information associated with the Steam Plant, or direct work that does not require a drawing change or affect system configuration control, to the Fleet and overhaul activities. This document is intended to be a data collection tool only, and in general will not direct Forces Afloat to accomplish any repair, modification, or alteration to systems or components. Following NAVSEA approval, a SPLI is issued to the applicable TYCOM(s), who will forward the request to the appropriate ships via official letter. Each activity shall maintain an auditable file, containing all information associated with each incoming and outgoing (answered) inquiry. A SPLI may be necessary to obtain specific data and other information from Forces Afloat during development of SPAR responses and other CET products.

5.10.6.1 Process Manager. In addition to preparing SPLI's, the PPEA is tasked as the Process Manager for both the SPAR and SPLI Programs. Additionally, the PPEA is responsible for maintaining an SPLI log book/database and providing a historical file of completed SPLIs.

- a. The PPEA is responsible for keeping track of SPLIs in routing for concurrence, SPLIs issued to the fleet for accomplishment and ensuring the log book is updated as SPLIs are completed.
- b. The PPEA will route a copy of all SPLI responses received to the SPLI originator and other parties as applicable. If a SPLI request has exceeded the requested due date without the required response, the applicable CET representative shall contact the TYCOM to establish a revised due date. The final status of an SPLI shall be noted in the SPLI log book/database.
- c. The status of outstanding SPLIs will be reported monthly. The activity's report will be maintained by the PPEA SPAR/SPLI Process Manager and will list only those SPLIs which require a response.

5.10.6.2 Amplifying Information. Amplifying information is provided in the NLI/SPLI Process Map (Figure 5-5 of this chapter).

5.10.7 Reactor Plant Configuration Change Report. RPCCRs are used to report any and all changes to the configuration of any NAVSEA 08 cognizant space. This includes SHIPALTs, Ship Class Drawings, NLIs or any other form of authorized change. Addresses can be found in reference (d) or obtained through the TYCOM as needed.

- a. Formal instructions for completion of RPCCRs is found in Appendix 11 of reference (d). Blocks 1 - 30 (31 if needed) must be filled out in accordance with the instructions found in Appendix 11.

- b. Commanding Officers are directed to forward RPCCR(s) to NAVSEA 08 by official letter, similar to the sample in Appendix E of this chapter, using ship's letterhead with copies to the TYCOM, ANSTR Pittsburgh and A4W/A1G RPPY.

Figure 5-4 - PPEA SPAR Process Map

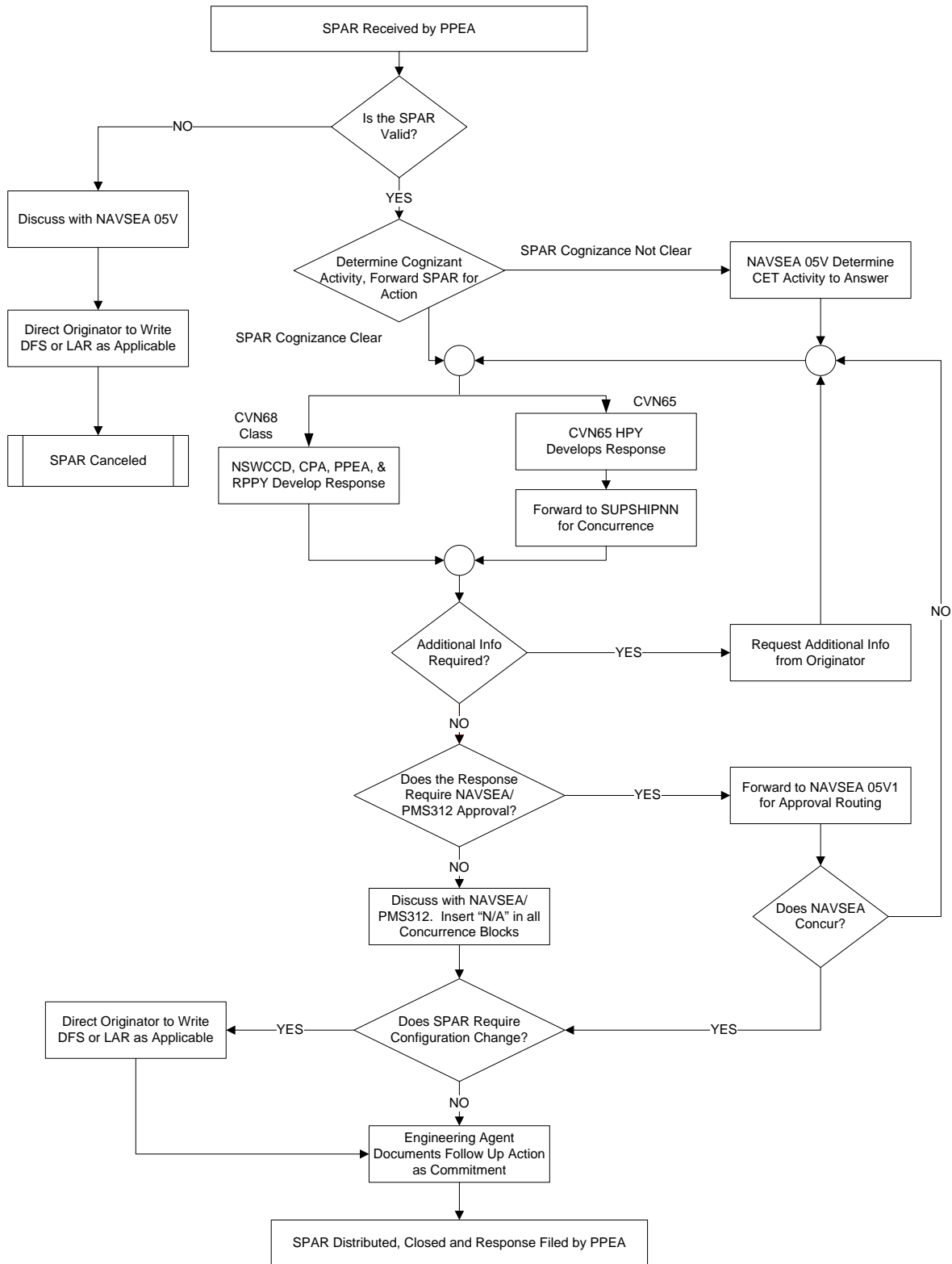

5.10.8 Technical Manual Deficiencies and Manual Change Requests.

5.10.8.1 Technical Manual Maintenance. Technical Manuals (TM) must be maintained current at all times. TMs associated with hardware must reflect current hardware configurations. Changes to hardware accordingly, must be accompanied by changes or revisions to the TMs. TMs must also be changed or revised to correct known deficiencies in the technical content in instances not related to hardware modifications.

5.10.8.2 Technical Manual Deficiency/Evaluation Report. The TMDER, NAVSEA/Space and Naval Warfare Systems Command (SPAWAR) Form 4160/1, (Appendix F of this chapter) is used to identify technical and non-technical discrepancies/deficiencies (non nuclear cognizant) in NAVSEA or SPAWAR technical manuals. It may be that a paragraph or page is missing, that measurements or troubleshooting procedures are incorrect, a safety step is omitted, instructions are unclear or that the text or illustrations are not legible. Whatever the issue, it must be corrected. The TMDER is a quick and efficient tool for reporting problems with technical manuals that are used every day.

5.10.8.3 URGENT Deficiencies.

- a. URGENT deficiencies should be reported to the Naval Systems Data Support Activity (NSDSA) by priority Naval Message addressed to:

Commander, Naval Surface Warfare Center (NSWC PHD)
Port Hueneme Division, Code 5E00,
4363 Missile Way,
Port Hueneme, CA 93043-4307
- b. Via the web at <https://nsdsa.nmci.navy.mil/tmder/tmdp.aspx>.
- c. For users with a Technical Data Management Information System (TDMIS) account, the most expedient manner of TMDER submission is via the TDMIS Web Site.
- d. Unclassified TMDERs can be submitted from the TDMIS database via the “deficiency module”. This method is strongly encouraged. Instructions for each method are detailed below.

5.10.8.4 Routine Deficiencies.

- a. Routine TM documentation deficiencies and concerns are reported via the web or using a paper TMDER. The paper form should be available in the back of any ship or NAVSEA/SPAWAR system tech manual. If not, a copy should be requisitioned.
- b. Attach a copy of the TM title page and the marked-up pages (if available) to the TMDER and mail to Commander, Naval Surface Warfare Center, Port Hueneme Division at the address above or via the web at <https://nsdsa.nmci.navy.mil/tmder/tmdp.aspx>.
- c. Again, TDMIS users may submit routine TMDERs via the “deficiency module” of TDMIS. Attachments may be uploaded in TDMIS.

5.10.8.5 Technical Manual Deficiency/Evaluation Report Process. TMDERs are received at NSDSA, logged into the TMDER tracking module and provided to the Technical Manual Maintenance Activity (TMMA) for review and response. The TMMA shall:

- a. Review, analyze and resolve TMDERs for all assigned TMs.
- b. Determine the accuracy and criticality of a reported deficiency.
- c. Inform the TMDER originator and update the deficiency data in the deficiency module of TDMIS: Urgent reports - 3 working days. Routine reports - 90 calendar days.
- d. Prepare or procure Field Change Bulletins, change packages and revisions or prepare changes, to correct TMDER reported deficiencies, using the Rapid Action Change process.
- e. Letters of response should include the appropriate status and shall be similar to the following:

- (1) Your TMDER # _____ for TM # _____ has been received by this activity for action. We have determined that a change to the manual is required. A change package (or revision) is in work or work is planned to start this fiscal year. Distribution is scheduled on (Mo/Yr).
 - (2) Your TMDER # _____ for TM # _____ has been received by this activity for action. We have determined that a change to the manual is not required for the following reason(s):
 - (3) Your TMDER # _____ for TM # _____ has been received by this activity for action. We have determined that the deficiency reported will not impede the operation/maintenance of the equipment, and that it is not cost effective to prepare a change at this time. The deficiency will be considered for incorporation with the next change package or revision.
- f. Notify NSDSA and the Acquisition Manager, TMDER originator or Designated Ship Program Management Office when a TMDER for the assigned TM cannot be reviewed, resolved, or TM updated. This notification can be completed via the on-line TMDER form in the TDMIS deficiency module.

5.10.9 Fleet COSAL Feedback Report.

5.10.9.1 Usage. This report is used specifically to call attention to and seek correction of any technical deficiencies found on Allowance Parts Lists (APL)/Allowance Equipage Lists (AEL), including those covered under P-OMMS. For example:

- a. The part/item is not listed on the APL/AEL, but is considered to be a “maintenance significant item”.
- b. APL is incomplete or is missing information, such as characteristics data, technical manual number, etc.
- c. Incorrect part/item listed on APL/AEL.
- d. Allowed quantity insufficient for PMS requirements.
- e. Part number in technical manual does not agree with APL.
- f. Non-allowed part required for PMS.
- g. APL technical problem such as incorrect Minimum Replacement Unit assignment.
- h. Source, Maintenance and Recoverability Codes and Allowance Note Codes noted on APL/AEL are not defined in any publication held.
- i. Suspected error in code assignments, e.g., Source, Maintenance and Recoverability Codes, Note Codes, etc.
- j. Circuit symbol number in Electronics APL (Section B) crosses to incorrect reference number or stock number.

5.10.9.2 Misuse. This report is not to be used to:

- a. Address any matters relating to Nuclear Reactor Plant COSAL (“Q” COSAL). Matters relating to Q-COSAL should be addressed by LAR through A4W RPPY
- b. Report equipment configuration changes. Ship’s Configuration Change Form, OPNAV Form 4790/CK, is to be used for this purpose. RPCCR for nuclear cognizant systems.
- c. Request changes in allowance for repair parts or equipage. Use NAVSUP Form 1220-2, except in cases when the allowance problem is caused by technical deficiencies in the COSAL, such as incorrect Minimum Replacement Unit assignment, PMS requirement not reflected in Standard Navy Stock List/Installation Sequence List etc. See reference (x) for further details concerning this form.

5.10.9.3 Form Location. The Fleet COSAL Feedback Report form (Appendix G of this chapter) can be found at www.anchordesk.navy.mil under the fleet support section. Distribution of the form should be as follows:

- a. Original to NAVSEALOGCEN Code N42.
- b. Copy to Ship's Supply Officer.
- c. Copy retained by Originator.

(This Page Intentionally Left Blank)

**APPENDIX A
DETERMINING SOFTWARE USABILITY**

**EXPIRATION DATE ON PACKAGE
(SHELF LIFE MANAGED)**

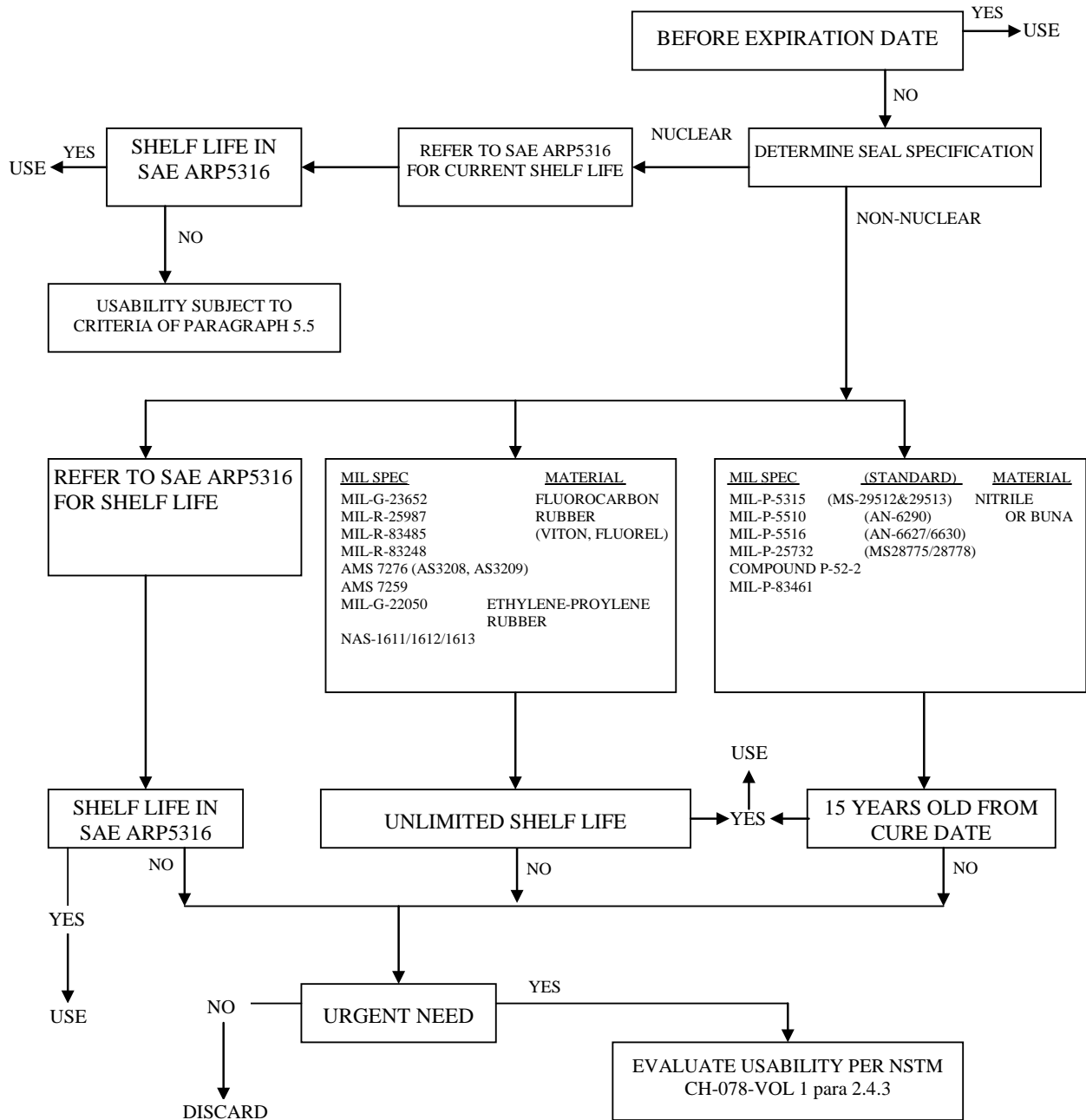

**REFERENCES: NAVSEA S9086-CM-STM-010/CH78
NAVSEA 0989-037-2000**

“USE BEFORE” DATE ON PACKAGE

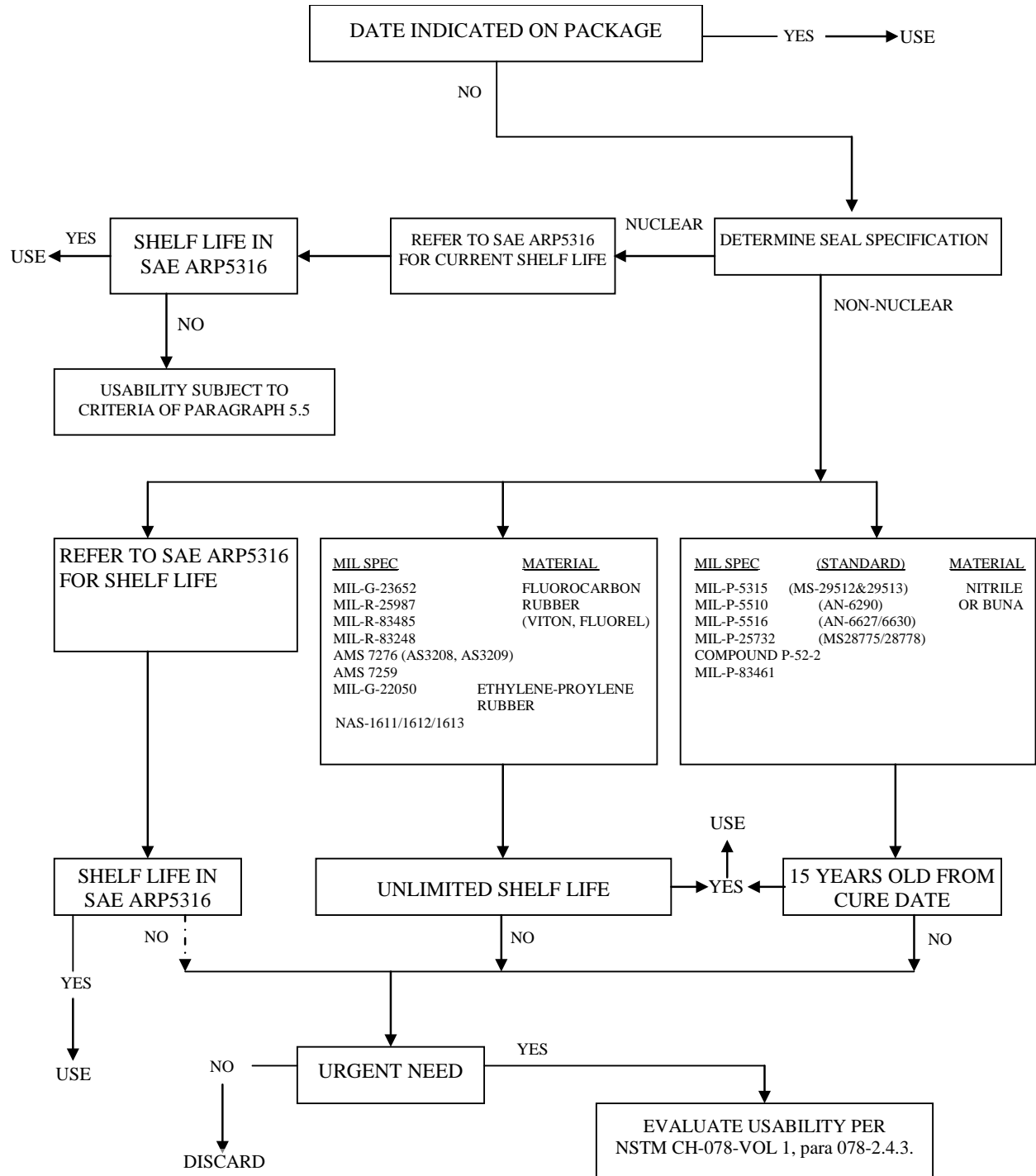

**REFERENCES: NAVSEA S9086-CM-STM-010/CH78
NAVSEA 0989-037-2000**

ITEM OF UNKNOWN AGE OR MATERIAL

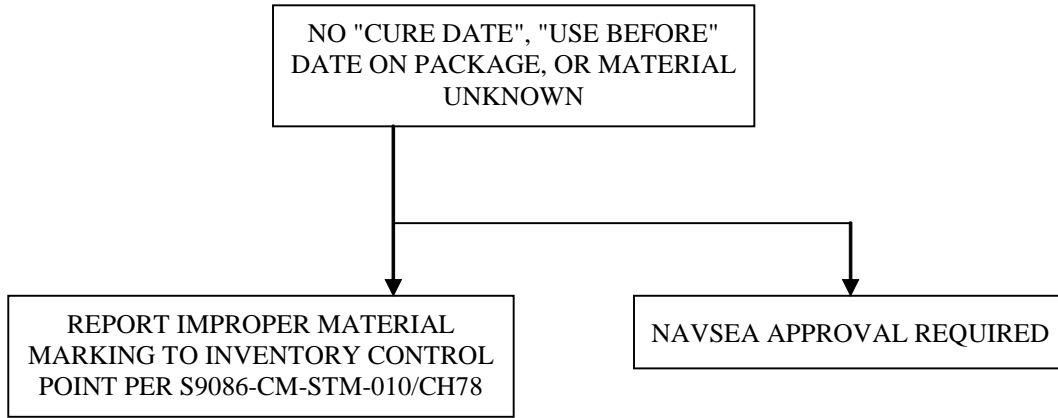

**REFERENCES: NAVSEA S9086-CM-STM-010/CH78
NAVSEA 0989-037-2000**

CURE DATE ON PACKAGE

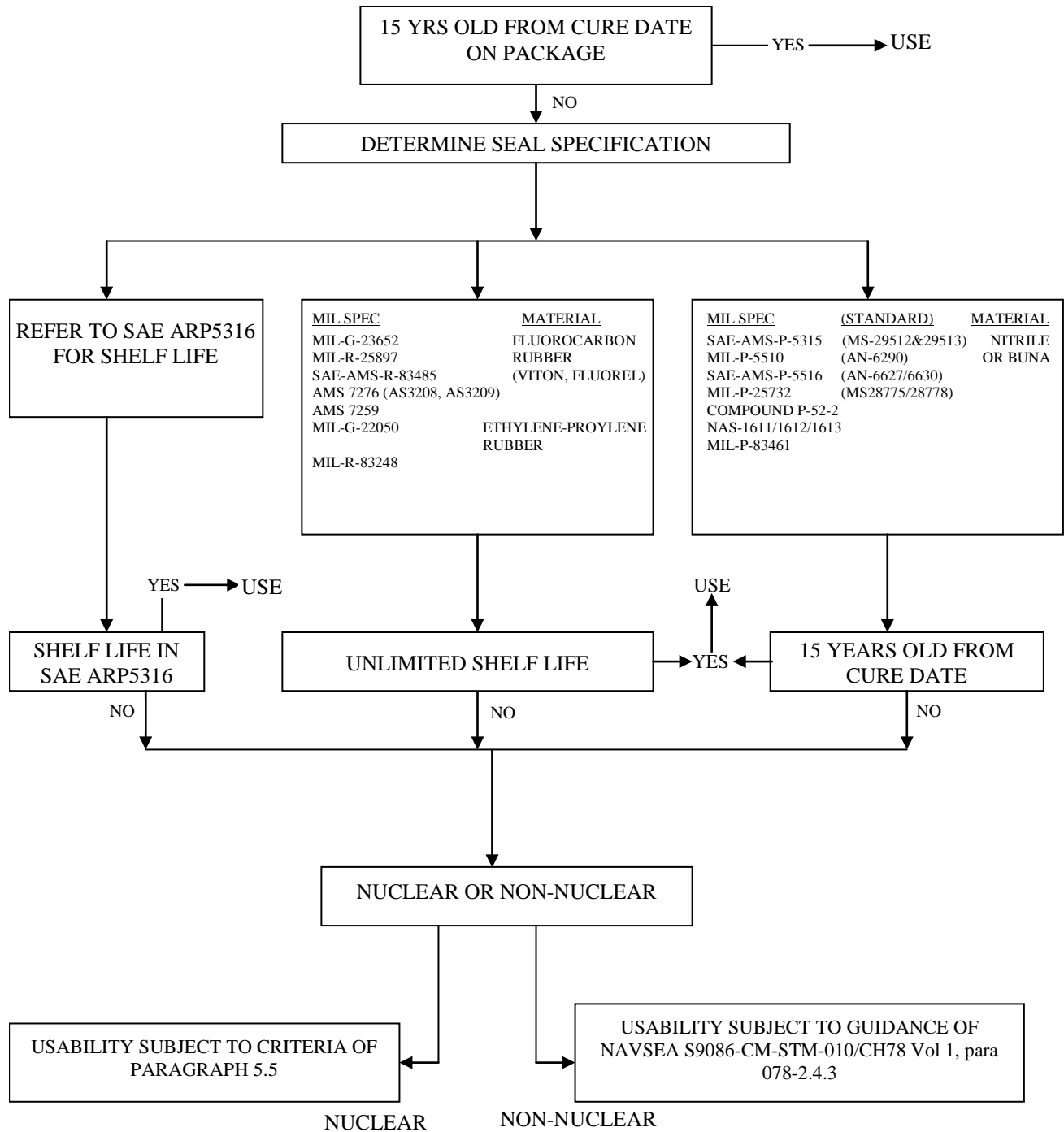

**REFERENCES: NAVSEA S9086-CM-STM-010/CH78
NAVSEA 0989-037-2000**

APPENDIX B**FORMAT FOR SUBMARINE CERTIFICATION CONTINUITY REPORT**

From: USS (Ship's Name)
 To: ISIC _____ (Note 1) Deployed ISIC (If applicable)
 Info: Parent ISIC (Applicable in all cases when deployed)
 Additional Addees (Note 2)

Subj: CERTIFICATION CONTINUITY

Ref: (a) COMUSFLTFORCOMINST 4790.3 - Joint Fleet Maintenance Manual, Volume V
 (b) NAVSEA 0924-062-0010 - Submarine Safety (SUBSAFE) Requirements Manual
 (c) NAVSEA T9044-AD-MAN-010 - Requirements Manual for Submarine Fly-By-Wire Ship Control Systems

1. In accordance with reference (a) and (b), all work performed within the SUBSAFE Boundary has been completed and satisfactorily retested except as noted in paragraph 2 below. There are no outstanding REC's for equipment/systems required for underway operations.

2. The following Controlled Work Packages/REC's were closed by transferring the remaining at-sea testing to a Departure from Specifications.

<u>CWP/REC Serial No.</u>	<u>DFS Serial No.</u>	<u>Type</u>	<u>Component</u>
---------------------------	-----------------------	-------------	------------------

3. All URO MRC mandatory tests/inspections have been successfully accomplished within the required periodicity. The following URO MRC requirements which have become due since the last underway period or which would have become due during this scheduled at-sea period have been completed during the preceding inport period as indicated or require at-sea operations and will be accomplished prior to the listed due date:

<u>URO MRC</u>	<u>Component Ident</u>	<u>Next Due (MO/YR)</u>
----------------	------------------------	-------------------------

4. The URO MRC Automated Work Requests for Ship's Force accomplished items have been signed, the data report forms have been mailed, and copies have been provided to the ISIC.

5. In accordance with reference (a) and (c), all work performed within the Submarine Fly-By-Wire Ship Control System Boundary has been completed and satisfactorily retested. There are no outstanding MCRs for equipment/systems required for underway operations.

NOTE 1: THIS CERTIFICATION REPORT MAY BE PROVIDED TO THE ISIC IN THE FORM OF A MEMORANDUM, MESSAGE, OR LETTER.

NOTE 2: ADDITIONAL ADDEES SHOULD BE ADDED AS NECESSARY BASED ON SITUATION (E.G., REPORT FOR UNDERWAY TRIALS DURING MAJOR INDUSTRIAL AVAILABILITIES WOULD NORMALLY INCLUDE SHIPYARD, NAVSEA AND TYCOM).

NOTE 3: IF NONE WAS ENTERED IN PARAGRAPH 3 THEN PARAGRAPH 4 IS NOT REQUIRED. PARAGRAPH 4 IS ONLY REQUIRED IF URO MRC ITEMS WERE COMPLETED BY SHIP'S FORCE.

NOTE 4: IF NO WORK ON THE SUBMARINE FLY-BY-WIRE SHIP CONTROL SYSTEM WAS PERFORMED, PARAGRAPH 5 IS NOT REQUIRED. PARAGRAPH 5 IS ONLY REQUIRED IF WORK ON THE SUBMARINE FLY-BY-WIRE SHIP CONTROL SYSTEM WAS PERFORMED.

NOTE 5: DELIVER THE CERTIFICATION CONTINUITY REPORT VIA ANY MEANS SUITABLE FOR OFFICIAL CORRESPONDENCE AGREED TO BY THE ISIC.

(This Page Intentionally Left Blank)

APPENDIX C**FORMAT FOR FLEET MAINTENANCE ACTIVITY CERTIFICATION REPORT TO TENDED
SUBMARINE**

Ser

From: Commanding Officer, (FMA)
To: Commanding Officer, (Tended Submarine)

Subj: CERTIFICATION CONTINUITY OF USS (Tended Submarine)

Ref: (a) COMUSFLTFORCOMINST 4790.3 - Joint Fleet Maintenance Manual, Volume V
(b) NAVSEA 0924-062-0010 - Submarine Safety (SUBSAFE) Requirements Manual
(c) NAVSEA T9044-AD-MAN-010 - Requirements Manual for Submarine Fly-By-Wire Ship Control Systems

Encl: (1) Copies of completed Re-entry Controls (REC)
(2) Copies of approved Departures from Specification (DFS) and Liaison Action Requests (LAR)
(3) Copies of completed MCRs for Submarine Fly-By-Wire Ship Control System

1. In accordance with reference (a), (b) and (c), certification of those SUBSAFE/Fly-By-Wire Ship Control Systems or portions of SUBSAFE/Fly-By-Wire Ship Control Systems, on which the FMA performed maintenance, has been sustained by the FMA. All required re-certification of the maintenance has been completed except as noted in paragraphs 2 and 3 below.

2. All CWPs for SUBSAFE/Fly-By-Wire Ship Control Systems opened by the FMA for maintenance have been closed and a copy of each completed REC/MCR is forwarded as enclosures (1) and (3) respectfully:

<u>CWP Serial No.</u>	<u>Task Description</u>	<u>Reason Deferred</u>
-----------------------	-------------------------	------------------------

3. The following Departures from Specifications (DFS) and Liaison Action Requests (LAR) for deviations from specification were approved as part of FMA maintenance in the SUBSAFE/Fly-By-Wire Ship Control System boundary. Copies of each are provided as enclosure (2):

<u>CWP Serial No.</u>	<u>DFS or LAR Serial No.</u>	<u>Type</u>	<u>Component</u>
-----------------------	------------------------------	-------------	------------------

4. The following URO maintenance requirements were satisfied and are reported as complete by the FMA. The original data report forms will be mailed to SUBMEPP with copies to your ISIC within 30 days.

<u>URO MRC</u>	<u>EGL (if applicable)</u>	<u>Component Identification</u>	<u>JCN</u>
----------------	----------------------------	---------------------------------	------------

Copy to:
Parent ISIC for ship
Parent ISIC for FMA

(This Page Intentionally Left Blank)

APPENDIX D**FORMAT FOR NON-FLEET MAINTENANCE ACTIVITY CERTIFICATION REPORT TO TENDED SUBMARINE**

From: Commander, <Activity Name>
 To: Commanding Officer, <USS Ship Name and Hull Number> Commander <Squadron Number>

Subj: CERTIFICATION CONTINUITY OF USS <Ship Name and Hull Number>, <Availability Number>

Ref: (a) NAVSEA 0924-062-0010 <Insert Rev>, Submarine Safety (SUBSAFE) Requirements Manual
 (b) SS800-AG-MAN-010/P-9290 <Insert Rev> - System Certification Procedures and Criteria Manual for Deep Submergences Systems (DSS)
 (c) NAVSEA T9044-AD-MAN-010 <Insert Rev>, Requirements Manual for Submarine Fly-By-Wire Ship Control System (FBW SCS)
 (d) COMUSFLTFORCOMINST 4790.3 <Insert Rev>, Joint Fleet Maintenance Manual

Encl: (1) List of Closed Re-Entry Controls <optional>
 (2) List of Approved Departure From Specification (DFS) <optional>
 (3) List of Scheduled URO-MRCs/HIPs Accomplished by the Activity <optional>

1. In accordance with references (a), (b), (c) and (d), certification of SUBSAFE/DSS/FBW SCS systems on which <Activity Name> performed maintenance has been sustained. All required recertification of the maintenance has been completed as noted in paragraphs 2 through 6 below.

2. All REC/MCRs for SUBSAFE/DSS/FBW SCS (SFCC) systems opened by <Activity Name> for maintenance have been closed as noted below:

REC/MCR Serial No

Task Description

<See enclosure (1) if needed>

3. The following Departures From Specifications (DFSs) for SUBSAFE/DSS/FBW SCS (SFCC) systems were approved as part of <Insert Activity Name> maintenance:

DFS Serial No.

Type

Component

<See enclosure (2) Part A if needed>

4. In addition to the DFSs listed above, the following DFSs were generated for work accomplished by <Activity Name> for the purpose of testing at Sea. If at sea testing is required, request Ship's Force report via naval message and inform <Maintenance Activity> of the results of at sea testing.

DFS Serial No.

Type

Component

<See enclosure (2) Part B if needed>

5. The following Scheduled URO-MRCs/HIPs were completed. URO-MRC/HIP data will be forwarded by <Activity Name> to SUBMEPP:

<u>URO-MRC/HIPs</u>	<u>EGL (if applicable)</u>	<u>Component ID</u>	<u>JCN</u>
---------------------	----------------------------	---------------------	------------

<See enclosure (3) if needed>

6. <Note: This paragraph is only applicable to those activities acting as a NSA/LMA> In accordance with reference (d) <Activity Name>, as Naval Supervisory Activity, reports that certification of SUBSAFE/DSS/FBW SCS systems for work accomplished by outside activities has been maintained based on the SUBSAFE/DSS/FBW SCS Certification Continuity letters as identified below:

<u>Supervising Activity</u>	<u>Letter Ser No./Naval Message</u>	<u>Description</u>	<u>ALT</u>
-----------------------------	-------------------------------------	--------------------	------------

SY Commander

Copy to:
COMSUBRON XXX <Assigned Squadron>
NSSC QAO or RSG QAO <as applicable>
NSRO <Shipyard performing work>
NRRO <Shipyard performing work>

APPENDIX E

RPCCR COVER LETTER FOR SHIPALTS (SAMPLE)

9210
Ser CVN XX-RX/
DD MMM YY

NOFORN (When Filled in)

From: Commanding Officer, USS _____ (CVN XX)

To: Commander, Naval Sea Systems Command (NAVSEA 08P)

Subj: CHANGES TO REACTOR PLANT CONFIGURATION STATUS (SHIPALT)

Ref: (a) NAVSEA 0989-043-0000, Commissioned Surface Ship General Reactor
Plant Overhaul and Repair Specification (U)

Encl: (1) End of Availability Reactor Plant Configuration Change Letter

(2) RPCCR JCN_____

1. The following reactor plant SHIPALTs are hereby reported in accordance with reference (a) and the SHIPALT Approval Record.

SHIPALT	BRIEF	COMPLETION STATUS
---------	-------	-------------------

2. Enclosures (1) through (X) attach a Reactor Plant Configuration Change Report for each change in the period _____ through _____ including each completed or partially completed SHIPALT.

3. Ship's Material History Records have been revised in accordance with NAVSEAINST 9210.37 to reflect these modifications and changes to onboard repair part support have been initiated.

X. X. XXXXXX

By direction

Copy to:

COMNAVAIRLANT/COMNAVAIRPAC (Code N9)

ANSTR, Pittsburgh

NAVICP, Mechanicsburg (Code 87)

A4W RPPY

RMO

(Place NOFORN statement)

(This Page Intentionally Left Blank)

**APPENDIX F
TECHNICAL MANUAL DEFICIENCY REPORT (TMDER)**

Ref: NAVSEAINST 4160.3A NAVSEA S0005-AG-GYD-010/TMMP			
NAVSEA/SPAWAR TECHNICAL MANUAL DEFICIENCY/EVALUATION REPORT (TMDER)			
<p>INSTRUCTIONS: Continue on 8 ½" x 11" page if additional space is needed.</p> <p>1. Use this report to indicate deficiencies, problems and recommendations relating to publications.</p> <p>2. For CLASSIFIED TMDERs see OPNAVINST 5510H for mailing requirements.</p> <p>3. For TMDERs that affect more than one publication, submit a separate TMDER for each.</p> <p>4. Submit TMDERs at web site https://nsdsa2.phdnswc.navy.mil or mail to: COMMANDER, CODE 310 TMDER BLDG 1389, NAVSURFWARCENDIV NSDSA, 4363 MISSILE WAY, PORT HUENEME CA 93043-4307</p>			
1. PUBLICATION NUMBER	2. VOL/PART	3. REV/DATE OR CHG/DATE	4. SYSTEM/EQUIPMENT ID
5. TITLE OF PUBLICATION			6. REPORT CONTROL NUMBER (6 digit UIC-YY-any four: xxxxxx-03-xxxx)
7. RECOMMEND CHANGES TO PUBLICATION			
7a. Page #	7b. Para #	7c. RECOMMENDED CHANGES AND REASONS	
8. ORIGINATOR'S NAME AND WORK CENTER	9. DATE	10. ORIGINATOR'S E-MAIL ADDRESS	11. TMMA of Manual (NSDSA will complete)
12. SHIP OR ACTIVITY Name and Address (Include UIC/CAGE/HULL)		13. Phone Numbers: Commercial (___) ___-___	

(This Page Intentionally Left Blank)

**APPENDIX G
FLEET COSAL FEEDBACK REPORT**

Fleet COSAL Feedback Report

[ANCHORDESK WEBSITE ?](#)

Request Nbr: NOT ASSIGNED Submitted: 05/27/2009 07:45 PM

Mandatory Fields in Red

FROM:	name/activity	APL/AEL NUMBER:	APL DATE:
<input type="text"/>		<input type="text"/>	<input type="text"/>
	address line 1	TECHNICAL MANUAL NBR:	PAGE:
<input type="text"/>		<input type="text"/>	<input type="text"/>
	address line 2	REF/CIRCUIT SYMBOL NBR:	NSN:
<input type="text"/>		<input type="text"/>	<input type="text"/>
	address line 3	CAGE: JCN/JSN:	PART NUMBER:
<input type="text"/>		<input type="text"/> <input type="text"/>	<input type="text"/>

TO: NAVSEALOGCEN Building 307 P.O. Box 2060 Mechanicsburg, PA 17055-0795	NAMEPLATE DATA: (for material handling Equipment Include USN No) <input type="text"/>
---	---

Fully describe the technical problem. Be specific, include Part Numbers and FSCM, RSNS/CSNS, NSN, and Item Name.

Identify Amplifying Documents Which Are Available

When practical, attach files of any amplifying documents, i.e., copies of Tech. manual pages, drawings, schematics, MRC cards, etc.

File1: File2: File3:

SUBMITTED BY:

Name , Rate, Work Center	Telephone Number	WC Supervisor
<input type="text"/>	<input type="text"/>	<input type="text"/>
Email Address		
<input type="text"/>		

REVIEWED BY:	ORIGINATOR'S SERIAL/TRANSMITTAL NUMBER:
<input type="text"/>	<input type="text"/>

This information resides on a DoD interest computer. Important conditions, restrictions, and disclaimers apply.
[Please read our Privacy Policy.](#)

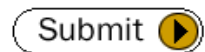

(This Page Intentionally Left Blank)

VOLUME V
PART I
CHAPTER 6
MATERIAL CONTROL

REFERENCES.

- (a) NAVSEA 0948-LP-045-7010 - Material Control Standard
- (b) NAVSEA SS800-AG-MAN-010/P-9290 - System Certification Procedures and Criteria Manual for Deep Submergence Systems
- (c) NAVSEAINST C9210.34 - All Nuclear Projects - Material Identification and Control Requirements for Naval Nuclear Reactor Plant Piping Systems
- (d) NAVSEAINST C9210.4 - Changes, Repairs and Maintenance to Nuclear Powered Ships
- (e) NAVSEA S9213-45-MAN-000 - Naval Nuclear Material Management
- (f) NAVSEA 0989-LP-037-2000 - Commissioned Submarine General Reactor Plant Overhaul and Repair Specification
- (g) NAVSEA 0989-LP-043-0000 - Commissioned Surface Ship General Reactor Plant Overhaul and Repair Specification
- (h) NAVSEAINST 9210.23 - Naval Nuclear Work at Naval Activities and Private Shipyards - Certification of Work Accomplishment and Data Retention of Associated Records and Retention of Design Records - Requirements for
- (i) NAVSEA 0387-LP-046-8000 - System Hydrostatic Test Requirements
- (j) MIL-STD-792 - Identification Marking Requirements for Special Purpose Components
- (k) NAVSEA T9044-AD-MAN-010 - Requirements Manual for Submarine Fly-By-Wire Ship Control Systems
- (l) NAVSEA 0924-062-0010 - Submarine Safety (SUBSAFE) Requirements Manual
- (m) NASM 7838 - Bolts, Internal Wrenching
- (n) NAVSEA S9425-CF-STD-010 - Submarine Antenna/Periscope and Mast Materials
- (o) NAVSEA 0900-LP-016-7008 - Submarine Antenna Technical Documentation
- (p) NUSC 551 - Handbook for Submarine Antenna Systems
- (q) NAVICPINST 4355.5 - Receipt, Inspection, Storage and Issue of Level I/SUBSAFE Material

6.1 **PURPOSE.** To define responsibility and provide guidance for material control which includes procurement, receipt inspection, stowage, issue, in-process control, and records for controlled material used in maintenance.

6.1.1 **Discussion.** Controlled material is the term used in this manual to describe those materials designated for use in or removed from Submarine Safety (SUBSAFE), Level I (LI), Scope of Certification (SOC), Submarine Flight Critical Components (SFCC), and Nuclear LI systems which are in the custody of the end-user work center, division Controlled Material Petty Officer (CMPO) or are undergoing receipt inspection, have been certified for use and are tagged with the appropriate Quality Assurance (QA) forms of this manual. In this manual, material in the custody of the Naval supply system, which includes the supply departments onboard ships and Fleet Maintenance Activities (FMA), is identified as LI stock program materials or nuclear repair parts. Reference (a) provides the special administrative and technical requirements that are levied by Naval Sea Systems Command (NAVSEA) for materials from fabrication to final installation for non-nuclear and nuclear controlled material, respectively. Section 6.3 of this chapter for non-nuclear material control provides direction for implementation of higher authority requirements pertaining to material control. Reference (b) and Part III, Chapter 6 of this volume provide specific requirements for receipt inspection and control of SOC material.

6.2 NUCLEAR.

NOTE: INFORMATION ON THIS SUBJECT IS SAFEGUARDED IN ACCORDANCE WITH OPNAVINST N9210.3.

6.2.1 Controlled Material Determination. This section describes the use of the specific references used to identify proper material for repair work. It is important that the difference between system and part Level of Essentiality be understood. A system may be LI, but this does not mean that every part in the system will be LI. This section also provides references and guidance necessary to obtain this understanding and to determine if controlled material is required, and if so, the proper level of control.

6.2.1.1 General Requirements. In order to determine the correct material to be installed in a ship and to properly certify the material prior to installation, the work center responsible for the specific area of the ship must first gather the appropriate reference material as follows:

- a. Drawings that specifically define the system and component.
- b. System/Component Technical Manual.
- c. Applicable Allowance Parts List (APL) from the ship's Coordinated Shipboard Allowance List (COSAL).
- d. Component replacement manuals, etc.
- e. NAVSEA Instructions.
- f. Military Standards.

6.2.1.2 Determination of Required Repair Parts. Using the above reference materials, the required repair parts will be determined by comparing the appropriate part number from the technical manual or drawing (if no technical manual) to the part numbers listed in the APL and therefore obtaining the National Stock Number (NSN) with associated Special Material Identification Code (SMIC), if assigned or listed on the APL.

NOTE: THE USE OF NUCLEAR REPAIR PARTS (NRP) WILL BE RESTRICTED TO THOSE SPECIFIC APPLICATIONS WHERE REQUIRED.

6.2.1.3 Determination of Level of Control. The next step is to determine if the material identified by the NSNs in paragraph 6.2.1.2 of this chapter is certifiable, if required, as controlled material for the system or component. In order to determine level of control required for the parts, the Level of Essentiality for the system and component must be determined for nuclear systems. Controlled material is used in systems designated with a Level of Essentiality in accordance with reference (c) for Nuclear LI.

NOTE: A SMIC (E.G., X1, X2, X3, X4, X5, X6), IS ADDED TO THE END OF THE NSN. IT IS ASSIGNED TO SELECTED COMPONENTS AND REPAIR PARTS BY THE NAVAL SUPPLY SYSTEM AND IS USED FOR CONTROLLING THE ISSUANCE AND STOCKING OF THESE COMPONENTS AND REPAIR PARTS WITHIN THE NAVY SUPPLY SYSTEM. IT SHOULD NOT BE CONFUSED WITH THE LEVEL OF ESSENTIALITY. A SMIC IS AN ADMINISTRATIVE TOOL FOR THE SUPPLY SYSTEM. LEVEL OF ESSENTIALITY IS A TECHNICAL DESIGNATION APPLICABLE TO SPECIFIC PIPING SYSTEMS.

6.2.1.4 Nuclear Material Level Determination. The following can be used to assist in determining the required "Level of Essentiality" for the material.

- a. Determine if the system to be repaired is nuclear by using reference (c) or (d) or the applicable piping system drawing.
- b. Determine if the nuclear system and repair part is Nuclear LI by reviewing reference (c) and the piping system drawing. If the drawing designates the component as LI, or II, the component is equivalent to LI. Systems, material, or components designated as Nuclear Level III should be considered non-Level. In the absence of specific level designations, or if questionable or conflicting Levels of Essentiality exist, refer to references (a) and (c) for proper determination.

6.2.2 Controlled Material Procurement. This section provides general guidance for procurement of nuclear controlled material. It should be noted that NAVSEA and Naval Supply Weapon Systems Support (NAVSUP WSS) have adequate programs in place for procurement of controlled material for nuclear applications. Therefore, ships and repair activities should always obtain controlled material from the Navy supply system. This section also provides:

- a. Background regarding NAVSEA and NAVSUP WSS controlled material procurement programs.
- b. Summary of or reference to the NAVSEA and NAVSUP WSS requirements for nuclear controlled material procurement.

6.2.2.1 General Requirements.

- a. NRP are procured by several Nuclear Material Procurement Programs and certified, when required by certain NAVSEA specifications (e.g., reference (e) for 2S-X1 components). NRP are generally identified in the supply system by SMIC codes X1, X2, X3, X4, X5 and X6.
- b. Nuclear LI material which meets acceptance criteria will be marked with a permanent Material Identification and Control (MIC) code when required by reference (a). A manufacturer's marking which provides traceability may be used in lieu of a MIC number.

6.2.2.2 Controlled Material Procurement.

- a. Material for Nuclear Level I applications should be procured in accordance with references (a), (c) and (e). For reactor plant components and equipment, identified by a "2S" cognizance NSN and "X1" SMIC, requisitions should include supplementary information required by reference (e). When substitute material must be used because the original material is no longer available, refer to references (f) and (g). Section 9020-0 of reference (f) for Submarines and Chapter 5 of reference (g) for Surface Ships identifies the Reactor Plant Replacement Component Technical Manual for each reactor plant.
- b. When ordering nuclear material, the Q-COSAL and reference (e) should be used.
- c. Nuclear Material Procured Outside the Supply System. Reference (e) states, "Fleet activities will not locally procure material for use in NRP applications. If non-stocked items are required, activities shall submit non-standard requisitions to NAVSUP WSS according to Naval Supply Systems Command (NAVSUP) P-485". Requisitions for NAVSUP WSS managed NRP material shall be prepared according to NAVSUP P-485 and applicable Type Commander (TYCOM) directives. Requisitions for NAVSEA Nuclear Propulsion Directorate (08) managed 2S/X1 components shall be prepared according to reference (e).

6.2.3 Receipt Inspection of Nuclear Controlled Material. This section provides the guidance and procedures for forces afloat and FMAs to conduct and document receipt inspections to certify controlled material as acceptable for installation.

6.2.3.1 General Requirements. Once the material ordered for use in LI systems is received, the material must be receipt inspected in accordance with reference (a). Receipt inspection of this material is required to establish positively that the material is the correct material for the job.

NOTE: THE TECHNICAL INSPECTION REQUIREMENTS OF THE APPLICABLE TECHNICAL MANUAL, DRAWING OR OTHER TECHNICAL REFERENCE AND PIPING SYSTEM MATERIAL REQUIREMENTS (E.G., CLEANLINESS, DIMENSIONS, SURFACE FINISH) ARE THE RESPONSIBILITY OF THE END-USER (WORK CENTER SUPERVISOR/CRAFTSMAN) TO ACCOMPLISH PRIOR TO INSTALLATION AND ARE NOT PART OF THE RECEIPT INSPECTION OF THIS MANUAL.

- a. Reference (a) provides the controls and certain testing requirements that are levied by NAVSEA to cover the material from fabrication to final installation for nuclear material.
- b. For Nuclear LI material, the unique requirement for "traceability" is invoked, meaning that a marking system is employed which links the material to Objective Quality Evidence (OQE). OQE for the material is the quantitative and qualitative data proving that the material conforms to specified requirements. To meet the requirements for traceability, the following requirements are instituted:
 - (1) Receipt inspection of the material.
 - (2) Use of QA tags in association with the item(s).
 - (3) Segregated stowage for Nuclear LI.

- (4) Custody by CMPOs, Controlled Material Handlers (CMH), Quality Assurance Inspectors (QAI) or qualified craftsman.
 - (5) Use of material verification procedures, as required by reference (a), during installation of the material.
- c. For Nuclear LI material, all signatures made on QA-form 2 (Material Identification and Control Tag) are considered to be certification signatures as defined in reference (h). The individual responsible for performing the certification shall be indicated in each signature block on the QA form 2 and that person shall understand his/her signature to indicate the following: "The person designated to sign for an action verifies, based on personal observation, and certifies by their signature that the action has actually been performed in accordance with the specified requirements."

6.2.3.2 Quality Assurance Forms for Receipt Inspections. The QA forms necessary to complete and document receipt inspections (QA form 1 and QA form 2) are addressed in paragraph 6.2.3.5 of this chapter.

6.2.3.3 Nuclear Receipt Inspection. The receipt inspection requirements for NRP as required by reference (a) are provided in paragraph 6.2.3.5 below, and will be used for the receipt inspection of Nuclear LI material.

6.2.3.3.1 Receipt Inspection of Nuclear Material. Controlled material for nuclear applications is designated as Nuclear LI. Reference (c) discusses the Nuclear Systems and the associated Level of Essentiality as either Nuclear LI or Level-none. Project Target Ready for Issue (RFI) tag (NAVSEA 9210/2, Figure 6-1 of this chapter or NAVSEA 9210/2, Figure 6-2 of this chapter) will be attached to all SMIC X1, X2 or X4 Nuclear LI RFI material. X1 material components and repair parts furnished by NAVSEA 08 prime contractor may not have RFI tags attached; however, this material is considered pre-certified and ready for use. The RFI tags depicted in Figure 6-3 and Figure 6-4 of this chapter will be attached to Nuclear LI or non-LI material, respectively, previously inspected by a Naval shipyard. SMIC X6 components and repair parts will not have RFI tags attached. X6 includes material formerly classified as X3 and X5 items that were procured as LI Material in accordance with NAVSEA 0900-070-6010. Additionally, material may be received with other tags (e.g., hydrostatic test tags in accordance with reference (i)).

- a. Project Target is a NAVSEA nuclear material procurement program.
- b. NAVSEA Prime Contractor. Material supplied by NAVSEA prime contractors may or may not have an RFI tag attached, but such material should be receipt inspected and handled the same as material received with an RFI tag. Material supplied by NAVSEA prime contractors is identified by a 2S cognizance/X1 SMIC NSN and N00024 in the contract number.
- c. It should be noted that reference (a) only contains requirements for nuclear piping system MIC. Nuclear piping system material requirements (e.g., cleanliness, dimensions, surface finish) and requirements to perform technical inspections in accordance with the applicable material technical manuals are not included in reference (a).

6.2.3.4 General Requirements for Nuclear Material.

- a. Supply departments of Fleet activities will perform the basic receipt inspection required by the appropriate NAVSEA, NAVSUP WSS instruction prior to placing the material into stock inventory. QA forms of this manual are not required to be completed and/or placed on the material by supply department personnel.
- b. Material identification must remain on or with the material throughout all stages of stowage, fabrication and installation.
- c. Material awaiting or undergoing receipt inspection will be segregated from accepted material.
- d. If guidance in addition to that specified in paragraph 6.2.3.5 of this chapter is required, reference (a), Section 3.4 and reference (e), specifies the certification and receipt inspection requirements for Nuclear LI material.
- e. The certification of the material, or verification the material is certified for use, will be accomplished by the end-user.

- f. New Construction Ships. During outfitting, Nuclear LI material may be received without an RFI tag. The Supervisor of Shipbuilding must provide a “by-serial-number” list of NAVSEA Prime Contractor SMIC X1 components provided to the shipbuilder directly by the prime contractor. Additionally, the letter should state that since the material is from a prime contractor, it is exempt from the requirements to perform a generic material identity verification. A copy of this letter must be kept on file for reference by the ship and this letter should be treated as a permanent record.
- g. Unit of Issue. QA form 2 (Material Identification/Control tag) will be attached to each accepted unit of issue (e.g., a valve, can of weld wire, length of barstock).
- h. Package Alteration Kits. Package alteration kits should not normally be opened until the ship/FMA is ready to proceed with the installation, provided that a certification of the contents and a copy of the installation instructions are in the envelope on the outside of the box. When the ship/FMA is ready to proceed with the installation, the lead work center CMPO will open the kit and perform the receipt inspection.

6.2.3.5 Nuclear Material Receipt Inspection Procedures. The following tables are to be used as a guide in conducting a proper receipt inspection in accordance with reference (a). Disassembly of the item is not required or intended by any of these procedures.

- a. Navy supply system material requisitioned for Nuclear LI applications.

NOTE: SHIP’S FORCE IS NOT REQUIRED TO USE A QA FORM 1 TO DOCUMENT RECEIPT INSPECTION OF NUCLEAR LI MATERIAL TO BE IMMEDIATELY INSTALLED FOR A SPECIFIC MAINTENANCE ACTION. A QA FORM 2 WILL BE USED TO DOCUMENT RECEIPT INSPECTION OF MATERIAL TO BE IMMEDIATELY INSTALLED.

<u>Procedure</u>	<u>Responsibility</u>
Visually check for damage.	CMPO/CMH
Visually check the item to ensure the item is what was specified or ordered and retain any supplied OQE (None is required to be provided).	CMPO/CMH
Check markings or nameplate on the item for correct correspondence with the shipping papers (or Ready for Issue Tag, NAVSEA 9210/2). (Figures 6-1, 6-2 and 6-3 of this chapter).	CMPO/CMH
FMA assistance is required or another activity with a LI Certifying Activity Designator: If the Nuclear LI item has no permanent markings, (serial number, heat lot or batch number, etc.), the FMA will mark the item with a FMA nuclear MIC marking to allow traceability.	CMPO/QAI/CMH
Fill out QA form 1.	CMPO/CMH
Fill out and attach a QA form 2 to the item.	CMPO/CMH

NOTE: THE RFI TAG AND QA FORM 2 MUST REMAIN ON THE MATERIAL UNTIL INSTALLATION.

<u>Procedure</u>	<u>Responsibility</u>
If the item does not pass the above receipt inspection, attach a QA form 3 (Material Reject tag) to the material and reject the material.	CMPO/CMH

<p>Verify that the item is what is required for intended use and has satisfactorily completed receipt inspection and is certified for use. Complete the appropriate blocks on the QA form 2 and print name and sign the QA form 2. Turn over the material to a craftsman for fabrication and/or installation or stow in a controlled material storage area.</p>	<p>CMPO/CMH</p>
<p>Forward QA form 1 to QA Office when material is issued for installation.</p>	<p>CMPO/CMH</p>
<p>b. Material supplied from the NAVSEA Prime Contractor received by the ship at new construction.</p>	
<p><u>Procedure</u></p>	<p><u>Responsibility</u></p>
<p>Visually check for damage.</p>	<p>CMPO/CMH</p>
<p>Visually check the item to ensure the item is what was specified or ordered and retain any supplied OQE. (None is required to be provided).</p>	<p>CMPO/CMH</p>
<p>Visually check the material to ensure that material is as stated on the Supervisor of Shipbuilding supplied list including verification of serial number if provided.</p>	<p>CMPO/CMH</p>
<p>Fill out QA form 1. Attach all supporting documentation.</p>	<p>CMPO/CMH</p>
<p>Fill out and attach a QA form 2 to the item.</p>	<p>CMPO/CMH</p>
<p>Fill out applicable portion of QA form 2.</p>	<p>CMPO/CMH</p>
<p>If the item does not pass the above receipt inspection, attach a QA form 3 (Material Reject Tag) to the material and reject the material.</p>	<p>CMPO/CMH</p>
<p>Verify that the item is what is required for intended use and has satisfactorily completed receipt inspection and is certified for use. Complete the appropriate blocks on the QA form 2, print name and sign the QA form 2. Turn over the material to craftsman for fabrication and/or installation or stow in a controlled material storage area.</p>	<p>CMPO/CMH</p>
<p>Forward QA form 1 to QA Office when material is issued for installation.</p>	<p>CMPO/CMH</p>
<p>c. Nuclear LI material procured from a shipyard. (Does not include Naval supply system material with NSN and SMIC X1, X2, X4 or X6 material). Material which was procured or manufactured by a shipyard and which is then transferred to another activity may be accepted for use by the receiving activity if the shipyard provides certification that the material passed receipt inspection requirements (i.e., a tag or form that is equivalent to the NAVSEA 9210/2 (Figures 6-1 and 6-2) is acceptable proof of receipt inspection in accordance with reference (a)).</p>	

<u>Procedure</u>	<u>Responsibility</u>
Check item received to ensure that it is the one ordered or specified. Retain any OQE received.	CMPO/CMH
Check markings or nameplate data for correct correspondence with shipping papers.	CMPO/CMH
Fill out QA form 1. Attach all supporting documentation.	CMPO/CMH
Fill out and attach a QA form 2 to the item.	CMPO/CMH
Verify that the item is what is required for intended use and has satisfactorily completed receipt inspection and is certified for use. Complete the appropriate blocks on the QA form 2, print name and sign the QA form 2. Turn over the material to craftsman for fabrication and/or installation or stow in a controlled material storage area.	CMPO/CMH
Forward QA form 1 to QA office when the material has been issued for installation.	CMPO/CMH

6.2.4 Marking of Nuclear Repair Parts.

6.2.4.1 General Requirements. SMIC X1, X2, X4 and X6 NRP (except for SMIC X1 material provided by a prime contractor to the installing activity), passes from the manufacturers into the Navy supply system by way of Navy receipt inspection activities, which examine the material and subject it to a number of tests. Nuclear LI material which meets acceptance criteria is marked with a permanent MIC number. In some cases the manufacturer's marking is used for material identification.

- a. The purpose of MIC marking is:
 - (1) To denote that the marked material has been inspected, verified and accepted.
 - (2) To provide traceability from the installed material to OQE.
 - (3) To preclude complete re-inspection of material accepted by an approved activity.
- b. Two problems arise in application which can defeat the purpose of the MIC marking.
 - (1) Internal components of an assembly which is MIC marked on the exterior, are usually not marked individually, and can lose their identity as NRP if separated during disassembly. Strict adherence to "bag and tag" requirements, using Fleet QA forms, overcomes this problem. Any part which becomes separated from its QA form (a loss of traceability), must be treated as uncontrolled material.
 - (2) Reference (a) permits the use of shortened MIC numbers in cases where the entire marking cannot be applied due to space limitations.

This problem is circumvented by a tag affixed by the receipt inspection activity directly to the material or to its container, which lists the complete MIC number. The complete MIC marking is recorded during receipt inspection. Although the complete MIC marking would not be visible once the item was installed, traceability is maintained through the retained QA paperwork and tags associated with the job, which will list the full MIC number.
- c. The MIC markings are in addition to the required manufacturer's marking.
- d. Altering of a MIC marking is prohibited except to make documented corrections.
- e. Method of Marking Controlled Material. Nuclear physical marking methods are described in reference (j).

- f. Items not physically capable of being marked. Nuclear items such as small parts are packaged in homogeneous lots (i.e., same heat, batch or melt; and same vendor traceability) and the package is marked. If the package is opened, the individual items removed must be tagged with a QA form 2. The remaining items in the package will be controlled by the use of a single QA form 2 attached to the package.

6.2.4.2 Marking Requirements for Nuclear Repair Parts.

- a. Nuclear LI material is permanently marked by the manufacturer with the following information:
 - (1) The manufacturer's name, trademark or symbol.
 - (2) Kind of material. Normally the generic material designations contained in the Material Designator Catalog, Volume II of reference (a).
 - (3) Traceability information. The traceability information enables the manufacturer to trace a LI component back to the chemical and physical test results which prove that the material fabricated meets procurement specifications.
- b. If the entire manufacturer marking cannot be affixed due to space limitations, then the following priority applies:
 - (1) Kind of material.
 - (2) Traceability code number.
 - (3) Manufacturer's name, trademark or symbol.
- c. Navy receipt inspection activities, which are primarily shipyards in the case of NRP, add their own marking to Nuclear LI items they accept. This MIC mark consists of:
 - (1) Kind of material.
 - (2) Traceability number.
 - (3) Activity identification letter.
- d. If a complete receipt inspection MIC mark cannot be affixed due to space limitations, then the following priority applies:
 - (1) Kind of material.
 - (2) Traceability number.
 - (3) Procurement identification letter.
- e. RFI Material.
 - (1) NRP, which have the SMICs X1, X2, and X4 associated with the NSN, are tagged as RFI once accepted by Navy receipt inspection activities. The RFI tag clearly marks the item as properly receipt inspected and RFI. Receipt inspection by end user is still required by reference (a).
 - (2) The X1 SMIC identifies high value reactor plant components. The X2 SMIC applies to pipe, tubing, fittings, flanges, barstock, welding consumables and some LI fasteners that are used in reactor plants. The X4 SMIC covers high pressure components used in reactor plant applications.
 - (3) There are four types of RFI tags. NAVSEA 9210/2 (Figure 6-1 of this chapter) is attached to all Nuclear LI RFI material except that which is SMIC coded X4. Nuclear LI RFI material coded X4 is tagged with NAVSEA 9210/2 (Figure 6-2 of this chapter). Nuclear LI material previously inspected by a Naval shipyard is tagged with the RFI tag depicted in Figure 6-3 of this chapter. Non-LI nuclear material previously inspected by a Naval shipyard is tagged with the RFI tag depicted in Figure 6-4 of this chapter.

f. Sample MIC Markings.

(1) IN-804-8801-C 159 (N)

IN	804	8801	C	159	(N)
Generic	Lot	Date of	Certifying	Inspection	Nuclear
Material	Number	Inspection	Activity	Lot	
Designation					

NOTE: ADDITIONAL INFORMATION, SUCH AS INSPECTION LOT NUMBER, IS PERMITTED TO BE PART OF THE MIC MARK.

(2) CSA-(4-056-001)-N

CSA	4-056-001	N
Material	Receipt	Inspection
Code	inspection	Activity
	package	(Norfolk Naval Shipyard)
	number (traceability	
	number)	

(3) 7150-001-A-VBA

7150	001	A	VBA
Julian	Lot	CAD	Material
Date	#		
of			
Inspection			

(4) ST-00259-A01-S

ST	00	259	A01	S
Generic	Year	Julian	Lot #	Inspection
Type		Date	(A for	Activity
			Nuclear	(PSNS)
			LI)	

6.2.4.3 Assignment of Material Identification and Control Numbers for Items Manufactured from Certified Raw Materials. Nuclear LI items manufactured using certified Nuclear LI raw material (e.g., barstock, plate, forged shape) may be assigned the same MIC markings as the raw stock provided no work is done on the base material that would alter its chemical, physical or mechanical properties (machining and welding may be done).

6.2.5 Nuclear Repair Parts Downgrading.

6.2.5.1 Nuclear Controlled Material Downgrading. It is recognized that occasionally NRP and controlled material must be downgraded in order to support training or production work due to the unavailability of non-certified material. In order to maintain accountability of the end use of NRP and controlled material, the following procedure is required:

NOTE: ENSURE THAT ARTICLES 103 AND 211 OF REFERENCE (e) ARE FOLLOWED IF APPLICABLE TO THE MATERIAL TO BE DOWNGRADED.

<u>Procedure</u>	<u>Responsibility</u>
Obtain written authorization to downgrade the material from the Quality Assurance Officer (QAO).	Leading Petty Officer/Work Center Supervisor

Remove all MIC markings from the controlled material as well as all controlled material tags and forms. The QA forms with RFI tag will be forwarded to the QAO (ship) or QA office (FMA) with the approved authorization.

CMPO/CMH

6.2.6 Storage, Issue and Handling of Nuclear Repair Parts.

6.2.6.1 Storage Requirements.

- a. The Supply Department onboard an FMA or a ship will stow, handle and issue NRP as required by the governing NAVSEA, or NAVSUP WSS instruction.

NOTE: NRP BECOMES CONTROLLED MATERIAL, FOR THE PURPOSES OF THIS MANUAL, WHEN THE MATERIAL HAS BEEN RECEIVED BY THE CMPO/CMH OF THE WORK CENTER OR DIVISION.

- b. Nuclear controlled material in the custody of customers (ship or FMA work centers) will be segregated by a physical barrier, in clearly marked dry, secure, clean stowage and handling areas.

NOTE: THE SEGREGATION AND PHYSICAL CONTROL REQUIREMENTS OF PARAGRAPHS 6.2.6.1.b.(1), (2), and (3) OF THIS CHAPTER DO NOT APPLY TO NUCLEAR COMPONENTS WHICH ARE NOT SUBJECT TO MIX UP NOR TO NUCLEAR MATERIAL WHILE IT IS CLEARLY MARKED OR TAGGED TO INDICATE ITS LEVEL OF ESSENTIALITY AND GENERIC MATERIAL TYPE.

- (1) Use of separate boxes, shelves, roped off or marked (e.g., painted lines) areas are acceptable methods of segregation/stowage, provided they are clearly marked, allowing separation of the following materials:
 - (a) Nuclear LI.
 - (b) Material staged for a specific job or process.
 - (2) These materials must be segregated from each other and from other materials. Segregation will be maintained from receipt through staging. Access to controlled material will be positively controlled.
 - (3) Within a given level of material, different generic materials will be segregated from each other physically such that similar appearing materials of different generic types are not mixed.
 - (4) Unidentified material or rejected material will be segregated from acceptable controlled material.
 - (5) Material waiting receipt inspection will be segregated from controlled material and from rejected material.
- c. Controlled material will be handled and stored in a manner to prevent damage and be sealed for cleanliness when applicable.
 - d. Material received not meeting the receipt inspection requirements of paragraph 6.2.3 of this chapter will be rejected, tagged with QA form 3, and placed in segregated stowage to await disposition.
 - e. CMPOs/CMHs will inspect controlled material storage areas of their work center, semi-annually as a minimum to ensure:
 - (1) Material is in designated area.
 - (2) Material is properly identified.
 - (3) Material properly marked and tagged.
 - (4) Material is protected from damage.
 - (5) Material is kept clean.

(6) Material segregated as required.

6.2.6.2 Staging Requirements. Controlled materials of different Levels of Essentiality and non-controlled material may be co-located when staging material for a specific job provided that:

- a. All QA forms or identification tags attached to the material are annotated with the same Job Control Number and
- b. Material is segregated from material staged for other jobs or processes.

6.2.6.3 Issue of Nuclear Controlled Material. Nuclear controlled material should be issued for only those specific applications for which the nuclear material is required.

6.2.6.4 Handling of Nuclear Controlled Material. All controlled material received by a work center, whether received from the supply department as onboard stock, work center stores or from a tended ship must be controlled as required by reference (a).

- a. Controlled material must at all times be in physical custody of either the work center CMPO/CMH, QAI, a craftsman or stowed in a work center controlled material stowage area.
- b. Lots of material (e.g., box of bolts) broken down for end use, will maintain the same identification and control as the parent controlled item using QA form 2 as appropriate.
- c. The QA form 2, and/or any other identification (e.g., RFI tag) must stay with the material at all times until it is installed or reinstalled in the system.
- d. Transfer of MIC marking during issue of barstock or pipe will be accomplished by transferring the MIC to a new location on the piece to be sectioned, prior to sectioning, and be verified by the work center CMPO/CMH or a QAI before the original marking is lost.
- e. If, during fabrication, the original piece must be broken down (such as cutting off a piece of barstock) or the MIC marking will be lost by machining, welding, etc, the proper MIC markings will be transferred to the piece(s) prior to cutting or to the container, in case of small parts, and a QA form 2 as appropriate will be attached to each new piece.
- f. On completion of shop/ship fabrication or assembly stage, the QAI will check the finished product against the attached material identification tags for required material markings. The QAI will inspect the finished product for conformance to specifications. If satisfactory and if the required markings are present the QAI will print name and sign the QA form 2 as applicable.
- g. If for any reason at any time the product fails inspection, the QAI will reject the material, attach a QA form 3 and inform the QAO.
- h. The lead work center will be responsible for installation and the final acceptance block on all QA forms associated with a particular product. Assist work centers or divisions will be responsible for control of material which they use on a job.
- i. Material consumed (e.g., welding electrode, brazing alloy) in the fabrication process must have its identity (MIC number) recorded on the appropriate QA form that documents the weld or braze (e.g., QA form 18, QA form 20).
- j. Existing parts of certified Nuclear LI systems, retain their certification provided their traceability is maintained.
- k. All material, parts or components from controlled systems which are removed from the ship by Ship's Force, to be worked on by the FMA, must have a QA form 2 properly filled out and attached. If it is necessary for the FMA to disassemble such components, identification must be retained on each part which is controlled material using additional QA forms 2. The original QA form 2 will remain with the part or component until it is re-installed in the ship and then be removed and filed until final Controlled Work Package closeout. The QA-2 may then be disposed of.

1. Each controlled component removed from a ship's system in order to allow repair/maintenance will be tagged with a QA form 2 as appropriate to maintain identification and traceability. If a nuclear component is further disassembled, each pressure boundary part will be tagged with a QA form 2. Controlled components (e.g., valves and valve bonnets, pumps, etc.) disassembled and reassembled in a temporary controlled jobsite (established in a work space or at a jobsite) do not require individual QA tags to be filled out and attached to each controlled component (controlled components are defined in reference (a)), provided that:
 - (1) Access to the temporary controlled jobsite is controlled by a physical boundary and is marked with a posted sign stating "Temporary Controlled Jobsite".
 - (2) Rejected material must be identified, tagged with QA form 3 and removed from the area.
 - (3) Work must be actively in progress and not be longer than a shift or one normal working day on a job site vice in a FMA repair shop.

FIGURE 6-1

Tags similar to those shown in Figure 6-1 and Figure 6-2 were previously used to identify material receipt inspected and certified RFI. Therefore, material received with RFI tags similar to Figures 6-1 and 6-2 is acceptable for use without re-tagging.

NAVSEA 9210/2 Project Target Ready for Issue Tag

READY FOR ISSUE

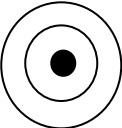
PROJECT  **TARGET**

MATERIAL

CERTIFIED BY (INDIVIDUAL) _____

INSPECTOR _____

ACTIVITY _____

DATE _____

NSN _____

SERIAL NUMBER _____

REMARKS _____

REMARKS: _____

COMPONENT CERTIFIED RFI _____ BY NNSY
 REQUIRED TEST(S) HAVE BEEN PERFORMED PER
 APPLICABLE N/S T/M. RECEIPT INSPECTION
 RECORDS ARE AVAILABLE AT NNSY CODE 2320.10
 R.I. PACKAGE NUMBER. _____

NAVSEA 9210/2 (E-77) SIN 0116-1 E-092-1006

FRONT **BACK**

White tag with black printing

FIGURE 6-2

SMIC X4

NAVSEA 9210/2 Project Target Ready for Issue Tag for X-4 Material

READY FOR ISSUE

PROJECT X 4 TARGET

MATERIAL

CERTIFIED BY (INDIVIDUAL)

INSPECTOR

ACTIVITY

DATE

NSN

SERIAL NUMBER

REMARKS

NAVSEA 9210/2 (5-77) S/N 0116J E-002-1006

PRE-INSTALLATION PREPARATIONS SUCH AS FINAL CLEANING, CALIBRATION, WELD END PREPARATIONS, IS THE RESPONSIBILITY OF THE INSTALLING ACTIVITY.

FRONT

BACK

White tag with black printing

FIGURE 6-3

In order to support the identification of Level I material previously inspected by a Naval shipyard, the following RFI tag shall be used:

Nuclear Level I Ready for Issue Tag

○
LEVEL-1 Ready for Issue
STOCK No.:
MIC No.:
<input type="checkbox"/> MAINTAINED BY TAG ONLY
VENDOR SERIAL No.:
DESCRIPTION:
GENERIC MATERIAL:
CERTIFYING ACTIVITY & DATE:
REMARKS/WAIVERS:
<input type="checkbox"/> SEE BACK
MATERIAL EXHIBITING THIS TAG HAS BEEN TECHNICALLY RECEIPT INSPECTED BY A NAVSEA CERTIFIED ACTIVITY TO MEET LEVEL-I REQUIREMENTS AS DEFINED IN NAVSEAINST C9210.34 (SERIES)

TAG FRONT

FIGURE 6-4

In order to support the identification of Non-Level I material previously inspected by a Naval shipyard, the following RFI tag shall be used:

Non-Level Nuclear Ready for Issue Tag

○
NON-LEVEL NUCLEAR Ready For Issue
STOCK No.:
RIN:
VENDOR SERIAL No.:
DESCRIPTION: _____ _____ _____
GENERIC MATERIAL:
SHELF-LIFE EXP:
CERTIFYING ACTIVITY & DATE:
REMARKS/WAIVERS: _____ _____ _____
[] SEE BACK
MATERIAL EXHIBITING THIS TAG HAS BEEN TECHNICALLY RECEIPT INSPECTED BY A NAVSEA CERTIFIED ACTIVITY FOR NON-LEVEL APPLICATIONS. IT IS NOT FOR USE IN LEVEL-I APPLICATIONS AS DEFINED IN NAVSEAINST C9210.34 (SERIES)

TAG FRONT

(Left Blank)

6.3 NON-NUCLEAR.

6.3.1 Controlled Material Determination. This section describes the use of the specific references used to identify proper material for repair work. It is important that the difference between system and part Level of Essentiality be understood. A system may be LI, but this does not mean that every part in the system will be LI. This section also provides references and guidance necessary to obtain this understanding and to determine if controlled material is required, and if so, the proper level of control.

6.3.1.1 General Requirements. In order to determine the correct material to be installed in a ship and to properly certify the material prior to installation, the work center responsible for the specific area of the ship must first gather the appropriate reference material as follows:

- a. Drawings that specifically define the system and component.
- b. System/Component technical manual.
- c. Applicable APL from the ship's COSAL.
- d. Component replacement manuals, etc.
- e. Ship's SUBSAFE Certification Boundary Book.
- f. LI Boundary Book.
- g. Military Standards (MIL-STD).
- h. Applicable ship class Fly-By-Wire Ship Control System Certification Boundary Book, per reference (k).

6.3.1.1.1 Determination of Required Repair Parts. Using the above reference materials, the required repair parts will be determined by comparing the appropriate part numbers from the drawing to the part numbers/drawings listed in the APL and thereby obtaining the NSN with associated SMIC, if assigned or listed on the APL.

NOTE: THE USE OF LI STOCK PROGRAM MATERIALS AND CONTROLLED MATERIAL WILL BE RESTRICTED TO THOSE SPECIFIC APPLICATIONS WHERE REQUIRED.

6.3.1.1.2 Determination of Level of Control. The next step is to determine if the material identified by the NSNs in paragraph 6.3.1.1.1 of this chapter is certifiable, if required, as controlled material for the system or component. In order to determine level of control required for the parts, the Level of Essentiality for the system and component must be determined for non-nuclear systems:

- a. Controlled material is used in systems designated with a Level of Essentiality in accordance with reference (a) for LI. The definitions of LI systems and material in accordance with reference (a) are provided to the users of this manual as paragraph 6.3.1.3 and 6.3.1.4 of this chapter.
- b. The applicable LI material control boundary book provides an interpretation of the latest reference (a) requirements.

NOTE: A SMIC (E.G., S1, SB, LI, C1, VIRGINIA CLASS COMPONENT (VU), SEAWOLF CLASS COMPONENT (SW)), IS ADDED TO THE END OF THE NSN. IT IS ASSIGNED TO SELECTED COMPONENTS AND REPAIR PARTS BY THE NAVAL SUPPLY SYSTEM AND AIDS IN CONTROLLING THE ISSUANCE OF THESE COMPONENTS AND REPAIR PARTS WITHIN THE NAVY SUPPLY SYSTEM. SMIC IS AN ADMINISTRATIVE TOOL FOR THE SUPPLY SYSTEM. LEVEL OF ESSENTIALITY IS A TECHNICAL DESIGNATION APPLICABLE TO SPECIFIC PIPING SYSTEMS.

6.3.1.2 Non-Nuclear Material Level Determination. The crux of the controlled material program at the maintenance level is establishing the required Level of Essentiality for repair parts, to include determination of whether a specific part is LI. This is important for three reasons:

- a. To serve as a partial check that the supply system has provided the correct part.
- b. To determine record-keeping requirements. This is particularly important in the case of alterations, where drawings may provide no Level of Essentiality for the parts and systems involved, and also on older ships, where the drawings may reflect no Level of Essentiality information at all or may use previous revisions of references (a) or (l).
- c. To determine the correct SMIC in the case of non-nuclear repair parts where the COSAL and the applicable drawing conflict over the required Level of Essentiality.

6.3.1.2.1 Systems and Components. Paragraph 6.3.1.3 of this chapter provides the LI systems and paragraph 6.3.1.4 of this chapter provides the LI components of reference (a).

6.3.1.2.2 Emergent Situation Upgrading. Upgrading the Level of Essentiality of a repair part provided by the supply system may become necessary during the course of maintenance and can be done in emergent situations using the procedures specified in reference (a) and paragraph 6.3.5 of this chapter.

6.3.1.3 Non-Nuclear Level I Systems and Boundaries.

- a. Submarines.
 - (1) Air, nitrogen and other gas systems, except oxygen and hydrogen, with design pressures of 1500 psig and above. Oxygen and hydrogen systems with a design pressure of 100 psig and above.
 - (2) Feedwater system with a design pressure of 600 psig and above.
 - (3) Main steam system, and all branch piping from this system which is designed to the main steam system design pressure, up to and including the first valve downstream of pressure reducing valves and their by-pass valves. Included will be high pressure steam drains up to and including the first valve downstream of the trap or orifice.
 - (4) Hydraulic systems for any steering or diving control surface, failure of which would cause loss of both the normal and emergency modes of operation for the control surface. Exceptions are internal wrenching bolts per reference (m), and Naval Aerospace Standard cap screws with NAS 1347, Type IV identification need not be to LI requirements.
 - (5) All circulating seawater systems (e.g., main seawater, auxiliary seawater, shaft seal water) or portions thereof, continually open to the sea below 200 feet. The brine and seawater feed portion of the distilling or reverse osmosis system which provides the through path of the shaft seal water to the main or auxiliary seawater system.
 - (6) All seawater and sea connected systems or portions thereof, which are intermittently subject to submergence pressure below 200 feet, and which are within the SUBSAFE Certification Boundary as defined by reference (l).
 - (7) Torpedo, signal ejector/launcher and trash disposal unit tubes. Included are the breech and muzzle doors and associated piping system components installed between the breech and muzzle doors that form part of the pressure boundary, up to and including the inboard joint of the backup closure.
- b. Surface Force Ships.
 - (1) Gaseous oxygen systems above 100 psig design pressure except for both the diver's recompression chamber and the diver's surface supplied oxygen systems, which are excluded from LI unless specifically invoked by NAVSEA in writing.
 - (2) Gaseous oxygen piping from the oxygen and nitrogen producer plant, storage tanks and fill station above 100 psig design pressure, including low pressure gaseous oxygen vent piping which is or can be cross-connected with high pressure gaseous oxygen piping.
 - (3) Surface Force. Main steam and all branch piping designed for temperatures above 775°F. Included will be high pressure steam drains up to and including the last valve downstream of the trap or orifice designed for temperatures above 775°F.
- c. Aircraft Carriers.
 - (1) Feed systems with design pressure of 600 psig and above.
 - (2) Main steam, catapult steam (including the trough heating system), and reboiler systems, and all branch piping connected to these systems designed for main steam system design pressure. Included will be high pressure steam drains up to and including the last valve downstream of the trap or orifice designed for main steam system design pressure.
 - (3) Gaseous oxygen systems above 100 psig design pressure except for both the diver's recompression chamber and the diver's surface supplied oxygen systems, which are excluded from LI unless specifically invoked by NAVSEA in writing.

- (4) Gaseous oxygen piping from the oxygen and nitrogen producer plant, storage tanks and fill station above 100 psig design pressure, including low pressure gaseous oxygen vent piping which is or can be cross-connected with high pressure gaseous oxygen piping.

- d. Submarine, Aircraft carrier and Surface Force Ship Requirements. The LI boundary requirements listed above apply to new construction, repairs, modifications, alterations and conversions for all submarines and surface ships regardless of the material identification and control requirements invoked, or not invoked, by the original shipbuilding specifications and/or system diagrams and component drawings.

NOTE: IT IS NOT THE INTENT TO REMOVE NON-LI MATERIAL SOLELY FOR THE PURPOSE OF INSTALLING LI MATERIAL. LI MATERIAL SHALL BE INSTALLED IN NEW LI SYSTEMS OR COMPONENTS OR WHEN REPLACING MATERIAL INCIDENT TO THE REPAIR OR REFURBISHMENT OF A LI SYSTEM COMPONENT(S).

- e. LI Designated Systems. Cognizant NAVSEA technical codes are responsible for determining any additional scope and boundary of individual systems, including the components and parts of components, that are to be controlled as LI material.

6.3.1.4 Level I Components.

- a. Pressure Boundary Parts. Pressure boundary parts of components within LI systems shall be controlled. LI pressure boundary parts include piping, tubing and the following:

- (1) Bodies. In general, these are the parts of a component that are the pressure boundaries of the component, including end connections. Examples are:
 - (a) Valve bodies.
 - (b) Strainer bodies.
 - (c) Cylinders (flasks, reservoirs).
 - (d) Pipe fittings (elbows, tees, couplings, union assemblies, separately furnished union tail-pieces).
 - (e) Trap bodies (housings).
 - (f) Orifice plates.
- (2) Covers. In general, these are component parts which act as pressure boundaries for the bodies listed above and other items. Examples are:
 - (a) Valve bonnets.
 - (b) Valve caps.
 - (c) Strainer caps.
 - (d) Closure plates for cylinders.
 - (e) Oxygen and nitrogen valve cartridges.
- (3) Plugs. All plugs, including submarine zinc anode plugs, set screws, adjusting screws and vent and drain plugs which form a part of the LI pressure boundary, or otherwise opened to the sea below 200 feet.
- (4) Fasteners. Bolts, nuts, studs, stud-bolts, and screws used when joining two pressure boundary parts. All hull integrity fasteners shall be LI. Fasteners used for joining non-LI machinery or equipment to LI material shall be LI when the component is located within the LI boundary.
- (5) Extension Pieces. In general, these are branch systems connecting “bodies” and “covers” which are subject to piping system pressures and temperatures. In many cases they are furnished with end connections for installing into either main or branch system piping. Examples are:
 - (a) Blowdown or drain nipples (e.g., pipe, including pipe fittings or flanges).

- (b) Union tail-pieces when part of a component end connection (including flange union connections).
- (c) Separate bosses (attached to “bodies” or “covers” and providing connections for external piping).
- (6) Miscellaneous.
 - (a) Portions of submarine pressure hull penetrations, excluding hull structure items, which isolate seawater from the submarine atmosphere. Examples of hull penetrations are: hull fittings (electrical and fiber optic), rodmeters, periscopes, and periscope hoist cylinders, radar masts and antennas, main propulsion shaft seal housings, floating wire and towed array shear valve assemblies, and lubrication distribution valves.
 - (b) Brazing alloys and welding filler metals, including consumable inserts.
 - (c) Union nuts (both bonnets and end-connection unions).
 - (d) Hose assembly end fittings and the nipple, flange, and body of sound isolation couplings (e.g., Rubber Insert Sound Isolation Couplings (RISIC)) which form a part of the pressure boundary.
 - (e) All submarine seawater or sea connected hull and backup valve internal metallic pressure containing parts that serve to directly isolate seawater from the atmosphere or downstream connected system(s) (e.g., balls, disks, flappers, and poppets).
 - (f) Valve stems which penetrate the pressure boundary.
 - (g) Oxygen charging lines and assemblies.
 - (h) In-line instrumentation components and parts:

<u>INSTRUMENTS</u>	<u>LEVEL I PARTS</u>
Temperature	Thermowell (welded and flanged bare bulb)
Flow	Meter casing
Liquid level	Tank penetration fitting
Pressure	Root valve of pressure instrument piping
Gage column (MIL-I-20037)	Isolation valve
 - (i) Propulsion shafts for submarines.
 - (j) Through hull operating shafts for submarines.
 - (k) Fasteners and plugs for the components listed in paragraph 6.3.1.4.b.(9) of this chapter, and LI systems as defined in paragraph 6.3.1.3 of this chapter, which satisfy the above description of a LI pressure boundary part.

- b. Exclusions. Items and components specifically excluded from the classification of LI are:
 - (1) Packing gland assemblies located in the systems and their components identified in paragraph 6.3.1.3 of this chapter and stuffing boxes. This includes their associated flanges, fasteners, followers, and retainers.
 - (2) Pressure seal rings, gaskets, O-Rings, packing and similar sealing members used in conjunction with joining two pressure boundary parts.
 - (3) Silver braze flux.

- (4) Flexible hoses and RISIC rubber elements.
- (5) Gages, gage valves, pressure indicators, measuring instruments, and their associated piping installed downstream of root valves in instrumentation piping or that which does not form a part of the pressure boundary.
- (6) Pipes, fittings, mufflers and Quiet Pressure Release Devices for the high pressure air system etc., continuously open to ambient conditions and only transiently subjected to pressures in excess of paragraph 6.3.1.3 of this chapter criteria (e.g., open-ended ballast tank piping outboard of the pressure hull penetration, open-ended vents and drains).
- (7) Valve yokes and bonnet retainers restrained by the body inside diameter that do not directly form the pressure boundary, but retain parts that do form the pressure boundary, unless otherwise specified.
- (8) Items not permanently installed (portable) and designated only for dockside use.
- (9) Pumps, distilling plants, compressors, heat exchangers, oxygen generators, steam turbines, condensers, hydraulic accumulators and dehydrators.
- (10) Washers.
- (11) Valve stem retaining nuts that do not come in direct contact with system fluid and serve no other function than to retain the stem.
- (12) Valve seat retainers and other internal parts that are totally enclosed within the pressure boundary except for those parts described in paragraph 6.3.1.4.a.(6)(e) of this chapter.
- (13) Non consumable weld backing rings.
- (14) Piping system sleeves.

6.3.2 Quality Assurance List (Submarines only). Quality Assurance Lists (QAL) on NAVSEA drawings specify Nondestructive Test (NDT) requirements for items scheduled for installation within the SUBSAFE boundary during new construction. The QALs should only be utilized for guidance subsequent to ship's commissioning, since they will not necessarily reflect current NDT requirements.

6.3.3 Controlled Material Procurement. This section provides general guidance for procurement of controlled material. It should be noted that NAVSEA and Naval Inventory Control Point (NAVICP) have adequate programs in place for procurement of controlled material for non-nuclear applications. Therefore, ships and repair activities should always obtain controlled material from the Navy stock system. This section also provides:

- a. Background regarding NAVSEA and NAVICP controlled material procurement programs.
- b. Summary of or reference to the NAVSEA and NAVICP requirements for controlled material procurement.

6.3.3.1 General Requirements.

- a. The LI material procurement program procures and certifies materials that are generally identified in the supply system by SMIC SB, LI, C1, D1, S1, etc. Stock system or installed items that fall under the SUBSAFE category are generally restricted to castings and fasteners. Stock system or installed items that fall under the LI category are generally restricted to metallic pressure boundary parts and components.
- b. The SFCC material procurement program procures and certifies materials that are identified in the supply system by SMIC VU and SW. Stock system or installed items that fall under SFCC are generally electronic circuit cards with embedded software.
- c. LI stock program material pass from the manufacturers into the Navy supply system by way of Navy receipt inspection activities, which examine the material and subject it to a number of tests. LI material which meets acceptance criteria is marked with a permanent MIC code as required by reference (a). Not all material within the SUBSAFE boundary supplied by the shipyard during new construction is

required to be marked. SUBSAFE castings receive a permanent LI marking. The MIC markings are in addition to the required manufacturer's marking, which need not be maintained after the MIC marking is added, except in the case of non-nuclear fasteners.

NOTE: PER REFERENCE (1), ANY LI STOCK SYSTEM SUPPLIED ITEMS WITH LI 1990 OR LATER MIC ARE ACCEPTABLE FOR USE WITHIN THE SUBSAFE CERTIFICATION BOUNDARY WHEN THE APL OR DRAWINGS INDICATE LI SMIC MATERIAL IS REQUIRED. SS SMIC CODED ITEMS CURRENTLY IN STOCK MAY BE USED IN SUBSAFE APPLICATIONS WITHOUT FORMAL DOWNGRADING.

6.3.3.2 Controlled Material Procurement.

- a. Material Procurement. Requisitioning of LI/SFCC controlled material is done in accordance with standard supply instructions. Determination of the systems that require the use of LI/SFCC material is addressed in paragraph 6.3.1 of this chapter.
- b. Stock System LI/SFCC Material. Stock system LI/SFCC materials will be requisitioned in accordance with normal supply department procedures ensuring that the SMIC is identified, if assigned to the item.
- c. (Submarines only) Submarine Antenna Engineering Directorate (SAED)-Submarine Antenna Quality Assured Material (SAQAM) LI Material. SAED-SAQAM LI material will be requisitioned in accordance with normal supply procedures with the additional guidance from references (n), (o) and (p). The supply and QA standards are discussed in references (p) and (q).
- d. Other Controlled Material. Material procured for structural repairs, modifications or fabrication will be compatible with existing structure as specified in applicable plans and MIL-STDs.
- e. LI material to be procured outside the supply system.
 - (1) Requisitions for non-nuclear LI stock program material shall be prepared according to reference (q) and other applicable NAVSUP documents.
 - (2) Reference (q) states in part:
 - (a) "Local purchases or manufacture of non-nuclear LI Stock Program stock numbered material, not available from the supply system, will be reported to NAVICP for demand recording purposes. The local purchase/manufacture action will be reported via a Demand Only Transaction (DOC ID DHA) in accordance with the procedures established in NAVSUP 437. A DHA will not be submitted when the original requisition was submitted with advice code 2C or 5C since NAVICP records demand for 2C/5C requisitions returned for local action."

NOTE: THERE ARE NO LI STOCK PROGRAM ITEMS THAT ARE CODED FOR LOCAL PURCHASE.

- (b) "Local purchases or manufacture of LI Stock Program non-stock numbered material will be reported to NAVICP to record demand and usage to determine whether the item should be stock numbered. The local purchase/manufacture action will be reported via a Report of Local Purchase for Non-stock Numbered Items (DOC ID BHJ) in accordance with the procedures established in NAVSUP 437. A BHJ will not be submitted when the requisition for a non-stock numbered item is submitted to a stock point or to NAVICP for supply action."
- (3) Procurement of non-nuclear LI material from other than the Navy stock system is not permitted except in emergent situations as discussed in Section 3 of reference (a). Such procurement will be through NAVICP Mechanicsburg only. Requisitions to NAVICP will include all of the information listed below:
 - (a) If material certification requirements of reference (a) call for destructive tests, enough material must be procured in the lot for performance of such testing.
 - (b) Complete specifications must be provided for all LI material requisitions for non-Navy stock system material. These specifications must include:
 - 1 Marking requirements, if applicable.

- 2 Material designation.
 - 3 Military and/or federal specifications, that must be met (e.g., ultrasonic testing inspection of a fitting).
 - 4 Grade, class, type, form and manufacturing process (e.g., plate, class B, Type I, hot forged).
 - 5 American Society for Testing and Materials, American Iron and Steel Institute, Society of Automotive Engineers (whether item is procured in whole or in part).
 - 6 Request for a certification of compliance or detailed analysis if required.
 - 7 All ordering data required by applicable military/federal specifications and/or industry standards/specifications shall be provided in the requisition.
- (c) Descriptive language on all documents will be clear and detailed so that no choice is left, either to the vendor or the activity concerned, as to what material is to be furnished.
- (d) The vendor will also be required to provide the following documentation with the material, to enable the material to be certified for “Level” application.
- 1 Chemical: Quantitative analysis for principal constituent elements according to reference (a).
 - 2 Physical: Mechanical properties (e.g., yield strength, tensile strength, elongation or hardness testing) as specified in reference (a).
 - 3 Fabrication: Documented compliance with fabrication procedures including NDT (e.g., seamless tubing).

6.3.4 Receipt Inspection of Controlled Material. This section provides the guidance and procedures for forces afloat and FMAs to conduct and document receipt inspections to certify controlled material as acceptable for installation.

6.3.4.1 General Requirements. Once the material ordered for use in SUBSAFE and LI systems is received, the material must be receipt inspected in accordance with reference (a). Once the material ordered for use within the submarine Fly-By-Wire Ship Control System Certification Boundary is received, the material must be receipt inspected in accordance with reference (k). Receipt inspection of these materials is required to establish positively that the material is the correct material for the job.

NOTE: THE TECHNICAL INSPECTION REQUIREMENTS OF THE APPLICABLE TECHNICAL MANUAL, DRAWING OR OTHER TECHNICAL REFERENCE AND PIPING SYSTEM MATERIAL REQUIREMENTS (E.G., CLEANLINESS, DIMENSIONS, SURFACE FINISH) ARE THE RESPONSIBILITY OF THE END-USER (WORK CENTER SUPERVISOR/ CRAFTSMAN) TO ACCOMPLISH PRIOR TO INSTALLATION AND ARE NOT PART OF THE RECEIPT INSPECTION OF THIS MANUAL.

- a. Reference (a) provides the controls and certain testing requirements that are levied by NAVSEA to cover the material from fabrication to final installation for LI material. Reference (k) provides the controls and certain testing requirements that are levied by NAVSEA to cover the material from certification to final installation for SFCCs.
- b. For LI and SFCC material, the unique requirement for “traceability” is invoked, meaning that a marking system is employed which links the material to OQE. OQE for the material is the quantitative and qualitative data proving that the material conforms to specified requirements. To meet the requirements for traceability, the following requirements are instituted:
 - (1) Receipt inspection of the material.
 - (2) Use of QA tags in association with the item(s).
 - (3) Segregated stowage for LI/SFCC stock program material, and controlled material.

- (4) Custody by CMPO/CMHs, QAIs or qualified craftsman.
- (5) Use of material verification procedures, as required by reference (a), during installation of the material.

6.3.4.2 Quality Assurance Forms for Receipt Inspections. The QA forms necessary to complete and document receipt inspections (QA form 1 and QA form 2) are addressed in paragraphs 6.3.4.5.q and 6.3.5 of this chapter.

6.3.4.3 Receipt Inspection and Certification of Valve Balls. New stock system LI balls are certified for use prior to placing a "LI" SMIC on them. Refurbished teflon coated valve balls also are certified for use according to the indicated SMIC ("LI", "Q3" or "QA").

- a. Balls received with a SMIC code "LI" are acceptable for use in SUBSAFE or LI system applications as specified by the applicable APL or drawing without further tests prior to installation.
- b. Balls received with a SMIC code "QA" or "Q3" are acceptable for use in SUBSAFE or LI system applications unless required to be LI in accordance with paragraph 6.3.1.4.a.(6)(e) of this chapter.
- c. Balls received with a SMIC code "QA" or "Q3" may be certified as acceptable for use in SUBSAFE or LI system applications defined in paragraph 6.3.1.4.a.(6)(e) of this chapter by either:
 - (1) Request certification papers from NAVICP code 8452 based on the heat and lot data etched in the fluid flow path of the ball, if available, and based on the certification papers and satisfactory receipt inspection locally assign a MIC number or
 - (2) If certification papers are not available or heat and lot data is not present in fluid flowpath, conduct a generic material identity test, hardness test, perform applicable NDT and obtain TYCOM approval of a major Departure from Specification (DFS) in accordance with Part I, Chapter 8 of this volume.
- d. Balls certified as acceptable for use in accordance with paragraph 6.3.4.3.c of this chapter shall be marked with a locally assigned MIC marking in the fluid flow path of the ball in accordance with paragraph 6.3.7.1 of this chapter, providing traceability to applicable certification papers, test documentation, and approved DFS.

6.3.4.4 Level I and Submarine Flight Critical Component Receipt Inspection. The receipt inspection requirements for LI material from reference (a) are provided in paragraph 6.3.4.5 of this chapter and will be used for the receipt inspection of SUBSAFE and LI material. The receipt inspection requirements for SFCC material from reference (k) are provided in paragraph 6.3.4.5 of this chapter and will be used for the receipt inspection of SFCC material.

6.3.4.5 General Requirements for Level I and Submarine Flight Critical Component Material.

- a. Traceability for LI, and SAED-SAQAM material is to be maintained from the material back to its certification records. Material losing its identity will be considered unsuitable for use until identification can be positively re-established. It will be segregated from other controlled material, tagged and handled as rejected material. Traceability for SFCCs having a SMIC code of (VU) or (SW) is to be maintained from the material back to its certification records. Material losing its identity will be considered unsuitable for use until identification can be positively re-established. It will be segregated from other controlled material, tagged and handled as rejected material. Upon determination that the SFCC is nonconforming and unusable for Fly-By-Wire Ship Control Systems (FBW SCS) Flight Critical applications, the SFCC shall be clearly identified as rejected and the SMIC marking shall be removed or obliterated.
- b. Supply departments of Fleet activities will perform the basic receipt inspection required by the appropriate NAVSEA, NAVICP, and/or NAVSUP instruction prior to placing the material into stock inventory. QA forms of this manual are not required to be completed and/or placed on the material by supply department personnel.

NOTE: LI/SFCC STOCK PROGRAM MATERIAL BECOMES CONTROLLED MATERIAL, FOR THE PURPOSES OF THIS MANUAL, WHEN THE MATERIAL HAS BEEN RECEIVED BY THE CMPO OF THE WORK CENTER OR DIVISION.

- c. Material identification must remain on or with the material throughout all stages of stowage, fabrication and installation. SFCC Certification OQE shall be kept with the SFCC until the part is installed in the system.
- d. Material awaiting or undergoing receipt inspection will be segregated from accepted material.
- e. Material which met specifications at the time of procurement, but cannot be used in the system for which it was procured because of a change in requirements occurring after submission of material requests, will be returned to the supply department with a QA form 3.
- f. LI. Material NAVICP procured for the LI Stock Program which meets the required SUBSAFE attributes will be inscribed with a MIC number which provides traceability back to the certification documents or certifying activity.

NOTE: NON-LI STOCK PROGRAM MATERIAL WILL NOT BE MARKED WITH A LI SMIC.

- g. (Submarines only) SAED-SAQAM Material with a "LI" SMIC. A "Certification Statement" required by reference (o) must accompany the material unless the material is certified and marked by an NAVICP certifying activity, and is received from the LI stock program.
 - (1) Submarine Periscope/Antenna SUBSAFE parts received after 31 July 1979 will be marked in accordance with reference (a).
 - (2) SUBSAFE Periscope/Antenna parts received prior to 31 July 1979 were marked "Ser 1991-921A <SS>" by Portsmouth Naval Shipyard or "Ser 1991-921A-061 <SS>" by Naval Surface Warfare Center, Carderock Division (Submarine Antenna Engineering Directorate).
 - (3) Parts not marked in accordance with paragraph 6.3.4.5.g.(1) of this chapter may be used providing the certification can be positively traced to certification records via certificate of conformance which records a traceable number on the material as recorded on the certificate of conformance. If certification records can not be located, then an approved major DFS in accordance with Part I, Chapter 8 of this volume is required if the part must be used in lieu of a certified part.
- h. Transfer of LI and SFCC Material Between Activities. Material which is procured or manufactured and certified by an authorized certifying activity and which is then transferred to another activity may be accepted for use by the receiving activity after satisfactory receipt inspection in accordance with paragraph 6.3.4.5.q of this chapter.
- i. Non-Standard Stock Certification Documentation. Material procured from non-government sources or shipped direct from the manufacturer and not certified by the LI stock program must be receipt inspected in accordance with paragraph 6.3.5.1 of this chapter.
- j. Accepted Material. Each acceptable unit of issue (e.g., valve, fitting, can of welding rod) will have a Material Identification/Control Tag (QA form 2) attached.
- k. New Construction. The acceptable certification for LI and SFCC material provided to new construction ships by shipbuilders as on board repair parts consists of a written statement from the cognizant Supervising Authority. The letter will certify that the material is acceptable and has been proven by a sampling audit. The letter will also list the certified material furnished. A copy of this letter will be kept by the ship as a permanent record. After receipt of the initial letter during new construction and delivery of the ship, additional material will not be accepted without a letter being provided with or prior to receipt of the items. SUBSAFE, LI and SFCC on board repair parts, received with Certificates of Conformances after the start of Fast Cruise, do not require additional certification letters from the Supervising Authority.
- l. Package Alteration Kits. Package alteration kits should not normally be opened until the ship/FMA is ready to proceed with the installation, provided that a certification of the contents and a copy of the installation instructions are in the envelope on the outside of the box. When the ship/FMA is ready to proceed with the installation, the lead work center CMPO will open the kit and perform the receipt inspection.

- m. Installed material or upgraded existing material on a ship originally built or upgraded to SUBSAFE/LI standards involved in a repair will be assumed acceptable.

CAUTION: MATERIAL REMOVED FROM A SHIP UNDERGOING INACTIVATION CANNOT BE REINSTALLED IN A LI APPLICATION WITHOUT FOLLOWING THE GUIDELINES IN REFERENCE (a).

- n. Reuse of Previously Certified LI/SFCC Material. Material removed from a ship originally built or upgraded to LI or SFCC certified, which is subsequently installed in another ship, will be assumed acceptable provided control (traceability) is available in FMA or ship records proving the item was removed from a ship built or upgraded to LI or SFCC certified and verification of the following:
 - (1) The level of certification of the system in the ship from which the part was removed is the same as the level of certification required for end use.
 - (2) DFS log (for the ship from which the material is removed) does not identify any outstanding DFS against the item that would preclude end use. Copies of outstanding DFS must be provided with the material. Those outstanding DFS for the material on the supplying ship will be cleared and the receiving ship will process new DFS on board in accordance with Part I, Chapter 8 of this volume.
 - (3) The files of DFS approved as permanent repairs (for the ship from which the material was removed) have been reviewed and copies of applicable DFS provided with the material.
 - (4) Ship's plans (for the ship from which the material was removed) do not identify any drawing differences from the ship's plans for the ship onto which the material will be installed.
 - (5) End use installation is consistent with the previous service parameters such as the design pressure rating, design temperature rating, or system applicability of the component.

CAUTION: MATERIAL REMOVED FROM A SHIP UNDERGOING INACTIVATION CANNOT BE REINSTALLED IN A SUBSAFE APPLICATION WITHOUT FOLLOWING THE GUIDELINES IN REFERENCE (I).

- o. Reuse of Previously Certified SUBSAFE Material. (For commissioned ships only) Material removed from a ship originally built or upgraded to SUBSAFE, which is subsequently installed in another ship, will be acceptable under the following conditions:
 - (1) A Maintenance Certification Record/Re-Entry Control is used to document removal from the supplying ship. The supplying ship must be SUBSAFE certified and re-entry control must be in effect.
 - (2) All DFS (active and those accepted as permanent repairs that are not yet reflected in ship's selected record drawings/data or technical variance documentation), applicable technical variance documentation, the last accomplishment date and category of all applicable Unrestricted Operation (URO) Maintenance Requirement Card (MRC) inspections, and all legible component markings will be documented and supplied to the receiving activity along with a copy of the supplying ship's Maintenance Certification Record/Re-Entry Control. This documentation will be maintained and filed with the SUBSAFE Controlled Work Package that installed the component on the receiving ship. Those outstanding DFS for the material on the supplying ship will be cleared and the receiving ship will process a new DFS on board in accordance with Part I, Chapter 8 of this volume.
 - (3) The receiving activity will conduct material inspection to verify the following conditions:
 - (a) Received component came from a ship that has been previously SUBSAFE certified and for which Re-Entry Control has been maintained since initial certification.
 - (b) Material marking on hardware matches material marking on supporting documentation.
 - (c) Applicable URO MRC inspections are current for the intended end use.

- (d) End use installation is consistent with the previous service parameters such as the design pressure rating, design temperature rating, or system applicability of the component.
- (4) Receiving activity will update applicable technical data to document information and records provided by paragraph 6.3.4.5.o.(2) of this chapter (e.g., ship's drawing index for drawing revision, date of last URO MRC periodicity accomplishment, and documentation of outstanding DFS) into ship's Current Ship's Maintenance Project and other records.
- (5) Material which does not meet the requirements of paragraph 6.3.4.5.o.(3) of this chapter will be acceptable for use under the following conditions:
 - (a) For material which does not meet the requirements of paragraph 6.3.4.5.o.(3)(c) of this chapter, the material will be subjected to and comply with the applicable URO MRC inspections required for the receiving ship's end use application.
 - (b) For material which does not meet the requirements of paragraph 6.3.4.5.o.(3)(d) of this chapter, the material will be subjected to and satisfy the pressure and operability tests that would be required for a new component installed in the receiving ship, provided the design rating is consistent with the intended end use.
- p. Reuse of material in the previously certified SUBSAFE work control boundary from a ship whose SUBSAFE certification has lapsed by virtue of inactivation availability commencement, shall be in accordance with reference (l).
- q. Material received from Navy stock system. LI/SFCC material received from the Navy supply system will be receipt inspected by the CMPO as follows:

<u>Procedure</u>	<u>Responsibility</u>
Visually inspect the material.	CMPO/CMH
Check that quantity received is same quantity ordered.	CMPO/CMH
Check for completeness (i.e., are all parts of a component present); disassembly is not required or desired.	CMPO/CMH
Verify item has MIC number and MIC number is correct in accordance with paragraph 6.3.7 of this chapter (not applicable to SFCC).	CMPO/CMH
For Fasteners: Document the markings from the fastener to include either: <ul style="list-style-type: none"> (1) The color code and the heat/lot number, material type and manufacturer's symbol (for nuts containing a self-locking insert, the color of the insert is the manufacturer's symbol). (2) The MIC number (when MIC number is on the fastener or on the individual tag for some small fasteners). 	CPO/CMH
For Flight Critical Components, verify that the SFCC certifying activity identified on the accompanying OQE is traceable to one of the NAVSEA approved activities listed in paragraph 2.4.1 of reference (k).	CMPO/CMH
For Flight Critical Components, ensure applicable SMIC marking is listed on supply documentation/component.	CMPO/CMH

NOTE: MORE THAN ONE MIC NUMBER MAY BE ON A COMPONENT (E.G., VALVE BODY MAY HAVE ONE MIC NUMBER AND THE BONNET MAY HAVE ANOTHER MIC NUMBER). IF THE COMPONENT HAS A SHORTENED MIC MARKING, ENSURE THE FULL MIC MARKING IS AVAILABLE ON THE SHIPPING DOCUMENTS, TAGS, AND/OR PACKAGING. VERIFY THAT THE SHORTENED MIC MARKING IS CORRECT IN ACCORDANCE WITH PARAGRAPH 6.3.7 OF THIS CHAPTER AND REFERENCE (a).

For LI material, verify MIC number including proper “LI” markings. CMPO/CMH

Check that the MIC number is traceable to a NAVSEA authorized certifying activity, (e.g., Is there an “A” for Portsmouth Naval Shipyard?). See paragraph 6.3.6 of this chapter for list of authorized certifying activities and paragraph 6.3.7.2 of this chapter for additional guidance on MIC marking. CMPO/CMH

Check NSN on part and verify that it is the NSN ordered. CMPO/CMH

For oxygen clean material verify that the package is sealed and marked with a certified oxygen clean tag. CMPO/Cleanliness Inspector/CMH

Fill out QA form 1 and attach the shipping papers, if provided. CMPO/CMH

NOTE: QA FORM 1 IS NOT REQUIRED FOR SHIP’S FORCE WHEN PERFORMING RECEIPT INSPECTION OF MATERIAL TO BE IMMEDIATELY INSTALLED FOR A SPECIFIC JOB. IF ALL MATERIAL IS NOT UTILIZED IN THE ONGOING JOB, QA FORM 1 MUST BE FILLED OUT PRIOR TO PLACING THE MATERIAL IN A STOWAGE LOCKER/AREA.

NOTE: IF THE COMPONENT HAS A SHORTENED MIC MARKING, ENSURE THE FULL MIC MARKING FROM THE SHIPPING DOCUMENTS, TAGS, AND/OR PACKAGING IS ENTERED ON QA FORM 1 AND QA FORM 2.

<u>Procedure</u>	<u>Responsibility</u>
------------------	-----------------------

Fill out and attach QA form 2 to each unit of issue accepted.	CMPO/CMH
---	----------

If material fails any of above steps reject and attach QA form 3.	CMPO/CMH
---	----------

Verify that the item is what is required for intended use and turn the material over to craftsman for fabrication and/or installation or stow in a controlled material storage area.	CMPO/CMH
--	----------

Forward QA form 1 to the QA office when the material has been issued for installation.	CMPO/CMH
--	----------

NOTE: LI MATERIAL RECEIVED FROM THE NAVY SUPPLY SYSTEM WITH PROPER MATERIAL MARKINGS DO NOT REQUIRE “H” PRESSURE TESTING AFTER RECEIPT INSPECTION.

- r. FBW Diagnostic and Maintenance Computers (DMAC) will be receipt inspected in accordance with sub-paragraph q. of this paragraph. The following are unique requirements specific to the DMAC:
 - (1) A QA form 1 will be used to document the DMAC receipt inspection.
 - (2) A QA form 2 is not required for the DMAC during or after receipt inspection.
 - (3) A QA form 3 is required for a DMAC that fails receipt inspection or is out of commission.

- (4) The QA form 1 shall be completed in accordance with the QA form 1 instructions in Part 1 Chapter 11 of this volume. The QA form 1 shall be retained in the ship Re-Entry Control exception folder until superseded by a new DMAC receipt inspection.
- s. SFCCs may be downgraded for use in non-SFCC, however, the component shall not be subsequently reinstalled into any SFCC application if it was ever installed in a non-SFCC application. The SMIC markings on the SFCC shall be obliterated and the certification records for the item annotated to indicate the item is no longer a certified SFCC prior to being installed.

6.3.5 Receipt Inspection of Open Purchase (Non-Supply System) or Locally Manufactured Material or Upgrading Supply System Material to Level I (Fleet Maintenance Activity only).

6.3.5.1 Uncertified Material Required for Level I Applications. For uncertified material required for use in a LI application, the item must comply with the requirements of reference (a). Fleet activities shall not certify open purchase (non-supply system/no NSN) materials to LI requirements without specific authorization from TYCOM/NAVSEA. Additionally, unless authorized in advance, a major DFS in accordance with Part I, Chapter 8 of this volume must be processed.

- a. Uncertified material (supply system/NSN assigned) received or used as a starting material for a manufactured part for LI requirements must be receipt inspected in accordance with reference (a) by a certifying activity (e.g., shipyard, FMA).
- b. Upon completion of the requirements of reference (a) the following procedure will be used:

<u>Procedure</u>	<u>Responsibility</u>
Review vendor data (if provided with material), MIL-STD, and/or FMA manufacturing and test data to ensure that it all matches. See note at end of this table regarding vendor data.	FMA QAO
Place certifying FMA MIC markings on the item.	FMA CMPO/CMH/QAI
Fasteners will be appropriately marked and color coded if required.	FMA CMPO/CMH/QAI
Fill out QA form 1 to document the receipt inspection.	FMA CMPO/CMH/QAI
File QA form 1 with all applicable documents.	FMA Quality Assurance Supervisor
Verify that the item is what is required for intended use and turn the material over to craftsman for fabrication and/or installation or stow in a controlled material storage area.	FMA CMPO/CMH/QAI
Forward QA form 1 to QA Office when the material has been issued for installation.	CMPO/CMH

NOTE: VENDOR DATA - MATERIAL RECEIVED DIRECTLY FROM THE MANUFACTURER REQUIRES THE FOLLOWING CERTIFICATION DOCUMENTATION AS A MINIMUM:

- (1) CHEMICAL: QUANTITATIVE ANALYSIS FOR PRINCIPAL CONSTITUENT ELEMENTS IN ACCORDANCE WITH REFERENCE (a).
- (2) PHYSICAL: MECHANICAL PROPERTIES (YIELD STRENGTH, TENSILE STRENGTH, ELONGATION OR HARDNESS TESTING) AS SPECIFIED IN REFERENCE (a).
- (3) FABRICATION: DOCUMENTED COMPLIANCE WITH FABRICATION PROCEDURES INCLUDING NDT (E.G., SEAMLESS CONDITION OF TUBING).

- c. If all testing required by reference (a) cannot be accomplished, then, as a minimum, a generic materials identity test, hardness test, and visual inspection will be accomplished and a major DFS must be processed in accordance with Part I, Chapter 8 of this volume.

6.3.5.2 Uncertified Material Required for SUBSAFE Applications. For uncertified material required for use in a SUBSAFE application and requiring an “LI” certification, the item must first comply with the requirements for LI discussed above and the requirements of reference (l). Fleet activities shall not certify non-level materials to SUBSAFE requirements without specific authorization from TYCOM/NAVSEA and, unless authorized in advance, a major DFS in accordance with Part I, Chapter 8 of this volume must be processed.

6.3.5.3 Uncertified Material Required for Submarine Flight Critical Component Applications. Fleet activities shall not install non-certified SFCC materials within the SFCC boundary without specific authorization from TYCOM/NAVSEA and, unless authorized in advance, a major DFS in accordance with Part I, Chapter 8 of this volume must be processed.

- a. Upon completion of the requirements of reference (k) the following procedure will be used:

<u>Procedure</u>	<u>Responsibility</u>
Fill out QA form 1 to document the receipt inspection	FMA CMPO/CMH/QAI
NOTE: QA FORM 1 IS NOT REQUIRED FOR SHIP’S FORCE WHEN PERFORMING RECEIPT INSPECTION OF MATERIALS TO BE IMMEDIATELY INSTALLED FOR A SPECIFIC JOB. IF ALL MATERIAL IS NOT UTILIZED IN THE ONGOING JOB, QA FORM 1 MUST BE FILLED OUT PRIOR TO PLACING MATERIALS IN A STORAGE LOCKER/AREA.	
File QA form 1 with all applicable documents	FMA Quality Assurance Supervisor
Verify that the item is what is required for intended use and turn the material over to craftsman for installation or stow in a controlled material storage area.	FMA CMPO/CMH/QAI
Forward QA form 1 to QA Office when the material has been issued for installation.	CMPO/CMH

6.3.6 Authorized Material Certification Activities. This section provides a list of those activities that are currently authorized or have been authorized previously to receipt inspect and accept LI and SFCC controlled materials. This list is provided as a reference to be used in performance of receipt inspections of paragraph 6.3.4 of this chapter.

6.3.6.1 Currently or Previously Authorized Material Certification Activities.

- a. For material ordered from NAVICP by forces afloat for SUBSAFE/LI applications. The following activities are authorized to receipt inspect and stock material for the LI Stock Program:

<u>Activity</u>	<u>Identification Code</u>
Portsmouth Naval Shipyard	A
Naval Weapons Station Yorktown	YT

- b. If material is not available through the activities listed in paragraph 6.3.6.1.a. of this chapter, NAVSEA has authorized the following activities to certify material as LI in accordance with reference (a) and this material may be used for SUBSAFE applications without further receipt inspection, other than normal receipt inspection of paragraph 6.3.4.5.q. of this chapter. The activities and their designator are:

<u>Activity</u>	<u>Identification Code</u>
Newport News Shipbuilding	NN
Naval Undersea Warfare Systems Center - Newport (NUWC)	NUSC
Norfolk Naval Shipyard	N
Charleston Naval Shipyard	C
Puget Sound Naval Shipyard	S
Pearl Harbor Naval Shipyard	P

- c. Listed below are some of the LI activity designators assigned by NAVSEA to various activities.

<u>Activity</u>	<u>Identification Code</u>
<u>Naval Shipyard</u>	
Charleston	C
Long Beach	L
Mare Island	MS
Norfolk	N
Pearl Harbor	P
Philadelphia	H
Portsmouth	A
Puget Sound	S

Supervisor of Shipbuilding

Groton	SSG
--------	-----

<u>Activity</u>	<u>Identification Code</u>
<u>Naval Weapons Station</u>	
Naval Surface Warfare Center Division, Crane	WQC
Naval Surface Warfare Center Ordnance Station, Louisville	NSL
Naval Weapons Station, Yorktown	YT
<u>Other NAVSEA Activities</u>	
Other	JCR
SRF, Guam	SRFG
SRF, Yokosuka	SRFY
Naval Undersea Warfare Center Detachment, New London	NUWC
Naval Inventory Control Point (formerly Navy Ships Parts Control Center)	X
Naval Submarine Support Facility, NLON Submarine Base, Pearl Harbor	SFNL SBPH

<u>Activity</u>	<u>Identification Code</u>
TRIDENT Refit Facility, Kings Bay	TRFK
TRIDENT Refit Facility, Bangor	TRFB
SIMAs/Tenders	AS-32, 33, 34, 36, 37, 39, 40, 41, etc.

- d. For Submarine Flight Critical Components, see reference (k) for the activities authorized for testing and certification.

6.3.7 Marking of Level I Stock Program Material and Controlled Material.

6.3.7.1 General Requirements. LI Stock Program Material passes from the manufacturers into the Navy supply system by way of Navy receipt inspection activities, which examine the material and subject it to a number of tests. LI material which meets acceptance criteria is marked with a permanent MIC number. SUBSAFE material supplied by the shipyard as onboard repair parts during new construction is required to be MIC marked. On older ships, the SUBSAFE material supplied as onboard repair parts during new construction may not have been MIC marked, but will be listed on the Supervisor of Shipbuilding's letter of certified material.

- a. The purpose of MIC marking is four-fold:
 - (1) To denote that the marked material has been inspected, verified and accepted.
 - (2) To verify the material in hand by comparing it to the applicable drawings, plans, ordering requirements, and installing documents.
 - (3) To provide traceability from the installed material to OQE.
 - (4) To preclude complete re-inspection of material accepted by an approved activity.
- b. Two problems arise in application that can defeat the purpose of the MIC marking:
 - (1) Internal components of an assembly which is MIC marked on the exterior, are usually not marked individually, and can lose their identity as LI material, if separated during disassembly. Strict adherence to "bag and tag" requirements, using fleet QA forms, overcomes this problem. Any part that becomes separated from its QA form (a loss of traceability) must be treated as uncontrolled material.
 - (2) Reference (a) permits the use of shortened MIC numbers in cases where the entire marking cannot be applied due to space limitations. It is possible that some LI material will lack the traceability number providing the critical link to the OQE, which in turn serves as the basis for the designation "LI material or controlled material". This problem is circumvented by a tag affixed by the receipt inspection activity directly to the material or to its container, which lists the complete MIC number. The complete MIC marking is recorded during receipt inspection. Although the complete MIC marking would not be visible once the item was installed, traceability is maintained through the retained QA paperwork and tags associated with the job, which will list the full MIC number.
- c. SUBSAFE castings and aluminum bronze components receive a permanent LI marking.
- d. The MIC and SUBSAFE markings are in addition to the required manufacturer's marking.
- e. Altering of a MIC marking is prohibited except to make documented corrections.
- f. Method of marking controlled material. Physical marking methods are described in references (a) and (j).
- g. Items not physically capable of being marked. Items such as small parts are packaged in homogeneous lots (i.e., same heat, batch or melt; and same vendor traceability) and the package is marked. If the package is opened, the individual items removed must be tagged with QA form 2. The remaining items in the package will be controlled by the use of a single QA form 2 attached to the package.

6.3.7.2 Level I Material. LI material has a MIC marking affixed to it by the activities which certify the material for the Navy supply system. The activities are listed in paragraph 6.3.6 of this chapter. Authorized FMAs may apply a MIC marking to a component prior to installation in a ship. MIC markings will be applied in accordance with reference (a). The following paragraphs provide general guidance regarding MIC marks and marking:

- a. Elements of the MIC Marking. The normal MIC marking consists of three elements:
 - (1) Material designator. The material designation comes from Volume II of reference (a) with the two or three letter code (e.g., KMA).

NOTE: MIC MARKINGS ON OLDER STOCK PIPING MATERIAL, VALVES, FITTINGS, ETC., RECEIVED FROM THE SUPPLY SYSTEM MAY CONTAIN FOUR LETTER MATERIAL DESIGNATORS. FOUR LETTER MIC MARKING MATERIAL DEFINITIONS ARE CONTAINED IN VOLUME II OF REFERENCE (a).

- (2) Traceability number. The traceability number is used by the marking activity to relate the piece to inspection records and consists of the last two digits of the year, Julian date when the material was inspected, a hyphen and lot number (e.g., 89364-043).
 - (3) Certifying Activity Designator (CAD). The CAD denotes the activity that performed the certification testing and marking. The CAD indicates acceptance of the material. Only the government activities and private shipyards which are authorized by NAVSEA to certify inspect and mark LI material are assigned CADs. NAVSEA periodically issues a letter containing the list and identity code of government activities and private shipyards authorized to certify LI material. A listing of those activities authorized to certify LI material is provided in paragraph 6.3.6 of this chapter.
- b. If all the markings cannot be affixed because of space limitations, then they are affixed in accordance with reference (a).
- c. Sample MIC Markings. Three marking systems are in effect. Samples of MIC marks affixed to non-nuclear LI material from each of the marking systems follow:

- (1) CNB-91301-123 TRFB (LI material, new marking system)

CNB	91301	123	TRFB
Material code.	Julian date	Inspection	Inspection
70/30 copper	of inspection	lot number	Activity
nickel (from		(3 digits	(TRIDENT Refit
the Material		maximum)	Facility, Bangor)
Designator			
Catalog)			

- (2) KMD-90204-123 A (LI material, new marking system)

KMD	90204	123	A
Material code.	Julian date	Inspection	Inspection
K monel (from	of inspection	lot number	Activity
the Material		(3 digits	(Portsmouth
Designator		maximum)	Naval Shipyard)
Catalog)			

- (3) 7150 001 A VBA (LI material, old marking system)

7150	001	A	VBA
Julian Date	Inspection	Inspection	Material code.
of inspection	lot number	activity	Valve bronze
		(Portsmouth	alloy
		Naval Shipyard)	

- (4) 7100 005 CNB (LI material, old marking system)

7100	005	CNB
Julian date of inspection	Inspection lot number	Material code. Copper nickel alloy

- (5) SER 1991-921A LI (Marked by Portsmouth Naval Shipyard)

SER 1991-921A-061 LI (Marked by Naval Surface Warfare Center, Carderock Division (Submarine Antenna Engineering Directorate) (previously NAVSSES, Philadelphia))

- d. Examples of LI MIC marks for periscope and antenna parts marked prior to 31 July 1979:

- (1) NCD 8249-584 QQ LI

NCD	8249	584	QQ
Material code	Julian date of inspection	Inspection lot number (3 digits maximum)	Inspection Activity (Naval Surface Warfare Center, Carderock Division)
Nickel copper alloy			

- (2) SER 1991-921A-AS18

FMA marking applied to previously unmarked antenna, mast or periscope parts within the SUBSAFE boundary documented by receipt inspection record (QA form 1) as being received prior to 31 July 1979 or are parts removed from an antenna, mast or periscope from an in-service SUBSAFE certified submarine.

- (3) Fasteners are identified and color coded in accordance with Appendix C of reference (a).

6.3.7.3 Assignment of Material Identification and Control Numbers for Items Manufactured from Certified Raw Materials.

NOTE: HEADED FASTENERS (CAPSCREWS, BOLTS, MACHINE SCREWS, ETC.) MANUFACTURED FROM LI MATERIAL REQUIRE ADDITIONAL TESTING (i.e., WEDGE TENSILE OR AXIAL TENSILE TESTING AND HARDNESS TESTING).

- a. LI items manufactured using certified LI raw material (e.g., barstock, plate, forged shape) except fasteners with heads may be assigned the same MIC markings as the raw stock provided no work is done on the base material that would alter its chemical, physical or mechanical properties (machining and welding may be done).
- b. Headed fasteners will be assigned a unique MIC marking following local manufacture from existing LI material and satisfactory completion of certification testing. A DFS is required if certification testing is not completed.

NOTE: A NEW MIC MARKING SHALL BE ADDED WHENEVER LI MATERIAL IS HEAT TREATED OR WORKED IN SUCH A WAY AS TO ALTER CHEMICAL, PHYSICAL OR MECHANICAL PROPERTIES. THE NEW MIC NUMBER SHALL PROVIDE TRACEABILITY TO THE ORIGINAL MIC NUMBER AND RECERTIFICATION TEST REPORTS FOR CHEMICAL, PHYSICAL OR MECHANICAL PROPERTIES.

- c. The following procedures will be used by a FMA authorized to certify and assign MIC markings, in accordance with reference (a), to items manufactured from certified raw material that have had their chemical, physical or mechanical properties altered:
 - (1) Prepare a new QA form 1 for each new item.
 - (a) Complete Blocks 1, 2, 5, and 6 of QA form 1.
 - (b) Blocks 7 and 8 of QA form 1 will be marked "NA".

- (c) In Block 9 of QA form 1, check “no”, then print name, sign and date.
 - (d) Enter the appropriate codes for the required tests and inspections in Block 10 of QA form 1.
 - (e) Enter signed and dated statements in Block 11 of the QA form 1 that provides:
 - 1 The MIC number of the raw material and Controlled Work Package serial number used in manufacture, inspection and test of the item.
 - 2 The results of the tests and inspections designated in Block 10 of QA form 1
 - (f) Check the appropriate boxes in Blocks 12, 13 and 14, print name and sign Block 15 of QA form 1.
 - (g) If the item was found to be acceptable and certified to the appropriate Level of Essentiality, assign a new MIC number in the format shown in paragraphs 6.3.7.2.c.(1) or (2) of this chapter for non-nuclear material.
 - 1 Volume II of reference (a) should be consulted for the material designator since the fabrication processes may have altered the material.
 - 2 The date will be the date that the MIC number is assigned.
 - 3 Each item manufactured will be assigned a lot number and the appropriate test and inspection records for that item will be annotated with the lot number to ensure traceability.
- (2) Complete the new QA form 2 using the new MIC number.
- (a) Mark the certified material with the new MIC markings in accordance with paragraph 6.3.7.2 of this chapter. Block 5 of QA form 2 will be N/A.
 - (b) Remove the original QA form 2 with the raw stock MIC number. Enter a statement in the installation block that the item has been certified and the new MIC number that was assigned. The tag should then be filed with the new QA form 1.

6.3.8 Level I Submarine Flight Critical Component Stock Program Material Downgrading.

NOTE: MATERIAL CODED AS SS DOES NOT REQUIRE DOWNGRADING FOR USE IN LI APPLICATIONS.

6.3.8.1 Material Downgrading. Occasionally LI/SFCC Stock Program controlled material must be downgraded in order to support training or production work due to the non-availability of uncertified material. In order to maintain accountability of the end use of LI/SFCC Stock Program controlled material, the following procedure is required:

<u>Procedure</u>	<u>Responsibility</u>
For LI/SFCC, obtain written authorization to downgrade the material from the QAO.	Leading Petty Officer/Work Center Supervisor
Remove all MIC markings from the LI material and SMIC markings from SFCC as well as controlled material tags and forms. The QA forms will be forwarded to the QAO (ship) or QA office (FMA) with the approved authorization.	CMPO/CMH

6.3.9 Storage, Issue, and Handling of Level I/Scope of Certification/Submarine Flight Critical Component Stock Program Material.

6.3.9.1 Storage Requirements.

- a. The supply department onboard the FMA or a ship will stow, handle and issue LI/SOC/SFCC stock program material as required by the governing NAVSEA, NAVICP, or NAVSUP instruction.

NOTE: LI/SOC/SFCC STOCK PROGRAM MATERIAL BECOMES CONTROLLED MATERIAL, FOR THE PURPOSES OF THIS MANUAL, WHEN THE MATERIAL HAS BEEN RECEIVED BY THE CMPO OF THE WORK CENTER OR DIVISION.

- b. Controlled material in the custody of customers (ship or FMA work centers) will be segregated by a physical barrier, in clearly marked, dry, secure, clean stowage and handling areas.
 - (1) Use of separate boxes, shelves, roped off or marked (e.g., painted lines) areas are acceptable methods of segregation/stowage, provided they are clearly marked, allowing separation of the following materials:
 - (a) Material within the SUBSAFE boundary.
 - (b) LI.
 - (c) SFCC.
 - (d) SOC MCD-A, MCD-B and MCD-C.
 - (e) Material undergoing receipt inspection.
 - (f) Rejected materials.
 - (g) Material staged for a specific job or process. Controlled materials of different Levels of Essentiality and non-controlled material may be co-located when staging materials for a specific job as long as all identification tags attached to the material are annotated with the same Job Control Number.
 - (2) These materials must be segregated from each other and from other materials. Segregation will be maintained from receipt through staging. Unidentified material or rejected material will be segregated from acceptable controlled material. Access to controlled material will be positively controlled.
 - (3) LI materials of different material types, grades or condition shall be segregated through physical separation unless readily differentiated by other attributes, such as size or physical appearance. When physical segregation cannot be accomplished, an alternative positive system of control shall be used. The method used shall assure that different materials that appear to be similar are not mixed (unless the materials are approved alternates for each other as indicated by part or stock number).
- c. Controlled material will be handled and stored in a manner to prevent damage and be sealed for cleanliness when applicable (e.g., Oxygen Clean).
- d. Material received, or modified after receipt, not meeting the receipt inspection requirements of paragraph 6.3.4 of this chapter will be rejected, tagged with QA form 3, and placed in segregated controlled stowage to await disposition. Disposition examples:
 - (1) Disposal.
 - (2) Repair.
 - (3) Retention of components for future use.
- e. Material awaiting receipt inspection will be segregated from material accepted or material rejected.
- f. CMPOs will inspect controlled material storage areas of their work center, semi-annually as a minimum to ensure:
 - (1) Material is in designated area.
 - (2) Material is properly identified.
 - (3) Material is properly marked and tagged.

- (4) Material is protected from damage.
- (5) Material is kept clean.
- (6) Material is segregated as required.

6.3.9.2 Staging Requirements. Controlled materials of different Levels of Essentiality and non-controlled material may be co-located when staging material for a specific job provided that:

- a. All QA forms or identification tags attached to the material are annotated with the same Job Control Number.
- b. Material is segregated from material staged for other jobs or processes.

6.3.9.3 Issue of Level I/Scope of Certification/Submarine Flight Critical Component Controlled Material. LI/SOC controlled material issue will be restricted to those specific applications that have controlled material requirements. SFCC controlled material may be issued for non-Flight Critical applications without written authorization but must not be subsequently installed into components within the SFCC Certification Boundary.

6.3.9.4 Handling of Material. All controlled material received by a work center, whether received from the supply department as onboard stock, work center stores or from a tended ship must be controlled as required by reference (a) for LI, reference (b) for SOC or reference (k) for SFCC.

- a. Controlled material must at all times be in physical custody of either the work center CMPO, QAI, a craftsman or stowed in a work center controlled material stowage area.
- b. Lots of material (e.g., box of bolts) broken down for end use, will maintain the same identification and control as the parent controlled item using QA form 2 as appropriate.
- c. The QA form 2, and/or any other identification must stay with the material at all times until it is installed or reinstalled in the system or returned to the custody of Ship's Force.
- d. Transfer of a MIC marking during issue of barstock or pipe will be accomplished by transferring the MIC to a new location on the piece to be sectioned, and be verified by the work center CMPO/CMH or a QAI before the original marking is lost.
- e. If, during fabrication, the original piece must be broken down (such as cutting off a piece of barstock) or the MIC marking will be lost by machining, welding, etc., the proper material identification markings will be transferred to the piece(s) prior to cutting or to the container, in case of small parts, and QA form 2 will be attached to each new piece.
- f. On completion of shop/ship fabrication or assembly stage, the QAI will check the finished product against the attached material identification tags for required material markings. The QAI will inspect the finished product for conformance to specifications. If satisfactory and if the required marking is present the QAI will print name and sign the QA form 2.
- g. If for any reason at any time the product fails inspection, the QAI will reject the material, attach QA form 3 and inform the QAO.
- h. The lead work center will be responsible for installation and the final acceptance block on all QA forms associated with a particular product. Assist work centers or divisions will be responsible for control of material that they use on a job.
- i. Material consumed (e.g., welding electrode, brazing alloy) or installed (e.g., studs, valve ball) in the repair process must have its identity (MIC number, type or grade of the material) recorded on the appropriate QA form (e.g., QA form 18, QA form 20, QA form 34).
- j. For previously installed material in a SUBSAFE, LI, SOC or SFCC system which is removed and is to be re-installed, positive control and identification of the material shall be maintained from removal through reinstallation by use of a QA form 2. Non-controlled material will be tagged with a QA form 2 or other positive means of traceability until reinstallation.

<u>Procedure</u>	<u>Responsibility</u>
<p>Issuing a portion of a lot with material remaining: Initiate a new QA form 2 for each quantity less than the entire lot of material to be issued specifically annotating the amount to be issued. Annotate the Name of the craftsman and workcenter or shop or organization the material is issued to. Do not modify the original QA form 2.</p>	<p>CMPO</p>
<p>Update associated QA form 1 to annotate amount issued and amount remaining in accordance with QA form 1 instructions.</p>	<p>CMPO</p>
<p>When the last material of a lot is issued, destroy the original QA form 2 with zero amount remaining. Submit the associated QA form 1 with zero amount remaining to the QAO.</p>	<p>CMPO</p>

(This Page Intentionally Left Blank)

VOLUME V
PART I
CHAPTER 7
TESTING REQUIREMENTS

REFERENCES.

- (a) NAVSEA 0387-LP-046-8000 - System Hydrostatic Test Requirements
- (b) NAVSEA S9505-AF-MMA-010 - Submarine Non-Nuclear Piping Systems Test Manual
- (c) NAVSEA S9086-RK-STM-010 - NSTM Chapter 505 (Piping Systems)
- (d) NAVSEA S9074-AR-GIB-010/278 - Requirements for Fabrication Welding and Inspection, and Casting Inspection and Repair for Machinery, Piping and Pressure Vessels
- (e) NAVSEA S9086-RJ-STM-010 - NSTM Chapter 504 (Pressure, Temperature and other Mechanical and Electromechanical Measuring Instruments)
- (f) NAVSEA T9044-AD-MAN-010 - Requirements Manual for Submarine Fly-By-Wire Ship Control Systems
- (g) NAVSEA S9221-C1-GTP-010/020 - Main Boiler Repair and Overhaul, Volumes I and II
- (h) NAVSEA 0989-LP-037-2000 - Commissioned Submarine General Reactor Plant Overhaul and Repair Specification
- (i) NAVSEA 0989-LP-043-0000 - Commissioned Surface Ship General Reactor Plant Overhaul and Repair Specification
- (j) NAVSEA S9086-XG-STM-010 - NSTM Chapter 700 (Shipboard Ammunition Handling and Storage)
- (k) NAVSEA 0924-062-0010 - Submarine Safety (SUBSAFE) Requirements Manual
- (l) NAVSEA 0902-018-2010 - General Overhaul Specifications for Deep Diving SSBN/SSN Submarines (DDGOS)
- (m) NAVSEA 0989-LP-058-0000 - AS/AD Tender Nuclear Support Facilities Preventive Maintenance Index
- (n) NAVSEA 0900-LP-001-7000 - Fabrication and Inspection of Brazed Piping Systems
- (o) NAVSEA 0989-150-0000 - Standard Naval Nuclear Valves and Auxiliary Equipment
- (p) MIL-STD-1330 - Standard Practice for Precision Cleaning and Testing of Shipboard Oxygen, Helium, Helium-Oxygen, Nitrogen and Hydrogen Systems
- (q) NAVSEA S9086-CN-STM-040 - NSTM Chapter 079 V4 (Damage Control; Compartment Testing and Inspection)
- (r) NAVSEA T9512-AC-TRO-010 SS/SSN/SSBN - Submarine Snorkel Systems
- (s) NAVSEA S9425-AW-PRO-010 - Submarine Pressure Test, Evacuation/Charge and Dew Point Test Procedures

LISTING OF APPENDICES.

- A Testing Requirements for Surface Ship Systems
- B Testing Requirements for Submarine Systems
- C SUBMEPP Product Feedback

7.1 GENERAL. Testing is a key element in the certification process of work accomplished by Ship's Force, Fleet Maintenance Activities (FMA), shipyards and private organizations on ships or submarines. It is the final physical check that the system or component has been returned to its normal operational state and will function as designed. Excessive re-testing of system components will cause unnecessary cycling stresses on system components and is not desired. Test only what you fix.

NOTE: THE PRESSURE TEST REQUIREMENTS FOR REACTOR PLANT FLUID SYSTEMS ARE DELINEATED IN REFERENCE (a).

7.1.1 Testing Requirements for Systems, Portions of Systems and Components. Research is necessary to determine all applicable test requirements prior to conducting repairs. It is important to note that all required tests may not be identified by a single source (e.g., a fitting or component that has been manufactured locally will have to satisfy both the testing required by the original manufacturing specifications as well as any installation tests). Unless specific guidance to the contrary is given, the following requirements will be followed:

- a. Shipboard (in place) testing. The following requirements apply:
 - (1) All valve lineups and operations necessary to meet the testing requirements and performance of the test will be accomplished by Ship's Force to include the generation and approval of a Formal Work Package detailing the test procedure.
 - (2) The FMA will provide the test equipment required for in place testing, if requested.
 - (3) For testing to recertify FMA work, the FMA will provide Ship's Force with the test requirements, Quality Assurance (QA) data forms for Controlled Work Packages (CWP) only, and list of affected joints (if applicable). The FMA will review the test records to verify the satisfactory accomplishment of the test(s) and maintain the original Objective Quality Evidence (OQE) in the FMA CWP for testing to re-certify work.
 - (4) The System Test Check List of Volume IV, Chapter 9 of this manual will be used in the preparation, conduct, and recovery from hydrostatic tests and tests above normal operating pressure when an external pressure source is required.
- b. Shop or bench testing. To the maximum extent possible, all components to be installed in a ship's system will be work center or bench tested and/or inspected prior to installation, when required. This includes weld joint radiography, strength tests of welds or manufactured pressure boundary parts, valve seat leakage tests, etc. This results in a reduced number of cyclic stresses on the systems. The applicable portions of the System Test Check List of Volume IV, Chapter 9 of this manual will be used in preparation, conduct, and recovery from shop hydrostatic testing. QA form 28 will be used to document the OQE for shop testing.
- c. Hydrostatic/pneumatic testing. A QA form 26 will be used to document the OQE that the hydrostatic/pneumatic testing was completed satisfactorily. Nuclear hydrostatic/joint/pneumatic testing will be in accordance with reference (a) and paragraph 7.5.1 of this chapter. Non-nuclear hydrostatic/joint/pneumatic testing will be in accordance with reference (b) and (c) and Section 7.2 of this chapter.
- d. Miscellaneous testing, such as operational testing, will be documented on a QA form 17 when higher test authority requires a record and for which there is no other QA form.
- e. Drop testing. Used to test the integrity of a system by applying pressure and holding for a specified time and correcting the pressure drop for temperature changes. A QA form 27 will be used to document the OQE that the drop test was completed satisfactorily.
- f. Nondestructive Testing (NDT). Used to determine the integrity of metals with no detrimental effects to the subject metal. Specific guidance on NDT and required OQE is contained in reference (d) and Part I, Chapter 11 of this volume.
- g. Test instrumentation. Test instrumentation will be in accordance with the source documents.
 - (1) Installed master/primary and backup test pressure gages, including shop hydrostatic test stands, must be calibrated for accuracy as required by references (a), (c) and (e). These references may not include special test gage requirements and other source documents (e.g., Reactor Plant Manual (RPM), special test procedures, maintenance and replacement instruction requirements) may have to be consulted.
 - (2) Non-nuclear test instruments will be in accordance with references (c) and (e). Local exceptions to gage range and/or increments specified in references (c) and (e) will be approved by an individual with a technical warrant.

- h. Duration of tests. The duration of a shop or shipboard test will normally be established by the applicable technical reference (e.g., Test Pressure Drawing (TPD), technical manual, RPM, maintenance and replacement instructions), references (b) and (c) for non-nuclear piping systems, or reference (a) for nuclear systems. The following are general guidelines for duration of tests:
- (1) Mechanical joint tightness tests. All operating pressure tests performed to verify the integrity of a remade mechanical joint, which has only software (e.g., flexitallic gasket, gasket, O-ring) replaced, a 30 minute soak period at test pressure prior to commencement of inspections is required to permit weepage or seepage to accumulate.
 - (2) Strength and porosity tests. Tests performed in accordance with references (a) or (b) and (c) to verify the integrity of untested pressure boundary parts (e.g., flanges, bonnets, valve cartridges) or newly brazed or welded joints shall be soaked at test pressure for a minimum of 30 minutes prior to commencement of inspections.
 - (3) Periodic system hydrostatic tests. Periodic hydrostatic tests performed to verify the integrity and leak tightness of entire systems shall be conducted in accordance with references (b) and (c), which require a minimum 30 minute soak at test pressure prior to commencement of inspections.
 - (4) Operational tests. All operational tests performed to assure that all items, components, controls and indications function as designed and in accordance with specifications will be conducted for as long as required to prove the operability of the item being tested.
 - (5) The pressurization time prior to commencing inspections for leakage may be reduced from the normal 30 minute period when pressurization for 30 minutes using installed system equipment is impractical or undesirable (e.g., to avoid generation of radioactive liquid waste or hazardous waste, to avoid undesirable start/stop cycling of the normal system pressure source). In such cases where no minimum pressurization time is specified or it is impractical, maintain pressure for at least five minutes before inspecting joints.
 - (6) When performing operating pressure tests on gas systems (e.g., air, oxygen, nitrogen) using a soap bubble leak test method, a 15 minute hold period at test pressure is required. If system configuration makes it impossible to pressurize the joints continuously for 15 minutes, they should be pressurized for as long as possible.
- i. Testing of valve stems. Replaced stems in non-nuclear valves do not require a strength/porosity test, but the re-assembled valves do require a mechanical joint tightness test after assembly as discussed in reference (c). This includes stems manufactured by an FMA from certified Level I barstock.
- j. Testing of new flanged valves received without drilled bolt holes. New valves (e.g., Submarine Safety (SUBSAFE), Level I, nuclear Ready for Issue, and other valves received with certification) without bolt holes in the flanges require only mechanical joint tightness and operational testing in system, not strength testing, following machining bolt holes into flanges.
- k. Following routine maintenance and repair work performed on submarine Fly-By-Wire Ship Control Systems in accordance with submarine class maintenance plan, testing shall be performed as identified in class Fly-By-Wire Ship Control System Technical Work Document and reference (f). Work impacting Unrestricted Operations/Maintenance Requirement Card 019 measured parameters shall invoke conduct of applicable portions of Unrestricted Operations/Maintenance Requirement Card 019.

7.2 TESTING.

7.2.1 Test Procedures. Non-nuclear testing will comply with the detailed system/component plans of the source documents. TPDs have been developed for some classes of ships and contain strength test pressures, designated as "H" on the TPD, and mechanical joint tightness test pressures, designated as "J" on the TPD, for all portions of piping systems. Revisions and modifications to TPDs are documented in the SUBMEPP Strength and Tightness Standardized Test Procedure between periodic revisions to the TPDs. The Test Procedure should be reviewed for changes to the TPD. If TPDs do not exist, and test pressures are not identified on applicable system drawings, particular attention must be devoted to system design pressures and configuration. Technical Repair Standard

(TRS)/Maintenance Standard (MS) provide requirements for testing of many piping system components and generally are the source document for testing of those components. General guidelines for use of TPD "H" or "J" pressures and Appendices A and B Column 1 or Column 2 pressures are:

- a. TPD "H" or Appendices A and B Column 1 pressure is used following:
 - (1) Major repairs.
 - (2) Installation of new piping, components or fittings that have not been previously strength tested. DO NOT assume that new uncontrolled material from the Navy Supply System has been previously strength tested. Exceptions to the strength test requirement exist only for reduced energy criteria systems, installation of approved mechanically attached fittings, seals (gaskets, including pressure seal rings and O-rings), fasteners, valve stems and material meeting the requirements of Note 1 below. A strength test is not required if the end user obtains adequate documentation that a strength test has been previously completed for a specific item.
 - (3) (Submarines only) Re-making the mechanical joint between the hull and hull valve.

NOTE: "H" PRESSURE TESTING FOR NEW MATERIAL IS NOT REQUIRED IF ALL THE FOLLOWING ARE MET:

1. MATERIAL IS SUBSAFE SPECIAL MATERIAL IDENTIFICATION CODE (SMIC) OR LEVEL I MATERIAL RECEIVED FROM THE NAVY SUPPLY SYSTEM PROPERLY MARKED.
 2. A SATISFACTORY RECEIPT INSPECTION IS COMPLETED BY THE END USER.
 3. MATERIAL IS RECEIVED IN THE CONFIGURATION REQUIRED FOR USE WITHOUT REQUIRING ADDITIONAL MACHINING, WELDING OR OTHER MAJOR REPAIR. (BAR, INGOTS, PLATE, FORGINGS, ETC., WHICH ARE MACHINED, WELDED OR HAVE A MAJOR REPAIR, REQUIRE AN "H" PRESSURE TEST TO CERTIFY THE COMPONENT.)
- b. TPD "J" or Appendices A and B Column 2 pressure is used following:
 - (1) Minor repairs.
 - (2) Re-made mechanical joints meeting requirements of reference (c).
 - (3) Repairs, replacements and modifications of piping, components and fittings in reduced energy criteria systems (those operating at 500 psig or less and 200°F or less); the work must meet all applicable specifications and requirements and satisfactorily pass all other required non-destructive testing.
 - (4) Installation of approved mechanically attached fittings meeting the requirements of reference (c).

7.2.2 Test Requirements. The following requirements pertain to non-nuclear testing:

- a. Reference (b), (c) and (e) contain the test rig, test gauges, and testing procedure requirements for performing non-nuclear testing. Additionally, ship or system specific manuals such as a Steam Plant Manual should be consulted where applicable. Test, Measuring and Diagnostic Equipment documentation for operating pressure tests is not required if normally installed system gages are used.
- b. When a test gauge is not listed in reference (e), a gauge where the test pressure falls within 50-90% of the gauge range will be used (not applicable for operating pressure tests using normally installed system gages).
- c. Portions of systems that are not designed for full test pressure will be isolated and provided with a relief or vent path to prevent over pressurization during testing.
- d. Hydrostatic/pneumatic test results will be documented on a QA form 26 and system drop tests will be documented on a QA form 27. Miscellaneous testing will be documented on a QA form 17.

- e. Where test requirements cannot be met, a Departure from Specification (DFS) will be processed in accordance with Part I, Chapter 8 of this volume.
- f. Shop test of replacement components will be conducted in accordance with reference (c).
- g. Renewal or replacement of non-nuclear mechanical joint fasteners. If mechanical joint fasteners are removed and re-installed or replaced one at a time, torqued in accordance with an approved procedure and using approved thread lubricants, the integrity of the mechanical joint has not been violated and a test for strength or tightness is not required. For submarines, this applies to joints both within and outside of hull integrity areas. Replacement shall be controlled by a Technical Work Document.

7.2.3 Test Pressure Source References. Mechanical joint tightness tests are performed to test work performed on piping systems and components. The following list provides typical documents used to determine test pressures and operational requirements:

- a. TPD. The applicable TPD, if promulgated for a particular class of ship, can be found through the use of the TPD Index or Ship's Drawing Index or referenced in the Record of Shipboard Tests.
- b. RPM.
- c. Steam and Electric Plant Manual Maintenance and Replacement Instructions requirements.
- d. Component technical manual.
- e. Ship valves technical manual.
- f. Ship System Manual.
- g. Naval Ships' Technical Manual (NSTM) chapter dealing with the appropriate system.
- h. Record of Shipboard Tests.
- i. Standardized Class Shipboard Test Procedures.
- j. System diagrams/drawings.
- k. Vendor drawings.
- l. Submarine MSs.
- m. Steam Plant Manual.
- n. Boiler Repair Manual (reference (g)).
- o. References (a), (b), (c), (d), (h), (i), (j), (k) and (l) of this chapter. In each case, every effort should be made to conform to the latest applicable specifications and detailed test requirements.

7.2.4 Non-Nuclear Pressure Drop Tests. (Submarines only)

7.2.4.1 General Instructions.

- a. When accomplishing pneumatic mechanical joint tightness tests on air/compressed gas systems, tanks and/or compartments as specified by the procedure, pressurize the space/system with the test medium (air, nitrogen, etc.) to the pressure specified. Isolate the test rig from the test area and allow the system to stabilize and remain isolated for the specified amount of time. The actual drop in test pressure corrected for temperature change must be calculated.
- b. This method of testing may also be used when testing valves for tightness/seat tightness using water. When test pressure is reached, lock in test pressure and isolate the pressure source from the test rig, and allow the system to stabilize and remain isolated for the specified amount of time. Acceptance criteria is no drop in pressure over the specified time (unless a specific drop in pressure is specified). Test duration shall be as specified in the TWD. Generally calculations for correction due to temperature changes are not required.

7.2.4.2 Calculations.

a. METHOD: Pressure Drop, (psi) Temperature Corrected =
$$\frac{(P_1 + 14.7)(T_2 + 460)}{(T_1 + 460)} - (P_2 + 14.7)$$

WHERE:

T₁ = Initial Measured Temperature °F

T₂ = Final Measured Temperature °F

P₁ = Initial Measured Pressure, psig from Test Gage

P₂ = Final Measured Pressure, psig from Test Gage

14.7 = Atmospheric Pressure, psi (added to gage pressure to convert to absolute pressure)

460 = Absolute Temperature Scale (added to Fahrenheit temperature to convert to absolute temperature)

- b. The temperature value used for calculations must be the net effective temperature for the tested volume. For a submarine high pressure air system under test, most of the system gas is in the flasks located in the main ballast tanks. Therefore, temperatures most nearly representing the flask(s) internal temperature(s) are required. The net effective temperature of a high pressure air system on a waterborne submarine is calculated by a weighted average of temperatures using a weighing factor of nine (9) for sea water temperature and one (1) for average compartment temperature.

$$T_{net} = \frac{(\text{SEA WATER TEMP} \times 9) + (\text{COMPARTMENT TEMP})}{10}$$

7.2.4.3 Example. This paragraph provides a typical example of a Pressure Drop Test corrected for a temperature change:

Ships Air Bank Initial Pressure 4500 psig

* Sea Water Temperature Outside Ballast Tank at Start of Test 44°F

* Sea Water Temperature Outside Ballast Tank at End of Test 50°F

** Ship's Compartment Air Temperature at Start of Test 70°F

Ship's Compartment Air Temperature at End of Test 72°F

Ship's Air Bank Final Pressure 4520 psig

Allowable Pressure Drop in 24 Hours at 1 % 45 psi

$$\text{Actual Pressure Drop} = \frac{(P_1 + 14.7)(T_2 + 460)}{(T_1 + 460)} - (P_2 + 14.7)$$

$$T_1 \text{ Net} = \frac{(44 \times 9) + (70 \times 1)}{10} + 460 = 507$$

$$T_2 \text{ Net} = \frac{(50 \times 9) + (72 \times 1)}{10} + 460 = 512$$

$$\frac{(4500 + 14.7) (512)}{(507)} = 4559.2$$

$$\begin{aligned} \text{Actual Pressure Drop} &= 4559.2 - 4534.7 \\ &= 24.5 \end{aligned}$$

RESULT: Final pressure drop in 24 hours corrected for temperature change is 24.5 psi, which is less than the allowable 45 psi; therefore, test is satisfactory.

- * Sea water temperature should preferably be taken at one half (1/2) keel depth in proximity to air banks. For a ship in drydock, substitute air flask surface temperatures in the main ballast tanks in lieu of sea water temperatures.
- ** Compartment temperatures should be taken in close proximity to the air system piping and should include surface temperature of air flasks within compartments which are included in the test boundaries.

7.3 WEIGHT HANDLING EQUIPMENT.

7.3.1 Weight Handling Equipment. All weight handling equipment, fittings and fixtures, shall be tested and marked or tagged to indicate completion of test prior to being placed into service.

- a. Shipboard Equipment. The following are sources of test procedures for shipboard equipment/systems that require tests upon completion of manufacture or repairs:

<u>Equipment/System</u>	<u>Governing Document(s)</u>
Davits	NSTM 583, Planned Maintenance System (PMS)
Cranes	NSTM 589, PMS
General stores & provisions handling (i.e., dumbwaiters, hoists, conveyors)	NSTM 572, PMS
Booms	NSTM 573, PMS
Underway replenishment	NSTM 571, PMS
Anchors & anchoring	NSTM 581, PMS
Elevators	NSTM 588, NSTM 772, PMS
Deck fittings	NSTM 9120, PMS
Deck edge safety nets	PMS, Naval Sea Systems Command (NAVSEA) Dwgs 53711-803-5000902 and 53711-803-5184097
Trunk nets	PMS, NAVSEA Dwg 53711-804-5184163
Ordnance handling	NAVSEA SG420-AP-MMA-010, NSTM 700
Slings:	
- General Purpose	NSTM 572
- Specialized	Per drawing or In-Service Engineering Activity guidance
Padeyes (temporary - installed for rigging purposes)	Install in accordance with NAVSEA S9AA0-AB-GOS-010

Portable weight handling equipment; chain falls (pneumatic/manual) and come-alongs	PMS, NSTM 572, ASME HST-3, MIL-H-904* *MIL-H-904 is inactive and used only for replacement parts. ASME HST-3 is used for new procurement.
Aircraft securing and engine run-up fittings	803-191630, PMS
Cargo tie down fittings	NSTM 572, PMS
Landing craft tie downs	NSTM 584, PMS
Vehicle tie downs	NSTM 575, PMS
Bridge cranes	NSTM 700
Hoists	NSTM 700

NOTE: PER NAVSEA DIRECTION, STATIC, DYNAMIC AND RATED LOAD TESTING OF MAIN STORAGE BATTERY LIFTING GEAR INSTALLED IN SUBMARINE BATTERY COMPARTMENTS IS NOT REQUIRED UNLESS REPAIRS TO STRUCTURAL OR WEIGHT SUPPORTING COMPONENTS HAVE BEEN ACCOMPLISHED. FOLLOWING REPAIRS, LOAD TESTING WILL BE ACCOMPLISHED DURING BATTERY REPLACEMENT AFTER THE BATTERY CELLS HAVE BEEN REMOVED.

- b. Reactor plant and Nuclear Support Facility (NSF) lifting and handling equipment testing requirements.
 - (1) In addition to the respective ship class RPM, references (h) and (i) shall be consulted for reactor plant lifting and handling tests and inspection requirements.
 - (2) The applicable NAVSEA drawing, the respective ship class NSF manual and reference (m), specify the lifting and handling tests and inspection requirements for NSFs/CIFs.

7.4 EXEMPTIONS/ALTERNATIVE TEST REQUIREMENTS (NON-NUCLEAR).

7.4.1 General. In some instances, the required test may not be able to be performed. The following exemption/alternative tests have been developed in order to properly recertify the system or component. These tests are non-nuclear unless specifically addressed in nuclear technical documents. A DFS will be used to document non-performance of the required testing and/or deferral of certification of the system to an at sea test.

NOTE: THE DFS APPROVAL WILL BE IN ACCORDANCE WITH CHAPTER 8, PART I, PARAGRAPH 8.2.5.b OF THIS VOLUME TO IDENTIFY APPLICABLE RESTRICTIONS TO SHIP OPERATIONS (IF ANY) REQUIRED UNTIL SATISFACTORY COMPLETION OF THE CONTROLLED DEEP DIVE.

- a. (Submarines only) Technical Work Documents for maintenance or repair of seawater interface systems which require a “J” pressure test, equivalent to test depth pressure, to certify the maintenance boundaries shall be closed prior to underway operations, if at sea, prior to operations below 200 feet. When controlled deep dive testing is required in lieu of a joint tightness test to “J” pressure, a QA form 12 shall be used to establish accountability for the controlled deep dive test. If certification of the maintenance associated with the exception/alternative for non-SUBSAFE controlled systems or components (such as L1, O2, etc.) retest requires a controlled deep dive test in lieu of a joint tightness test to “J” pressure of TPD, the DFS will:
 - (1) Identify completion of the controlled assembly (if required).
 - (2) Identify results of the exception/alternative testing.

- (3) Identify the at-sea testing requirements, acceptance criteria and restrictions, if any, for unsatisfactory testing. Generally, failed testing of work on a non-SUBSAFE system does not result in depth limitations.
- b. (Submarines only) If a Maintenance Certification Record/Re-Entry Control is closed by transferring at sea testing to a DFS (e.g., controlled dive to test depth for test of a periscope hull gland, controlled dive for test of a sea connected system (e.g., Main Sea Water (MSW), Auxiliary Sea Water (ASW)) in lieu of joint tightness test to “J” pressure of TPD), the ship will be restricted to the requirements of Part I, Chapter 5, Section 5.6.5a of this volume until satisfactory completion of a controlled deep dive per Volume VI, Chapter 26 of this manual.
- c. (Submarines only) If work on a non-controlled system requires an exception/alternative retest and/or at sea testing, the work shall be performed as follows:
 - (1) A Formal Work Package in accordance with Part I, Chapter 2 of this volume, (e.g., PMS Maintenance Requirement Card, technical manual pages, detailed maintenance outline), will be used to control and document all work performed.
 - (2) If a controlled assembly is required, the QA form 34 shall be retained per Part I, Chapter 10 of this volume. Controlled assembly requirements are:
 - (a) Verification that surface finishes of gasket/o-ring sealing surfaces are in accordance with applicable specifications.
 - (b) Verification that fastener material and installation is in accordance with applicable specifications.
 - (c) Verification that gaskets/o-rings are properly installed and in accordance with applicable specifications.
 - (d) Assembly is documented on a QA form 34.
 - (e) Inspected by a Quality Assurance Inspector or Quality Assurance Supervisor.
 - (3) If certification of the maintenance associated with the exception/alternative retest requires a controlled deep dive test in lieu of a joint tightness test to “J” pressure of TPD, the DFS will:
 - (a) Identify completion of the controlled assembly (if required).
 - (b) Identify results of the exception/alternative testing.
 - (c) Identify the at sea testing requirement(s) and acceptance criteria and restrictions, if any, for unsatisfactory testing. Generally, failed testing of work on a non-SUBSAFE system does not result in depth limitations.

7.4.2 Exemptions/Alternatives to Test Requirements (Non-Nuclear unless Specifically Addressed in Nuclear Technical Documents).

NOTE: 1. “H” PRESSURE TESTING FOR NEW MATERIAL IS NOT REQUIRED IF BOTH THE FOLLOWING ARE MET:

- 1. MATERIAL IS SUBSAFE SMIC OR LEVEL I MATERIAL RECEIVED FROM THE NAVY SUPPLY SYSTEM PROPERLY MARKED.
- 2. A SATISFACTORY RECEIPT INSPECTION IS COMPLETED BY THE END USER.

NOTE: 2. MATERIAL IS RECEIVED IN THE CONFIGURATION REQUIRED FOR USE WITHOUT REQUIRING ADDITIONAL MACHINING, WELDING OR OTHER MAJOR REPAIR. (BAR, INGOTS, PLATE, FORGINGS, ETC., WHICH ARE MACHINED, WELDED OR HAVE A MAJOR REPAIR, REQUIRES A “H” PRESSURE TEST TO CERTIFY THE COMPONENT.)

- a. Mechanical joints. For minor repairs on those mechanical joints previously strength tested (e.g., an “H” test has been conducted on the pressure boundary parts in the past) including hull joints, where system configuration makes mechanical joint tightness testing impractical, the following is considered a satisfactory alternate testing method.

- (1) Perform a controlled assembly of the joint(s).
 - (2) Visually inspect the joint for leakage during first system pressurization to nominal/system operating pressure and document on a QA form 17.
 - (3) (Submarines only) For submarine sea connected systems, initiate a minor DFS to document the lack of retest. Clearance will require joints to be visually inspected at each incremental depth during the first controlled dive. No leakage is allowed.
- b. Valve test. Following the in place repair of valves where configuration precludes mechanical joint tightness testing or seat tightness testing after minor repairs, the following is considered a satisfactory alternate testing method.

NOTE: (SUBMARINES ONLY) EXCEPT FOR EMERGENCY MAIN BALLAST TANK (EMBT) PARKER CHECK VALVES, THE FOLLOWING EXEMPTIONS DO NOT APPLY TO SUBMARINE HULL AND BACKUP VALVES OR ASSOCIATED HULL INTEGRITY JOINTS OUTBOARD OF THE BACKUP VALVE.

- (1) For lack of seat tightness testing, measure and document the following as applicable:
 - (a) A seat blue check for non-ball valves (100% contact required).
 - (b) For soft seated valves, such as Parker check valves, where a blue check is not practical, re-assemble the valve, perform the appropriate mechanical joint tightness test, and applicable portions of the Unrestricted Operation Maintenance Requirement Card (if applicable). A minor DFS is required to document the lack of seat tightness testing and the requirements to conduct inspections during a controlled dive to test depth to verify seat tightness.
 - (c) Dimensional verification/stack height for ball valves (satisfactory seat compression required).
 - (d) For welded or brazed in-line SUBSAFE valves (hull and backup valves are specifically excluded) and all non-nuclear, non-SUBSAFE valves repaired in place, no DFS is required.
 - (e) For bolted-in SUBSAFE valves repaired in place, initiate a major DFS to the Type Commander in accordance with Part I, Chapter 8 of this volume to document the lack of seat tightness test.
 - (2) For lack of mechanical joint tightness testing for valves in submarine sea connected systems, perform a controlled assembly of the valve(s) mechanical pressure boundary joints and initiate a minor DFS to document the lack of test. Clearance will require that the affected joints be visually inspected during the first controlled dive.
- c. Welded joint options. Reference (c) contains options for testing welded joints.

NOTE: ELECTION TO INVOKE THE OPERATING PRESSURE TEST OPTION REQUIRES A CLEAR UNDERSTANDING OF THE SYSTEM OPERATING, TEST AND INSPECTION REQUIREMENTS OF REFERENCES (c), (d) AND APPLICABLE TEST METHODS. CONSIDERATION MUST BE GIVEN TO SAFETY, MAINTENANCE COST, TIME AND THE SPECIFIC SYSTEM UNDERGOING REPAIR. THE OPERATING PRESSURE TEST OPTION MUST BE PART OF THE PRE-PLANNED REPAIR PROCESS INCORPORATED INTO THE TECHNICAL WORK DOCUMENT.

- d. Nuclear interface systems. Nuclear interface systems should be tested in accordance with reference (a).
- e. Brazed joints.
- (1) A hydrostatic test is not required after brazed repairs or replacements if all of the following criteria are met:

- (a) System is a reduced energy system. (Normal operating pressure 200 psig or less and normal operating temperature 200 degrees F or less). Joints are not in “lethal” system as defined in reference (n). Joints are not in sea water or sea connected systems or portions thereof, which are subject to submergence pressure below 200 feet or to sections of piping that pass through sea pressure rated bulkheads and which are rated for submergence pressures greater than 200 feet.
 - (b) All applicable NDT on brazed joints is performed.
 - (c) Visually inspect for leakage during the first system pressurization to normal operating pressure.
- (2) When a brazed joint of a system and/or component cannot be strength tested due to configuration, the following is considered to be an acceptable alternative:
- (a) Initiate a major DFS to document the lack of strength test.
 - (b) Visually inspect the joint for leakage during first system pressurization to nominal/system operating pressure and document on a QA form 17.
- f. Mechanically attached fittings are not welded or brazed fittings. They must meet all QA requirements as specified in the applicable Uniform Industrial Process Instruction or Process Instruction for mechanically attached fitting installation per reference (c). Election of the operating pressure test option will not require a DFS if pre-planned into the repair process to ensure all original QA requirements and additional NDT required by reference (c) are performed.
 - g. (Submarines only) When post deep dive passive/pre-energize testing is required by system specific Technical Manuals or Maintenance Index Pages/Maintenance Requirement Cards, outboard electrical connections subject to full submergence sea pressure will be documented on a QA form 12 as a minor departure to accomplish post deep dive passive/pre-energize testing. The departure will also indicate if a controlled assembly was performed.
 - h. (Submarines only) For lack of mechanical joint tightness testing following replacement of BPS-16 upper RADAR mast seals, perform a controlled assembly of the mast mechanical pressure boundary joints and initiate a minor DFS to document the lack of test. Clearance will require that the affected joints be visually inspected during the first controlled dive.

7.5 REACTOR PLANT AND NUCLEAR SUPPORT FACILITY TESTING.

7.5.1 Hydrostatic/Pneumatic Tests or Drop Tests. A QA form 26 and QA form 27, will be used to document the OQE that the hydrostatic/pneumatic or drop testing was completed satisfactorily.

- a. When unable to accomplish the required test, a Liaison Action Request will be initiated in accordance with Part I, Chapter 8, of this volume.
- b. When unable to satisfactorily test repaired valves due to out of specification seat leakage, Part I, Chapter 8, of this volume describes the procedure to defer work and close out the CWP.
- c. Reference (a) contains the hydrostatic test requirements for reactor plant fluid systems and portions of systems. It contains requirements for test rigs, test gauges, and test precautions.
- d. Some reactor plant fluid systems have specific system hydrostatic test instructions and special test requirements in the RPM. Others must have local procedures prepared based on the requirements of reference (a) and the RPM.
- e. The Immediate Superior in Command will review Ship’s Force test procedures for FMA accomplished nuclear work and will resolve questions or problems with test requirements.
- f. The System Test Check List in Volume IV, Chapter 9 of this manual will be used in preparation, conduct and recovery from test.

7.5.2 Mechanical Joint Fasteners.

- a. When mechanical joint fasteners are removed and re-installed or replaced one at a time and torqued in accordance with an approved procedure, refer to reference (a) to determine the extent of test required.

- b. Test requirements for mechanical fasteners within the reactor plant SUBSAFE boundary are contained in Appendix 8 of reference (h).
- c. Replacement of fasteners shall be controlled by a CWP in accordance with Part I, Chapter 2, of this volume, for hydrostatic tests and tests above normal operating pressure when an external source is required.

7.5.3 Valve Seat Leak Tests. Periodically and following any repair which affects seat tightness, installed valves (i.e., valves repaired in-place) seat leak tests shall be performed in accordance with reference (o), in conjunction with the cognizant RPM. The necessity for seat tightness testing of replaced valves (with or without Ready for Issue) should be determined using the requirements of reference (o) and the cognizant RPM. Prior to installation or recertification as Ready for Issue, valves removed from the system for overhaul or refurbishment shall be tested in accordance with the applicable component technical manual. Fleet Maintenance Support Branch Quality Engineering Division Note 18 provides information for troubleshooting and leak testing reactor plant valves.

7.6 SUPPLEMENTAL TEST CRITERIA (NON-NUCLEAR).

7.6.1 Purpose. This section is provided along with section 7.4 of this chapter to identify test requirements that may be used when more authoritative requirements are not available, or are incomplete. The performance of tests in accordance with these requirements will constitute satisfactory testing. A DFS will not be required unless specifically required as part of the alternative test. The applicable ship class source documents take precedence over Appendices A and B. Notes in the appendices also provide testing guidance that is to be applied even when the testing requirements are specified by TPD or other authoritative guidance. Appendix A applies to Surface ships systems and Appendix B applies to Submarines.

- a. Appendices A and B are intended as a general guide for testing where specific guidance is not provided. All portions of a given system may not necessarily be tested to the pressure specified (e.g., the 30 psig portions of a submarine Fuel Oil Filling, Transfer, and Compensating Water System should not be tested to 150% of test depth pressure).
- b. For component testing where a TRS/MS has been used for restoration or overhaul, TRS/MS testing requirements should be followed. TRS/MS requirements may differ from the test specifications on the drawing for the component. The drawing specifications are generally intended as manufacturing acceptance tests. Though no specific guide to precedence can be made, good engineering judgment and conservative approach to testing should prevail. If only part of a TRS/MS was used in component maintenance, the testing requirements in the TRS/MS may not apply. The use of submarine TRS/MS in the testing phase of maintenance has, in the past, required an inordinate amount of work during submarine upkeep and refit periods. Where only minor repairs (as defined in the glossary) are accomplished using a TRS/MS, only the applicable test requirements should be accomplished.

APPENDIX A
TESTING REQUIREMENTS FOR SURFACE SHIP SYSTEMS

System Note 1	Column 1 Strength and Porosity Test Pressure Notes 2, 3, and 4	Column 2 Mechanical Joint Tightness Test Pressure Notes 3, 4, and 5	Special Notes
Steam	135% system design pressure	100% nominal operating pressure	
Non-Nuclear structural tanks			
Feed and condensate	135% system design pressure	100% nominal operating pressure	
Fuel oil service	135% system design pressure	100% nominal operating pressure	
Lube oil fill, transfer, and service	135% system design pressure	100% nominal operating pressure	Note 3
Oxygen (except surface ship divers' life support systems)	135% system design pressure	100% nominal operating pressure	Notes 6, 7, and 8
Nitrogen	135% system design pressure	100% nominal operating pressure	Note 7
Fresh water cooling, chilled water, potable water	135% system design pressure	100% nominal operating pressure	
Fuel oil filling and transfer	135% system design pressure	100% nominal operating pressure	
Compressed air (except surface ship divers' life support systems, bleed air, and starting air)	135% system design pressure	100% nominal operating pressure	
Hydraulic (e.g., ship service, controllable pitch propeller, windlass)	135% system design pressure	100% nominal operating pressure	Notes 3 and 9
Boiler (within boundary valves)	See Note 10	See Note 10	
Fire main and flushing	135% system design pressure	100% nominal operating pressure	
Sea water cooling	135% system design pressure	100% nominal operating pressure	
Deck and plumbing drains, sound tubes open to the atmosphere	Not required	See Note 11	
Countermeasures washdown	50 psig	Operational test	
Divers' life support system (air, oxygen, helium)	135% system design pressure	100% nominal operating pressure	Notes 7, and 8

System Note 1	Column 1 Strength and Porosity Test Pressure Notes 2, 3, and 4	Column 2 Mechanical Joint Tightness Test Pressure Notes 3, 4, and 5	Special Notes
Sewage	135% system design pressure	100% nominal operating pressure	
Ballasting, sea water transfer	135% system design pressure	100% nominal operating pressure	
Primary and secondary drainage from pump	50 psig	Operational test	
Primary and secondary drainage from eductor	135% system design pressure	100% nominal operating pressure	
Bilge stripping system	50 psig	Operational test	
Main steam drain system	Relief valve setting	Operational test	
Feedwater drain collecting system	Fill with water and let stand		
Feedwater drain collecting tank and discharge from tank	135% system design pressure	Operational test	
Gage lines (all systems)	135% system design pressure for welded and brazed joints visual inspection for other joints	Operational Test	
Freon, Halon, hydrocarbons	135% system design pressure	See Note 12	
Valves	135% system design pressure		Note 13

NOTE 1: Testing requirements for surface ship piping and components not specified above will be 135% of system design pressure where repairs meet the criteria of a major repair.

NOTE 2: Strength and porosity test - Where a major repair is accomplished on the pressure boundary of a piping system or component, that portion of the system or component will be hydrostatically tested as indicated in column 1. Strength and porosity test duration is 30 minutes unless otherwise specified on a component, system, or TPD. The strength and porosity test pressure is identified on a TPD as the "H" pressure.

- a. Strength and porosity test pressure shall be not less than 50 psig.
- b. New mechanical joints (as defined in the Glossary of Terms) are subjected to a strength and porosity test.

NOTE 3: Test fluids.

- a. If the test fluid for a mechanical joint tightness test is not specified, either clean fresh water or system fluid shall be used. System fluid shall be used for hydraulic and lubricating oil systems. Compressed gasses may be used for mechanical joint tightness tests provided they can be used safely.
- b. Observe safety precautions for air, industrial gases, and hydraulic systems found in NSTM, as well as notes below, if system fluid or gas is used.

NOTE 4: Exceptions/alternatives to hydrostatic test requirements are provided in Section 7.4 of this chapter.

NOTE 5: Mechanical joint tightness test duration is 30 minutes unless otherwise specified on a component, system, or TPD. The mechanical joint tightness test pressure is indicated on a TPD as the “J” pressure or nominal operating pressure if performing an operational pressure test. Zero visual external leakage is normally the tightness acceptance criterion.

- a. Re-made mechanical joints (as defined in the glossary) are subjected to a mechanical joint tightness test.
- b. The tightness test must be performed with the thermal insulation removed from mechanical joints to be examined.

NOTE 6: Where oxygen piping or system components are re-installed by mechanical joints, these portions of the system will be tested to 100% operating pressure using **nitrogen** in accordance with reference (p). System fluid (oxygen) may be used in **at-sea** situations when use of nitrogen is not practical. The test pressure will be held for a minimum of 15 minutes plus the time required to conduct inspection of joints under test.

NOTE 7: Refer to reference (p) for testing requirements and procedures for oxygen, nitrogen, and hydrogen systems.

NOTE 8: Before testing oxygen stop valves with Kerotest Co. cartridges in accordance with Kerotest Drawing 72594765, ensure the valve is assembled in accordance with Kerotest Instruction K-673 and that the union is torqued to 160 - 170 ft.-lbs. This is necessary to ensure the cartridge is not damaged.

CAUTION: CARE MUST BE EXERCISED WHEN HYDRAULIC OIL IS USED AS A TEST LIQUID TO PREVENT SPRAY OR LEAKAGE FROM BECOMING A FIRE OR CONTAMINATION HAZARD.

NOTE 9: Where shop pre-tested hydraulic system components or hydraulic system piping are reinstalled by mechanical joints, those portions will be tested to column 2 requirements using hydraulic oil as the test fluid.

NOTE 10: All testing within the boundary valves of boilers shall be accomplished in accordance with reference (g).

NOTE 11: System must be open to the atmosphere. Fill system with water and allow to stand for a minimum of 30 minutes. Examine disturbed joints for leakage; none is allowed.

NOTE 12: Refer to system, equipment, or component technical manual. Final test involves performance of pressure drop tests over various time periods. See also reference (p).

NOTE 13: Cycle valve during hydrostatic testing as required by NSTM.

(This Page Intentionally Left Blank)

APPENDIX B

TESTING REQUIREMENTS FOR SUBMARINE SYSTEMS

System	Column 1	Column 2	Special Notes
Note 1	Strength and Porosity Test Pressure	Mechanical Joint Tightness Test Pressure	
	Notes 2, 3 and 4	Notes 3, 4 and 5	
Steam	135% system design pressure	100% nominal operating pressure	
Non-Nuclear structural tanks			Notes 13 and 18
Feed and condensate	135% system design pressure	100% nominal operating pressure	
Fuel oil service	135% system design pressure	100% nominal operating pressure	
Lube oil fill, transfer, and service	135% system design pressure	100% nominal operating pressure	Note 3
Oxygen (except surface ship divers' life support systems)	135% system design pressure	100% nominal operating pressure	Notes 10, 11 and 12
Nitrogen	135% system design pressure	100% nominal operating pressure	Note 11
Fresh water cooling, chilled water, potable water	135% system design pressure	100% nominal operating pressure	
Fuel oil filling and transfer	135% system design pressure (135% test depth pressure for those portions of submarine systems exposed to submergence pressure)	100% nominal operating pressure (100% test depth pressure for those portions of submarine systems exposed to submergence pressure)	
Compressed air including EMBT blow (except surface ship divers' life support systems, bleed air, and starting air)	135% system design pressure	100% nominal operating pressure. For submarines, this is up to the pressure hull cutout valve if the airline penetrates the pressure hull	Notes 6, 8 and 24
Hydraulic (e.g., ship service, steering and diving, windlass, flood control)	135% system design pressure	100% nominal operating pressure	Notes 3, 23 and 24
Hull glands, cables, shafts, masts			Notes 13, 25, 26 and 29
Escape trunks, hatches (including missile tube muzzle hatches on SSBN/SSGN Class Submarines), watertight bulkhead doors, Sonar Spheres			Notes 14, 21, 27, 28, 29, 32, 33 and 34
Periscopes			Note 16

System Note 1	Column 1 Strength and Porosity Test Pressure Notes 2, 3 and 4	Column 2 Mechanical Joint Tightness Test Pressure Notes 3, 4 and 5	Special Notes
Antennas		In accordance with NAVSEA 0900-LP-016-7007 and SS-404-1971420	Note 31
Diesel Sea Water (DSW)			Notes 6 and 9
Hydrogen	135% design pressure	100% nominal operating pressure	Note 11
Hovering/depth control, sea water circulating (e.g., ASW, MSW, Air Conditioning Seawater)	150% test depth plus pump shutoff pressure	100% test depth pressure	Notes 6, 7, 24, and 30
Plumbing system subjected to submergence pressure	150% test depth	100% test depth pressure	Note 6
Trim and drain systems subjected to submergence pressure	150% test depth pressure	100% test depth pressure	Notes 6, 7 and 24
Torpedo tube system, including the entire SUBSAFE portion of the system	100% test depth pressure plus 90 psig	100% test depth pressure plus 90 psig	Notes 17 and 24
Signal ejectors			Notes 20, 24 and 32
SSBN/SSGN bulkhead penetrator holes/covers			Note 22
Snorkel induction and exhaust lines			Notes 15 and 32
Cable plugs to EHF's, EHPs, antennas, masts, radars and other component connection/joint exposed to submergence sea pressure (excluding photonics, shore power connectors and pressure proof caps used on EHF's and EHPs)			Notes 31 and 35
SONAR Hydrophone, Transducer, Projectors and Outboard Components			Note 35

NOTE 1: Testing requirements for submarine ship piping and for submarine pressure hull envelope systems and components not specified above will be 135% of system design pressure where repairs meet the criteria of a major repair.

NOTE 2: Strength and porosity test - Where a major repair is accomplished on the pressure boundary of a piping system or component, that portion of the system or component will be pressure tested as indicated in the applicable TPD. The strength and porosity test pressure is identified on a TPD as the "H" pressure. In the absence of specific test pressure direction on a TPD, test pressure shall be per Note 1. Strength and porosity test duration is 30 minutes unless otherwise specified in a technical reference.

- a. Strength and porosity test pressure shall be not less than 50 psig unless otherwise specified in the TPD.
- b. New mechanical joints (as defined in the Glossary of Terms) are subjected to a strength and porosity test.

NOTE 3: Test fluid.

- a. If the test fluid for a mechanical joint tightness test is not specified, either clean fresh water or system fluid shall be used. System fluid shall be used for hydraulic and lubricating oil systems. Compressed gases may be used for mechanical joint tightness tests provided they can be used safely.
- b. Observe safety precautions for air, industrial gases, and hydraulic systems found in NSTM, as well as notes below, if system fluid or gas is used.

NOTE 4: Exceptions/alternatives to hydrostatic test requirements are provided in Section 7.4 of this chapter.

NOTE 5: Mechanical joint tightness test duration is 30 minutes unless otherwise specified on a component, system, or TPD. The mechanical joint tightness test pressure is indicated on a TPD as the "J" pressure or nominal operating pressure if performing an operational pressure test. Zero visual external leakage is normally the tightness acceptance criterion.

- a. Re-made mechanical joints (as defined in the glossary) are subjected to a mechanical joint tightness test.
- b. The tightness test must be performed with the thermal insulation removed from mechanical joints to be examined.
- c. This note does not apply to submarine hull and backup valves. (See NOTE 6 of this appendix)

NOTE 6: Where hull valves and backup valves are repaired or replaced, they will be tested as follows:

- a. Valves removed for repair. Hull valve and/or backup valves that are removed completely from the system for repair and/or maintenance will be tested as follows:
 - (1) Prior to installing in the system:
 - (a) Conduct a strength and porosity test to column 1 requirements with the valve ball/disc positioned such that the unproven pressure boundary parts and disturbed joints are exposed to test pressure.
 - (b) With the valve shut, test from seaside to column 1 requirements to test for seat leakage.
 - (c) If a mechanical joint leaks at column 1 pressure, decrease to column 2 pressure and verify no leakage.
 - (d) For minor repairs, test as in steps a.(1) (a) through a.(1) (c) of this Note, but to column 2 requirements.
 - (e) Where valve internals can be visually inspected for leakage, seat tightness test pressure need only be maintained for three minutes unless specified otherwise in the applicable maintenance document.
 - (2) After re-installation in system, test disturbed mechanical joints as follows:
 - (a) Apply test pressure of column 1 requirements to all mechanical joints to which major repairs were conducted and not strength tested prior to valve installation.
 - (b) Apply external (seaside) test to column 1 requirements of all mechanical joints between hull valve and hull. For other disturbed mechanical joints, test to column 2 requirements.
 - (c) For hull joints where testing is not feasible, controlled assembly followed by a controlled dive in accordance with paragraph 7.4.2 a of this chapter is a satisfactory alternative to the test.
- b. Valves repaired in place.
 - (1) If major repairs have been accomplished:
 - (a) Conduct a strength test to column 1 requirements with the valve ball/disc positioned such that the unproven pressure boundary parts and disturbed joints are exposed to test pressure.

- (b) With the valve shut, test from seaside to column 1 requirements to test for seat leakage.
- (c) If a mechanical joint leaks at column 1 pressure, decrease to column 2 pressure and verify no leakage.
- (2) If minor repairs have been accomplished, test as in step b.(1) of this Note, but to column 2 requirements. If test to column 2 requirements is not possible, controlled assembly followed by a controlled dive in accordance with paragraph 7.4.2 of this chapter, is a satisfactory alternative to the test.
- (3) For those mechanical joints in sea connected systems where testing is not feasible, controlled assembly followed by a controlled dive in accordance with paragraph 7.4.2 a. of this chapter, is a satisfactory alternative to the test.
- c. Operational test. In addition to the hydrostatic testing required by steps a. or b. of this Note, after repairs have been completed on the valve and/or hydraulic actuator, in-place operational testing of Emergency Flood Control hydraulic components or EMBT Blow valves will be conducted by performing applicable portions of the operational Unrestricted Operation.
- d. Trash Disposal Units (TDU). The TDU is a special purpose device which requires tests beyond those normally required of hull and/or backup valves. The specific testing required for the re-certification of the TDU after maintenance must be determined from MSs or other reference documentation. A good reference to ensure adequate testing is the Index of Submarine Maintenance Engineering, Planning and Procurement (SUBMEPP) Standardized Test Procedures SSN/SSBN/SSGN Submarines.

NOTE 7: For testing work performed on portions of the sea connected systems including the joint between the hull and hull valve, tests shall be conducted for strength and porosity and mechanical joint tightness to the pressures specified on the applicable ship/class drawing. In some instances the pressures specified will not reflect those on the individual TPDs provided to the ship. For SSN 688 and SSBN/SSGN 726 Class ships, the applicable TPDs shall be used. The applicable ship/class drawings listed below should be used if TPDs are not available.

Ship/Class	Drawing	Strength	Tightness
SSN 21	830-6404016	#Item 18 plus 50 psi	Item 1
SSN 688	845-4456141	Item 3	Item 6
SSBN/SSGN 726	845-4640418	*Item 11	Item 1
SSN774	801-6984058	**Item 12	Item 18

Except for SSN23 LDT hull insert for TD-704 and 705 valve assembly which is tested to Item 1 of NAVSEA Dwg 830-6404016.

* Except valves TD-2021 and TD-2022 and associated piping which are tested to Item 2 of NAVSEA Dwg 845-4640418.

** Except valves TD-116, TD-138 and TD-554 and associated piping which are tested to Item 2 of NAVSEA Dwg 801-6984058.

Errors in any TPD should be reported to SUBMEPP via SUBMEPP Feedback Form provided as Appendix C of this chapter.

CAUTION: CRYSTALLIZATION/MELTING OF MAIN BALLAST TANK HULL STOP VALVE SEATS AND DOWNSTREAM EMBT BLOW VALVE SEATS MAY RESULT FROM RAPID PRESSURIZATION OF THE EMBT BLOW PIPING AGAINST SHUT MAIN BALLAST TANK HULL STOP VALVES.

NOTE 8: 4500 psig air system hull stop and bank stop valves will not be used as a boundary for hydrostatic test pressures greater than 4500 psig unless valve seats and software are replaced after the test and a mechanical joint tightness is performed.

NOTE 9: For repairs to the DSW system, inboard of the hull and backup valve, the column 1 test pressure is 122 psig and the column 2 test pressure is 88 psig. This is to prevent damaging the attached DSW pump.

NOTE 10: Where oxygen piping or system components are re-installed by mechanical joints, these portions of the system will be tested to 100% operating pressure using nitrogen in accordance with reference (p). System fluid (oxygen) may be used in at-sea situations when use of nitrogen is not practical. The test pressure will be held for a minimum of 15 minutes plus the time required to conduct inspection of joints under test.

NOTE 11: Refer to reference (p) for testing requirements and procedures for oxygen, nitrogen, and hydrogen systems.

NOTE 12: Before testing oxygen stop valves with Kerotest Co. cartridges in accordance with Kerotest Drawing 72594765, ensure the valve is assembled in accordance with Kerotest Instruction K-673 and that the union is torqued to 160 - 170 ft.-lbs. This is necessary to ensure the cartridge is not damaged.

CAUTION: WHEN TESTS INVOLVE NUCLEAR BOUNDARIES, REFER TO REFERENCE (h), REFERENCE (q), AND THE APPLICABLE RPM BEFORE TESTING.

NOTE 13: When packing glands, stuffing tubes, manhole covers, etc., in hull envelope boundary tanks are entered and remade, the assembled unit will be tested by conducting a 12 psig air tightness test. With 12 psig air within the tank, apply soap solution to the work area and inspect for leakage. No leakage is allowed.

NOTE 14: Escape trunk penetrations not exposed to sea pressure during normal ship operation, escape and access lower hatches, and watertight bulkhead doors require only a completion test. The completion test is a 12 psig air test with no pressure drop allowed in 10 minutes. If unable to accomplish the completion test, perform an alternate test per note 25 of this Appendix. No inspection following the controlled dive is required.

NOTE 15: Where repairs are performed on the snorkel induction or exhaust piping or valves, refer to reference (r) for test requirements.

NOTE 16: Submarine Periscope Pressure testing, evacuation/charge and dew point testing will be in accordance with reference (s).

NOTE 17: Where minor repairs have been accomplished on torpedo tubes (including attached piping) and/or impulse tanks, the applicable portion of the system will be tested by performing sub-paragraph a., b. or c. below.

NOTE: WHEN REMOVAL OF THE TORPEDO TUBE SIGHT GLASS (SSN688/SSB(G)N726 CLASS) OR LIGHT PIPE (SSN21 AND 774 CLASSES) ASSEMBLIES IS REQUIRED TO INSTALL TEST INSTRUMENTATION, REINSTALLATION OF THE SIGHT GLASS SHALL INCLUDE A VISUAL INSPECTION OF THE GLASS (CHECK FOR CHIPPING, CRACKS, ETC.) AND/OR IF THE SIGHT GLASS HAS BEEN REMOVED FOR REPAIRS (LEAKS, BROKEN GLASS, STRIPPED THREADS, ETC.), TESTING SHALL BE ACCOMPLISHED PER SUB-PARAGRAPH b. BELOW.

- a. "J" pressure hydrostatic test pierside.
- b. Controlled assembly of components exposed to sea pressure, completion test and a water tight integrity test.

NOTE: DUE TO HIGH IN-SERVICE ALLOWABLE LEAKAGE RATES FOR AIR TURBINE PUMPS, TIGHTNESS TEST MAY NOT BE POSSIBLE. IT IS PERMISSIBLE TO UTILIZE THE AIR TURBINE PUMP INFLATABLE SEAL TO AID WITH TESTING. IF THE AIR TURBINE PUMP TEST IS STILL NOT ACHIEVABLE, A MAJOR DFS MUST BE SUBMITTED FOR FAILED TESTING.

NOTE: FOR SUBMARINES EQUIPPED WITH AIR TURBINE EJECTION PUMPS (SS(G)BN726 CLASS, SSN21 AND 774 CLASS), THERE IS AN ALLOWABLE LEAKAGE RATE (FRESH WATER OR SEAWATER) PAST THE TURBINE PUMP MECHANICAL SEALS. MAXIMUM ALLOWED LEAKAGE RATE FOR NEW AND RESTORED TURBINE PUMPS IS 55 CC/HOUR. MAXIMUM ALLOWED LEAKAGE RATE FOR IN-SERVICE TURBINE PUMPS IS 5 GALLONS/MINUTE.

- (1) For Torpedo Tubes and piping: The affected joints shall be assembled as a controlled assembly and subjected to a 12 psig air tightness test for 10 minutes. Accomplish a soap bubble test of the affected joints. In addition, a minor DFS will be used to document requirement for inspections during a controlled dive in order to verify re-establishment of the watertight integrity for those repaired joints.

- (2) If air soap test is impractical, or if the affected joint is inaccessible: The affected joints shall be assembled as a controlled assembly and subjected to a drop test by pressurizing to 12 psig air. Allow time for pressure/temperature to stabilize. Hold for 10 minutes. No drop allowed. In addition, a minor DFS will be used to document the requirement for inspections during controlled dive in order to verify re-establishment of the watertight integrity for those repaired joints.
- c. For Impulse Tank: The affected joints shall be assembled as a controlled assembly and subjected to a drop test by pressurizing to 12 psig air. Allow time for pressure/temperature to stabilize, hold for 10 minutes. No drop allowed. In addition, a minor DFS will be used to document requirement for inspections during a controlled dive in order to verify re-establishment of the watertight integrity for those repaired joints.
- (1) When drop test is conducted in drydock, record the highest pressure held. Minimum pressure shall be 5 psig. No drop allowed. Repeat at 12 psig when waterborne.
 - (2) In lieu of drop test, the affected joints shall be assembled as a controlled assembly and the tank subjected to a 12 psig air tightness test for 10 minutes. Accomplish a soap bubble test of the affected joints. In addition, a minor DFS will be used to document requirement for inspections during controlled dive in order to verify re-establishment of the watertight integrity for those repaired joints.

CAUTION: WHEN PERFORMING TESTING OF TANKS, COMPLY WITH REFERENCE (q), SECTIONS 50 THROUGH 54.

NOTE 18: NAVSEA drawing 126-5792666 provides the detailed requirements and guidance for tank testing.

NOTE 19: DELETED

NOTE 20: Signal ejectors/launchers are special purpose devices, which require tests beyond those normally required of hull and/or backup valves. The specific testing required for the re-certification of signal ejector or launcher after maintenance must be determined from ship's plans and/or other reference documentation. A good reference to ensure adequate testing is the Index of SUBMEPP Standardized Test Procedures SSN/SSBN/SSGN Submarines.

NOTE 21: Upper escape and access hatches (including missile tube muzzle hatches on SSBN/SSGN Class Submarines) and escape trunk penetrations exposed to sea pressure during normal ship operation require a completion test and a controlled dive to test depth. The completion test is a 12 psig air test conducted per Note 25 of this Appendix for 10 minutes. In addition, a minor DFS will be used to document the requirement to inspect for leakage by opening the escape trunk drain at depths for hull valve cycling in accordance with NAVSEA Instruction C9094.2B to verify re-establishment of the watertight integrity for the repaired items.

NOTE 22: Bulkhead penetration hole covers will be tested using the air hose test alternative of Note 25, step c. of this appendix. Upon successful completion of the air hose test, document test on a QA Form 17 and submit to the ship's Quality Assurance Officer. A DFS is not required.

CAUTION: CARE MUST BE EXERCISED WHEN HYDRAULIC OIL IS USED AS A TEST LIQUID TO PREVENT SPRAY OR LEAKAGE FROM BECOMING A FIRE OR CONTAMINATION HAZARD.

NOTE 23: Where shop pre-tested hydraulic system components or hydraulic system piping are reinstalled by mechanical joints, those portions will be tested to column 2 requirements using hydraulic oil as the test fluid.

NOTE 24: For maintenance involving a system or component monitored under the Unrestricted Operation Maintenance Requirement Card program, partial or full performance of in-periodicity operational Unrestricted Operation Maintenance Requirement Cards may be required as a retest. Consult NAVSEA 0924-062-0010, Submarine Safety Requirements Manual, Section 6.4.5 for additional information. Perform applicable portions of Unrestricted Operation-Maintenance Requirement Card 025. For "O" and "T" level activities, when a component in the Emergency Flood Control System is disturbed, the retest shall consist of testing the entire Emergency Flood Control System, e.g., if a component in the Engine Room was disturbed, a retest of the entire Engine Room is required. If a component in the Forward Emergency Control System is disturbed, a retest of the entire Emergency Flood Control System in the Forward compartment is required.

NOTE: NAVSEA DRAWING 126-5792666 ALSO CONTAINS INFORMATION REGARDING TESTING OF SUBMARINE TANKS AND COMPARTMENTS.

NOTE 25: Hull Glands (e.g., cable stuffing tubes, shaft/mast packing glands, electrical/electronic hull fittings excluding the inboard packing assembly and pressure proof caps screwed onto EHF cable connection). Hull glands require a completion test (12 psig compartment test) and an acceptance/structural watertight integrity test (where the joint is exposed to full submergence depth pressure). If the structural watertight integrity test will be accomplished by performing a controlled dive to test depth, the work is required to be accomplished using a controlled assembly, and a minor DFS for the controlled deep dive is required. The affected joints will be inspected during the first controlled dive. Performance of alternate completion tests are acceptable in lieu of a 12 psi compartment test and do not require a DFS. In the event that a 12 psig compartment test or an alternate completion test cannot be accomplished and the structural watertight integrity test will be accomplished by performing a controlled dive to test depth, the work is required to be accomplished using a controlled assembly and a major DFS for the controlled deep dive is required. The affected joints will be inspected during the first controlled dive. If required, perform one of the following alternate completion test methods when a 12 psi compartment test is not scheduled or practical.

a. Cofferdam Test Method.

- (1) A pressure cofferdam can be used to verify the tightness of hull or bulkhead patches or components after re-installation where it is physically possible to cover the item. A simple cofferdam can be constructed from six inch diameter or larger pipe with length determined by item to be tested. One end of the pipe is capped and the other fitted with a suitable gasket to provide a seal. Sufficient pipe threaded penetrations should be provided for air supply, gauge, and relief valve fittings.
- (2) Cofferdam tests, used in lieu of 12 psig compartment air tests, will be performed as follows:
 - (a) Install the cofferdam over joint/fittings to be tested so that the pressure differential will be in the same direction as a full compartment or tank test. Secure the cofferdam by use of shores and wedges or hydraulic jacks braced against sound structure. Attach air supply and non-isolable gauge and relief valves.
 - (b) Pressurize the air space inside the cofferdam to the test pressure specified for the test of the applicable tank or compartment, as shown in the ship's test drawing.
 - (c) Apply a soapy solution to the opposite side of the structure and inspect for leakage.
 - (d) Acceptance criteria for cofferdam tests will be no evidence of leakage.
 - (e) Where the opposite side of the structure is inaccessible, an alternate method of providing tightness is to measure the drop in pressure within the cofferdam over a ten minute period. The gasket and fittings in the cofferdam should be checked for leakage using a soapy solution.
 - (f) Acceptance criteria for this alternate cofferdam test will be no drop in pressure.

b. Vacuum Box Test Method.

- (1) A vacuum box can be used to test the same items tested by the cofferdam method. However, since the pressure differential is now in the opposition direction, it may be used in many locations where a cofferdam is not suitable. Several portable vacuum pumps capable of pulling a vacuum in a small displacement test vessel are commercially available. An air eductor can be used to pull a vacuum for testing penetrations through the deck over a submarine battery space.
- (2) Vacuum box tests used in lieu of 12 psig compartment air tests, will be performed as follows:
 - (a) Apply a soapy solution to the joint to be tested.
 - (b) Install the vacuum box over the joint or fitting to be tested so that the pressure differential will be in the same direction as a full compartment or tank test.

CAUTION: PROVIDE SUPPORT FOR THE VACUUM BOX WHERE A CHANGE IN THE INTERNAL PRESSURE COULD CAUSE THE BOX TO FALL.

- (c) Draw a vacuum to obtain a pressure differential comparable to the test pressure specified in the ship's test drawings.
- (d) Inspect the joint or fitting for leakage by observing through the Plexiglas cover of the vacuum box for the formation of bubbles which would indicate leakage.
- (e) Acceptance criteria for vacuum box tests will be no evidence of leakage.
- (f) An alternate test method of proving tightness with the vacuum box is to measure the rise in pressure within the vacuum box over a ten minute period.

NOTE: A SOAPY SOLUTION SHOULD BE APPLIED TO THE GASKET, COVER, AND FITTINGS INSIDE THE VACUUM BOX. FORMATION OF BUBBLES ON THE INTERIOR OF THE VACUUM BOX INDICATES A LEAK IN THE BOX.

- (g) Acceptance criteria for this alternate vacuum box test will be no rise in pressure.

c. Air Hose Test Method.

- (1) An air hose test may be used to verify the tightness of piping or electrical penetrations directly accessible on both sides of the bulkhead or pressure hull for observation. Extreme caution will be used when this method is used to test periscopes, hydraulic control rods or other movable cylinders that penetrate bulkheads or the pressure hull due to the possibility of blowing abrasive material into the seals. Also, ensure that openings exist to prevent ambient pressure buildup.
- (2) Air hose tests will be performed as follows:
 - (a) The air hose nozzle shall be about 3/8 inch in diameter and the pressure at the nozzle shall be about 90 psig.
 - (b) Apply a soapy solution to the structure on the side opposite from the side the stream of air is to be applied. Communications are to be established to ensure air hose nozzle position and soap test are being accomplished at the same location (i.e., top, bottom, port, starboard).

WARNING: HIGH VELOCITY AIR IS A PERSONNEL HAZARD. ALL NON-ESSENTIAL PERSONNEL WILL BE CLEARED FROM THE AREA BEING TESTED. SAFETY GLASSES WILL BE WORN AT ALL TIMES. CARE MUST BE TAKEN SO THAT THE AIR STREAM IS NOT DIRECTED TOWARD ANY PERSONNEL.

- (c) The air hose shall be located so as to produce a pressure differential in the same direction as would occur if a full compartment or tank test were performed. Hold the nozzle as close as possible, within two inches, if possible, to the joint/fitting under test and direct the air stream in the manner most likely to reveal leakage. The test shall be accomplished for a minimum of 30 to 45 seconds on each quadrant/area.
- (d) Inspect the soapy solution for the formation of bubbles during the test, which would indicate leakage.
- (e) Acceptance criteria for air hose tests will be no evidence of leakage.

d. Pressurized Water Testing Method for Submarine Main Propulsion Shaft Primary Seals (Shaft Seal Cavity Testing in advance of Controlled Deep Dive).

- (1) Conduct pressurized water testing of the shaft seal cavity following assembly of any seal repaired in accordance with applicable tech manual or maintenance standard.
- (2) If no pressurized water test procedure is available,
 - (a) Pressurize the repaired shaft seal cavity with fresh water to 100 (95 to 105) psig.
 - (b) Measure leakage rate past the affected seal into the ship. Allowable leakage is 16 oz/minute maximum. Test pressure must be held for 30 minutes minimum.

- NOTE 26: For steering and diving penetrations (and other hull V-Ring packing installations including associated o-rings), perform a controlled assembly and initiate a minor DFS to document the requirement for inspections during a controlled dive to test depth in order to verify re-establishment of the watertight integrity for those joints.
- NOTE 27: Removable Logistics Escape Trunks and Logistics Plug Trunks require an inter seal tightness test and a controlled dive to test depth. The inter seal tightness test will be accomplished using air or nitrogen to 100% test depth pressure with no pressure drop allowed in 10 minutes. In addition, immediately following the first controlled dive to test depth, enter the trunk and remove the cleanliness cap from the drain/test connection and verify no leakage has occurred. A minor DFS will be used to document the requirement to inspect for leakage immediately following the dive to verify re-establishment of the watertight integrity for the reinstalled trunk.
- NOTE 28: The Sonar Sphere requires a completion test and a controlled dive to test depth. The completion test is a 12 psig air test with no pressure drop allowed in 10 minutes. If unable to accomplish the completion test, perform an alternate test per note 25 of this Appendix. In addition, immediately following the first controlled dive to test depth, enter the sonar sphere and inspect for evidence of leakage. A minor DFS will be used to document the requirement to inspect for leakage immediately following the dive to verify re-establishment of the watertight integrity.
- NOTE 29: Electrical/electronic hull fitting pressure proof caps manufactured in accordance with MIL-C-24231/12, 13 or 14 are not Level I or boundaries within the SUBSAFE Systems and do not require REC or testing when installed or operated.
- NOTE 30: For preventative maintenance (e.g., PMS) to inspect and replace seawater heat exchanger pencil and disc type zinc anodes closed with an o-ring threaded plug with a nominal diameter of 1-5/8" or less (outside of a major availability) accomplished without additional testing, the following conditions must be met:
- a. Work will be performed using a CWP within the SUBSAFE boundary and a Formal Work Package when performing work outside the SUBSAFE boundary.
 - b. The joint will be assembled as a controlled assembly and documented on QA form 34.
 - c. Complete a surfaced condition maximum operating pressure test with zero leakage for 5 minutes. Operate seawater pumps at maximum speed without causing cavitations or violating operating procedure restrictions.
 - d. List "SURFACED" as the actual pressure on QA forms.
 - e. No new pressure boundary parts are installed (excluding software).
 - f. No testing is required for other maintenance or repair (e.g., ASW valve repairs) which would subject the zinc anode area to at least mechanical joint tightness pressure.

CAUTION: APPLYING POWER TO ANTENNA CONTROL CABLES OR TRANSMITTING ON RADIO FREQUENCY CABLES THAT HAVE NOT HAD THE ELECTRICAL CHECKS COMPLETED CAN SIGNIFICANTLY DAMAGE EQUIPMENT/COMPONENTS. IF THE APPROPRIATE ELECTRICAL CHECKS CANNOT BE COMPLETED, CONSIDERATION OF AN EQUIPMENT TAG-OUT MAY BE APPROPRIATE.

- NOTE 31: Submarine SubHDR and Photonics systems outboard cable removal and replacement.
- a. Insert plugs with new O-ring each time the cable is unplugged and assemble using a controlled assembly. The QA form 34 is required to be retained until the availability is complete or if accomplished outside of an availability, the QA form 34 will be retained until the package is closed and reviewed by the Quality Assurance Officer.
 - b. After performing a deep dive, passive and/or pre-energize testing shall be performed in accordance with the system specific Technical Manual, SUBMEPP approved Maintenance Standard, SUBMEPP approved Standard Test Procedure or Maintenance Requirement Card to ensure the system is not grounded prior to use.

- c. Controlled Assembly Process used for Re-Entry Control (REC) Exceptions or Exception to Retest Requirements for Mechanical Joints consists of:
 - (1) Verification that surface finishes of gasket/O-ring sealing surfaces are in accordance with applicable specifications.
 - (2) Verification that fastener material and installation is in accordance with applicable specifications.
 - (3) Verification that gaskets/O-rings are properly installed and in accordance with applicable specifications.
 - (4) Assembly is documented on a Quality Assurance (QA) form 34.
 - (5) Inspected by a Quality Assurance Inspector (QAI) or Quality Assurance Supervisor (QAS).

NOTE 32: A partial salvage inspection shall be accomplished in accordance with Volume IV, Chapter 18 of this manual for any item worked during an availability (i.e., hatches, salvage air valves, etc.).

NOTE 33: Repairs of SSGN Class Lockout Chamber and SSN 774 Class Lockout trunks and hatches within the certified Scope of Certification boundary require an 89 psig completion test. Minor repairs, in addition to an 89 psi completion test, require a minor DFS for a controlled dive to test depth to certify structural watertight integrity. Major repairs require a hydrostatic test at "H" pressure or an 89 psi completion test and a major DFS to perform a controlled dive to test depth to certify structural watertight integrity. Hydrostatic testing at "H" pressure satisfies all mechanical joint testing requirements for minor repairs.

NOTE 34: Specific repair and acceptance criteria for submarine water tight doors and hatches is defined in the following SUBMEPP Maintenance Standards:

- a. 1000-081-774
- b. 1000-081-726
- c. 1000-081-688
- d. 1000-081-021

NOTE 35: Post installation testing shall be conducted in accordance with the applicable SUBMEPP Maintenance Standard or Combat System Test Procedure. Post deep dive testing shall be accomplished in accordance with the applicable Combat System Test Procedure or Maintenance Requirement Card. For transducer or hydrophone replacements for spherical arrays (excluding SSBNs), a dental chart, or equivalent test, performed in accordance with the applicable technical manual or Maintenance Requirement Card shall be performed prior to getting underway.

APPENDIX C

SUBMEPP PRODUCT FEEDBACK			
FROM: SUBMEPP ACTIVITY PO BOX 2500 PORTSMOUTH NAVAL SHIPYARD PORTSMOUTH NH 03804-2500		DATE:	
		AUTHORIZED ACTION: <input type="checkbox"/> FINAL RESOLUTION <input type="checkbox"/> REFERRAL <input type="checkbox"/> INTERIM SOLUTION	
TO:			
PRODUCT: <input type="checkbox"/> TPD			
TITLE OR		NO:	
SYSTEM:			
ORIGINATOR INFORMATION:			
NAME:		CODE/SHOP:	
EMAIL:		CLASS/HULL:	
ACTIVITY:		ORIGINATOR TRACKING NO:	
SUBMEPP P.O.C.		SUBMITTAL DATE:	
<input type="checkbox"/> ACTUAL NEED DATE: 			
<i>Impact to activity if date not met</i>			
PROBLEM/RECOMMENDED SOLUTION:			
SUBMEPP FINAL SOLUTION:			
REMARKS:			

APPENDIX C (Cont'd)

SUBMEPP TECH P. O. C.:	CODE: 18	PHONE: (207) 438-
PROGRAM MANAGER:	CODE: 1833	PHONE: (207) 438-
COPY TO:		
CLOSEOUT: <input type="checkbox"/> RESOLUTION NOT ACCEPTABLE - RETURN TO SUBMEPP FOR FURTHER ACTION <input type="checkbox"/> REFERRAL APPROVED <input type="checkbox"/> REFERRAL ANSWERED - RETURN TO SUBMEPP FOR FURTHER ACTION ACTIVITY: SIGNATURE: DATE: PHONE:		
Originator, please complete all highlighted sections between the "PRODUCT" and the "PROBLEM/RECOMMENDED SOLUTION" Provide recommended solution whenever possible and contact SUBMEPP engineer prior to submittal if other than "Routine" Email FOR OFFICIAL USE ONLY to SUBMEPP.MIDS@navy.mil via NMCI account or to MIDS.SUBMEPP.nmpi@navy.mil via NNPI account; or FAX to (207) 438-6220. (For questions contact Cynthia Waters at (207) 438-6239 or Bob Dearborn at (207) 438-6087)		
PROBLEM/RECOMMENDED SOLUTION: (Cont'd) <div style="background-color: yellow; height: 100px; width: 100%;"></div>		
SUBMEPP FINAL SOLUTION: (Cont'd)		
REMARKS: (Cont'd)		
COPY TO: (Cont'd)		

VOLUME V**PART I****CHAPTER 8****DEPARTURE FROM SPECIFICATION****(DFS/WAIVERS/NUCLEAR LIAISON ACTION REQUEST/STEAM PLANT ACTION REQUESTS)**REFERENCES.

- (a) NAVSEAINST 5400.95 - Waterfront Engineering and Technical Authority Policy
- (b) NAVSEA 0989-LP-037-2000 - Commissioned Submarine General Reactor Plant Overhaul and Repair Specification
- (c) NAVSEA 0989-LP-043-0000 - Commissioned Surface Ship General Reactor Plant Overhaul and Repair Specification
- (d) NAVSEA 0989-LP-058-1000 - Destroyer Tender and Submarine Tender Nuclear Support Facilities Overhaul and Repair Specification
- (e) NAVSEA S9086-T4-STM-010 - NSTM Chapter 589 (Cranes)
- (f) NAVSEA T9044-AD-MAN-010 - Requirements Manual for Submarine Fly-By-Wire Ship Control Systems
- (g) NAVSEAINST C9210.4 - Changes, Repairs and Maintenance to Nuclear Powered Ships
- (h) NAVSEA SL720-AA-MAN-030 - Navy Modernization Process Management and Operations Manual (NMP-MOM)

LISTING OF APPENDICES.

- A Departure From Specification Request Message Format
- B Departure From Specification Clearance/Cancellation Report Message Format

8.1 PURPOSE. To establish standard procedures to be used by the Fleet and all maintenance activities for reporting, requesting approval and clearance, at the earliest opportunity, of all non-conforming/departable conditions, Departures from Specification (DFS).

8.1.1 Background. Specifications are engineered requirements such as type of materials, dimensional clearances, vibration levels, flow rates, and physical arrangement to which ship components are purchased, installed, tested, and maintained. All ships are designed and constructed to specific technical and physical requirements. It is imperative that every effort be made to maintain all ship systems and components to their designed specifications. There are occasions when the applicable specifications cannot be met. In these cases, the non-conformance to specifications is controlled with a DFS.

8.1.2 Terminology.

- a. A DFS is the mechanism used to document and resolve a lack of compliance with any authoritative document, plan, procedure, instruction, etc.
- b. Authorized Technical Authority. An Authorized Technical Authority is a representative designated by reference (a) to act for Naval Sea Systems Command (NAVSEA) in dispositioning non-conformance issues. They are also charged with providing technically sound maintenance alternatives to the Fleet upon which maintenance and operational decisions can be made.
- c. The terms deviation and waiver are often used synonymously. The principle difference being that deviations are requested prior to conducting work that will result in a non-conformance and waivers are requested after a non-conformance has been discovered.

8.1.3 Specification. Technical specifications originate from a variety of sources. When a conflict exists between specifications the governing requirement has to be determined on a case by case basis. The following listing is provided to assist in determining the governing specification. This listing may not be exact for a particular case and all pertinent technical documents will require review:

- a. Non-Nuclear listing of specifications which may be consulted when determining the governing specification:
 - (1) Volume V (Quality Maintenance) of the Joint Fleet Maintenance Manual.
 - (2) Fleet/Type Commander (TYCOM) Technical Notes.
 - (3) Ship's plans/drawings, NAVSEA Standard and Type drawings, and approved Technical Repair Standard or Maintenance Requirement Procedure, or Maintenance Standard.
 - (4) NAVSEA letters and Liaison Action Requests (LAR).
 - (5) The Military Standard (MIL-STD) and Military Specification (MIL-SPEC) series. MIL-SPEC for specific components being procured or manufactured, MIL-STD for specific processes being performed.
 - (6) NAVSEA approved component technical manuals.
 - (7) NAVSEA 0902-018-2010; General Overhaul Specifications for Deep Diving SSBN/SSN Submarines.
 - (8) TYCOM Instructions.
 - (9) Naval Ships' Technical Manuals and Technical Specifications.
 - (10) NAVSEA Instructions.
 - (11) NAVSEA S9AA0-AB-GOS-010; General Specifications for Overhaul of Surface Ships.

NOTE: WHERE THIS MANUAL IS MORE RESTRICTIVE THAN OTHERS, THIS MANUAL WILL TAKE PRECEDENCE UNLESS SPECIFICALLY STATED THAT IT PROVIDES GUIDANCE ONLY. UNRESOLVED QUESTIONS ON PRECEDENCE SHOULD BE REFERRED TO THE TYCOM FOR RESOLUTION. IN SOME INSTANCES A SPECIFICATION OF LESSER PRECEDENCE MAY MODIFY OR SUPERSEDE A MORE SENIOR SPECIFICATION, I.E., A NAVSEA LETTER OR LAR RESPONSE COULD SPECIFICALLY MODIFY A TECHNICAL STANDARD PENDING REVISION.

- b. Nuclear listing of specifications which may be consulted when determining the governing document:
 - (1) Reactor Plant Manual.
 - (2) Reactor plant component technical manuals.
 - (3) NAVSEA technical manuals (e.g., NAVSEA 250-1500-1 Welding Standard).
 - (4) Reference (b).
 - (5) Reactor Plant Drawings.
 - (6) NAVSEA instructions.
 - (7) TYCOM instructions.
 - (8) Reference (c).
 - (9) Reference (d).

8.2 **DEPARTURE FROM SPECIFICATION.** A DFS (non-nuclear only) is a lack of compliance with any authoritative document, plan, procedure, instruction, etc. General guidance regarding DFS is as follows:

NOTE: FOR SURFACE FORCE SHIPS AND AIRCRAFT CARRIERS, THE TYCOM WILL PERFORM THE IMMEDIATE SUPERIOR IN COMMAND (ISIC) FUNCTIONS OF THIS CHAPTER.

- a. During a maintenance action, including temporary repairs, a DFS is required for lack of compliance with cognizant documents, drawings, etc. For "as found" conditions during maintenance, the ISIC, ship and Fleet Maintenance Activity (FMA) (if involved) must evaluate the non-compliance using the guidance of paragraph 8.2.4 and 8.2.5 of this chapter.

- b. For “as found” conditions or equipment failures during operations that result in non-compliance with cognizant documents, drawings, etc., the ship and/or ISIC (if in port) must evaluate the condition or failure using the guidance of paragraph 8.2.4 and 8.2.5 of this chapter to determine if the non-conforming condition meets the criteria as a Major DFS. Non-conformances meeting the criteria as a major DFS shall be submitted to the ISIC for adjudication when in a port with a FMA and shall be approved by the Commanding Officer if at sea or in a port without an FMA. Excluding Fly-by-Wire and Scope of Certification (SOC) systems and components, if the non-conformance is determined to be minor, no DFS is required and the non-conforming condition will be entered in the ship’s Current Ship’s Maintenance Project (CSMP). If at sea, the guidance of paragraph 8.3.8 of this chapter will be followed.

8.2.1 Reporting Departures from Specification. It is incumbent upon ships, FMAs, and ISICs to discuss potential DFS as early as possible (prior to the work close out or component assembly if possible) to determine direction of actions, and alternatives to the DFS. Every effort must be made to correct each deficiency prior to equipment/system operation or underway of the ship. If a DFS has to be submitted, the request for it must be processed as soon as possible to enable a technical evaluation of the DFS request and final adjudication from the TYCOM.

8.2.2 Types of Departures from Specification. A DFS is classified as either Major or Minor depending on its significance. Major DFS are described in paragraph 8.2.4 of this chapter. Minor DFS are described in paragraph 8.2.5 of this chapter. Care must be exercised in evaluating and determining the type of DFS. All submarine DFS must be approved prior to ship’s underway for submerged operations.

8.2.3 Permanent and Temporary Approval of Departure from Specification. DFSs are approved as either permanent or temporary depending on the nature of the non-compliance and technical determination of whether the condition needs to be repaired.

- a. A temporary DFS requires subsequent action to correct the non-compliance and is approved with specific direction regarding duration and actions necessary to clear. A Major DFS accepting a temporary repair or condition is approved by the TYCOM following concurrence by an Authorized Technical Authority. A Minor DFS accepting a temporary repair will be approved by the TYCOM or ISIC as specified in paragraph 8.2.5 of this chapter.
- b. Temporary deviation/waivers initiated by the Authorized Technical Authority per reference (a) require TYCOM concurrence prior to approval.
- c. A permanent DFS requires no additional repair effort and is approved by NAVSEA. Technical Authority within NAVSEA for approval of a permanent DFS is specified in reference (a). As an exception, a permanent DFS may be approved only by the TYCOM or ISIC as specifically allowed in paragraph 8.2.5.a. of this chapter when previously approved precedent setting documentation that directly applies to the DFS exists. The specific NAVSEA precedent must be referenced in the DFS approval.

NOTE: PARAGRAPH 8.2.4 OF THIS CHAPTER DOES NOT APPLY TO THE CATEGORY OF DFSs FOR CRANES COVERED UNDER REFERENCE (e). REFERENCE (e) LISTS THE CATEGORY REQUIREMENTS AND LEVEL OF APPROVAL FOR CRANE RELATED DFSs.

NOTE: AN OUT-OF SPECIFICATION PARAMETER IN A SUBMARINE FLY-BY-WIRE SHIP CONTROL SYSTEM FUNCTION MEASURED BY URO/MRC 019 IS ALSO CONSIDERED A MAJOR NON-CONFORMANCE WHETHER OR NOT THE URO/MRC IS DUE FOR ACCOMPLISHMENT. URO MRC 019 PROVIDES THE REQUIREMENTS FOR PROCESSING URO MRC RELATED NON-CONFORMANCES.

NOTE: THE BELOW LISTING IS NOT ALL INCLUSIVE AND SITUATIONS MAY ARISE WHERE DEFICIENCIES NOT LISTED MAY BE OF SUCH A NATURE TO WARRANT A MAJOR DFS. FOR EACH DEFICIENCY DETERMINED TO DIRECTLY INVOLVE SAFETY OF SHIP, SAFETY OF PERSONNEL, OR CAUSE A REDUCTION IN THE INTEGRITY OR OPERABILITY OF EQUIPMENT ESSENTIAL TO SHIP’S MISSION, A MAJOR DFS SHALL BE ISSUED.

8.2.4 Major Departure from Specification. A major DFS is one that affects (a) performance; (b) durability; (c) reliability or maintainability; (d) interchangeability; (e) effective use or operation; (f) weight or appearance (where a factor); (g) health or safety; (h) system design parameters such as schematics, flow, pressures, or temperatures; or (i) compartment arrangements or assigned function. The following list identifies some deficient conditions which require a major DFS:

NOTE: IN SOME INSTANCES, THESE MAJOR DEPARTURES MAY SUBSEQUENTLY BE RECATEGORIZED BY THE LOCAL TECHNICAL AUTHORITY FROM MAJOR TO A MINOR IN ACCORDANCE WITH REFERENCE (a).

- a. Use of unapproved joint design or additional joints.
- b. Non-conformances to plan specifications that result in a change in configuration. Examples are:
 - (1) Non-conformances to plan specifications resulting in a change in configuration or dimensions to pressure boundary parts or components. Examples would be "as found" dimensional or clearance differences from plan requirements for a Submarine Safety (SUBSAFE) valve bonnet and no authorization (e.g., Ship Alteration, Alteration and Improvement, Engineering Change Notice or NAVSEA letter) is available.
 - (2) Non-conformances to plan specification resulting in a change in configuration considered to be a permanent repair to pressure boundary parts. An example would be replacement of a failed valve of older design with one of more recent design because valves of the older design are no longer available and no authorization (e.g., Ship Alteration, Alteration and Improvement, Engineering Change Notice, NAVSEA letter) is available.
- c. Failure to meet all applicable standards for major repairs unless other alternatives are authorized by this volume. Examples are linear indications, failed tightness test, hydrostatic test, use of unqualified welder/brazer, failed radiography, inadequate bond during brazing, etc.
- d. Pipe or component wall thickness below minimum specification without restoration. Epoxy and shim methods for ball valve repairs are not considered restorations of component wall thickness.
- e. Manufacture of a part or component without use/availability of applicable technical documentation (e.g., manufactured per sample due to non-availability of detailed drawings), regardless of whether the repair is considered temporary or permanent. A DFS is not required if the part or component is non-level and in a non-controlled system, it is fabricated from the correct material and the lack of technical documentation does not affect: performance, durability, reliability or maintainability, interchangeability, use or operation, weight or appearance (where a factor), health or safety, or system design parameters.
- f. Failure to complete required retest of a SUBSAFE/Level I/Submarine Flight Critical Component (SFCC) component or system.
- g. Leakage from a SUBSAFE/Level I hull fitting, piping system, or component as follows:
 - (1) Hull valve/fitting to hull flange leakage.
 - (2) Leakage or weepage through a component body or pipe wall. Completion of temporary repairs (e.g., plastic pipe patch) does not negate the requirement for a DFS.
 - (3) Leakage or weepage from a welded or brazed joint. Completion of temporary repairs (e.g., plastic pipe patch) does not negate the requirement for a DFS.
 - (4) Leakage upper escape and access hatches, leakage from hull glands (e.g., cable stuffing tubes, shaft/mast packing glands, electrical/electronic hull fittings excluding the inboard packing assembly and pressure proof caps screwed onto Electrical Hull Fitting cable connection) that is in excess of the allowable specification that cannot be repaired, immediately, by a packing adjustment or greasing.
- h. Installation of new pressure boundary parts which do not meet all applicable material certification requirements. The following are some departable conditions:

- (1) (Submarines only) Non-Level I valve internals (e.g., ball, disc, poppet, flapper) installed in seawater or sea-connected hull valves and backup valves.
 - (2) Non-Level I weld rod, insert material, brazing filler, etc. installed in a SUBSAFE/Level I system welded or brazed joint.
 - (3) Non-Level I pressure boundary parts (e.g., stem, bonnet, studs, nuts) installed in or on SUBSAFE or Level I components or systems.
- i. (Submarines only) For any Unrestricted Operation (URO) Maintenance Requirement Card (MRC) measured parameter found out of tolerance and not restored, whether the MRC is due or not.
 - j. (Submarines only) Failure to complete any URO MRC within required periodicity.
 - (1) Non-conformance requests that result in a change of the URO MRC inspection periodicity (not authorized by the MRC), a change in a URO MRC technical requirement, or deferral of required work require NAVSEA approval. TYCOM or Authorized Technical Authority approval is not authorized for these non-conformances.
 - (2) To support operational commitments, TYCOMs may authorize temporary periodicity extensions (not authorized by MRC) after consultation with NAVSEA 07T. The periodicity extensions should be limited to the next availability or in port period, where a submarine maintenance activity is available, and shall be documented by a major DFS. The DFS shall then be submitted to NAVSEA for approval.
 - (3) When a URO/MRC periodicity becomes due during a maintenance availability, a DFS is not required when the TYCOM/ISIC takes positive actions to restrict submerged operations. Prior to the ship conducting submerged operations, all URO/MRC requirements must be complied with or a Major DFS must be approved.
 - k. (Submarines only) For all submarine hatch (Logistics Escape Trunks, Lock Out Chambers, Logistic Plug Trunks, etc.) deficiencies which will not be repaired prior to ships underway involving the following:
 - (1) Non-operational submarine access hatch. (Upper Hatch Operability and Remote Operating Devices)
 - (2) Hatch clearance reading out of specification. (Hatch-to-Seat Clearance)
 - (3) Locking ring hatch lug alignment out of specification. (Coaming Lugs and Locking Rings)
 - (4) Locking ring hatch/trunk coaming lug metal to metal contact out of specification. (In Service Lug Engagement)
 - (5) Hatch gasket groove and hatch trunk seating surface out of specification. (Gasket and seating surface inspection)
 - l. (Submarines only) Non-operational Emergency Main Ballast Tank Blow Valve, seawater system hull or backup valve, Modified After Signal Ejector/signal ejector muzzle ball valve, salvage air valve, etc.
 - m. (Submarines only) Failure to complete any category "A" Alteration and Improvement.
 - n. (Submarines only) A fault condition or unsatisfactory test within the SFCC Boundary indicates a deficiency with a safety critical function per reference (f) and shall be classified as a Major non-conformance under the following conditions:
 - (1) When the system design employs more than two redundant SFCCs and a deficiency degrades the redundancy to only two remaining SFCCs.
 - (2) When the system design employs two redundant SFCCs or a non-redundant SFCC and a deficiency results in the loss of a SFCC.

- o. Headed fasteners locally manufactured from Level I material (i.e., capscrews, bolts, machine screws, etc.) which have not been certified by tensile and hardness testing specified in MIL-DTL-1222 (Studs, Bolts, Screws and Nuts for Applications Where a High Degree of Reliability is Required; General Specification for) or FF-S-86 (Federal Specification, Screw, Cap, Socket Head) as applicable.
- p. (Submarines only) All high pressure compressed gas flasks designed to MIL-F-22606 specifications shall be recertified at intervals not to exceed 20 years for SSN 688, SSN 21 and SSN 774 Classes and 21 years for SSBN/SSGN 726 Class. High pressure air moisture separator flasks shall be recertified at an interval not to exceed ten years for SSN 688, SSN 21, SSBN/SSGN 726 and SSN 774 Classes. All oxygen and gas management separator flasks designed to MIL-F-24032 specifications shall be recertified at an interval not to exceed nine years for SSN 688 and SSN 21 Classes and SSBN/SSGN 726 Class. A major DFS, approved by NAVSEA, is required for any flask that will exceed the recertification periodicity.
- q. (Submarines only) Propulsion shafts shall be replaced at intervals not to exceed six years for SSBN/SSGN 726 Class, seven years for SSN 688 and SSN 774 Classes and ten years for SSN 21 Class. A major DFS, approved by NAVSEA, with supporting operating information, including shaft turn count since shaft installation is required for shafts that will exceed planned replacement periodicity.

8.2.5 Minor Departure from Specification. A DFS which is not a Major DFS as defined in paragraph 8.2.4 of this chapter is considered to be a Minor DFS. All permanent Minor (and Major) DFSs will be approved by NAVSEA except those identified in paragraph 8.2.5.a. of this chapter, which may be dispositioned by the TYCOM or the ISIC. Temporary Minor DFSs identified in paragraph 8.2.5.b. of this chapter may also be dispositioned by the TYCOM or the ISIC. All other temporary Minor DFSs will be approved by the TYCOM. Paragraphs 8.2.5.a. through e. below identify some deficient conditions which require a Minor DFS:

- a. Any condition which could be considered a Major DFS except for the fact that specific and definite (TYCOM or NAVSEA) guidance is available based on documented action for another identical (same component, same application, and same class ship) request in which no restriction was imposed. An example would be a previous DFS which was approved as a precedent setting DFS.
- b. Any condition which is associated with exemptions/alternatives to non-nuclear retest requirements in Section 7.4 of Part I, Chapter 7, of this volume on testing, except where noted. Examples are:

NOTE: IF A MAINTENANCE CERTIFICATION RECORD/RE-ENTRY CONTROL IS CLOSED BY TRANSFERRING AT SEA TESTING TO A DFS (E.G., CONTROLLED DIVE TO TEST DEPTH FOR RETEST OF A PERISCOPE HULL GLAND, CONTROLLED DIVE FOR RETEST OF A SEA CONNECTED SYSTEM (E.G., MAIN SEAWATER, AUXILIARY SEAWATER) IN LIEU OF JOINT TIGHTNESS TEST TO "J" PRESSURE OF TEST PRESSURE DRAWING (TPD)), THE SHIP WILL BE RESTRICTED IN DEPTH AS REQUIRED IN PART I, CHAPTER 5, PARAGRAPH 5.6.5 OF THIS VOLUME.

- (1) (Submarines only) DFS for controlled dive following re-installation of a periscope.
- (2) (Submarines only) DFS for controlled dive following work on a hatch exposed to sea pressure.
- (3) (Submarines only) DFS for controlled dive following work on an Electrical/Electronic Hull Fitting.
- c. Associated with a temporary repair to a system or component not involving ship or personnel safety or not involving integrity or operability of equipment essential to ship's mission.
- d. For a material deficiency discovered during a maintenance action **as follows:**
 - (1) **(For Aircraft Carriers and Surface Forces) For any material deficiency discovered during a maintenance action** that will not be corrected prior to the ship's underway, and is not categorized as a Major DFS in accordance with paragraph 8.2.4 of this chapter.

- (2) (For submarines only) For any material deficiency discovered during a maintenance action that will not be corrected prior to the ship's underway, and is not categorized as a Major DFS in accordance with paragraph 8.2.4 of this chapter except "K" Coded Maintenance Requirement Cards (KMRC) that are outside the SUBSAFE boundary which will be entered into and tracked in the Ship's CSMP as well as the Performance Monitoring Team Onsite Analysis Report.
- e. (Submarines only) Material deficiencies in the SUBSAFE boundary that were discovered outside a regularly scheduled FMA upkeep (excluding voyage repair and planning availability). These deficiencies will be tracked with a CSMP entry and scheduled for repair during the next regular upkeep after the discovery of the non-conforming condition. Deferral of the repair past the next upkeep will require a Minor DFS with proper justification as to why the condition was not corrected during the upkeep and any supply information for outstanding repair parts that were not repaired during subsequent regularly scheduled availability (excluding voyage repair and planning availability).
- f. (Submarines only) A Major DFS is required to document missing or damaged Special Hull Treatment removed from external structure only when the coating system beneath the Special Hull Treatment is missing or delaminated resulting in bare metal that is not repaired. Missing or damaged Special Hull Treatment removed from external structure is to be tracked using the CSMP process as long as the remaining coating system is intact or repaired (i.e., no bare metal) when the following conditions are met:
- (1) The submarine is not currently in a Depot Level Availability.
 - (2) Temporary repairs are performed in accordance with the requirements of the class specific hull treatment repair and maintenance manual.
 - (3) The CSMP item is scheduled to be cleared no later than the next scheduled Depot Level Availability.

8.3 DEPARTURE FROM SPECIFICATION PROCEDURES.

NOTE: FOR SURFACE FORCE SHIPS AND AIRCRAFT CARRIERS, THE TYCOM WILL PERFORM THE ISIC FUNCTIONS OF THIS CHAPTER.

8.3.1 General Administrative Requirements. The following requirements pertain to all DFSs:

- a. Requests for DFS will be submitted, approved and cleared in accordance with paragraph 8.3.7 or 8.3.8 of this chapter. The Web Based Electronic Departure from Specification (eDFS) program is acceptable for use unless directed otherwise by the respective TYCOM.

NOTE: THE FORMS (QUALITY ASSURANCE (QA) FORM 12, QA FORM 12A) MENTIONED IN THE FOLLOWING DISCUSSION ARE COMPLETED ELECTRONICALLY WHEN USING eDFS.

NOTE: WHEN USING A NAVAL MESSAGE TO REQUEST A DFS OR REPORT A COMMANDING OFFICER APPROVED DFS THE EXACT FORMAT SHOWN IN APPENDIX A WILL BE USED. EACH PARAGRAPH IN THE NAVAL MESSAGE WILL HAVE A PARAGRAPH NUMBER, THE PARAGRAPH TITLE AND A COLON. ANY DEVIATION IN THE FORMAT MAY CAUSE A PROBLEM WITH THE AUTOMATIC DFS PROCESSOR. IF THE SHIP IS UNABLE TO CONNECT TO EDfs, A DEPARTURE MAY BE REQUESTED BY NAVAL MESSAGE USING THE FORMAT OF APPENDIX A.

- b. Requests for DFS will be normally submitted on a QA form 12. The approval of the DFS will normally be made on the QA form 12. If unable to use QA form 12, use the message format of Appendix A. Surface ships that are not able to generate a DFS using eDFS have the option of generating DFS per existing message based system or Command E-mail. The Command E-mail shall be approved by the ship's Commanding Officer or his designated representative.
- c. The ship is responsible for all approved DFS relating to its systems/components until cleared or canceled. When a DFS is approved as a temporary repair requiring rework to correct the discrepancy, a CSMP entry for correction of the discrepant condition will be initiated by the ship or ISIC. The ship's Quality Assurance Officer (QAO) will ensure that this action is done. Verify an active Job Control

Number (JCN) exists for all active temporary DFSs at the completion of all scheduled Fleet maintenance activity availabilities, major or minor, Chief of Naval Operations availabilities or at least quarterly and maintain an auditable record of the verification until superseded.

- d. The ISIC is responsible for all DFSs which have been approved or forwarded to TYCOM for approval until the DFS is cleared, canceled or formally transferred to another TYCOM. The ISIC is also responsible for ensuring that the CSMP entry is annotated on the DFS for temporary repairs.
- e. All DFS must be reported and controlled. Each activity must have an auditable system for reporting and controlling DFS. Deviation/waivers will be retained and tracked in an auditable fashion within the DFS system by Ship's Force and the ISIC/TYCOM until permanent documentation is confirmed to reflect the specific non-compliance. Use of the Web Based eDFS program will facilitate meeting these requirements.
- f. When work performed results in a DFS and requires future action (e.g., re-inspection, repair), the ship will submit an OPNAV 4790/2K (or equivalent) with a new Job Sequence Number. The CSMP Job Sequence Number will be included in Block 17 of the DFS. This Job Sequence Number will be added to the DFS prior to submission to the ISIC. The DFS or waiver will be retained in an auditable fashion with the DFS file. DFSs and waivers written exclusively to transfer accountability for testing do not require an OPNAV 4790/2K (or equivalent) with a new Job Sequence Number.
- g. To preclude last minute ship's operational delays, DFS should be processed as early as possible. Any request for approval for a DFS must contain all pertinent information on materials, processes, testing and procedures used, so that a complete and educated engineering evaluation can be made by the TYCOM, Local Technical Authority or System Command.
 - (1) (Carriers and Surface Force Ships) DFS serial numbers for Ship's Force initiated departures will be automatically supplied by eDFS (0000 series). For departures initiated by a depot level activity, the serial numbers will be automatically supplied by eDFS (1000 series). All outstanding departures must be submitted to the TYCOM for evaluation by a Local Technical Authority prior to a ship's underway. However, if the Local Technical Authority evaluation is not complete prior to the underway, the ship is responsible to ensure adequate temporary precautions and/or standing orders are in effect until the DFS evaluation is complete. For temporary departures expiring during an underway, as discussed in paragraph 8.3.9 of this chapter, the extension request shall be made sufficiently in advance to allow the evaluation process to be completed before the expiration date and preferably prior to the underway in which the DFS expires.
 - (2) (Submarines only) DFS serial numbers will be issued from the Ship's Force hand written log and entered into the ship's eDFS stand alone program (and delivered to ISIC in either electronic or hard copy format). DFS serial numbers for work performed by NAVSEA managed activities, to include Public and Private shipyards and/or activities directed by TYCOM, shall use 1000 series DFS numbers auto initiated by the eDFS software.
- h. The activity originally requesting the DFS will track the DFS until it is approved/disapproved.
- i. For any DFS, Non-Conformance, deviation or waiver that has been adjudicated, the approving activity is required to provide a copy of the DFS, Non-Conformance, deviation or waiver to the ship's QAO for retention and tracking per paragraph 8.3.1e. of this chapter.
- j. (Submarines only) All departures shall be adjudicated prior to the ship getting underway for submerged operations.

8.3.2 Review of Outstanding Departures from Specification. Commands responsible for tracking approved DFS will review them prior to each upkeep to establish FMA/shipyard work requirements to clear the DFS. DFSs should be cleared as soon as possible based on:

- a. Approval as a permanent repair.
- b. Condition has been corrected.
- c. Condition is no longer applicable as a result of an alteration.

- d. Condition is no longer applicable as a result of a change in the specification that originally resulted in the DFS request.

8.3.3 Clearing of Departure from Specification by Exposing Sea Connected Systems and Hull Integrity Boundary Items to Submergence Pressure (Submarines only). SUBSAFE certified submarines will submerge to 95% of design test depth, as a minimum, as measured to the keel, for clearing certain "Controlled Dive" DFSs. Satisfactory completion of the test and clearance of the DFS will be in the format of QA form 12A. If unable to use QA form 12A, use message format of Appendix B.

8.3.4 Incorporation of Departure from Specification in Selected Record Drawings/Data or Technical Variance Documentation.

- a. Those DFSs for a change in configuration which NAVSEA accepts as a permanent repair will be maintained in an auditable file by the ship and the ISIC until reflected in ship's selected record drawings/data or technical variance documentation. Examples are:
 - (1) An oversized shaft and bushing.
 - (2) A seal welded mechanical joint.
 - (3) Addition of piping joints or fittings.
 - (4) Different style/type valve.
- b. The activity submitting the DFS for permanent approval will inform the ship of the configuration change and provide sufficient data to support submission of Ship's Configuration Change Report (OPNAV 4790/CK) and a Fleet COSAL Feedback Report (NAVSUP 1371).
- c. For DFS approved as a permanent repair for material/component substitution resulting in a configuration change, the ship will submit a Ship's Configuration Change Report (OPNAV 4790/CK) and a Fleet COSAL Feedback Report (NAVSUP 1371) to ensure accurate configuration accounting and technical/supply support are maintained.
- d. The activity causing or discovering the non-conformance/departable condition that the DFS approved as a permanent repair, and affects selected drawings and records, will provide a copy of the marked up drawing to Ship's Force prior to underway and will forward a copy of the applicable portions of the work package and a marked up copy of the affected drawing or record to the planning yard as soon as practical. The ship and accomplishing activity will maintain a copy of the correspondence until the technical variance documentation or selected record drawing is issued.

8.3.5 Preparations for Correction of Departure from Specification and Clearance During Depot Level Availabilities. The following procedures will be used to schedule DFS for correction and report correction of DFS in depot level availabilities:

- a. Ship's Force and/or the parent ISIC will provide copies of DFS outstanding at the Availability Planning Conferences for incorporation into the work package as required by the Availability Baseline Work Package.
- b. DFS deferred to a Depot Availability for correction must be cleared by the submission of a QA form 12A as the shipyard accomplishes the work or upon completion of shipyard period, provided that the shipyard "scope of work" corrected the DFS. Completion reports from shipyards are not required. These forms are submitted by Ship's Force to the ISIC. If unable to use a QA form 12A, use the message format of Appendix B.

8.3.6 Numbering of Departures from Specification. All DFSs will be identified by a unique sequential number issued by the affected ship. The sequential number will consist of the ship's designation and hull number, a hyphen, the sequential number portion, a hyphen, and the last two digits of the year (e.g., SSN 674-13-90, CVN 70-30-94). DFSs already assigned a number under another numbering system will be retained, as there is no intent to revise the numbers already used. DFSs established using the Web Based eDFS program will use the numbering conventions of those systems. Approved temporary departures requiring extension will not be assigned new Departure numbers.

8.3.7 Submission and Approval of Departures from Specification. The activity finding or causing a DFS will normally report the DFS to the appropriate approval authority using either a QA form 12, a naval message or electronically using the eDFS program. The DFS Request will be completed in accordance with the instructions. If unable to use QA form 12 or the electronic web based programs, use the naval message request format of Appendix A.

NOTE: IN THE FOLLOWING SECTION, IF USING eDFS, WHEN IT IS DIRECTED THAT THE QA FORM 12 IS SIGNED, AN ELECTRONIC SIGNATURE IS IMPLIED. ISIC AND UNITS ASSIGNED TO TYCOMs UTILIZING THE eDFS SYSTEM WILL SUBMIT DFSs TO THE TYCOM VIA THE eDFS PROGRAM. THIS PROGRAM REQUIRES A USER IDENTIFICATION AND PASSWORD SUPPLIED BY THE TYCOM. THE FOLLOWING PROCESSES WILL BE EXECUTED UNDER THE eDFS PROGRAM USING THE ELECTRONIC VERSION OF THE QA FORM 12 AND QA FORM 12A. THE SIGNATURES WILL BE ONLY THE PRINTED NAME AND TITLE OF THE INDIVIDUAL. SHIPS WITHOUT UNCLASSIFIED INTERNET ACCESS MAY SUBMIT DFSs AND DFS CLEARANCES TO THE ISIC VIA A MANUALLY PREPARED QA FORM 12/QA FORM 12A, THE STAND-ALONE MS ACCESS DATABASE FORMAT OR MESSAGE FORMAT IF AT SEA.

- a. The Work Center Supervisor/Leading Petty Officer/Craftsman/Quality Assurance Inspector will fill out the applicable portion of the QA form 12, ensuring the extent of the DFS and the recommendation for repair/re-certification must be clearly and completely stated, and deliver, after review by the cognizant division officer, to:
 - (1) For ship initiated DFS, the Ship's QAO or in his/her absence the Ship's Duty Officer.
 - (2) For FMA initiated DFS, the FMA QAO or in his/her absence the FMA Repair Duty Officer.
- b. The QAO or designated representative will:
 - (1) Review the QA form 12 for technical adequacy, accuracy, and completeness.
 - (2) Determine the latest time the answer must be received in order to carry out the ship's schedule, obtain and enter the next consecutive number from the affected ship's DFS log. For aircraft carriers, the numbering convention assigned by the Web Based eDFS program when submitting the DFS will be used.
 - (3) Deliver/forward to Department Head (ship)/Repair Officer (FMA).
- c. For ship initiated DFS, Ship Department Head (in his/her absence Ship's Duty Officer) will:
 - (1) Review the QA form 12 for technical adequacy, accuracy, and completeness.
 - (2) Sign the QA form 12 and deliver/forward to the cognizant ISIC QAO (in his/her absence ISIC Duty Officer).
- d. For FMA initiated DFS, FMA Repair Officer (in his/her absence his/her designated representative) will:
 - (1) Review the QA form 12 for technical adequacy, accuracy, and completeness.
 - (2) Sign the QA form 12 and deliver/forward it to the cognizant ISIC QAO (in his/her absence ISIC Duty Officer).
- e. For Depot initiated temporary waivers and deviations, responsible Depot personnel will:
 - (1) Review the waiver or deviation for technical accuracy, adequacy, and completeness.
 - (2) Utilize, prepare and sign a QA form 12 or eDFS to document, attach the QA form 12 to the waiver or deviation and deliver/forward it to the cognizant ISIC representative QAO (in his/her absence the ISIC Duty Officer) for review and concurrence prior to approval. For a DFS initiated by a depot level activity, the ISIC will provide the JCN and the DFS serial number to the depot level activity when requested. For carrier repair activities, eDFS will automatically supply the next open DFS serial number. See paragraph 8.3.1g.(1) of this chapter for carriers and surface force ships and paragraph 8.3.1g.(2) of this chapter for submarines for a description of the current process for assigning DFS serial numbers.

- (3) The ISIC representative QAO will review and concur with the waiver or deviation by signing the ISIC block of the QA form 12 or electronically signing in eDFS prior to Depot approval and return the waiver or deviation to the Depot. For temporary waivers and deviations, the ISIC representative will contact the Ship's Maintenance Planner or the Ship's QAO for a JCN and a Departure serial number (if required) prior to returning the waiver or deviation to the Depot.
- f. The cognizant ISIC QAO (in his/her absence his/her designated representative) will:
 - (1) Review the QA form 12 for technical adequacy, accuracy, and completeness.
 - (2) Issue instructions regarding clearance and approve/disapprove and return QA form 12 to the Department Head (Ship)/Repair Officer (FMA) for action and/or filing in QA files.
 - (3) Deployed Ships ISICs will ensure parent ISIC is an information addressee on all QA form 12s.
- g. Approval/disapproval of a DFS by the TYCOM or NAVSEA will be noted on the QA form 12.
- h. Upon completion of corrective action, the DFS will be cleared by the ship using the format of QA form 12A. The TYCOM will be informed by copy of QA form 12A or via message, when a major temporary DFS is cleared. The NAVSEA or TYCOM approval of a permanent repair requires no further administrative action.

NOTE: DO NOT DELETE ANY INFORMATION FROM AN eDFS ITEM THAT HAS RECEIVED TEMPORARY APPROVAL FROM EITHER THE ISIC, TYCOM OR AUTHORIZED TECHNICAL AUTHORITY.

NOTE: THE ABILITY TO ADD COMMENTS TO AN APPROVED DFS IS LIMITED BY THE ELECTRONIC SYSTEM'S ASSIGNED LEVEL OF ACCESS (I.E., ISICs CAN ADD COMMENTS ONLY TO THE ISIC PORTION OF THE DFS FORM).

8.3.8 Departure from Specification Approval and Reporting for Ships While at Sea or at a Port Without a Fleet Maintenance Activity.

8.3.8.1 Evaluation. The Commanding Officer will evaluate any DFS and approve the corrective action to be taken including any necessary restrictions. The Commanding Officer will issue directions regarding clearance and approve/disapprove the DFS and return the QA form 12 to the Department Head for action and/or filing. For any Commanding Officer approved DFS, a report of the condition and intended action will be made at the first opportunity to the ship's ISIC/TYCOM utilizing either a naval message in the "EXACT" format of Appendix A or the eDFS program.

8.3.8.2 Condition not Corrected. If the condition is not planned to be corrected or cannot be corrected during the next inport period (a port with a fleet maintenance facility), the Commanding Officer approved DFSs must be submitted to the applicable approval authority for adjudication prior to getting underway.

- a. (Submarines only) All departures shall be adjudicated prior to the ship getting underway.
- b. (Aircraft Carriers and Surface Force Ships only) In the event the DFS evaluation is not completed prior to the ship's underway, the Commanding Officer approved DFS will remain in effect until the evaluation is completed and disposition provided.

NOTE: AN EXTENDED DEPARTURE WILL NOT BE ASSIGNED A NEW DEPARTURE NUMBER THAT CANCELS AND/OR SUPERSEDES THE ORIGINAL DEPARTURE NUMBER.

8.3.9 Extending a Temporary Departure. In the event that a departed condition will not be corrected by the expiration date, the Ship's QAO is responsible to submit the departure(s) to the ISIC requesting an extension. The extension request will explain why the departure will not be corrected. The extension request shall be made sufficiently in advance to allow the evaluation process to be completed before the expiration date. The Departure extension will be routed to the same level of approval authority as the original Departure.

- a. Non-conformances are expected to expire. It is acceptable for non-conformances to expire while the ship or Deep Submergence System (DSS)/SOC asset is in a scheduled availability.

- b. (Submarines/DSS/SOC assets only) Expired non-conformances must be adjudicated prior to at sea operation and/or prior to manned use for DSS/SOC systems/assets.
- c. Extension requests via the eDFS program shall be accomplished using the Request Extension feature accessed by clicking the associated button at the top of the QA form 12 for the most recent approved active DFS extension. Changes to an existing non-conformance in the eDFS program that do not affect the expiration date shall be accomplished by submittal of an "UPDATE" as directed in paragraph 8.3.10.c of this chapter.

8.3.10 Electronic Non-Conformance Administration.

- a. User access requires TYCOM or initiating agencies Point Of Contact (POC) approval for all levels of access.
- b. All attachments to the electronic non-conformances are preferred to be in Adobe Acrobat PDF format. If another format is used, ensure it is one that is readily available on government computers, such as Microsoft Word or Excel format. Non-conformances with attachments that cannot be opened by the ISIC or TYCOM will be rejected.
- c. Changes to an existing electronic non-conformance is normally accomplished by submittal of an "UPDATE" to the QA form 12.
 - (1) To enter changes, the initiator of the change will enter the current calendar date and the word "UPDATE": in the user's comment block followed by the relevant information and ending the comments with the user Name, Rank (if applicable) and Title. Do not write over any existing comments, Names or dates in the comment block.
 - (2) Changes or Updates shall be disseminated via an e-mail alert.
 - (3) Deletion of QA form 12s will not be supported. Clear or cancel QA form 12s with a QA form 12A.
- d. Naval Sea Logistics Center (NAVSEALOGCEN) assistance is required to change an archived non-conformance. NAVSEALOGCEN will use the following process to change an electronic non-conformance:
 - (1) Database non-conformance changes (change to a QA form 12) will only be accomplished if requested by the TYCOM or the initiating agencies POC.
 - (2) Archived non-conformances requiring changes which were signed by multiple TYCOMS and/or multiple initiating agencies:
 - (a) Requires e-mail concurrence of all POC signatory users to the non-conformance prior to NAVSEALOGCEN making database changes or unarchiving the non-conformance (i.e., Supervisor of Shipbuilding/TYCOM/NAVSEA signed QA form 12).
 - (b) If a non-conformance is unarchived to allow TYCOMs or agency users to make changes, change will be accomplished in accordance with the requirement cited in paragraph 8.3.10.c. above.
 - (c) Each signatory level user should indicate their concurrence to the change in accordance with the requirement cited in paragraph 8.3.10.c. above.
 - (3) Archived non-conformances requiring change which were signed by a single TYCOM and/or single initiating agency:
 - (a) Requires e-mail concurrence of the POC signatory user to the non-conformance prior to NAVSEALOGCEN making database changes or unarchiving the non-conformance (i.e., Supervisor of Shipbuilding/TYCOM/NAVSEA signed QA form 12).
 - (b) If a non-conformance is unarchived to allow a TYCOM or agency user to make changes, change will be accomplished in accordance with the requirement cited in paragraph 8.3.10.c. above.

8.4 NUCLEAR COGNIZANT AREAS. Request for DFS for nuclear systems will be neither requested nor approved. If a ship or FMA has a question, problem, or is unable to comply with nuclear specifications, request for technical resolution will be made using a LAR. Formal resolution of the LAR is required prior to reactor plant or propulsion plant startup.

8.4.1 Nuclear Powered Surface Ships. A memorandum of agreement exists between NAVSEA Nuclear Propulsion Directorate (08) and NAVSEA PMS 312/335 that details the division of responsibilities within the propulsion plants of nuclear powered ships. This may be useful to Forces Afloat as an aid in directing inquiries and correspondence and has been distributed to all nuclear surface ships as a NAVSEA letter Ser 08J/C90-5873, dated 7 AUG 90.

8.4.2 Reactor Plant Systems. If a nuclear powered ship or nuclear capable FMA is unable to comply with specifications for reactor plant systems or components listed in enclosure (1) to reference (g) and also those systems identified as nuclear by the appropriate nuclear/non-nuclear interface diagram (references (b) and (c)), then a review of NAVSEA 08 requirements shall be requested. In general, technical resolution to questions or problems for reactor plant systems or components requires use of a liaison inquiry according to the requirements of references (b) and (c).

- a. References (b) and (c) provide the requirements on submission of LARs for nuclear powered surface ships and submarines.

NOTE: LARs SUBMITTED MUST CONTAIN ALL INFORMATION REQUIRED BY REFERENCE (b) AND REFERENCE (c) TO ENSURE A RAPID, ACCURATE RESPONSE.

- b. Reference (d) provides the requirements on submissions of LARs for nuclear support facilities.
- c. A LAR should not be submitted for cases of out of specification seat leakage of nuclear valves after repairs. The Reactor Plant Planning Yard and Reactor Plant Prime Contractors do not have the authority to waive valve leakage specifications. When valve seat leakage exceeds reactor plant manual specification after attempted Ship's Force/FMA repairs, the following method may be used to defer rework and close out the Controlled Work Package (CWP):

NOTE: THIS ALTERNATIVE TO SATISFACTORY COMPLETION OF RETEST IS APPLICABLE ONLY TO VALVE SEAT LEAKAGE.

- (1) The ship must inform TYCOM (via squadron/group for submarines) by message with an info copy to NAVSEA 08. The message must include a description of the initial problem, repairs conducted, seat leakage rate, leak specification, dates of next availability, status of paragraphs (2) through (5) below, and request for authorization to continue operation with out-of-specification seat leakage.
- (2) All hydrostatic and tightness test requirements must be satisfactorily completed.
- (3) All other portions of the CWP must be properly completed.
- (4) A new maintenance deferred action must be submitted to the ISIC for repair of the valve seat leakage at the next FMA availability.
- (5) The valve seat leakage must not constitute an operational problem (for submarines, Group/Squadron's determination and justification statement required).
- (6) Based on Ship's justification statement, TYCOM will respond by message to all concerned regarding deferral of corrective maintenance. After satisfactory final review, close-out of the CWP can be made with an approved deferral of corrective maintenance in lieu of a satisfactory seat leakage test.
- d. A liaison action file, with a sequential index and containing all submitted Nuclear LARs, shall be maintained by the originating activity. The file shall contain a copy of LARs submitted. A copy of the liaison action shall be kept with liaison requests in the Answered LARs section and in the CWP/Formal Work Package if applicable.
- e. Request for DFS for nuclear systems will be neither requested nor approved. If a ship, FMA or shipyard has a question, problem or is unable to comply with nuclear specifications, request for technical resolution will be made using an LAR or Trouble Record.

8.4.3 Propulsion Plant Systems (Aircraft Carriers only). If a ship or FMA has a question, problem or is unable to comply with non-nuclear specifications, technical assistance is available from the Propulsion Plant Engineering Activity (PPEA). The PPEA was formed to provide an additional technical resource for assisting operational aircraft carriers with technical or operational issues not associated with Ship Alteration installation and configuration control. PPEA Liaison services are requested using the Steam Plant Action Request (SPAR). The SPAR allows the Fleet and overhaul activities to submit requests to the PPEA for technical assistance on non-Ship Alteration related issues; the SPAR is not intended to replace the LAR process described above or non-nuclear LARs submitted to the Hull Planning Yard in accordance with reference (h). The PPEA can request information, disseminate technical information associated with the Steam Plant to the Fleet/overhaul activities, or direct work that does not require a drawing change or affect system configuration control using the Steam Plant Liaison Inquiry. Procedures for preparing SPARs are discussed in reference (c).

APPENDIX A**DEPARTURE FROM SPECIFICATION REQUEST MESSAGE FORMAT**

RTTUZYUW RUCBSRF0001 DDHHMM-UUUU--RUCBSUU.
 ZNR UUUUU
 R DDHHMMZ MMM YY ZYB
 FM (COMMAND REQUESTING DFS)//
 TO ISIC/TYCOM// (NOTE 1)
 NAVSEALOGCEN MECHANICSBURG PA//
 INFO COMNAVSEASYS COM WASHINGTON DC// (NOTE 2 and 3)
 ISIC//
 COGNIZANT IMA//
 SHIP//
 SUBMEPP PORTSMOUTH NH//(URO PROGRAM MANAGER)// (NOTE 4)
 PEO CARRIERS (AS APPLICABLE FOR CARRIERS)//
 PEO THEATER SURFACE COMBATANTS (AS APPLICABLE FOR COMBATANTS)//
 PEO EXW (AS APPLICABLE FOR AUXILIARIES, LITTORALS AND PATROL CRAFT)//
 PEO MUW (AS APPLICABLE FOR MINE WARFARE)//
 NAVSPECWARCOM (WHEN DDS IS INSTALLED)//
 BT
 UNCLAS (OR CLAS)//N04855//
 MSGID/GENADMIN/ (COMMAND REQUESTING DFS)/0000/FEB//
 SUBJ/DFS REQUEST FOR (SHIP AND HULL NUMBER AND DEPARTURE NUMBER ASSOCIATED WITH
 (COMPONENT/SHORT DESCRIPTION))/(NOTE 5)//
 OR FOR A CO APPROVED DEPARTURE
 NOTIFICATION OF COMMANDING OFFICER APPROVED DFS (SHIP AND HULL NUMBER AND
 DEPARTURE NUMBER ASSOCIATED WITH (COMPONENT/SHORT DESCRIPTION))/(NOTE 5)//
 REF/A/DOC/COMUSFLTFORCOMINST 4790.3// (NOTE 6)
 POC//
 AMPN/REF A IS THE JOINT FLEET MAINTENANCE MANUAL// (NOTE 7)
 NARR//(NOTE 7)
 RMKS/1. DFS NUMBER:
 2. SHIP & HULL NUMBER:
 3. JCN:
 4. CWP NUMBER:
 5. DATE OF DFS:
 6. ORIGINATOR:
 7. DEPARTURE TYPE
 A. MAJOR:
 B. MINOR:
 C. SUBSAFE:
 D. SOC:
 E. FBW:
 F. SFCC:
 8. DEPARTURE CLASSIFICATION
 A. DEVIATION:
 B. WAIVER:
 C. FBWDR:
 9. SYSTEM/COMPONENT/LOCATION/ESWBS:
 10. NAVSEA DRAWING/PLAN NUMBER/PIECE NUMBER:
 11. REFERENCES:
 12. APPLICABLE SPECIFICATIONS:
 13. SITUATION/DEGREE OF NON-COMPLIANCE: (NOTES 8, 9 AND 10)
 14. COMMENTS/RECOMMENDATION:
 15. DATE ANSWER REQUESTED BY:

16. SUBMITTING ACTIVITY:

17. NEW JCN:

18. CO APPROVED DFS:

DECL: ODAR//

BT

NOTE: ENSURE MESSAGES ARE IN ACCORDANCE WITH CURRENT MESSAGE FORMAT AND CURRENT PLAIN LANGUAGE ADDRESS DIRECTORY (PLAD) IS UTILIZED.

NNNN

NOTES:

1. Office codes for TYCOMs are: COMNAVAIRLANT N43/N9; COMNAVAIRPAC N434; COMNAVSURFLANT N434; COMNAVSURFPAC N434; COMNAVSURFLANT/AIRLANT SNPMTT N02NB; COMNAVSURFPAC N434 AND COMNAVAIRPAC N9/N434; PACIFIC FLEET CVNs – COMNAVAIRPAC N9/N434; COMNAVSURFLANT N434 AND COMNAVAIRLANT N9/N43; ATLANTIC FLEET CVNs - COMNAVAIRLANT N9/N43; COMSUBLANT N4322; COMSUBPAC N4, N4322.
2. Office codes for NAVSEA are: PMS 392 and SEA 07TC (All SSN and SSBN/SSGN); PMS 399 (DEEPSUBM and DDS); OOC (DDS and DLSS). For URO related DFS, also include the appropriate NAVSEA codes listed in the URO MRC.
3. Include NAVSEA 07Q for informational purposes on all SUBSAFE DFS messages. Include the applicable Program Manager at NAVSEA for informational purposes on all SOC DFS messages. Include the NAVSEA 07T for informational purposes on all Fly-By-Wire Ship Control System (FBW SCS) DFS messages.
4. Include SUBMEPP only on URO related DFS.
5. Comply with current annotation/declassification requirements for classified messages.
6. Year/Month/Day.
7. Enter date of most current revision.
8. When non-approved parts are used, identify part by NSN, Mil Spec, drawing and piece number and MIC level.
9. When DFS is the result of part non-availability, identify APL and NSN or drawing and piece number and state that the part is not available until (year, month, day) or unknown.
10. Where new welded or brazed pipe joints are added, state the welding or brazing procedure used. State the NDT procedure(s) used (if applicable). State completed, or to be completed tests.

INSTRUCTIONS:

1. From Line - Command requesting/submitting the DFS.
2. To Line - List the respective ISIC/TYCOM and NAVSEALOGCEN Mechanicsburg PA. (see note 1)
3. Info Line - Any additional activities that should receive a copy of this DFS message. (see notes 2, 3 and 4)
4. Subject Line - Must include one of the following:

For a standard DFS request, the subject line will start out with:

DFS REQUEST FOR (SHIP'S NAME AND HULL NUMBER, THE DEPARTURE NUMBER ASSOCIATED WITH THE REQUEST, THE COMPONENT AND/OR SHORT DESCRIPTION)

For a notification of a CO approved DFS the subject line will start out with:

NOTIFICATION OF COMMANDING OFFICER APPROVED DFS (SHIP'S NAME AND HULL NUMBER, THE DEPARTURE NUMBER ASSOCIATED WITH THE NOTIFICATION, THE COMPONENT AND/OR SHORT DESCRIPTION)

5. Reference Line - List all required references. (see note 6)
6. AMPN Line - Used if only one reference is listed. (see note 7)
7. NARR Line - Used if there are 2 or more references listed. (see note 7)
8. RMKS Section - Must be completed exactly as follows:

NOTE: THE COLONS MUST BE INSERTED EXACTLY AS SHOWN.

RMKS/1. DFS NUMBER: (enter the next sequential DFS number from the ship's DFS log. Note, this number may be changed during the input process due to previously entered departures that were entered prior to receipt of this message)

2. SHIP & HULL NUMBER: *(enter the ship's name and hull number)*

3. JCN: *(enter JCN of task that resulted in a discrepant condition or the lack of compliance)*

4. CWP NUMBER: *(enter the CWP serial number if a CWP was used or mark N/A if no CWP used)*

5. DATE OF DFS: *(enter the date the DFS was initiated)*

6. ORIGINATOR: *(name of person initiating the DFS)*

7. DEPARTURE TYPE *(at least one item under departure type will be YES. For submarines a yes will be entered by SUBSAFE, SOC, FBW and SFCC as needed)*

A. MAJOR: *(enter either YES or leave blank)*

B. MINOR: *(enter either YES or leave blank)*

C. SUBSAFE: *(enter either YES or leave blank)*

D. SOC: *(enter either YES or leave blank)*

E. FBW: *(enter either YES or leave blank)*

F. SFCC: *(enter either YES or leave blank)*

8. DEPARTURE CLASSIFICATION *(either DEVIATION or WAIVER will have a YES after it. FBWDR will be followed by YES if applicable for submarines)*

A. DEVIATION: *(enter either YES or leave blank)*

B. WAIVER: *(enter either YES or leave blank)*

C. FBWDR: *(enter either YES or leave blank)*

9. SYSTEM/COMPONENT/LOCATION/ESWBS: *(enter the system/component affected, location and ESWBS if known)*

10. NAVSEA DRAWING/PLAN NUMBER/PIECE NUMBER: *(enter the NAVSEA drawing number, plan number and piece number)*

11. REFERENCES: *(enter applicable references)*

12. APPLICABLE SPECIFICATIONS: *(enter the applicable specifications citing the reference from block 11 above. Be descriptive and specific. Enter the reference that provided the specification. This block should fully explain the specifications and include the Job Identification Number or part applicable (e.g., perform "J" pressure test to test pressure depth after mechanical assembly of joints "XXXX" in which software was replaced). This block must be explicit, so that no reference is required to the work procedure to understand the specifications.)*

13. SITUATION/DEGREE OF NON-COMPLIANCE: *(enter what the actual condition is. (enter qualitative/quantitative deviation description from block 12 including variations based on ship's*

conditions.) Sketches, drawings, QA forms, etc., may be attached, if they clarify the description of the non-conforming condition.)

14. COMMENTS/RECOMMENDATION: *(enter justification, course of action, tests conducted, affected systems, ECD (if known))*

15. DATE ANSWER REQUESTED BY: *(MMDDYYYY enter the month, day and year that an answer to the DFS request is required by. For a Notification of a CO Approved DFS leave blank, no date is required)*

16. SUBMITTING ACTIVITY: *(enter the name of the activity submitting the departure)*

17. NEW JCN: *(enter the JCN that will be used to correct the non-compliance or discrepant condition)*

18. CO APPROVED DFS: *(enter either YES (if this is a Notification of a CO Approved DFS) or leave blank)*

APPENDIX B**DEPARTURE FROM SPECIFICATION CLEARANCE/CANCELLATION REPORT MESSAGE
FORMAT**

RTTUZYUW RUCBSRF0001 DDHHMM-UUUU--RUCBSUU.
 ZNR UUUUU
 R DDHHMMZ MMM YY ZYB
 FM (COMMAND REQUESTING DFS CLEARANCE/CANCELLATION)
 TO ISIC/TYCOM//(NOTE 1)
 INFO COMNAVSEASYS COM WASHINGTON DC//(NOTE 2)
 ISIC//
 COGNIZANT IMA//
 SHIP//
 SUBMEPP PORTSMOUTH NH//(URO PROGRAM MANAGER)/(NOTE 3)
 PEO CARRIERS (AS APPLICABLE FOR CARRIERS)//
 PEO THEATER SURFACE COMBATANTS (AS APPLICABLE FOR COMBATANTS)//
 PEO EXW (AS APPLICABLE FOR AUXILIARIES, LITTORALS AND PATROL CRAFT)//
 PEO MUW (AS APPLICABLE FOR MINE WARFARE)//
 NAVSPECWARCOM (WHEN DDS IS INSTALLED)//
 BT
 UNCLAS (OR CLAS)/N04855//
 MSGID/GENADMIN/(REQUESTING COMMAND)/0000/FEB//
 SUBJ/MAJOR DFS (TYCOM NUMBER) FOR (COMPONENT/SHORT DESCRIPTION) ON (SHIP AND HULL NUMBER)/DFS
 NUMBER/(NOTE 4)/(*)//
 REF/A/DOC/COMUSFLTFORCOMINST 4790.3/(NOTE 5)
 REF/B/GENADMIN/ORIGINATOR OF DFS/DTG//
 REF/C/GENADMIN/ORIGINATOR OF DFS APPROVAL/DTG//
 REF/D/GENADMIN/-/DTG// (USE AS APPROPRIATE)
 POC//
 AMPN/REF A IS THE JOINT FLEET MAINTENANCE MANUAL//(NOTE 6)
 RMKS/ 1. PER REF A REQUEST THE FOLLOWING DFS BE CLEARED FOR USS <SHIP NAME/HULL NO>:

DFS NO.	DESCRIPTION	JUSTIFICATION
766-012-02	DSW-5	DEEP DIVE SAT
766-013-02	STBD IMPULSE TK	DEEP DIVE SAT

 2. CLEAR(CANCEL) SUBJECT DFS. REFS A, B, C AND D REFER.//
 DECL: ODAR//
 BT

NOTE: ENSURE MESSAGES ARE IN ACCORDANCE WITH CURRENT MESSAGE FORMAT AND
 CURRENT PLAD IS UTILIZED.

NOTES

- Office codes for TYCOMs are: COMNAV A IRLANT N43/N9; COMNAV A IRLANT N43;
 COMNAV SURFLANT N434; COMNAV SURFPAC N434; COMNAV SURFLANT/A IRLANT SNPMTT N02NB;
 COMNAV SURFPAC N434 AND COMNAV A IRLANT N9/N432N; PACIFIC FLEET CVNs - COMNAV A IRLANT
 N9/N432N/N432; COMNAV SURFLANT N434 AND COMNAV A IRLANT N9/N43; ATLANTIC FLEET CVNs -
 COMNAV A IRLANT N9/N43; COMSUBLANT N4322; COMSUBPAC N4, N4322.
- Office codes for NAVSEA are: SEA 07TC (All SSN and SSBN/SSGN); PMS 399 (DEEPSUBM and DDS);
 OOC (DDS and DLSS). For URO related DFS, also include the appropriate NAVSEA codes listed in the URO
 MRC. Include the NAVSEA 07T for informational purposes on all Fly-By-Wire Ship Control System (FBW SCS)
 DFS messages.

3. Include SUBMEPP only on URO related DFS.
 4. Subject line should be identical to subject line of TYCOM approval message.
 5. Year/Month/Day.
 6. Enter date of most current revision.
- (*) Comply with current annotation/declassification requirements for classified messages.

VOLUME V**PART I****CHAPTER 9****AUDITS, SURVEILLANCE, EVALUATIONS AND ASSESSMENTS**REFERENCES.

- (a) NAVSEA ST700-AM-GYD-010 - Metrology and Calibration (METCAL) Laboratory Requirements and Certification Guide
- (b) NAVAIR 17-35QAL-15 - Naval Aircraft Carrier and Amphibious Assault Ships Metrology and Calibration (METCAL) Program Manual
- (c) OPNAVINST 3120.33 - Submarine Extended Operating Cycle (SEOC) Program
- (d) NAVSEA T9044-AD-MAN-010 - Requirements Manual for Submarine Fly-By-Wire Ship Control Systems

LISTING OF APPENDICES.

- A Vertical Audits
- B Horizontal Audits
- C Surveillances
- D Submarine Quality Assurance Assessment Evaluation Criteria
- E Quality Assurance Audit/Assessments/Surveillance Discrepancy Form

9.1 PURPOSE. Provide requirements, procedures, and criteria for audits, surveillance, evaluations and assessments of the Fleet Quality Assurance (QA) Program.

9.2 GENERAL. Command evaluation is necessary in order to ensure that positive and effective corrective actions are determined and taken in any deficient areas. Audit, surveillance, evaluation and assessment programs are objective and constructive evaluations of the quality, effectiveness and efficiency with which repairs are being accomplished. The purpose of these programs is to determine the activity's compliance with established directives and to serve as tools to reduce rework, improve efficiency and produce permanent improvement in operational readiness. The internal audit and surveillance program must be flexible and dynamic. Specific grooming, concentrating on any recent problems, should be done on a regular basis to increase the benefit of the audit or surveillance. Infrequent repair efforts, components which have repetitive failures, first time repair efforts or time critical work are excellent examples of the types of jobs where extra monitoring could prove most beneficial. Guides used should lend themselves to evaluate recent command or division issues. Involvement of the highest levels of the command is essential to a highly effective program. QA form 14 can be a valuable tool to accomplish the tracking of corrective actions.

9.2.1 Audits. Audits are an internal systematic comparison of records and requirements to ensure compliance with technical and administrative requirements. Different types of audits may be performed depending on the area to be audited and the purpose of the audit. The audit categories are as follows:

- a. Vertical Audit. These audits review all aspects of one repair/maintenance action. They track the system/component task from start to finish. This is done by verifying all aspects of the technical, material, process and documentation requirements associated with the work. These audits include attributes covering the entire spectrum of the task (e.g., training and qualification of personnel, technical and production requirements, cleanliness, material control). Appendix A provides guidelines for the preparation and conduct of vertical audits.
- b. Horizontal Audit. These audits are conducted on only one specific area or aspect of the QA program (e.g., Re-Entry Control (REC), welding, training, qualification, and testing). They focus on the particular area and do not track a job from start to finish. Appendix B provides guidelines for preparation and conduct of horizontal audits.

9.2.2 Surveillance. Surveillance involves observation of actual work in progress or specific areas of concern. Appendix C provides general guidance for the preparation and conduct of a surveillance.

9.2.3 Evaluation. Evaluations provide the Commanding Officer with an internal review of the overall adequacy and effectiveness of the QA program.

9.2.4 Assessments. Assessments are an external programmatic review of processes to ensure compliance with parent directives. Assessments are normally conducted by the Command's Immediate Superior In Command (ISIC) with participation of other commands, as determined by the ISIC.

9.2.5 Key Elements. Fleet Activities will use, as a minimum, the following key elements to assure the effectiveness of their audit/surveillance program.

- a. Conduct training on techniques for preparation, execution and the evaluation of findings prior to conducting an audit or surveillance for the first time.
- b. Development and use of attribute sheets/guides. These should be based on key attributes from the source documents and are not meant to limit the scope of the review.
- c. Selective use of QA form 14. QA form 14 is an effective tool to document and track those deficiencies that require further investigation and programmatic evaluation. Deficiencies that are minor in nature, or that do not indicate a weak area in the ship's/Fleet Maintenance Activity's (FMA) QA program, should be documented in the audit or surveillance conducted along with corrective action taken.

NOTE: CORRECTION OF SOME DEFICIENCIES ASSOCIATED WITH THE AUDITS OF RECORDS FOR CONTROLLED WORK MAY RESULT IN REWORK.

- d. Develop a thorough review process focusing on audit/surveillance deficiencies to identify adverse trends and recurring deficiencies.

9.2.6 Record Retention. The retention of records for audits and surveillance will be in accordance with Part I, Chapter 10 of this volume.

9.3 RESPONSIBILITIES AND PROCEDURES.

9.3.1 Ship's Force Audits, Surveillance and Evaluation Program.

- a. Ship's Force personnel will conduct internal QA Audit and Surveillance as scheduled by the Quality Assurance Officer (QAO) as part of the ship's overall monitoring program. This program should focus on in-process controlled work and shall use the guidance of Appendices A, B and C. QA form 14 should be used to document and track those deficiencies that require further investigation and programmatic evaluation. Minor deficiencies which do not affect certification of a component or system or the nature of the finding does not warrant specific follow up action, may be entered into a deficiency-tracking system for trend analysis and/or corrected without causal analysis or long-term corrective action unless recurring in nature.
- b. Ship's Force will schedule and conduct the following audits:
 - (1) Annual audits to be conducted:
 - (a) Material control.
 - (b) QA Audit and Surveillance program.
 - (c) QA and welder training and qualification programs.
 - (d) QA records and record retention.
 - (e) Departure from Specification (DFS).
 - (f) Cleanliness controls to include:
 - 1 Training and qualification.
 - 2 Local directives.
 - (g) Technical documentation availability and controls.

- (h) Shipboard calibration facilities.
 - (i) (Submarines only) Submarine Safety (SUBSAFE)/REC, Fly-By-Wire (FBW) and Scope of Certification (SOC) program compliance.
 - (j) (Submarines only) Unrestricted Operation (URO) Maintenance Requirement Card (MRC) Program.
- (2) Perform a closeout audit.
 - (a) Perform a closeout vertical audit of all Controlled Work Packages (CWP) on a quarterly basis, except RECs, when not in a Chief of Naval Operations availability.
 - (b) Perform a post closeout audit of all RECs within 60 days following availability completion or within 60 days of work completion if work was not accomplished in availability.
 - (3) Written audit guides shall be used for each audit. The QAO will develop audit guides for all audits. The audit guides should be tailored and customized for the specific organization or area being audited. One successful technique is to acquire a collection of audit findings from previous audits or other ships and incorporate these into the audit guides.
 - (4) All audits should be conducted on an annual basis unless a shorter period is specified. Those areas identified as weak should be audited more frequently. The periodicity of these audits shall be adjusted by the QAO based upon the results of previous audits/surveillance.
 - (5) Maintain an auditable record of the most current Job Control Number to DFS verification.
- c. Administer an aggressive QA surveillance program to ensure compliance with all QA requirements and to support work process improvements. The surveillance program must include the following elements:
 - (1) Surveillance of in-process work of all types.
 - (2) Surveillance of shipboard calibration facilities.
 - d. Report results of all audits and Surveillances to the Commanding Officer with copies to the Executive Officer and cognizant Department Head/Division Officer.
 - e. Annually the ship's QAO will evaluate the effectiveness of the QA Audit and Surveillance program. This reviews the results of the internal Audit and Surveillance program to identify trends or areas requiring additional monitoring. It should also review external inspections/monitoring deficiencies to determine if immediate and permanent corrective actions have been effective or if additional surveillance is required in a specific area.

9.3.2 Fleet Maintenance Activity Audit, Surveillance and Evaluation Program.

- a. FMAs will schedule and conduct the following audits:
 - (1) Annual audits to be conducted:
 - (a) Material control.
 - (b) QA audit and surveillance program.
 - (c) QA, NDT, and brazer/welder training and qualification.
 - (d) QA records and record retention.
 - (e) Cleanliness controls to include:
 - 1 Training and qualification.
 - 2 Local directives.
 - 3 Facilities such as permanent oxygen clean work areas, oxygen clean material storage areas and special clean/cleaning rooms (except for oxygen clean instrument room).

- (f) Technical documentation availability and controls.
 - (g) Test equipment (mechanical, electrical and electronic) control, issue, receipt and maintenance.
 - (h) Audits of calibration facilities in accordance with references (a) and (b).
 - (i) (Submarine repairs only) Submarine Safety (SUBSAFE)/REC, SOC and FBW program compliance.
- (2) Perform a post closeout audit of all CWP's.
 - (a) Perform a post closeout audit of all CWP's quarterly except RECs.
 - (b) Perform a post closeout audit of all RECs within 60 days following availability completion.
 - (3) Written audit guides shall be used for each audit. The FMA will develop audit guides for all audits. The audit guides should be tailored and customized for the specific organization or area being audited. One successful technique is to acquire a collection of audit findings from other FMAs and incorporate these into the audit guides.
 - (4) All audits should be conducted on an annual basis unless a shorter period is specified. Those areas identified as weak should be audited more frequently. The periodicity of these audits shall be adjusted by the QAO based upon the results of previous audits/surveillance.
 - (5) Report results of all audits to the Commanding Officer with copies to the Repair Officer (Planning Officer at TRIDENT Refit Facilities) and cognizant Department Head/Division Officer.
- b. Administer an aggressive FMA QA surveillance program to ensure compliance with requirements and to support FMA work process improvements. The surveillance program must include the following elements:
 - (1) Surveillance of in-process work of all types.
 - (2) Surveillance of calibration facilities in accordance with references (a) and (b).
 - c. Evaluations. The FMA QAO will conduct a semi-annual evaluation of the overall adequacy and effectiveness of the FMA's QA program.
 - (1) This evaluation should include the following areas:
 - (a) Findings of the annual internal audits.
 - (b) Results of the FMA's internal surveillance program.
 - (c) An evaluation of trends identified by the FMA QA audit and surveillance programs. Areas requiring additional monitoring should be identified.
 - (d) A review of external inspections/monitoring deficiencies (ISIC, Radiological Controls Practices Evaluation and Naval Reactors Representative's Office surveillance) that relate to the FMA QA program or QA records.
 - (e) The previous semi-annual evaluation to determine the effectiveness of corrective actions.
 - (f) Review of the last FMA assessment to check for recurring deficiencies and effectiveness of corrective action.
 - (2) Results of this evaluation will be provided to the Repair Officer, Department Head (Planning Officer at TRIDENT Refit Facilities) and Commanding Officer.

9.3.3 Immediate Superiors in Command Assessments, Audits, and Surveillance.

- a. QA Program Assessment.

- (1) ISICs shall schedule and conduct a QA Program assessment in conjunction with the Fleet Readiness Training Plan (or as determined by each Type Commander (TYCOM)) of all assigned ships. This assessment will review the following areas:
 - (a) Vertical audit of CWPs.
 - (b) Material control.
 - (c) DFS.
 - (d) Audits and surveillances (to include QA-14 Binder).
 - (e) Welder qualification and training.
 - (f) QA records and record retention.
 - (g) (Submarines only) SUBSAFE/REC, SOC and FBW program.
 - (h) (Submarines only) URO MRC Program.
 - (2) (Submarines only) Assessments will be evaluated using the criteria provided in Appendix D. Electronic copies of the assessment reports will be forwarded to the TYCOM. Submission of the assessment may be via email with appropriate cover letter.
 - (3) (Surface Force Ships) Copies of the assessment reports will be forwarded to the TYCOM noting completion of assessment as satisfactory with findings documenting corrective action taken or proposed corrective action or corrective action required to be taken by the TYCOM or higher authority.
- b. ISICs will conduct the following additional periodic audits and surveillance:
- (1) Conduct periodic monitoring of Ship's Force controlled work and QA program on all assigned ships during maintenance periods.
 - (a) Perform at least one surveillance during each refit/upkeep/FMA availability.
 - (b) Conduct monitoring during industrial availabilities.
 - (2) Conduct monitoring of assigned FMA's QA. This monitoring will include:
 - (a) Review of work procedures including opening and closing practices.
 - (b) Monitoring of in progress work both on tended ships and in FMA work centers.
- c. (Submarines only) Additional ISIC Requirements.
- (1) On completion of a Selected Restricted Availability (SRA), Pre-Inactivation Restricted Availability (PIRA), Major Maintenance Period (MMP), Extended Refit Period (ERP), **Docking Phased Maintenance Availability (DPMA)** or Interim Drydocking (IDD), the ISIC will conduct an audit to include the following:
 - (a) Conduct a 100% audit of CWPs for SUBSAFE work accomplished by Forces Afloat (FMA and Ship's Force).
 - (b) Conduct an audit of UROs assigned to Forces Afloat (Ship's Force and the FMA) by the Availability Work Package (AWP) and ensure all URO MRCs have been satisfactorily completed and documented within the required periodicity. Verify that all URO MRC items coming due within six months of availability completion are complete or assigned to a follow-on fleet availability. ISICs are not responsible for auditing UROs assigned to the depot in the AWP.
 - (c) Conduct a review of all outstanding Forces Afloat DFSs.

NOTE: UPON COMPLETION, PROVIDE THE SHIP'S COMMANDING OFFICER AND THE FMA COMMANDING OFFICER A COPY OF THE RESULTS FROM THE REVIEWS CONDUCTED IN ACCORDANCE WITH PARAGRAPH 9.3.3 OF THIS CHAPTER AND IDENTIFY ANY DEFICIENCY THAT MUST BE CORRECTED/RESOLVED PRIOR TO UNDERWAY. REPORT SIGNIFICANT DEFICIENCIES TO THE TYCOM.

- (2) For submarines scheduled to and undergoing a Post Shakedown Availability (PSA), Depot Modernization Period (DMP), Extended Docking Selected Restricted Availability (EDSRA), Engineered Overhaul (EOH), Engineered Refueling Overhaul (ERO), Refueling Overhaul (RFOH) or Regular or Refueling Overhaul (ROH), the following audits will be performed:
 - (a) Vertical audits of all Forces Afloat (including FMA) CWP's done since commencement of the PSA, DMP, EDSRA, EOH, ERO, RFOH or ROH prior to cold operations and prior to Fast Cruise. CWP's audited for cold operations do not have to be re-audited for Fast Cruise. These audits must be done sufficiently early to avoid impact on the PSA, DMP, EDSRA, ERO, EOH, RFOH or ROH schedule. If deemed necessary by the ISIC or based on the amount of Forces Afloat work, the ISIC may conduct vertical audits prior to other Key Events (e.g., hot operations, criticality, undocking).
 - (b) Prior to commencement of Fast Cruise for the PSA, DMP, EDSRA, EOH, ERO, RFOH or ROH conduct an audit of the following:
 - 1 Conduct an audit of UROs assigned to Forces Afloat (Ship's Force and the FMA) by the AWP and ensure all URO MRCs have been satisfactorily completed and documented within the required periodicity. Verify that all URO MRC items coming due within six months of availability completion are complete or assigned to a follow-on fleet availability. ISICs are not responsible for auditing UROs assigned to the depot in the AWP.
 - 2 All outstanding Forces Afloat DFS.
 - 3 Verify any non-conformance of a temporary nature has been correctly resolved per Part I, Chapter 8 of this volume.
- (3) The ISIC will perform a Submarine Operating Cycle Extension Assessment of each submarine in accordance with reference (c) when required by TYCOM.

NOTE: THE ISIC IS ONLY RESPONSIBLE TO AUDIT FBW WORK PERFORMED BY FORCES AFLOAT/TYCOM MANAGED ACTIVITIES.

- (4) Conduct a 100% audit if Upgrades/Alterations or Major Repair Work of the FBW system were performed. Use the FBW message reporting process for certification specified in Volume II, Part I, Chapter 3 of this manual for availabilities of less than six months duration.

9.3.4 Type Commander Assessments. TYCOM QA Assessments of ISICs, where applicable, and submarine maintenance FMAs will be conducted annually, not to exceed 18 months. Assessments by TYCOMs will be accomplished concurrently with FMA assessments, explained in Volume IV, Chapter 2 of this manual, when scheduled in the same calendar year. Assessments will include review of the following areas:

- a. Level I, Submarine Flight Critical Components per reference (d) and nuclear work (i.e., CWP's).
- b. Material identification and control including procurement, receipt inspection, marking, storage, issuing, and in-process use.
- c. Qualification and training of QA personnel.
- d. Metal fabrication including welding, brazing, NDT, qualification, and processes.
- e. DFS program.
- f. Cleanliness program.
- g. Audit and surveillance program.

- h. QA records and record retention.
- i. Effectiveness of corrective actions for previous audit findings.
- j. (Submarines only) SUBSAFE/REC, SOC and FBW program compliance.
- k. (Submarines only) URO MRC program.

9.4 REPORTING AUDIT, SURVEILLANCE AND ASSESSMENT RESULTS AND CORRECTIVE ACTION.

NOTE: WHEN REPEAT FINDINGS ARE NOTED, THE AUDITOR SHALL DECIDE IF ROOT CAUSE ANALYSIS IS REQUIRED FOR THE SPECIFIC DEFICIENCY.

9.4.1 Reporting Requirements for External Audits, Surveillances and Assessments. Each Audit, Assessment and Surveillance Report finding should be a concise statement of the situation, complete to the extent that it will stand on its own as a summary of the condition. It should include the requirement for immediate corrective action where such action is indicated. In the event the finding is not a direct violation of a requirement or the nature of the finding does not warrant specific oversight from the auditing activity, yet it offers room for process improvement, no official response is required. These findings are offered to commands as a tool to improve their processes. Such findings will be clearly identified in the audit report reflecting that no official response is required. A discussion should generally be included to amplify the nature of the finding. If not included in the finding, identify positively what directives were violated. TYCOM/ISIC audit/assessment/surveillance findings will be reported using the format of Appendix E. The TYCOM/ISIC cover letter forwarding the QA Audit/Assessment/Surveillance Discrepancy forms (Appendix E) will include a summary of all areas. When repeat findings are noted the effectiveness of the corrective action taken in response to previous audits should be addressed.

- a. Ship's Force will provide a report to the ISIC of completed corrective action, proposed corrective action and schedule of accomplishment within 60 days of receipt of the ISIC Official Audit/Assessment/Surveillance Report. Specifically, the Ship's Force report shall:
 - (1) For individual findings that require immediate corrective action, include a root cause, causal analysis, immediate corrective action and permanent corrective action.
 - (2) For areas evaluated as weak (i.e., Below Standards) or areas where repeat findings indicate that previous corrective action was not effective include:
 - (a) A discussion of the fundamental root causes.
 - (b) A discussion of action taken to correct the causes and an evaluation of the effectiveness of this action.
 - (c) A discussion of the reasons why previous corrective action was not successful in improving any area where repeat findings indicate that previous corrective action was not effective.
 - (3) For all other individual findings requiring an official response, include, at a minimum, a permanent corrective action taken to correct the deficiency.
- b. (Submarines/Submarine Repair Activities) For immediate corrective action items (items that must be corrected prior to certain operations):
 - (1) (Within the SUBSAFE Boundary) The immediate corrective action must be complete and verified with the ISIC prior to the ship's next underway for submerged operations or within 15 days of receipt of the ISIC Official Audit/Assessment/Surveillance Report, whichever is sooner. All deficiencies which affect certification shall be categorized as "IMMEDIATE CORRECTIVE ACTION".
 - (2) (Within the SOC Boundary) The immediate corrective action must be clearly identified as to whether it must be completed prior to manned operations whether in-port or at-sea, or prior to unmanned operations at-sea or within 15 days of receipt of the ISIC Official Audit/Assessment/Surveillance Report, whichever is sooner. This may require discussions with the Program Manager and/or the System Certification Authority (SCA). The corrective action must be complete and verified with the ISIC prior to the operation being conducted that was restricted.

- (3) (Within the Level I Boundary) The immediate corrective action must be clearly identified as to what system operation restrictions must be in place prior to the completion of the corrective actions. The corrective action must be complete and verified with the ISIC prior to the operation of the system if restricted or prior to at-sea operations or within 15 days of receipt of the ISIC Official Audit/Assessment/Surveillance Report, whichever is sooner.
- (4) (Within the FBW Boundary) The immediate corrective action must be complete and verified with the ISIC prior to the ship's next underway for surfaced or submerged operations or within 15 days of receipt of the ISIC Official Audit/Assessment/Surveillance Report, whichever is sooner. All deficiencies which affect certification shall be categorized as "IMMEDIATE CORRECTIVE ACTION".
- c. FMAs will provide a report to TYCOM via ISIC (if applicable) on completed corrective action, assessment of root cause, proposed permanent corrective action, and schedule of accomplishment within 60 days of receipt of the TYCOM QA Audit/Assessment/Surveillance Official Report. Those items determined to need immediate correction should be addressed on a case basis. No official response is required for those items indicated as not requiring a response.
- d. Naval Sea Systems Command (NAVSEA) Deep Submergence System/SOC Surveys. Findings for Deep Submergence System/SOC Surveys are reported in accordance with Part III paragraphs 9.3.4.2 or 9.3.6.3 of this volume, as applicable. Survey findings will be formally forwarded to the Sustaining Activity via the ISIC and an informational copy to the respective TYCOM and maintenance activity, as applicable. The Sustaining Activity response will be provided to the SCA via the operational chain of command. Survey findings to allow manned operations will be processed as follows:
 - (1) When action identified by a specific card has been completed, a brief summary of the corrective action shall be written on the card and the card shall be signed by the Command responsible for the corrective action. All applicable Objective Quality Evidence (OQE) documenting the corrective action taken shall be attached to the signed card and forwarded to the SCA via the ISIC and an informational copy to the respective TYCOM.
 - (2) For Category 1A, Category 1B and applicable Category 1C findings affecting manned operations, the corrective action must be completed and verified with the SCA prior to manned operations whether in-port or at-sea, or prior to unmanned operations at-sea, or within 30 days of receipt of the Official NAVSEA Survey Report, which ever is shorter.
 - (3) For all other findings, the Sustaining Activity will provide a report to NAVSEA, via the ISIC, of completed corrective action, proposed corrective action and schedule of accomplishment within 60 days of receipt of the Official NAVSEA Survey Report.

9.4.2 Correcting Deficiencies in Certified Controlled Work Packages or Objective Quality Evidence Records.

Deficiencies identified in OQE of certified (closed) CWPs or OQE records (such as retained for REC exceptions) require action to update or correct the OQE to support continued certification of the system. No changes are permitted to a certified CWP, the certified supporting documents listed on the Maintenance Certification Record/REC or certified OQE record except as noted below. Additional OQE that is generated to clarify the certified documents can include: providing additional administrative information to clarify the OQE documentation, re-performance of the maintenance and/or performance of certification testing. The CWP/OQE record shall be annotated to associate the additional information to the document(s) as follows:

- a. A QA form 14 shall be generated for each OQE deficiency identified. Each QA form 14 shall identify the deficiency, root cause and corrective action required or completed. The corrective action taken shall clearly identify the revised OQE attributes such as data, an attached certified QA form, a separate CWP number (to document a rework such as performance of a required test, inspection or assembly process) and/or approved DFS (if applicable).
- b. The QA form 14 serial number(s) shall be annotated at the top of the QA form 9 or QA form to clearly indicate a QA form 14 has been generated to revise or update the OQE.

- c. Once all required actions are completed to revise or update the OQE, a copy of the completed QA 14 forms and any additional documentation generated shall be attached to the CWP/QA form record such that it is clear that the OQE was revised or updated and certification of the system was restored. The QA form 14 index log shall be updated to indicate the action was completed and the log shall be retained per Part I, Chapter 10 paragraph 10.5.6 of this volume.

(This Page Intentionally Left Blank)

APPENDIX A
VERTICAL AUDITS

1. The function of a vertical audit is to determine if a single job has been completed in accordance with the required specifications. It tracks the job from start to finish by using the documentation used to perform and certify the job. The following steps are considered the minimum requirements to conduct an audit:

- a. Assemble the documentation for the job being audited.
- b. Assemble the references.
- c. Assign auditors who are familiar with the job being audited.
- d. Develop (if not already existing) attribute sheets to be used during conduct of audit.
- e. Assemble previous audit discrepancies, if applicable.
- f. Brief auditors on the following:
 - (1) Purpose of vertical audit.
 - (2) Common discrepancies from previous audits.
 - (3) Audit attributes.
- g. Conduct audit as follows:
 - (1) Review procedure against the governing references and/or documentation to ensure they reflect what was supposed to be accomplished, if it was accomplished, and how it was accomplished.
 - (2) Review all documentation pertaining to OQE to ensure that it actually reflects that the job was done correctly. Additionally, a check for accuracy and completeness of forms is required.
 - (3) All deficiencies noted, that require investigation or program evaluation to identify root cause and permit effective and permanent corrective action, will be documented on a QA Audit Discrepancy form (Appendix E), or QA form 14, as appropriate, and presented to the activity being audited.

2. There is no specific formula for the successful completion of a vertical audit other than time and attention to detail. If properly performed, this audit provides an excellent method to assess the effectiveness of the QA program, since it provides small concise snap-shots of several areas of the entire program.

(This Page Intentionally Left Blank)

APPENDIX B
HORIZONTAL AUDITS

1. The function of a horizontal audit is to review one specific area or part of an area to ensure compliance with the governing requirements. It focuses only on the documentation used to certify the area of concern. The following steps should be considered minimum requirements for an audit:
 - a. Assemble the source documents/references for the area being audited.
 - b. Assemble the documentation/records of area being audited.
 - c. Develop (if not already existing) attribute sheets/audit guide to be used during conduct of the audit.
 - d. Assemble previous audit findings (if available) for area being audited.
 - e. Assemble and brief auditors on the following:
 - (1) Purpose of audit.
 - (2) Audit attributes.
 - (3) Common discrepancies from previous audits (if available).
 - f. Conduct audit as follows:
 - (1) Review area being audited using attribute sheets/audit guide.
 - (2) Review the organization's implementation and adherence to the source documents.
 - (3) Review the documentation used to certify that the organization is in compliance with the governing requirements.
 - (4) Document deficiencies which require investigation or program evaluation to determine root cause and permit effective and permanent corrective action on a QA Audit Discrepancy form (Appendix E), or QA form 14, as appropriate, and present it to the organization being audited.
2. If properly performed this type audit provides an excellent assessment of a specific area within the overall QA program.

(This Page Intentionally Left Blank)

APPENDIX C

SURVEILLANCES

1. Surveillance programs provide an excellent method for activities to review in-process work and every day practices to determine if deficient conditions or areas exist. A surveillance is designed to observe in-process work on a particular job.
2. The following steps should be considered minimum requirements for surveillance:
 - a. Personnel assigned to conduct a surveillance must be knowledgeable and trained in how to conduct surveillance.
 - b. Personnel assigned to conduct a specific surveillance must be knowledgeable in the area to be monitored.
 - c. Once assigned, the individual should prepare for the surveillance as follows:
 - (1) Assemble the reference material for the surveillance (e.g., Technical Work Document, Formal Work Package, Planned Maintenance System MRC, URO MRC and process instruction).
 - (2) Review reference material. This review may indicate other documentation that must be reviewed. This review should concentrate on the specific steps or portions of the procedure, which will be monitored during the surveillance.
 - (3) Based on the review, attribute checklists may be developed and used, which are tailored to the area to be monitored.
 - (4) Individual assigned must stay abreast of the job progress to ensure that the surveillance is conducted as required to observe the critical aspects. It serves no purpose to conduct the surveillance, if the job has progressed to a point of insignificant importance (e.g., surveillance of a valve repair after valve is repaired and being reassembled).
 - d. Once all preparations are complete, the surveillance should proceed as follows:
 - (1) Upon arrival at the job site, inform individuals performing the job that a surveillance is being conducted.
 - (2) Position yourself so the job can be monitored but not to interfere with individual(s) performing the work.
 - (3) Ensure that all key elements/attributes are observed. The focus must be on technical requirements and adherence to it. In those instances where a safety issue, incorrect assembly, or violation of a technical requirement critical to the job is noted, identify this to the individuals performing the job and request they stop until the problem can be resolved.
 - (4) Look beyond the items on the checklist, if used, for evidence that work is being done correctly.
 - (5) Once the surveillance is completed, inform the individuals performing the job of any violations or comments noted during the surveillance. Findings will also be discussed with appropriate supervisor.
 - (6) Write up surveillance findings and provide them to the QAO with copy to the division officer in charge of the work surveyed.
 - e. It is important that personnel involved in the surveillance program understand that they must focus their efforts towards improvement of the program by being objective and thorough when performing a surveillance. Identification of deficiencies should lead to effective corrective action and an overall improvement in the QA program.

(This Page Intentionally Left Blank)

APPENDIX D

SUBMARINE QUALITY ASSURANCE ASSESSMENT EVALUATION CRITERIA

1. The following guidance is provided to establish consistent grading standards across the Submarine Force. This will enable consistent evaluation of QA assessments in the Submarine Force and provide specific feedback to commands thus improving their ability to independently assess and maintain readiness in Undersea Warfare. The areas are based on the requirements of this chapter. The overall assessment will be graded as satisfactory or unsatisfactory. A grade of unsatisfactory will be assigned by the ISIC if any of the following criteria are met:
 - a. Unsatisfactory in any of the following areas:
SUBSAFE/REC, DSS-SOC, FBW-SCS Program or URO MRC Program or,
 - b. Unsatisfactory in Vertical Audit of CWPs and Audit, Surveillance, Evaluation and Assessment Program or,
 - c. Unsatisfactory in Vertical Audit of CWPs and QA Training and Qualification.

Any additional trending may be provided by the ISIC. An overall grade of unsatisfactory shall result in the ISIC restricting the ship from processing any controlled work and the ISIC shall promulgate specific guidance for controlled work processing and performance up to and including assuming certification responsibilities for controlled work. This assumption of certification responsibilities by the ISIC will remain until the ISIC has deemed that adequate actions have been taken to correct the significant programmatic issues.

2. Quality Assurance Program Assessment area criteria.

NOTE: WHERE NOT PREVIOUSLY DEFINED BY REFERENCE (A), ISICS SHOULD GENERALLY REVIEW 20%, BUT NO LESS THAN 10 CWPS, OF THE TOTAL CWPS WORKED BY THE SHIP SINCE THE PREVIOUS AUDIT.

- a. Vertical Audit of CWPs: This review encompasses a sampling of RECs, REC Exceptions and Maintenance Certification Records. Deficiencies noted during the review that affect certification and require an Immediate Corrective Action Report (ICAR) are generally the grade drivers for this area of the assessment. Additionally, systemic weaknesses in documentation of OQE, determination of technical requirements (e.g., torque, retest) and ineffective supervisor reviews may also require an ICAR.

Vertical Audit of CWPs	
Grade	Attributes
Above Standards	No ICARs.
At Standards	≤ 2 ICAR.
Below Standards	≥ 3 ICARs and/or systemic problems in specific areas of work package development or review (i.e., inadequate supervisory reviews, inability to properly determine retest).
Unsatisfactory	ICARs written on four or more CWPs or ICARs written on 40% of the CWPs audited, whichever is greater.

- b. **Material Control:** This review focuses on storage, handling and documentation. Inspections of lockers are the usual source of deficiencies in this area. Cards are written based on the magnitude of deficiencies. The magnitude should be determined by taking the total items with deficiencies and dividing by the number of items in the inventory. Additionally, systemic failures to follow both local and Joint Fleet Maintenance Manual (JFMM) requirements or installation of uncertified material into a controlled system may require an ICAR.

Material Control	
Grade	Attributes
Above Standards	No Locker deficiencies.
At Standards	< 10% deficiencies No ICAR on material Control.
Below Standards	≤ 25% deficiencies and/or one ICAR on Material Control (Controlled work or Program Coordination).
Unsatisfactory	> 25% deficiencies and/or one ICAR on Material Control (Controlled work or Program Coordination).

- c. **DEPARTURES FROM SPECIFICATION:** This program review consists of a review of active DFSs and necessary OQE supporting clearance of DFSs against JFMM requirements. Deficiencies are normally centered on improper administration (e.g., incorrect Job Control Numbers) or inadequate record retention.

DFS	
Grade	Attributes
Above Standards	No deficiencies noted.
At Standards	Only minor (< 10) administrative deficiencies noted with program administration.
Below Standards	Multiple deficiencies with records (≥ 10) and/or systemic failure to follow JFMM and ISIC requirements for administration of program.
Unsatisfactory	Any ICAR assigned based on failure to follow DFS policies.

- d. **Audit, Surveillance, Evaluations and Assessment:** This review is an in-depth review of how the ship's ability to monitor, assess and determine corrective actions to prevent re-occurrence. This review is one of the more subjective areas and the auditor will have to be consistent in his methodology and provide specific comments. In general the grades will be based on the ability to meet the requirements (e.g., conduct the required audits as required by the JFMM). Other driving factors may include repeat poor performance and systemic failure to follow both local and JFMM administrative requirements. An aggressive program is defined as one where the QAO demonstrates his surveillance schedule is dynamic and focuses on infrequent repair efforts, first time repairs and components that have repetitive failure in addition to previously noted weak areas. An aggressive program will also demonstrate how weak areas are assessed, assigned corrective actions that affect change and have been adequately re-assessed.

Audit, Surveillance, Evaluation and Assessment Program	
Grade	Attributes
Above Standards	All audits performed as scheduled/required. Aggressive surveillance program.
At Standards	≤ 1 Audit not performed. Only minor (< 10) administrative deficiencies noted with program administration.
Below Standards	≤ 2 Audits not performed. Multiple deficiencies with records (≥10) and/or systemic failure to follow JFMM and ISIC requirements for administration of program.
Unsatisfactory	> 5 Audits not performed. Continued below standards performance with program.

- e. **QA Training and Qualification:** This review will validate that the ship has an auditable qualification program and that the ship is maintaining the qualification (i.e., continuing training) as required by Part I, Chapter 3 of this volume.

QA Training and Qualification	
Grade	Attributes
Above Standards	Demonstrated QAO involvement in the QA Program. Demonstrated ability to incorporate lessons learned in QA Training Program. Demonstrated accountability in SUBSAFE, FBW-SCS and DSS-SOC awareness training for all required personnel.
At Standards	Only minor (< 10) administrative deficiencies noted with program administration. Adequate number of qualified personnel.
Below Standards	Multiple deficiencies with records (≥ 10) and/or systemic failure to follow JFMM requirements for administration of program (e.g., QA training plan not incorporated into Engineering Training Plan, qualification of personnel not auditable).
Unsatisfactory	Continued below standards performance with program.

- f. QA Records and Record Retention: Review will ensure that OQE and program records are being maintained in accordance with Part I, Chapter 10 of this volume.

QA Records and Record Retention	
Grade	Attributes
Above Standards	All required records are available and auditable.
At Standards	Records retained in an auditable fashion. Only minor (< 10) administrative deficiencies or missing records noted.
Below Standards	Multiple deficiencies with records (≤ 25) and/or systemic failure to maintain records as required by JFMM requirements.
Unsatisfactory	Records completely un-auditable or loss of a controlled work package.

- g. SUBSAFE/REC, DSS-SOC and FBW-SCS Program: This review ensures that the ship has maintained certification of SUBSAFE/REC, FBW-SCS and DSS-SOC systems in accordance with the applicable manuals. When ships utilize more than one level of control (e.g., SUBSAFE and FBW) then individual grades will be provided. ICARs of SUBSAFE/REC, FBW-SCS or DSS-SOC may influence the grade for this area as indicated below.

SUBSAFE/REC, SOC and FBW Program	
Grade	Attributes
Above Standards	No deficiencies noted.
At Standards	Only minor (< 10) administrative deficiencies noted with program administration.
Below Standards	Multiple deficiencies with records (≥ 10) and/or systemic failure to follow JFMM requirements for administration of program. Missing one or two REC Exception Documents.
Unsatisfactory	Failure to issue certification of continuity letters or failure to use REC controls when performing SUBSAFE/REC, DSS-SOC or FBW-SCS work when re-entry controls are required. Missing three or more REC Exception Documents.

- h. URO MRC Program: This program review is to ensure that the ship maintains certification on all systems that contain URO measured parameters. Ships are required to call out the correct retest and maintain appropriate documentation for the program in accordance with Volume VI, Chapter 25 of this manual.

URO MRC Program	
Grade	Attributes
Above Standards	Not applicable.
At Standards	All documentation on hand. All UROs within periodicity. All maintenance affecting URO parameters properly retested.
Below Standards	Missing/un-auditable URO documentation (records were recovered from other organizations). Failing to properly document a URO retest for associated maintenance (retest performed for some other reason, e.g., periodicity).
Unsatisfactory	Operated at sea with an Out of Specification, untested or overdue URO parameter.

3. The following metrics will be identified in the Quality Assurance Assessment report issued by the ISIC:

CWPs		REC EXCEPTIONS		Total	
ISSUED	AUDITED	ON-FILE	AUDITED	ICARS	CARS
QAO History (since previous audit)					
	Rank/Name		Duration Assigned (mm/yy-mm-yy)		
Current					
Prior					
Assistant QAO History (since previous audit)					
	Rank/Name		Duration Assigned (mm/yy-mm-yy)		
Current					
Prior					
Qualification Status					
	Actual		Fleet Standard for Area		
Craftsman					
Planner					
CMPOs					
QAI					
WCS					
Welders					
O2 Clean					
STP Clean					
RP Clean					

APPENDIX E

QUALITY ASSURANCE AUDIT/ASSESSMENTS/SURVEILLANCE DISCREPANCY FORM

() IMMEDIATE CORRECTIVE ACTION REQUIRED

() REPEAT FINDING

ITEM:

AREA:

AUDITOR:

DISCUSSED WITH:

REFERENCE:

FINDING:

DISCUSSION:

CORRECTIVE ACTION:

A. ROOT CAUSE(S):

B. ROOT CAUSE DISCUSSION(S):

C. IMMEDIATE CORRECTIVE ACTION(S):

D. PERMANENT CORRECTIVE ACTION(S):

(This Page Intentionally Left Blank)

VOLUME V
PART I
CHAPTER 10
QUALITY ASSURANCE RECORDS

REFERENCES.

- (a) SECNAVINST 5239.21 - Department of the Navy Electronic Signature Policy
- (b) NAVSEAINST 9210.23 - Requirements for Naval Nuclear Work at Naval Activities and Private Shipyards - Certification of Work Accomplishment and Data Retention of Associated Records and Retention of Design Records
- (c) SECNAV M-5210.1 - Department of the Navy, Navy Records Management Program, Records Management Manual
- (d) NAVSEA T9044-AD-MAN-010 - Requirements Manual for Submarine Fly-By-Wire Ship Control Systems
- (e) COMSUBLANT/COMSUBPAC NOTE C3120 - Submarine Operating Restrictions and Depth Authorizations
- (f) NAVSEAINST 9210.39 - Submarine Nuclear Propulsion Plant Operator Welders: Procedures for Maintenance of Qualification

10.1 PURPOSE. Provide record keeping and retention requirements for the Quality Assurance (QA) records used by the Fleet.

10.2 GENERAL. QA records provide the only lasting records and Objective Quality Evidence (OQE) that repairs and alterations performed on ships of the fleet were accomplished and subsequently tested in accordance with applicable specifications. The accuracy of these records will be beyond reproach and the record for each job will be complete so as to "stand alone", that is, the record will be understood without additional explanation.

10.2.1 Quality Assurance Record Requirements. Record keeping methods are of concern because they affect the apparent validity of a completed record. In order to ensure continued validity of Fleet maintenance records, and to provide the necessary OQE, the following record keeping rules are specified:

- a. Hand written Record and Certification Signature Block or signature will be legible, in ink and in accordance with reference (a). Erasures, write-overs, white outs, ditto marks, continuation arrows, signature stamps, etc., are not acceptable.
- b. Neatness and readability of the original record is paramount. Copying records to "make them neat" is prohibited.
- c. When an error is made, it will be corrected by drawing a single line through the error, recording the correct entry, initialing, dating and printing the name of the person making the correction.
- d. When a questionable item is recognized and is subsequently justified or accepted, remarks explaining the decision will be added or appended as appropriate.
- e. QA records pertaining to certification of nuclear work will be kept in accordance with the requirements of reference (b).

10.2.2 Record Retention in General. The following paragraphs summarize the general QA records that will be retained by each organizational group and how long they will be retained:

- a. Reduced Size Records. Records (except radiographic film) required to be maintained may be reduced in size (such as by microfilming or CD-ROM in .pdf format only). However, the activity (ship or Fleet Maintenance Activity (FMA)) responsible for the record will ensure that the reduced size records are clearly legible, reproducible, and will so certify prior to destroying the original records. The following procedure will be followed for record reduction:

- (1) Record reduction shall be in accordance with reference (c).
 - (2) Compare the reduced size record against the original record to ensure each page of the original record has been reduced. This comparison shall ensure that the front and the associated back of QA forms and tags have been reproduced.
 - (3) Reproduce two randomly selected pages of the reduced record into paper copy. Verify completeness and legibility of reproduced pages by comparing against the original record.
 - (4) Person making comparison will sign the logbook or some other permanent record to certify that the reduced size record is complete and legible after being reproduced.
 - (5) After steps (1) through (4) above are satisfactorily completed, the original record may be destroyed.
- b. Storage and Disposal.
- (1) Nuclear Records.
 - (a) Records that are required to be retained for the life of the ship by reference (b) require Naval Sea Systems Command Nuclear Propulsion Directorate (NAVSEA 08) approval prior to record disposal.
 - (b) Records of nuclear controlled work will be retained at the activity (ship or FMA) for at least three years following completion of the work in accordance with reference (b). They may then be transferred to a Federal Records Center (FRC) or other designated records repository in accordance with reference (c), after these records are no longer required on board.
 - (c) Records stored at a FRC. Records stored at FRC will be in accordance with reference (c). Those records stored at a FRC or other designated repository will be appropriately cataloged to allow prompt retrieval if necessary. A copy of the list of records transferred to storage will be sent to the applicable Type Commander (TYCOM). TYCOM will retain these lists until the ship is stricken from Navy rolls. Activities may forward reactor plant work records to FRCs specifying that the records be destroyed 75 years from the date the records are sent to the FRC.
 - (2) Level I Records.
 - (a) Non-Nuclear/Non-Submarine Safety (SUBSAFE) Level I Records will be maintained for a minimum of 75 years from the ship's delivery date for new construction or 75 years from the availability completion date for repairs, overhauls, conversions, etc. Disposition instructions will be requested from NAVSEA 05P via the appropriate TYCOM after that time.
 - (b) Records of Level I work will be retained at the activity (ship or FMA) for at least three years following the completion of the work. After three years the records may be stored ashore.
 - (3) Submarine Safety and Submarine Flight Critical Component (SFCC) Records.
 - (a) SFCC records shall be kept in accordance with reference (d). The re-entry control log, completed Re-Entry Controls Forms (REC/MCR), and supporting documentation for SUBSAFE and SFCC work shall be maintained for the life of the ship.
 - (b) Records of SUBSAFE and SFCC work will be retained at the activity (ship or FMA) for at least three years following the completion of the work. After three years the records, including completed RECs and supporting documentation, may be stored ashore or at a FRC in an auditable condition.

- (c) Records stored at a FRC will be in accordance with reference (c). Those records stored at a FRC or other designated repository will be appropriately cataloged to allow prompt retrieval if necessary. Activities may forward SUBSAFE and SFCC records to FRCs specifying that the records be destroyed 75 years from the date the records are sent to the FRC.
 - (d) Approval to destroy non-ship-specific completed RECs, REC logs, completed RECs, and supporting documentation must be obtained from NAVSEA 07Q via the appropriate submarine TYCOM.
- (4) Scope of Certification (SOC) Records.
- (a) The REC log, completed RECs and supporting documentation shall be maintained for the operational life of the Deep Submergence System.
 - (b) The REC log, completed RECs, and supporting documentation of work performed by the Sustaining Activity shall be maintained by the Sustaining Activity in an auditable condition for the period between major availabilities and between sustaining surveys. When work requiring REC is accomplished by an activity other than the Sustaining Activity, the Sustaining Activity's REC log shall reflect this work and the Sustaining Activity shall maintain a copy of the completed REC form (QA form 9 and QA form 10 when applicable). After this period, the records, including completed RECs and supporting documentation, may be stored ashore or at a FRC in an auditable condition.

10.3 TYPE COMMANDER QUALITY ASSURANCE RECORD RETENTION.

10.3.1 Assessment Record Retention. Retain copy of last assessment of FMAs and Immediate Superiors in Command (ISIC), where applicable, including the report of root causes and corrective action.

10.3.2 Departure from Specification Record Retention.

- a. Maintain outstanding Departure from Specification (DFS) File. This file may be maintained on electronic media.
 - (1) An index that reflects the major DFS unique serial number assigned, date approved, system or component including brief description and status.
 - (2) A copy of each outstanding major DFS and all applicable correspondence.
- b. (Submarines only) A hard or electronic copy of cleared major SUBSAFE/SFCC DFSs with an index will be retained for life of ship.

10.3.3 Material Certification Statement Retention (Submarines only).

- a. A hard or electronic copy of the TYCOM and NAVSEA SUBSAFE Material Certification message from new construction, Depot Modernization Period (DMP), Engineered Overhaul (EOH), Engineered Refueling Overhaul (ERO), Refueling Overhaul (RFOH) and Regular or Refueling Overhaul (ROH) will be retained for life of ship.
- b. A hard or electronic copy of the Operating Cycle Extension Assessment used as basis for granting TYCOM extension of operating interval or operating cycle will be retained until the ship enters the next Selected Restricted Availability (SRA)/DMP/EOH/ERO/RFOH/ROH for which the TYCOM extension applies.

10.4 IMMEDIATE SUPERIOR IN COMMAND QUALITY ASSURANCE RECORD RETENTION.

10.4.1 Assessment and Surveillance Record Retention.

- a. Copy of last ISIC or TYCOM assessment of assigned ships and FMA including report of root causes and corrective action.
- b. (Submarines only) Copy of the ISIC monitor surveillance reports of the FMA and assigned ships and the corrective action. Retain the past 18 months of monitor surveillance reports. These records may be kept with the other ISIC monitor program records.

- c. (Submarines only) Copy of the last TYCOM assessment of the ISIC and corrective actions.
- d. All SUBSAFE and Fly-By-Wire Certification Audit Reports of ships shall be retained for the life of the ship in accordance with paragraph 10.2.2b. of this chapter.

10.4.2 Departure from Specification Record Retention.

- a. Outstanding DFS Files.
 - (1) A hard copy or electronic media index that reflects the DFS unique serial number assigned, TYCOM major DFS number (if assigned), date approved, system or component including brief description and status.
 - (2) A copy of each outstanding DFS and all applicable correspondence.
- b. A hard or electronic copy of cleared DFS with an index will be retained for 24 months.

10.4.3 Material Certification Statement Retention (Submarines only).

- a. The SRA/Tiger Team certification statements from industrial activities will be retained until the next SRA/DMP/EOH/ERO/RFOH/ROH of the affected ship.
- b. The ISIC request for Sea Trials (Volume II, Part I, Chapter 3, Appendix BK, and if used, Appendix BF of this manual) and the TYCOM message authorizing Sea Trials (Volume II, Part I, Chapter 3, Appendix BD, and if used, Appendix BG of this manual) for CNO availabilities less than 6 months until the next SRA/DMP/EOH/ERO/RFOH/ROH of the affected ship.
- c. The most recent FMA end of upkeep statement.
- d. The most recent ship generated, prior to underway, certification continuity report will be retained.
- e. The audit guide and justification used for any Operating Cycle Extension Assessment of assigned ships will be retained in accordance with paragraph 10.3.3 of this chapter.

10.5 SHIP'S QUALITY ASSURANCE RECORD RETENTION.

10.5.1 Controlled Work Package Log. The Quality Assurance Officer (QAO) will maintain a Controlled Work Package (CWP) log, using the QA form 11, for the life of the ship. Re-copying or consolidation of this log is not to be done.

10.5.2 Completed Controlled Work Packages. All CWPs (retain onboard per paragraph 10.2.2 of this chapter), which includes:

- a. Maintenance Certification Record (MCR)/REC (QA forms 9 and 10).
- b. References unique to this task (e.g., NAVSEA letters, Liaison Action Requests) will be retained with the CWP unless specifically identified to allow recall, if necessary.
- c. All enclosures documenting the OQE (e.g., QA forms and Ready for Issue (RFI) tags (NAVSEA 9210/2 and 9210)) will be retained.
- d. FWP's executed as the core of a CWP shall be retained with the CWP. After three years when CWPs are moved ashore or placed in storage, the FWP portion of the CWP may be discarded.

10.5.3 Controlled Material Records. Controlled material records will be maintained with the associated CWP. Those records not associated with a CWP will be maintained on file by the QAO.

- a. The Supply Officer will maintain on file the letter of certification from the Supervisor of Shipbuilding, for all lots of Level I/SFCC Stock Program material and Nuclear Repair Parts during the new construction period. When the material is issued, a copy of this letter should be attached to the QA form 1.

NOTE: MATERIAL CONTROL RECORDS (E.G., QA FORM 2s) ARE NOT REQUIRED TO BE RETAINED FOR REMOVED AND REINSTALLED CONTROLLED MATERIAL AFTER THE CWP IS CLOSED.

- b. The QAO will maintain controlled material records as outlined below. These records should be included in the appropriate CWP to the maximum extent practical. Retain material certification files for all Nuclear Level I, SFCC and Level I material installed.
 - (1) RFI tags for Nuclear Level I items installed.
 - (2) For any Nuclear Level I items received and installed without a RFI tag retain all OQE used to certify.
 - (3) All OQE used to upgrade material for non-nuclear "Level" use.
 - (4) All QA forms 3 for any rejected items accepted for use.
 - (5) A file of QA forms 1 with certification documentation.

10.5.4 Qualification Records. The QAO will maintain a master list of qualified Work Center Supervisors and Maintenance Planners, Controlled Material Petty Officers (CMPO), Cleanliness Inspectors, Quality Assurance Inspectors (QAI), Quality Assurance Supervisors (QAS), Oxygen Clean Workers and Oxygen Clean Instructors. The records will be retained for the duration the individual is onboard. Records in the case of re-qualifications shall consist of a written plan and sub-paragraphs a. through d. below, as applicable, based upon the plan defined by the QAO or Department Head. The file will consist of:

- a. Date Personnel Qualification Standard completed. For Oxygen Clean Workers and Oxygen Clean Instructors, the date the required course of instruction is completed.
- b. Qualification test results. This includes a copy of the examination cover sheet. In addition, a copy of the examination given with answers shall be available either in electronic medium or hard copy. For Oxygen Clean qualifications, this entry is not required.
- c. A copy of the signed Final Qualification Page from the Personnel Qualification Standard.
- d. Copy of the signed oral interview sheets for each qualification record.
- e. (Submarines only) A master list of qualified Oxygen Clean Workers shall be retained for the life of the ship.

10.5.5 Departure from Specification Records.

- a. Outstanding DFS Files.
 - (1) An index that reflects the DFS unique serial number assigned, date approved, system or component including brief description, annotation for SUBSAFE and status.
 - (2) A copy of each outstanding DFS and all applicable correspondence.
- b. A copy of cleared DFS with an index will be retained for 24 months.
- c. A copy of all DFS approved as permanent repairs, with an index, will be retained until they are reflected in the ship's selected records and drawings or technical variation documents.

10.5.6 Assessments, Evaluations and Audits. The QAO will retain records of assessments, evaluation and surveillance for the past 24 months (unless otherwise stated). The records will consist of:

- a. QA form 14 index log that has the item numbers, work center responsible to correct and estimated date corrective action is due.
- b. Copy of last higher authority assessment and the corrective action for all items.
- c. Results of all Audits and Surveillances of the QA Program, including the root cause, immediate and permanent corrective action. (This may be kept with the rest of the monitor program records).
- d. Last annual QA Program evaluation performed.
- e. Maintain an auditable record of the most current Job Control Number to DFS verification.

10.5.7 Training.

- a. Training records will be retained in accordance with TYCOM instructions.

- b. (Submarines only) The ship shall maintain a record of completion for each member of the crew indicating the date of completion for annual SUBSAFE Awareness, Fly-by-Wire Awareness and SOC Awareness Training, as applicable.

10.6 ADDITIONAL SUBMARINE/NUCLEAR UNIQUE QUALITY ASSURANCE RECORD RETENTION REQUIREMENTS.

10.6.1 Submarine Safety/Nuclear/Level I/Submarine Flight Critical Component/Scope of Certification/Other Certification. The ship will retain the following records for the life of the ship or as indicated below:

10.6.1.1 Reactor Plant Work Accomplishment Report (Submarines only). A copy of all completed Reactor Plant Work Accomplishment Reports.

10.6.1.2 Submarine Safety Material Certification (Submarines only). Copy of the TYCOM and NAVSEA SUBSAFE Material Certification message from new construction, DMP or overhaul until the ship's current status is reflected in reference (e). When the ship's current status is reflected in the notice, the messages may be destroyed, and the current notice will be retained.

10.6.1.3 End of Fleet Maintenance Availability Certification (Submarines only). Retain the last end of FMA Availability letter from the FMA.

10.6.1.4 Certification Continuity Reports (Submarines only). Retain the last certification continuity report sent by the ship.

10.6.1.5 Industrial Activity Certification Reports (Submarines only). A copy of all industrial activity/shipyard certification letters or messages from all SRA conducted between overhauls. In addition, a copy of the ISIC audit of SUBSAFE work performed by the industrial activity should also be kept. These may be disposed of at the next Extended Refit Period/SRA/DMP/EOH/ERO/RFOH/ROH.

10.6.1.6 Other Certification Reports (Submarines only). A copy of any other correspondence or messages that affect the certification of the ship or hull integrity should be retained until:

- a. Resolved via inspection/maintenance or DFS as required or
- b. As defined within the applicable correspondence/message.

10.6.1.7 Controlled Material (Submarines only). Except for Fly-By-Wire Diagnostic and Maintenance Computers (DMAC), Ship's Force is not required to use a QA form 1 to document receipt inspection of Level I/SFCC/SOC material to be immediately installed for a specific maintenance action. A QA form 2 will be used to document receipt inspection of material to be immediately installed. DMACs require a QA form 1 to document receipt inspection but do not require a QA form 2. The QA form 1 for the DMAC will be retained in the ship REC exception folder.

10.6.1.8 Nuclear Records. Nuclear records will be retained as required by reference (b). Reference (b) defines which nuclear records must be retained and length of retention as well as specifies requirements for retention of existing records. It is not intended to create new records for record retention requirements, if they do not already exist.

10.6.1.9 Nuclear Propulsion Plant Operator Welder Records (Submarines only). The Main Propulsion Assistant will retain the following qualification records in accordance with reference (f), for each welder as long as the welder is qualified onboard.

- a. Documentation certifying original weld school completion.
- b. QA form 20 for most current proficiency welds and qualification welds (the four most recent test assemblies).
- c. Copy of current eye examination report.

10.6.1.10 Re-Entry Control/Maintenance Certification Record Exception Objective Quality Evidence and Other Controlled Assembly Records. Retain a file of the most recent QA form 34 generated for each component or system assembled as a controlled assembly and performed as a REC/MCR exception per Part I, Chapter 5, paragraph 5.6.7, Note 3, Part I, Chapter 2, paragraph 2.2.5, Note 2 and Part III, Chapter 5, paragraph 5.11.6.1.b of this volume. Retain a file of the most recent QA form 34 record generated per Part I, Chapter 7, paragraph 7.4.1.c of this volume for non-controlled systems or components until the system or component testing is completed satisfactory.

10.6.1.11 Scope of Certification (Submarines only). Retain a copy of the NAVSEA and TYCOM, if applicable, Scope of Certification and/or Sustaining Survey Certification letter or message.

10.6.1.12 Unrestricted Operations (Submarines only). Retain records related to the Unrestricted Operations Program as defined by Volume VI, Chapter 25 of this manual.

10.7 FLEET MAINTENANCE ACTIVITY QUALITY ASSURANCE RECORD RETENTION.

10.7.1 Submarine Safety/Nuclear/Level I/Scope of Certification/Other Certification. The QAO or designated officer will retain material certification (SUBSAFE, Nuclear, Level I, Scope of Certification and CWP category "Other") records for the life of each tended ship.

10.7.2 Reactor Plant Work Accomplishment Report (Submarines only). The Nuclear Repair Officer will retain a legible copy of all FMA generated Reactor Plant Work Accomplishment Reports.

10.7.3 Controlled Work Package Log. The QAO will maintain a CWP log, using the QA form 11, for the life of the ship. Re-copying or consolidation of this log is not to be done.

10.7.4 Completed Controlled Work Packages. All CWPs (retain onboard per paragraph 10.2.2 of this chapter), which includes:

- a. MCR/REC (QA forms 9 and 10).
- b. References unique to this task (e.g., NAVSEA letters, Liaison Action Requests) will be retained with the CWP unless specifically identified to allow recall, if necessary.
- c. All enclosures documenting the OQE (e.g., QA forms and RFI tags (NAVSEA 9210/2 and 9210)) will be retained.
- d. FWP's executed as the core of a CWP shall be retained with the CWP. After three years when CWPs are moved ashore or placed in storage, the FWP portion of the CWP may be discarded.

NOTE: MATERIAL CONTROL RECORDS (E.G., QA FORM 2s) ARE NOT REQUIRED TO BE RETAINED FOR REMOVED AND REINSTALLED CONTROLLED MATERIAL AFTER THE CWP IS CLOSED.

10.7.5 Controlled Material Records. Controlled material records will be maintained with the associated CWP. Those records not associated with a CWP will be maintained on file by the QAO. The QAO will maintain controlled material records as outlined below. These records should be included in the appropriate CWP to the maximum extent practical. Retain material certification files for all Nuclear Level I, SFCC, Level I and SOC material installed.

- a. RFI tags for nuclear Level I items installed.
- b. For any Nuclear Level I items received and installed without a RFI tag retain all OQE used to certify the material for installation.
- c. All OQE used to upgrade material for non-nuclear "Level" use.
- d. All QA forms 3 for any rejected items accepted for use.
- e. A file of QA forms 1 with certification documentation.
- f. All material control records from receipt inspection through installation will be maintained throughout the life of Deep Submergence Systems.

10.7.6 Assessment, Audits, Surveillance and Evaluations. The QAO will retain records for the past 18 months (unless otherwise stated). The records will consist of:

- a. Last year and present year internal audit schedule.
- b. Completed audit plans/guides and results (Associated QA forms 14 or other discrepancy reports).
- c. QA form 14 index log that has the item numbers, work center responsible to correct and estimated date corrective action is due.
- d. Copy of last higher authority assessment, surveillance and the corrective action for all items.

- e. Schedule and results of internal surveillance of the QA Program, including the corrective action. (This may be kept with the rest of the monitor program records).
- f. Last two semi-annual QA Program evaluations.
- g. Two years worth of records for calibration laboratory spot checks/sampling of outgoing work.
- h. Two years worth of records for Field Calibration Activity spot checks/sampling of outgoing work, as applicable.

10.7.7 End of Fleet Maintenance Activity Certification Report to Tended Submarines (Submarines only). The QAO will retain a copy of the last End of Fleet Maintenance Activity Certification Report to tended submarines issued per Part I, Chapter 5, paragraph 5.6.8.b. or Part III, Chapter 5, paragraph 5.11.7.b of this volume, as applicable.

10.7.8 Nuclear/Submarine Safety/Scope of Certification Work. The master lists of qualified CMPO/Controlled Material Handler, Cleanliness Inspector/Certifier, QAI and QAS (if assigned), will be maintained by name, for the duration the individual is assigned to the repair activity.

NOTE: AT A FMA, CIVILIAN EMPLOYEE CONTINUING TRAINING KNOWLEDGE EXAMINATION QUESTIONS AND ANSWERS WILL BE RETAINED FOR TWO YEARS.

10.7.9 Qualification Record. The QAO will maintain a master list of qualified CMPOs/Controlled Material Handlers, Cleanliness Inspectors, QAIs, QASs, Oxygen Clean Workers and Oxygen Clean Instructors and a qualification file on each CMPO/Controlled Material Handler, Cleanliness Inspector, QAI and QAS. The records will be retained for the duration the individual is onboard. The file will consist of:

- a. Date Personnel Qualification Standard completed. For Oxygen Clean Workers and Oxygen Clean Instructors, the date the required course of instruction is completed.
- b. Qualification test results. For Oxygen Clean qualifications, this entry is not required.
- c. A master list of all qualified Oxygen Clean Workers shall be retained for the life of the FMA.

VOLUME V
PART I
CHAPTER 11
QUALITY ASSURANCE FORMS AND FORM INSTRUCTIONS

11.1 PURPOSE. Provide Quality Assurance (QA) forms and tags with instructions for preparation and usage.

11.2 NATIONAL ITEM IDENTIFICATION NUMBER. National Item Identification Number (NIIN) may be used whenever National Stock Number (NSN) is called for, including all QA forms. The NIIN uniquely identifies material in supply system and is adequate for Objective Quality Evidence (OQE) purposes.

11.3 LIST OF FORMS. This chapter provides copies of the QA forms and tags discussed throughout this volume

- | | | | |
|----|---------------|---|---|
| a. | QA form 1. | - | Material Receipt Control Record. |
| b. | QA form 2. | - | Material ID/Control Tag. |
| c. | QA form 3. | - | Controlled Material Reject Tag. |
| d. | QA form 9. | - | Maintenance Certification Record/Re-Entry Control. |
| e. | QA form 10. | - | Maintenance Certification Record/Re-Entry Control Supplement Sheet. |
| f. | QA form 11. | - | Controlled Work Package (CWP)/Re-Entry Control (REC) Log. |
| g. | QA form 11A. | - | REC/MCR Exception Controlled Assembly Log |
| h. | QA form 12. | - | Departure From Specification Request. |
| i. | QA form 12A. | - | Departure Clearance Report. |
| j. | QA form 14. | - | Surveillance/Monitoring/Audit Discrepancy Record. |
| k. | QA form 17. | - | Test and Inspection Record. |
| l. | QA form 17A. | - | Epoxy Repair Record. |
| m. | QA form 17B. | - | Electroplating Repair Record. |
| n. | QA form 17C. | - | Component Repair Record. |
| o. | QA form 17D. | - | Submarine Flight Critical Component (SFCC) Access, Removal and Installation Record. |
| p. | QA form 17SI. | - | Stud Installation Record. |
| q. | QA form 17W. | - | Handling Equipment Test Record. |
| r. | QA form 18. | - | Silver Braze Fabrication and Inspection Record. |
| s. | QA form 18A. | - | Ultrasonic Inspection Record. |

t.	QA form 20.	-	Welding In Process Control/Nondestructive Test Record.
u.	QA form 20A.	-	Radiographic Test Inspection Record.
v.	QA form 20B. (Part A)	-	Structural Primary Record.
w.	QA form 20B. (Part B)	-	Structural Weld History.
x.	QA form 20B. (Part C)	-	Structural Defect Record.
y.	QA form 20C.	-	Pipe, Machinery and Pressure Vessel Weld Record/Weld Defect Repair Sheet.
z.	QA form 26.	-	Hydrostatic/Pneumatic Test Record.
aa.	QA form 27.	-	Drop Test Record.
ab.	QA form 28.	-	Shop Test Record.
ac.	QA form 34.	-	Joint/Component Torque and Assembly Record.
ad.	QA form 34A.	-	Joint/Component Assembly Record.
ae.	QA form 35.	-	Thickness Measurement Record.
af.	MAT-1.	-	Ship to Shop Tag MAT-1 (General Use).

MATERIAL RECEIPT CONTROL RECORD
QA FORM 1 (FRONT)

1. MATERIAL NOMENCLATURE		2. LEVEL OF ESSENTIALITY		3. MIC NO./ID NO.						
4. REQUISITION NUMBER (REQ. NO.)		5. JULIAN DATE		6. NUMBER RECEIVED						
7. NSN/SMIC			8. VENDOR'S MARKINGS							
9. REQUIRED CERTIFICATION DOCUMENTS FURNISHED (SIGNATURE AND DATE) <input type="checkbox"/> YES <input type="checkbox"/> NO										
10. ENTER APPROP CODE	MT	PT	RT	UT	VT	CHEM	PHYS	GENERIC MATERIAL IDENTITY CHECK	HARDNESS	DIMEN
X - RECORDS REQ'D O - RECORDS NOT REQ'D										
11. INSPECTION RESULTS, REMARKS, SIGNATURES AND DATE:										
12. DISPOSITION <input type="checkbox"/> ACCEPT <input type="checkbox"/> REJECT						13. CERTIFIED <input type="checkbox"/> LI <input type="checkbox"/> NUC LI <input type="checkbox"/> SOC MCD __ <input type="checkbox"/> OTHER				
14. DOWNGRADE <input type="checkbox"/> GENERAL STOCK <input type="checkbox"/> REJECT TO SOURCE						15. SIGNATURE AND DATE				

QA FORM 1 INSTRUCTIONSMATERIAL RECEIPT CONTROL RECORD

PURPOSE: To document the proper receipt, control, end use and certification of material to the required "Level of Essentiality" for controlled material.

PROCEDURE: The numbered blocks on QA form 1 correspond with the instructions listed below.

NOTE: SHIP'S FORCE IS NOT REQUIRED TO COMPLETE A QA FORM 1 TO DOCUMENT THE RECEIPT INSPECTION OF CONTROLLED MATERIAL IF THE ITEM(S) IS TO BE IMMEDIATELY INSTALLED FOR A SPECIFIC MAINTENANCE ACTION. IN THESE CASES, THE RECEIPT INSPECTION WILL BE CAPTURED ON A QA FORM 2. IF THE MATERIAL IS NOT UTILIZED DURING THE SPECIFIC MAINTENANCE ACTION FOR WHICH IT WAS PROCURED IT SHOULD BE TURNED BACK IN TO SUPPLY. IF THE MATERIAL IS TO BE RETAINED FOR A FUTURE MAINTENANCE ACTION, A QA FORM 1 MUST BE FILLED OUT PRIOR TO PLACING THE MATERIAL IN A CONTROLLED MATERIAL STORAGE LOCKER/AREA.

NOTE: IF THE COMPONENT HAS A SHORTENED MATERIAL IDENTIFICATION AND CONTROL (MIC) MARKING, ENSURE THE FULL MIC MARKING FROM THE SHIPPING DOCUMENTS, TAGS, AND/OR PACKAGING IS ENTERED ON QA FORM 1 AND QA FORM 2.

NOTE: IF PORTIONS OF A COMPONENT WILL BE CANNABALIZED FOR INSTALLATION VICE INSTALLING THE ENTIRE COMPONENT, DISPOSITION IN ACCORDANCE WITH PART I, CHAPTER 6, PARAGRAPH 6.3.9.1.D OF THIS VOLUME.

BLOCK 1 - **MATERIAL NOMENCLATURE**

Enter the noun name of the material (e.g., 5/8" - 11 NICU studs, 10" O.D. CUNI Barstock).

BLOCK 2 - **LEVEL OF ESSENTIALITY**

Enter the applicable Level of Essentiality (SUBSAFE, Level I, Nuclear Level I, Submarine Flight Critical Component (SFCC) or Scope of Certification (SOC) Material Control Division (MCD)) for the material received. For assemblies such as valves, the Level of Essentiality will be the Level of Essentiality for the entire assembly, not individual parts.

- a. Nuclear Level I:
 - (1) Material received with a "Target" Ready for Issue (RFI) tag or Naval Sea Systems Command (NAVSEA) Prime Contractor Material determined to be Nuclear Level I.
 - (2) Material from stock system required to be certified as Nuclear Level I.
- b. SUBSAFE:
 - (1) Special Material Identification Code (SMIC) material with valid MIC markings.
 - (2) Submarine Antenna Engineering Directorate (SAED), (Submarine Antenna Quality Assurance Material) SMIC material.
 - (3) Open purchased and stock system non-level material required to meet SUBSAFE requirements.
- c. Level I:
 - (1) LI, C1, S1 or D1 SMIC material with valid MIC markings.
 - (2) Non-level material required to be upgraded to Level I requirements.
- d. SOC MCD A or MCD B: The entry will be based on the SOC Level of Essentiality as determined in Part III, Chapter 6 of this volume.

BLOCK 3 - **MIC NO./I.D. NO.**

NOTE: THE PNSY "TRACE CODE" RESEMBLES A MIC NUMBER BUT DOES NOT INCLUDE THE GENERIC MATERIAL DESIGNATOR (E.G., 98205-003A).

- a. Enter the MIC or the identification number/name plate data (I.D. No. if no MIC No.) etched on the major part of the assembled material received (some individual parts may also have MIC numbers that need not be recorded). Fleet Maintenance Activity (FMA) will enter MIC upon completion of upgrading for FMA certified/upgraded material. Ships (Non-FMA) will enter the FMA MIC No. for material that the FMA certifies for the ship. For rotatable items enter the appropriate rotatable pool serial number (e.g., rp-148a, tin-292-11893, etc.).
- b. For fasteners enter either the MIC number (when MIC number is marked on the fastener or the individual tag for some small fasteners) or the color code and the PNSY "trace code" provided on the shipper and the package/box.
- c. If the material is MCD B, enter Markings on the material or documented on the shipping papers providing identification to material type or military specification.

BLOCK 4 - **REQUISITION NUMBER (REQ. NO.)**

Enter the Requisition No. (invoice number) that was used to order the material or appears on shipping documents (if provided).

BLOCK 5 - **JULIAN DATE**

Enter the five digit Julian Date (e.g., 90121, 91200, 92030) the material is received.

BLOCK 6 - **NUMBER RECEIVED**

Enter the total number received (must agree with the invoice). If the material is, for example, "Barstock" enter the number of pieces and total length. Only one QA form 1 is required if the entire lot has the same MIC number and is receipt inspected on the same day.

BLOCK 7 - **NSN/SMIC**

Enter the National Stock Number (NSN), including the SMIC, of material received. If material is identified only by drawing and piece number, enter them.

BLOCK 8 - **VENDOR'S MARKINGS**

- a. Enter any Vendor's Marking (heat, lot) present on the material.
- b. For fasteners, enter the heat/lot number, material type, and manufacturer's symbol (for nuts containing a self-locking insert, the color of the insert is the manufacturer's symbol).

BLOCK 9 - **REQUIRED CERTIFICATION DOCUMENTS FURNISHED (SIGNATURE AND DATE)**

- a. If required certification documentation is provided, and the item passes receipt inspection in accordance with Chapter 6, enter an "X" in the "YES" block. Controlled Material Petty Officer (CMPO)/Controlled Material Handler (CMH) print name, sign and date the block to certify the item passed receipt inspection. Blocks 10 through 15 are left blank. Attach a QA form 2. A copy of any certification documentation will be attached to the QA form 1.
- b. If the certification documentation is unacceptable or the material fails receipt inspection or the item is non-level material undergoing upgrading, enter an "X" in the "NO" block, attach a QA form 3 to the item, and notify the Quality Assurance Officer (QAO)/Quality Assurance Supervisor (QAS). CMPO/CMH print name, sign and date the block.

BLOCK 10 - **ENTER APPROPRIATE CODE**

QAO/QAS will mark the applicable blocks signifying attributes that must be verified for receipt inspection, by referring to the appropriate references, using the appropriate code; "X" (whenever records are required) or "O" (whenever records are not required, e.g., visual inspection).

BLOCK 11 - **INSPECTION RESULTS, REMARKS, SIGNATURE AND DATE**

- a. CMPO/Quality Assurance Inspector (QAI)/QAS will enter the results of all inspections and, if unsatisfactory, state the reason for failure.
- b. Print name, sign and date all entries which certifies the above inspections, issues, and records.

NOTE: BLOCKS 12, 13 AND 14 ARE COMPLETED AS REQUIRED, INCOMPLETE BLOCKS ARE LEFT BLANK.

BLOCK 12 - **DISPOSITION**

Check the appropriate block based upon inspection results documented in Block 11 and fill out Blocks 13 or 14 as applicable.

BLOCK 13 - **CERTIFIED**

Check the appropriate block signifying the level of essentiality to which the material has been inspected/certified. For SOC material, enter the applicable MCD designator (A or B) in the blank.

NOTE: NON-LEVEL ITEMS UPGRADED OR CERTIFIED WILL HAVE THE ASSIGNED MIC NUMBER ENTERED IN BLOCK 3 ABOVE PRIOR TO SIGNATURE IN BLOCK 15.

BLOCK 14 - **DOWNGRADE**

Check the appropriate block, if “reject” is checked in Block 12.

BLOCK 15 - **SIGNATURE AND DATE**

QAO/QAS responsible for Blocks 10-14 will print name, sign and date certifying the record as correct.

BLOCK 16 - **Same as Block 1.**

BLOCK 17 - **Same as Block 2.**

BLOCK 18 - **Same as Block 3.**

BLOCK 19 - **Same as Block 4.**

BLOCK 20 - **Same as Block 7.**

BLOCK 21 - **Same as Block 6.**

BLOCK 22 - **Enter the date that the material is issued.**

BLOCKS 23A, 23B, AND 23C - **Enter the Unit Identification Code (UIC), Work Center (WC), and the job sequence number that the material is issued against.**

BLOCK 24 - **Enter the system that the material is issued for.**

BLOCK 25 - **Enter the Controlled Work Package (CWP) serial number that the material is issued for.**

BLOCK 26 - **Enter the amount of material issued.**

BLOCK 27 - **Enter the amount of material remaining after issue.**

BLOCK 28 - **CMPO/CMH issuing material, print name.**

BLOCK 29 - **Enter “Yes” or “No” as appropriate.**

BLOCK 30 - **Enter Level the material was downgraded to.**

BLOCK 31 - **QAO sign, signifying authorization to downgrade material.**

NOTE: THE COMPLETED QA FORM 1 WILL BE FORWARDED TO THE QA OFFICE, WHEN THE MATERIAL HAS BEEN ISSUED FOR INSTALLATION.

(This Page Intentionally Left Blank)

QA FORM 2

MATERIAL ID/CONTROL TAG
LANTFLT 4790/2 (8-01) S/N 0103-LF-981-0300

MATERIAL IDENTIFICATION & CONTROL TAG RECEIPT INSPECTION / REMOVAL		
(1) TAG <u>(A)</u> OF <u>(B)</u>		
MIC NO/SERIAL NO:		(2)
MATL LEVEL <input type="checkbox"/> NEW <input type="checkbox"/> EXISTING (3)		
<input type="checkbox"/> LI / NUC LI <input type="checkbox"/> SFCC <input type="checkbox"/> SOC <input type="checkbox"/> OTHER		
MATL DESCRIPTION (4)		
NSN/SMIC (5)		
RECEIPT INSPECTION COMMENTS (6)		
RECEIPT INSPECTION IS SATISFACTORY AND MATERIAL IS ACCEPTABLE FOR USE		
CMPO/CMH (7)		DATE _____
UIC	WC	JCN
CWP SER. NO. (8)		
QA FORM 2		

IN PROCESS CONTROL ISSUE / FABRICATION / TRANSFER	
WC NO. _____ (9)	DATE _____ (10)
REMARKS _____ (11)	
(12)	
CRAFTSMAN/CMPO/CMH/QAI	
FABRICATION / TRANSFER	
WC NO. _____ (13)	DATE _____ (14)
REMARKS _____ (15)	
(16)	
CRAFTSMAN/CMPO/CMH/QAI	
FABRICATION / TRANSFER	
WC NO. _____ (13)	DATE _____ (14)
REMARKS _____ (15)	
(16)	
CRAFTSMAN/CMPO/CMH/QAI	
INSTALLATION / FABRICATION / TRANSFER	
WC NO. _____ (17)	DATE _____ (18)
REMARKS _____ (19)	
(20)	
CRAFTSMAN _____	
INSPECTOR _____ (21)	DATE _____
QA FORM 2	

(This Page Intentionally Left Blank)

QA FORM 2 INSTRUCTIONSMATERIAL IDENTIFICATION (ID)/CONTROL TAG
LANTFLT 4790/2 (8-01) S/N 0103-LF-981-0300PURPOSE:

1. Used for receipt inspection, certification and traceability of new controlled material.
2. Used to maintain traceability and identification of Level I, Nuclear Level I, SOC, SFCC and non-level controlled items removed from a controlled system or component during maintenance including transfer between organizations until reinstalled.

PROCEDURE: The numbered blocks on QA form 2 correspond with the instructions listed below. Two sets of instructions are provided depending on purpose.

PURPOSE 1: RECEIPT OF NEW MATERIAL FROM SUPPLY SYSTEM.
CMPO/CMH WILL COMPLETE BLOCKS 1-7 DURING THE RECEIPT INSPECTION.

NOTE 1: FOR NUCLEAR MATERIAL, ANY RFI OR OTHER CERTIFICATION TAGS ATTACHED TO THE ITEM WILL REMAIN ATTACHED UNTIL THE MATERIAL IS INSTALLED.

NOTE 2: FOR NUCLEAR LEVEL I MATERIAL, ALL SIGNATURES MADE ON QA-FORM 2 (MATERIAL IDENTIFICATION AND CONTROL TAG) ARE CONSIDERED TO BE CERTIFICATION SIGNATURES AS DEFINED IN NAVSEAINST 9210.23 AND ADDENDUM B-1 OF PART 2, CHAPTER 1 OF THIS VOLUME. THE INDIVIDUAL RESPONSIBLE FOR PERFORMING THE CERTIFICATION SHALL BE INDICATED IN EACH SIGNATURE BLOCK ON THE QA FORM 2 AND THAT PERSON SHALL UNDERSTAND HIS/HER SIGNATURE TO INDICATE THE FOLLOWING: *"THE PERSON DESIGNATED TO SIGN FOR AN ACTION VERIFIES, BASED ON PERSONAL OBSERVATION, AND CERTIFIES BY THEIR SIGNATURE THAT THE ACTION HAS ACTUALLY BEEN PERFORMED IN ACCORDANCE WITH THE SPECIFIED REQUIREMENTS."*

NOTE 3: IF PORTIONS OF A COMPONENT WILL BE CANNABALIZED FOR INSTALLATION VICE INSTALLING THE ENTIRE COMPONENT, ATTACH A QA FORM 2 (PURPOSE 1 INSTRUCTIONS) TO THE PORTIONS OF THE COMPONENT OR ASSEMBLY TO BE INSTALLED IN THE SYSTEM. REMOVE THE ORIGINAL QA FORM 2 (DISCARD) AND ATTACH A NEW QA FORM 2 (PURPOSE 1 INSTRUCTIONS) DOCUMENTING THE ACTUAL CONFIGURATION OF THE REMAINING PORTION OF THE ORIGINAL ASSEMBLY. DISPOSITION IN ACCORDANCE WITH PART I, CHAPTER 6, PARAGRAPH 6.3.9.1.D OF THIS VOLUME.

BLOCK 1 - TAG (A) OF (B)

- a. Block A – Enter "1". For additional tags used during the fabrication/transfer/installation process, number the tags in sequential order as used (2, 3, 4, etc.).
- b. Block B - The last number reflects the total number of tags used for this item during this maintenance action. This block is filled in by the craftsman at the time Block 20 is signed for non-SUBSAFE/non-SOC systems. For SUBSAFE, Nuclear or SOC systems, this block is filled in by the QAI at the time Block 21 is signed on the last tag (e.g., 3 of 3).

BLOCK 2 - MIC NO./SERIAL NO.

NOTE: THE INFORMATION ENTERED FOR FASTENERS MAY NEED TO INCLUDE INFORMATION FROM BLOCKS 3 AND 8 FROM QA-1. DO NOT ENTER THE PNSY TRACE NUMBER FROM BLOCK 3 OF THE QA-1.

- a. New Material: Enter the MIC etched on the material. If the component has no MIC or a shortened MIC marking, ensure the full MIC marking from the shipping documents, tags, and/or packaging is entered. For Flight Critical Components, enter the component serial number.
- b. Fasteners: Document the markings from the fastener to include either:
 - (1) The color code and the heat/lot number, material type, and manufacturer's symbol (for nuts containing a self-locking insert, the color of the insert is the manufacturer's symbol).

- (2) The MIC number (when MIC number is on the fastener or on the individual tag for some small fasteners).

BLOCK 3 - **MAT LEVEL**

Check the NEW block and the appropriate block for Level of Essentiality [e.g., check LI/NUC LI, if Level I or Nuclear Level I, or check SOC, if Scope of Certification, SFCC, or check "OTHER" (e.g., SAED Controlled)]. This block should be the same as the "Level" on the QA form 1.

BLOCK 4 - **MATL DESCRIPTION**

Enter the quantity, size and noun name of the material (e.g., (6 each) 5/8" - 11 NICU studs, 10" O.D. CUNI barstock 6" long).

BLOCK 5 - **NSN/SMIC**

Enter the NSN, including SMIC, of the material. If none, enter "NONE".

BLOCK 6 - **RECEIPT INSPECTION COMMENTS**

Enter receipt inspection results (i.e., SAT or UNSAT). If inspection results are UNSAT in Block 6, initiate a QA form 3. For UNSAT results in Block 6, the CMPO will only sign Block 7 of the QA form 2 if the QAO dispositions the item suitable for use on Block 12 of the QA form 3. For SAT receipt inspection of SOC MCD Level A or B material received without an RFI tag or an EB Blue tag, enter the following statement with the blank having the appropriate A or B entered:

"Material Receipt Inspected SAT and is certified as SOC MCD ____."

This entry will be signed by the QAO.

For SAT receipt inspection of SOC MCD A or B material received with an RFI tag or an EB Blue tag, enter the MCD Level (i.e., MCD A or MCD B) after the receipt inspection results.

BLOCK 7 - **CMPO/CMH**

CMPO/CMH certifying the entries in Blocks 1-7 print name, enter signature and date.

NOTE 1: THE CMPO WILL VERIFY THAT THE ITEM IS WHAT IS REQUIRED FOR INTENDED USE PRIOR TO TURNING THE MATERIAL OVER TO CRAFTSMAN FOR FABRICATION AND/OR INSTALLATION AND FILL IN BLOCKS 8 THROUGH 12 AT THE TIME THE MATERIAL IS ISSUED.

NOTE 2: IF A PARTIAL ISSUE IS MADE (E.G., A SECTION OF BARSTOCK IS CUT OFF A LARGER PORTION OR ONLY 4 OF 12 NUTS IN A BOX ARE USED), THE CMPO MAKING THE ISSUE WILL COMPLETE BLOCKS 1-12 OF A NEW QA FORM 2 FOR THE PARTIAL ISSUE IN ACCORDANCE WITH PART I, CHAPTER 6, PARAGRAPH 6.3.9 OF THIS VOLUME AND UPDATE THE ASSOCIATED QA-FORM 1. THE ORIGINAL OR "PARENT" QA-FORM 2 DOCUMENTING ORIGINAL RECEIPT OF MATERIAL WILL NOT BE MODIFIED. THE QA-FORM 1 WILL TRACK DISTRIBUTION OF MATERIAL.

BLOCK 8 - **UIC, WC, JSN AND CWP SERIAL NO.**

At the time of issue, enter the Job Control Number (JCN) [UIC, WC and Job Sequence Number (JSN)] and CWP serial number.

BLOCK 9 - **WC NO.**

Enter the number of the WC receiving material (e.g., EM01, 10C, 38A).

BLOCK 10 - **DATE**

Enter date the WC received the material.

BLOCK 11 - **REMARKS**

Enter the reason for issue (e.g., issued to 31A for manufacture of fitting, issued to EM01 for installation).

BLOCK 12 - **CRAFTSMAN/CMPO/CMH/QAI**

For Initial Material Issue: Print name, enter signature signifying issue of material by CMPO/CMH. For Fabrication/Transfer (Additional QA form(s) 2 required). Print name, enter signature signifying receipt of material.

NOTE: THE REMAINING SECTIONS OF THE TAG ARE COMPLETED BY THE COGNIZANT CRAFTSMAN/CMPO/CMH/QAI DURING THE FABRICATION/INSTALLATION PROCESSES.

NOTE: SATISFACTORY CONDITION OF MATERIAL EXCHANGED BETWEEN WCs IS ASSUMED, UNLESS AN ENTRY IS MADE IN REMARKS INDICATING MATERIAL IS REJECTED.

BLOCK 13 - **WC NO.**

Enter the number of the WC receiving material (e.g., 56A or EA01).

BLOCK 14 - **DATE**

Enter date material received.

BLOCK 15 - **REMARKS**

Record work performed while the material was in the custody of the WC (e.g., drilled screws and installed Nylock pellets).

BLOCK 16 - **CRAFTSMAN/CMPO/CMH/QAI**

Cognizant craftsman print name and sign to certify the above blocks are complete and correct.

NOTE: IF 2 OR MORE WCs ARE INVOLVED IN THE FABRICATION PROCESS, ADDITIONAL QA FORMS 2 WILL BE FILLED OUT AND NUMBERED IN ACCORDANCE WITH THE INSTRUCTIONS ABOVE FOR BLOCK 1.

NOTE: IF FOR ANY REASON THE COGNIZANT CRAFTSMAN REJECTS THE MATERIAL HE/SHE WILL COMPLETE AND ATTACH A MATERIAL REJECT TAG (QA FORM 3) AND LEAVE THE QA FORM 2 ATTACHED.

NOTE: BLOCKS 17 THROUGH 21 WILL CONTAIN THE RECORD OF FINAL INSTALLATION. IF ADDITIONAL TAGS ARE REQUIRED FOR THE MATERIAL DURING THE FABRICATION AND TRANSFER PROCESS (MORE THAN TWO WCs/PROCESSES INVOLVED IN THE REPAIR), BLOCKS 9 THROUGH 12 AND BLOCKS 17 THROUGH 21 MAY BE USED.

BLOCK 17 - **WC NO.**

Enter the number of the WC responsible for installation of the material (e.g., 56A or EA01).

BLOCK 18 - **DATE**

Enter the date of installation.

BLOCK 19 - **REMARKS**

Enter the location where the material was installed into the system or component (e.g., installed in AHP-514, installed in system at joints ASW-70014(F) and ASW-70015(F), etc.).

BLOCK 20 - **CRAFTSMAN**

Cognizant craftsman print name and enter signature signifying that the material is the correct material, is installed correctly and in accordance with the applicable technical specifications. Remove the QA form 2 and file with the CWP if a QAI is not required.

NOTE: A QAI INSPECTION IS REQUIRED FOR NEW MATERIAL INSTALLATIONS FOR JOINTS AND ASSEMBLIES WITHIN THE HULL INTEGRITY BOUNDARY (INCLUDING ELECTRICAL HULL FITTING (EHF) TO PRESSURE HULL JOINTS), SOC JOINTS AND COMPONENTS, SUBSAFE SEAWATER/SEA-CONNECTED FLANGED PIPE JOINTS, AND ALL NUCLEAR LEVEL I SYSTEM JOINTS AND COMPONENTS.

BLOCK 21 - INSPECTOR

When required, inspector print name and enter signature and date certifying that the material is the correct material, acceptable for application and correctly installed. Enter NA in QAI signature space when QAI is not required. Remove the QA form 2 and file with the CWP.

NOTE: IF, FOR ANY REASON, A CRAFTSMAN/CMPO/CMH/QAI REJECTS MATERIAL, THEY WILL COMPLETE AND ATTACH A QA FORM 3, LEAVING THE QA FORM 2 ATTACHED. TAG USED ITEMS WHICH MUST BE TURNED IN TO SUPPLY AND ANY ITEM WHICH IS NOT PROPERLY DISCARDED (E.G., AT THE END OF WORK DAY OR SHIFT).

NOTE: WHEN EXISTING CONTROLLED MATERIAL IS REINSTALLED INTO THE SYSTEM, THE QA FORM 2 WILL BE COMPLETED AND RETAINED WITH THE CWP UNTIL THE CWP IS CLOSED OUT. THE ACCOUNTABILITY FOR CONTROLLED MATERIAL REINSTALLATION IS ON THE APPLICABLE OBJECTIVE QUALITY EVIDENCE (OQE) RECORD (E.G., JOINT/COMPONENT REPAIR RECORD, QA FORM 34). THE QA FORM 2 MAY BE DISCARDED AFTER THE CWP IS CLOSED OUT.

PURPOSE 2: UPON REMOVAL FROM SYSTEM OR COMPONENT (EXISTING MATERIAL).

NOTE 1: FOR NUCLEAR LEVEL I MATERIAL, ALL SIGNATURES MADE ON QA-FORM 2 (MATERIAL IDENTIFICATION AND CONTROL TAG) ARE CONSIDERED TO BE CERTIFICATION SIGNATURES AS DEFINED IN NAVSEAINST 9210.23 AND ADDENDUM B-1 OF PART 2, CHAPTER 1 OF THIS VOLUME. THE INDIVIDUAL RESPONSIBLE FOR PERFORMING THE CERTIFICATION SHALL BE INDICATED IN EACH SIGNATURE BLOCK ON THE QA FORM 2 AND THAT PERSON SHALL UNDERSTAND HIS/HER SIGNATURE TO INDICATE THE FOLLOWING: *“THE PERSON DESIGNATED TO SIGN FOR AN ACTION VERIFIES, BASED ON PERSONAL OBSERVATION, AND CERTIFIES BY THEIR SIGNATURE THAT THE ACTION HAS ACTUALLY BEEN PERFORMED IN ACCORDANCE WITH THE SPECIFIED REQUIREMENTS.”*

NOTE 2: DAMAGED EXISTING MATERIAL REMOVED FROM CONTROLLED SYSTEMS WHICH IS NOT INTENDED TO BE REPAIRED OR REUSED AND IS INTENDED TO BE DISPOSED OF AS TRASH DOES NOT REQUIRE A QA FORM 2 TO BE ATTACHED PROVIDED THE MATERIAL IS IMMEDIATELY DISCARDED. EXAMPLES OF THIS ARE DAMAGED VALVE STEMS, DAMAGED COMPONENT FASTENER NUTS AND STUDS. DOES NOT APPLY TO TURN-IN ITEMS SUCH AS DEPOT LEVEL REPAIRABLE.

BLOCK 1 - TAG (A) OF (B)

- a. Number the tags in sequential order as used (e.g., 1, 2, 3, etc.).
- b. The last number reflects the total number of tags written for each part removed from a disassembled component or system. This block is filled in by the craftsman at the same time Block 20 is signed for final installation of non-SUBSAFE/non-SOC systems. For SUBSAFE, Nuclear or SOC systems, the QAI will fill in this block at the time Block 21 is signed on the last tag (e.g., 3 of 3).

BLOCK 2 - MIC NO./SERIAL NO.

Enter the MIC etched on the material. If none, enter “NONE”. For fasteners enter either the MIC number (when MIC number is marked on the fastener) or the material marking, color code, heat/lot number, and manufacturer’s symbol (for nuts containing a self-locking insert, the color of the insert is the manufacturer’s symbol). For rotatable items enter the appropriate rotatable pool serial number (e.g., rp-148a, tin-292-11893, etc.). For Flight Critical Components, enter the component serial number.

BLOCK 3 - MAT LEVEL

Check the EXISTING block and the appropriate block for Level of Essentiality [e.g., check LI/NUC LI, if Level I or Nuclear Level I, or check SOC if Scope Of Certification, SFCC, or check “OTHER” (e.g., SAED Controlled)].

BLOCK 4 - MATL DESCRIPTION

Enter the quantity, size and noun name of the material (e.g., 6 each, 5/8” - 11 NICU studs, AHP-56 4500/2000 PSI Reducer).

BLOCK 5 - NSN/SMIC

Enter "NA".

BLOCK 6 - RECEIPT INSPECTION COMMENTS

Enter "NA".

BLOCK 7 - CMPO/CMH

Enter "NA".

BLOCK 8 - UIC, WC, JCN AND CWP SERIAL NO.

Enter the JCN, consisting of the UIC, WC, JSN, and CWP serial number in the appropriate blocks.

NOTE: CAUTION MUST BE TAKEN WHEN USING THE WORDS "REPAIRED", "REINSTALLED" TO ENSURE THAT THESE WORDS ARE USED PROPERLY.

TAG BACK SIDE

(This side is filled out by the QAI, CMPO, CMH or craftsman).

BLOCK 9 - WC NO.

Enter the number of the WC which completed Blocks 1-8 of the tag (e.g., 56X, EA01).

BLOCK 10 - DATE

Enter date material removed from system or component.

BLOCK 11 - REMARKS

Enter information regarding why component was removed (e.g., removed for repair of valve seats, removed for transfer to AS-40 for repair and testing).

BLOCK 12 - CRAFTSMAN/CMPO/CMH/QAI

The cognizant craftsman will print name and sign.

NOTE: IF MORE THAN ONE WC IS INVOLVED IN THE FABRICATION/REPAIR PROCEDURE, BLOCKS 13-16 WILL BE FILLED OUT BY THE COGNIZANT CRAFTSMAN IN THE SAME MANNER AS BLOCKS 9 THROUGH 12 AS THE ITEM IS TRANSFERRED FROM ONE WC TO ANOTHER FOR FABRICATION, ETC. FOR A TOTAL SHIP'S FORCE JOB, THESE BLOCKS ARE NORMALLY "NA", UNLESS ANOTHER WC HAS TO DO SOMETHING TO THE MATERIAL.

If used for transfer of material between organizations, Blocks 13-16 will be filled out by the receiving activity as follows:

BLOCK 13 - WC NO.

Enter the number of the WC receiving material (e.g., 56A, 38C).

BLOCK 14 - DATE

Enter date material received.

BLOCK 15 - REMARKS

Record work performed while in the custody of the WC.

BLOCK 16 - CRAFTSMAN/CMPO/CMH/QAI

Cognizant individual will print name and sign that all work performed was completed satisfactorily and in accordance with applicable technical requirements. This signature will be made prior to transferring the material back to the original organization from which it was received.

NOTE: BLOCKS 17 THROUGH 21 WILL CONTAIN THE RECORD OF FINAL INSTALLATION. IF ADDITIONAL TAGS ARE REQUIRED FOR THE MATERIAL DURING THE FABRICATION AND TRANSFER PROCESS (MORE THAN TWO WCs/PROCESSES INVOLVED IN THE REPAIR), BLOCKS 9 THROUGH 12 AND BLOCKS 17 THROUGH 21 MAY BE USED.

BLOCK 17 - WC NO.

Enter WC responsible for installation.

BLOCK 18 - DATE

Enter date of final installation.

BLOCK 19 - REMARKS

Enter the location where the material was installed into the system or component (e.g., installed in AHP-514, installed in system at joints ASW-70014(F) and ASW-70015(F), etc.).

BLOCK 20 - CRAFTSMAN

Cognizant craftsman print name and enter signature signifying that the material is installed correctly and in accordance with applicable technical specifications. Remove the QA form 2 and file with the CWP.

NOTE: QAI VERIFICATION IS REQUIRED FOR NUCLEAR LEVEL I PRESSURE BOUNDARY JOINTS OR WHEN TRANSFERRED/CANNIBALIZED MATERIAL IS INSTALLED WITHIN THE SUBSAFE OR SOC BOUNDARY.

BLOCK 21 - INSPECTOR

When required, inspector print name, and enter signature and date certifying that the material is the correct material, acceptable for application and correctly installed. Remove the QA form 2 and file with the CWP.

NOTE: IF, FOR ANY REASON, A CRAFTSMAN/CMPO/CMH/QAI REJECTS MATERIAL THEY WILL COMPLETE AND ATTACH A QA FORM 3, LEAVING THE QA FORM 2 ATTACHED. TAG USED ITEMS WHICH MUST BE TURNED IN TO SUPPLY AND ANY ITEM WHICH IS NOT PROMPTLY DISCARDED (E.G., AT THE END OF WORK DAY OR SHIFT).

NOTE: WHEN EXISTING CONTROLLED MATERIAL IS REINSTALLED INTO THE SYSTEM THE QA-2 WILL BE COMPLETED AND RETAINED WITH THE CWP UNTIL THE CWP IS CLOSED OUT. THE ACCOUNTABILITY FOR CONTROLLED MATERIAL REINSTALLATION IS ON THE APPLICABLE OQE RECORD (E.G., JOINT/COMPONENT REPAIR RECORD, QA-34). THE QA-2 MAY BE DISCARDED AFTER THE CWP IS CLOSED OUT.

QA FORM 3

CONTROLLED MATERIAL REJECT TAG

CONTROLLED MATERIAL REJECT TAG QA FORM 3	
PART I	
1. MIC/ID NUMBER	
2. <input type="checkbox"/> L/I	<input type="checkbox"/> NUC L/I
<input type="checkbox"/> MIL-SPEC	<input type="checkbox"/> OTHER
3. REASON	
4. REJECTED BY _____ DATE _____	
PART III	
FINAL DISPOSITION BY QA	
9. ACCEPT AS:	
10. DOWNGRADE TO:	
11. RETURN TO SOURCE	
12. REMARKS	

13. QAO APPROVED	
PART II	
QA DISPOSITION REQUEST	
5. MIC NO.	
6. LOCATION	
7. REASON	

8. DIVISION OFFICER	DATE

Red tag with black lettering.

(This Page Intentionally Left Blank)

QA FORM 3 INSTRUCTIONS
CONTROLLED MATERIAL REJECT TAG
 S/N 0103-LF-655-1300

PURPOSE: This tag provides visual evidence and identification of rejected material or material in a hold status, and a request for QAO evaluation for final disposition.

NOTE: DAMAGED EXISTING MATERIAL REMOVED FROM CONTROLLED SYSTEMS WHICH IS NOT INTENDED TO BE REPAIRED OR REUSED AND IS INTENDED TO BE DISPOSED OF AS TRASH DOES NOT REQUIRE A QA FORM 3 TO BE ATTACHED PROVIDED THE MATERIAL IS IMMEDIATELY DISCARDED. EXAMPLES OF THIS ARE DAMAGED VALVE STEMS, DAMAGED COMPONENT FASTENER NUTS AND STUDS. DOES NOT APPLY TO TURN-IN ITEMS SUCH AS DEPOT LEVEL REPAIRABLE. ALL MIC MARKINGS ON DAMAGED MATERIAL WILL BE REMOVED OR OBSCURED TO PREVENT INADVERTENT REUSE.

PROCEDURE:

- a. Part I and Blocks 5 through 7 of Part II are filled out by personnel attaching the tag.
- b. Attach filled out tag to the material.
- c. Person attaching the tag will remove Part II, and forward to the QAO/QAS via the division officer.
- d. The QAO will determine the final disposition and fill out Part III.
- e. The numbered blocks on QA form 3 correspond with the instructions listed below.

PART I

BLOCK 1 - **MIC/SERIAL NO.**

Enter the MIC, serial number or other identifying permanent marking etched on the material, or if the item does not have a MIC number/serial number/other identifying marking visible, enter none or existing, as appropriate. Enter the same in Block 5.

BLOCK 2 - **MATL LEVEL**

Check the appropriate block indicating the Level of Essentiality for the material or fill in the blank for "other". When "other" is selected, enter in the amplifying remarks why the material is being tagged (e.g., SAED, Controlled or SOC).

BLOCK 3 - **REASON**

Enter the reason for rejection of the material (be explicit). Example: "Invalid MIC marking", "Linear indications on weld". Provide as much applicable information as possible concerning the item (e.g., rejection form(s) (Departure From Specification (DFS), Quality Deficiency Report, etc.), Drawing No., Piece No., Contract, Stock No., Control Work Procedure, etc.).

BLOCK 4 - **REJECTED BY/DATE**

Cognizant individual print name, enter signature and date rejected.

PART II - **QA DISPOSITION REQUEST**

BLOCK 5 - **MIC/SERIAL NO.**

Enter the same information that is in Block 1.

BLOCK 6 - **LOCATION**

Enter exact location of material (e.g., Rejected Material Locker WC 38A).

BLOCK 7 - **REASON**

Enter the reason why the rejected material should be released (e.g., located Nondestructive Test (NDT) records for material, etc.).

BLOCK 8 - REQUESTED BY

Cognizant division officer print name and enter signature.

NOTE: REMOVE AND FORWARD THE COMPLETED PART II OF THE REJECT FORM TO THE QAO VIA THE DIVISION OFFICER. SHIPS MAY NEED ASSISTANCE FROM THE FMA QAO IN DISPOSITIONING THE MATERIAL.

PART III - FINAL DISPOSITION BY QA

Enter all data used to determine final disposition.

BLOCK 9 - ACCEPT AS

Enter the level of essentiality to which the item is to be accepted (e.g., Non-Level to Level I) A DFS may be required. If this item will not be accepted mark this blank "NA".

BLOCK 10 - DOWNGRADE TO

Enter Level of Essentiality to which the item is to be downgraded. If it is to be returned to source enter "NA" or "None".

BLOCK 11 - RETURN TO SOURCE

If to be returned to source, place an "X" or check in the block.

BLOCK 12 - REMARKS

Enter any remarks needed to explain the disposition of the material or why a particular decision was made. Identify the Objective Quality Evidence (OQE)/technical justification or documentation which authorizes use/disposal of material (e.g., DFS, Liaison Action Record (LAR), waivers, deviations, etc.).

BLOCK 13 - QA OFFICER SIGNATURE AND DATE

QAO who made the disposition decision print name, enter signature and date. The tag shall stay with the material. Upon installation of the material, remove the tag and return to the QAO.

MAINTENANCE CERTIFICATION RECORD/RE-ENTRY CONTROL
QA FORM 9

1. PAGE 1 OF

2. <input type="checkbox"/> SUBSAFE/RE-ENTRY <input type="checkbox"/> NUCLEAR <input type="checkbox"/> LEVEL I <input type="checkbox"/>		SCOPE OF CERTIFICATION <input type="checkbox"/> SFCC <input type="checkbox"/> OTHER	
3. SHIP HULL		4. CWP/REC SERIAL NO. REV.	
5. J.O./JCN		6. ASSOCIATED CWP(s)/REC(s)	
7. ORIGINATOR BADGE/GRADE/RANK		8. ORGANIZATION	
9. SYSTEM REPAIRED/RE-ENTERED		10. REPAIR/RE-ENTRY LOCATION	
11. COMPONENT(s)			
WORK DESCRIPTION INCLUDING BOUNDARIES			
12. JID MAP/DWG WITH REV			
13. WORK AND TESTING TO BE PERFORMED AND WORK AND TEST REFERENCE DOCUMENTS			
14. APPLICABLE JOINT NO(s), OR IF NOT SUPPLIED. SPECIFIC BOUNDARIES			
APPROVAL FOR CONTROLLED WORK/RE-ENTRY			
15A. PRIME APPROVAL SIGNATURE LEGIBLY PRINTED, TYPED OR STAMPED NAME & BADGE/GRADE/RANK			DATE
15B. PRIME APPROVAL SIGNATURE LEGIBLY PRINTED, TYPED OR STAMPED NAME & BADGE/GRADE/RANK			DATE
15C. PRIME APPROVAL SIGNATURE LEGIBLY PRINTED, TYPED OR STAMPED NAME & BADGE/GRADE/RANK			DATE
15D. PRIME APPROVAL SIGNATURE LEGIBLY PRINTED, TYPED OR STAMPED NAME & BADGE/GRADE/RANK			DATE
VERIFICATION AND CERTIFICATION			
16. SUPPORTING DOCUMENTATION			
VERIFICATION OF WORK COMPLETION			
17. THE PRODUCTION WORK DESCRIBED BY THIS MCR / REC HAS BEEN ACCOMPLISHED IN ACCORDANCE WITH THE SPECIFIED INSTRUCTIONS AND THE REQUIRED DOCUMENTATION LISTED IN BLOCK 16 HAS BEEN COMPLETED, REVIEWED AND IS CORRECT.			DATE
APPROVAL SIGNATURE LEGIBLY PRINTED, TYPED OR STAMPED NAME & BADGE/GRADE/RANK			
CERTIFICATION OF DOCUMENTATION OF PRODUCTION WORK			
18. ALL DOCUMENTATION AND CERTIFICATION FOR PRODUCTION WORK SPECIFIED IN BLOCK 16 HAS BEEN COMPLETED. THE DOCUMENTATION HAS BEEN REVIEWED FOR ACCURACY AND COMPLETENESS.			DATE
APPROVAL SIGNATURE LEGIBLY PRINTED, TYPED OR STAMPED NAME & BADGE/GRADE/RANK			
CERTIFICATION OF TESTING RESULTS			
19. THE TESTING INVOKED FOR THIS MCR HAS BEEN COMPLETED. THE TEST DOCUMENTATION SPECIFIED IN BLOCK 16 HAS BEEN REVIEWED FOR ACCURACY AND COMPLETENESS.			DATE
APPROVAL SIGNATURE LEGIBLY PRINTED, TYPED OR STAMPED NAME & BADGE/GRADE/RANK			
FINAL MCR CLOSEOUT CERTIFICATION			
20. ALL CERTIFICATIONS RELATED TO THIS MCR HAVE BEEN REVIEWED FOR CORRECTNESS AND VERIFIED TO BE COMPLETE. I CERTIFY THIS QA CERTIFICATION/RE-ENTRY IS CLOSED.			DATE
PRIME APPROVAL SIGNATURE LEGIBLY PRINTED, TYPED OR STAMPED NAME & BADGE/GRADE/RANK			
21. SHIP'S COMMANDING OFFICER SIGNATURE LEGIBLY PRINTED, TYPED OR STAMPED NAME & GRADE/RANK			DATE

(This Page Intentionally Left Blank)

QA FORM 9 INSTRUCTIONSMAINTENANCE CERTIFICATION RECORD/RE-ENTRY CONTROLPURPOSE:

NOTE: "N/A" ALL UNUSED BLOCKS.

1. This form is used to authorize and certify maintenance within SUBSAFE, Nuclear Level I, Level I, SOC or SFCC boundaries and is used as a CWP cover sheet.
2. The instructions are broken down into two separate situations.

SITUATION 1. CONTROLLED WORK/SUBSAFE RE-ENTRY CONTROL BY SHIP'S FORCE ONLY.

- a. The following instructions contain the minimum information and controls necessary to maintain certified systems on board ship when work is performed by Ship's Force on a certified ship.
- b. Each block number on the Maintenance Certification Record (MCR)/Re-Entry Control (REC), QA form 9 corresponds to the same number below. The number identifies the purpose and use of the entry on the MCR/REC.
- c. Each block will be filled in/signed by the personnel assigned or their authorized representatives. Such authorized representatives will be designated in writing in an approved ship's instruction.

BLOCK 1 - PAGE 1 OF

Enter the total number of pages (QA form 9 plus any QA form 10 used as a supplement, should normally be 1 of 2).

BLOCK 2 - SUBSAFE/REC NUCLEAR LEVEL I SCOPE OF CERTIFICATION
 SFCC OTHER

Check or "X" the appropriate block(s) and, if "OTHER" is checked, will enter the appropriate level of control (e.g., P-1, P-3a, P-LT).

BLOCK 3 - SHIP HULL NO.

Enter ship's name and hull number.

BLOCK 4 - CWP SERIAL NO.

Obtain the next CWP serial number from the ship's QAO and enter in the block. Revision "-"(dash) will be entered on the initial version of all MCR/RECs. When a revision is required, enter the next revision letter. If necessary, prepare a new MCR/REC using the original numbers plus the next revision letter. Upon issuance of each REC revision, all prior revisions are canceled and superceded and shall be so annotated and retained as OQE. A REC revision must go through the same approval process as the original REC. REC Supplement or continuation sheets (QA-10) shall not be used as an alternate to revision of the REC.

BLOCK 5 - J.O./JCN

Enter the JCN for the maintenance action.

BLOCK 6 - ASSOCIATED CWP(s)/REC(s)

Shipyard use only.

BLOCK 7 - ORIGINATOR

Enter the name (and badge/grade/rank) of the person preparing the CWP.

BLOCK 8 - ORGANIZATION

Enter the division of the person preparing the CWP.

BLOCK 9 - SYSTEM REPAIRED/RE-ENTERED

Enter the system(s) being repaired/re-entered.

BLOCK 10 - REPAIR/RE-ENTRY LOCATION

Enter the physical location of the work.

BLOCK 11 - COMPONENT(S)

Enter the noun name of the component(s) being repaired/re-entered.

BLOCK 12 - JID MAP/DWG WITH REV

- a. Enter the number and revision of the appropriate mapping drawing(s) for the work. If no mapping drawing is available, list the most appropriate arrangement or component drawing or diagram. For component repair, enter the applicable document (Standard Navy Valve Drawing, Vendor Drawing, etc.) which depicts the disturbances of the item (work in place or shop work). Based on the scope of work planned, several drawings may need to be referenced. If necessary, local sketches are authorized.
- b. The general order of precedence for entering Joint Identification (JID) is:
 - (1) JID number from the SUBSAFE Joint Mapping Plan, if there is one.
 - (2) JID number from the Joint Index Drawing, ship or class, for welding.
 - (3) Joint description/JID from Assembly or Arrangement/Installation Drawing. The drawing chosen must adequately portray the joints to be broken.
 - (4) Drawings/diagrams from technical manual.
 - (5) A locally prepared sketch where other alternatives do not adequately describe the joints to be broken. Since the sketch will not be retrievable elsewhere, it must be kept in the REC package as OQE.

BLOCK 13 - WORK AND TESTING TO BE PERFORMED AND WORK AND TEST REFERENCE DOCUMENTS

Enter the total scope of work and testing required for certification of this repair/re-entry (e.g., ripout, repair, restore, replace, reinstall). Enter the work and test description and make positive reference to the TWD, which contains the detailed work procedure, material requirements, testing and certification to be performed. If additional space is needed to properly identify all elements, then a QA form 10 will be used to supplement this block. The information provided in Block 6 does not need to be repeated in Block 13. The description of work on each REC revision shall detail the total revised Scope of Work. Cumulative partial descriptions do not satisfy this requirement.

BLOCK 14 - APPLICABLE JOINT NO(S), OR, IF NOT SUPPLIED, SPECIFIC BOUNDARIES

Enter the JID to be repaired/re-entered. If joint numbers are not supplied, specify boundaries in specific terms (e.g., body to bonnet joint of valve ASW-29) or assign local joint numbers. If local joint numbers are assigned, the sketch used to identify the joints must be included as OQE in the completed CWP. Listing of work boundary "end points" in lieu of listing discrete individual joints does not satisfy this requirement.

BLOCK 15 - PRIME APPROVAL SIGNATURE

- a. BLOCK 15A. The QAO will sign, legibly print or stamp his/her name and badge/grade/rank and enter the date indicating the package is technically correct.
- b. BLOCK 15B. The Department Head will sign, legibly print or stamp his/her name and badge/grade/rank and enter the date granting permission for work to be conducted. **No work can start prior to this signature.**
- c. BLOCK 15C. For nuclear system work, the ship's Commanding Officer (Reactor Officer for CVNs) will sign, legibly print or stamp his/her name and badge/grade/rank and enter the date granting permission for work to be conducted in accordance with Part I, Chapter 2, Appendix E of this Volume. No nuclear work can start prior to this signature. The Immediate Superior In Command (ISIC) Material Officer will counter sign and enter his/her badge/grade/rank to indicate review for testing of repair activity accomplished nuclear work in accordance with Part I, Chapter 2, Appendix E of this Volume. For oxygen, SUBSAFE, Scope of Certification or Safety of Flight Critical Component work, the ship's

Engineer Officer (Chief Engineer for CVNs) will sign, legibly print or stamp his/her name and badge/grade/rank and enter the date, granting permission for work to be conducted in accordance with Part I, Chapter 2, Appendix E of this Volume. **No nuclear, oxygen system, SUBSAFE, Scope of Certification or Safety of Flight Critical Component work can start prior to this signature.**

- d. BLOCK 15D. The Officer Of the Deck/Duty Officer or Engineering Officer of the Watch/Engineering Duty Officer, depending on the work to be performed, will sign, legibly print or stamp his/her name and badge/grade/rank and enter the date authorizing the work to start. The signature establishes the work and CWP start date and signifies that the system/component is in a condition to accomplish the work.

NOTE: COMPLETE BLOCKS 16, 17 AND 18 BEFORE PERFORMING ANY SHIPBOARD TESTING. IF REWORK BECOMES NECESSARY AS THE RESULT OF SHIPBOARD TESTING, THE REQUIREMENTS OF PART I, CHAPTER 2, PARAGRAPH 2.3.7.2 OF THIS VOLUME SHALL BE FOLLOWED. FOR SHIP-TO-SHOP MAINTENANCE, BLOCKS 16, 17 AND 18 DO NOT NEED TO BE COMPLETED FOR IN-PROCESS TESTING IDENTIFIED AS PART OF THE CWP "PROCEDURE" SECTION. AFTER COMPLETING THE PROCEDURE AND BEFORE PERFORMING THE CWP "TESTING AND INSPECTION" SECTION, COMPLETE BLOCKS 16, 17, AND 18.

BLOCK 16 - **SUPPORTING DOCUMENTATION**

The Lead Work Center (LWC) Division Officer will identify all supporting documentation required and generated as established by the CWP. For example, a typical entry would be: QA2(3), QA12(1), QA26(1), QA34(1), RFI Tag(1), LAR(2). List only QA form 2s for new material installed in the system or component. The cumulative documentation (OQE) shall be listed on the most current revision.

BLOCK 17 - **VERIFICATION OF WORK COMPLETION**

The LWC Division Officer will sign, legibly print or stamp his/her name (and badge/grade/rank) and enter the date certifying that the production work described by the MCR/REC has been accomplished in accordance with the specified instructions and that the required documentation for the production work as described in Block 16 has been completed, reviewed and is correct. When rework is identified following signing blocks 17 and 18, new signature/date blocks for blocks 17 and 18 shall be documented on a QA form 10.

BLOCK 18 - **CERTIFICATION OF DOCUMENTATION OF PRODUCTION WORK**

The QAO will sign, legibly print or stamp his/her name and badge/grade/rank and enter the date certifying that all documentation for the production work specified in Block 16 has been reviewed for accuracy and completeness and is complete and accurate. When rework is identified following signing blocks 17 and 18, new signature/date blocks for blocks 17 and 18 shall be documented on a QA form 10.

BLOCK 19 - **CERTIFICATION OF TESTING RESULTS**

The QAO will sign, legibly print or stamp his/her name and badge/grade/rank and enter the date certifying that the testing invoked for this MCR/REC has been completed satisfactorily. The test documentation specified in Block 16 has been completed, has been reviewed, and is complete and accurate.

BLOCK 20 - **FINAL MCR/REC CLOSEOUT CERTIFICATION**

The Department Head will sign, legibly print or stamp his/her name and badge/grade/rank and enter the date certifying that all documentation related to this MCR/REC has been reviewed for accuracy and completeness and is complete and accurate. For oxygen, SUBSAFE, Scope of Certification or Safety of Flight Critical Component work, the ship's Engineer Officer (Chief Engineer for CVNs) shall perform this certification and sign, legibly print or stamp his/her name and badge/grade/rank and enter the date.

BLOCK 21 - **SHIP'S COMMANDING OFFICER SIGNATURE**

The ship's Commanding Officer (Reactor Officer for CVNs) will sign, legibly print or stamp his/her name and grade/rank and enter the date acknowledging that the MCR/REC has been closed by the Department Head in accordance with Part I, Chapter 2, Appendix E of this Volume.

SITUATION 2. CONTROLLED WORK (NUCLEAR/LEVEL I/SOC/OTHER)/SUBSAFE REC BY REPAIR ACTIVITY AND SHIP OR REPAIR ACTIVITY ONLY.

- a. The following instructions contain the minimum information and controls necessary to maintain certified systems on board ship, or to document new work for eventual certification when work is performed by Ship's Force and a repair activity or by a repair activity only on a certified ship or component.
- b. Each block number on the MCR/REC, QA form 9 corresponds to the same number below. The number identifies the purpose and use of the entry on the MCR/REC.
- c. The planner will fill in Blocks 1 – 14. All other blocks will be filled in/signed by the personnel assigned or their authorized representatives. Such authorized representatives will be designated in writing in an approved ship's/activity's instruction.

BLOCK 1 - **PAGE 1 OF**

Enter the total number of pages (QA form 9 plus any QA form 10 used as a supplement).

BLOCK 2 - **[] SUBSAFE/REC [] NUCLEAR [] LEVEL I [] SCOPE OF CERTIFICATION [] SFCC [] OTHER**

Check or "X" the appropriate block(s) and, if "OTHER" is checked, will enter the appropriate level of control (e.g., P-1, P-3a, P-LT).

BLOCK 3 - **SHIP HULL NO.**

Enter ship's name and hull number.

BLOCK 4 - **CWP SERIAL NO.**

- a. For Ship's Force and FMA work, obtain the next CWP serial number from the ship's QAO and enter it in the block. For controlled or SUBSAFE work to be performed by the repair activity only (in repair activity shops and the repair activity does no work onboard the ship, examples include ship to shop work; rotatable pool assets) obtain the next CWP serial number from the FMA QAO and enter it in the block. Revision "-" (dash) will be entered on the initial version of all MCR/RECs. When a revision is required, enter the next revision letter. If necessary, prepare a new MCR/REC using the original numbers plus the next revision letter.
- b. For FMA work on a SUBSAFE system, the REC number will be obtained from the ship's QAO and entered after the CWP number (e.g., CWP/REC number). Upon issuance of each REC revision, all prior revisions are canceled and superceded and shall be so annotated and retained as OQE. A REC revision must go through the same approval process as the original REC. REC Supplement or continuation sheets (QA-10) shall not be used as an alternate to revision of the REC.

BLOCK 5 - **J.O./JCN**

Enter the JCN for the maintenance action.

BLOCK 6 - **ASSOCIATED CWP(s)/REC(s)**

Shipyards use only.

BLOCK 7 - **ORIGINATOR**

Enter the name (and badge/grade/rank) of the person preparing the CWP.

BLOCK 8 - **ORGANIZATION**

Enter the division of the person preparing the CWP.

BLOCK 9 - **SYSTEM REPAIRED/RE-ENTERED**

Identify the system(s) being repaired/re-entered.

BLOCK 10 - REPAIR/RE-ENTRY LOCATION

Identify the physical location (i.e., ship or shop) of the work.

BLOCK 11 - COMPONENT(S)

Identify the noun name of the component(s) being repaired/re-entered.

BLOCK 12 - JID MAP/DWG WITH REV

- a. Enter the number and revision of the appropriate mapping drawing(s) for the work. If no mapping drawing is available, list the most appropriate arrangement or component drawing or diagram. For component repair, enter the applicable document (Standard Navy Valve Drawing, Vendor Drawing, etc.) which depicts the disturbances of the item (work in place or shop work). Based on the scope of work planned, several drawings may need to be referenced. If necessary, local sketches are authorized.
- b. The general order of precedence for entering JID is:
 - (1) JID number from the SUBSAFE Joint Mapping Plan, if there is one.
 - (2) JID number from the Joint Index Drawing, ship or class, for welding.
 - (3) Joint description/JID from Assembly or Arrangement/Installation Drawing. The drawing chosen must adequately portray the joints to be broken.
 - (4) Drawings/diagrams from technical manual.
 - (5) A locally prepared sketch where other alternatives do not adequately describe the joints to be broken. Since the sketch will not be retrievable elsewhere, it must be kept in the REC package as OQE.

BLOCK 13 - WORK AND TESTING TO BE PERFORMED AND WORK AND TEST REFERENCE DOCUMENTS

Enter the total scope of work and testing required for certification of this repair/re-entry (e.g., ripout, repair, restore, replace, reinstall). Enter the work and test description and make positive reference to the TWD, which contains the detailed work procedure, material requirements, testing and certification to be performed. If additional space is needed to properly identify all elements, then a QA form 10 will be used to supplement this block. The information provided in Block 6 does not need to be repeated in Block 13. The description of work on each REC revision shall detail the total revised Scope of Work. Cumulative partial descriptions do not satisfy this requirement.

BLOCK 14 - APPLICABLE JOINT NO(S), OR, IF NOT SUPPLIED, SPECIFIC BOUNDARIES

Enter the JID to be repaired/re-entered. If joint numbers are not supplied, specify boundaries in specific terms (e.g., body to bonnet joint of valve ASW-29) or assign local joint numbers. If local joint numbers are assigned, the sketch used to identify the joints must be included as OQE in the completed CWP. Listing of work boundary "end points" in lieu of listing discrete individual joints does not satisfy this requirement.

BLOCK 15 - PRIME APPROVAL SIGNATURE

- a. BLOCK 15A. The QAO will sign, legibly print or stamp his/her name and badge/grade/rank and enter the date indicating the package is technically correct. **No work can start prior to this signature.**
- b. BLOCK 15B. The Department Head will sign, legibly print or stamp his/her name and badge/grade/rank and enter the date granting permission for work to commence. **No SUBSAFE work can start prior to this signature.**
- c. BLOCK 15C. For nuclear, oxygen, SUBSAFE, Scope of Certification or Safety of Flight Critical Component work, the ship's Engineer Officer (Reactor Officer for CVNs) will sign, legibly print or stamp his/her name and badge/grade/rank and enter the date, granting permission for work to be conducted. **No nuclear, oxygen system, SUBSAFE, Scope of Certification or Safety of Flight Critical Component work can start prior to this signature.**

- d. **BLOCK 15D.** The Officer Of the Deck/Duty Officer or Engineering Officer of the Watch/Engineering Duty Officer, depending on the work to be performed, will sign, legibly print or stamp his/her name and badge/grade/rank and enter the date, authorizing the work to start. This signature establishes the work and CWP start date and signifies that the system/component is in a condition to accomplish the work. This signature is not required for repair activity generated MCR/RECs to repair ship to shop items from tended ships (e.g., periscopes, relief valves, antennae).

NOTE: COMPLETE BLOCKS 16, 17, AND 18 BEFORE PERFORMING ANY SHIPBOARD TESTING. IF REWORK BECOMES NECESSARY AS THE RESULT OF SHIPBOARD TESTING, THE REQUIREMENTS OF PART I, CHAPTER 2, PARAGRAPH 2.3.7.2 OF THIS VOLUME SHALL BE FOLLOWED. FOR SHIP-TO-SHOP MAINTENANCE, BLOCKS 16, 17, AND 18 DO NOT NEED TO BE COMPLETED FOR IN-PROCESS TESTING IDENTIFIED AS PART OF THE CWP "PROCEDURE" SECTION. AFTER COMPLETING THE PROCEDURE AND BEFORE PERFORMING THE CWP "TESTING AND INSPECTION" SECTION, COMPLETE BLOCKS 16, 17, AND 18.

BLOCK 16 - **SUPPORTING DOCUMENTATION**

- a. The LWC Division Officer will identify all supporting documentation required and generated as established by the CWP. For example, a typical entry would be: QA2(3), QA12(1), QA26(1), QA34(1), RFI Tag(1), LAR(2). List only QA form 2s for new material installed in the system or component. The cumulative documentation (OQE) shall be listed on the most current revision.
- b. For activities using the Task Group Instruction (TGI) process. Deficiency Logs (DL) do not have to be listed in this block since DLs are integral to the TGI. The TGI should be cited in Block 16 if not already cited in Block 13. QA forms and other individual OQE records must be listed.

BLOCK 17 - **VERIFICATION OF WORK COMPLETION**

The LWC Division Officer will sign, legibly print or stamp his/her name (and badge/grade/rank) and enter the date, certifying that the production work described by the MCR/REC has been accomplished in accordance with the specified instructions and that the required documentation for the production work as described in Block 16 has been completed, reviewed and is correct. When rework is identified following signing blocks 17 and 18, new signature/date blocks for blocks 17 and 18 shall be documented on a QA form 10.

BLOCK 18 - **CERTIFICATION OF DOCUMENTATION OF PRODUCTION WORK**

The QAO will sign, legibly print or stamp his/her name and badge/grade/rank and enter the date, certifying that all documentation for the production work specified in Block 16 has been reviewed for accuracy and completeness and is complete and accurate. When rework is identified following signing blocks 17 and 18, new signature/date blocks for blocks 17 and 18 shall be documented on a QA form 10.

BLOCK 19 - **CERTIFICATION OF TESTING RESULTS**

The QAO will sign, legibly print or stamp his/her name and badge/grade/rank and enter the date, certifying that the testing invoked for this MCR/REC has been completed satisfactorily. The test documentation specified in Block 16 has been completed, reviewed, and is complete and accurate.

BLOCK 20 - **FINAL MCR/REC CLOSEOUT CERTIFICATION**

The Department Head will sign, legibly print or stamp his/her name and badge/grade/rank and enter the date, certifying that all documentation related to this MCR/REC has been reviewed for accuracy and completeness and is complete and accurate.

BLOCK 21 - **SHIP'S COMMANDING OFFICER SIGNATURE**

For "Ship's Force and FMA" MCR/REC, the ship's Commanding Officer (Reactor Officer for CVNs) will sign, legibly print or stamp his/her name and grade/rank and enter the date, in accordance with Part I, Chapter 2, Appendix E of this Volume, acknowledging that the MCR/REC has been closed by the Repair Officer. For "FMA ONLY" MCR/REC, this block is marked N/A.

HULL NO. _____
CWP SER. NO. _____
REV. NO. _____
PAGE ___ OF ___

MAINTENANCE CERTIFICATION RECORD/RE-ENTRY CONTROL SUPPLEMENT SHEET
QA FORM 10

(This Page Intentionally Left Blank)

QA FORM 10 INSTRUCTIONS

MAINTENANCE CERTIFICATION RECORD/RE-ENTRY CONTROL SUPPLEMENT SHEET

PURPOSE: MCR/REC Supplement Sheets are used to record supplemental data required by the MCR/REC, QA form 9. Examples of supplemental data are:

- a. Continuation of Blocks 12, 13, 14 and 16 of the QA form 9.
- b. When rework is identified following signing blocks 17 and 18 of the QA form 9, new signature/date blocks for blocks 17 and 18 shall be documented on a QA form 10.

PROCEDURE: The MCR/REC Supplement Sheet, QA form 10 may be used, as required, to record supplemental data required by the MCR/REC, QA form 9 (page number will normally be 2 of _). Record the QA form 9 block number and supplemental data. Record name and signature of the person recording the information (normally the person who is signing QA form 9) and date, except where the entry is preprinted by Planning prior to initial review for approval/opening.

(This Page Intentionally Left Blank)

(This Page Intentionally Left Blank)

QA FORM 11 INSTRUCTIONSCONTROLLED WORK PACKAGE (CWP)/RE-ENTRY CONTROL (REC) LOG

PURPOSE: To provide a record of ship and repair activities entries into SUBSAFE, nuclear, Level I, Deep Submergence SOC and other certified systems or components. The CWP/REC Log will summarize the chronological record of CWP and REC for the life of the ship.

PROCEDURE: The numbered blocks on the CWP/REC Log, QA form 11 correspond to the same number below. A CWP/REC Log will be maintained by each ship, FMA and naval shipyard as follows:

- a. The log is maintained by the QAO for ships and repair activities.
- b. When the CWP/REC is performed by the ship alone, the serial number will be recorded in the ship's CWP/REC Log.
- c. The FMA will also have a tended ship CWP/REC Log that records entries for work on each tended ship.
- d. When the CWP/REC is a Ship's Force provided serial number, it will be recorded in both the ship's CWP/REC Log and in the FMA's tended ship CWP/REC Log.

BLOCK 1 - **PAGE NO.**

As each new page is started, the QAO will enter the appropriate page number(s).

BLOCK 2 - **SHIP**

The QAO will enter the ship's name and hull number. Locally pre-printed forms with the ship's name and hull number are acceptable.

BLOCK 3 - **CWP/REC NUMBER**

For controlled (i.e., Level I, Nuclear, Scope of Certification) or SUBSAFE work to be performed by Ship's Force only, the ship's QAO will issue the CWP/REC numbers sequentially for entry in Block 4 of the ship's QA form 9. For controlled or SUBSAFE work performed by the repair activity on, or for a tended ship, the ship's QAO will issue CWP/REC numbers sequentially to the repair activity for entry in Block 4 of the repair activity's QA form 9. For controlled or SUBSAFE work to be performed by the repair activity only, not associated with a specific ship (example – rotatable pool assets), the repair activity's QAO will issue the CWP/REC numbers sequentially for entry in Block 4 of the repair activity's QA form 9. The format of the CWP/REC serial numbers will be the serial number followed by the year (e.g., 1-90, 123-01).

NOTE: SOC IS A LEVEL OF WORK TERM FOR DEEP SUBMERGENCE SYSTEM WORK IN ACCORDANCE WITH NAVSEA SS800-AG-MAN-010/P9290 USED IN CONJUNCTION WITH WORK ON HOST SYSTEMS FOR DRY DECK SHELTERS.

BLOCK 4 - **LEVEL OF WORK**

The QAO will enter the level of the work (e.g., SUBSAFE, Nuclear, Level I, SFCC or SOC). For SUBSAFE/SOC work on a tended unit by a repair activity other than during a scheduled Chief of Naval Operations Availability, the repair activity will obtain a REC number from the ship's QAO and record it in this block (e.g., SUBSAFE/REC No.).

NOTE: IF THE MCR IS REVISED BEYOND REVISION "G", THE ADDITIONAL REVISION LETTERS WILL BE ENTERED AND CROSSED OUT IN THE REMARKS BLOCK, BLOCK 9.

BLOCK 5 - **REVISIONS**

The QAO will circle, cross out, and/or record the applicable revision. This column controls the revisions, with the first version being "-" (dash), the first revision being A, second revision being B, etc. When the initial CWP/REC number is issued the dash (-) will be circled, when subsequent revisions of the MCR are issued the appropriate letter (A, B, C) will be circled and the previously circled Revision Letter will be crossed out using an "X".

BLOCK 6 - SYSTEM/COMPONENT

The QAO will enter the same system as in Block 9 or component as in Block 11 of the QA form 9.

NOTE: COMPONENT IS PREFERRED IF IT IS A VALVE OR EQUIPMENT WITH A UNIQUE IDENTIFIER (e.g., ASW-617, NO. 1 MAIN CONDENSER, ETC.).

BLOCK 7 - PRIME RESPONSIBILITY WORK CENTER OR GROUP

The QAO will enter the division/organization responsible for the work. For a repair activity, this is the LWC as assigned by the Planning Officer. For the ship, this is the WC initiating the QA form 9.

NOTE: IF THE COMMANDING OFFICER OF THE SHIP IS REQUIRED TO REVIEW FOR CLOSING THE QA FORM 9, THEN THE DATE IN BLOCK 21 OF THE QA FORM 9 DOCUMENTING THE CO'S REVIEW SHALL BE DOCUMENTED IN BLOCK 8 OF THE QA FORM 11.

BLOCK 8 - DATE

The QAO will enter the date the MCR serial number is assigned in the column "ISSUED". In the column "STARTED", the QAO will enter the same date as in Block 15D of the MCR as soon as Block 15 is dated. In the column "CLOSED", the QAO will enter the same date documented in Block 20 or 21, as applicable, of the QA form 9.

BLOCK 9 - REMARKS

This column is to be used to record revisions of the MCR/REC, if more revisions are issued after revision "G", and to summarize the work description and any other pertinent information (e.g., repair ASW-22, accomplish Unrestricted Operation (URO) Maintenance Requirement Card (MRC) 008 on ASW-7, overhaul number 2 periscope).

| (This Page Intentionally Left Blank)

QA FORM 11A INSTRUCTIONS**REC/MCR EXCEPTION CONTROLLED ASSEMBLY LOG**

PURPOSE: To provide a record for the completion of maintenance on components or systems assembled as a controlled assembly and performed as a REC/MCR exception per Part I, Chapter 5, paragraph 5.10.7, Note 3, Part I, Chapter 2, paragraph 2.2.5, Note 2 and Part III, Chapter 5, paragraph 5.11.6.1.b of this volume.

PROCEDURE: The numbered blocks on QA Form 11A correspond to the same number below. A REC/MCR Exception Controlled Assembly log will be maintained by each ship.

- a. The log is maintained by the QAO for ships.
- b. The REC/MCR Exception and Controlled Assembly Log will summarize the chronological record of REC/MCR exceptions and controlled assemblies until all maintenance on the log sheet has been superseded.

NOTE 1: EACH REC/MCR EXCEPTIONS LOG PAGE SHALL BE RETAINED IN THE FRONT OF THE REC EXCEPTION BINDER UNTIL ALL ITEMS LISTED ON THAT PAGE ARE SUPERSEDED.

BLOCK 1: - PAGE NO.

As each new page is started, the QAO will enter the appropriate page number(s).

BLOCK 2: - SHIP

The QAO will enter the ship's name and hull number. Locally pre-printed forms with the ship's name and hull number are acceptable.

BLOCK 3: - TWD

QAO will identify the TWD used to perform the REC/MCR exception controlled assembly, (i.e. FWP serial number, PMS MRC, component technical manual, etc.).

BLOCK 4: - LEVEL OF WORK

The QAO will enter the level of work (e.g. SUBSAFE, Level I, SOC).

BLOCK 5: - SYSTEM OR COMPONENT

The QAO will enter the system or component for the maintenance (e.g. Salvage Air/SA-1 thru SA-8, RO Unit Wye Strainer).

BLOCK 6: - PRIME RESPONSIBILITY WORK CENTER OR GROUP

The QAO will enter the division/workcenter responsible for the work. This is the workcenter conducting the controlled assembly.

BLOCK 7: - DATE

QAO will enter the date reviewed in the "ISSUED" block. In the column "CLOSED", the QAO will enter the same date as the QA-34 block 13.

QAO will enter date QA-34 was filed in REC Exception binder.

BLOCK 8: - REMARKS

This column is to be used to summarize the work description and any other pertinent information (e.g., Salvage Air/SA-1 through 8, RO Unit Wye Strainer PMS, External Air Charging Conn). Enter "N/A" if block is not used.

| (This Page Intentionally Left Blank)

**DEPARTURE FROM SPECIFICATION REQUEST
QA FORM 12**

1. DEPARTURE NO.	2. SHIP	3. JCN	4. CWP/REC SER. NO. 4A. TECHNICAL WORK DOCUMENT	5. DATE
6. ORIGINATOR: NAME	7. DEPARTURE TYPE <input type="checkbox"/> MAJOR <input type="checkbox"/> MINOR <input type="checkbox"/> SUBSAFE <input type="checkbox"/> FBW <input type="checkbox"/> SFCC <input type="checkbox"/> SOC		7A. EXPECTED CLEARANCE DATE 7B. TEMPORARILY APPROVED UNTIL DATE	
8. ADDITIONAL CLASSIFICATION (SHIPYARD AND SOC USE ONLY) <input type="checkbox"/> WAIVER <input type="checkbox"/> DEVIATION <input type="checkbox"/> SDR <input type="checkbox"/> TVD <input type="checkbox"/> FBWDR ISIC CONCURRENCE (REQUIRED FOR CONDITIONAL DFS) <input type="checkbox"/> YES <input type="checkbox"/> NO <input type="checkbox"/> N/A				
9. SYSTEM/COMPONENT/LOCATION & SHORT DESCRIPTION				
10. NAVSEA DRAWING/PLAN NUMBER/PIECE NUMBER				
11. REFERENCES				
12. APPLICABLE SPECIFICATIONS				
13. SITUATION/DEGREE OF NON-COMPLIANCE				
14. COMMENTS/RECOMMENDATION (TEST CONDUCTED, AFFECTED SYSTEMS)				
15. DATE ANSWER REQUESTED BY:		16. SUBMITTING ACTIVITY: TYPED OR PRINT NAME/SIGNATURE (RO/DH)		
17. NEW JCN NUMBER FOR CONDITIONAL DEPARTURES (IF NECESSARY):				
18. APPROVAL ACTIVITY				
19. COPY TO:				

ISIC		
APPROVED <input type="checkbox"/> DISAPPROVED <input type="checkbox"/>	TEMPORARY <input type="checkbox"/> PERMANENT <input type="checkbox"/>	FORWARD TO TYCOM FOR ACTION <input type="checkbox"/> FORWARD TO LTA FOR ACTION <input type="checkbox"/>
ISIC COMMENTS (ENDORSEMENT)		
ISIC TYPED NAME (NAME, RANK, BILLET/CODE)		DATE
TYCOM		
APPROVED <input type="checkbox"/> DISAPPROVED <input type="checkbox"/> CONCUR <input type="checkbox"/>	TEMPORARY <input type="checkbox"/> PERMANENT <input type="checkbox"/>	FORWARD TO NAVSEA FOR ACTION <input type="checkbox"/> FORWARD TO LTA FOR ACTION <input type="checkbox"/>
TYCOM COMMENTS (ENDORSEMENT)		
TYCOM TYPED NAME (NAME, RANK, BILLET/CODE)		DATE
LOCAL TECHNICAL AUTHORITY		
APPROVED <input type="checkbox"/> DISAPPROVED <input type="checkbox"/>	TEMPORARY <input type="checkbox"/> PERMANENT <input type="checkbox"/>	FORWARD TO NAVSEA FOR ACTION <input type="checkbox"/>
LOCAL TECHNICAL AUTHORITY COMMENTS (ENDORSEMENT)		
LOCAL TECHNICAL AUTHORITY TYPED NAME (NAME, RANK, BILLET/CODE)		DATE
NAVSEA / NAVAIR TECHNICAL AUTHORITY		
APPROVED <input type="checkbox"/> DISAPPROVED <input type="checkbox"/>	TEMPORARY <input type="checkbox"/> PERMANENT <input type="checkbox"/>	PRECEDENT SETTING <input type="checkbox"/>
NAVSEA / NAVAIR TECHNICAL AUTHORITY COMMENTS (ENDORSEMENT)		
NAVSEA / NAVAIR TECHNICAL AUTHORITY TYPED NAME (NAME, RANK, BILLET/CODE)		DATE

(This Page Intentionally Left Blank)

QA FORM 12 INSTRUCTIONSDEPARTURE FROM SPECIFICATION REQUEST

PURPOSE: Used to report and request approval of a DFS.

PROCEDURE:

1. The activity finding or causing a DFS will immediately report the DFS to the appropriate approval authority using this form.
2. The numbered blocks on QA form 12 correspond with instructions listed below.

BLOCK 1 - DEPARTURE NO.

Enter the next sequential number from the affected ship serial file.

BLOCK 2 - SHIP HULL NO.

Enter the name and hull number of the ship on which the DFS occurred.

BLOCK 3 - JCN

Enter the JCN for the job upon which the DFS occurred or was identified.

BLOCK 4 - CWP/REC SER. NO.

Enter the CWP/REC serial number or enter N/A if no CWP/REC is required. Do not list the CWP/REC revision.

BLOCK 4A - TECHNICAL WORK DOCUMENT

(SHIPYARD USE ONLY) Enter the technical work document that identified the non-conformance.

BLOCK 5 - DATE

Enter the date the DFS request is filled out.

BLOCK 6 - ORIGINATOR

Print or type the name of the originator of the DFS.

BLOCK 7 - DEPARTURE TYPE

Enter the applicable departure type. (Major or Minor) and classification as necessary (SUBSAFE, SOC, FBW or SFCC).

BLOCK 7A - EXPECTED CLEARANCE DATE

The activity performing final approval shall enter an expected clearance date in conjunction with approving the non-conformance. This date will normally be the expiration date but may be a date earlier than the expiration of the non-conformance. The Ship, ISIC or TYCOM may revise this date to be earlier than the expiration date of the non-conformance.

BLOCK 7B - TEMPORARILY APPROVED UNTIL DATE

The Approval Activity will fill in the "TEMPORARILY APPROVED UNTIL DATE" for non-Electronic Departure from Specification departures. Electronic Departures from Specification will automatically populate with the TEMPORARILY APPROVED UNTIL DATE in conjunction with the approval authority signature.

BLOCK 8 - ADDITIONAL CLASSIFICATION (SHIPYARD AND SOC USE ONLY)

Enter the necessary information as required. If the departure is conditional, mark the appropriate block to indicate that ISIC concurrence is required.

BLOCK 9 - SYSTEM/COMPONENT/LOCATION

Enter the affected system, component, and location. A short description may be added if needed to fully identify the system/component/location.

BLOCK 10 - **NAVSEA DRAWING/PLAN NUMBER/PIECE NUMBER**

Enter the NAVSEA drawing number, plan number and piece number, as applicable, that shows the component or system on which the DFS is initiated.

BLOCK 11 - **REFERENCES**

Enter additional references used (e.g., Training Aid Booklet, Ships Information Book, Ships Systems Manual, Steam and Electric Plant Manual, SUBSAFE Certification Boundary Book, Tech Manual) as applicable.

BLOCK 12 - **APPLICABLE SPECIFICATIONS**

Enter the applicable specifications. Be descriptive and specific. Enter the reference that provided the specification. This block should fully explain the specifications and include the JID or part applicable (e.g., perform "J" pressure test to test pressure depth after mechanical assembly of joints "XXXX" in which software was replaced). This block must be explicit, so that no reference is required to the work procedure to understand the specifications.

BLOCK 13 - **SITUATION/DEGREE OF NON-COMPLIANCE**

Enter what the actual condition is. Sketches, drawings, QA forms, etc., may be attached, if they clarify the description of the non-conforming condition.

BLOCK 14 - **COMMENTS/RECOMMENDATION (TEST CONDUCTED, AFFECTED SYSTEMS)**

Enter comments/recommendations pertinent to the job. The comments will include recommendation and justification for approval of the DFS. Enter tests conducted and the results, SAT or UNSAT.

BLOCK 15 - **DATE ANSWER REQUESTED BY**

Enter date.

BLOCK 16 - **SUBMITTING ACTIVITY**

Type or print name and enter signature.

BLOCK 17 - **NEW JCN NUMBER FOR CONDITIONAL DEPARTURES**

Any departure that is conditional (requires future work to correct), Ship's Force will enter the new JCN that tracks the maintenance action to correct the deficient condition.

BLOCK 18 - **APPROVAL ACTIVITY**

List the activity who will be the final approval.

BLOCK 19 - **COPY TO**

Enter activities to receive copy.

For the ISIC, TYCOM, LOCAL TECHNICAL AUTHORITY and NAVSEA/NAVAIR TECHNICAL AUTHORITY blocks, the applicable activity will request, concur, approve, disapprove and indicate temporary, permanent or precedent setting as applicable. In the case of temporary non-conformances, specify the TEMPORARILY APPROVED UNTIL DATE (dd/mm/yyyy) that the noncompliance is acceptable prior to correction and list any restrictions.

ISIC: Check the appropriate blocks. Check the FWD to TYCOM/LOCAL TECH. AUTHORITY FOR ACTION block for any DFS requiring TYCOM action and print name, sign and date.

- a. (Surface Forces only) The originator of the non-conformance will check the appropriate blocks to forward the non-conformance to the appropriate activity for action.
- b. For an at sea generated DFS, the Commanding Officer will use the ISIC section to indicate approval of the DFS.
- c. In the instances where a depot activity forwards a conditional departure to the ISIC for concurrence, the ISIC will check the block labeled CONCUR, FORWARDED TO TYCOM FOR ACTION. The ISIC will type or print name, sign and date.

TYCOM: Check the appropriate blocks. Type or print name, sign and date. ((Submarines only) See QA-12 Block 19 table below for approval guidance).

LOCAL TECHNICAL AUTHORITY: When appropriate, check the appropriate blocks and type or print name, sign and date. Check the FWD TO NAVSEA FOR ACTION BLOCK for any DFS requiring NAVSEA final approvals. **NAVSEA/NAVAL AIR SYSTEMS COMMAND (NAVAIR)** action: The appropriate blocks will be checked and signed by NAVSEA.

NAME/SIGNATURE/DATE: The ISIC Material Officer, ISIC QAO, TYCOM Representative, Local Technical Authority Chief Engineer or Commanding Officer (for an at-sea initiated DFS) will type or print name and title, sign and date in the appropriate block signifying technical acceptance of the DFS. In the case of shipyard conditional departures, the ISIC signature only signifies acceptance that work to clear the deficient condition is acceptable to be delayed to a future time period. The ISIC signature in this case does not signify acceptance of the technical merit of the departure.

TYCOM: Check the appropriate blocks. Type or print name, sign and date.

NOTE: WHEN ANY OF THE FOLLOWING BLOCKS IN SECTION 7 ARE CHECKED, THE TYCOM MAY APPROVE THE DFS AS DEFINED IN THE FOLLOWING TABLE:

QA-12 Block 19 Table (Submarines Only)	
MAJOR	TYCOM may approve MAJOR non-conformances on a temporary basis with concurrence from the appropriate NAVSEA technical authority.
MINOR	TYCOM may approve all MINOR non-conformances not also marked SUBSAFE, FBW, SFCC, or SOC.
SUBSAFE	<p>TYCOM may approve the following MINOR departures:</p> <ul style="list-style-type: none"> (1) Departures to which a NAVSEA approved PRECEDENT setting departure clearly applies. The NAVSEA approved departure cited as the PRECEDENT shall be referenced and retained with the approved departure. (2) Departures administered solely for the purpose of transferring accountability to an alternative accountability system in support of at-sea testing. <p>The TYCOM may approve all other MAJOR or MINOR non-conformances within the SUBSAFE Certification Boundary following discussion with the designated NAVSEA technical authority or regional Chief Engineer.</p>
URO	With the exception of at-sea portions of URO MRC 022, the TYCOM shall obtain NAVSEA technical approval of all URO MRC non-conformances.
FBW	<p>TYCOM may approve the following MINOR departures:</p> <ul style="list-style-type: none"> (1) Departures to which a NAVSEA approved PRECEDENT setting departure clearly applies. The NAVSEA approved departure cited as the PRECEDENT shall be referenced and retained with the approved departure. <p>The TYCOM may approve all other MAJOR or MINOR non-conformances within the FBW/SFCC Certification Boundary following discussion with NAVSEA 05U7T.</p>

<p>SFCC</p>	<p>TYCOM may approve the following MINOR departures:</p> <p>(1) Departures to which a NAVSEA approved PRECEDENT setting departure clearly applies. The NAVSEA approved departure cited as the PRECEDENT shall be referenced and retained with the approved departure.</p> <p>The TYCOM may approve all other MAJOR or MINOR non-conformances within the FBW/SFCC Certification Boundary following discussion with NAVSEA 05U7T.</p>
<p>SOC</p>	<p>MINOR non-conformances: Following agreement from NAVSEA that a condition is MINOR, may be approved by the TYCOM as a temporary SOC non-conformance provided that it does not affect the watertight integrity of the DDS and no DDS manned operations will be conducted.</p> <p>Non-conformances affecting any system, equipment or component within the SOC boundary, which are determined to be required by Part III, Chapter 8 of this volume, shall be categorized and processed as a MAJOR departure, unless otherwise directed by NAVSEA, will require NAVSEA approval.</p>

DEPARTURE CLEARANCE REPORT
QA FORM 12A

1. FROM:	2. DATE
3. TO:	
4. SUBJECT	
DFS NUMBER _____ DATED _____	
ON SYSTEM/COMPONENT _____ IN USS _____	
5. REFERENCE(s):	
(A) COMUSFLTFORCOMINST 4790.3 - JOINT FLEET MAINTENANCE MANUAL	
(B)	
(C)	
(D)	
6. JUSTIFICATION	
7. CLEAR / CANCEL SUBJECT DFS IN ACCORDANCE WITH REFERENCE (A). (CIRCLE ONE)	
8. SIGNATURE	TITLE
DATE	

(This Page Intentionally Left Blank)

QA FORM 12A INSTRUCTIONS
DEPARTURE CLEARANCE REPORT

PURPOSE: Provide document for reporting the clearance of a DFS.

PROCEDURE: The numbered blocks on QA form 12A correspond with the instructions listed below. QA form 12A should be completed by the ship on which the DFS exists as soon as the discrepant condition has been corrected.

BLOCK 1 - FROM

Enter the ship's name and hull number.

BLOCK 2 - DATE

Enter date the DFS was cleared/cancelled.

BLOCK 3 - TO

Enter the appropriate ISIC or, if clearing ship approved DFS, enter "CO".

BLOCK 4 - SUBJECT

Enter the required data taken from the QA form 12.

BLOCK 5 - REFERENCE(s)

Enter all applicable references.

BLOCK 6 - JUSTIFICATION

Enter detailed justification for the clearance/cancellation listing all references, tests and inspections used for the DFS clearance.

BLOCK 7 - CLEAR/CANCEL

Circle the appropriate action.

BLOCK 8 - SIGNATURE

QAO print name, enter signature, title and date.

(This Page Intentionally Left Blank)

SURVEILLANCE/MONITORING/AUDIT DISCREPANCY RECORD
QA FORM 14

	1. DATE	2. SERIAL NUMBER	3. WC
4. PART 1 - DISCREPANCY DESCRIPTION			
5. ORIGINATOR SIGNATURE		6. QA OFFICER/QA SUPERVISOR REVIEW SIGNATURE	
QA RETAIN ORIGINAL AND FORWARD COPY TO DIVISION			
7. PART 2 – CORRECTIVE ACTION			
ROOT CAUSE(s):			
IMMEDIATE CORRECTIVE ACTION(s):			ECD
PERMANENT CORRECTIVE ACTION(s):			ECD
OBJECTIVE QUALITY EVIDENCE CORRECTIONS:			
8. DIVISION OFFICER (SIGNATURE)			DATE
DIVISION RETAIN COPY AND FORWARD COPY TO QA OFFICER			
9. QA OFFICER/QA SUPERVISOR (QAO/QAS) (SIGNATURE)			DATE
10. PART 3 - EFFECTIVENESS REINSPECTION/AUDIT		ECD	11. EFFECTIVENESS (YES/NO)
			QA FORM 14
12. EFFECTIVENESS REVIEW QA OFFICER/QA SUPERVISOR (QAO/QAS) (SIGNATURE)			DATE
COMPLETED ORIGINAL TO: QA-14 BINDER			
COPY TO: DIVISION RECORD FILE			
CWP, QA FORM AND/OR REC (IF CORRECTING OQE OR PACKAGE)			

(This Page Intentionally Left Blank)

QA FORM 14 INSTRUCTIONSSURVEILLANCE/MONITORING/AUDIT DISCREPANCY RECORD

- PURPOSE:**
- a. To provide as a result of conducting audits and surveillances, a method or means of reporting a discrepancy and ensuing corrective actions are taken by the WC or division.
 - b. To provide a method of recording discrepancies, reworks and processing actions until final clearance.
 - c. To provide the only approved method to correct or add Objective Quality Evidence to a certified CWP or closed QA Form.
 - d. To provide, when maintained in an auditable fashion, a record of completed corrective actions.
 - e. To provide, when completed, an ability to conduct trend analysis to improve overall FMA and ship's maintenance quality.

NOTE: A COPY OF ALL ASSOCIATED QA FORMS 14 SHALL BE INCLUDED WITH THE CWP, QA FORM AND/OR REC. DEFICIENCIES FOUND IN A CLOSED CWP, QA FORM AND/OR REC THAT REQUIRE CORRECTION SHALL BE DOCUMENTED ON A QA FORM 14. NO CHANGE TO THE CLOSED CWP, QA FORM AND/OR REC IS PERMITTED EXCEPT AS CITED IN THIS NOTE. THE QA FORM 14 SERIAL NUMBER WILL BE ANNOTATED AT THE TOP OF THE QA FORM 9 OR QA FORM TO CLEARLY INDICATE A QA FORM 14 WAS WRITTEN AFTER THE CWP, QA FORM AND/OR REC WAS CLOSED/CERTIFIED AND THAT ADDITIONAL OQE IS ASSOCIATED WITH THE CLOSED CWP, QA FORM AND/OR REC PACKAGE.

PROCEDURE: The numbered blocks in QA form 14 correspond with the instructions listed below.

BLOCK 1 - **DATE**

The person discovering/documenting the discrepancy will enter the date the report was initiated.

BLOCK 2 - **SERIAL NUMBER**

The QAS/QAO will enter the next sequential number from the QA form 14 Log.

BLOCK 3 - **WC**

Person discovering/documenting the discrepancy will enter the WC responsible.

BLOCK 4 - **PART 1 - DISCREPANCY DESCRIPTION**

Person discovering the discrepancy will enter a description of the discrepancy and the associated reference. If associated with a CWP, enter the CWP serial number.

BLOCK 5 - **ORIGINATOR SIGNATURE**

The individual discovering/documenting the discrepancy will sign, and legibly print, type or stamp his/her name.

BLOCK 6 - **QA OFFICER/QA SUPERVISOR REVIEW SIGNATURE**

The QAO or a QAS will sign and legibly print, type or stamp his/her name signifying a review of and concurrence with the validity of the discrepancy.

NOTE: BLOCK 7, WHEN COMPLETE, WILL SIGNIFY A COMPREHENSIVE PROCESS BY WHICH THE BLOCK 4 DISCREPANCY'S CAUSE, CORRECTION AND PREVENTION ARE IDENTIFIED AND TRACKED TO COMPLETION.

BLOCK 7 - **PART 2 - CORRECTIVE ACTION**

- a. **ROOT CAUSE:** When required by the QAO, the Division Officer of the WC responsible (Block 3) for causing the discrepancy will enter the root cause and a brief supporting discussion.

- b. **IMMEDIATE CORRECTIVE ACTION:** The Division Officer of the WC responsible for causing the discrepancy will enter a description of the IMMEDIATE CORRECTIVE ACTIONS (if applicable) that have been taken or are planned and indicate their Estimated Completion Date (ECD).
- c. **PERMANENT CORRECTIVE ACTION:** The Division Officer of the WC responsible for causing the discrepancy will enter a description of the PERMANENT CORRECTIVE ACTIONS (to prevent recurrence) that have been taken or are planned and indicate their ECD. Examples include: process improvements and policy/procedural changes.
- d. **OBJECTIVE QUALITY EVIDENCE CORRECTIONS:** The Division Officer of the WC responsible for causing an Objective Quality Evidence discrepancy will enter all required information that adds and/or corrects existing discrepant OQE (described in Block 4) to a closed CWP, QA FORM and/or REC. In the event the deficiency identified in Block 4 is not related to OQE, this area shall be marked NA.

NOTE: UPON SIGNING BLOCK 8, THE DIVISION OFFICER SHALL RETAIN A COPY FOR TRACKING PURPOSES, UNTIL RESOLVED, AND PROVIDE A COPY OF THE QA FORM 14 TO THE QAO/QAS.

BLOCK 8 - **DIVISION OFFICER SIGNATURE**

The Division Officer of the WC responsible for causing the discrepancy will sign, date and legibly print, type or stamp his/her name signifying comment validity and accurate corrective action/OQE correction (if applicable) exists.

NOTE: UPON SIGNING BLOCK 9, THE QAO/QAS SHALL FILE A COPY OF THE SIGNED QA FORM 14 WITH THE DISCREPANT CLOSED CMP, QA FORM AND/OR REC (AS APPLICABLE) TO ALLOW IT TO STAND ALONE.

BLOCK 9 - **QA OFFICER/QA SUPERVISOR SIGNATURE**

The QAO or QAS will sign, date and legibly print, type or stamp his/her name indicating full acceptance of the Block 7 comments.

BLOCK 10 - **PART 3 - EFFECTIVENESS RE-INSPECTION/AUDIT**

When required by the QAO, the QAO or QAS will enter a description of the necessary QAO/QAS re-inspections/audits that will support determining effectiveness of each Block 7 Corrective Action and indicate an ECD for each re-inspection/audit action. Examples include but are not limited to: audits, surveillances, exams and level of knowledge interviews.

BLOCK 11 - **EFFECTIVENESS**

Upon completion of a Re-inspection/Audit (Block 10), the QAO or QAS will enter its effectiveness as "YES or NO". If the effectiveness has been determined to be "NO", the QAO/QAS shall transfer the issue to a new QA form 14 (for further root causal analysis and corrective actions) and enter that new QA FORM 14 serial number in the space provided.

NOTE: UPON CLOSURE, THE QAO/QAS SHALL FILE THE COMPLETED AND CLOSED QA FORM 14 IN THE QA FORM 14 BINDER WITH A COPY FILED WITH THE DISCREPANT CLOSED CWP, QA FORM AND/OR REC (AS APPLICABLE) TO ALLOW IT TO STAND ALONE.

BLOCK 12 - **EFFECTIVENESS REVIEW QA OFFICER/QA SUPERVISOR SIGNATURE**

Upon completion of all re-inspections/audits (Block 10), determination of effectiveness and deferral (by QA-14 for any corrective actions deemed NOT effective), the QAO or QAS shall enter signature and date, and legibly print, type or stamp his/her name indicating acceptance and closure of the QA form 14.

TEST AND INSPECTION RECORD

QA FORM 17 Planning shall fill in blocks identified by a ♦ prior to issuing

Page ___ of ___

♦1. SHIP	HULL NO.	♦2. JCN	♦3. LWC/SHOP	♦4. CWP/REC SER NO.	♦5. SYSTEM/COMPONENT
♦6. REFERENCES (COMPONENT DETAIL/ASSEMBLY DRAWING AND REV)					
A.		B.		C.	
D.		E.		F.	
♦7. PART DESCRIPTION/PIECE NO.:					
♦8. DESCRIPTION OF TEST AND/OR INSPECTION:					
9. RESULTS					
10. CRAFTSMAN SIGNATURE			11. QA INSPECTOR SIGNATURE		
DATE			DATE		
12. RECORD HAS BEEN REVIEWED FOR COMPLETENESS					
QA WCS SIGNATURE (QAO/QAS SIGNATURE FOR SUBSAFE/SOC/SFCC ONLY)				DATE	

(This Page Intentionally Left Blank)

QA FORM 17 INSTRUCTIONS
TEST AND INSPECTION RECORD

PURPOSE: To provide a report form for work, tests and inspections not covered by other QA forms. This form can be used for flushes, operational testing, shop inspections, cleanliness inspections, generic material identity test, and other tests, inspections, and information deemed necessary. The QA form 17 will not be used in lieu of a QA form 26A in DSS/SOC applications.

PROCEDURE: The numbered blocks on QA form 17 correspond with the instructions listed below. The planning organization shall fill in Blocks 1 through 8 (identified by a ♦) prior to issuing the CWP.

BLOCK 1 - **SHIP HULL NO.**

Enter the ship's name and hull number.

BLOCK 2 - **JCN**

Enter the JCN.

BLOCK 3 - **LWC**

Enter the shop number of the LWC.

BLOCK 4 - **CWP/REC SERIAL NO.**

Enter the CWP/REC serial number or enter N/A if no CWP/REC is required. Do not list the CWP/REC revision.

BLOCK 5 - **SYSTEM/COMPONENT**

Enter the noun name of the system or component to be tested or inspected.

BLOCK 6 - **REFERENCES (COMPONENT ASSY/DETAIL DRAWING AND REVISION)**

Enter all references used to identify component parts, material information, and required test/inspection including revision letter and if applicable, the assembly number (Assy D, Assy RA, etc.). For original issue drawings (no revisions) enter a dash (-). For vendor drawings, include vendor name. Revisions for technical manuals are not required.

BLOCK 7 - **PART DESCRIPTION/PIECE NO.**

Enter the part number/description (pc 5, bonnet, stem bore, backseat, etc.).

BLOCK 8 - **DESCRIPTION OF TEST AND/OR INSPECTION**

Enter a detailed description of tests/inspections/work to be performed or note the reference used and paragraph/note number that specifies the inspection or test. Enter the required pressure, duration, medium and acceptance criteria of the test. If the test or inspection has a numerical value (e.g., maximum and/or minimum value), the values will be written in. If listing the pressure values would classify the work procedure, then the symbols "J" or "H" (with the applicable reference including paragraph/table/section/item number) may be used instead of classifying the document.

NOTE: WHEN MANUFACTURING PARTS, ENTER THE MATERIAL SPECIFICATION OR NSN FOR RAW STOCK AND RECORD THE PLAN AND WHEN APPLICABLE, THE PIECE NUMBER OF THE PART MANUFACTURED.

NOTE: FOR URO MRCs TO BE PERFORMED AS A RETEST, LIST THE SPECIFIC APPLICABLE PORTIONS OF THE URO MRC (TO INCLUDE APPLICABLE PRE-REQUISITE STEPS) REQUIRED TO RECERTIFY THE SYSTEM.

BLOCK 9 - **RESULTS**

Enter the specific results of the test, inspection or work specified in Block 8. Indicate satisfactory or unsatisfactory results or completion. If UNSAT, the craftsman will:

- a. Initiate action to resolve the condition.

- b. Record actions taken in this block to correct the unsatisfactory condition.
- c. Sign in this block (Block 9).

Do not sign Block 10 unless signing for satisfactory results or completion are obtained or for an UNSAT condition that has been accepted.

- NOTE: IF THE TEST OR INSPECTION REQUIRES THE USE OF TMDE, RECORD THE INSTRUMENT, RANGE AND SERIAL NUMBER AND CAL DUE DATE IN THE RESULTS BLOCK.
- NOTE: WHEN VULCANIZING O-RINGS, ENTER THE STOCK NUMBER AND EXPIRATION DATE (IF PROVIDED).
- NOTE: IF SKETCHES/DRAWINGS/URO DATA REPORT FORMS OR ADDITIONAL INFORMATION IS REQUIRED TO SUPPLEMENT THIS REPORT, EACH DRAWING, ETC., WILL BE LABELED AS AN ATTACHMENT TO ITS RESPECTIVE QA FORM 17, INCLUDING THE PAGE NUMBER, WHICH SHALL BE SIGNED (INCLUDE PRINTED NAME, DATE) BY THE CRAFTSMAN AND QAI FILLING OUT THE QA FORM 17. (FOR ATTACHMENTS WITH MULTIPLE PAGES, ONLY THE FIRST PAGE REQUIRES SIGNATURES.)
- NOTE: FOR OPERATIONAL JOINT TIGHTNESS TESTS ENTER ACTUAL PRESSURE AND DURATION. TEST DURATION WILL INCLUDE THE REQUIRED TEST PERIOD AND THE TIME REQUIRED TO COMPLETE THE INSPECTION. IF LISTING THE ACTUAL TEST PRESSURE VALUE WOULD CLASSIFY THE WORK PROCEDURE, THEN THE SYMBOLS "J" OR "H" (WITH THE APPLICABLE REFERENCE, INCLUDING PARAGRAPH/TABLE/SECTION/ ITEM NUMBER) MAY BE USED INSTEAD OF CLASSIFYING THE DOCUMENT. FOR URO MRCs PERFORMED AS A RETEST, COMPLETE REQUIRED PORTIONS OF THE URO MRC DATA FORMS AND ENTER SATISFACTORY OR UNSATISFACTORY IN BLOCK 9.

BLOCK 10 - CRAFTSMAN/DATE

Craftsman print name, enter signature and date after completing Block 9. Do not sign Block 10 unless satisfactory results or completion are obtained or the UNSAT condition has been accepted.

- NOTE: FOR NDT INSPECTIONS, THE NDT INSPECTOR WILL SIGN BLOCK 10 AS THE CRAFTSMAN AND THE NDT SUPERVISOR WILL SIGN BLOCK 11 FOLLOWING REVIEW OF THE FORM.

BLOCK 11 - QA INSPECTOR/DATE

Inspector print name, enter signature and date verifying the accuracy of the data recorded in Block 9.

BLOCK 12 - RECORD HAS BEEN REVIEWED FOR COMPLETENESS

QAS or QAO will print name, enter signature and date for final review, signifying the accuracy of the completed form for SUBSAFE/SOC/SFCC items only. For other components, the QA Work Center supervisor shall sign and date the form signifying the accuracy of the completed form.

EPOXY REPAIR RECORD

QA FORM 17A (06/05) Planning shall fill in blocks identified by a ♦ prior to issuing

♦ 1. SHIP HULL NO.		♦ 2. JCN		♦ 3. LWC/SHOP		♦ 4. CWP/REC SER NO.		5. SYSTEM/COMPONENT/ROTATABLE POOL SER NO.		♦ 6. REFERENCES (COMP DETAIL/ASSY DWG & REV)			
										A.			
♦ 7. EPOXY REPAIRS ARE IAW: <input type="checkbox"/> UIPI 2560-107 <input type="checkbox"/> UIPI 6300-905 <input type="checkbox"/> OTHER _____				8. LEGEND FOR EPOXY METHOD (ENTER APPLICABLE SYMBOL(S) IN BLOCK 9) SH – SHIM PE – POWDER EPOXY REPAIR CP – COLD PATCH ♦ OT - OTHER (specify): B – BUSHING CE – COLD EPOXY COATING SL – SLEEVE _____								B.	
												C.	
9. DESCRIPTION OF REPAIR(S)				10. REPAIR(S) & TEST ACCOMPLISHED									
				10A. PRE-EPOXY DIMENSIONS			10B. EPOXY APPLIED			10C. REQUIRED TESTS/RESULTS			
♦ PART NO./NAME & DESCRIPTION OF DEFECT AREA(S) (USE BLOCK 11 FOR ADDITIONAL INFO, IF REQUIRED)		♦ REF DWG LTR	♦ UIPI 2560-107 METHOD OR EPOXY METHOD (See Block 8)		DEPTH OF MACHINING (INCHES)	DEPTH (INCHES) OF REMAINING DEFECTS	SHIM/SLEEVE THICKNESS (INCHES) & MAT'L USED		EPOXY MATERIAL & BATCH NO. USED			REQUIRED TEST LEGEND (Enter number below) 1. TAP 2. PULL 3. SPARK 4. VT CURE 5. OTHER (Specify)	
												♦ REQUIRED TEST (See Test Legend)	
A.												TEST RESULTS <input type="checkbox"/> SAT <input type="checkbox"/> UNSAT FINAL SURFACE FINISH MEETS REQUIREMENTS	
					SIGNATURE/BADGE/DATE			SIGNATURE/BADGE/DATE			SIGNATURE/BADGE/DATE		
B.												♦ REQUIRED TEST (See Test Legend)	
												TEST RESULTS <input type="checkbox"/> SAT <input type="checkbox"/> UNSAT FINAL SURFACE FINISH MEETS REQUIREMENTS	
					SIGNATURE/BADGE/DATE			SIGNATURE/BADGE/DATE			SIGNATURE/BADGE/DATE		
11. ADDITIONAL INFORMATION/SKETCHES: This block may be used to provide additional information, signatures, and sketches to clarify EPOXY repair area(s). Use the back of the sheet for additional space. (CRAFTSMAN/QAI SUBMIT A DF TO RESOLVE UNSAT DATA)													
12. QA INSPECTOR/SHOP SUPERVISOR SIGNATURE/BADGE NO. (RECORD REVIEWED FOR FINAL ACCEPTANCE)								13. QAS SIGNATURE /BADGE NO. (RECORD HAS BEEN REVIEWED FOR COMPLETENESS)					
								DATE				DATE	

65-11-59

COMUSFLTFORCOMINST 4790.3 REV C CH-5

(This Page Intentionally Left Blank)

QA FORM 17A INSTRUCTIONSEPOXY REPAIR RECORD

PURPOSE: To document the proper OQE for epoxy repairs on components when directed by the Technical Work Document.

NOTE:

1. EACH FORM ALLOWS FOR TWO EPOXY REPAIRS TO BE DOCUMENTED, BUT MUST BE LIMITED TO A SINGLE COMPONENT (E.G., TD-29/30 VALVE ASSEMBLY).
2. REWORK: IN CASES WHERE REWORK IS REQUIRED AFTER CRAFTSMAN CERTIFICATION OF A RECORD, A NEW RECORD AND WORK AUTHORIZING DOCUMENT IS REQUIRED.
3. IN CASES WHERE REWORK IS REQUIRED DUE TO AN IN-PROCESS FAILURE, THE FOLLOWING PROCESS SHALL BE USED:
 - a. CHECK THE "UNSAT" BOX IN THE "TEST RESULTS" SECTION OF BLOCK 10 ALONG WITH AN EXPLANATION OF FAILURE IN BLOCK 11. LEAVE REMAINING UNSIGNED BLOCKS BLANK.
 - b. ENTER "REWORK FOR ITEM 9X" (WHERE X IS THE LETTER DESIGNATOR FOR THE BLOCK 9 ITEM LINE (E.G., 9A, 9B)) OR SIMILAR WORDS IN THE NEXT BLANK "PART NO./NAME/ DESCRIPTION OF DEFECT AREAS" BLOCK, ALONG WITH AN ASTERISK OR OTHER MARK WITH A CORRESPONDING EXPLANATION IN BLOCK 11 WITH SIGNATURE, BADGE NUMBER AND DATE. IF THERE IS NO EMPTY ITEM LINE, ANOTHER QA FORM 17A MAY BE USED AS A CONTINUATION SHEET. IF THE RECORD CONTAINS MULTIPLE PAGES, IDENTIFY THE PAGE THAT CONTAINS THE ITEM LINE FOR WHICH THE REWORK IS ACCOMPLISHED (E.G., 9A OF PAGE 1).
 - c. RE-ENTER ALL OF THE ORIGINALLY REQUIRED TESTS IN THE NEW ITEM LINE AND COMPLETE ALL BLOCKS EXCEPT THE "PART NO./NAME/DESCRIPTION OF DEFECT AREAS" BLOCK WHICH IS ANNOTATED AS DESCRIBED IN PARAGRAPH B. ABOVE. IT IS ACCEPTABLE FOR THE CRAFTSMAN TO COPY ENTRIES INTO PLANNING BLOCKS FROM THE ORIGINAL PLANNING ENTRIES.

SCOPE: Documentation with this QA form is required for epoxy repair of the following:

- SUBSAFE components
- Scope of Certification (SOC) components
- Seawater ball valves

PROCEDURE: PLANNING DEPARTMENT: Provide guidance in accordance with UIPI 2560-107 or UIPI 6300-905, and provide QA-17A records as part of the TWD or DL.

The numbered blocks on QA form 17A correspond with the instructions listed below. Planning shall fill in blocks identified by a ♦ prior to issuing QA form 17A. The shop craftsman is responsible for all other blocks on the form unless otherwise specified.

TOP OF FORM - PAGE _____ OF _____

Enter page numbers.

BLOCK 1 - SHIP HULL NO.

Enter the ship's name and hull number or enter the appropriate rotatable pool system designator (e.g., TRIPER, CCRP, AERP, SSN 688CL, etc.).

BLOCK 2 - JCN

Enter the Job Control Number (JCN). Naval shipyards enter Job Order and KeyOp.

BLOCK 3 - **LWC/SHOP**

Enter the lead shop (e.g., X38, outside machinist).

BLOCK 4 - **CWP/REC SERIAL NO.**

Enter the CWP/REC serial number or enter NA if no CWP/REC is required. Do not list the REC revision.

BLOCK 5 - **SYSTEM/COMPONENT/ROTATABLE POOL SER NO.**

Enter the noun name of the system and component (if applicable) (e.g., MSW-25). If the record is for in-shop restoration of rotatable/factory pool material, enter the serial number of the material.

NOTE: ROTATABLE POOL/FACTORY SERIAL NUMBERS MAY BE ENTERED BY THE PLANNER, IF KNOWN, OR THE CRAFTSMAN AS SPECIFIED BY LOCAL INSTRUCTIONS.

BLOCK 6 - **REFERENCES (COMP DETAIL/ASSY DWG & REV)**

Enter all references used to identify component parts, material information and test/inspection requirements. Include revision letter and if applicable, identify the assembly number (e.g., Assy D, Assy RA, etc.). For original issue (non revised) drawings, enter a dash (-). Revisions for Technical Manuals are not required. Include vendor name for vendor drawings.

BLOCK 7 - **EPOXY REPAIRS ARE IAW**

Check the "UIPI 2560-107" or "UIPI 6300-905" box when applicable; otherwise check the "OTHER" box and specify the procedure.

BLOCK 8 - **LEGEND FOR EPOXY METHOD**

Identifies the designators for Block 9 (EPOXY METHOD). Planning shall specify the type of epoxy repair on the line following the "OT - OTHER" designator when a required repair method is not listed.

BLOCK 9 - **DESCRIPTION OF REPAIR(S)**

NOTE: PLANNING SHALL COMPLETE ALL SECTIONS OF BLOCK 9. ADDITIONAL QA 17A FORMS MAY BE ADDED AS CONTINUATION SHEETS IF NECESSARY.

PART NO./NAME & DESCRIPTION OF DEFECT AREA(S)

Enter part number and/or name (e.g., pc 5, bonnet; pc 3, body, etc.) and description of defect areas (e.g., O-ring groove pitted, stem bore, backseat, etc.). Ensure each surface area being epoxy repaired is clearly identified.

NOTE: USE BLOCK 11 AND/OR THE BACK OF THE SHEET FOR ADDITIONAL INFORMATION AND/OR SKETCHES.

REF DWG LTR(S)

Enter the letters corresponding to the reference listed in Block 6 which provides the material, dimensional and testing/inspection information for the items listed in the "PART NO./NAME & DESCRIPTION OF DEFECT AREA(S)" block.

UIPI 2560-107 METHOD OR EPOXY METHOD

Enter the epoxy repair method code from UIPI 2560-107 when applicable, or use a symbol from the legend in Block 8 that identifies the method of epoxy repair being accomplished when UIPI 6300-905 or OTHER instruction is identified in Block 7. For an epoxy repair method not identified in the Block 8 legend, enter "OT" and specify the epoxy repair method on the line following "OT - OTHER" in Block 8.

BLOCK 10 - **REPAIR(S) & TEST ACCOMPLISHED**

NOTE: CRAFTSMAN SHALL COMPLETE ALL SECTIONS OF BLOCKS 10A AND 10B. PLANNING SHALL COMPLETE BLOCK 10C.

BLOCK 10A. - PRE-EPOXY DIMENSIONS**DEPTH OF MACHINING**

When required by the TWD, record the thickness of the material removed during machining. Enter "NA" when not required by the TWD or material removal is not accomplished.

REMAINING WALL THICKNESS

When required by the TWD, enter the wall thickness dimensions after machining or removing material. Dimensions must take into account the depth of remaining defects. Enter "NA" when material is not removed or wall thickness documentation is not required by the TWD.

DEPTH OF REMAINING DEFECTS

Enter the maximum depth of remaining defects. Enter "No Defects Remain" if there are no remaining defects after machining.

SHIM/SLEEVE THICKNESS & MAT'L USED

Enter "NA" when shims are not used. Enter the thickness of the shim or sleeve (or bushing used as a sleeve) used (e.g., 0.032, 1/8 or 3/32, etc.). When installing "S", "L", or top hat shims, enter the thickness of the upper, the middle and the lower legs as applicable. Enter the generic material (e.g., titanium) or a stock number of the shim when provided by the naval or local stock program. When this block is being used to document installation of the shim in lieu of a QA form 34, then the stock number (NSN), part number, drawing and piece number, generic or material spec marking, or results of generic material identity testing shall be documented here also. If reinstalling an existing shim, enter "Reinstalled existing".

SIGNATURE/BADGE/DATE

Craftsman enter signature, badge number and date for pre-epoxy dimensions recorded in Block 10A.

BLOCK 10B. - EPOXY APPLIED**EPOXY MATERIAL & BATCH NO. USED**

Enter the epoxy material (e.g., 3M Epoxy Adhesive EC-2216B/A) used and the batch number when provided on the container (e.g., Batch 1234).

SIGNATURE/BADGE/DATE

Craftsman enter signature, badge number and date signifying the epoxy was applied per the requirements and the data recorded in Block 10B.

BLOCK 10C. - REQUIRED TESTS/RESULTS

Enter the number(s) for the required test(s) from the legend.

TEST RESULTS FINAL SURFACE FINISH MEETS REQUIREMENTS

The craftsman shall check the SAT or UNSAT block to indicate test.

SIGNATURE/BADGE/DATE

Craftsman enter signature, badge number and date signifying that each epoxy repair has been satisfactorily accomplished and tested in accordance with the requirements and the OQE documented in Blocks 7, 9, 10A, 10B and 11, and the surface finish meets requirements.

If UNSAT, the craftsman will initiate action to resolve the unsat condition and indicate the action taken in Block 11 and sign in Block 11. Do not sign Block 10 (for the specific line item) unless a satisfactory repair is completed or the unsat condition is accepted. If the condition is accepted, identify the document that grants acceptance in Block 11.

BLOCK 11 - ADDITIONAL INFORMATION/SKETCHES

This block can be used to provide additional information, signatures, and sketches (if required to clarify epoxy repair area(s) and/or shim/sleeve). If there is insufficient room, the back of the form or the addition of a second page is allowed for use. Include a signature, badge number and date with any additions to this block. Initials may be entered in lieu of an employee's signature and badge number, if a corresponding employee's signature and badge number appears elsewhere on the same page.

NOTE: IF MORE THAN ONE EPOXY REPAIR IS BEING ACCOMPLISHED, IDENTIFY THE ADDITIONAL INFORMATION, SIGNATURES AND SKETCHES BY THE LINE ITEM LETTERS IN BLOCK 9 (E.G., 9A, 9B).

BLOCK 12 - QA INSPECTOR/SHOP SUPERVISOR SIGNATURE/BADGE NO./DATE

Naval Shipyards: Production Shop Supervisor shall sign that the records have been reviewed for completeness.

BLOCK 13 - QAS SIGNATURE/BADGE NO./DATE

For SUBSAFE or SOC Components Only, QAS or cognizant QA representative as defined by local instructions, will sign, enter badge number and date in this block to indicate the completeness of the entries.

ELECTROPLATING REPAIR RECORD

QA FORM 17B (6/05)

Planning shall fill in blocks identified by a ♦ prior to issuing

♦ 1. SHIP HULL NO.		♦ 2. JCN		♦ 3. LWC/SHOP	♦ 4. CWP/ REC SER NO.	♦ 5. REFERENCES (COMP DETAIL/ASSY DWG & REV)				
6. SYSTEM/COMPONENT/ROTATABLE POOL SER NO.		♦ 7. ELECTROPLATING PROCESSES ARE IAW: <input type="checkbox"/> UIPI 0810-451 <input type="checkbox"/> OTHER _____		8. LEGEND FOR TYPE OF REPAIR, SEE BLOCK 9 D = DYNAMIC SURFACES (CL 3) S = STATIC SURFACES (CL 2) ♦ OT = OTHER (SPECIFY)(e.g., CL-1, CL-3A, etc.)		A.				
6. SYSTEM/COMPONENT/ROTATABLE POOL SER NO.		♦ 7. ELECTROPLATING PROCESSES ARE IAW: <input type="checkbox"/> UIPI 0810-451 <input type="checkbox"/> OTHER _____		8. LEGEND FOR TYPE OF REPAIR, SEE BLOCK 9 D = DYNAMIC SURFACES (CL 3) S = STATIC SURFACES (CL 2) ♦ OT = OTHER (SPECIFY)(e.g., CL-1, CL-3A, etc.)		B.				
6. SYSTEM/COMPONENT/ROTATABLE POOL SER NO.		♦ 7. ELECTROPLATING PROCESSES ARE IAW: <input type="checkbox"/> UIPI 0810-451 <input type="checkbox"/> OTHER _____		8. LEGEND FOR TYPE OF REPAIR, SEE BLOCK 9 D = DYNAMIC SURFACES (CL 3) S = STATIC SURFACES (CL 2) ♦ OT = OTHER (SPECIFY)(e.g., CL-1, CL-3A, etc.)		C.				
♦ 9. DESCRIPTION OF DEFECT & TYPE OF REPAIR				10. MATERIAL VERIFICATION & REPAIR (S) ACCOMPLISHED			♦ 11. REQD TEST (S)	12. TEST (S) RESULTS		
♦ ITEM A. PART NO./ NAME/DESCRIPTION OF DEFECT (S)		♦ REF DWG LTR	♦ BASE MATL	♦ TYPE OF REPAIR (SEE BLOCK 8 ABOVE)	♦ PLATING MATL REQD	BASE MATL VERIFIED <input type="checkbox"/> SAT	APPLIED PLATING THICKNESS WITHIN MAX ALLOWED OR RANGE <input type="checkbox"/> SAT	ELECTROPLATING HAS BEEN ACCOMPLISHED IN ACCORDANCE WITH REQUIREMENTS (Use Block 13 for clarification) SIGNATURE/BADGE/DATE	1. ADHESION 2. VT 3. PT 4. THICK 5. OTHER (SPECIFY)	2 ND OPERATOR VERIFICATION OF SATISFACTORY TEST ACCOMPLISHED SIGNATURE/BADGE /DATE
		♦ EXISTING PLATING MATL NONE <input type="checkbox"/>	♦ H2 BAKE REQD <input type="checkbox"/> YES <input type="checkbox"/> NO	♦ MAX THICKNESS OR RANGE	AFTER MACHINING DIMENSIONS: REMAINING DEFECTS DEPTH _____ <input type="checkbox"/> NONE	PLATING MATL APPLIED:				
♦ ITEM B. PART NO./ NAME/DESCRIPTION OF DEFECT (S)		♦ REF DWG LTR	♦ BASE MATL	♦ TYPE OF REPAIR (SEE BLOCK 8 ABOVE)	♦ PLATING MATL REQD	BASE MATL VERIFIED <input type="checkbox"/> SAT	APPLIED PLATING THICKNESS WITHIN MAX ALLOWED OR RANGE <input type="checkbox"/> SAT	ELECTROPLATING HAS BEEN ACCOMPLISHED IN ACCORDANCE WITH REQUIREMENTS (Use Block 13 for clarification) SIGNATURE/BADGE /DATE	1. ADHESION 2. VT 3. PT 4. THICK 5. OTHER (SPECIFY)	2 ND OPERATOR VERIFICATION OF SATISFACTORY TEST ACCOMPLISHED SIGNATURE/BADGE/DATE
		♦ EXISTING PLATING MATL NONE <input type="checkbox"/>	♦ H2 BAKE REQD <input type="checkbox"/> YES <input type="checkbox"/> NO	♦ MAX THICKNESS OR RANGE	AFTER MACHINING DIMENSIONS: REMAINING DEFECTS DEPTH _____ <input type="checkbox"/> NONE	PLATING MATL APPLIED:				
13. ADDITIONAL INFORMATION/SKETCHES: USE THE BACK OF THE SHEET FOR ADDITIONAL SPACE TO PROVIDE ADDITIONAL INFORMATION, AND SKETCHES TO CLARIFY ELECTROPLATE REPAIR AREA (S) (CRAFTSMAN/QAI SUBMIT A DF TO RESOLVE UNSAT DATA)										
14. QA INSPECTOR/SHOP SUPERVISOR SIGNATURE/BADGE NO. (RECORD REVIEWED FOR FINAL ACCEPTANCE)						15. QAS SIGNATURE/BADGE NO. (RECORD HAS BEEN REVIEWED FOR COMPLETENESS)				
DATE						DATE				

V-I-11-65

COMUSFLTFORCOMINST 4790.3 REV C CH-5

(This Page Intentionally Left Blank)

QA FORM 17B INSTRUCTIONS
ELECTROPLATING REPAIR RECORD

PURPOSE: To document the proper OQE for electroplating repairs on components when directed by the work procedure.

PROCEDURE: The numbered blocks on QA form 17B correspond with the instructions listed below. The planner shall fill in blocks identified by a ♦ (1 through 9 and 11) prior to issuing the CWP.

TOP OF FORM - Page _____ of _____

Enter page numbers.

BLOCK 1 - **SHIP HULL NO.**

Enter the ship's name and hull number, or enter the appropriate rotatable pool system designator (e.g., TRIPER, CCRP, AERP, SSN 688CL, etc.).

BLOCK 2 - **JCN**

Enter the Job Control Number (JCN). Naval shipyards enter Job Order and KeyOp.

BLOCK 3 - **LWC/SHOP**

Enter the lead shop (e.g., X38, outside machinist).

BLOCK 4 - **CWP/REC SERIAL NO.**

(Work Packaging/Planning Organization/Craftsman) Enter the CWP or REC serial number or enter NA if no CWP/REC is required. Do not list the REC revision.

BLOCK 5 - **REFERENCES (COMP DETAIL/ASSY DWG & REV)**

Enter all references used to identify component parts, material information, and test/inspection requirements including revision letter and if applicable, the assembly number (e.g., Assy D, Assy RA, etc.). For original issue (non revised) drawings, enter a dash (-). Revisions for Technical Manuals are not required. Include vendor name for vendor drawings.

BLOCK 6 - **SYSTEM/COMPONENT/ROTATABLE POOL SER NO**

Enter the noun name of the system and component (if applicable) being plated, (e.g., MSW-25). If the record is for in-shop restoration of rotatable pool material, enter the serial number of the material when known.

NOTE: ROTATABLE POOL SERIAL NUMBERS MAY BE ENTERED BY THE CRAFTSMAN IF NOT ENTERED BY PLANNING ORGANIZATION.

BLOCK 7 - **ELECTROPLATING PROCESSES ARE IN ACCORDANCE WITH**

Mark the applicable box for the electroplating process. Specify the process when OTHER is marked. Do not enter revision/change of procedure.

BLOCK 8 - **LEGEND FOR TYPE OF REPAIR**

Identifies the designators for Block 9 (TYPE OF REPAIR). For other than DYNAMIC (D) or STATIC (S) surfaces, PLANNING ORGANIZATION shall specify the type of repair on the line following the "OT=OTHER" designator, or in Block 13 if additional space is needed.

BLOCK 9 - **DESCRIPTION OF DEFECT & TYPE OF REPAIR**

NOTE: PLANNING ORGANIZATION SHALL COMPLETE ALL SECTIONS OF BLOCK 9 EXCEPT AS NOTED. ADDITIONAL QA 17B FORMS MAY BE ADDED AS CONTINUATION SHEETS IF NECESSARY.

PART NO./NAME/DESCRIPTION OF DEFECT AREA(S)

Enter part number or name (e.g., pc. 5, bonnet, body, etc.) and description of defect areas. Include dimension after machining and maximum depth of remaining defects prior to plating (e.g., Stem bore O-ring groove pitted, machined 0.010", removed all defects). For more than one of a kind component (XYZ fitting, threaded end) enter the total number of items (e.g., XYZ fitting, threaded end, 6 ea.). Identify each surface area being plated as a separate line item.

NOTE: USE BLOCK 13 AND THE BACK OF THE SHEET FOR ADDITIONAL INFORMATION AND/OR SKETCHES.

REFERENCE DRAWING LETTER

Enter the letter(s) corresponding to the reference(s) listed in Block 5 which provided the material, dimensional, and/or test and inspection information for the items listed in the "PART NO./NAME/DESCRIPTION OF DEFECT(S)" block(s).

BASE MATERIAL

Enter the required base material.

EXISTING PLATING MATERIAL

Identify any known existing plating or mark the NONE box.

TYPE OF REPAIR

Enter the symbol from the legend in Block 8 that identifies the type of electroplating repair being accomplished.

HYDROGEN BAKE REQUIRED

Mark the YES box when hydrogen bake is required; otherwise mark the NO box.

PLATING MATERIAL REQ'D

Enter the plating material to be applied.

MAXIMUM THICKNESS OR RANGE ALLOWED

Enter the maximum plating thickness allowed or the allowable thickness range (minimum/maximum).

BLOCK 10 - MATERIAL VERIFICATION & REPAIR(S) ACCOMPLISHED

NOTE: THE CRAFTSMAN SHALL COMPLETE ALL SECTIONS OF BLOCK 10.

BASE MATERIAL VERIFIED

Craftsman shall visually compare the required base material identified and the base material to be plated for obvious discrepancies such as color of material or material markings, and ensure that all existing plating has been removed or identified as being existing. Perform a generic material test if existing material cannot be identified. Check the "SAT" block if no discrepancies are found. Report any discrepancies to PLANNING ORGANIZATION for resolution.

AFTER MACHINING DIMENSIONS

When required by the TWD, record the dimensions after machining.

REMAINING DEFECTS DEPTH

Record the depth of any remaining defects. If no defects remain, mark the NONE box.

APPLIED PLATING THICKNESS WITHIN MAX ALLOWED OR RANGE

Mark SAT if the thickness of plating meets the maximum thickness or range identified by PLANNING ORGANIZATION in Block 9.

PLATING MATERIAL APPLIED

Enter the generic plating material applied (e.g., nickel cap, copper fill, etc.).

NOTE: IF THE APPLIED PLATING THICKNESS IS BEYOND THE MAXIMUM ALLOWED OR NOT WITHIN THE SPECIFIED RANGE, STOP WORK AND OBTAIN FURTHER TECHNICAL DIRECTION.

ELECTROPLATING REPAIR HAS BEEN ACCOMPLISHED IN ACCORDANCE WITH REQUIREMENTS

Craftsman(s) shall sign, record badge number, print name and date verifying that each ELECTROPLATING application has been satisfactorily accomplished in accordance with the requirements and the OQE documented in Blocks 7, 9 and 10 (and 13 when used) and is complete and accurate. For cases where further machining is required, the electroplating craftsman that completed the plating shall sign this block to indicate application of electroplating only, prior to sending the component to the machining craftsman. After the machining and test have been accomplished, a final signature shall be made indicating satisfactory completion of the form and the testing. The last signature indicates final acceptance. Use Block 13 for clarification of requirements.

BLOCK 11 - REQUIRED TEST(S)

Enter the designator(s) (i.e., 1-5) for the test(s) required to ensure proper installation/bonding. For "Other" (5), enter the type of test required in the block or in Block 13 if additional space is needed.

BLOCK 12 - TEST(S) RESULTS

2ND Operator, Inspector, or other person qualified to the plating procedure (other than the workpiece craftsman) shall sign, record badge number, print name and date to indicate the coating meets the acceptance criteria of the required test(s).

NOTE: SATISFACTORY LIQUID PENETRANT TEST RESULTS SHALL BE DOCUMENTED IN ONE OF THE FOLLOWING MANNERS:

1. A QUALIFIED NDT INSPECTOR OR QAI MAY SIGN, RECORD BADGE NUMBER AND DATE TO INDICATE SATISFACTORY TEST RESULTS.
2. THE CRAFTSMAN MAY ENTER THE NON-DESTRUCTIVE TEST (NDT) RECORD NUMBER (OR ATTACH A COPY OF THE RECORD) THAT DOCUMENTS THE SATISFACTORY RESULTS OF NDT PERFORMED BY A QUALIFIED NDT INSPECTOR. THE CRAFTSMAN SHALL SIGN (NAME, BADGE, DATE) FOR EACH ENTRY.

BLOCK 13 - ADDITIONAL INFORMATION/SKETCHES

This block may be used to provide additional information, signatures, and sketches (if required to clarify electroplate repair area(s)). If there is insufficient room, use of the back of the form or the addition of a second page is allowed. Include signature, badge number and date (except where the entry is pre-printed on the form by PLANNING ORGANIZATION with any entries in this block). Initials may be entered in lieu of an employee's signature and badge number, if a corresponding employee's signature and badge number/printed name appears elsewhere on the same page.

NOTE: IF MORE THAN ONE ELECTROPLATING REPAIR IS BEING ACCOMPLISHED, IDENTIFY THE ADDITIONAL INFORMATION, SIGNATURES, AND SKETCHES BY THE LINE ITEM NUMBERS IN BLOCK 9 (e.g., 9a, 9b, etc.). IF THE RECORD CONTAINS MULTIPLE PAGES, INCLUDE THE PAGE NUMBER OF THE REFERENCED ITEM LINE NUMBER.

BLOCK 14 - QUALITY ASSURANCE INSPECTOR/SHOP SUPERVISOR SIGNATURE/BADGE NO.

Production shop supervisor shall sign and print name that the record has been reviewed for completeness.

BLOCK 15 - QAS SIGNATURE/BADGE NUMBER/RECORD HAS BEEN REVIEWED FOR COMPLETENESS

For SUBSAFE or SOC Components Only: QAS or authorized QAO representative, as defined by local instructions, will sign, enter badge number, print name and date this block to indicate the completeness of the entries.

(This Page Intentionally Left Blank)

COMPONENT REPAIR RECORD – (MACHINING/MANUFACTURING/MODIFICATIONS)

QA FORM 17C (6/05)

Planning shall fill in blocks identified by a ♦ prior to issuing

Page _____ of _____

♦1. SHIP		HULL NO.		♦2. JCN		♦3. LWC/SHOP		♦4. CWP/REC SER NO.		♦5. SYSTEM/COMPONENT/ROTATABLE POOL SER NO.		
♦6. REFERENCES (COMPONENT DETAIL/ASSEMBLY DRAWING AND REV, SPECIFY ASSEMBLY NO. IF APPLICABLE)												
A.				B.				C.				
D.				E.				F.				
♦7. DESCRIPTION OF REPAIR(S)						8. RESULT OF REPAIR(S)						
LINE NO.	♦ PART NO./ DESCRIPTION	♦ REF DWG LTR	♦ QTY	♦ DESCRIPTION OF MODIFICATION(S) / MANUFACTURING PROCESS / SUPPLEMENTAL INFORMATION / INSTRUCTION Describe action or use the following legends: MM-Minor Machining HW-Hand Working MF- Manufacturing V - Vulcanizing O-rings	♦ REQUIRED/ MINIMUM FINAL DIMENSION(S) AND TOLERANCE	ACTUAL FINAL DIMENSION(S)	NEW MATERIAL MANUFACTURED/INSTALLED			♦ TEST REQ'D	PROCESS IDENTIFIED, MATERIAL AND TEST HAS BEEN SATISFACTORILY ACCOMPLISHED IN ACCORDANCE WITH REQUIREMENTS. MATERIAL NOT LISTED AS NEW, IS EXISTING AND IS ACCEPTABLE FOR RE-USE & IS INSTALLED.	
							QTY	L O E	MATERIAL IDENT/ DESCRIPTION		CRAFTSMAN SIGNATURE/ BADGE NO.	DATE
1												
2												
3												
4												
9. ADDITIONAL INFORMATION/SKETCHES: This block can be used to provide additional information, signatures and sketches (if required). Use back of the sheet for additional space. If NDT is required, record satisfactory NDT report number in this block or attach a copy of the report. (CRAFTSMAN/QAI SUBMIT A DF TO RESOLVE UNSAT DATA)												
10. QA INSPECTOR/SHOP SUPERVISOR SIGNATURE /BADGE NO. (RECORD REVIEWED FOR FINAL ACCEPTANCE)						11. QAS SIGNATURE/ BADGE NO. (RECORDS HAVE BEEN REVIEWED FOR COMPLETENESS)						
DATE						DATE						

V-1-11-71

(This Page Intentionally Left Blank)

QA FORM 17C INSTRUCTIONS
COMPONENT REPAIR RECORD

PURPOSE: To document the proper OQE for multiple repairs to a single component (i.e., machining, manufacturing, modifications) when directed by the work document.

PROCEDURE: The numbered blocks on QA form 17C correspond with the instructions listed below. Planning shall fill in blocks identified by a ♦ prior to issuing the CWP.

NOTE: THIS FORM ALLOWS MULTIPLE REPAIRS TO BE ACCOMPLISHED, BUT SHOULD BE LIMITED TO A SINGLE COMPONENT (E.G., TD-29/30 VALVE ASSEMBLY).

BLOCK 1 - **SHIP HULL NO.**

PLANNER - Enter the ship's name and hull number, or enter the appropriate rotatable pool system designator (e.g., TRIPER, CCRP, AERP, SSN 688CL, etc.).

BLOCK 2 - **JCN**

PLANNER - Enter the Job Control Number (e.g., 20884-EM01-2947, 3872556103/R01). Naval Shipyards enter Job Order and KeyOp.

BLOCK 3 - **LWC/SHOP**

PLANNER - Enter the lead shop (e.g., X56, outside machinist).

BLOCK 4 - **CWP/REC SERIAL NO.**

(REC Originator or PLANNER as defined by local instructions) Enter the CWP/REC serial number if applicable; otherwise mark NA. Do not list the REC Revision.

BLOCK 5 - **SYSTEM/COMPONENT/ROTATABLE POOL SER NO.**

PLANNER - Enter the noun name of the system, component (e.g., MSW-25). If the record is for in-shop repair/manufacture of rotatable pool item, enter the serial number of the item when known.

NOTE: ROTATABLE POOL SERIAL NUMBERS MAY BE ENTERED BY THE CRAFTSMAN IF NOT ENTERED BY THE PLANNER.

BLOCK 6 - **REFERENCES (COMPONENT DETAIL/ASSEMBLY DRAWING AND REVISION)**

PLANNER - Enter all references used to identify component parts, material information and required testing/inspection. Include revision letter and if applicable, the assembly number (e.g., Assy D, Assy RA, etc.). For original issue (non revised) drawings, enter a dash (-). For vendor drawings, include vendor name. Revisions for technical manuals are not required.

BLOCK 7 - **DESCRIPTION OF REPAIR(S)**

NOTE: PLANNING SHALL COMPLETE ALL SECTIONS OF BLOCK 7.

LINE NO. Pre-filled. A number to provide traceability to new material documented in Block 8.

PART NO./DESCRIPTION Enter part number/description/component assembly (e.g., pc 5, bonnet, body, stem bore, backseat, etc.).

NOTE: USE BLOCK 9 AND THE BACK OF THE SHEET FOR ADDITIONAL INFORMATION AND/OR SKETCHES.

REF DWG LTR Enter applicable reference letter(s) of the drawing or document listed in Block 6 that provides the material and/or dimensional information for the items listed in the "PART NO./DESCRIPTION" block.

QTY Enter quantity of items to repair. Enter NA if not applicable.

DESCRIPTION OF MODIFICATION(S) / MANUFACTURING PROCESS / SUPPLEMENTAL INFORMATION / INSTRUCTION

Enter description of action to perform (e.g., drill and nylok in accordance with reference (b), **MF** stem in accordance with reference (c), **V** in accordance with reference (d), **MM** .005” to remove pits, splice o-rings, etc.). The description must clearly identify the surface(s) to be machined. Use legend for abbreviation.

NOTE: USE BLOCK 9 AND THE BACK OF THE SHEET FOR ADDITIONAL INFORMATION AND/OR SKETCHES. IF ADDITIONAL SPACE IS REQUIRED, ADDITIONAL SHEETS SHALL HAVE CONTINUING PAGE NUMBERS AND INFORMATION FROM BLOCKS 1 THROUGH 5 ON EACH SHEET.

REQUIRED MINIMUM/FINAL DIMENSION(S) AND TOLERANCE

When minimum/final dimension documentation is required, Planning shall specify the final dimension(s) and tolerance(s) numerically, do not cite a drawing detail or other reference. Enter NA in this block and the Block 8 ACTUAL FINAL DIMENSIONS section if not applicable.

BLOCK 8 - RESULT OF REPAIR(S)

NOTE: THE CRAFTSMAN SHALL COMPLETE ALL SECTIONS OF BLOCK 8 EXCEPT THE SECTION TITLED “TEST REQ'D”.

ACTUAL FINAL DIMENSION(S)

When final dimension documentation is required by Planning, the craftsman shall record the actual final dimension(s) identified in Block 7. If final dimension documentation is not required, Planning shall enter NA in the block.

NOTE: CRAFTSMAN MAY ENTER “NA” IF REQUIRED/MINIMUM FINAL DIMENSION(S) AND TOLERANCE SECTION OF BLOCK 7 IS MARKED “NA” BY PLANNING.

NEW MATERIAL - MANUFACTURED/INSTALLED

Enter the following information for any parts/material, Level I and non-level, in the appropriate blocks. If a portion of a new valve is used to replace parts (e.g., bonnet and disc assembly), document the Level I number of the new valve and list the parts that the assembly consists of in the remarks block with a note that the stem and disc assembly were taken from the new valve.

QTY Enter the quantity of the replacement parts installed. Enter NA for raw material used in manufacture.

NOTE: THE TERM “ASSEMBLY” REFERS TO ONE PACKAGE OF PARTS (E.G., STEM AND DISC ASSEMBLY OR BALL AND SEAT ASSEMBLY) WHERE THE ITEM IS ORDERED UNDER ONE STOCK NUMBER, AND IS ASSIGNED ONE LEVEL I NUMBER.

LOE (Level of Essentiality, Level I) – Enter the MIC level (e.g., “I” or “LI”) for the part or assembly. Enter NA or dash (-) for non-Level.

MATERIAL IDENT/ DESCRIPTION Identification shall be in accordance with Table I or Forces Afloat. Record one of the following for raw material used to manufacture components:

TABLE 1- DOCUMENTATION REQUIREMENTS	
Material Control Level	Required Information
Level I Material Other Than Fasteners	MIC Number and any other traceability number, including any local traceability number (e.g., PNSY MLN – examples Z142, AB12).
Level I Fasteners	Either the MIC number or Material Marking, Color Code, Heat/Lot Number, and Manufacturers Symbol (Note: For nuts containing a self-locking insert, the color of the insert is the Manufacturer’s symbol).
Controlled Structural Material And SOC Control Division “A” Material	Traceability Number
SOC Control Division “B” Material	Markings providing identification to material type or specification
AERP And Other Rotatable Pool Material (688 Class, TRIPER, Etc.)	Enter the appropriate rotatable pool serial number (e.g. RP-148A, 4810-013-5812-A3-0113, TIN -292-11893, etc.)
Transferred And Cannibalized Material	Enter the Equipment Removal List No. or other material History/ Traceability number (ERL# XXXX, SSBN-600 EHF #24, etc.)
Other Material Within The LEVEL I/SUBSAFE Boundary And SOC Control Division “C” Material	1. Enter at least one of the following documentation attributes: <ol style="list-style-type: none"> Stock Number (from package/container) Part Number (from package/piece) Part Number and associated Manufacturing Work Procedure (for manufactured items) Local Traceability Number (from piece/tag) Drawing and Piece Number (from piece/tag) Generic, MIL-SPEC, or Material Specification Marking (from piece) NDT record numbers or test results for items verified by generic material testing. 2. For SOC components only: Enter the stock number of the “O-ring lubricant or any sealant used during assembly.

- MIC NUMBER
- RAW MATERIAL NSN
- GENERIC MATERIAL
- MIL-SPEC
- MATERIAL SPECIFICATION MARKING
- NDT RECORD OR TESTING RESULTS FOR GENERIC MATERIAL TESTING

NOTE: IF NDT IS REQUIRED, RECORD SATISFACTORY NDT REPORT NUMBER OR ENCLOSURE NUMBER IN THIS BLOCK AND ATTACH/INCLUDE A COPY OF THE REPORT.

TEST REQ'D Planning shall enter the test(s) (e.g., NDT, hydrostatic pressure testing, etc.) required to ensure proper certification.

PROCESS IDENTIFIED, MATERIAL AND TEST HAS BEEN SATISFACTORILY ACCOMPLISHED IN ACCORDANCE WITH REQUIREMENTS

Craftsman shall sign, record badge number and date of the signature, verifying that each repair process, material installed/utilized, and test has been satisfactorily accomplished in accordance with the requirements and the OQE documented in Blocks 7 and 8, respectively.

NOTE: IF UNSATISFACTORY, THE CRAFTSMAN WILL INITIATE ACTION TO RESOLVE THE UNSATISFACTORY CONDITION (E.G., SUBMIT A DF). INDICATE THE ACTION TAKEN TO RESOLVE THE UNSATISFACTORY CONDITION ALONG WITH A SIGNATURE, BADGE NUMBER AND DATE IN BLOCK 9. DO NOT SIGN BLOCK 8 (FOR THE SPECIFIC LINE NO.) UNLESS A SATISFACTORY REPAIR IS COMPLETED OR THE UNSATISFACTORY CONDITION IS ACCEPTED.

BLOCK 9 - ADDITIONAL INFORMATION/SKETCHES

This block can be used to provide additional information, signatures, and sketches (if required to clarify repair area(s)). If there is insufficient room, the back of the form or the addition of a second page is allowed. Include a signature, badge number, and date with any additions to this block. Initials may be entered in lieu of an employee’s signature and badge number, if a corresponding employee’s signature and badge number appears elsewhere on the same page.

NOTE: IF MORE THAN ONE REPAIR IS BEING ACCOMPLISHED, IDENTIFY THE ADDITIONAL INFORMATION, SIGNATURES, AND SKETCHES BY THE LINE ITEM NUMBERS IN BLOCK 7.

BLOCK 10 - QA INSPECTOR/SHOP SUPERVISOR/BADGE NO./DATE

NA if inspection is not required by the technical work document (e.g., TGI, FWP).

BLOCK 11 - QAS SIGNATURE/BADGE NO. (RECORDS HAVE BEEN REVIEWED FOR COMPLETENESS)

For SUBSAFE or SOC Components Only: QAS or cognizant QA representative as defined by local instructions, will sign, enter badge number, and date in this block to indicate the completeness of the entries.

For other components: the Production Shop/Work Center Supervisor shall sign that the records have been reviewed for completeness.

SUBMARINE FLIGHT CRITICAL COMPONENT (SFCC) ACCESS, REMOVAL AND INSTALLATION RECORD

QA FORM 17D (1/08) Planning shall fill in blocks identified by a ♦ prior to issuing

♦ 1. SHIP	HULL NO.	♦ 2. JCN	♦ 3. LWC/SHOP	♦ 4. CWP/REC SER NO.
♦ 5. SYSTEM(S) COMPONENT		♦ 6. NOMENCLATURE		♦ 7. REFERENCE DESIGNATION

♦ 8. REFERENCES

A.		B.		C.	
D.		E.		F.	

9. DIAGNOSTICS BLOCK CONTINUED ON REVERSE

ALERT MESSAGE(S)	SYSTEM STATUS DISPLAY FAULT STATUS	LINE REPLACEABLE UNIT (LRU) CALLOUT(S)	ADDITIONAL DIAGNOSTIC INDICATIONS
------------------	------------------------------------	--	-----------------------------------

EXISTING PERTINENT FAULT DATA

10. EXISTING SFCC REMOVAL

SFCC NSN with SMIC	SFCC PART NUMBER	SFCC SERIAL NUMBER	CHASSIS LOCATION & INFO	SW VERSION REMOVED

11. NEW SFCC INSTALLATION/SFCC PROGRAMMED IN PLACE

SFCC NSN with SMIC	SFCC PART NUMBER	SFCC SERIAL NUMBER	CHASSIS LOCATION & INFO	SW VERSION INSTALLED	SFCC CONFIGURED	PROPERLY INSTALLED & ENGAGED/ CABLE RECONNECTED
					<input type="checkbox"/> SAT <input type="checkbox"/> UNSAT	<input type="checkbox"/> SAT <input type="checkbox"/> UNSAT

12. SFCC RESTORATION

13. OPERATIONAL VERIFICATION

SFCC POWERED UP	ONLINE/AVAILABLE	SYSTEM STATUS OK	BUILT IN TEST	SFCC ENGAGED	OPERABILITY TEST
<input type="checkbox"/> SAT/ <input type="checkbox"/> UNSAT	<input type="checkbox"/> SAT/ <input type="checkbox"/> UNSAT	<input type="checkbox"/> SAT/ <input type="checkbox"/> UNSAT	<input type="checkbox"/> SAT/ <input type="checkbox"/> UNSAT	<input type="checkbox"/> SAT/ <input type="checkbox"/> UNSAT	<input type="checkbox"/> SAT/ <input type="checkbox"/> UNSAT

14. SOFTWARE INSTALLATION

15. SOFTWARE VERIFICATION

INSTALLATION SOFTWARE REV	SFCC SOFTWARE REV	VDD CHECKSUM	INSTALLATION CHECKSUM	NEW SFCC CONFIGURED SIMILARLY AS REMOVED SFCC
				<input type="checkbox"/> SAT/ <input type="checkbox"/> UNSAT

16. REMARKS

--	--	--	--

17. CRAFTSMAN SIGNATURE

DATE

18. AIT LEADER/INSPECTOR SIGNATURE

DATE

--	--	--	--

19. RECORD HAS BEEN REVIEWED FOR COMPLETENESS

OSIC/QAS/QAO SIGNATURE	DATE

(This Page Intentionally Left Blank)

QA FORM 17D INSTRUCTIONSSUBMARINE FLIGHT CRITICAL COMPONENT (SFCC) ACCESS, REMOVAL AND INSTALLATION RECORDREFERENCES:

- (a) NAVSEA T9044-AD-MAN-010 - Requirements Manual for Submarine Fly-By-Wire Ship Control Systems

NOTE: PLANNING SHALL FILL IN BLOCKS IDENTIFIED BY A ♦ PRIOR TO ISSUING.

PURPOSE: To provide a standard form to document the SFCC access, replacement, removal and installation record capturing the requirements of reference (a), Appendix H.

REQUIREMENTS:

1. The FORM 17D is required for all SFCC work within the boundary specified in reference (a).
2. Form 17D shall be used for each component that requires controlled access, replacement, removal or installation.

NOTE: ANY BLOCK NOT USED WILL BE MARKED "N/A".

BLOCK 1 - SHIP/HULL NO.

Planner enter the ship's name and hull number.

BLOCK 2 - JCN

Planner enter the Job Control Number (JCN).

BLOCK 3 - LWC/SHOP

Planner enter the lead shop assigned to install the component.

BLOCK 4 - CWP/REC SER NO.

Planner enter the CWP/REC serial number or enter NA if no CWP/REC is required. Do not list the CWP/REC revision.

BLOCK 5 - SYSTEM(S)/COMPONENT

Planner enter the noun name of the system and component (if applicable) (e.g., SCPU CHANNEL A CPU#2 or CIRCUIT 1DB). If record is for inshop restoration, enter the serial number of the material if known.

BLOCK 6 - NOMENCLATURE

Planner enter the system/component nomenclature as described in the technical documentation.

BLOCK 7 - REFERENCE DESIGNATION

Planner enter the reference designation of the component as described in the technical documentation.

BLOCK 8 - REFERENCES

Planner enter the applicable component technical reference documents.

BLOCK 9 - DIAGNOSTICS

Check the block if diagnostic codes/data are continued on reverse of form. If necessary, additional diagnostic codes/data may be listed on reverse of form.

Craftsman record diagnostic data as appropriate for SFCC being replaced as part of repair efforts. Mark "N/A" if repair effort is not being performed.

- Alert Messages - Enter any observed Alert Messages displayed by the Ship Control Station
- Fault Status - Enter any fault status message observed at the system status display
- LRU Callout - Enter any Line Replaceable Unit (LRU) Callouts

- Additional Diagnostic Indications - Record any additional diagnostic information
- Existing pertinent fault data - Record any existing pertinent fault data identified on the MC/DMAC

BLOCK 10 - **EXISTING SFCC REMOVAL**

List data required as appropriate for each of the provided blocks. Record the specific components software revision level. If software is pre-programmed on SFCC, record the software revision level identified on the applicable SFCC Certificate of Conformance.

BLOCK 11 - **NEW SFCC INSTALLATION**

Craftsman mark as "SAT", "UNSAT" or list data required as appropriate for each of the provided blocks. Record the specific components software revision level. If software is pre-programmed on SFCC, record the software revision level identified on the applicable SFCC Certificate of Conformance.

BLOCK 12 - **SFCC RESTORATION**

Craftsman mark as "SAT" or "UNSAT" as appropriate.

BLOCK 13 - **OPERATIONAL VERIFICATION**

Craftsman mark as "SAT" or "UNSAT" as appropriate.

BLOCK 14 - **SOFTWARE INSTALLATION**

NOTE: **BLOCK 14 ONLY USED DURING SYSTEM/SOFTWARE UPGRADES/ALTERATIONS.**

Craftsman list data required as appropriate for each of the provided blocks (N/A if not used).

- Installation Software Rev - Record the Ship Control System operational software revision level identified in the change vehicle.
- VDD Checksum - Record the checksum value identified in the Version Description Document (VDD). Should match Installation Checksum.

BLOCK 15 - **SOFTWARE VERIFICATION**

NOTE: "INSTALLATION CHECKSUM" IS ONLY USED FOR PROGRAMMED SW SMIC SFCC COMPONENTS OR DURING VU SMIC UPGRADES/ALTERATION (N/A IF NOT USED).

- Installation Checksum - Record the checksum as observed during installation. Should match VDD Checksum from original installation.
- New SFCC Configured Similarly as Removed SFCC - Verify that the SFCC is configured similarly as the SFCC removed from the FBW SCS chassis in accordance with the controlled work package documentation. This includes satisfactory VDD Checksum verification (if applicable).

BLOCK 16 - **REMARKS**

Craftsman or Alteration Installation Team (AIT) Lead will record amplifying information as required or additional space is required, and will sign, print name and date Block 16.

BLOCK 17 - **CRAFTSMAN SIGNATURE**

Craftsman shall sign this block signifying that the work has been accomplished.

BLOCK 18 - **AIT LEADER/INSPECTOR SIGNATURE**

(SHIP'S FORCE) INSPECTOR/QAI will enter signature, date and badge number for final review, signifying the accuracy of the completed form and witnesses testing associated with Blocks 13, 14 and 15 (as applicable). If any entry is UNSAT, initiate action to resolve the UNSAT condition and indicate the action taken in the "Remarks" block. Do not sign unless a satisfactory repair is completed or the UNSAT condition is accepted.

BLOCK 19 - **RECORD HAS BEEN REVIEWED FOR COMPLETENESS**

The OSIC/QAS/QAO shall sign, date and enter badge number for final review, signifying entries are complete and that the data agrees with the listed requirements.

(This Page Intentionally Left Blank)

QA FORM 17SI INSTRUCTIONS
STUD INSTALLATION RECORD

PURPOSE: To document the proper OQE for installing Level One studs in a SOC, SUBSAFE or Level One application when directed by the work procedure.

PROCEDURE: The numbered blocks on QA form 17SI correspond with the instructions listed below. Blocks marked with a ♦ shall be completed by the planner prior to issue.

BLOCK 1 - SHIP HULL NO.

Enter the ship's name and hull number.

BLOCK 2 - JCN

Enter the JCN.

BLOCK 3 - LWC

Enter the shop number of the LWC.

BLOCK 4 - CWP/REC SERIAL NO.

Enter the CWP/REC serial number or enter N/A if no CWP/REC is required. Do not list the CWP/REC revision.

BLOCK 5 - SYSTEM/COMPONENT

Enter the noun name of the system and component being repaired. (e.g., MSW-25 Hull Insert). If the record is for in-shop repair/manufacture of rotatable pool item, enter the serial number of the item.

BLOCK 6 - NEW MATERIAL DESCRIPTION

NOTE: THE CRAFTSMAN SHALL COMPLETE ALL SECTIONS OF BLOCK 6.

MATERIAL DESCRIPTION

Enter a description of the new studs installed in the joint. Include diameter, thread, and length (e.g., Stud, 5/8"-11x3").

QTY - Record the quantity of the new studs installed.

LOE - Enter the Level of Essentiality as "I" or "NA" as appropriate.

IDENTIFICATION/MIC/TRACEABILITY NO.

Document the markings from the fastener to include either:

- (1) The color code and the heat/lot number, material type and manufacturer's symbol (for nuts containing a self-locking insert, the color of the insert is the manufacturer's symbol).
- (2) The MIC number (when MIC number is on the fastener or on the individual tag for some small fasteners).

BLOCK 7 - DESCRIPTION OF STUD DATA REQUIREMENTS

NOTE: THE PLANNER SHALL COMPLETE ALL SECTIONS OF BLOCK 7.

JOINT MAPPING DRAWING & REV

Enter the joint mapping drawing and revision. Enter NA when no mapping drawing exists.

JOINT NO/JOINT DESCRIPTION

Enter the joint number if applicable or clearly describe the installation location. If joint numbers are assigned via a sketch in the TWD, identify the sketch enclosure number and TWD number.

REQUIRED STUD DIAMETER & THREAD SERIES

Enter the required diameter and thread series of the replacement stud.

DETAIL DRAWING & REV

Enter the detailed drawing and revision number. For original issue (non revised) drawings, enter a dash (-). Include vendor name for vendor drawings. Revisions for Technical Manuals are not required.

STUD PIECE NO.

Enter the detailed drawing pertaining to the stud.

REQUIRED STUD LENGTH

Enter the required length of the stud.

REQUIRED CLASS OF FIT AUTHORIZED INSTALLATION METHOD

Mark the appropriate block for the required class of fit.

TORQUE REFERENCE

Enter the source for the torque value (e.g., NAVSEA S9505-AM-GYD-010, SAE J2270, drawing, MS, etc.).

REQUIRED MIN BREAKAWAY TORQUE OR STUD SETTING TORQUE

Enter the required minimum breakaway torque, the tolerance or range, and mark the appropriate torque units box (ft-lb or in-lb).

BLOCK 8 - STUD INSTALLATION DOCUMENTATION

REQUIRED ANAEROBIC LOCKING COMPOUND: GRADE

Planner enter the required grade of anaerobic locking compound. Leave blank for Class 5 installation method.

ACTUAL ANAEROBIC LOCKING COMPOUND MANUFACTURER & GRADE

Record the manufacturer and grade of the thread locking compound used. Leave blank for Class 5 installation method.

REQUIRED STUD STANDOUT & TOLERANCE

Enter the required stud standout and tolerance.

ACTUAL STUD(S) STANDOUT

Record the actual stud standout for each new or reset existing stud.

BLOCK 9 - SKETCH/REMARKS

Provide a sketch of the fastener circle, showing all the newly installed and all re-installed existing studs and their orientation to the component.

BLOCK 10 - CRAFTSMAN SIGNATURE/BADGE NO./DATE

Craftsman print name, enter signature, badge number and date after completing Blocks 6, 8 and 9. Do not sign Block 10 unless signing for satisfactory results. If unsat, the craftsman will report the unsat condition and document the rework on the applicable QA form. If only one fastener is unsat, the craftsman may sign for completing the installation of the remaining studs but must clearly annotate in Block 9 the location of the stud and reason for the unsatisfactory condition.

Craftsman signature signifies the following:

- Fastener size, length, and class of fit are per the stated requirements
- Minimum breakaway torque or stud setting or stud setting torque (as applicable) is satisfactory

- Stud installation complies with all installation requirements
- All new material meets specified requirements, is installed and listed in Block 6
- Material not listed as new is existing, and is acceptable for re-use and is installed

BLOCK 11 - QAI/SHOP SUPERVISOR SIGNATURE/BADGE NO./DATE

NOTE: REQUIRED FOR SOC, SUBSAFE AND LEVEL I COMPONENTS ONLY.

Inspector/shop supervisor print name, enter signature, badge number and date certifying the accuracy of the data recorded in Block 6, 8 and 9. This signature is only required for SOC, SUBSAFE and Level I components.

BLOCK 12 - RECORDS HAVE BEEN REVIEWED FOR COMPLETENESS

QAS or QAO will print name, enter signature, badge number and date for final review, signifying the accuracy of the completed form for SUBSAFE/SOC items only. For other components, the Work Center supervisor shall sign and date the form signifying the accuracy of the completed form.

(This Page Intentionally Left Blank)

HANDLING EQUIPMENT TEST RECORD

QA FORM 17W (Front) For CWPs, planning shall fill in blocks identified by a ♦ prior to issuing
 Page ____ of ____

♦ 1. SHIP HULL NO.	♦ 2. JCN	♦ 3. LWC/SHOP	♦ 4. CWP/REC SER NO.
♦ 5. Equipment Description:			
♦ 6. Log I.D. Number:		♦ 7. Manufacturer or Local Serial Number (Hull No.- Work Center-Number):	
♦ 8. NAVSEA Drawing Number/Revision used for Test:			
♦ 9. Safe Working Load (SWL) in pounds:		♦ 10. Dynamic Test Load (DTL) in pounds:	
♦ 11. Static Test Load (STL) in pounds:		♦ 12. STL Frequency in months:	
13a. Test Type	13b. Testing Activity	13c. Test Activity Witness	13d. Quality Assurance
Action		Signature	Signature
Date		Print Name	Print Name
Action		Signature	Signature
Date		Print Name	Print Name
Action		Signature	Signature
Date		Print Name	Print Name
Action		Signature	Signature
Date		Print Name	Print Name
Action		Signature	Signature
Date		Print Name	Print Name
14. Remarks:			
TMDE TYPE OF EQUIPMENT / RANGE		TMDE ID. NUMBER	TMDE CAL DUE
TMDE TYPE OF EQUIPMENT / RANGE		TMDE ID. NUMBER	TMDE CAL DUE
TMDE TYPE OF EQUIPMENT / RANGE		TMDE ID. NUMBER	TMDE CAL DUE

QA FORM 17W INSTRUCTIONSHANDLING EQUIPMENT TEST RECORD INSTRUCTIONS

PURPOSE: To provide a report form for work, tests and inspections not covered by other QA forms. This form can be used for handling equipment weight testing except cranes and strategic weapons handling equipment.

PROCEDURE: The numbered blocks on QA form 17W correspond with the instructions listed below. When this form is used to certify manufacture or repair of handling equipment, the planning organization shall fill in Blocks 1 through 11 (identified by a ♦) prior to issuing a procedure requiring use of this form. When this form is used to perform periodic handling equipment testing, the weight test supervisor/shop supervisor shall fill in Blocks 1 through 12 (identified by a ♦) prior to performing testing.

BLOCK 1 - **SHIP HULL NO.**

Enter the ship's name and hull number.

BLOCK 2 - **JCN**

Enter the JCN.

BLOCK 3 - **LWC/SHOP**

Enter the shop number of the LWC.

BLOCK 4 - **CWP/REC SERIAL NO.**

Enter the CWP serial number or enter NA if no CWP/REC is required. Do not list the CWP/REC revision.

BLOCK 5 - **EQUIPMENT DESCRIPTION**

Enter the name and a readily understood description of the equipment or component name from the TLMD. If the equipment is permanently installed (e.g., a monorail or padeye, etc.), enter the compartment location, (e.g., torpedo room, port, overhead, and frame 21.)

BLOCK 6 - **LOG I.D. NUMBER**

Enter log identification number from the Test Load Methods Drawing (TLMD) when applicable.

BLOCK 7 - **MANUFACTURER OR LOCAL SERIAL NUMBER**

Enter the manufacturer or Local Serial Number when applicable (i.e., Hull No. - Work Center - Number).

BLOCK 8 - **NAVSEA DRAWING NUMBER/REVISION**

Enter NAVSEA drawing number and revision for drawing used to conduct the test.

BLOCK 9 - **SAFE WORKING LOAD (SWL)**

Enter the item's Safe Working Load (SWL), in pounds, from the TLMD.

NOTE: LIST THE SWL FOR BOTH THE SHORT AND LONG POSITIONS FOR LOADING POLES.

BLOCK 10 - **DYNAMIC TEST LOAD (DTL)**

Enter the item's Dynamic Test Load (DTL), in pounds, from the TLMD.

BLOCK 11 - **STATIC TEST LOAD (STL)**

Enter the item's Static Test Load (STL), in pounds, from the TLMD.

BLOCK 12 - **STL FREQUENCY**

Enter the frequency required for the static test in months.

NOTE: STRATEGIC WEAPONS HANDLING EQUIPMENT COVERED UNDER THE PREVENTIVE MAINTENANCE MATERIAL PROGRAM (PMMP) DOES NOT REQUIRE A QA FORM 17W. EQUIPMENT NOT COVERED UNDER THE PMMP MUST MEET THE REQUIREMENTS OF THIS MANUAL.

BLOCK 13 - **TEST TYPE**

Enter the test date, the action taken (e.g., STL, DTL, MT, VT, tension, compression, short/long for loading poles) and the name or hull number of the testing facility. Print the name (e.g., first name, middle initial and last name) of the test facility witness. The test facility witness shall then sign the block above the name. If test facility witness signature and/or QA signature cannot be obtained, the source document bearing that signature will be obtained and retained in the weapons handling test record log. Only the latest source document applicable to any particular piece of equipment/component need be retained.

BLOCK 14 - **REMARKS**

(Craftsman/QAI/QAS/Planning) Enter any pertinent remarks or additional information related to the repair/assembly of the component. Each entry shall contain signature, badge number and date except where the entry is pre-printed on the form by Planning.

FIGURE 1 Record measurement in blocks provided on the back of the QA form 17W when applicable.

- a. Hook throat opening measurements and tram point pre/post test measurements when new, or as first recorded, per NSTM 700 or PMS.
- b. Length and link diameters of hoist load chains when new, or as first recorded, per NSTM 700 or PMS.

SILVER BRAZE FABRICATION & INSPECTION RECORD

QA FORM 18 (NEW 09/05) (Work planning to fill in blocks/evaluate block options identified by a ♦ prior to release)

♦ 1. SHIP		♦ HULL NO.		♦ 2. JCN		♦ 3. LWC/SHOP		♦ 4. CWP/REC SER NO.		♦ 5. SYSTEM/COMPONENT						
♦ 6. PURPOSE: <input type="checkbox"/> PRODUCTION <input type="checkbox"/> QUAL <input type="checkbox"/> RE-QUAL <input type="checkbox"/> MAINTENANCE OF QUAL				♦ 7. INSTALLATION DWG.				♦ 8. JOINT ID/DESCRIPTION								
♦ 9. JOB DESCRIPTION						♦ 10. MAP JOINT DWG			♦ 11. <input type="checkbox"/> P-3A SPECIAL <input type="checkbox"/> P-3A <input type="checkbox"/> P-3B							
♦ 12. BRAZE PROC.		♦ 13. BRAZE PROCESS <input type="checkbox"/> H101 <input type="checkbox"/> H103 <input type="checkbox"/> NA		14. JOINT DESIGN <input type="checkbox"/> SOCKET <input type="checkbox"/> SLEEVE <input type="checkbox"/> FACE FEED <input type="checkbox"/> SINGLE INSERT			15. ACCESS <input type="checkbox"/> RESTRICTED (<4") <input type="checkbox"/> UNRESTRICTED			16. <input type="checkbox"/> ORIGINAL <input type="checkbox"/> REPAIR (1) <input type="checkbox"/> REPAIR (2)						
17. FITTING, PIPE, AND TUBE MATERIALS																
♦ DWG PC NO.	♦ SIZE	THICKNESS	♦ MIL-SPEC	♦ P-NUMBER	♦ NEW OR EXIST	IDENT (E.G., MIC NO./NSN/TRACEABILITY NO.)										
					<input type="checkbox"/> NEW <input type="checkbox"/> EXISTING											
					<input type="checkbox"/> NEW <input type="checkbox"/> EXISTING											
18. LAND WIDTH	PIPE	FITTING	CENTER	SOCKET DEPTH	19. FLUX ♦ <input type="checkbox"/> MINIMUM FLUX FED SPEC O-F-499: <input type="checkbox"/> TYPE A <input type="checkbox"/> TYPE B											
20. BRAZE ALLOY	MIL-SPEC			F- NUMBER	GRADE	IDENT (E.G., MIC NO./NSN/TRACEABILITY NO.)										
INSERT RING																
ROD																
JOINT DATA IS CORRECT, JOINT AND MATERIAL MEETS SPECIFIED REQUIREMENTS				21. CRAFTSMAN SIGNATURE/BADGE				DATE								
22. INSPECTION TYPE			23. ACCEPT	24. REJECT	25. SIGNATURE (Inspector/Craftsman)			BADGE NO.	DATE							
NDT EXISTING PPG <input type="checkbox"/> NOT REQD	<input type="checkbox"/> VT5X <input type="checkbox"/> PT															
NDT EXISTING FTG <input type="checkbox"/> NOT REQD	<input type="checkbox"/> VT5X <input type="checkbox"/> PT															
DIAMETRICAL CLEARANCE																
FIT UP INSPECTION																
ALLOY DRAW																
EVIDENCE OF ALLOY																
BOTTOM CLEARANCE																
26. BRAZED POSITION <input type="checkbox"/> VERT <input type="checkbox"/> HORZ	BRAZING REQUIREMENTS ARE SATISFACTORY				27. BRAZER SIGNATURE/BADGE NO.				DATE							
♦ 28. <input type="checkbox"/> NO. UT INSPECTION REQUIRED (NON P-3 A SPECIAL)				NDT PROCEDURE NO.				ACCEPTANCE STANDARD: NAVSEA 0900-LP-001-7000								
29. SCANNING METHOD <input type="checkbox"/> STATIC <input type="checkbox"/> CONTINUOUS		30. EQUIPMENT MFG.			MODEL		SERIAL NO.		CAL DUE DATE							
31. TRANSDUCER MFG.			SIZE	SERIAL NO.	FREQUENCY			32. COUPLANT TYPE								
33. LAND	1	2	3	4	5	6	7	8	9	10	11	12	13	14	TOT.	AVG.
PPG																
MID																
FTG																
34. TOTAL % BOND		35. DISPOSITION <input type="checkbox"/> ACCEPT <input type="checkbox"/> REJECT			36. UT INSPECTOR/BADGE						DATE					
37. REMARKS (SHOP REMARKS ALSO)																
FINAL DISPOSITION		38. SUPERVISOR (Signature/Badge/Date)						39. WCS (QAS For SUBSAFE/SOC Only) (Signature/Badge/Date)								

(This Page Intentionally Left Blank)

QA FORM 18 INSTRUCTIONSSILVER BRAZE FABRICATION AND INSPECTION RECORD

- PURPOSE:** To provide a standard form for documenting OQE for a silver brazed joint.
- PROCEDURE:** The numbered blocks on QA form 18 correspond with the instructions listed below. The planner preparing the work procedure will complete blocks identified with the diamond symbol. The craftsman will complete blocks without the diamond symbol. The NDT Supervisor will verify the completed form and sign in Block 38. A QA form 18A will be attached to this form to complete each brazed joint record.
- NOTE:** BLOCKS 13, 17, P-NUMBER, 20, F-NUMBER, AND 26 ARE FOR QUALIFICATION USE ONLY AND ARE NOT REQUIRED FOR PRODUCTION BRAZES.
- PAGE OF** Enter the page number, starting with page 1, of total number of QA forms 18 and 18A associated with the joint (e.g., 1 of 2, 1 of 3).
- BLOCK 1** - SHIP HULL NO.
Enter the tended ship's name and hull number.
- BLOCK 2** - JCN
Enter the JCN.
- BLOCK 3** - LWC/SHOP
Enter the shop number for the LWC.
- BLOCK 4** - CWP/REC SER NO.
Enter the CWP/REC serial number or enter N/A if no CWP/REC is required. Do not list the CWP/REC revision.
- BLOCK 5** - SYSTEM/COMPONENT
Enter the system/component noun name.
- BLOCK 6** - PURPOSE
Check appropriate block.
- BLOCK 7** - INSTALLATION DRAWING
Enter the installation drawing number and revision.
- BLOCK 8** - JOINT ID/DESCRIPTION
Enter the map joint number from the applicable plan (Block 10). If not a mapped joint, assign a local unique joint ID number or enter a description of the joint.
- BLOCK 9** - JOB DESCRIPTION
Enter a brief statement describing the work.
- BLOCK 10** - MAP JOINT DWG
Enter ship's plan number and revision, which show and identify the map number of the joint being brazed or enter "NA" if there isn't a map drawing.
- BLOCK 11** - P-3A SPECIAL/P-3A/P 3B
Enter an "X" in the appropriate box.
- BLOCK 12** - BRAZE PROCEDURE
Enter the braze procedure used, including revision and change.
- BLOCK 13** - BRAZE PROCESS
Enter an "X" in the appropriate block per NAVSEA 0900-LP-001-7000.

BLOCK 14 - **JOINT DESIGN**

Enter an "X" in the appropriate boxes.

BLOCK 15 - **ACCESS**

Enter an "X" in the appropriate box.

BLOCK 16 - **ORIGINAL/REPAIR**

Enter an "X" in the appropriate box.

BLOCK 17 - **FITTING, PIPE AND TUBE MATERIALS**

- a. Enter the fitting piece and pipe/tube piece number from the installation drawing (Block 7) or NA if not available.
- b. Enter the size of the fitting and pipe/tube (e.g., 1/2 Normal Pipe Size (NPS)).
- c. Enter the thickness (.127 inches).
- d. Enter the actual thickness (minimum value) of the fitting and pipe/tube.
- e. Enter the material specification of the component (from Table 4-4 of NAVSEA 0900-LP-001-7000), when known. If existing, enter "existing".
- f. For qualification purposes, enter the applicable P-number from Table 4-4 of NAVSEA 0900-LP-001-7000.
- g. Enter an "X" in the appropriate New/Exist box.
- h. Enter the material marking of the component. Enter the MIC Number for new level I material installed or N/A. Enter other material markings if material is not required to be level I and marking is present. If fitting is existing and is not marked, an acid check when required by the TWD to ensure generic material is correct shall be accomplished and documented in remarks block.

BLOCK 18 - **LAND WIDTH**

Enter the land width or socket depth for fittings without inserts. N/A blocks that are not applicable.

BLOCK 19 - **FLUX**

- a. Enter an "X" if minimum flux technique was used.
- b. Enter an "X" for flux type per FED-SPEC O-F-499.

BLOCK 20 - **BRAZE ALLOY**

Enter the Mil-Spec and the alloy grade. Enter the MIC Number when new level I brazing material is installed in a Level I application or enter "NA" for non-level applications when material is not required to be level I.

BLOCK 21 - **JOINT DATA IS CORRECT/CRAFTSMAN SIGNATURE**

Verify data entered is correct and actual material to be used/installed is as specified. Sign name, enter date and badge number to certify information is correct.

BLOCK 22 - **INSPECTION TYPE**

- a. Mark the appropriate type of inspection.
- b. Diametrical Clearance – Enter the actual measurement. Acceptance criteria is per Table 5.2 of NAVSEA 0900-LP-001-7000.
- c. Fit up Inspection-Acceptance criteria of paragraph 7.2.1.a of NAVSEA 0900-LP-001-7000.
- d. Alloy Draw-Acceptance criteria per paragraph 7.2.1.d of NAVSEA 0900-LP-001-7000.
- e. Evidence of Alloy-Acceptance criteria per paragraph 7.2.1.e of NAVSEA 0900-LP-001-7000.
- f. Clearance Acceptance criteria per paragraph 7.2.1.f of NAVSEA 0900-LP-001-7000.

BLOCK 23/24 - ACCEPT/REJECT

Mark the appropriate column.

BLOCK 25 - SIGNATURE

Enter the signature, badge number and date.

BLOCK 26 - BRAZED POSITION

Mark the appropriate block for position brazing performed.

BLOCK 27 - BRAZE PROCEDURE IS SATISFACTORY

Brazer sign name and enter Brazer badge number and date to certify all joint information is correct.

BLOCK 28 - NDT REQUIREMENTS

- a. Enter an "X" if Ultrasonic Testing (UT) is not required.
- b. Enter the NDT procedure number.

BLOCK 29 - SCANNING METHOD

Enter an "X" in the appropriate box.

BLOCK 30 - EQUIPMENT MANUFACTURER

Enter Equipment Manufacture Name, Model, Serial number and calibration Due Date of Equipment.

BLOCK 31 - TRANSDUCER MANUFACTURER

Enter Equipment Manufacture Name, Size, Serial number, and Frequency of Equipment.

BLOCK 32 - COUPLANT TYPE

Enter the name of the fluid used.

BLOCK 33 - LAND/PIPE/MID/FTG

Enter the percent of bond for the various segments of the lands. Enter NA as applicable. Enter the total for all segments used and the average percent bond for the lands (or passes of a non insert fitting).

BLOCK 34 - TOTAL % BOND

Calculate and enter the total % bond for the joint.

BLOCK 35 - DISPOSITION

Enter an "X" in the appropriate box to accept or reject the joint.

BLOCK 36 - INSPECTOR/BADGE/DATE

UT inspector will sign, enter badge number and date, signifying the technical accuracy of the data recorded and acceptance/rejection of the joint.

BLOCK 37 - REMARKS

Enter any additional information.

BLOCK 38 - FINAL DISPOSITION/SUPERVISOR

NDT Supervisor enter signature, badge number and date signifying the joint is satisfactory and that all data on the form is completed satisfactorily.

BLOCK 39 - FINAL DISPOSITION/RECORD HAS BEEN REVIEWED FOR COMPLETENESS/QAS

QAS or QAO will print name, enter signature and date for final review, signifying the accuracy of the completed form for SUBSAFE/SOC items only. For other components, the Work Center supervisor shall sign and date the form signifying the accuracy of the completed form.

(This Page Intentionally Left Blank)

ULTRASONIC INSPECTION RECORD
QA FORM 18A

PAGE OF

2. SHIP		HULL		3. JCN				4. LWC/SHOP				5. CWP/REC SERIAL NO.			
ULTRASONIC EQUIPMENT AND INSPECTION DATA															
6. EQUIPMENT MANUFACTURER			7. MODEL NO.		8. SERIAL NO.		9. TRANSDUCER MANUF.			10. SIZE/FREQ		11. SERIAL NO.			
12. SCANNING METHOD <input type="checkbox"/> STATIC <input type="checkbox"/> CONTINUOUS			13. COUPLANT TYPE		14. CAL EXP DATE		15. JOINT ID NO.				16. DWG NO.				
17. REMARKS/NOTES															
18. LAND%	1	2	3	4	5	6	7	8	9	10	11	12	TOTAL	TOTAL BOND	
PIPE															
MIDDLE															
FITTING															
19. DISPOSITION <input type="checkbox"/> ACCEPT <input type="checkbox"/> REJECT			20. TOTAL % BOND				21. INSPECTOR/DATE								
ULTRASONIC EQUIPMENT AND INSPECTION DATA															
6. EQUIPMENT MANUFACTURER			7. MODEL NO.		8. SERIAL NO.		9. TRANSDUCER MANUF.			10. SIZE/FREQ		11. SERIAL NO.			
12. SCANNING METHOD <input type="checkbox"/> STATIC <input type="checkbox"/> CONTINUOUS			13. COUPLANT TYPE		14. CAL EXP DATE		15. JOINT ID NO.				16. DWG NO.				
17. REMARKS/NOTES															
18. LAND%	1	2	3	4	5	6	7	8	9	10	11	12	TOTAL	TOTAL BOND	
PIPE															
MIDDLE															
FITTING															
19. DISPOSITION <input type="checkbox"/> ACCEPT <input type="checkbox"/> REJECT			20. TOTAL % BOND				21. INSPECTOR/DATE								

- NOTES: 1. INCREMENTS FOR WHICH NO ULTRASONIC READING CAN BE OBTAINED WILL BE MARKED AS FOLLOWS:
 "X" - INCREMENTS THAT ARE INACCESSIBLE DUE TO FITTING CONFIGURATION.
 "NA" - INCREMENTS THAT ARE INACCESSIBLE DUE TO PIPING CONFIGURATION OR LOCATION.
 "NP" - INCREMENTS IN WHICH THERE IS NO ULTRASONIC PENETRATION.
2. INCREMENTS OF THE ABOVE TYPE WILL BE ASSIGNED PERCENT BOND VALUES AS FOLLOWS:
 "NA" = 0% BOND.
 "NP" AND "X" = INCREMENTS UP TO A TOTAL LENGTH NOT EXCEEDING 20% OF THE CIRCUMFERENCE OF THE
 LAND WILL BE ASSIGNED A % BOND VALUE EQUAL TO THAT OF THE LOWEST READABLE INCREMENTS ADJACENT
 TO THE "X" OR "NP" INCREMENTS OR 60% WHICHEVER IS THE LEAST. "X" AND "NP" INCREMENTS IN EXCESS OF
 20% OF CIRCUMFERENCE WILL BE ASSIGNED A BOND VALUE OF 0%. THE INSPECTOR MAY AT HIS/HER
 DISCRETION, SHIFT THE INCREMENTAL SCALE SO THAT THE MINIMUM NUMBER OF INCREMENTS CONTAIN "X",
 "NP" OR "NA" VALUES.

(This Page Intentionally Left Blank)

QA FORM 18A INSTRUCTIONS
ULTRASONIC INSPECTION RECORD

PURPOSE: To supplement the QA form 18 to document UT inspection date, equipment used, and acceptability of UT results.

PROCEDURE: QA form 18A will be completed by the planner and/or UT NDT Inspector. The numbered blocks on QA form 18A correspond with the instructions listed below.

BLOCK 1 - **PAGE OF**

Enter the page number, starting with page 2, of total number of QA forms 18A associated with the joint (e.g., 2 of 3, 3 of 3). The associated QA form 18 is always page 1 of ___.

BLOCK 2 - **SHIP HULL NO.**

Enter the tended ship's name and hull number.

BLOCK 3 - **JCN**

Enter the JCN.

BLOCK 4 - **LWC/SHOP**

Enter the LWC/Shop.

BLOCK 5 - **CWP/REC SERIAL NO.**

Enter the CWP/REC serial number or enter N/A if no CWP/REC is required. Do not list the CWP/REC revision.

BLOCKS 6-11 - **EQUIPMENT MANUFACTURER/MODEL NO./SERIAL NO./TRANSDUCER
MANUFACTURER/SIZE/FREQUENCY/SERIAL NO.**

Enter the information for the equipment used to conduct the inspection.

BLOCK 12 - **SCANNING METHOD**

Place an "X" in the appropriate box.

BLOCK 13 - **COUPLANT TYPE**

Enter the name of fluid used.

BLOCK 14 - **CAL EXP DATE**

Enter the calibration expiration date of the equipment listed in Blocks 6-11.

BLOCK 15 - **JOINT ID NO.**

Enter the JID of the joint being UT inspected. If it is a qualification joint and not an actual production joint, enter the individual's name performing the qualification.

BLOCK 16 - **DWG. NO.**

Enter the number of the drawing or plan that identifies the joint listed in Block 15 if a production braze.

BLOCK 17 - **REMARKS/NOTES**

Enter any applicable remarks or notes.

BLOCK 18 - **LAND/PIPE/MIDDLE/FITTING**

Enter the various segments of the lands, enter % bond, X, NA or NP as applicable. Enter the total for all segments used and the average percent bond for the lands (or passes of a no-insert fitting).

BLOCK 19 - **DISPOSITION**

Place an "X" in the appropriate box to accept or reject the joint.

BLOCK 20 - TOTAL % BOND

Calculate and enter the total % bond for the joint.

BLOCK 21 - INSPECTOR/DATE

NDT Inspector print name, enter signature and date, signifying the technical accuracy of the data recorded and acceptance/rejection of the joint.

WELDING IN PROCESS CONTROL/NONDESTRUCTIVE TEST RECORD
QA FORM 20 (FRONT)

When the form is used for production welding, the blocks marked with a ◆ shall be completed by the planner.

◆ 2. SHIP HULL NO.	◆ 3. JCN	◆ 4. CWP/REC SER. NO.		◆ 5. LWC	◆ 6. DATE
◆ 7. SYSTEM	◆ 8. COMPONENT	◆ 9. DWG NO.		◆ 10. CWP STEP NO.	
◆ 11. JOINT ID		◆ 12. JOINT DESIGN		13. INST LOCATION: <input type="checkbox"/> STBD COMPT: <input type="checkbox"/> C/L FR: <input type="checkbox"/> PORT	14. WELDED LOCATION: <input type="checkbox"/> SHOP <input type="checkbox"/> FIELD
BASE MATERIAL DATA					
15. COMP DATA	16. MATERIAL	17. SIZE	18. THICKNESS	19. MATL SPEC	20. MIC NO.
COMPONENT A:					
COMPONENT B:					
21. <input type="checkbox"/> SEAL RING <input type="checkbox"/> BACK RING/STRIP	22. MATERIAL	23. SIZE	24. THICKNESS	25. MATL SPEC	26. MIC NO.
WELDING MATERIAL SPECIFICATIONS AND DATA					
27. TYPE OF FILLER(S)	28. SIZE	29. MATL	30. MIL-SPEC	31. MIC NO.	
WELD HISTORY					
◆ 32. WELDING STANDARD:	33. WELDING PROCEDURE:	34. DATA SHEET	35. POSITION: <input type="checkbox"/> VERT <input type="checkbox"/> FLAT <input type="checkbox"/> FIXED <input type="checkbox"/> 45 DEG <input type="checkbox"/> HORZ <input type="checkbox"/> OVHD <input type="checkbox"/> ROLLED		
36. ACCESSIBILITY: <input type="checkbox"/> 12" OR LESS <input type="checkbox"/> UNRESTRICTED	37. PREHEAT TEMP	38. PREHEAT METHOD		39. POST HEAT. TEMP REQD:	START TIME: STOP TIME:
40. PURGE GAS:	41. FLOW RATE	42. SHIELD GAS	43. FLOW RATE	44. CUP SIZE	45. TUNGSTEN SIZE
46. WELD LAYER	47. PROCESS	48. QUAL EXP DATE	49. AMPS	50. INTERPASS TEMP	51. WELDER SIGNATURE
53. INSPECTION DATA CONTAINED ON REVERSE OF THIS PAGE REMARKS:					
94. FINAL DISPOSITION: <input type="checkbox"/> ACCEPT <input type="checkbox"/> REJECT		95. NDT SUPERVISOR			DATE

THE PERSON DESIGNATED TO SIGN FOR AN ACTION VERIFIES, BASED ON PERSONAL OBSERVATION OR CERTIFIED RECORDS, AND CERTIFIES BY HIS/HER SIGNATURE THAT THE ACTION HAS BEEN PERFORMED IN ACCORDANCE WITH THE SPECIFIED REQUIREMENTS.

**WELDING IN PROCESS CONTROL/NONDESTRUCTIVE TEST RECORD
QA FORM 20 (BACK)**

NDT INSPECTION DATA					
54. INSPECTION STANDARD		55. WELD CLASS	56. ACCEPTANCE STANDARD		57. ACCEPT CLASS
58. WELD PREP	59. INSP METHOD	60. ACCEPT/REJECT	61. NDT INSPECTOR SIGNATURE		62. DATE
COMPONENT A		[] ACCEPT [] REJECT			
COMPONENT B		[] ACCEPT [] REJECT			
63. JOINT FITUP		[] ACCEPT [] REJECT			
64. INSP LAYER	65. INSP METHOD	66. INSP PROC NO	67. ACCEPT/REJECT	68. NDT INSPECTOR SIGNATURE	69. DATE
			[] ACCEPT [] REJECT		
			[] ACCEPT [] REJECT		
			[] ACCEPT [] REJECT		
			[] ACCEPT [] REJECT		
			[] ACCEPT [] REJECT		
70. NDT INSPECTION DATA REPAIR NO. _____			Defect: L	W	D
71. Repair Method:			Excavation: L	W	D
72. INSP LAYER	73. INSP METHOD	74. INSP PROC NO.	75. ACCEPT/REJECT	76. NDT INSPECTOR SIGNATURE	77. DATE
			[] ACCEPT [] REJECT		
			[] ACCEPT [] REJECT		
78. NDT INSPECTION DATA REPAIR NO. _____			Defect: L	W	D
79. Repair Method:			Excavation: L	W	D
80. INSP LAYER	81. INSP METHOD	82. INSP PROC NO.	83. ACCEPT/REJECT	84. NDT INSPECTOR SIGNATURE	85. DATE
			[] ACCEPT [] REJECT		
			[] ACCEPT [] REJECT		
86. NDT INSPECTION DATA REPAIR NO. _____			Defect: L	W	D
87. Repair Method:			Excavation: L	W	D
88. INSP LAYER	89. INSP METHOD	90. INSP PROC NO.	91. ACCEPT/REJECT	92. NDT INSPECTOR SIGNATURE	93. DATE
			[] ACCEPT [] REJECT		
			[] ACCEPT [] REJECT		
53. REMARKS (Continued):					

THE PERSON DESIGNATED TO SIGN FOR AN ACTION VERIFIES, BASED ON PERSONAL OBSERVATION OR CERTIFIED RECORDS, AND CERTIFIES BY HIS/HER SIGNATURE THAT THE ACTION HAS BEEN PERFORMED IN ACCORDANCE WITH THE SPECIFIED REQUIREMENTS.

QA FORM 20 INSTRUCTIONSWELDING IN PROCESS CONTROL/NONDESTRUCTIVE TEST RECORD

PURPOSE: To document in process controls for welding and NDT of a completed weld.

PROCEDURE:

1. QA form 20 will be completed by the planner preparing the CWP, welder and NDT Inspector(s) observing or performing tests.
2. The numbered blocks on QA form 20 correspond to the instructions listed below. When the form is used for production welding, the blocks marked with a ♦ shall be completed by the planner.

BLOCK 1 - PAGE 1 OF

Enter the page number, starting with page 1, of total number of QA forms 20 and 20A, if used, associated with the joint (e.g., 1 of 3, 1 of 2).

BLOCK 2 - SHIP HULL NO.

Enter the ship's name and hull number.

BLOCK 3 - JCN

Enter the JCN.

BLOCK 4 - CWP/REC SER. NO.

Enter the CWP/REC Serial Number or enter N/A if no CWP/REC is required. Do not list the CWP/REC revision.

BLOCK 5 - LWC

Enter the shop number of the LWC.

BLOCK 6 - DATE

Enter the date this form is initiated.

BLOCK 7 - SYSTEM

Enter the noun name of the system.

BLOCK 8 - COMPONENT

Enter the noun name of component.

BLOCK 9 - DWG NO.

Enter the JID or mapping drawing, if applicable. If not applicable, the planner will enter the applicable arrangement drawing, system diagram, or component drawing number, or locally prepared JID sketch.

BLOCK 10 - CWP STEP NO.

Enter the appropriate step number(s) of the CWP.

BLOCK 11 - JOINT ID

Enter the JID from the joint identification or map plan if JID is unavailable, assign local JID. If for a qualification joint (and not production joint identification) enter individual name performing the qualification.

BLOCK 12 - JOINT DESIGN

Enter the joint design (e.g., P-73, PN-1A, P-14, PN-7) to be used.

BLOCK 13 - INST LOCATION

Enter the compartment, frame number, and check port, starboard, or centerline where the component is located.

BLOCK 14 - WELDED LOCATION

Check the appropriate block.

BLOCK 15 - COMPONENT A/B

Enter the component name (e.g., pipe, valve).

BLOCK 16 - MATERIAL

Enter the material type (e.g., CUNI, CRES).

BLOCK 17 - SIZE

Enter the iron pipe size/NPS.

BLOCK 18 - THICKNESS

For nuclear welds, enter the design material thickness. For non-nuclear welds, enter the nominal thickness or the actual measured thickness, if taken, for determining penetrameter selection for radiographed piping joints in accordance with NAVSEA T9074-AD-GIB-010/271, NAVSEA S9074-AR-GIB-010/278, and NAVSEA T9074-AD-GIB-010/1688 and for determining fillet legs on partial penetration welds in accordance with NAVSEA T9074-AD-GIB-010/271, NAVSEA T9074-AD-GIB-010/1688 and MIL-STD-1689 (for Surface Force Ships only).

BLOCK 19 - MATL SPEC

Enter the appropriate material specification for the material.

BLOCK 20 - MIC NO.

Enter the MIC number for component A and B, if applicable. Verify the MIC number from the QA form 2 for new material. For existing material, if the required MIC number is not readable enter "existing".

BLOCK 21 - [] SEAL RING [] BACK RING/STRIP

Check the appropriate block for the type of backing.

BLOCK 22 - MATERIAL

Enter the material type (e.g., CUNI, CRES).

BLOCK 23 - SIZE

Enter the ring size.

BLOCK 24 - THICKNESS

Enter the actual measured thickness of the ring or strip.

BLOCK 25 - MIL-SPEC

Enter the appropriate MIL-SPEC for the ring or strip.

BLOCK 26 - MIC NO.

Enter the MIC number of the ring or strip, if applicable. Verify the number from the QA form 2.

BLOCK 27 - TYPE OF FILLER(S)

Enter the type of the filler material(s) used (e.g., 9010, 11018, 304, RN62).

BLOCK 28 - SIZE

Enter the size rod, wire, insert, etc.

BLOCK 29 - MATL

Enter the material type (e.g., CUNI, CRES).

BLOCK 30 - **MIL-SPEC**

Enter the appropriate MIL-SPEC for the filler and insert (if applicable) material.

BLOCK 31 - **MIC NO.**

Enter the appropriate MIC number for the filler and insert (if applicable) material. Verify the number from the QA form 2.

BLOCK 32 - **WELDING STANDARD**

Enter the applicable welding standard.

BLOCK 33 - **WELDING PROCEDURE**

Enter the weld procedure number.

BLOCK 34 - **DATA SHEET**

Enter the weld procedure technique sheet number.

BLOCK 35 - **POSITION**

Check the appropriate block for the weld position.

BLOCK 36 - **ACCESSIBILITY**

Check the proper block for the actual accessibility.

BLOCK 37 - **PREHEAT TEMP**

Enter the actual preheat temperature as measured just prior to welding.

BLOCK 38 - **PRE-HEAT METHOD**

Enter the required pre-heat method.

BLOCK 39 - **POST HEAT TEMP START TIME AND STOP TIME**

Enter the temperature required for the post weld heat and the start and stop time for post heat.

BLOCK 40 - **PURGE GAS**

Enter the type of purge gas.

BLOCK 41 - **FLOW RATE**

Enter the actual flow rate of the purge gas.

BLOCK 42 - **SHIELD GAS**

Enter the type of shield gas.

BLOCK 43 - **FLOW RATE**

Enter the actual flow rate of the shield gas.

BLOCK 44 - **CUP SIZE**

Enter the gas cup size.

BLOCK 45 - **TUNGSTEN SIZE**

Enter the tungsten size.

BLOCK 46 - **WELD LAYER**

Enter the layer of welding (i.e., tacks, root, intermediate, and final).

BLOCK 47 - **PROCESS**

Enter the type of welding process used (e.g., SMAW, GTAW).

BLOCK 48 - QUAL EXP DATE

Enter qualification expiration date.

BLOCK 49 - AMPS

Enter the welding amperage actually used.

BLOCK 50 - INTERPASS TEMP

Enter the maximum interpass temperature as measured during the process.

BLOCK 51 - WELDER SIGNATURE

Print name and enter signature certifying the data recorded in Blocks 46-51 for the layer welded.

BLOCK 52 - DATE

Enter the date Block 51 is signed.

BLOCK 53 - REMARKS

Enter additional remarks or sketches. Enter the appropriate Test, Measuring and Diagnostic Equipment as defined in Part I, Chapter 5, paragraph 5.2.1 of this volume. If required, a continuation of Block 53 is on the back of the form at the bottom for additional information.

BLOCK 54 - INSPECTION STANDARD

Enter the applicable inspection standard.

BLOCK 55 - WELD CLASS

Enter class 1 or 2, per the requirements of NAVSEA 250-1500-1, for nuclear welds. The class (e.g., A-1, A-2, A-F, A-LT, M-1, P-1, PL-T, T-1) for non-nuclear welds.

BLOCK 56 - ACCEPTANCE STANDARD

Enter the applicable acceptance standard.

BLOCK 57 - ACCEPT CLASS

Enter acceptance class 1 or 2, per the requirements of NAVSEA 250-1500-1, for nuclear welds. The class (e.g., I, II, III) for non-nuclear welds.

BLOCK 58 - WELD PREP - COMPONENT A/B

Enter the component name (e.g., pipe, valve).

BLOCK 59 - INSPECTION METHOD

Enter the type and method of inspection performed (e.g., VT 5X, PT).

BLOCK 60 - ACCEPT/REJECT

Enter accept or reject to indicate disposition of the weld preps.

BLOCK 61 - NDT INSPECTOR SIGNATURE

NDT Inspector print name and enter signature certifying the disposition of the weld prep.

BLOCK 62 - DATE

Enter the date Block 61 is signed.

BLOCK 63 - JOINT FIT-UP

Enter results (i.e., inspection method, Accept/Reject, Inspector and date) of joint fit up inspections.

BLOCK 64 - INSP LAYER

Enter the weld layer inspected (i.e., tacks, root, intermediate, final, inside/backside, accessible/inaccessible).

BLOCK 65 - **INSP METHOD**

Enter the type and method of inspection performed (e.g., VT 5X, PT).

BLOCK 66 - **INSP PROC NO.**

Enter the inspection procedure number.

BLOCK 67 - **ACCEPT/REJECT**

Enter accept or reject to indicate disposition of the weld layer. If final disposition of the weld is rejectable, document reason(s) for rejection, description and location of the defect(s) in Block 53. Document the repair number, length, width and depth of the defect(s) in Block 70, 78, or 86, as applicable.

BLOCK 68 - **NDT INSPECTOR SIGNATURE**

NDT Inspector print name and enter signature certifying the disposition of the weld layer.

BLOCK 69 - **DATE**

Enter the date Block 68 is signed.

NOTE: IF REPAIRS ARE REQUIRED TO THE JOINT, RECORD THE INSPECTIONS IN BLOCKS 72 THROUGH 77, 80 THROUGH 85, AND 88 THROUGH 93 IN THE SAME MANNER AS BLOCKS 64 THROUGH 69. BLOCKS NOT COMPLETED WILL BE LEFT BLANK EXCEPT AS DIRECTED BELOW.

BLOCK 70 - **REPAIR NUMBER/L W D**

The NDT Inspector will enter the repair number, length, width and/or depth of the defect(s) if known. Enter N/A for length, width or depth if unknown based on the limitations of the inspection method performed.

BLOCK 71 - **REPAIR METHOD/L W D**

The welder will record the method of repair (e.g., file, excavate and weld, weld only). Document the length, width and depth of the excavation. If excavation was not required for weld repair, enter N/A for L W D.

BLOCK 78 - **REPAIR NUMBER/L W D**

The NDT Inspector will enter the repair number, length, width and/or depth of the defect(s) if known. Enter N/A for length, width or depth if unknown based on the limitations of the inspection method performed.

BLOCK 79 - **REPAIR METHOD/L W D**

The welder will record the method of repair (e.g., file, excavate and weld, weld only). Document the length, width and depth of the excavation. If excavation was not required for weld repair, enter N/A for L W D.

BLOCK 86 - **REPAIR NUMBER/L W D**

The NDT Inspector will enter the repair number, length, width and/or depth of the defect(s) if known. Enter N/A for length, width or depth if unknown based on the limitations of the inspection method performed.

BLOCK 87 - **REPAIR METHOD/L W D**

The welder will record the method of repair (e.g., file, excavate and weld, weld only). Document the length, width and depth of the excavation. If excavation was not required for weld repair, enter N/A for L W D.

BLOCK 94 - **FINAL DISPOSITION**

The NDT Inspector who completed the final inspection of the final weld will check acceptable or rejectable.

BLOCK 95 - **NDT SUPERVISOR SIGNATURE DATE**

NDT Supervisor print name, enter signature and date signifying all information in Blocks 1 through 93 is technically and administratively correct.

(This Page Intentionally Left Blank)

(This Page Intentionally Left Blank)

QA FORM 20A INSTRUCTIONSRADIOGRAPHIC TEST INSPECTION RECORD

PURPOSE: To provide a supplement to the QA form 20 to document the technical aspects of the radiograph and the acceptance or rejection of the item radiographed. Both the QA form 20 and QA form 20A are required for a complete radiographic record of a joint.

PROCEDURE: QA form 20A will be completed by the radiographer and the RT inspector. The numbered blocks on QA form 20A correspond with the instructions listed below.

BLOCK 1 - PAGE OF

Enter the page number, starting with page 2, of the total number of QA forms 20A associated with the joint (e.g., 2 of 3, 3 of 3). The associated QA form 20 is always page 1 of ____.

BLOCK 2 - SHIP AND HULL NO.

Enter the tended ship's name and hull number.

BLOCK 3 - JCN

Enter the JCN.

BLOCK 4 - CWP/REC SERIAL NO.

Enter the CWP/REC serial number or enter N/A if no CWP/REC is required. Do not list the CWP/REC revision.

BLOCK 5 - CWP STEP NO.

Enter the CWP step number(s).

BLOCK 6 - JOINT ID

Enter JID.

BLOCK 7 - REPAIR NO.

Enter ORIG or repair number (e.g., R-1, R-2).

BLOCK 8 - INSP STD & CLASS

Enter the inspection standard and class.

BLOCK 9 - QUALITY LEVEL

Enter the quality level required.

BLOCK 10 - RT COVERAGE REQ'D

Indicate the RT coverage required.

BLOCK 11 - PENETRAMETER

Record the penetrameter size and group. Indicate use of source or film side penetrameter.

BLOCK 12 - SPECIMEN MATL

Enter the material type of the item being radiographed (e.g., NICU, CFE).

BLOCK 13 - TM

Enter the nominal or actual, or design material thickness of the item being radiographed per NAVSEA 250-1500-1 or NAVSEA T9074-AS-GIB-010/271.

BLOCK 14 - TS

Enter the total specimen thickness.

BLOCK 15 - EXPOSURE TECH

Check the appropriate technique used (e.g., if a pipe was radiographed through two walls and the image of both walls are to be viewed for acceptance, enter an "X" in the brackets next to DWE/DWV).

BLOCK 16 - FILM

Enter the film type and brand. "X" the appropriate method used to load the film cassette.

BLOCK 17 - ISOTOPE

Record the listed information when using the source.

BLOCK 18 - X-RAY MACHINE MFG

Record the listed information when using the X-ray machine.

BLOCK 19 - X-RAY PARAMETERS

Record the listed information when using the X-ray machine.

BLOCK 20 - SFD

Enter the source to film distance used.

BLOCK 21 - RADIOGRAPHIC SHOOTING SKETCH

The radiographer will draw a sketch indicating the items listed.

BLOCK 22 - SHIM

Enter the shim material used and thickness.

BLOCK 23 - LEAD SCREENS THICKNESS

Record thickness, front and back of the intensifying screens.

BLOCK 24 - REMARKS

The radiographer will use this block to record any unusual technique requirements.

BLOCK 25 - RADIOGRAPHER

The radiographer will print name, sign and date upon verifying that all the information in Blocks 1 through 24 is correct.

BLOCKS 26 - RADIOGRAPHIC INTERPRETATION
thru 28

NOTE: BLOCK 26 WILL BE COMPLETED BY THE RT INSPECTOR AS THE FILM IS READ.

- a. One RT Inspector will evaluate the radiograph, check ACCEPT/REJECT as appropriate in Block 27, print name, enter signature and date in Block 28.
- b. It is important to note that all indications read must be recorded on the QA form 20A and dispositioned in the appropriate block.
- c. Additional sheets may be added to the report by the RT Inspector. The additional sheets will be properly numbered and will be authenticated with printed name and signature on each sheet by the RT Inspector making up the report.

BLOCK 29 - RT EXAMINER

The Command RT Examiner will review the weld record (including radiographic film) for completeness accuracy and compliance with applicable standards, print name, enter signature, unique identification number, and date.

QA FORM 20B (PART A) INSTRUCTIONSSTRUCTURAL PRIMARY RECORD

PURPOSE: To provide a standard form and instruction for documenting required structural welding and NDT completion data.

NOTES:

1. PLANNING AND ESTIMATING (P&E) SHALL COMPLETE BLOCKS 1-14, 20, 21, 22-24 (PARTIAL), AND 26 (IF NECESSARY) FOR SUBMARINE RECORDS. ANNOTATED PERSONNEL SHALL COMPLETE ALL REMAINING BLOCKS.
2. RECORD OF ACCOMPLISHMENT DEFINITION: A RECORD USED FOR SOME SUBMARINE WELDS THAT NAVSEA TECH PUB T9074-AD-GIB-010/1688 ALLOWS REDUCED NDT DATA REQUIREMENTS. IT IS PRIMARILY USED FOR MAGNETIC PARTICLE TESTING (MT) INSPECTION. MT INSPECTIONS THAT MAY USE A RECORD OF ACCOMPLISHMENT FOR COMPLETION DATA ARE DEFINED IN TABLES 6-1 AND 6-2 OF NAVSEA TECH PUB T9074-AD-GIB-010/1688, BY REFERENCE TO NOTE 8. NDT COMPLETION DATA FOR A RECORD OF ACCOMPLISHMENT IS DEFINED IN NAVSEA TECH PUB T9074-AD-GIB-010/1688, PARAGRAPH 5.3.1.
3. BLOCKS/ROWS OF THIS RECORD MAY BE EXPANDED OR DELETED TO SUIT THE WORK BEING DOCUMENTED.
4. EACH SIGNATURE WILL BE ACCOMPANIED BY A PRINTED NAME AND DATE. AN EMPLOYEE MAY USE THEIR INITIALS PROVIDED THEIR SIGNATURE AND PRINTED NAME APPEAR ELSEWHERE ON THE SAME PAGE.

SCOPE: The scope of this instruction is limited to structural welding and NDT for overhaul and repair governed by NAVSEA Tech Pub T9074-AD-GIB-010/1688, or MIL-STD-1689A as invoked by Naval Ships Tech Manual S9086-CH-STM-010/CH-074, through NAVSEA S9AA0-ABGOS-010/GSO, NAVSEA 0902-018-2010 or COMUSFLTFORCOMINST 4790.3 Joint Fleet Maintenance Manual.

BLOCK 1 - **RECORD NO.**

Enter the Part A record number. The numbering convention is A-01, A-02, A-03 etc., in numerical order, depending on how many Part A records are generated for the TWD. Keep the number of Primary Records generated to a minimum.

BLOCK 2 - **LWC/SHOP**

Enter local work center or lead shop.

BLOCK 3 - **SHEET**

(P&E/Craftsman/Inspector) Enter the sheet number of the Part A record or Part A continuation sheet. Total number of sheets generated (e.g., 2 of 3) will be added by the supervisor at time of signature in Block 27. It is pre-printed for the first sheet. All continuation sheet numbers must be added. Sheet numbers for Part A, B and C records are not associated. They are unique only to the record, Part A, B, or C that you are dealing with.

BLOCK 4 - **SHIP/HULL NO.**

Enter the ship name and/or hull type, SSN, SSBN/SSGN, CVN, etc., and unique hull number for the ship, 759, 732, or 65, etc.

BLOCK 5 - **JCN**

Enter the Job Control Number (JCN).

BLOCK 6 - **CWP/REC**

Enter the CWP/REC serial number or enter N/A if no CWP/REC is required. Do not list the CWP/REC revision.

BLOCK 7 - **REFERENCES**

Enter references, drawings etc. that are to be used to describe joints. Do not enter references that are associated only with joints that require a Part B record.

BLOCK 8 - **JOINT NUMBER**

Enter the Joint Numbers.

BLOCK 9 - **SS/SOC**

Check the block associated with each joint number if it is SUBSAFE or Scope Of Certification (SOC). All joints that involve the SUBSAFE boundary shall be checked whether they require re-entry control or not. For example, attachment welds to the boundary shall be checked even though this work is not subject to re-entry control. For surface ship welds, enter NA.

BLOCK 10 - **REC (SHIPYARD USE ONLY)**

Check the block associated with each joint number if the joint requires re-entry control.

BLOCK 11 - **COMPONENT NUMBER 1 (Leave blocks blank for joints that require a Part B Record.)**

Enter the letter associated with the drawing number in Block 7, which describes the component and enter the piece number (if necessary to describe the joint) for the component. For joints that may require explanation, enter "See remarks" as a reference in a Block 7, refer to this note as you would a drawing and give the explanation in remarks.

The term "EXISTING" may be used to describe existing ship structure, provided the other component in the joint defines the joint location. To do this, add "EXISTING" as a reference in Block 7, refer to it as you would a drawing, and "N/A" the piece number. Enter the base material type (OSS, HY-80, HSS, etc.), S-Group Number from Table 1 of NAVSEA S9074-AQ-GIB-010/248, and the drawing material thickness (decimal or fraction).

BLOCK 12 - **COMPONENT NUMBER 2**

Make entries for Component 2 as described in Block 11. For repair sites, enter N/A in Component 2 columns.

BLOCK 13 - **WELD INFO (Leave blocks blank for joints that require a Part B Record.)**

JOINT DESIGN: Enter the joint design in terms of MIL-STD-22 joint numbering system (PT2S.1, PT2V.1, C2V.2, B2V.3 etc.). Use Remarks (Block 14) to describe "Special Joints", as described in paragraph 11.4.7 of NAVSEA Tech Pub T9074-AD-GIB-010/1688 or paragraph 11.2.7 of MIL-STD-1689A, including any special weld buildup required for the joint.

WELD SIZE: Enter the weld size in terms of fractions. Enter N/A for butt welds, plug welds, base material repairs, weld surfacing, corner welds with no reinforcing fillet, clad welds, and edge welds. For PT2V.3 and PT2V.4, enter sizes for both reinforcing fillets. Use Remarks blocks for local joint clarification or joint or sketch numbers.

BLOCK 14 - **REMARKS**

Enter any joint clarifying comments. This block may also be used to specify any special heat restriction instructions (e.g., preheat and interpass requirements). Each entry shall contain signature, printed name and date except where the entry is pre-printed on the form by P&E.

NOTE: BLOCKS 15-18 ARE RESERVED FOR FUTURE USE.

BLOCK 19 - **NDT METHODS & ACCEPTANCE PROCEDURES/REV/CHG**

(INSPECTOR) Enter the NDT methods and acceptance standard procedure, revision, and change for NDT listed in Block 21 as the inspection is performed. This entry is not required for joints that do not list required NDT or that have Block 24 checked off. Leave unused blocks blank.

BLOCK 20 - **JOINT NO.**

(P&E) Repeat joint numbers listed in Block 8.

BLOCK 21 - **NDT OR DATA REQUIREMENT**

NOTE: LEAVE THIS BLOCK BLANK IF A PART B RECORD IS REQUIRED. IF A PART B RECORD IS NOT USED, ENTER REQUIRED NDT OR DATA REQUIREMENTS AS FOLLOWS:

- a. DATA REQUIREMENTS: List WELD COMPL (weld complete) as the first entry for each joint listed in Block 20 that does not require a Part B record.
- b. NDT REQUIREMENTS: List required NDT for the joint. List each required NDT as a separate line item in approximate order in which they will occur. Use the following convention: List NDT Type first (VT, 5X VT, MT, PT, ET, RT or UT), Wait Time second (8HR, 24HR, 7DAY, or AH (for after hydro) etc.), and Phase last (EXCAV, BACKGOUGE or FINAL). It is not necessary to give a wait time for ambient temperature NDT; it is assumed if not given. Typical examples are: MT EXCAV, MT BACKGOUGE, MT FINAL, ET FINAL, PT FINAL, RT 8HR FINAL, MT 24HR FINAL, MT 7DAY FINAL, MT AH FINAL, and VT FINAL.
- c. WORKMANSHIP AND VT SPECIAL REQUIREMENTS:
 - 1) Workmanship inspections are not normally listed as required NDT. Certification of satisfactory completion is made either by TWD signature when the joint does not require documentation using a Part A or Part B record, or by signature on the Part A or Part B record when the joint does require documentation.
 - 2) Joints that require VT only do not require a structural record. The VT is specified and certified by TWD. Certification of satisfactory VT completion for VT only welds can be made by a NDT inspector signature in the body of the TWD.

BLOCK 22 - **CERTIFICATION OF DATA ENTRY OR SAT NDT**

- a. (P&E) Enter "See Part B record" for joints that require a Part B record.
- b. (WELDER) Enter signature, printed name, and date beside each WELD COMPL data entry to certify that the weld is complete, and that fit-up and weld workmanship inspection requirements have been met. The weld is complete when all weld metal has been deposited, required weld soaks are completed, preheat is removed, weld has cooled to ambient temperature and the weld has been prepared to ensure the weld is ready for final NDT. When required, include the ambient temperature time in Block 23 as described in Block 23 instructions.
- c. (NDT INSPECTORS) Enter signature, printed name, and date for each NDT when the NDT is satisfactory. Except when a Part C record is required, this signature is made when the weld is complete and the NDT is satisfactory. Part C records are required only if local instructions require them or if the note "Initiate a Part C record if NDT fails" appears in Block 23. If a Part C record is required and the NDT you are performing rejects the weld, enter an X in Block 24 for the NDT that generated the reject and initiate a Part C record. Your signature in Block 22, in this case, indicates the NDT failed and a Part C record was generated. If indications are cleared by grinding/polishing only and the subsequent VT (final) is satisfactory, a Part C record is not required.

BLOCK 23 - **DATA ENTRY OR ADDITIONAL NDT REQMT**

- a. (P&E)
 - 1) Enter any NDT clarifying comments, (i.e., partial inspections and/or expansion requirements).
 - 2) Enter "AMB TIME:" for each WELD COMPL data requirement listed in Block 21.

NOTE: THE AMBIENT TIME IS ONLY REQUIRED IF SUBSEQUENT NDT HAS A WAIT TIME, SUCH AS A 24 HOUR MT.

- 3) Enter "PENETRANT:" for each PT requested in Block 21.
- 4) Enter "EQUIP No:" for each ET requested in Block 21.
- 5) For submarine envelope attachment weld MT inspections, enter "Initiate a Part C record if NDT fails" and "EQUIP No:".

- 6) For submarines, enter "Initiate a Part C record if NDT fails" for RT/UT listed in Block 21 (expansions are required when repair welding is required as a result of RT or UT inspection).
- b. (WELDERS) Enter military time when the weld reaches ambient temperature beside the "AMB TIME:" entry associated with each WELD COMPL data requirement. If this data is entered by someone other than who signed Block 22, a signature, printed name and date is required.

NOTE: THE AMBIENT TIME IS ONLY REQUIRED IF SUBSEQUENT NDT HAS A WAIT TIME, SUCH AS A 24 HOUR MT.

- c. (NDT INSPECTORS)
 - 1) Enter penetrant used, manufacturer's brand and type, beside each "PENETRANT:" entry.
 - 2) Enter equipment information as follows beside each MT or ET with "EQUIP No.:" entry:
 - (a) ET: Enter unique equipment identification, or instrument manufacturer and model number used.
 - (b) MT: If AC yoke is used enter the word "Yoke". Otherwise, enter unique equipment identification, or instrument manufacturer and model number used.

BLOCK 24 - **SUPPLEMENTAL RECORD (CHECK IF REQD)**

(NDT INSPECTORS) When required by local procedures to document deficiencies, or if the note "Initiate a Part C record if NDT fails" is listed in Block 23, a Part C record shall be initiated to document defects. If a part C record is initiated, check the box in the row associated with the required NDT.

BLOCK 25 - **RECORD NO. OF REPAIR CYCLES (SURFACE SHIPS ONLY)**

(INSPECTOR/WELDER) Enter the number of repair cycles required to obtain a satisfactory NDT, (i.e., "1" for the first cycle, "2" for the second, etc.).

BLOCK 26 - **REMARKS**

(ALL) Enter any clarifying comments associated with the record. Add or refer to any expansion requirements here or in Block 14. Each entry shall contain signature, printed name, and date except where the entry is pre-printed on the form by P&E.

BLOCK 27 - **SUPERVISOR**

(WELD SUPERVISOR) Certify final disposition of all welding and NDT for all joints listed in Block 20 (including continuation sheets) by entering signature, printed name, and date. This includes certification of any Part C records generated. Ensure that page numbering is correct.

BLOCK 28 - **QAS (SUBSAFE/SOC ONLY)**

(QAS) Enter signature, printed name, and date to certify completeness of entries. To aid the certification process, this block is repeated on the Part B record in Block 34. For joints being documented by Part B record, the individual signing for all joints shall review the certification signature(s) on the Part B record(s) and sign the Part A record based on the Part B signature(s).

STRUCTURAL PRIMARY RECORD CONTINUATION SHEET: Follow corresponding block instructions in this attachment.

STRUCTURAL WELD HISTORY
QA FORM 20B (PART B) (FRONT)

1. JOINT NO.				2. LWC/SHOP:		3. SHEET 1 OF				
4. SHIP HULL NO.			5. JCN			6. CWP/REC: <input type="checkbox"/> YES <input type="checkbox"/> NO				
7. REFERENCES										
A.		B.			C.					
JOINT IDENTIFICATION										
8. COMPONENT NUMBER 1				9. COMPONENT NUMBER 2				10. WELD INFO		
REF	PC NO.	MATL TYPE	MATL THICK	REF	PC NO.	MATL TYPE	MATL THICK	JOINT DESIGN	WELD SIZE	REMARKS
11. REMARKS										
12. NEW MATERIAL: MATL DOCUMENTATION REQUIRED <input type="checkbox"/> Y <input type="checkbox"/> N CRAFTSMAN/QAI: ENTER TRACEABLE MATERIAL MARKING (E.G., MIC NO., TCSM NO., HEAT NO., OR OTHER) FOR THE PIECE NUMBER (PC NO.) BELOW, UNLESS USE OF EXISTING MATERIAL IS SPECIFIED.										
REF	PC NO.	TRACEABLE MATL MARKING						CRAFTSMAN/QAI: MATERIAL VERIFICATION (SIGNATURE/DATE)		
WELD HISTORY										
13. WELD PROCEDURE, REV., CH. AND TECHNIQUE SHEETS:							14. MIN PREHEAT:		15. MAX INTERPASS:	
16. WELD FILLER MATERIAL (WELDER) ENTER TRACEABLE FILLER MARKING (MIC NO.)										
LETTER	GRADE/TYPE	MIC NO.			LETTER	GRADE/TYPE	MIC NO.			
A					C					
B					D					
17. FITUP SAT: CRAFTSMAN/QAI (SIGNATURE/DATE)										
18. PHASE LETTER KEY: F=BUILDUP OF BASE MATERIAL FOR FIT-UP; W=TACKING OR WELDING JOINT; BG=BACKGOUGE WORKMANSHIP SAT. (VERIFY BG NDT PRIOR TO WELD IF REQD)										
19. PHASE LETTER	20. FILLER LETTER	21. PREHEAT & INTERPASS TEMP			22. WELDER & WELD WORKMANSHIP (WELDER SIGNATURE/DATE)			23. REMARKS		
		<input type="checkbox"/> SAT								
		<input type="checkbox"/> SAT								
		<input type="checkbox"/> SAT								
		<input type="checkbox"/> SAT								
		<input type="checkbox"/> SAT								
		<input type="checkbox"/> SAT								
<input type="checkbox"/> SEE STRUCTURAL WELD HISTORY CONTINUATION SHEET										
24. WELDING COMPLETE				WELDER (SIGNATURE/DATE)						
25. JOINT IS AT AMBIENT TEMP				WELDER (SIGNATURE/DATE)				MILITARY TIME AT AMBIENT TEMP:		
26. JOINT IS COMPLETE AND READY FOR FIN AL NDT				CRAFTSMAN/CRAFTSMAN SUPERVISOR (SIGNATURE/DATE)						
REQUIRED NDT										
27. REQD NDT (TYPE, WAIT TIME, & PHASE)		28. NDT & ACCEPTANCE PROCEDURE, REV, CH			29. NDT RPT/EQPT (FOR ET OR MT, RECORD SERIAL # OF MANF & MODEL NO.) (FOR MT BY YOKE, ENTER "YOKE"). FOR PT, ENTER TYPE OF LIQUID PENETRANT, FOR RT/UT, ENTER REPORT #			30. RESULTS A OR R (NOTE 1)	31. INSPECTOR (SIGNATURE/DATE)	
MT EXCAV (NOTE 2)					ENTRY NOT REQUIRED					
MT BACKGOUGE (NOTE 2)					ENTRY NOT REQUIRED					
MT EVERY LAYER (NOTE 2&3)					ENTRY NOT REQUIRED					
VT FINAL					NA					
RT 8 HR FINAL										
UT 8 HR FINAL										
MT AMBIENT FINAL										

QA FORM 20B (PART B) (BACK)				
REQUIRED NDT (CONT.)				
27. REQD NDT (TYPE, WAIT TIME, & PHASE)	28. NDT & ACCEPTANCE PROCEDURE, REV, CH	29. NDT RPT/EQPT (FOR ET OR MT, RECORD SERIAL # OF MANF & MODEL NO.) (FOR MT BY YOKE, ENTER "YOKE"). FOR PT, ENTER TYPE OF LIQUID PENETRANT, FOR RT/UT, ENTER REPORT #	30. RESULTS A OR R (NOTE 1)	31. INSPECTOR (SIGNATURE/DATE)
MT 24 HR FINAL				
MT 7 DAY FINAL				
PT FINAL				
MTAH FINAL				
ET FINAL				
ETAH FINAL				
<p>NOTE 1: ANY WORK & FINAL NDT INSPECTIONS TO RESOLVE DOCUMENTED REJECTS ON THIS RECORD SHALL BE DOCUMENTED ON PART C RECORDS UNLESS NOTE 2 IS INVOKED IN BLOCK 27. DEFECTS REMOVED IN-PROCESS OF ANY VT, MT, OR PT DO NOT HAVE TO BE DOCUMENTED ON A PART C RECORD.</p> <p>NOTE 2: DEFECTS DO NOT HAVE TO BE DOCUMENTED. A PART C RECORD IS NOT REQUIRED. CERTIFY AFTER ALL DEFECTS ARE REPAIRED AND THE NDT IS SATISFACTORY.</p> <p>NOTE 3: MT EVERY LAYER SIGNIFIES MT INSPECTION AFTER DEPOSITION OF EACH LAYER, OR 3/8 INCH THICKNESS, WHICHEVER IS GREATER.</p>				
32. REMARKS				
FINAL DISPOSITION	33. WELD SUPERVISOR (SIGNATURE/DATE)		34. (SUBSAFE/SOC/REC ONLY) QAS: (SIGNATURE/DATE)	

(This Page Intentionally Left Blank)

QA FORM 20B (PART B) INSTRUCTIONSSTRUCTURAL WELD HISTORY

NOTE: P&E PERSONNEL SHALL COMPLETE BLOCKS 1, 2, 4, 5, 7-11, 12 (PARTIAL), 14-15 (IN SPECIAL SITUATIONS), 27, AND 32 (IF NECESSARY). ANNOTATED PERSONNEL SHALL COMPLETE ALL REMAINING BLOCKS. FOR CONTINUATION SHEETS GENERATED DURING PLANNING, P&E SHALL COMPLETE BLOCKS 1, 4, 5 AND 32 (IF NECESSARY). ANNOTATED PERSONNEL SHALL COMPLETE ALL REMAINING BLOCKS. FOR CONTINUATION SHEETS GENERATED DURING EXECUTION, ANNOTATED PERSONNEL SHALL COMPLETE ALL BLOCKS.

NOTE: BLOCKS/ROWS OF THIS RECORD MAY BE EXPANDED OR DELETED TO SUIT THE WORK BEING DOCUMENTED.

BLOCK 1 - JOINT NO.

Enter Joint Number. If the Part B record is referenced from a Part A record, the joint number on both records must match.

BLOCK 2 - LWC/SHOP

Enter lead work center.

BLOCK 3 - SHEET

(CRAFTSMAN/INSPECTOR/P&E) Enter the sheet number(s) of Part B continuation sheets generated. Inspector/Craftsman enter total number of sheets generated, (e.g., 1 of 3, 2 of 3 at the time of completion). (The first sheet, the Part B record, is pre-printed as "Sheet 1 of "). Sheet numbers for Part A, B and C records are not associated. They are unique only to the record, Part A, B, or C, that you are dealing with.

BLOCK 4 - SHIP/HULL NO.

Enter the ship name and/or hull type, SSN, SSBN/SSGN, CVN, etc., and unique hull number for the ship, 759, 732, or 65, etc.

BLOCK 5 - JCN

Enter the Job Control Number (JCN).

BLOCK 6 - CWP/REC

Check the [] Y box if CWP or REC is required, and enter CWP or REC number. Check the [] N box if a CWP or REC is not required.

BLOCK 7 - REFERENCES

Enter references, drawings etc. that are to be used to describe joints or material requiring traceability.

BLOCK 8 - COMPONENT NUMBER 1

Enter the letter associated with the drawing number in Block 7, which describes the component and enter the piece number (if necessary to describe the joint) for the component. For joints that may require explanation, enter "See remarks" as a reference in Block 7, refer to this note as you would a drawing and give the explanation in remarks. When piece number, material type, or material thickness is provided in Remarks, these columns should be left blank, or a dash entered.

The term "EXISTING" may be used to describe existing ship structure, provided the application is not SUBSAFE/SOC, and provided the other component in the joint defines the joint location. To do this, add "EXISTING" as a reference in Block 7, refer to it as you would a drawing, and "N/A" the piece number.

Enter the base material type (OSS, HY-80, HSS, etc.), S-Group Number from Table I of NAVSEA S9074-AQ-GIB-010/248 and the component thickness (decimal or fraction). If a component has more than one thickness or material type, enter each one on a separate row, or use Block 11 (Remarks).

BLOCK 9 - COMPONENT NUMBER 2

Make entries for Component 2 as described in Block 8. For repair sites, enter N/A in Component 2 columns.

BLOCK 10 - WELD INFO

Enter the joint design in terms of MIL-STD-22 joint numbering system (PT2S.1, PT2V.1, C2V.2, B2V.3, etc.). Use Remarks (Block 11) to describe "Special Joints", as described in paragraph 11.4.7 of NAVSEA Tech Pub T9074-AD-GIB-010/1688, including any special weld buildup required for the joint. For base material repairs and weld surfacing, enter N/A, or describe the repair or surfacing in Remarks (Block 11).

Enter the weld size in terms of fractions. Enter N/A for butt welds, plug welds, corner welds with no reinforcing fillet, weld surfacing, base material repairs, and edge welds. For PT2V.3 and PT2V.4, enter sizes for both reinforcing fillets. Use Remarks for local joint clarification or joint numbers.

BLOCK 11 - REMARKS

Enter any joint clarifying comments. Add or refer to any expansion requirements here or in Block 32. Each entry shall contain signature, printed name and date except where the entry is pre-printed on the form by P&E.

BLOCK 12 - NEW MATERIAL

- a. (P&E) Check the box "[] Y or [] N", to indicate that material documentation is or is not required and enter reference letter from Block 7 and the associated piece number to describe the material requiring traceability. Block 12 is marked "No" when electrode only is installed (e.g., repair of a pit, or for cladding) because electrode is entered in Block 16.
- b. (CRAFTSMAN/QAI) At the time of installation, enter traceable material marking (e.g., MIC No., TSCM No., Heat No., or other) for the piece number listed and certify (signature, printed name, and date). If existing material is being reinstalled, enter "EXISTING" in the TRACEABLE MATERIAL-MARKING column and sign. If "No" is Checked by P&E, no entry is required.

BLOCK 13 - WELD PROCEDURE, REV, CH, AND TECHNIQUE SHEET(S)

(WELDER) Before welding, enter the Weld Procedure to be used. Include Technique Sheet if applicable.

BLOCK 14 - MINIMUM PREHEAT

(WELDER) Before welding, enter the required minimum preheat. In certain situations, when heat must be controlled using non-standard temperatures, P&E may complete this block.

BLOCK 15 - MAXIMUM INTERPASS

(WELDER) Before Welding, enter the required maximum interpass temperature. In certain situations, when heat must be controlled, P&E may complete this block.

BLOCK 16 - WELD FILLER MATERIAL

(WELDER) Just prior to welding, enter grade/type (e.g., MIL-11018-M or 11018-M) and MIC Number (e.g., WCAF 9093 202A) of electrode used. Filler letters, A, B, C, etc., are provided so that the data needs only to be entered once for that electrode and its corresponding traceability number. Enter the filler letter, A, B, C, etc., corresponding to the electrode used during the weld process in the FILLER LTR block, Block 20. The filler material information recorded in this block only applies to weld phases being documented on this sheet. If a continuation sheet is used, the filler material used to document welding on that continuation sheet shall be recorded in Block 16 of that sheet.

BLOCK 17 - FITUP SAT

(CRAFTSMAN/QAI) Enter signature, printed name, and date when the workmanship inspection for fit-up or base material preparation for weld surfacing/repair is satisfactory. This signature certifies that the joint or base metal surface is ready for welding. For weld repairs, the signature certifies the excavation is ready for NDT (if required).

BLOCK 18 - PHASE LETTER KEY

No entry is required for this block. Use Phase Letter Key given to complete Block 19.

BLOCK 19 - **PHASE LETTER**

(WELDER) Using the Phase Letter Key given, enter the phase being accomplished during the weld process in the PHASE LETTER blocks provided. Check the box, “[] (See Structural Weld History Continuation Sheet)” when the record has insufficient room for the number of entries, and a continuation sheet is needed.

BLOCK 20 - **FILLER LETTER**

(WELDER) Enter the letter corresponding to the filler material information entered in Block 16 of the sheet you are completing. If the phase does not involve the addition of filler metal, enter N/A.

BLOCK 21 - **PREHEAT & INTERPASS TEMP**

(WELDER) Check Preheat and Interpass Temperature for the phase being accomplished. Mark the block when satisfactory. Take corrective action if it is not satisfactory. Enter “NA” for phases that do not involve welding, (e.g., backgouge phases).

BLOCK 22 - **WELDER AND WELD WORKMANSHIP**

(WELDER) Enter signature, printed name, and date for the associated phase. Signing of this block certifies that all welding has been performed in accordance with the welding procedure entered in Block 13; the MIC number of welding rod(s) used is recorded in Block 16; Blocks 19, 20, and 21 are completed and required information is correct and that all weld workmanship inspection requirements have been satisfied. For backgouge phase, the signature certifies that the weld has been backgouged and the root meets the workmanship requirements. Block 22 signatures shall be made based on personal observation.

BLOCK 23 - **REMARKS**

(WELDER) Enter remarks if necessary. If the remark is made by someone other than the welder who signed Block 22, entry shall contain signature, printed name, and date except where the entry is pre-printed on the form by P&E.

BLOCK 24 - **WELDING COMPLETE**

(WELDER/WELDER SUPERVISOR) Enter signature, printed name, and date when welding is complete, all metal has been deposited, required weld soaks are completed, preheat is removed and weld meets workmanship inspection requirements. This signature shall be made based on personal observation or by normal trade supervisory controls.

BLOCK 25 - **JOINT IS AT AMBIENT TEMP**

(WELDER OR WELDER SUPERVISOR) Enter military time weld reached ambient temperature and sign name (include name and date). NOTE: The ambient time is only required if subsequent NDT has a wait time, such as a 24 hour MT.

BLOCK 26 - **JOINT IS COMPLETE AND READY FOR FINAL NDT**

(CRAFTSMAN) Enter signature, printed name, and date when the joint is complete and ready for final NDT (i.e., meets workmanship inspection requirements).

BLOCK 27 - **REQUIRED NDT**

(P&E) Choose the required NDT from the menu given or add NDT if necessary. The NDT menu given lists most NDT required by NAVSEA Tech Pub T9074-AD-GIB-010/1688. Choose the NDT you desire by deleting the rows from the form for NDT that is not required. Include the Notes block at the bottom of the menu. After deleting NDT that is not required, ensure that the required NDT list will fit on a single page. If “MT EXCAV”, “MT BACKGOUGE”, and “MT EVERY LAYER” are not used, delete Note 2 from the note block. If “MT EVERY LAYER” is not used, delete Note 3 from the Note block.

BLOCK 28 - **NDT & ACCEPTANCE PROCEDURE REV, CH**

(INSPECTOR) Enter the NDT methods and acceptance standard procedure used.

BLOCK 29 - **NDT REPORT, EQUIPMENT**

(INSPECTOR) Enter NDT Report number or equipment used as directed on the form. Enter "Yoke" when performing an MT by yoke method. Equipment information is not required for MT by yoke. If "MT EXCAV", "MT BACKGOUGE" or "MT EVERY LAYER" is the NDT listed in Block 27, "Entry Not Required" may be entered in Block 29. (See example of Part B form).

BLOCK 30 - **RESULTS A OR R**

(INSPECTOR) Enter "A" for accept or "R" for reject to indicate the inspection result. If indications are cleared by grinding/polishing only, and the subsequent VT (final) is satisfactory, a Part C record is not required.

BLOCK 31 - **INSPECTOR**

(INSPECTOR) Enter signature, printed name, and date for the inspections performed. When a NDT results in a deficiency, the results of any other NDT not performed yet in the process will be documented on the Part C record generated for the failed NDT. All blocks for NDT not yet performed will be left blank on this sheet.

BLOCK 32 - **REMARKS**

(ALL) Enter remarks. Add or refer to any expansion requirements here or in Block 11. Each entry shall contain signature, printed name, and date except where the entry is pre-printed on the form by P&E.

BLOCK 33 - **WELD SUPERVISOR**

(WELD SUPERVISOR) Certify final disposition of all welding and NDT for the joint listed in Block 1 by entering signature, printed name and date.

NOTE: WHEN PERFORMING RECORD REVIEW, ALL CERTIFICATION DATA TO REPAIR DEFECTS (I.E., DEFECT EXCAVATION INFORMATION, REPAIR WELD HISTORY, FINAL NDT OF DEFECTS AND CERTIFICATION SIGNATURES, ETC.) ARE DOCUMENTED ON ASSOCIATED PART C RECORDS FOR THE JOINT AND PAGE NUMBERING IS CORRECT, INCLUDING ANY PART C RECORDS.

BLOCK 34 - **QAS (SUBSAFE/SOC/REC ONLY)**

(QAS) Enter signature, printed name, and date to certify completeness of entries for joints listed in Block 1.

STRUCTURAL WELD HISTORY CONTINUATION SHEET:

Follow corresponding block instructions in this attachment except as noted below:

(WELDER) Transcribe entries from the associated Part B record (sheet 1) onto the continuation sheet for Blocks 1, 4, 5 and 6.

BLOCK 13 - **WELD PROCEDURE, REV, CH, AND TECHNIQUE SHEET(S)**

(WELDER) Check the box provided if the weld procedure and technique sheet (if applicable) used for the Block 19 phase(s) is the same as shown on the associated Part B record (sheet 1). Otherwise, enter the weld procedure and technique sheet (if applicable) used for the Block 19 phase(s) that you are documenting on the continuation sheet.

STRUCTURAL DEFECT RECORD
QA FORM 20B (PART C)

3. SHIP HULL NO.			4. JCN		1. JOINT NO.		2. SHEET OF	
5. CWP/REC: <input type="checkbox"/> YES <input type="checkbox"/> NO								
6. METHOD OF REJECTED INSPECTION: <input type="checkbox"/> PT <input type="checkbox"/> MT <input type="checkbox"/> UT <input type="checkbox"/> VT <input type="checkbox"/> RT <input type="checkbox"/> OTHER (SPECIFY):								
7. DESCRIPTION OF DEFICIENCY (NUMBER EACH DEFICIENCY WITH AN INDICATION NUMBER):								
<input type="checkbox"/> SEE REPORT NO.								
8. ALL AREAS REQUIRING INSPECTIONS ARE SATISFACTORY EXCEPT AS NOTED IN BLOCK 7								
REPAIR								
9. NDT EQUIPMENT (FOR ET OR MT, RECORD SERIAL # OR MANF & MODEL NO.) (FOR MT BY YOKE, ENTER "YOKE", FOR PT, ENTER TYPE OF LIQUID PENETRANT).								
A:			B:			C:		
10. IND NO.	11. DEFECT REMOVAL (SIGNATURE/DATE)	12. NDT	13. NDT EQUIP LTR	14. REASON FOR REJECT OR EXCAVATION (LENGTH, WIDTH, DEPTH)	15. FINAL NDT FOR DEFECT REMOVAL. ENTER "A", "R" OR "W". SEE BLOCK INSTRUCTIONS.			
					SIGNATURE/DATE			
<input type="checkbox"/> (SEE ADDITIONAL STRUCTURAL DEFECT RECORD)								
WELD HISTORY								
16. WELD PROCEDURE, REV., CH, AND TECHNIQUE SHEETS: <input type="checkbox"/> SAME AS ORIGINAL						17. MIN PREHEAT:		18. MAX INTERPASS:
19. WELD FILLER MATERIAL (WELDER) ENTER TRACEABLE FILLER MARKING (MIC NO.)								
LETTER	GRADE/TYPE	MIC NO.			LETTER	GRADE/TYPE	MIC NO.	
A					C			
B					D			
20. PHASE LETTER KEY: F=BUILDUP OF BASE MATERIAL FOR FIT-UP; W=TACKING OR WELDING JOINT; BG=BACKGOUGE WORKMANSHIP SAT. (VERIFY BG NDT PRIOR TO WELD IF REQD)								
21. IND NO.	22. PHASE LETTER	23. FILLER LETTER	24. PREHEAT & INTERPASS TEMP	25. WELDER (SIGNATURE/DATE)		26. REMARKS		
			<input type="checkbox"/> SAT					
			<input type="checkbox"/> SAT					
			<input type="checkbox"/> SAT					
			<input type="checkbox"/> SAT					
			<input type="checkbox"/> SAT					
			<input type="checkbox"/> SAT					
<input type="checkbox"/> (SEE ADDITIONAL STRUCTURAL DEFECT RECORD)								
27. IND NO(S).		28. COMPLETE & READY FOR NDT - CRAFTSMAN (SIGNATURE/DATE)			27. IND NO(S).		28. COMPLETE & READY FOR NDT - CRAFTSMAN (SIGNATURE/DATE)	
REQUIRED NDT								
29. IND NO.	30. REQD NDT (TYPE & METHOD)	31. NDT & ACCEPTANCE PROCEDURE, REV, CH	32. NDT RPT/EQPT (FOR ET OR MT, RECORD SERIAL # OF MANF & MODEL NO.) (FOR MT BY YOKE, ENTER "YOKE"). FOR PT, ENTER TYPE OF LIQUID PENETRANT, FOR RT/UT, ENTER REPORT #		33. RESULTS A OR R	34. INSPECTOR (SIGNATURE/DATE)		
<input type="checkbox"/> (SEE ADDITIONAL STRUCTURAL DEFECT RECORD)								
35. REMARKS								

(This Page Intentionally Left Blank)

QA-20B PART C FLOWCHART

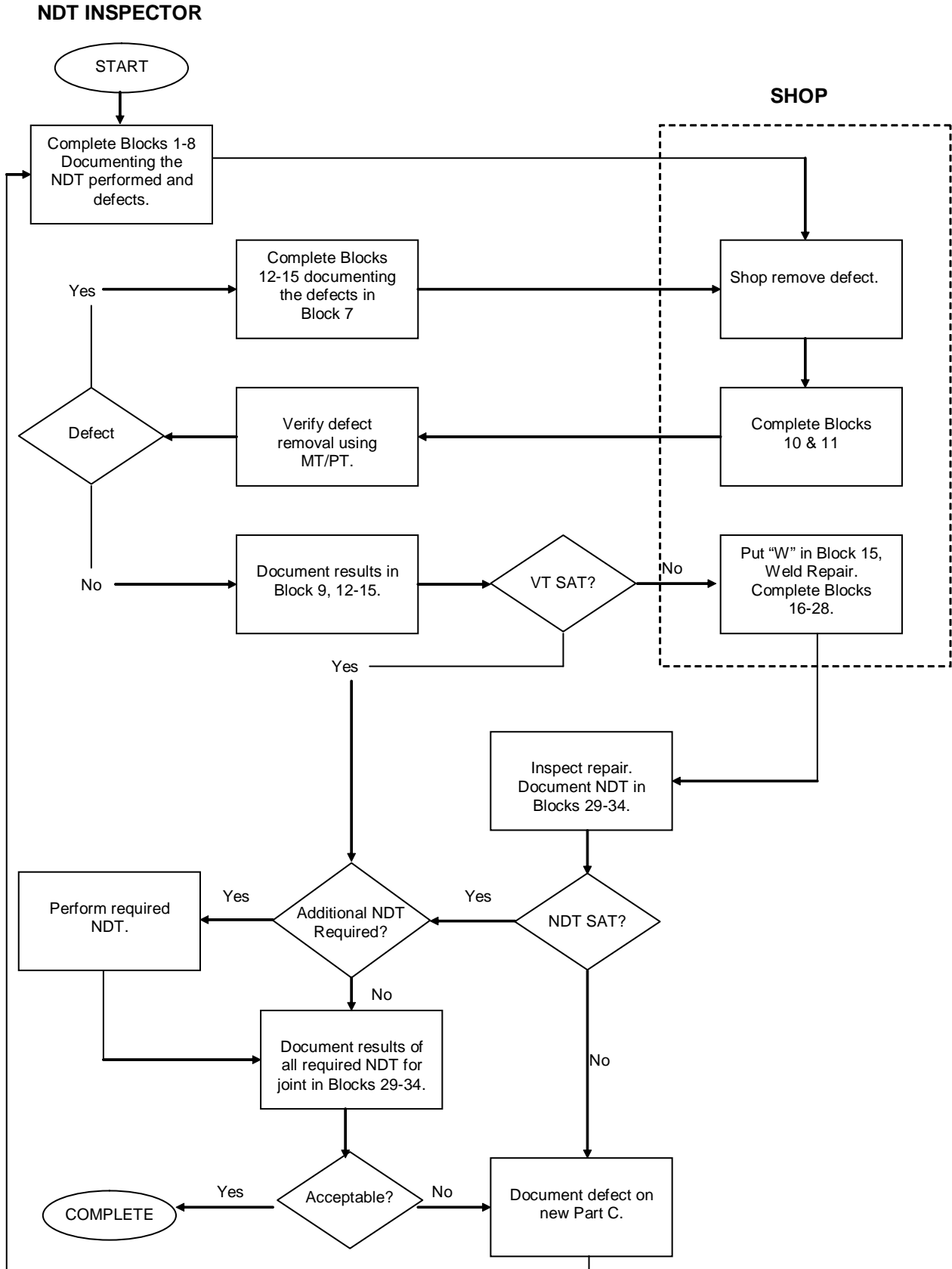

(This Page Intentionally Left Blank)

QA FORM 20B (PART C) INSTRUCTIONSSTRUCTURAL DEFECT RECORD

PURPOSE: To document defect completion data noted by failed NDT associated with a QA Form 20B Part A, Part B, or (if continued repair cycles are necessary) other Part C records. This form is only required for defects on the skin of the ship.

PROCEDURE: The numbered blocks on the QA Form correspond with instructions listed below. The P&E organization shall complete Blocks 17, 18 (in special situations) and 35 (if necessary). The blocks/rows of this record may be expanded to suit the work being documented. Unused rows for multiple entries (i.e., Blocks 10-15) may be deleted as necessary such that the form fits on a single page. If unable to keep on a single page a continuation sheet shall be used.

NOTE: EACH SIGNATURE WILL BE ACCOMPANIED BY A PRINTED NAME AND DATE. AN EMPLOYEE'S INITIALS MAY BE USED PROVIDED THEIR SIGNATURE AND PRINTED NAME APPEAR ELSEWHERE ON THE SAME PAGE.

NOTE: BLOCKS 1 - 10 WILL BE FILLED IN BY THE NDT INSPECTOR.

BLOCK 1 - **JOINT NO.**

Enter Joint Number.

BLOCK 2 - **SHEET**

Enter the sheet number of Part C record and additional Part C records generated and total number of sheets generated, (e.g., 1 of 2) at the time of completion. Sheet numbers for Part A, B and C records are not associated. They are unique only to the record, Part A, B, or C, that you are dealing with.

BLOCK 3 - **SHIP/HULL NO.**

Enter the ship name and hull number.

BLOCK 4 - **JCN**

Enter the Job Control Number (JCN).

BLOCK 5 - **CWP/REC NO.**

Check the [] N box if a CWP or REC is not required. Check the [] Y box if CWP or REC is required, and enter CWP or REC number. This information can be obtained from the associated Part A or B record.

BLOCK 6 - **METHOD OF REJECTED INSPECTION**

Check the box or indicate what NDT method has rejected.

BLOCK 7 - **DESCRIPTION OF DEFICIENCY**

Sketch, describe, or reference supporting documents to show defects. Label defects with an indication number. The numbering scheme must be consistent throughout the record.

BLOCK 8 - **INSPECTOR**

The inspector that rejected the NDT shall sign name and date for the NDT with exceptions for defects noted. (Signature certifies that all areas requiring inspection are satisfactory, except as noted in Block 7). If associated records are used to document acceptance, refer to the applicable records (e.g., RT, UT records).

BLOCK 9 - **NDT EQPT**

Enter equipment number or "YOKE" when MT is performed by Yoke method, or PT penetrant as directed on the form. The letters are to be annotated in Block 13 to correlate the equipment used with the NDT being performed. Check the box "[] (SEE ADDITIONAL STRUCTURAL DEFECT RECORD)" in the REPAIR section of the form when Block 10 has insufficient rows for the required number of entries.

BLOCK 10 - **IND NO.**

For each NDT performed on the repair excavation, list the indication number associated with the NDT being performed.

BLOCK 11 - **DEFECT REMOVAL**

(CRAFTSMAN) Enter signature and date for defect removal certifying the defect has been removed and the site is ready for VT and other NDT to verify defect removal.

NOTE: THE PURPOSE OF BLOCKS 12-15 IS TO DOCUMENT THE STEPS TAKEN TO EITHER BRING THE DEFECT TO THE POINT OF BEING CLEARED WITH NO ADDITIONAL ACTION OR TO THE POINT THAT REQUIRES WELD REPAIR.

BLOCK 12 - **NDT**

(INSPECTOR) Enter the NDT performed on the excavation site using one line per NDT entry. This shall include all VT and other NDT performed to verify defect removal. Unless otherwise directed by TWD or DL, NDT of the excavation site to verify defect removal shall be as follows:

- a. For defects discovered by VT, MT or PT, defect removal shall be verified by the NDT method (VT, MT or PT) that discovered the defect. All original required NDT must be accomplished and meet requirements to certify the weld.
- b. For defects discovered by ET, RT, or UT, defect removal shall be verified by MT (Ferrous) or PT (Non-Ferrous). All original required NDT must be accomplished and meet requirements to certify the weld.

NOTE: THE MT OR PT PROVES SOUND METAL AFTER THE DEFECT IS REMOVED. ACTUAL DEFECT REMOVAL IS VERIFIED BY THE VOLUMETRIC INSPECTION THAT FOUND THE DEFECT (AFTER WELD REPAIR).

BLOCK 13 - **NDT EQUIP LTR**

(INSPECTOR) Enter the letter from Block 9 that corresponds to the equipment or penetrant used in the inspection. Enter N/A if not applicable.

BLOCK 14 - **REASON FOR REJECT OR EXCAVATION**

(INSPECTOR) If the inspection fails, indicate reason for failure (e.g., type, dimensions and location of indication). If it is a VT failure indicate length, width, and depth of excavation. To show locations, modify sketch/description in Block 7 if possible. Such modifications shall contain signature, printed name, and date.

BLOCK 15 - **FINAL NDT FOR DEFECT REMOVAL**

(INSPECTOR) Enter "A", "R", or "W" to indicate results of inspection and enter signature and date. "A" means the inspection is acceptable. "R" means reject, (i.e., defect is not removed). "W", which is entered by the VT inspector and means weld repair is required, (i.e., defect is removed but the weld does not meet criteria for completed weld). Check the box "[] (SEE ADDITIONAL STRUCTURAL DEFECT RECORD)" in the REPAIR section of the form when Block 10 has insufficient rows for the required number of entries.

BLOCK 16 - **WELD PROCEDURE, REV, CH, & TECHNIQUE SHEET(S)**

(WELDER) Check the box provided if Weld Procedure and Technique Sheet (if applicable) to be used for repair welding is the same as shown on the associated Part B record. Otherwise, before welding enter the Weld Procedure (including Revision and Change used for repair welding). Include Technique Sheet if applicable.

BLOCK 17 - **MINIMUM PREHEAT**

(WELDER) First, see Part A (Block 14) or B record (Block 14), to verify that no special heat restrictions apply. If no special restrictions apply, before welding enter the required minimum preheat temperature. If special heat restrictions apply, before welding, enter the preheat temperature applied as specified by the Part A or Part B record.

BLOCK 18 - **MAXIMUM INTERPASS**

(WELDER) First, see Part A (Block 14) Part B record, (Block 15), to verify that no special heat restrictions apply. If no special restrictions apply, before welding, enter the required maximum interpass temperature. If special heat restrictions apply, before welding, enter the interpass temperature applied as specified by the Part A or Part B record.

BLOCK 19 - **WELD FILLER MATERIAL**

(WELDER) Just prior to welding, enter grade/type (e.g., MIL-11018-M or 11018-M) and MIC Number (e.g., WCAF 9093 202A) of electrode used in repair welding. Filler letters A and B are provided so that the data needs only to be entered once for that electrode and its corresponding traceability number. Enter the filler letter, A or B, corresponding to the electrode used during the weld repair process in Block 23. The filler material recorded here is only applicable to this sheet. If an additional Part C sheet is used, the filler material used to document weld phases on that sheet is recorded in Block 19 of that sheet.

BLOCK 20 - **PHASE LETTER KEY**

No entry is required for this block. Use Phase Letter Key given to complete Block 22. NOTE: Check the box “[] (SEE ADDITIONAL STRUCTURAL DEFECT RECORD)” in the REPAIR section of the form when Block 21 or 22 has insufficient rows for the required number of entries.

BLOCK 21 - **IND NO.**

(WELDER) Enter the indication number(s) for the defect(s) that is/are being worked on.

BLOCK 22 - **PHASE LETTER**

(WELDER) Using the Phase Letter Key given, enter the phase being accomplished during the weld repair process in the PHASE LETTER blocks provided. For most repairs, the last entries for each indication must be “WC” (weld complete) and “AMB” (ambient temperature). Multiple phases may be accomplished and certified as one line item entry (e.g., “WC/AMB”).

BLOCK 23 - **FILLER LTR**

(WELDER) Enter the letter corresponding to the filler material information entered in Block 19 of this sheet. If the phase does not involve the addition of filler material, enter NA.

BLOCK 24 - **PREHEAT & INTERPASS TEMP**

(WELDER) Check Preheat and Interpass Temperature for the phase being accomplished. Mark the block when satisfactory. Take corrective action if it is not satisfactory. Enter NA for phases that do not involve welding (e.g., WC and AMB).

BLOCK 25 - **WELDER**

(WELDER/WELDER SUPERVISOR) Enter signature, printed name, and date for the associated phase. Signing of this block certifies that all welding has been performed in accordance with the applicable welding procedure entered in Block 16, the traceability number of the filler material used is recorded in Block 19, Blocks 21 through 24 are completed and required information is correct, and that all weld workmanship inspection requirements have been satisfied. This signature shall be made based on personal observation. For Phase Welding Complete (WC), signature indicates welding is complete, all metal has been deposited, required weld soaks are completed, preheat is removed and weld meets workmanship inspection requirements. This signature shall be made based on personal observation or by normal trade supervisory controls. For Phase “AMB” enter military time that the weld reached ambient temperature (less than 125 Deg. F) in Block 26 and sign Block 25.

NOTE: THE AMBIENT TIME IS ONLY REQUIRED IF SUBSEQUENT NDT HAS A WAIT TIME, SUCH AS A 24 HOUR MT.

BLOCK 26 - **REMARKS**

(WELDER) Enter remarks if necessary. Ensure ambient temperature time is noted for the ambient temperature (AMB) phase after reaching ambient temperature (See note in Block 25 above). Each entry shall contain signature, printed name and date except (1), where the entry is pre-printed on the form by P&E, or (2) for ambient temperature time if "AMB" is listed in Block 22. These signature requirements are not necessary if the Block 26 entry is made by the welder who has signed for the acceptance requirements in Block 25.

BLOCK 27 - **IND NO(S).**

(CRAFTSMAN/SUPERVISOR) Enter indication numbers that you are certifying ready for NDT in Block 28. The block is large enough to enter several indication numbers. Two blocks are provided if different craftsmen are signing for different indications. Unused blocks may be left blank.

BLOCK 28 - **COMPLETE & READY FOR NDT**

(WELDER, WELDER SUPERVISOR or CRAFTSMAN) Enter signature, printed name, and date when the weld is ready for final NDT (i.e., meets workmanship inspection requirements). This signature shall be made based on personal observation or by normal trade supervisory controls. This block may be signed by other than welder for non-weld issues.

NOTE: THE PURPOSE OF BLOCKS 29-34 IS TO PICK-UP THE JOINT NDT PROCESS AT THE POINT THE PART C RECORD WAS GENERATED AND TO DOCUMENT THE PROCESS FROM THAT POINT FORWARD. CHECK THE BOX "[] (SEE ADDITIONAL STRUCTURAL DEFECT RECORD)" IN THE REPAIR SECTION OF THE FORM WHEN BLOCK 29 OR 30 HAS INSUFFICIENT ROWS FOR THE REQUIRED NUMBER OF ENTRIES.

BLOCK 29 - **IND NO.**

(INSPECTOR) At the point the Part C record was generated, some required NDT may have already been completed and certified except for indications noted in Block 7. Other required NDT may yet need to be performed on the entire joint. Make block entries as follows:

- a. For inspections of repairs to clear indications in Block 7, list the indication number you are inspecting.
- b. For inspections on the entire joint that are not yet completed on a Part A or Part B Record, enter "N/A" beside the required NDT. The N/A entry means the required NDT applies to the entire joint.

BLOCK 30 - **REQUIRED NDT**

(INSPECTOR) List all required NDT to certify the defect you are inspecting as follows:

- a. Ensure all the required NDT for the entire joint is documented and certified, including NDT previously certified on previous Part A, Part B, or Part C records (if required by local instruction), and all other NDT required to complete the joint, plus repair NDT. On the Part C record, at a minimum, list all NDT required to clear the defect and any remaining (not previously certified) NDT required to certify the joint. All NDT required, (previously certified and repair NDT) may be listed if required by local instructions. Required NDT can be found in Block 21 of the Part A record, in Block 27 of the Part B record, or in Block 30 of other Part C records generated for previous repair cycles. See discussion on expansion requirements in Block 35.
- b. On rare occasion the required NDT may change. In this case, the substituted NDT shall be listed, not the original required NDT. These changes may be specified by P&E through TWD revisions.

BLOCK 31 - **NDT & ACCEPTANCE PROCEDURE REV, CH**

(INSPECTOR) Enter the NDT methods and acceptance standard procedure used for the NDT listed in Block 30.

BLOCK 32 - **NDT REPORT, EQUIPMENT**

(INSPECTOR) The purpose of this block is to record data for equipment or PT penetrant used. Enter equipment or PT penetrant information for the required NDT listed in Block 30 as directed on the form or list the NDT Report number that gives this information. Enter "Yoke" when performing an MT by yoke method. Equipment information is not required for MT by yoke. If the NDT listed is NDT previously completed satisfactorily and

does not have to be repeated, enter "See Part (A or B or C)" as applicable. If "MT EXCAV", "MT BACKGOUGE" or "MT EVERY LAYER" is the NDT listed in Block 27, "Entry Not Required" may be entered in Block 29. (See example of Part B form). NA VT only inspections.

BLOCK 33 - **RESULTS A OR R**

(INSPECTOR) Enter "A" for accept or "R" for reject to indicate the inspection result. For NDT that has been accepted up to this point in the process enter "A". In this case, your entry is based on entries and certification signatures made on associated Part A, B, or C records.

BLOCK 34 - **INSPECTOR**

Enter signature, printed name, and date for entries in Blocks 29 through 33. Your signature for previous, acceptable NDT is based on entries and certification signatures made on associated Part A, B, or C records.

BLOCK 35 - **REMARKS**

(ALL) Enter remarks. Expansion requirements should be documented or referred to in this block. Each entry shall contain signature, printed name and date except where the entry is pre-printed on the form by P&E.

NOTE: EXPANSION REQUIREMENTS MAY BE SPECIFIED BY P&E THROUGH TWDS.

(This Page Intentionally Left Blank)

PIPE, MACHINERY AND PRESSURE VESSEL WELD RECORD

QA FORM 20C (NEW 09/05) (WORK PLANNING TO FILL IN BLOCKS/EVALUATE BLOCK OPTIONS IDENTIFIED BY

A ♦ PRIOR TO RELEASE)

♦1. SHIP		♦2. JCN		♦3. LWC/SHOP		♦4. CWP/REC SER NO.			
♦5. SYSTEM/COMPONENT		♦6. FABRICATION STD: <input type="checkbox"/> 278 <input type="checkbox"/> 250-1500-1		♦7. WELD CLASS	♦8. JT DESIGN	♦9. SSMAP/JT ID DWG & REV	♦10. JOINT NO. <input type="checkbox"/> MARK JNT		
11. PART NO. 1	DESCRIPTION	SIZE (NPS)	SCHED/CLASS		PART NO. 2	DESCRIPTION	SIZE (NPS)	SCHED/CL.	
♦ DWG NO. & REV.		♦ PC. NO.		♦ MATL.		♦ DWG NO. & REV.		♦ PC. NO.	♦ MATL.
INSTALLATION	12. PART NO. 1	<input type="checkbox"/> EXISTING <input type="checkbox"/> EXST MATL MKS <input type="checkbox"/> GEN MATL TEST	PART NO. 2	<input type="checkbox"/> EXISTING <input type="checkbox"/> EXST MATL MKS <input type="checkbox"/> GEN MATL TEST	<input type="checkbox"/> NEW	MATERIAL MRKS/TEST RESULT:	<input type="checkbox"/> NEW	MATERIAL MRKS/TEST RESULT:	
	NEW MATERIAL (INCLUDING CONSUMABLE INSERTS, BACKING MATERIAL, ETC.)								
	13. PART NO.	14. DESCRIPTION		15. LEVEL I NO./OTHER TRACEABILITY NUMBER/MATERIAL/SPECIFICATION MARKINGS			16. FITTER/INSPECTOR (Signature, Badge, Date)		
	17. PART NO. 1	WALL THICKNESS:		PREWELD NDT	JOINT DESIGN INSTALLED	FITUP: <input type="checkbox"/> SAT	21. VERIFICATION		
	NO. 2	♦18. REQD	19. ACTUAL	<input type="checkbox"/> COMP	♦20. FITUP	FITTER (Signature, Badge, Date)	INSPECTOR (250-1500-1 welds) (Signature, Badge, Date)		
NO. 1	♦ Nom:	Min:	<input type="checkbox"/> NA						
NO. 2	♦ Nom:	Min:							
	♦ Min:								
WELDING	22. WELD PROC/REV/CH & TECH DATA SHEET			23. POSITION	24. MIN PREHEAT TEMP:	25. FABRICATION LOCATION: SHOP/BLDG _____			
				HFP VFP OOP		SHIPBOARD			
	26. LAYER(S) (T/R/I/F)	27. FILLER TYPE	28. FILLER SERIAL NO. (e. g., Level I No.)		MAX INTERPASS TEMP:	COMPT: FRAME LEVEL P C S			
					<input type="checkbox"/> SAT	29. WELDER (Signature, Badge, Date)			
					<input type="checkbox"/> SAT				
					<input type="checkbox"/> SAT				
					<input type="checkbox"/> SAT				
♦30. STRESS RELIEF REQD	<input type="checkbox"/> YES <input type="checkbox"/> NO	31. PROCEDURE: _____			32. HEAT TREATER (Signature, Badge, Date)				
		TEMPERATURE:	DURATION	HR	MIN				
33. WELDING COMPLETE, SURFACE IS PREPPED AND READY FOR FINAL NDT, AND JOINT NUMBER IS PERMANENTLY MARKED NEAR JT IF "MARK JT" BOX IN BLOCK 10 IS CHECKED.				WELDER or FITTER (Signature, Badge, Date)					
WELD INSPECTIONS: (I) = INTERMEDIATE, (F) = FINAL # = PREWELD INSPECTION (EXCAVATION, END-PREP, ETC.) ## = NUCLEAR ONLY									
♦34. ACCEPTANCE STANDARD:				♦ CLASS					
♦35. INSP	♦36. INSPECTION TYPE			37. PROCEDURE USED		38. INSPECTOR (Signature, Badge, Date)			
♦ <input type="checkbox"/> #	♦ <input type="checkbox"/> 5X <input type="checkbox"/> RT	♦ <input type="checkbox"/> TACK ##	♦ <input type="checkbox"/> VT <input type="checkbox"/> 5X			<input type="checkbox"/> SAT	<input type="checkbox"/> REJ		
<input type="checkbox"/> NA	♦ <input type="checkbox"/> PT TYPE II-C <input type="checkbox"/> MT EQPT NO: _____	<input type="checkbox"/> NA	♦ <input type="checkbox"/> PT TYPE II-C <input type="checkbox"/> MT EQPT NO: _____			<input type="checkbox"/> SAT	<input type="checkbox"/> REJ		
♦ <input type="checkbox"/> ROOT	♦ <input type="checkbox"/> VT <input type="checkbox"/> 5X	♦ <input type="checkbox"/> ROOT	♦ <input type="checkbox"/> PT TYPE II-C <input type="checkbox"/> MT EQPT NO: _____			<input type="checkbox"/> SAT	<input type="checkbox"/> REJ		
<input type="checkbox"/> NA	♦ <input type="checkbox"/> PT TYPE II-C <input type="checkbox"/> MT EQPT NO: _____	<input type="checkbox"/> NA	♦ <input type="checkbox"/> PT TYPE II-C <input type="checkbox"/> MT EQPT NO: _____			<input type="checkbox"/> SAT	<input type="checkbox"/> REJ		
♦ <input type="checkbox"/> BKGGOUGE	♦ <input type="checkbox"/> 5X	♦ <input type="checkbox"/> BKGGOUGE	♦ <input type="checkbox"/> PT TYPE II-C <input type="checkbox"/> MT EQPT NO: _____			<input type="checkbox"/> SAT	<input type="checkbox"/> REJ		
<input type="checkbox"/> NA	♦ <input type="checkbox"/> PT TYPE II-C <input type="checkbox"/> MT EQPT NO: _____	<input type="checkbox"/> NA	♦ <input type="checkbox"/> PT TYPE II-C <input type="checkbox"/> MT EQPT NO: _____			<input type="checkbox"/> SAT	<input type="checkbox"/> REJ		
♦ <input type="checkbox"/> PT/MT (I)	♦ <input type="checkbox"/> PT TYPE II-C <input type="checkbox"/> MT EQPT NO: _____	♦ <input type="checkbox"/> PT/MT (I)	♦ <input type="checkbox"/> PT TYPE II-C <input type="checkbox"/> MT EQPT NO: _____			<input type="checkbox"/> SAT	<input type="checkbox"/> REJ		
<input type="checkbox"/> NA	♦ <input type="checkbox"/> PT TYPE II-C <input type="checkbox"/> MT EQPT NO: _____	<input type="checkbox"/> NA	♦ <input type="checkbox"/> PT TYPE II-C <input type="checkbox"/> MT EQPT NO: _____			<input type="checkbox"/> SAT	<input type="checkbox"/> REJ		
♦ <input type="checkbox"/> VT (F)	♦ OUTSIDE (ALL VTs) <input type="checkbox"/> INSIDE INACCESSIBLE	♦ <input type="checkbox"/> VT (F)	♦ <input type="checkbox"/> INSIDE			<input type="checkbox"/> SAT	<input type="checkbox"/> REJ		
<input type="checkbox"/> NA	♦ <input type="checkbox"/> PARTIAL INSIDE INSP	<input type="checkbox"/> NA	♦ <input type="checkbox"/> PARTIAL INSIDE INSP			<input type="checkbox"/> SAT	<input type="checkbox"/> REJ		
♦ <input type="checkbox"/> PT/MT (F)	♦ <input type="checkbox"/> 24 HR. MT	♦ <input type="checkbox"/> PT/MT (F)	♦ <input type="checkbox"/> PT TYPE II-C <input type="checkbox"/> MT EQPT NO: _____			<input type="checkbox"/> SAT	<input type="checkbox"/> REJ		
<input type="checkbox"/> NA	♦ <input type="checkbox"/> PT TYPE II-C <input type="checkbox"/> MT EQPT NO: _____	<input type="checkbox"/> NA	♦ <input type="checkbox"/> PT TYPE II-C <input type="checkbox"/> MT EQPT NO: _____			<input type="checkbox"/> SAT	<input type="checkbox"/> REJ		
♦ <input type="checkbox"/> PT/MT-ID	♦ <input type="checkbox"/> PT TYPE II-C <input type="checkbox"/> MT EQPT NO: _____	♦ <input type="checkbox"/> PT/MT-ID	♦ <input type="checkbox"/> INACCESSIBLE <input type="checkbox"/> PARTIAL INSP DONE			<input type="checkbox"/> SAT	<input type="checkbox"/> REJ		
<input type="checkbox"/> NA (F)	♦ <input type="checkbox"/> INACCESSIBLE <input type="checkbox"/> PARTIAL INSP DONE	<input type="checkbox"/> NA (F)	♦ <input type="checkbox"/> INACCESSIBLE <input type="checkbox"/> PARTIAL INSP DONE			<input type="checkbox"/> SAT	<input type="checkbox"/> REJ		
♦ <input type="checkbox"/> RT (F)	♦ <input type="checkbox"/> 8 HR.	♦ <input type="checkbox"/> RT (F)	♦ <input type="checkbox"/> 60 <input type="checkbox"/> 360 <input type="checkbox"/> 100%			<input type="checkbox"/> SAT	<input type="checkbox"/> REJ		
<input type="checkbox"/> NA	♦ <input type="checkbox"/> 60 <input type="checkbox"/> 360 <input type="checkbox"/> 100%	<input type="checkbox"/> NA	♦ <input type="checkbox"/> 60 <input type="checkbox"/> 360 <input type="checkbox"/> 100%			<input type="checkbox"/> SAT	<input type="checkbox"/> REJ		
39. REMARKS (SHOP REMARKS ALSO)									
FINAL DISPOSITION	40. SUPERVISOR (Signature, Badge, Date)				41. LOCAL GOVERNMENT INSP./QAS (Signature, Badge, Date)				

PIPE, MACHINERY AND PRESSURE VESSEL WELD RECORD – WELD DEFECT REPAIR SHEET QA FORM 20C-2				
SHIP:		DWG/JCN:		JOINT NO.:
			PAGE	OF
52. DEFECT DESCRIPTION				
<input type="checkbox"/> CRACK	<input type="checkbox"/> INCOMP INSERT FUSION	<input type="checkbox"/> INCOMPLETE FUSION	<input type="checkbox"/> ARC STRIKE	<input type="checkbox"/> ROUNDED
<input type="checkbox"/> SLAG	<input type="checkbox"/> CRATER PIT	<input type="checkbox"/> BURN THRU	<input type="checkbox"/> WELD SPLATTER	<input type="checkbox"/> OTHER: (ENTER BELOW)
<input type="checkbox"/> POROSITY	<input type="checkbox"/> INTERNAL CONCAVITY	<input type="checkbox"/> MELT THRU	<input type="checkbox"/> ROOT EDGE FUSION COND	
<input type="checkbox"/> UNDERCUT	<input type="checkbox"/> INTERNAL CONVEXITY	<input type="checkbox"/> TUNGSTEN	<input type="checkbox"/> LINEAR	
<input type="checkbox"/> OXIDATION	<input type="checkbox"/> CENTERLINE CREASE	<input type="checkbox"/> INCOMPLETE PENETRATION	<input type="checkbox"/> LINEAR DISPOSED	
53. DEFECT LOCATION(S) AND EXTENT <input type="checkbox"/> SEE SKETCH IN REMARKS			54. INSPECTOR (SIGNATURE/DATE)	
DEFECT REPAIR				
55. TYPE OF REPAIR <input type="checkbox"/> GRIND ONLY <input type="checkbox"/> GRIND AND WELD <input type="checkbox"/> WELD ONLY <input type="checkbox"/> OTHER (SEE REMARKS)	56. REPAIR LOCATION(S) AND EXTENT <input type="checkbox"/> SEE SKETCH IN REMARKS	57. WELD PROC AND REV/CH <input type="checkbox"/> NA <input type="checkbox"/> SAME AS ORIGINAL	58. EXCAV NDT REQUIRED <input type="checkbox"/> Y (MARK REQD INSP BLK 65/66) <input type="checkbox"/> N	59. ROOT PASS INSP REQUIRED <input type="checkbox"/> Y (MARK REQD INSP BLK 65/66) <input type="checkbox"/> N
60. LAYER T/R/L/F	61. FILLER TYPE	62. FILLER SERIAL NO. (MIC NO.)	63. PREHEAT/ INTERPASS TEMP <input type="checkbox"/> SAT	64. WELDER (SIGNATURE/DATE)
			<input type="checkbox"/> SAT	
			<input type="checkbox"/> SAT	
			<input type="checkbox"/> SAT	
REPAIR INSPECTIONS				
REPAIR WELD REQUIRES THE SAME INSPECTIONS AS THE ORIGINAL WELD. CARRY OVER ALL REJECTED OR VOIDED INSPECTIONS FROM PAGE 1.				
65. INSPECTION	66. INSPECTION TYPE	67. PROCEDURE USED	68. INSPECTOR (SIGNATURE/DATE)	
<input type="checkbox"/> EXCAV <input type="checkbox"/> NA	<input type="checkbox"/> 5X <input type="checkbox"/> PT TYPE IIC <input type="checkbox"/> MT/EQUIP NO.:		<input type="checkbox"/> SAT <input type="checkbox"/> REJ	
<input type="checkbox"/> ROOT <input type="checkbox"/> NA	<input type="checkbox"/> VT <input type="checkbox"/> 5X <input type="checkbox"/> PT TYPE IIC <input type="checkbox"/> MT/EQUIP NO.:		<input type="checkbox"/> SAT <input type="checkbox"/> REJ	
<input type="checkbox"/> BACKGOUGE <input type="checkbox"/> NA	<input type="checkbox"/> 5X <input type="checkbox"/> PT TYPE IIC <input type="checkbox"/> MT/EQUIP NO.:		<input type="checkbox"/> SAT <input type="checkbox"/> REJ	
<input type="checkbox"/> PT/MT (I) <input type="checkbox"/> NA	<input type="checkbox"/> PT TYPE IIC <input type="checkbox"/> MT/EQUIP NO.:		<input type="checkbox"/> SAT <input type="checkbox"/> REJ	
<input type="checkbox"/> VT (F) <input type="checkbox"/> NA	<input type="checkbox"/> OUTSIDE (ALL VTs) <input type="checkbox"/> INSIDE INACCESSIBLE <input type="checkbox"/> INSIDE <input type="checkbox"/> PARTIAL INSIDE INSP		<input type="checkbox"/> SAT <input type="checkbox"/> REJ	
<input type="checkbox"/> PT/MT(F) <input type="checkbox"/> NA	<input type="checkbox"/> PT TYPE IIC <input type="checkbox"/> 24 HOUR MT/EQUIP NO.:		<input type="checkbox"/> SAT <input type="checkbox"/> REJ	
<input type="checkbox"/> PT/MT – ID(F) <input type="checkbox"/> NA	<input type="checkbox"/> PT TYPE IIC <input type="checkbox"/> MT/EQUIP NO.: <input type="checkbox"/> INACCESSIBLE <input type="checkbox"/> PARTIAL INSP DONE		<input type="checkbox"/> SAT <input type="checkbox"/> REJ	
<input type="checkbox"/> RT (F) <input type="checkbox"/> NA	<input type="checkbox"/> 8 HOUR <input type="checkbox"/> 60 <input type="checkbox"/> 360 <input type="checkbox"/> 100%		<input type="checkbox"/> SAT <input type="checkbox"/> REJ	
69. REMARKS				

(This Page Intentionally Left Blank)

QA FORM 20C INSTRUCTIONSPIPE, MACHINERY AND PRESSURE VESSEL WELD RECORD/WELD DEFECT REPAIR SHEET

PURPOSE: This instruction provides a form to document in process controls for welding and NDT of piping, machinery, pressure vessels, shafting and propellers including base metal repair and repair of castings in accordance with NAVSEA S9074-AR-GIB-010/278 (NSTP-278), MILSTD-2191, DOD-STD-2185 or in accordance with NAVSEA 250-1500-1. This Form does not contain all required data for accomplishment of Titanium Welds. Additional data is required as specified in local documents.

NOTES:

1. WHEN ADDITIONAL NDT AND OPERATIONAL TESTING (IN LIEU OF HYDROSTATIC STRENGTH TESTING) OF WELDED PIPE JOINTS IS SPECIFIED PER CHAPTER 505 OF NAVSEA S9086-RK-STM-010/CH505, PIPING SYSTEMS FOR NSTP-278 CLASS P-1 JOINTS, THE CWP/TGI SHALL CLEARLY SPECIFY THAT ADDITIONAL NDT IN LIEU OF HYDROSTATIC TESTING IS REQUIRED. ROOT LAYER SHALL BE PT OR MT INSPECTED. THE 5X VISUAL INSPECTION SUBSTITUTION ALLOWED BY NSTP-278 IS NOT PERMITTED. THE FINAL LAYER SHALL BE PT INSPECTED; MT IS NOT PERMITTED.
2. PLANNER SHALL COMPLETE THE BLOCKS IDENTIFIED BY A RED DIAMOND PRIOR TO ISSUING.
3. PER NAVSEA S9074-AR-GIB-010-278, WHEN A SPECIFIC ITEM ON A RECORD IS NOT APPLICABLE THE LETTERS "NA" SHALL BE ENTERED. IF A LINE ITEM HAS A "NA" BLOCK, CHECKING THE BLOCK MEETS THE INTENT OF ENTERING "NA" FOR THE REMAINDER OF THE BLOCKS FOR THAT LINE.

SCOPE: This weld record is required for NSTP-278 A-F, A-1, A-2, A-3, A-LT, P-1, P-LT, M-1, and T-1 welds, SUBSAFE welds, SOC welds, welding per MIL-STD-2191 (Main Shafts) and DOD-STD-2185 (Propellers) and other welds as required by the local Engineering authority.

PROCEDURE: Production and QA personnel make entries in QA form 20C as required below. Signatures verify that all entries in the associated line item are correct. When adding Continuation or Repair Sheets, enter the Ship (from Block 1), Map Drawing Number (from Block 9) or JCN (from Block 2) if there is no Map Drawing and the Joint Number (from Block 10). Enter the page number, starting with page 2, for each supplemental sheet (Continuation Sheet or Defect Repair Sheet) associated with the joint.

PIPE, MACHINERY AND PRESSURE VESSELS WELDING DETAIL/NDT RECORD IDENTIFICATION SECTION

BLOCK 1 - SHIP HULL

Enter ship's name and hull number.

BLOCK 2 - JCN

Enter Job Control Number.

BLOCK 3 - LWC/SHOP

Enter LWC.

BLOCK 4 - CWP/REC SER NO.

Enter REC serial number or NA as applicable. Do not list the REC Rev.

BLOCK 5 - SYSTEM/COMPONENT

Enter system and/or component to be welded, (e.g., Main Sea Water, 1MS-V23, HP Air flask, or #2 propulsion shaft).

BLOCK 6 - **FABRICATION STD.**

Mark the governing fabrication standard, NSTP-278 or NAVSEA 250-1500-1. For other Fabrication standards (MIL-STD 2191, DOD-STD-2185) enter an asterisk or other identifying mark and record procedure in the Remarks block.

BLOCK 7 - **WELD CLASS**

Enter applicable weld class from NSTP-278 fabrication standard (e.g., P-1, A-2). Enter classification for NAVSEA 250-1500-1 welds.

BLOCK 8 - **JT DESIGN**

Enter joint design. This can be a MIL-STD-22D or NAVSEA 250-1500-1 joint number, a joint design from a drawing or technical manual or a description such as "Build-up" or "Seal Weld". More than one joint design may be entered if allowed by drawing, NSTP-278, the Weld Procedure and local policy. If necessary, enter "RMKS" and list allowed joint design(s) in the Remarks section.

BLOCK 9 - **SSMAP/JT ID DWG & REV**

Enter map drawing or joint identification drawing. Enter NA if there is no map or joint identification drawing. Note that most submarine work requires that P-1 joints are mapped to a drawing that is included in the Ship's Drawing Index. See Deep Diving General Overhaul Specifications (DDGOS) 9480-0-I.

BLOCK 10 - **JOINT NO.**

Enter joint number, including type (WB, WS etc.) if listed, from joint map drawing. Check the "Mark JT" block if the weld is not mapped. NSTP-278 requires weld joint marking of class A-F, A-1, A-2, A-3, A-LT, P-1, P-LT, M-1 and T-1 welds if not mapped. Fabrication/repair/cladding welds within components do not require marking if the weld location is clearly defined on the record such that the record is clearly applicable to only that location.

If there is no joint number/map drawing or other traceability from joint to record:

Check the "MARK JT" block if required by TWD and/or local instruction. This box identifies to the fitter that the joint shall be marked, usually by vibra-tool, scribe or etch.

Example: Enter the Level I Certifying Activity Designator (CAD) letter(s) followed by a five digit date number and a joint number. The date number is the two-digit year plus the Julian day when the record is created. A job at Norfolk Naval Shipyard that installs one elbow would need two joint numbers for records created on May 14 1999, N-99134-1 and N-99134-2. (The joint number is unique to the applicable job (JCN). Each job starts a new series so there is no need for joint number logs or pre-allocation of joint numbers).

BLOCK 11 - **PART DESCRIPTION**

- a. Enter information for each part to be joined or repaired.
- b. Enter description of piece (e.g., pipe, valve, clevis, plate, etc.).
- c. Enter NPS pipe size and schedule or class (pipe welds only, NA others including pipe fittings).
- d. Enter arrangement drawing (preferred) or diagram and applicable revision.
- e. Enter piece number from drawing just entered (enter NA if there is no pc no.).
- f. Enter the base material type (normally from drawing) and the S-Group Number (e.g., ASTM A 178, Grade A (S-1), CUNI-70:30 (S-34), CRES 316 (S-8), 1-1/4Cr 1/2Mo (S-4)). S-group numbers are obtained from Table (1) of NSTP 278. Specify CRES by grade, Aluminum by grade and temper and Inconel (S-43) as either 600 or 625. In addition, for carbon steels (Group S-1) with carbon content greater than 0.30%, make a note of the maximum carbon content in the Remarks block. Include material spec if known (e.g., QQ-N-281, ASTM A182 F11). For new material, P&E verifies that information in Block 11, especially for material type, matches material ordering information in TWD. Use the Remarks block if additional space is needed.

NOTE: FOR BASE METAL REPAIRS, NORMALLY ONLY INFORMATION FOR PART 1 IS COMPLETED. ENTER "NA" IN PART 2 BLOCKS. FOR BASE METAL REPAIRS INVOLVING MORE THAN ONE MATERIAL TYPE, SUCH AS A REPAIR TO CU-NI BASE MATERIAL THAT TIES INTO AN ADJACENT NI-CU CLADDING, INFORMATION FOR BOTH MATERIALS SHALL BE COMPLETED AS PART 1 AND PART 2.

INSTALLATION SECTION

NOTE: THE PURPOSE OF BLOCK 12 IS TO CONFIRM THE MATERIAL OF EACH PART IS THE SAME AS LISTED IN BLOCK 11.

BLOCK 12 - **PART NO.1 AND PART NO.2**

(Welder) Check New or Existing for each part. If the part is new, no further action is required. If existing, check the method used to verify the material and annotate the existing material markings found or the results of the generic material test in the results section. For base metal repairs, Part 2 will be left blank if Part 2 of Block 11 is blank as only one part exists.

BLOCK 13 - **PART NO.**

(Welder) Enter part number from Block 11 for each new part. Enter "NA" for backing rings or consumable inserts which are not included in Block 11.

BLOCK 14 - **DESCRIPTION**

(Welder) Enter piece description either from Block 11 or for additional pieces, such as backing rings or consumable inserts which do not have a part number.

BLOCK 15 - **LEVEL I NO./OTHER TRACE NO./MATERIAL/SPECIFICATION MARKINGS**

(Welder) For all new material, enter the material type (e.g., 316L, Inconel 625, ASTM A106 Grade B, etc.) when this information is on the piece or its accompanying tag or documentation. In addition, the following information is required:

- a. For new material in applications requiring traceability markings (e.g., Level I, SOC, etc.), enter the traceability marking.
- b. For new material not requiring traceability marking and not having a material type evident, enter the information required by Table 1 below (this would normally be the stock number).

TABLE 1- DOCUMENTATION REQUIREMENTS	
Material Control Level	Required Information
Level I Material Other Than Fasteners	MIC Number and any other traceability number, including any local traceability number (e.g., PNSY MLN – examples Z142, AB12)
Level I Fasteners	Either the MIC number or Material Marking, Color Code, Heat/Lot Number, and Manufacturers Symbol (Note: For nuts containing a self-locking insert, the color of the insert is the Manufacturer's symbol)
Controlled Structural Material And SOC Control Division "A" Material	Traceability Number
SOC Control Division "B" Material	Markings providing identification to material type or specification
AERP And Other Rotatable Pool Material (688 Class, TRIPER, Etc.)	Enter the appropriate rotatable pool serial number (e.g., RP-148A, 4810-013-5812-A3-0113, TIN -292-11893, etc.)
Transferred And Cannibalized Material	Enter the Equipment Removal List No. or other material History/ Traceability number (ERL# XXXX, SSBN-600 EHF #24, etc.)
Other Material Within The LEVEL I/SUBSAFE Boundary And SOC Control Division "C" Material	1. Enter at least one of the following documentation attributes: <ul style="list-style-type: none"> a. Stock Number (from package/container) b. Part Number (from package/piece) c. Part Number and associated Manufacturing Work Procedure (for manufactured items) d. Local Traceability Number (from piece/tag) e. Drawing and Piece Number (from piece/tag) f. Generic, MIL-SPEC, or Material Specification Marking (from piece) g. NDT record numbers or test results for items verified by generic material testing 2. For SOC components only: Enter the stock number of the "O"-ring lubricant or any sealant used during assembly

- c. If an alternate material is authorized enter an asterisk or other identifying symbol and provide authorization (e.g., DFS #) in Block 39 (Remarks).
- d. For consumable inserts, enter the type (e.g., MIL-67) marked on the insert, the insert size and the Level I or certified material number from the tag.

BLOCK 16 - **FITTER/INSPECTOR**

Sign to verify that Block 15 entries match the markings on the piece or tag and to verify that the material matches that required by Block 11. Where material type is not annotated on the piece or its accompanying tag/documentation, material verification is accomplished by matching the identifying marking on the tag/documentation against the ordering information specified in the TWD.

BLOCK 17 - **PART**

No entry. Part numbers correspond to Block 11.

BLOCK 18 - **WALL THICKNESS REQUIRED**

Enter nominal wall thickness for piping and piping fittings.

NA may be entered for non-piping applications which are greater than ½ inch thick, or pipe socket fittings, valves, piping drilled after boss installation or piping passing through sleeves.

Nominal wall thickness is the nominal wall thickness for the associated system piping. Minimum allowable piping installation wall thickness is that provided by the installation drawing or can be calculated by subtracting 10% from the nominal wall thickness. Tubing specifications generally specify a minimum wall thickness only. For NAVSEA 250-1500-1 welds and if required by local direction for NSTP-278 welds, the nominal wall thickness for tubing should be calculated by adding 10% to the tubing minimum wall thickness. If the basis for minimum wall thickness is different from above, document the special basis in the Remarks.

Enter minimum allowable installation thickness.

BLOCK 19 - **WALL THICKNESS ACTUAL**

(Welder) Enter minimum measured thickness after end preparation. "NA" may be entered for non-piping applications which are greater than ½ inch thick, or pipe socket fittings, valves, piping drilled after boss installation or piping passing through sleeves.

For casting repairs, record the wall thickness adjacent to the defect (excavation area). A sketch showing the size (length, width, and depth) and location of all nominal and special repair will be entered per the directions for the REMARKS section (Block 39).

BLOCK 20 - **FITUP**

Planner mark PREWELD NDT and FITUP AFTER TACK blocks "NA" when not applicable. Fitter check other appropriate blocks or make entry for:

- a. Completion of any required pre-weld NDT - See Block 35 and 36 and the TWD.
- b. Installed joint design - Annotate the joint design installed. The installed joint design shall be as specified in Block 8. If an alternate joint design is authorized enter an asterisk or other identifying symbol and provide authorization (e.g., DFS #) in Block 39 (Remarks). For base metal repair, sketch excavation in Remarks section. Sketches should include location, dimensioned from a reference surface or line, and length width and depth of excavation.
- c. Satisfactory fit-up - This means that the fit-up meets the procedure requirements for the joint design, and that any scribe line or joint number marking (required if "MARK JT" in Block 10 is checked) is complete.
- d. Satisfactory fit-up after tacking - If NA is not checked in advance by P&E, the SAT block will be checked after satisfactory fit-up after tacks by the NDT Inspector.

BLOCK 21 - **VERIFICATION**

(Fitter/NDT Inspector) Sign verification of proper fit-up.

WELDING SECTION**BLOCK 22** - **WELD PROC/REV/CH & TECH DATA SHEET**

(Welder) Enter weld procedure (including revision and change), tech data sheet or other welding instruction.

BLOCK 23 - **POSITION**

(Welder) Circle HFP (Horizontal Fixed Pipe), VFP (Vertical Fixed Pipe) or OOP (Out Of Position pipe) as applicable by local instruction.

BLOCK 24 - **MIN PREHEAT**

PREHEAT - (Welder) Enter minimum preheat temperature just prior to welding.

INTERPASS - (Welder) Enter maximum interpass temperature as measured during the process.

BLOCK 25 - **FABRICATION LOCATION**

(Welder) Enter location where work is performed. Compartment can be the damage control number or the common name such as UL MMR1, or Aux Machinery Space. Circle Port (P), Centerline (C), or Starboard (S).

BLOCK 26 - **LAYER(S)**

(Welder) Enter type of weld layer(s) (e.g., Tack (T), Root (R), Intermediate (I), or Final (F)). Record one line for each different welder/filler metal combination. (If a complete weld is done by the same welder, on the same day, using filler metal with the same traceability numbers, the layer may be indicated as T, R, I, F using only one line). However, the welder's signature is required prior to each specified inspection, (e.g., If a root PT or 5X is required, the R and I layers can not be on the same line). Intermediate layers shall be numbered (I1, I2, I3...) if needed, to record more than one filler metal lot or welder. Use continuation sheet if needed.

BLOCK 27 - **FILLER TYPE**

(Welder) Enter type of filler material used, (e.g., RN60, 9N10, etc.).

BLOCK 28 - **FILLER SERIAL NO.**

(Welder) Enter filler serial number (Level I numbers, traceability numbers) from filler or tag. Enter, "Non level I", for Non-level filler material.

BLOCK 29 - **WELDER**

(Welder) Sign, enter badge number and Date to verify that the entries made are correct and the weld is per the required procedure. For HY or HSLA welds enter the time and date that the weld reached ambient temperature in the remarks.

BLOCK 30 - **STRESS RELIEF REQUIRED**

Planner mark "Yes" if stress relief is desired for distortion control or is required by tech manual or drawing, otherwise mark "NO" block. If Block 30 is marked "NO", "NA" Blocks 31 and 32.

BLOCK 31 - **PROCEDURE**

Welder enter stress relief procedure used, temperature range and duration. Planner mark "NA" if Block 30 is marked "NO".

BLOCK 32 - **HEAT TREATER**

Heat Treater, sign to verify that the heat treatment was accomplished per the required procedure, temperature range and duration. Planner, mark "NA" if Block 30 is marked "NO".

BLOCK 33 - **WELDER/FITTER**

(Welder) (Fitter includes other trades as applicable). For welds that are machined or ground flush, include a sketch in the Remarks section including weld location from a reference surface or line, and the length and width of the weld prior to requesting NDT. Sign that all welding and surface preparation is correctly completed, reference line(s) and joint number (if checked in Block 10) are marked and weld is ready for NDT. The welder

shall sign this block for weld workmanship if welding is performed and should be co-signed by the shop performing the final action on the joint (if other than the welder) prior to inspection as specified by local direction.

WELD INSPECTIONS SECTION

BLOCK 34 - **ACCEPTANCE STANDARD/CLASS**

Planner enter NDT acceptance standard (e.g., MIL-STD-2035 or NAVSEA 250-1500-1) and acceptance standard class (if applicable). (NDT acceptance standard classes for NSTP-278 welds are found in NSTP-278 Table XI).

BLOCK 35 - **INSPECTION**

Planner mark inspection(s) required. Mark NA for inspections that are not required. Note that first line allows writing in inspections, especially pre-weld inspections like excavations or end-preps. Mark MT/PT-ID for joints which require MT/PT and have an inside accessible surface (e.g., non-backing ring butt welds).

BLOCK 36 - **INSPECTION TYPE**

Planner mark the types of NDT (VT, 5X, PT, MT or RT). Mark "Inside" when required for welds that allow for inside inspections. For welding of HY/HSLA and STS materials indicate when 8 hour RT or 24 hour MT are required by marking appropriate box.

(Inspector) Record equipment numbers as appropriate. Line out Type II [Method] C if that type penetrant dye and method are not used and record substitute PT types and methods in the Procedure or Remarks block. If a yoke is used for MT write "Yoke" in place of the unique equipment identification. Mark "inaccessible" or "partial inspection done", as appropriate, if full inspection of inside surface cannot be accomplished.

BLOCK 37 - **PROCEDURE USED**

(Inspector) Record inspection procedure used.

BLOCK 38 - **INSPECTOR**

(Inspector) Mark "SAT" for satisfactory or "REJ" for rejection of required inspections. Do not mark either for inaccessible inspections. Sign verification for inspections required by Blocks 35 and 36. Rejection is required if an inspection shows rejectable conditions that have not been satisfactorily repaired by polishing or light grinding and reinspected. If an inspection is rejected add a Weld Defect Repair Sheet and complete Blocks 52-54. Carry rejected, voided, and incomplete inspections to Block 65 and 66. See Header instructions above for adding a Repair Sheet. If PT/MT-ID (F) in Block 36 is marked "inaccessible", the Inspector will enter signature and leave "SAT" and "REJ" check box blank.

BLOCK 39 - **REMARKS**

(All) Record additional relevant information as directed in this instruction, by work document or identified in-process. Appropriate remarks entries or sketches include: defect size and location, special weld joint designs, records of material weldability tests for casting repairs, or the additional records required for Titanium welding. Use a continuation sheet for additional space or reference a separate record. Each entry shall contain a signature, printed name and date except where the entry is pre-printed on the form by P&E.

FINAL DISPOSITION

BLOCK 40 - **SUPERVISOR**

The NDT Supervisor will enter printed name, signature, badge number and date signifying all information on the record (including any rejects and repairs) is technically acceptable and administratively correct. Enter total pages in the Heading.

BLOCK 41 - **LOCAL GOVERNMENT INSP./QAS**

For shipyard use only.

QA FORM 20C - CONTINUATION SHEET INSTRUCTIONS**WELD HISTORY**

BLOCKS 42 - 46 - LAYER, FILLER TYPE, FILLER SERIAL NO., PREHEAT/INTERPASS TEMP, WELDER

(Welder) See instructions for Blocks 24 and 26-29. Note any changes in Remarks on continuation sheet.

WELD INSPECTION

BLOCKS 47 - 50 - INSP, INSPECTION TYPE, PROCEDURE USED, INSPECTOR

(Engineering/Planning/Inspector) See instructions for Blocks 35-38. Write out inspection type in Block 48. General instruction may be written in the Remarks section.

BLOCK 51 - REMARKS

(All) See Block 39 instructions for remarks. Each entry shall contain signature, badge number and date except where the entry is pre-printed on the form by P&E. Initials may be entered in lieu if an employee's signature appears elsewhere on the same page.

QA FORM 20C - WELD DEFECT REPAIR SHEET**DEFECT DESCRIPTION**

BLOCK 52 - DEFECT DESCRIPTION

(Inspector) Place an "X" in the applicable defect description block that describes the defect.

BLOCK 53 - DEFECT LOCATION(S) AND EXTENT

(Inspector) Describe or sketch in remarks (Block 69) the defect location(s) and size(s). Defect location in reference to a permanent landmark is recommended.

BLOCK 54 - INSPECTOR

(Inspector) Verify that rejected inspections from page 1, continuation sheet or previous repair sheet are marked in Block 65 and 66 to be redone. Verify defect identification by signature.

DEFECT REPAIR

BLOCK 55 - TYPE OF REPAIR

(Welder) Mark type(s) of repair. Identify repair type (grind only, grind and weld, etc.). More than one repair type may be marked.

BLOCK 56 - REPAIR LOCATION(S) AND EXTENT

(Welder) Describe or sketch in Remarks section the repair locations and size (length, width and depth). Descriptions shall include distances and/or degrees from "0" reference points or lines to locate repairs. Note that generally the repair extends beyond the defect and this must be recorded.

BLOCK 57 - WELD PROC & REV/CH

(Welder) Mark "NA" if only grinding is needed for repair. Enter the weld procedure, revision and data sheet or mark "Same as original weld" if welding is required.

BLOCK 58 - EXCAVATION NDT REQUIRED

(Welder) Check if MT, PT or 5X VT is required for the excavation area. Also mark Blocks 65 and 66. Any weld repair which originally required final MT or PT requires MT, PT or 5X VT of repair excavations. Consult P&E or local facility engineering if there is any uncertainty about the repair inspection requirements.

BLOCK 59 - **ROOT PASS INSPECTION REQUIRED**

(Welder) Mark if a new root pass inspection is required (when all or part of the root is replaced), also mark Blocks 65 and 66 root pass inspections. Repaired root welds which originally required inspections shall require the same inspections when replaced or repaired. Consult P&E or local facility engineering if there is any uncertainty about the repair inspection requirements.

BLOCKS 60 - 64 - **LAYER, FILLER TYPE, FILLER SERIAL NO., PREHEAT/INTERPASS, WELDER**

See instructions for Blocks 24 and 26-29.

REPAIR INSPECTIONS

BLOCKS 65 - 68 - **INSP, INSPECTION TYPE, PROCEDURE USED, INSPECTOR**

(As Appropriate) In-process repairs of weld rejects generally require the same inspections as the original weld with the addition of inspection of the excavation needed to remove the defect.

The inspector is responsible to carry forward all inspections, from page 1, a Continuation Sheet or a previous Repair Sheet, which were rejected (see Block 38).

The welder will mark any additional inspections required due to the extent of the repair.

Excavations must be 5X VT, MT or PT inspected if MT or PT is a requirement of the finished weld. Root inspections must be accomplished if all or part of the root is redone. Also mark any intermediate layer inspections for repeat if these layers are removed by repair. These inspections must be done prior to covering by the repair. Blocks 58 and 59 serve to remind welders of this before the welding phase of the repair.

Previously accepted inspections shall be redone if a subsequent inspection requires rework that could affect the previous inspection result. Voided inspections shall be marked to be redone in the repair area. Any weld material removal for repair voids the completed finished surface inspections (F), VT, PT, MT, or RT inspections in Block 35.

Consult P&E, NDT Supervisor, or local facility engineering for repair inspection details. Note that your local activity may require that a discrepancy be clarified by a Liaison Action Request for formal direction or approved by a Departure from Specification prior to proceeding with in-process repair of welding defects.

BLOCK 69 - **REMARKS**

(All) Record additional details here, especially sketches of defect areas and repairs. Each entry shall contain signature, printed name and date except where the entry is preprinted on the form by P&E. Initials may be entered if a corresponding employee's signature appears elsewhere on the same page. Use a continuation sheet for additional space. See Block 39.

HYDROSTATIC/PNEUMATIC TEST RECORD

QA FORM 26 (9/05) Planning shall fill in blocks identified by a ♦ prior to issuing

♦1. SHIP	HULL NO.	♦2. JCN	♦3. LWC/SHOP	♦4. CWP/REC SER NO.	♦5. SYSTEM/COMPONENT
♦6. REFERENCES (TEST PRESSURE DRAWINGS, REFERENCE MANUALS OR OTHER APPLICABLE REFERENCES)					
A.		B.		C.	
♦7. REQUIRED TEST AND INSPECTION – SPECIFY TEST REQUIREMENTS [i.e., TYPE OF TEST, TEST FLUID, SPECIAL VALVE POSITIONS, DURATION, ACCEPTANCE CRITERIA, JOINTS TO BE TESTED (IF ENTIRE COMPONENT/SYSTEM IS TESTED, SO STATE)].					
♦8. DIAGRAM OF TEST AREA INCLUDING GAGS AND BLANKS INSTALLED, VALVE POSITIONS, AND TEST GAGES/INSTR USED (DOCUMENT BELOW).					
9. GAGE DATA	RANGE (PSIG)	SERIAL #	CAL DUE DATE		
PRIMARY					
BACKUP					
♦10. REQUIRED TEST PRESSURE (PSIG) AND TEST DURATION:			11. ACTUAL TEST PRESSURE (PSIG) AND TEST DURATION:		
12. TEST RESULTS (CHECK ONE):		<input type="checkbox"/> SAT <input type="checkbox"/> UNSAT			
13. REMARKS:					
14. CERTIFICATION					
PERFORMED BY			INSPECTED BY		
CRAFTSMAN SIGNATURE/BADGE NO.		DATE	QA INSPECTOR/SHIPYARD REP SIGNATURE/BADGE NO.		DATE

(This Page Intentionally Left Blank)

QA FORM 26 INSTRUCTIONSHYDROSTATIC/PNEUMATIC TEST RECORD

PURPOSE: To document hydrostatic/pneumatic tests accomplished on piping systems or portions of a system to recertify the system after maintenance. It also provides a method for the FMA to specify the required retests for work they performed. The QA form 26 will not be used in DSS/SOC applications.

PROCEDURE: The numbered blocks on QA form 26 correspond with the instructions listed below. Any block not used will be marked NA. The planning organization shall fill in blocks identified with the diamond symbol prior to issuing the CWP.

BLOCK 1 - **SHIP HULL NO.**

Enter the ship's name and hull number.

BLOCK 2 - **JCN**

Enter the JCN.

BLOCK 3 - **LWC**

Enter the shop number of the LWC.

BLOCK 4 - **CWP/REC SER. NO.**

Enter the CWP/REC serial number or enter N/A if no CWP/REC is required. Do not list the CWP/REC revision.

BLOCK 5 - **SYSTEM/COMPONENT**

Enter the name of the system and component to be tested.

BLOCK 6 - **TEST REFERENCES**

Enter the applicable test reference and/or other applicable references (e.g., drawing number and revision used to obtain the required test pressure and conducting of the test).

NOTE: (FOR SUBMARINES ONLY) ENTER "S9505-AF-MMA-010/PIPING SYSTEMS" WHICH PROVIDES REQUIREMENTS FOR SHIP'S FORCE TO SET-UP AND CONDUCT TESTING.

BLOCK 7 - **REQUIRED TEST AND INSPECTION POINTS**

Enter the specific test requirements necessary to recertify the work. Specify test requirements (i.e., type of test, test fluid, special valve positions, duration, acceptance criteria, joints to be tested (if entire component/system is tested, so state)).

BLOCK 8 - **DIAGRAM OF TEST AREA**

Enter a diagram of the test area. Be specific. Include such things as relief valve locations, gage locations, blanks, gags, and valve positions, etc. The QAI will verify the diagram prior to performance of the test. For nuclear tests identify major components to be isolated or vented to preclude unnecessary pressurization.

NOTE: ALL VALVES WITHIN THE TEST BOUNDARIES MUST BE IDENTIFIED AND THEIR POSITION (OPEN/SHUT) DURING THE TEST ANNOTATED.

NOTE: IF DRAWINGS OR ADDITIONAL INFORMATION IS REQUIRED TO SUPPLEMENT THIS REPORT, EACH DRAWING, ETC., WILL BE NUMBERED AND AUTHENTICATED WITH THE SIGNATURE BY THE CRAFTSMAN AND QAI MAKING UP THE REPORT.

NOTE: LOCAL EXCEPTIONS TO GAGE RANGE AND OR INCREMENTS WILL BE APPROVED BY AN INDIVIDUAL WITH A TECHNICAL WARRANT.

NOTE: SHIPS, FLEET MAINTENANCE ACTIVITIES AND REGIONAL MAINTENANCE CENTERS MANAGED BY UNITED STATES FLEET FORCES COMMAND OR TYCOMS SHALL DISREGARD THE BLOCK 8 DIAMOND WHEN TESTING IS PERFORMED BY AN ACTIVITY OTHER THAN THE ACTIVITY PERFORMING REPAIR. THE ACTIVITY PERFORMING THE TESTING SHALL COMPLETE THE DIAGRAM REQUIRED BY BLOCK 8.

BLOCK 9 - GAGE DATA

Enter the primary and backup gage data.

BLOCK 10 - REQ'D TEST PRESSURE (PSIG) AND TEST DURATION

Enter the required test pressure and test duration. If listing the test pressure would classify the CWP enter "J", "H", Item 1 of Ref (a), etc. as appropriate from the applicable reference instead of classifying the document.

BLOCK 11 - ACTUAL TEST PRESSURE (PSIG) AND TEST DURATION

Enter the actual test pressure and the duration the test pressure was applied. Test duration will include the required test period and the time required to complete the inspection. If listing the test pressure would classify the CWP enter "J", "H", Item 1 of Ref (a), etc. as appropriate from the applicable reference instead of classifying the document.

BLOCK 12 - TEST RESULTS

- a. Check "SAT" block, if all inspections specified by Block 7 are complete and satisfactory.
- b. Check "UNSAT" block, if test results are unsatisfactory. Identify the specific inspection and reason for failure in the remarks section.

NOTE: IF A SATISFACTORY TEST CANNOT BE ACHIEVED, A DFS FOR NON-NUCLEAR TESTS OR LAR FOR NUCLEAR TESTS MUST BE PROCESSED IN ACCORDANCE WITH PART 1 CHAPTER 8 OF THIS VOLUME OR THE TASK MUST BE REWORKED AND RETESTED.

BLOCK 13 - REMARKS

Remarks pertinent to this test will be entered in this block.

BLOCK 14 - CERTIFICATION

PERFORMED BY

Person performing the test print name, enter signature, badge number and date signifying accuracy of data recorded.

INSPECTED BY

QAI/Shipyard Representative print name, enter signature, badge number and date verifying the accuracy of test results recorded and inspection performed satisfactory.

DROP TEST RECORD

QA FORM 27 (9/05)

Planning shall fill in blocks identified by a ♦ prior to issuing

♦1. SHIP	HULL NO.	♦2. JCN	♦3. LWC/SHOP	♦4. CWP/REC SER NO.	♦5. SYSTEM/COMPONENT
♦6. REFERENCES (TEST REFERENCE MANUAL(S) AND/OR OTHER APPLICABLE REFERENCES)					
A.		B.		C.	
♦7. REQUIRED TEST AND INSPECTION – SPECIFY TEST REQUIREMENTS [i.e. TYPE OF TEST, SPECIAL VALVE POSITIONS, DURATION, ACCEPTANCE CRITERIA, JOINTS TO BE TESTED (IF ENTIRE COMPONENT/SYSTEM IS TESTED, SO STATE)].					
♦8. DIAGRAM OF TEST AREA INCLUDING GAGS AND BLANKS INSTALLED, VALVE POSITIONS, INITIAL & FINAL TEMPERATURE (IF APPLICABLE) AND TEST GAGES/INSTR USED (DOCUMENT BELOW).					
9. GAGE DATA	RANGE (PSIG)	SERIAL #	CAL DUE DATE		
PRIMARY					
BACKUP					
10. a. REQUIRED TEST PRESSURE (PSIG): b. ACTUAL TEST PRESSURE:		a.	b.	11. a. FINAL PRESSURE AT END OF TEST: b. ACTUAL DURATION:	
				a.	b.
12. ALLOWABLE PRESSURE DROP% IN MINUTES/HOURS			13. FINAL PRESSURE DROP CORRECTED FOR TEMPERATURE CHANGE		
14. TEST RESULTS (CHECK ONE):				<input type="checkbox"/> SAT	<input type="checkbox"/> UNSAT
15. REMARKS:					
16. CERTIFICATION					
PERFORMED BY:			INSPECTED BY:		
CRAFTSMAN SIGNATURE		DATE	QA INSPECTOR/SHIPYARD REP SIGNATURE/BADGE NO.		DATE

(This Page Intentionally Left Blank)

QA FORM 27 INSTRUCTIONSDROP TEST RECORD

PURPOSE: To document drop tests accomplished on piping systems or portions of a system to recertify the system after maintenance actions have been accomplished.

PROCEDURE: The numbered blocks on QA form 27 correspond with the instructions listed below. Any block not used will be marked NA. The planning organization shall fill in blocks identified with the diamond symbol, the Required Initial Test Pressure of Block 10 and the maximum allowable pressure drop in Block 12 prior to issuing the CWP.

BLOCK 1 - **SHIP HULL NO.**

Enter ship's name and hull number.

BLOCK 2 - **JCN**

Enter the JCN.

BLOCK 3 - **LWC**

Enter the shop number for the LWC.

BLOCK 4 - **CWP/REC SER NO.**

Enter the CWP/REC serial number or enter N/A if no CWP/REC is required. Do not list the CWP/REC revision.

BLOCK 5 - **SYSTEM/COMPONENT**

Enter the name of the system and/or component (i.e., FWD ESCAPE TRUNK) to be tested.

BLOCK 6 - **REFERENCES**

Enter the applicable test reference and/or other applicable references (e.g., drawing number and revision used to obtain the required test pressure and conducting of the test).

NOTE: ENTER "S9505-AF-MMA-010/PIPING SYSTEMS" WHICH PROVIDES REQUIREMENTS FOR SHIP'S FORCE TO SET-UP AND CONDUCT TESTING.

BLOCK 7 - **REQUIRED TEST AND INSPECTION POINTS**

Enter the specific test requirements, including inspection points, necessary to recertify the work. FMAs will fill in this block and then provide the QA form 27 to Ship's Force so they can prepare the test procedure to retest FMA work.

BLOCK 8 - **DIAGRAM OF TEST AREA**

Enter a diagram of the test area. Be specific. Include such things as relief valve locations, gage locations, blanks, gags, valve positions, initial and final temperature (if applicable), etc. The QAI will verify the diagram prior to performance of the test. For nuclear tests identify major components to be isolated or vented to preclude unnecessary pressurization.

NOTE: ALL VALVES WITHIN THE TEST BOUNDARIES MUST BE IDENTIFIED AND THEIR POSITION (OPEN/SHUT) DURING THE TEST ANNOTATED.

NOTE: IF DRAWINGS OR ADDITIONAL INFORMATION IS REQUIRED TO SUPPLEMENT THIS REPORT, EACH DRAWING, ETC., WILL BE NUMBERED AND AUTHENTICATED WITH THE SIGNATURE BY THE CRAFTSMAN AND QAI MAKING UP THE REPORT.

NOTE: LOCAL EXCEPTIONS TO GAGE RANGE AND OR INCREMENTS WILL BE APPROVED BY AN INDIVIDUAL WITH A TECHNICAL WARRANT.

NOTE: SHIPS, FLEET MAINTENANCE ACTIVITIES AND REGIONAL MAINTENANCE CENTERS MANAGED BY UNITED STATES FLEET FORCES COMMAND OR TYCOMS SHALL DISREGARD THE BLOCK 8 DIAMOND WHEN TESTING IS PERFORMED BY AN ACTIVITY OTHER THAN THE ACTIVITY PERFORMING REPAIR. THE ACTIVITY PERFORMING THE TESTING SHALL COMPLETE THE DIAGRAM REQUIRED BY BLOCK 8.

BLOCK 9 - GAGE DATA

Enter the primary and backup gage data.

BLOCK 10a - REQUIRED TEST PRESSURE

Enter the required test pressure (psig).

BLOCK 10b - ACTUAL TEST PRESSURE

Enter the actual test pressure.

BLOCK 11a - FINAL PRESSURE AT END OF TEST

Record final pressure reading when the required test time is completed.

BLOCK 11b - ACTUAL DURATION

Enter the actual duration of the test.

BLOCK 12 - ALLOWABLE PRESSURE DROP % IN MINUTES/HOURS

Enter the allowable pressure drop as a percentage of the test pressure in minutes or hours. Cross out time measure not used.

BLOCK 13 - FINAL PRESSURE DROP CORRECTED FOR TEMPERATURE CHANGE

Record final pressure drop calculated with corrections for temperature change in the same units as Blocks 11 and 12.

BLOCK 14 - TEST RESULTS

Check "SAT" block, if all inspections specified by Block 7 are complete and satisfactory.

Check "UNSAT" block, if test results are unsatisfactory. Identify the specific inspection and reason for failure in the remarks section.

NOTE: IF A SATISFACTORY TEST CANNOT BE ACHIEVED, A DFS FOR NON-NUCLEAR TESTS OR LAR FOR NUCLEAR TESTS MUST BE PROCESSED IN ACCORDANCE WITH PART I CHAPTER 7 OF THIS VOLUME OR THE TASK MUST BE REWORKED AND RETESTED.

BLOCK 15 - REMARKS

Enter any comments pertinent to the test.

BLOCK 16 - CERTIFICATION

PERFORMED BY

Person performing the test print name, enter signature and date signifying accuracy of data recorded.

INSPECTED BY

QAI/Shipyard Representative print name, enter signature, badge number and date verifying the accuracy of test results recorded and inspection performed satisfactory.

(This Page Intentionally Left Blank)

QA FORM 28 INSTRUCTIONSSHOP TEST RECORD

PURPOSE: To document the OQE required when performing in-shop testing.

PROCEDURE: The numbered blocks on QA form 28, SHOP TEST RECORD, correspond with the instructions listed below. The form will become part of the TWD, and the responsibilities for filling out the form are as follows:

- a. Planning shall fill in blocks identified by a ♦ prior to issuing QA form 28.
- b. QAI will complete Block 11 (when required by this manual).
- c. QAS shall complete Block 12 for SUBSAFE/SOC Testing.
- d. Shop Supervisor shall complete Block 12 for other testing.

BLOCK 1 - SHIP/HULL

Enter the ship's name and hull number, or enter the appropriate rotatable pool system designator (e.g., TRIPER, CCRP, AERP, SSN 688CL, etc.).

BLOCK 2 - JCN/Job Order & Key-Op

Enter the Job Control Number (e.g., 20884-EM01-2947, 3872556103/R01). Naval Shipyards enter Job Order and KeyOp.

BLOCK 3 - LWC/SHOP

Enter the shop number of the Lead Work Center/or the Assigned Key Shop.

BLOCK 4 - CWP/REC SERIAL NO.

Enter the CWP/REC serial number if applicable, otherwise NA. Do not list the CWP/REC revision.

BLOCK 5 - SYSTEM/COMPONENT/ROTATABLE POOL SER NO.

Planner enter the noun name of the system and component, or the name of the component being tested (e.g., ASW-80/81). If the record is for testing rotatable pool material, Planner or Craftsman enter the serial number of the material when available or known.

BLOCK 6 - TEST REFERENCES

Enter the document number that provides the test requirements other than those test requirements listed in the Task Group Instruction, JCN or Job Order listed in Block 2: (e.g., SUBMEPP Maintenance Standard or Technical Repair Standard (SMS/TRS) Revision and Change, Task Group Instruction, Technical Manual and Section No., Assembly Drawing Number & Revision, etc.).

BLOCK 7 - TEST GAGE RANGE/TEST INSTRUMENT USED, SERIAL NO. & CALIBRATION DUE DATE

Enter each test gage and each instrument (normally enter the gage or instrument range) used for testing any item or component. Enter the serial number of the gage or instrument, and Calibration Due Date. If the items are part of a computerized test stand, indicate the serial number of the test stand.

BLOCK 8 - RELIEF VALVE SET POINT

Enter the relief valve set point and verification signature of person setting the relief. The signature(s) in Block 8 include that the test was accomplished with the proper calibrated test equipment. Use Block 10 for additional space. If listing the test pressure would classify the CWP enter "J", "H", Item 1 of Ref (a), etc. as appropriate from the applicable reference instead of classifying the document.

BLOCK 9 - TEST REQUIREMENTS & RESULTS

Planner enter all test requirements Test Procedure/Type of Test/Paragraph, required valve position and entry point (if not described by Test procedure, SUBMEPP Maintenance Standard or Technical Repair Standard, that is invoked in the Technical Work Document), Required Medium, Required Pressure, Minimum Duration, Allowable Leakage and any other test requirements. NA blocks if not applicable. Enter other test requirements, if applicable, in Block 9 or the Remarks Block 10. If listing the test pressure would classify the CWP enter "J", "H", Item 1 of Ref (a), etc. as appropriate from the applicable reference instead of classifying the document.

NOTES:

1. For Scope of Certification Tests requiring Divers Air Clean Requirements, Planning add a SOC Cleanliness Maintained Test Requirement (annotate to verify that system cleanliness has been maintained) with signature, badge number and date for the craftsman.
2. For hydraulic actuators with relief valves which must be removed for the hydrostatic or tightness tests, relief valve reinstallation shall be documented in one of the following manners:
 - a. On a QA form 34A
 - b. On a QA form 17C
 - c. Planning: Enter "Relief valve removed for test and reinstalled after test" in the QA Form 28 Remarks block and provide an area for the mechanic to record the following attributes for all new material installed:
 - Piece number
 - Drawing number or reference letter
 - Part description
 - Quantity
 - LOE

Mechanic: Record the data for each attribute listed above for all new material installed. Provide signature, badge number and date for Objective Quality Evidence that the relief valve and o-ring were reinstalled after the test; all new material meets specified requirements, is installed and listed below; and after verifying existing material is acceptable for re-use and is installed.

3. For hydraulic 2 position valve orientation, enter a requirement in the Remarks block for the operation of the valve ("PRESSURIZE C1 TO OPEN, PRESSURIZE C2 TO CLOSE"), signature, badge number and date for Objective Quality Evidence of the proper operation if not already identified in the Maintenance Standard Test requirements.

Test or Production personnel enter the results of testing (Actual Medium Used, Actual Pressure, Actual Duration (including inspection time), Actual Leakage, and the results of testing (SAT or UNSAT) and enter signature, badge number and date. Signature also verifies that test instrumentation was calibrated, the correct test configuration was used to perform the test and any sequencing (e.g., valve cycling) listed in Block 9 or 10 was accomplished. If the results are unsatisfactory, enter the deficiency report number or DL serial number which documents the test deficiency and/or work accomplished to correct the deficiency. If unsat, the craftsman will report the condition on a Deficiency Form or document the re-work on the applicable QA Form. Further testing of the component should not continue until the unsat condition is resolved. NA blocks if not applicable.

NOTES:

1. For Test Procedure steps that require testing from both directions, annotate/record Actual Pressure, Duration, Leakage, and Results for each direction.
2. For SOC work, valves that act as a boundary closure between two distinct operating pressure systems or subsystems shall have the test pressure of each port identified by a temporary tag when testing is performed in a shop or on a test bench, when the valve configuration is such that it could be installed two ways into the system,

and the ports are not otherwise marked or identified. The temporary tags can be removed after the valves have been installed. The purpose of the tag is to alert personnel of the correct orientation of the valve into the system. (P9290 Appendix J, Paragraph J8 refers).

Enter any remarks in Block 10. Remarks shall be accompanied by a signature, badge number and date, if not part of the original technical direction.

BLOCK 10 - REMARKS

Enter any remarks. Identify which test the remarks apply to. Remarks shall have a signature, badge number and date except where the entry is pre-printed on the form by Planning, unless the pre-printed entry requires signature for OQE. Initials may be entered in lieu of an employee's signature and badge number, if a corresponding employee's signature and badge number appears elsewhere on the same page.

BLOCK 11 - QA INSPECTOR/SHOP SUPERVISOR SIGNATURE/BADGE NO

Quality Assurance Inspector or Shipyard Representative enter signature, badge number and date verifying the completeness of the data recorded in Blocks 7 through 9 and that the data agrees with the listed requirements (as implemented by local Shipyard instruction).

BLOCK 12 - QAS SIGNATURE/BADGE NO.

For SUBSAFE or SOC components only, QAS or cognizant QA representative as defined by local instructions, will sign, enter badge number and date in this block to indicate the completeness of the entries.

For other components, the Production Shop Supervisor shall sign that the records have been reviewed for completeness.

(This Page Intentionally Left Blank)

QA FORM 34 INSTRUCTIONSJOINT/COMPONENT TORQUE AND ASSEMBLY RECORDREFERENCES:

- (a) NAVSEA 389-0317 - Procedures for Maintenance and Repair of Naval Reactor Plants (Nuclear)

NOTE: PLANNING SHALL FILL IN BLOCKS IDENTIFIED BY A ♦ PRIOR TO ISSUING

PURPOSE: To provide a standard form to document the assembly and torquing of Nuclear Level I system piping joints, SUBSAFE, and SOC mechanical joints and assemblies listed in the requirements below. All other mechanical joints requiring assembly OQE, not listed below, may be documented on a QA form 34A.

REQUIREMENTS:

1. Torque documentation is required for the following joints and must be documented on a QA form 34.

- a. All nuclear Level I system piping joints (i.e., flanges) governed by Chapter 14 of reference (a).
- b. All joints assembled as a Controlled Assembly.

NOTE: ALTHOUGH JOINTS FOR CONTROLLED ASSEMBLIES AND NUCLEAR LEVEL I SYSTEM PIPING JOINTS ARE CERTIFIED ON THIS FORM, TORQUE VALUES MAY NOT APPLY TO ALL JOINTS.

c. SUBSAFE:

- (1) Sea Connected/Seawater bolted pressure boundary joints NPS 1/2 inch and larger from the inboard joint of the backup valve (or equivalent) outboard (i.e., Hull Integrity (HI) joints).
- (2) All sea connected/Seawater bolted pressure boundary piping and component joints from systems NPS 4 inches and larger inboard of the inboard joint of the backup valve.
- (3) Electrical Hull Fitting Installation joints including EHF to pressure hull and EHF Shore Power joints.

NOTE: BOLTED PRESSURE BOUNDARY JOINTS ARE DEFINED AS JOINTS WHICH UTILIZE BOLTS, NUTS, STUDS, STUD-BOLTS, OR SCREWS TO JOIN TWO PRESSURE BOUNDARY PARTS.

d. Scope of Certification:

- (1) All SOC bolted pressure boundary piping and SOC component joints.
- (2) In-line SOC union piping joints with torque values specified on drawing or document.

PLANNING THE SCOPE OF A QA 34 FORM: In order to support the execution process, it is necessary to properly limit the scope of Assembly Records. The following rules are provided to ensure proper breakdown:

- a. Each shipboard piping joint shall have a unique joint record consisting of separate Block 9 entries.
- b. All Level I material must be traceable to a specific joint. To ensure unique joint traceability, if any identical Level I parts are used in multiple joints within an assembly (normally this applies to fasteners), the craftsman will annotate which joint (Block 9A, 9B, etc.) the material was installed in.
- c. For complex assemblies (e.g., Shaft Seal installations), assembly records should be scoped to support testing evolutions.

PROCEDURE: The numbered blocks on QA form 34 correspond with instructions listed below. Any block not used will be marked N/A. Planning shall fill in blocks identified by a ♦ prior to issuing the CWP. For QAI signatures, the planner will determine the need for a QAI prior to the start of the job. If no QAI is required, the planner will enter NA in the QAI signature block.

TOP OF FORM - PAGE _____ OF _____

Enter page numbers.

BLOCK 1 - SHIP/HULL NO.

Planner enter the ship's name and hull number, or enter the appropriate rotatable pool system designator (e.g., TRIPER, CCRP, AERP, SSN 688CL, etc.).

BLOCK 2 - JCN

Planner enter the Job Control Number (JCN).

BLOCK 3 - LWC/SHOP

Planner enter the lead shop assigned to assemble the joint (e.g., X31, X58, X56).

BLOCK 4 - CWP/REC SER. NO.

Planner enter the CWP/REC serial number or enter NA if no CWP/REC is required. Do not list the CWP/REC revision.

BLOCK 5 - SYSTEM/COMPONENT/ROTATABLE POOL SER NO.

Planner enter the noun name of the system and component (if applicable), (e.g., MSW-25). For Rubber Insert Sound Isolation Coupling (RISIC) enter the Selected Record Drawing (SRD) Line Item No. If Record is for in-shop restoration of rotatable pool material, enter the serial number of the material if known.

NOTE: ROTATABLE POOL SERIAL NUMBERS MAY BE ENTERED BY THE CRAFTSMAN IF NOT ENTERED BY THE PLANNER.

BLOCK 6 - REFERENCES

Planner enter all references used to identify component parts, joint, material and assembly information. Include revision letter and, when applicable, the assembly number (e.g., Assy D, Assy RA, etc.). Revisions for technical manuals are not required. If joint numbers are assigned via a sketch in a TWD or Planning sketch, include the TWD or Planning sketch number. Include both the assembly drawing and electrical holes assignment drawing for Electrical Hull Fittings. NAVSEA Technical Manual S9502-AM-GYD-010 may be abbreviated as "GYD-010" if needed.

BLOCK 7 - NEW MATERIAL

Craftsman

PC NO: Enter the piece numbers of parts. List only the new parts being installed. New body bound studs documented on a QA form 17SI should not be documented on a QA form 34.

REF: Enter the letter corresponding to the reference listed in Block 6 that provides the material specification or assembly information for the piece listed in the "PC NO." block.

JOINT BLK ID: Enter the alphanumeric designator corresponding with the particular Block 9 or Block 14 entry (9A, 9B, 14A, 14B, etc.) that identifies the joint where the material is installed.

DESCRIPTION: Describe all new parts associated with the assembly or joint. For fasteners and nuts, include diameter and thread (e.g., bolt, 1/2"-13; stud, 1/2"-12; SHCS, 1/2"-13, etc.). Record shim thickness when shims are installed (not required for shims installed as a part of an epoxy repair).

NOTE: IF A PORTION OF A NEW VALVE OR COMPONENT IS USED TO REPLACE PARTS (E.G., BONNET AND DISC ASSEMBLY), ENTER A DESCRIPTION OF THE PART OR ASSEMBLY OF PARTS AND DOCUMENT THE LEVEL I NUMBER OF THE NEW VALVE OR COMPONENT IN THE IDENT SECTION. LIST THE PARTS THAT THE ASSEMBLY CONSISTS OF IN THE REMARKS BLOCK (A SINGLE COMPONENT MAY BE LISTED IN BLOCK 7) WITH A NOTE THAT THE PART(S) WERE TAKEN FROM THE NEW VALVE OR COMPONENT.

QTY: Record quantity of new material installed. Each quantity must be unique to one Block 9 joint.

LOE: Identify the Level of Essentiality (MIC Level). The material control level shall be as identified by craftsman. Example: LI, NA. For SOC material, enter the appropriate Material Control Division (A, B, or C).

IDENT: Enter the marking on the part or on the packaging/container/tag (when the part is not marked) as shown in Table 1.

CRAFT INT: Craftsman: Installing craftsman enter initials for material installed. The initials shall correspond to the related Block 9 craftsman’s signature unless otherwise noted with a corresponding signature elsewhere on the form (e.g., Remarks block entry and signature).

NOTE: IF THE CRAFTSMAN INSTALLING THE MATERIAL IS OTHER THAN THE CRAFTSMAN SIGNING FOR JOINT DATA IN BLOCK 9 OR BLOCK 14, A CORRESPONDING SIGNATURE, PRINTED NAME AND DATE SHALL BE ENTERED IN THE REMARKS BLOCK.

TABLE 1- DOCUMENTATION REQUIREMENTS	
Material Control Level	Required Information
Level I Material Other Than Fasteners	MIC Number and any other traceability number, including any local traceability number (e.g., PNSY MLN – examples Z142, AB12).
Level I Fasteners	NOTE: THE INFORMATION ENTERED FOR FASTENERS MAY NEED TO INCLUDE INFORMATION FROM BLOCKS 3 AND 8 FROM QA FORM 1. DO NOT ENTER THE PNSY TRACE NUMBER FROM BLOCK 3 OF THE QA FORM 1. Document the markings from the fastener to include either: (1) The color code and the heat/lot number, material type, and manufacturer’s symbol (for nuts containing a self-locking insert, the color of the insert is the manufacturer’s symbol). (2) The MIC number (when MIC number is on the fastener or on the individual tag for some fasteners).
Controlled Structural Material And SOC Control Division “A” Material	Traceability Number
SOC Control Division “B” Material	Markings providing identification to material type or specification
AERP And Other Rotatable Pool Material (688 Class, TRIPER, Etc.)	Enter the appropriate rotatable pool serial number (e.g. RP-148A, 4810-013-5812-A3-0113, TIN -292-11893, etc.)
Transferred And Cannibalized Material	Enter the Equipment Removal List No. or other material History/ Traceability number (ERL# XXXX, SSBN-600 EHF #24, etc.)
Other Material Within The LEVEL I/SUBSAFE Boundary And SOC Control Division “C” Material	1. Enter at least one of the following documentation attributes: a. Stock Number (from package/container) b. Part Number (from package/piece) c. Part Number and associated Manufacturing Work Procedure (for manufactured items) d. Local Traceability Number (from piece/tag) e. Drawing and Piece Number (from piece/tag) f. Generic, MIL-SPEC, or Material Specification Marking (from piece) g. NDT record numbers or test results for items verified by generic material testing. 2. For SOC components only: Enter the stock number of the “O-ring lubricant or any sealant used during assembly.

BLOCK 8 - BLUE/CHALK CHECK AND/OR VALVE BALL COMPRESSION DATA

NOTE: A QA-34 FORM IS NOT REQUIRED TO BE GENERATED SOLELY FOR CAPTURING BLOCK 8 DATA IF THE REMAINDER OF THE COMPONENT IS TO BE ASSEMBLED USING A QA-34A FORM. USE A QA-17 OR OTHER APPROPRIATE METHOD.

(PLANNING) A documented blue/chalk check or valve ball compression check is required for all controlled assemblies and is allowed by the DDGOS in lieu of a seat tightness test for welded in-line valves and components where a seat tightness test is not practical. Enter an X in the applicable NA box when Blue/Chalk Check or Valve Ball Compression is not applicable. When a Valve Ball Compression check is required, enter the required stack height and ball cavity dimensions. These dimensions should include maximum and minimum requirements.

(CRAFTSMAN) Record actual ball/seat stack heights and cavity dimensions when Planning has provided the required dimensions. If more than one blue check is required, enter additional checks in Remarks. For hull and back up valves where more than one ball/seat stack height dimension is required, enter in the following manner:

(3.213/3.567) where the first dimension is for one ball/seat combination and the second dimension is for the other one. Identify each dimension to its associated valve. Sign, date and print name after satisfactory accomplishment of a Blue/Chalk Check or Valve Ball Compression check.

BLOCK 9 - **JOINT DATA FOR JOINTS REQUIRING TORQUE DOCUMENTATION**

Torque documentation is required for the following joints:

NOTE: WHEN MULTIPLE JOINTS ARE DOCUMENTED ON ONE QA 34 FORM, ENTER A SUCCESSIVE LETTER FOR EACH BLOCK 9_ USED (E.G., 9B, 9C, ETC.).

NOTE: THIS BLOCK MAY BE USED FOR SPECIFIC ATTRIBUTES THAT ARE NOT COVERED BY THE STANDARD ATTRIBUTES ON THE FORM.

JOINT ID/JOINT TYPE: Planner enter the joint identification number including joint type (e.g., ASW-5744 F). For joint types, use “F” for flanged bolted joints, “U” for union joints, and “S” for screw joints. When a joint identification number is not available, a joint description (e.g., Tailpiece-to-Body (F)) shall be used. Locally assigned joint numbers may be used when a joint description is not practicable and clarity is required. When additional attribute(s) applies to a component (e.g., hatches, etc.) that are not covered by the attributes already on the form, list the attribute and location (applicable reference) for the acceptance criteria (e.g., TWD, technical manual, etc.). For hatches, at a minimum list the “Seat Clearance Measurement”.

JOINT REF: Planner enter the letter corresponding to the reference listed in Block 6 that identifies where the joint number or description information is found (e.g., Mapping Diagram, Drawing, Tech Manual, Work Procedure, etc.).

REQ THREAD LUBE: Planner enter the type(s) of thread lubricant(s) that are authorized (e.g., MOLYKOTE P37, Fel-Pro C5A, etc. or options (e.g., MOLYKOTE P37 or Fel-Pro C5A)). Enter “None” if no lubricant is required.

APPLIED THREAD Craftsman enter the thread lubricant actually used during assembly.

LUBE: Enter “None” if no lubricant was used.

HI FSTNR: Planner indicate (Yes/No) whether the joint contains Hull Integrity Male Fasteners. When “NO” is checked, enter “NA” in the “EXISTING HI MALE FASTENER MARKING” block.

EXISTING HI MALE FASTENER MARKING: (Craftsman) When the “HI FSTNER” block is marked “Yes”, record the quantity of reused/existing male fasteners and the symbols of recognizable significance, as required by Part I, Chapter 5, paragraph 5.4.3.b(2) of this volume (e.g., 6 ea. .K., 2 ea. unmarked).

NOTE: (CRAFTSMAN) IF HULL INTEGRITY MALE FASTENERS (DRIVEN STUDS) ARE UNMARKED, ILLEGIBLE, OR THE SYMBOLS ARE NOT RECOGNIZABLE PER CRITICAL INSPECTION REQUIREMENTS OF PART I, CHAPTER 5, PARAGRAPH 5.4.3.b(2) OF THIS VOLUME, AND THEY WERE NOT REMOVED FROM THE HULL INSERT OR COMPONENT BODY:

- a. DOCUMENT THE QUANTITY
- b. ENTER THE WORDS “STUDS NOT REMOVED” IN THE REMARKS BLOCK
- c. REQUEST QAI PERFORM A GENERIC MATERIAL IDENTIFICATION TEST (E.G., ACID SPOT TEST).

NOTE: (QUALITY ASSURANCE INSPECTOR) PERFORM A GENERIC MATERIAL IDENTIFICATION TEST ON HULL INTEGRITY MALE FASTENERS (DRIVEN STUDS) THAT ARE UNMARKED, ILLEGIBLY MARKED, OR MARKED WITH SYMBOLS THAT ARE NOT RECOGNIZABLE PER CRITICAL INSPECTION REQUIREMENTS OF PART I, CHAPTER 5, PARAGRAPH 5.4.3.b(2) OF THIS VOLUME AND FOR WHICH THE CRAFTSMAN HAS ANNOTATED “STUDS NOT REMOVED”. MARK STUDS THAT ARE IDENTIFIED AS HAVING THE CORRECT MATERIAL

(I.E., .K. OR KM). IF THE STUDS CANNOT BE MARKED DUE TO SIZE/CONFIGURATION, ETC., ENTER THE RESULTS OF THE GENERIC MATERIAL IDENTIFICATION TEST IN THE REMARKS BLOCK.

Planner enter "NA" if not an HI joint or if no existing pressure boundary male fasteners are to be reused.

STUD ROTATION: Planner enter an X in the NA box of the Stud Rotation block when not applicable (e.g., when joint does not contain studs).

Craftsman record SAT after verifying all set studs to be tight during nut installation and torquing in accordance with Part I, Chapter 5, paragraph 5.4.7 of this volume.

- a. Anaerobic Stud Bonding Inspection - Newly Installed Studs. The following test procedures shall be performed to ensure proper bonding after curing has been completed:
 - (1) Mark the end of the studs using a felt tip marker, paint pen or other appropriate marking pen by making a line in the direction of the center of the bolt circle.
 - (2) All newly installed studs shall be tested using one of the following methods. Either method may be used unless otherwise specified. Both methods utilize the same lubricant as required for final assembly of the joint. Studs shall not be restrained from turning during the test by any method other than the locking compound in the set end of the stud.
 - (3) Torque Method. Apply the minimum breakaway torque on each newly installed stud per TABLE 2. Double nuts or a stud extractor (Colette) shall be used to apply the required torque. Acceptance criteria is per paragraph b.
 - (4) Self Locking Nut Method. Apply torque to each newly installed stud by installing and removing an unused self-locking nut per NASM 25027 or commercial spec IFI-100/107 with plastic elements. Install the nut to a point of stud thread protrusion that is at least 3 threads beyond the self-locking insert. Acceptance criteria is per paragraph b.
- b. The assembly is considered acceptable if there is no turning of the stud during the Breakaway Torque or Self-Locking Nut check. The assembly may also be considered acceptable if a slight initial turning motion (up to 1/4 turn) of the stud is observed, and no further turning motion is observed during torquing or nut installation/removal. (A small turning of the set stud represents a breaking or powdering of the locking compound which actually increases resistance to further turning motion.) Report any failures to Engineering.
- c. In some cases, work authorizing TWDs may specify that studs set with an anaerobic locking compound in submarine hull integrity applications be subjected to an ultraviolet light inspection. Engineering requests for this test will be based on accessibility and ability to view the stud hole. When ultraviolet light inspection is specified, properly installed anaerobic compounds should appear as a red dye and should fully encircle the stud. This is considered to be an extra line of defense above and beyond performance proof testing of paragraphs a.(1) through b. above. Under no circumstances should ultraviolet light inspection be used as a substitute for performance proof testing.
- d. In-Service Anaerobic Stud Rotation. Rotation of in-service Class 3 studs with anaerobic locking compound on subsequent tightening to the required torque is permissible, as long as the following check is performed:
 - (1) If the stud does rotate up to 1/4 turn during in-service nut tightening, then back off the nut 1/4 turn before continuing to torque it.
 - (2) If the stud does not rotate while backing off the nut or when torquing the nut afterwards, the stud is acceptable as long as the stud does not violate the stand-off requirement for that application. In this case, the stud rotation represents further breaking or powdering of the locking compound which increases resistance to any further turning motion.
 - (3) If the stud rotates while backing off the nut, rotates when torquing the nut afterwards or violates the stand-off requirement for that application, the stud must be removed and replaced. In this case, the stud rotation represents locking compound failure.

NOTE: IF ANY STUD ROTATION CAUSES THE STUD STAND-OFF TO VIOLATE THE STAND-OFF REQUIREMENTS FOR THAT APPLICATION, THEN THE STUD MUST BE REMOVED. THE STUD MAY BE CLEANED AND REINSTALLED IF IN ACCEPTABLE CONDITION OR REPLACED BY A NEW STUD.

TABLE 2 - Resistance Test Breakaway Torque Values for Anaerobic Locking Compounds

STUD SIZE	MIN TORQUE (FT-LBS.)	STUD SIZE	MIN TORQUE (FT-LBS.)	STUD SIZE	MIN TORQUE (FT-LBS.)
1/4	2.5	5/8	25	1-3/8	100
5/16	5	3/4	33	1-1/2	115
3/8	6.7	7/8	50	1 3/4-5	150
7/16	8.3	1	67	1 3/4-8	160
1/2	12.5	1-1/8	75	2	180
9/16	17	1-1/4	83	2-1/4	215

FASTENER SIZE/TYPE: Planner enter the type, size and thread of the male fastener (e.g., 1-1/4"-7 Stud, 9/16"-18 SHCS, 3/4"-10 bolt, etc.). **Planner enter "N/A" if the joint being assembled does not contain threaded fasteners (bolts, studs, or stud-bolts, bolt-studs and nuts).**

REQUIRED TORQUE AND TOLERANCE: Planner enter the torque and tolerance required for the component or fastener. Mark the appropriate block (in-lbs or ft-lbs). When special tightening/assembly instructions apply in lieu of torque, enter tightening/assembly instructions and reference document/drawing; use Remarks if additional space is required.

TORQUE REF: Planner enter the letter of the reference listed in Block 6 that identifies where the torque value was obtained, including paragraph or table when applicable.

AVERAGE RUNNING TORQUE: Craftsman enter the average running torque as measured. Mark the appropriate block (in-lbs or ft-lbs).

(Planning/Craftsman) Enter "N/A" in the block when self-locking fasteners are not being used.

NOTE: RUNNING TORQUE DOES NOT NEED TO BE TAKEN INTO ACCOUNT FOR FASTENERS GREATER THAN 5/8 INCH DIAMETER UNLESS SPECIFIED IN THE TWD. THE INTENT IS TO ENSURE PROPER TORQUE IS APPLIED, TAKING RUNNING TORQUE INTO CONSIDERATION WHEN IT IS A SIGNIFICANT FACTOR WITH REGARD TO THE FINAL TORQUE. IF RUNNING TORQUE DOCUMENTATION IS NOT REQUIRED BY THE TWD FOR FASTENERS GREATER THAN 5/8", PLANNING SHOULD ANNOTATE THE BLOCK "NR" FOR NOT REQUIRED.

NOTE: CLICKER STYLE TORQUE WRENCHES AND HYTORC DEVICES ARE NOT TO BE USED TO MEASURE RUNNING TORQUE.

NOTE: THE AVERAGE RUNNING TORQUE MAY BE OBTAINED BY USING THE SAME DIAL TYPE TORQUE WRENCH THAT WILL BE USED FOR MEASURING THE FINAL TORQUE. A LOW RANGE DEVICE IS NOT REQUIRED AND RUNNING TORQUE DOES NOT HAVE TO FALL WITHIN THE 20% TO 90% SCALE REQUIREMENT. IF RUNNING TORQUE IS NOT MEASURABLE USING THIS DEVICE, ENTER "0" (ZERO) FOR THE AVERAGE RUNNING TORQUE.

NOTE: DOCUMENTATION OF THE TORQUE WRENCH USED FOR DETERMINING THE AVERAGE RUNNING TORQUE IS NOT REQUIRED. IF A DIFFERENT WRENCH IS USED TO TAKE THE RUNNING TORQUE BECAUSE THE FINAL TORQUE IS MEASURED WITH A CLICKER STYLE OR HYTORC DEVICE, THEN THE TORQUE WRENCH DATA MUST BE RECORDED.

FINAL TORQUE: Craftsman record the final torque observed on the torque device. The final torque observed shall be the average running torque, as required, plus the required torque. Mark the appropriate block (in.-lbs or ft-lbs). Request QAI to verify final torque by direct observation for all Controlled Assemblies and hull integrity pressure boundary joints which contain Hull Integrity fasteners (as required in Table 3). In the event that a multiplier or HYTORC machine is used, place an asterisk or other symbol in this block and refer to the remarks block. In the remarks block add a statement such as “Torque multiplier was used, actual torque reading was XXX PSI. This converts to a torque value of XXX Ft-lbs.” When a combination of torquing methods (e.g., torque wrench, turn-of-the-nut method, etc.) is used for a single joint, record the final torque applied, and document the alternate torquing process. Record the quantity of fasteners that were tightened using the alternate method. When special tightening/assembly instructions apply in lieu of torque, as identified in the required torque block, document the actual special tightening/assembly applied to the joint (tightened, wrench tight, cap installed, etc.).

TORQUE DEVICE/ INSTRUMENT USED: Craftsman enter the range, serial number and calibration due date of the torque device used during assembly for the final increment. For HYTORC machine, enter “HYTORC”, the HYTORC’s head data (i.e., serial number), serial number of the pressure gauge used to read actual pressure applied for final torque and the calibration due date of that pressure gauge. If other calibrated instruments (e.g., torque multiplier, torque meter) are used, also enter data for these instruments.

CRAFTSMAN SIGNATURE/BADGE: Craftsman sign and date after satisfactory assembly of the joint.

QAI SIGNATURE/BADGE: When required, QAI shall sign and date after the satisfactory completion of assembly in accordance with the requirements. Planner enter NA when QAI is not required.

Table 3 - QAI Inspection Requirements				
Location	Software Installation	Material Installations	Torque	Sealing Surface & Fasteners
Nuclear Level I piping system mechanical joints	Note 1	Yes - Existing and New LI	Yes (when a torque is specified)	No
Controlled Assemblies	Yes	Yes - New LI Only	Yes	Yes
SUBSAFE Hull Integrity Joints	Yes	Yes - New LI Only	Yes	Yes
SUBSAFE Bolted Pressure Boundary Joints	No	Yes - New LI Only	No	No
EHF Installations	Yes	Yes - New LI Only	Yes	Yes
SOC Bolted Pressure Boundary Joints	Yes	Yes - New LI Yes - MCD-A Yes - MCD-B Yes - MCD-C	Yes	Yes
SOC Unions	Yes	Yes - New LI Yes - MCD-A Yes - MCD-B Yes - MCD-C	Yes (When source is specified)	Yes

NOTE 1: YES - IF A FLEXATALLIC GASKET IS USED AND THE MATING SURFACES ARE NOT IN CONTACT. THE QAI IS NOT REQUIRED TO WITNESS INSTALLATION OF THE GASKET BUT MUST INSPECT THE MATING SURFACE GAP AND PARALLELISM AFTER SOFTWARE INSTALLATION AND FINAL TORQUE.

FOR JOINTS: CRAFTSMAN/QAI signature(s) certifies that the joint meets the requirements for the following:

- a. The applied lubricant is acceptable per the technical direction.

- b. All existing Hull Integrity Male Fasteners have been examined for markings of significance or have been verified by a generic material identification test to insure they are of proper material. All markings have been recorded and if required, the results of any material identification testing are recorded in the Remarks block.
- c. All set studs have been verified to be tight during assembly in accordance with Part I, Chapter 5, paragraph 5.4.7 of this volume.
- d. The final required pre-load torque has been applied in accordance with specified requirements.
- e. Sealing surfaces meet the acceptance criteria of the applicable Maintenance Standard.
- f. Alignment, gap and parallelism meet the specified requirements for the joint.
- g. Male fasteners type and size agree with entries in the "FASTENER SIZE/TYPE" block and the specified criteria.
- h. Existing fasteners are reinstalled in the same joint and are not obviously incorrect based on markings, color, corrosion or other visual indication.
- i. Thread protrusion is satisfactory. Thread protrusion is the number of threads protruding above the nut. Minimum thread protrusion is one thread on non-self-locking fasteners or flush for self-locking fasteners. Maximum thread protrusion is ten threads unless authorized by drawing or technical manual.
- j. All new material associated with the joint meets specified requirements and is listed in Block 7. Existing material associated with the joint is acceptable and is correctly installed.
- k. The Craftsman will perform a visual check of new Level I material at the time of installation to verify the material meets the requirements of the TWD used to install the new material.

FOR OTHER THAN JOINTS: CRAFTSMAN/QAI signature(s) indicates compliance with the attribute(s) listed and the corresponding listed acceptance criteria. All new material associated with the joint meets specified requirements and is listed in Block 7. Existing material associated with the joint is acceptable and is correctly installed.

If UNSAT, the craftsman/QAI will initiate action to resolve the UNSAT condition (e.g., submit a DF) and indicate the action taken in the Remarks block. Do not sign unless a satisfactory repair is completed or the UNSAT condition is accepted.

BLOCK 10 - LOCKWIRE/LOCKING CABLE/DEVICE INSTALLED OR REQD ACTION

(Only required for SUBSAFE/DSS SOC joints)

NOTE: THIS BLOCK APPLIES TO LOCKING DEVICES THAT ARE INSTALLED AFTER JOINT MAKE-UP OR FOR CASES WHEN AN ACTION MUST BE TAKEN AFTER JOINT MAKE-UP TO ENGAGE THE LOCKING DEVICE (E.G., FLIPPING OF A LOCKTAB, STAKING A FASTENER, ETC.) TO ALLOW JOINT MAKE-UP AND TESTING PRIOR TO INSTALLING OR ENGAGING THE LOCKING DEVICE. THIS DOES NOT INCLUDE SELF LOCKING NUTS, SELF LOCKING BOLTS/CAP SCREWS, LOCKWASHERS, ETC. THAT ARE PART OF THE JOINT MAKE-UP AND ARE LISTED IN BLOCK 7.

Planner enter an X in the NA box when not applicable. When an action is required to engage the locking device, enter a description of the required action.

Craftsman sign, date and check SAT when lockwire, locking cable or required locking device (e.g., locking ring for EHF's, barrel nut locking device, etc.) has been properly installed, or the required action has been accomplished. Enter description (e.g., lockwire, locking cable, locktab) and ident (e.g., stock number, **to include SMIC if given**, MIL-SPEC, or piece number) of the lockwire/locking cable/locking device. Enter description and "Existing" for existing locking devices. If more than one locking device type (e.g., lockwire and locktab washers) exists on the assembly, record additional information in the "Remarks block". When the installation of more than one of

the same type of locking device is being documented in Block 10 (e.g., 2 setscrews), record the quantity in addition to the description (Block 11 may be used if additional space is needed). Recording the quantity is not required for lockwire/locking cable, nor when the locking device quantity is documented in Block 7. **QAI sign, print and date in Block 11 for new MCD-C material installed by craftsman in Block 10 to ensure material conforms to specified requirements.**

BLOCK 11 - **REMARKS**

(Craftsman/QAI/QAS/Planning) Enter any pertinent remarks or additional information related to the repair/assembly of the component. Each entry shall contain signature, badge number and date except where the entry is pre-printed on the form by Planning. **For controlled assemblies on systems requiring MIL-STD-1622 for critical applications or MIL-STD-1330, document "Cleanliness maintained per (MIL-STD-1622 Critical Applications or MIL-STD-1330 (as applicable))" and include the Craftsman's signature and date.**

BLOCK 12 - **LWC SUPERVISOR/SHOP SUPERVISOR SIGNATURE/BADGE NO.**

LWC Supervisor will enter signature, date and badge number for final review, signifying the accuracy of the completed form. If any entry is UNSAT, initiate action to resolve the unsat condition and indicate the action taken in the "Remarks" block. Do not sign unless a satisfactory repair is completed or the UNSAT condition is accepted.

BLOCK 13 - **QAS/QAO SIGNATURE/BADGE NO.**

QAS/QAO sign, date and enter badge number for final review, signifying entries are complete and that the data agrees with the listed requirements.

BLOCK 14 - **JOINT DATA FOR JOINTS NOT REQUIRING TORQUE DOCUMENTATION**

NOTE: THIS BLOCK MAY BE USED FOR SPECIFIC ATTRIBUTES THAT ARE NOT COVERED BY THE STANDARD ATTRIBUTES ON THE FORM.

NOTE: (SUBMARINES ONLY) THIS BLOCK SHALL NOT BE USED FOR ANY JOINT ASSEMBLIES.

JOINT ID/JOINT TYPE OR ATTRIBUTE DESCRIPTION: Planner enter the joint identification number including joint type (e.g., ASW-5744 F). For joint types, use "F" for flanged bolted joints, "U" for union joints, and "S" for screw joints. When a joint identification number is not available, a joint description (e.g., Bonnet-to-Body (S)) shall be used. Locally assigned joint numbers may be used when a joint description is not practicable and clarity is required. When additional attribute(s) applies to a component (e.g., hatches, etc.) that are not covered by the attributes already on the form, list the attribute and location (applicable reference) for the acceptance criteria (e.g., TWD, technical manual, etc.). For hatches, at a minimum list the "Seat Clearance Measurement".

JT. REF: Planner enter the corresponding reference listed in Block 6 that identifies where the joint number or description information is found (e.g., Mapping Diagram, Drawing, Tech Manual, Work Procedure, etc.).

(C) FOR CRAFTSMAN OR (I) FOR INSPECTOR: Planner enter "C" on one line for each joint or attribute. Enter "I" on the remaining line for each joint or attribute that requires an inspector signature; leave blank if inspector signature is not required.

CRAFTSMAN SIGNATURE/BADGE/DATE: Craftsman sign and enter badge number and date on the line associated with the "C" after satisfactory assembly of the joint. If UNSAT, the craftsman will initiate action to resolve the UNSAT condition and indicate the action taken in the Remarks block. Do not sign unless a satisfactory repair is completed or the UNSAT condition is accepted.

FOR JOINTS: This signature provides certification that the joint meets the requirements for the following:

- a. All driven studs have been verified to be tight during assembly. Stud rotation during torquing (and break away) is limited to 1/4 turn, but no more turning during installation or removal of the nut for newly installed Class 3 studs installed with locking compound.
- b. The joint has been tightened using an approved method. Recording of torque value is not required.
- c. Sealing surfaces meet the acceptance criteria of the applicable Maintenance Standard.

- d. Alignment, gap and parallelism meet the specified requirements for the joint.
- e. All new material associated with the joint meets specified requirements and is listed in Block 7. Existing material associated with the joint is acceptable and is correctly installed.
- f. The Craftsman will perform a visual check of new Level I material at the time of installation to verify the material meets the requirements of the TWD used to install the new material.

FOR OTHER THAN JOINTS: This signature indicates compliance with the attribute(s) listed and the corresponding listed acceptance criteria. All new material associated with the joint meets specified requirements and is listed in Block 7. Existing material associated with the joint is acceptable and is correctly installed.

INSPECTOR SIGNATURE/BADGE/DATE: (Inspector) When required, Inspector sign and enter badge number and date on the line associated with the "(I)" for verification that all new material associated with the joint meets specified requirements and is listed in Block 7. Existing material associated with the joint is acceptable and is correctly installed.

(This Page Intentionally Left Blank)

QA FORM 34A INSTRUCTIONSJOINT/COMPONENT ASSEMBLY RECORDFOR ASSEMBLIES NOT REQUIRING TORQUE DOCUMENTATION

PURPOSE: To provide a standard form to document the assembly of joints that do not require torque documentation. Planning shall fill in blocks identified by a ♦ prior to issuing. The QA form 34A is not to be used in SOC applications.

REQUIREMENTS:

NOTE: NUCLEAR LEVEL I SYSTEM PIPING JOINTS (I.E., FLANGES) REQUIRE TORQUE DOCUMENTATION AND MUST BE DOCUMENTED ON A QA FORM 34.

1. A QA form 34A is required for:
 - a. All Level I (nuclear and non-nuclear) pressure boundary joints (e.g., “F”, “S”, and “U” type joints) unless specifically excluded by Part I, Chapter 2, paragraphs 2.2.4.a. and 2.2.4.b. of this volume.
 - b. The following submarine applications:
 - (1) (Pre-688 Class) Submarine SUBSAFE Bolted Pressure Boundary Joints including in-line pipe joints as well as component (bonnet to body) joints less than 4 inch NPS inboard of the inboard joint of the backup valve.
 - (2) Other SUBSAFE joints:
 - (a) Non-Seawater/Non-Sea Connected piping and component joints **to include non-pressure boundary joints** (e.g., EMBT Blow, Artic Blow, Emergency Flood Control, Stern Diving).
 - (b) Non-bolted pressure boundary piping and component joints within the hull integrity boundary (e.g., Union (“U”) Bonnet Joints on Hull and Backup Valves, Hull and backup valve stem retainers (“S”), Boiler type Manhole Covers (“BTMC”) on Impulse Tanks).
 - (c) Non-bolted pressure boundary piping and components (e.g., “U” and “S” joints) not within the hull integrity boundary.
 - (d) Linkage or mechanical interlock joints.
 - (e) SUBSAFE/Non-SUBSAFE interface piping joints (e.g., “F” and “U” joints).

PLANNING THE SCOPE OF A QA 34A FORM: In order to support the execution process, it is necessary to properly limit the scope of Assembly Records.

- a. Each joint shall have a unique joint record consisting of separate Block 8 entries.
- b. All Level I material (nuclear and non-nuclear) must be traceable to a specific joint. To ensure unique joint traceability, if any identical Level I parts are used in multiple joints within an assembly (normally this applies to fasteners), the craftsman will annotate which joint (Block 8A, 8B, etc.) the material was installed in.
- c. For complex assemblies (e.g., Shaft Seal installations), assembly records should be scoped to support testing evolutions.

PROCEDURE: The numbered blocks on QA form 34A correspond with instructions listed below. Any block not used will be marked N/A. Planning shall fill in blocks identified by a ♦ prior to issuing the CWP. For QAI signatures, the planner will determine the need for a QAI prior to the start of the job. If no QAI is required, the planner will enter NA in the QAI signature block.

TOP OF FORM - **PAGE** **OF**

Enter page numbers.

BLOCK 1 - **SHIP HULL NO.**

Planner - Enter the ship's name and hull number, or enter the appropriate rotatable pool system designator (e.g., TRIPER, CCRP, AERP, SSN 688CL, etc.).

BLOCK 2 - **JCN**

Planner - Enter the Job Control Number (JCN). Naval shipyards enter Job Order and KeyOp.

BLOCK 3 - **LWC/SHOP**

Planner - Enter the LWC lead shop assigned to assemble the joint (e.g., X31, X38, X56).

BLOCK 4 - **CWP/REC SER. NO.**

Planner - Enter the CWP/REC serial number or enter N/A if no CWP/REC is required. Do not list the CWP/REC revision.

BLOCK 5 - **SYSTEM/COMPONENT/ROTATABLE POOL NO.**

Planner - Enter the noun name of the system and component (if applicable), (e.g., MSW-25). For Rubber Insert Sound Isolation Coupling enter the Selected Record Drawing Line Item No.

NOTE: ROTATABLE POOL SERIAL NUMBERS MAY BE ENTERED BY THE PLANNER, IF KNOWN, OR THE SHOP AS SPECIFIED BY LOCAL INSTRUCTIONS.

BLOCK 6 - **REFERENCES**

Planner - Enter all references used to identify component parts, joint, material and assembly information. Both the assembly drawing and electrical holes assignment drawing shall be listed for Electrical Hull Fittings (EHF). Include revision letter and, if applicable, the assembly number (e.g., Assy D, Assy RA etc.).

BLOCK 7 - **NEW MATERIAL**

PC NO: Craftsman - Enter the piece number of parts. List only the new parts being installed.

REF: Craftsman - Record the reference letter of the drawing or document listed in Block 6 which provides the material specification or assembly information for the piece listed in the "PC NO." block.

JOINT ID: Craftsman - Enter the alphanumeric designator corresponding with the particular Block 8 entry (8A, 8B, 8C, etc.) that identifies the joint where the material is installed.

DESCRIPTION: Craftsman - Describe all new parts associated with the assembly or joint. For fasteners and nuts, include diameter and thread (e.g., bolt, ½"-13; stud, ½"-12; SHCS, ½"-13; etc.). Record shim thickness when shims are installed unless the installation is already documented on another QA form.

NOTE: IF A PORTION OF A NEW VALVE OR COMPONENT IS USED TO REPLACE PARTS (E.G., BONNET AND DISC ASSEMBLY), ENTER A DESCRIPTION OF THE PART OR ASSEMBLY OF PARTS AND DOCUMENT THE LEVEL I NUMBER OF THE NEW VALVE OR COMPONENT IN THE IDENT SECTION. LIST THE PARTS THAT THE ASSEMBLY CONSISTS OF IN THE REMARKS BLOCK (A SINGLE COMPONENT MAY BE LISTED IN BLOCK 7) WITH A NOTE THAT THE PART(S) WERE TAKEN FROM THE NEW VALVE OR COMPONENT.

QTY: Craftsman - Record quantity of new material installed.

LOE: Craftsman - Identify the Level of Essentiality (MIC Level) as "I" or "NA". The material control level shall be as identified by Planning in the TWD.

IDENT: Craftsman - Enter the marking on the part or on the packaging/container/tag (when the part is not marked) as shown in Table 1.

CRAFT INT: Craftsman - Installing craftsman enter initials for material installed. The initials shall correspond to the related Block 8 craftsman's signature unless otherwise noted with a corresponding signature elsewhere on the form (e.g., Remarks block entry and signature).

NOTE: IF THE CRAFTSMAN INSTALLING THE MATERIAL IS OTHER THAN THE CRAFTSMAN SIGNING FOR JOINT DATA IN BLOCK 8, A CORRESPONDING SIGNATURE, BADGE NUMBER AND DATE SHALL BE ENTERED IN THE REMARKS BLOCK.

TABLE 1- DOCUMENTATION REQUIREMENTS	
Material Control Level	Required Information
Level I Material Other Than Fasteners	MIC Number and any other traceability number, including any local traceability number (e.g., PNSY MLN – examples Z142, AB12).
Level I Fasteners	NOTE: THE INFORMATION ENTERED FOR FASTENERS MAY NEED TO INCLUDE INFORMATION FROM BLOCKS 3 AND 8 FROM QA FORM 1. DO NOT ENTER THE PNSY TRACE NUMBER FROM BLOCK 3 OF THE QA FORM 1. Document the markings from the fastener to include either: (1) The color code and the heat/lot number, material type, and manufacturer's symbol (for nuts containing a self-locking insert, the color of the insert is the manufacturer's symbol). (2) The MIC number (when MIC number is on the fastener or on the individual tag for some fasteners).
Controlled Structural Material	Traceability Number
AERP And Other Rotatable Pool Material (688 Class, TRIPER, Etc.)	Enter the appropriate rotatable pool serial number (e.g. RP-148A, 4810-013-5812-A3-0113, TIN -292-11893, etc.)
Transferred And Cannibalized Material	Enter the Equipment Removal List No. or other material History/Traceability number (ERL# XXXX, SSBN-600 EHF #24, etc.)
Other Material Within The LEVEL I/SUBSAFE Boundary	1. Enter at least one of the following documentation attributes: a. Stock Number (from package/container) b. Part Number (from package/piece) c. Part Number and associated Manufacturing Work Procedure (for manufactured items) d. Local Traceability Number (from piece/tag) e. Drawing and Piece Number (from piece/tag) f. Generic, MIL-SPEC, or Material Specification Marking (from piece) g. NDT record numbers or test results for items verified by generic material testing.

BLOCK 8 - JOINT DATA

NOTES:

- (1) THIS BLOCK MAY BE USED FOR SPECIFIC ATTRIBUTES THAT ARE NOT COVERED BY THE STANDARD ATTRIBUTES ON THE FORM.
- (2) FOR OVERHAUL OF HYDRAULIC ACTUATORS AND HYDRAULIC CONTROL VALVE ASSEMBLIES, ONLY ONE ENTRY IS REQUIRED FOR THE ENTIRE ASSEMBLY IN LIEU OF LISTING INDIVIDUAL JOINTS AS LONG AS A CLEAR DEFINITION OF WORK BOUNDARIES HAS BEEN IDENTIFIED IN THE WORK PROCEDURE. FOR THESE CASES, LIST "ACTUATOR ASSEMBLY" OR "CONTROL VALVE ASSEMBLY" IN THIS BLOCK.

JOINT ID & JOINT TYPE OR ATTRIBUTE DESCRIPTION: Planner - Enter the joint identification number including joint type (e.g., ASW-5744 F). For joint types, use "F" for flanged bolted joints, "U" for union joints, and "S" for screw joints. When a joint identification number is not available, a joint description (e.g., Bonnet-to-Body (S)) shall be used. Locally assigned joint numbers may be used when a joint description is not practicable and clarity is required. When an additional attribute(s) applies to a component (e.g., hatches, etc.) that are not covered by the attributes already on the form, list the attribute and location (applicable reference) for the acceptance criteria, (e.g., TWD, technical manual, etc.). For hatches, at a minimum list the "Seat Clearance Measurement".

JT. REF: Planner - Enter the corresponding reference listed in Block 6 that identifies where the joint number or description information is found (e.g., Mapping Diagram, Drawing, Tech Manual, Work Procedure, etc.).

(C) FOR CRAFTSMAN OR (I) FOR INSPECTOR: Planner - Enter "C" on one line for each joint. Enter "I" on the remaining line for each joint requiring an inspector signature.

CRAFTSMAN SIGNATURE/BADGE/DATE: Craftsman sign and enter badge number and date on the line associated with the "C" after satisfactory assembly of the joint.

For joints, this signature provides certification that the joint meets the requirements for the following:

- a. All set studs to be tight during nut installation and torquing in accordance with Part I, Chapter 5, paragraph 5.4.7 of this volume.
- b. The joint has been tightened using an approved method. Recording of torque value is not required.
- c. Sealing surfaces meet the acceptance criteria of the applicable Maintenance Standard or drawing.
- d. Alignment, Gap and Parallelism meet the specified requirements for the joint.
- e. All new material associated with the joint meets specified requirements and is listed in Block 7. Existing material associated with the joint is acceptable and is correctly installed.

For other than joints, the signature indicates compliance with the attribute(s) listed and the corresponding listed acceptance criteria. All new material associated with the joint meets specified requirements and is listed in Block 7. Existing fasteners are installed in the same joint and are not obviously incorrect based on markings, color, corrosion or other visual inspection.

INSPECTOR SIGNATURE/BADGE/DATE: (QAI) When required, Inspector sign, print and enter badge number and date on the line associated with the "(I)" for verification of the following:

- a. Controlled assemblies: All controlled assemblies shall be documented on a QA Form 34.
- b. Non-Controlled assemblies: Inspector signature is for new Level I material only and meets the specified requirements and is properly documented in Block 7.
- c. Nuclear Level I Non-Controlled assemblies: Inspector signature is for new Level I material, gasket compression and parallelism. (Gap measurement is only required when mating surfaces are not in contact).

If UNSAT, the craftsman/QAI will initiate action to resolve the UNSAT condition (e.g., initiate a DFS) and indicate the action taken in the Remarks block. Do not sign unless a satisfactory repair is completed or the UNSAT condition is accepted.

BLOCK 9 - LOCKING DEVICE INSTALLED OR REQD ACTION

NOTE: THIS BLOCK APPLIES TO LOCKING DEVICES ON SUBSAFE COMPONENTS THAT ARE INSTALLED AFTER JOINT MAKE-UP OR FOR CASES WHEN AN ACTION MUST BE TAKEN AFTER JOINT MAKE-UP TO ENGAGE THE LOCKING DEVICE (E.G., FLIPPING OF A LOCKTAB, STAKING A FASTENER, ETC.) TO ALLOW JOINT MAKE-UP AND TESTING PRIOR TO INSTALLING OR ENGAGING THE LOCKING DEVICE. THIS DOES NOT INCLUDE SELF LOCKING NUTS, SELF LOCKING BOLTS/CAP SCREWS, LOCKWASHERS, ETC. THAT ARE PART OF THE JOINT MAKE-UP, AND ARE LISTED IN BLOCK 7.

Planner - Mark the NA box when not applicable. When an action is required to engage the locking device, enter a description of the required action.

(CRAFTSMAN) Enter the Block 8 joint identifier (e.g., 8A) in the JT ID block, check the "SAT" box and sign, enter badge number and date when lockwire or required locking device (e.g., locking ring for EHF's, barrel nut locking device, etc.) has been properly installed, or the required action has been accomplished. Enter description (e.g., lockwire, locktab) and identification (e.g., stock number, MIL-SPEC or piece number) of the lockwire/locking device. Enter description and "Existing" for existing locking devices. If more than one locking device type (e.g., lockwire and locktab washers) exists on the assembly, record additional information in the REMARKS block. When the installation of more than one of the same type of locking device is being documented in Block 9 (e.g., 2 setscrews), record the quantity in addition to the description (Block 10 may be used if additional space is needed). Recording the quantity is not required for lockwire/locking cable, nor when the locking device quantity is documented in Block 7.

BLOCK 10 - REMARKS

(CRAFTSMAN/QAI/QAS) Enter any pertinent remarks or additional information related to the repair/assembly of the component. Each entry shall contain signature and date except where the entry is pre-printed on the form by Planning.

BLOCK 11 - LWC SUPERVISOR/SHOP SUPERVISOR SIGNATURE/BADGE NO.

LWC/shop LWC Supervisor will enter signature, badge number and date for final review, signifying the accuracy of the completed form. If any entry is UNSAT, initiate action to resolve the unsat condition and indicate the action taken in the "Remarks" block. Do not sign unless a satisfactory repair is completed or the UNSAT condition is accepted.

BLOCK 12 - QAS SIGNATURE/BADGE NO.

QAS or QAO will print name, enter signature, badge number and date for final review, signifying the accuracy of the completed form. If any entry is UNSAT, the QAS will initiate action to resolve the unsat condition and indicate actions taken in the "Remarks" block. Do not sign unless a satisfactory repair is completed or the UNSAT condition is accepted.

(This Page Intentionally Left Blank)

THICKNESS MEASUREMENT RECORD
QA FORM 35

1. SHIP		HULL NO.		2. JCN		3. LWC/SHOP		4. CWP/REC SER NO		5. SYSTEM/COMPONENT	
6. REFERENCES											
A				B				C			
7. ITEM(S) TO BE INSPECTED											
PC NO.	REF	TYPE MAT	MIL-SPEC	MATERIAL PP - PIPE C - CASTING PL - PLATE O- OTHER	INSPECTION PROCEDURE	ACCEPTANCE CRITERIA	DESIGN THICKNESS	MIN/MAX ACCEPT THICKNESS	ACTUAL THICKNESS	ACCEPT REJECT	
										<input type="checkbox"/> ACCEPT <input type="checkbox"/> REJECT	
										<input type="checkbox"/> ACCEPT <input type="checkbox"/> REJECT	
										<input type="checkbox"/> ACCEPT <input type="checkbox"/> REJECT	
										<input type="checkbox"/> ACCEPT <input type="checkbox"/> REJECT	
8. ULTRASONIC EQUIPMENT											
INSTR (MOD/SER#)				TYPE TRANSDUCER		SIZE	FREQ	CAL STANDARD		COUPLANT	
CAL DUE DATE:				DELAY <input type="checkbox"/>							
				CONTACT <input type="checkbox"/>							
				DUAL ELEMENT <input type="checkbox"/>							
12. SURFACE FINISH IS ACCEPTABLE IN ACCORDANCE WITH DRAWING:											
PC NO. ___ <input type="checkbox"/> SAT <input type="checkbox"/> UNSAT			PC NO. ___ <input type="checkbox"/> SAT <input type="checkbox"/> UNSAT			PC NO. ___ <input type="checkbox"/> SAT <input type="checkbox"/> UNSAT			PC NO. ___ <input type="checkbox"/> SAT <input type="checkbox"/> UNSAT		
10. INSPECTION AREA SKETCH/REMARKS											
11. INSPECTOR				DATE		11. INSPECTOR				DATE	
										12. NDT SUPERVISOR	
										DATE NO.	

(This Page Intentionally Left Blank)

QA FORM 35 INSTRUCTIONSTHICKNESS MEASUREMENT RECORD

PURPOSE: To document UT thickness measurements and acceptability of material measured based on design material thickness.

PROCEDURE: The numbered blocks in QA form 35 correspond with the instructions below.

BLOCK 1 - SHIP HULL NO.

Enter the ship's name and hull number.

BLOCK 2 - JCN

Enter the JCN.

BLOCK 3 - LWC

Enter the LWC.

BLOCK 4 - CWP/REC SER. NO.

Enter the CWP/REC serial number or enter N/A if no CWP/REC is required. Do not list the CWP/REC revision.

BLOCK 5 - SYSTEM/COMPONENT

Enter nomenclature and NPS (if applicable) for component being measured and if known, the end use (e.g., Valve body for ASW-352).

BLOCK 6 - REFERENCES

Enter the drawing number(s) or other references that show the material and design specifications for the component being measured (e.g., 845-4385050), the NDT inspection procedure number, and the drawing number and revision, material specification, or Military Standard used for acceptance criteria.

BLOCK 7 - MATERIAL

PC NO: Enter piece number of the part or component to be checked.

REF: Record the reference letter of the drawing or document listed in Block 6 which provides the assembly information for the piece listed in the "PC NO." block.

TYPE MATERIAL: Enter the material type (e.g., CRES-304, 7030 CUNI, 9010 CUNI).

MIL-SPEC: Enter the material MIL-SPEC or equivalent (e.g., ASTM, ASME/SPEC).

MATERIAL: Enter the abbreviation for the material being checked. If other than pipe, casting, or plate, write it in the block (e.g., forged) in the blank provided.

INSPECTION PROCEDURE: Enter the reference letter indicating the NDT inspection procedure number.

ACCEPTANCE CRITERIA: Enter the reference letter indicating the drawing, material specification, or Military Standard used for acceptance.

DESIGN MATL THICKNESS: Enter the design material thickness specified on the drawing, specification or standard.

MIN/MAX ACCEPT THK: Enter the drawing minimum acceptable thickness and if applicable the maximum drawing acceptable thickness with a MAX subscript.

ACTUAL THK: Enter the actual thickness as measured.

ACCEPT/REJECT: Check the appropriate box to indicate the results of the inspection.

BLOCK 8 - ULTRASONIC EQUIPMENT

INSTR (MOD/ SER. NO): Enter the equipment model and serial number.

CAL DUE DATE: Enter the calibration due date of the equipment used during the measurement.

TYPE TRANSDUCER: Enter the type transducer used during the measurement. Check the appropriate block.

SIZE: Enter the transducer size used during the measurement.

FREQ: Enter the transducer frequency used during the measurement.

CAL STANDARD: Enter the serial no. of the calibration standard used.

COUPLANT: Enter the couplant used during the measurement.

BLOCK 9 - SURFACE FINISH ACCEPTABILITY

Enter the piece number being inspected and check the appropriate block (SAT/UNSAT) indicating the result of the surface finish inspection.

BLOCK 10 - INSPECTION AREA SKETCH/REMARKS

Enter a sketch of the area measured. In addition to the sketch, enter a list of any other references to determine acceptability of material thickness. Enter grid spacing if applicable. Enter a list of any other references to determine acceptability of material thickness. This block may also be used to record the results of multiple thickness readings on the same component. Enter remarks or comments pertinent to the inspection. Sign and date each entry.

BLOCK 11 - INSPECTOR/DATE

NDT Inspector(s) print name, enter signature and date signifying accuracy of the data recorded.

BLOCK 12 - NDT SUPERVISOR ID NO./DATE

NDT examiner/supervisor print name, enter signature, and date signifying the report as technically and administratively complete and accurate.

SHIP TO SHOP TAG MAT-1 (GENERAL USE)
(Tag color is blue)

MAT-1		
SHIP TO SHOP TAG (GENERAL USE) TAG ___ OF ___		
(PART 1)		
SHIP	JCN	
EIC/APL	SER. NO.	
JOB BRIEF/EQUIP NOMENCLATURE		
LEAD W/C	DATE DELV'D	DELIVERED BY
(PART 2)		
READY FOR PICK UP TAG		
SHIP*	JCN*	
JOB BRIEF-WORK PERFORMED		
REPAIR ACTIVITY REP.	DATE	
(PART 3)		
CUSTOMER MATERIAL RECEIPT		
SHIP*	JCN*	
JOB BRIEF/EQUIP NOMENCLATURE*		
RECEIVED BY	DATE	
DELIVERED BY	DATE	
SHIP'S FORCE REMOVE AND RETAIN PART 3 AS RECEIPT FOR MATERIAL DELIVERED TO THE REPAIR ACTIVITY		

(This Page Intentionally Left Blank)

MAT-1 INSTRUCTIONS**SHIP TO SHOP TAG MAT-1 (GENERAL USE)**

S/N 0103-LF-984-3400

NOTE 1: NOT TO BE USED FOR CONTROLLED MATERIAL.

NOTE 2: THE MAINTENANCE PROVIDER WILL ESTABLISH A PROCESS FOR CONTROLLING MATERIAL BEING TRANSPORTED FROM SHIP TO SHOP. IF A PROCESS IS USED OTHER THAN DESCRIBED BELOW, ISIC APPROVAL IS REQUIRED.

1. **PURPOSE:** To maintain positive identification and control of ship to shop transfer of equipment and components.2. **PROCEDURE:**

- a. Ship's Force personnel will fill out all blocks in Part 1 and those marked with an asterisk (*) in Parts 2 and 3, attach the tag to the equipment/component and deliver to the Repair Activity. Verify correct EIC/APL is provided. Ensure accurate description of desired work is included in Job Brief/Equip Nomenclature Block. Example: No. 2 Main Lube Oil Pump Discharge Relief Valve Pop Test to 45 psi and attach test tag.
- b. When the component is delivered to the Repair Activity, ship's representative will sign and date Part 1 and 3 in the applicable blocks. The Repair Activity representative will sign and date Part 3 to acknowledge receipt of the equipment/component. Part 3 will be detached from the tag and given to the ship's representative.
- c. Upon completion of repairs, the Repair Activity will record work performed, sign and date Part 2 and forward Part 2 to the ship as notice that the equipment/component is ready to be picked up.
- d. The ship's representative will present Part 3 to the Repair Activity Shop when picking up the equipment/component. Ship's Force should sign the Work Request for job completion when the item is picked up. If desired, part 3 may be attached to the completed work request.

3. **BLOCK DESCRIPTION:**

a. Part 1.

Ship	Ship's name and hull number
JCN	Job Control Number (UIC, Work Center and JSN)
EIC/APL	Equipment Identification Code/Allowance Parts
	List of item worked
Ser. No.	Equipment/Component Serial Number
Job Brief/Equip Nomenclature	Job Description and name of equipment or component
Lead W/C	Work center responsible for equipment/component
Date Delv'd	Date delivered to Repair Activity
Delivered By	Signature of person delivering item

b. Part 2.

Ship	Ship's name and hull number
JCN	Job Control Number (UIC, Work Center and JSN)
Job Brief/Work Performed	Job Description and brief explanation of work performed
By Repair Activity	Signature of person verifying work complete
Repair Activity Rep.	Date of signature above
Date	

c. Part 3.

Ship	Ship's name and hull number
JCN	Job Control Number (UIC, Work Center and JSN)
Job Brief/Equip Nomenclature	Job Description and name of equipment or component
Received By	Signature of Repair Activity person accepting item for work
Date	Date of signature above
Delivered By	Signature of person delivering item to Repair Activity
Date	Date of signature above

VOLUME V
PART I
CHAPTER 12
SUBMARINE PRESERVATION

REFERENCES.

- (a) NAVSEA SI 009-32 - Cleaning and Painting Requirements Accomplishment
- (b) NAVSEA S9086-VD-STM-010 - NSTM Chapter 631 (Preservation of Ships In-Service - General)
- (c) NAVSEA MS 6310-081-015 - Submarine Preservation
- (d) NAVSEA ltr Ser 396A23/0641 of 25 June 93 - Trident Preservation Maintenance
- (e) NAVSEA ltr Ser 92T124/006 of 14 Mar 02 - Preservation QA Requirements for In-Service Submarines

12.1 **PURPOSE.** The purpose of this chapter is to specify maintenance requirements for preservation systems on submarines to the submarine maintenance community.

12.1.1 **Scope.** This chapter provides the requirements for the Trident Repair Facilities to be used in all instances of maintaining, repairing, and replacing preservation systems on non-nuclear components and spaces of U.S. Navy submarines.

12.2 **GENERAL PRESERVATION REQUIREMENTS.**

- a. Reference (a) is the primary preservation document and complies with requirements of reference (b), except where deviations are specifically approved by Naval Sea Systems Command (NAVSEA). In instances where the requirements specified in reference (a) conflict with requirements specified in other standards (including but not limited to Naval Ships' Technical Manuals, Deep Diving General Overhaul Specifications, Maintenance Requirement Cards, Maintenance Standards, and Individual Ship's Paint Schedules), the criteria of reference (a) must govern. Supplemental information and requirements for submarines can be found in reference (c).
- b. To reduce overall maintenance and to help insure that the maximum coating life is obtained, Section 11 of reference (b) and reference (a), as applicable, are invoked by reference (d) for all Ohio Class preservation maintenance. In that section the term "shipyard" is to be interpreted to mean "Refit Facility".
- c. Preservation maintenance must be performed as authorized by work statements in work packages or as specifically authorized by NAVSEA or the Type Commanders. In process inspections must be performed per reference (a).

12.3 **SUBMARINE PRESERVATION MAINTENANCE PROCESSES.**

12.3.1 **Maintenance Processes.** Reference (c) provides additional requirements for accomplishing cleaning, surface preparation, inspection, and paint application to maintain or replace submarine coatings. The individual maintenance processes are organized into separate attachments which can be used independently to perform the particular maintenance, and provide guidance to accomplish the minimum amount of work that has been historically required to support the safe operation of submarines.

12.3.2 **Coating System Maintenance Authorization.** Maintenance on a coating system is authorized by the work package or by the Current Ship's Maintenance Project, but it is the responsibility of the repair activity to evaluate the existing coating system to determine whether the authorized maintenance is adequate and proper to support reliable operation of the ship. When a repair activity determines, by inspection, that the level of repair needed is greater than authorized, they must obtain approval of the Type Commander for authorization to accomplish the additional work. The existing coating must be evaluated by a qualified technical evaluator who has, at a minimum, successfully completed the National Association of Corrosion Engineers (NACE) Level I Basic Coating Inspector Training (or equivalent) per reference (a).

12.4 QUALITY ASSURANCE FOR CRITICAL COATED AREAS. The Quality Control requirements of Section 11 of reference (b), and reference (a), as applicable, and reference (e) shall form an integral part of a shipyard's overall Quality Control program. The maintenance activity Quality Assurance organization shall be responsible for ensuring all requirements of this section are met.

12.4.1 Critical Coated Areas. Critical coated areas are areas where premature failure of the coating system cannot be detected by routine observation due to inaccessibility (such as inside ship's tanks) and those areas where restoration of the failed system cannot be undertaken without laying up the ship (e.g., nuclear space, ship's underwater hull requiring dry docking, and ship's tanks requiring separation from associated systems for access, cleaning and represervation).

12.4.2 Requirements for Critical Coated Areas. Critical coated areas shall have:

- a. Surface preparation accomplished by certified blasters.
- b. Coatings applied by certified painters.
- c. Test and inspection records maintained in accordance with Table 631-11-1 of reference (b) and reference (a), as applicable.
- d. Key checkpoints signed off by certified coating inspectors. See additional Quality Assurance requirements for potable water tanks and other high purity water tanks in applicable sections of reference (b) and reference (a), as applicable.
- e. Any out-of-specification condition found is to be mitigated in accordance with reference (c), paragraph 9.

12.4.3 Test and Inspection Records. The maintenance activity shall maintain auditable records of the tests and inspections listed in Table 631-11-1 of reference (b) and reference (a), as applicable, for critical coated areas. The records shall be designed to provide objective quality evidence that applicable surface preparation and painting procedures were followed and that acceptable conditions and quality attributes were achieved for each parameter defined in Table 631-11-1 of reference (b) and reference (a), as applicable. A separate set of records shall be maintained for each area painted. Records applicable to painting reported in docking reports shall be incorporated into the docking report. The records shall be available for three years after the delivery of the ship or completion of an overhaul or refit, unless otherwise specified. At the expiration of the records retention period, NAVSEA or its authorized representatives shall be given a written notification. If no disposition instructions are received within six months from the notification, the records may be destroyed.

12.4.4 Blaster and Painter Certification. The maintenance activity shall maintain a certification program for blasters and painters of critical coated areas. The program shall include minimum training requirements and provide for adequate records verifying the completion and currency of training for each blaster or painter involved in surface preparation or application of coatings in critical areas. Documentation shall be maintained verifying that only certified blasters and painters are used for preservation work in critical areas. Training shall include all blasting and paint application techniques and procedures appropriate to the surface preparation and coating materials being used. These techniques and procedures include mixing, conditioning and thinning of paints, proper selection, control and maintenance of blasting and application equipment, and blasting and application techniques.

12.4.5 Coating Inspector Certification. The maintenance activity Quality Assurance Departments shall maintain a certification program for paint inspectors of critical coated areas. The program shall include minimum training requirements and provide for adequate records verifying the completion and currency of training for each paint inspector involved in inspecting surface preparation, or application of coatings in critical areas. Documentation shall be maintained verifying that only certified paint inspectors are used for inspecting preservation work in critical areas. Training shall include all techniques and procedures appropriate to inspecting the surface preparation and coating application being used. These techniques and procedures include determining the acceptability of surface preparation prior to commencement of paint application, determining the degree of compliance with blasting and painting procedures appropriate to the surface preparation and coating materials being used and determining the acceptability of finished products in accordance with established standardized acceptance criteria. At a minimum, coating inspectors shall be certified and maintain certification to the NACE Level I Basic Coating Inspector training or equivalent per reference (a). Activities using application procedures such as thermal spray, resulting in deposition of flame sprayed aluminum or flame sprayed zinc, and other high technology coatings, are required to have at least one coating inspector professionally certified to NACE Level I or equivalent per reference (a). The coating inspector must be knowledgeable of the process and requirements.

12.4.6 Coating Inspector Responsibilities. Coating inspectors are responsible for providing reasonable confidence that material receipt and storage, surface preparation, paint application and paint curing are done in accordance with the requirements of references (a) and (b) and paint manufacturer instructions. These responsibilities require the coating inspector to:

- a. Inspect material storage and receipt inspection facilities.
- b. Ensure all inspection equipment requiring calibration certification is certified under organization metrology calibration programs.
- c. Perform in-process inspections of surface preparation and painting activities in critical coated areas.
- d. Verify successful completion of key checkpoints in the application process.
- e. Inspect and accept or reject final paint systems in critical coated areas.

12.4.6.1 Inspection of Storage and Receipt Inspection Facilities. Inspections of these areas shall be done periodically to ensure paints are being stored and receipt inspected in accordance with manufacturer's product data sheets (American Society for Testing and Materials F718) and the requirements of reference (b) and reference (a), as applicable. It is an organizational level responsibility to obtain American Society for Testing and Materials F718s and Material Safety Data Sheets for specified products. These documents shall reflect the properties and requirements of the specified product as of the date of Navy approval for use. Records of inspection results shall be maintained for NAVSEA audit, in a manner similar to the test and inspection records of paragraph 631-11.4 of reference (b) and reference (a), as applicable.

12.4.6.2 In-Process Inspections. Coating inspectors shall be given notice and shall perform an inspection of each critical coated area when the following key checkpoints are reached:

- a. Surface cleaned and ready for abrasive blasting.
- b. Surface abrasive blasted and ready for priming.
- c. Between each successive coat of paint and between stripe coats.
- d. Final coat of paint applied and area ready for final inspection.

The inspector is required to examine all data maintained by the paint foreman concerning environmental conditions, surface cleanliness, surface profile and paint thickness. Certain data shall always be verified, depending on the checkpoint in question, including surface cleanliness, surface profile, dry film thickness and workmanship. Environmental data, such as temperatures, relative humidity and dew point need only be verified if the inspector is doubtful of the recorded values. Deficiencies in personnel training, certification, record maintenance, equipment maintenance or any matter that is not in accordance with good painting practice shall be recorded. The coating inspector shall verify successful completion of each checkpoint with a signature on an appropriate form, which shall then be maintained in accordance with the instructions of paragraph 631-11.4 of reference (b) and reference (a), as applicable.

12.4.7 Inspection of Final Coating System. Inspection of final coating systems shall be performed in accordance with section IV.1.e of Table 631-11-1 of reference (b) and reference (a), as applicable, by certified paint inspectors. The responsibility for proper application including all associated processes for the application of the coating systems resides with the maintenance activity. Coating imperfections found, which may cause premature coating failure, shall be corrected before the paint system is accepted using appropriate touch-up procedures. Slight imperfections in the coating system are allowable, as long as they will not result in premature failure of the coating in the immediate vicinity of the imperfection. Such slight imperfections should be left intact, as trying to correct them could result in damage to the surrounding coating system. Failure to meet minimum dry film thickness requirements shall result in application of an additional coat or coats of paint in deficient areas before the coating system is accepted.

12.4.8 Review of Records for Final Coating Evaluation. A certified paint inspector authorized to represent NAVSEA shall review the paint records of each critical area to ensure the maintenance activity has maintained adequate control of the painting process. Records shall include all the test and inspection data required by reference (b) and reference (a), as applicable. Failure to produce such records, or records which indicate that blasting and painting was done in accordance with governing specifications/instructions, may be grounds for rejection.

12.4.9 Acceptance/Rejection of Final Coating Systems. Certified coating inspectors independent of the group, shop or code accomplishing the preservation work are responsible for accepting or rejecting completed coating systems in critical coated areas. Acceptance or rejection of coatings shall be based on a review of the painting records for the area and an inspection of the area, in accordance with paragraphs 631-11.11 and 631-11.12 of reference (b) and reference (a), as applicable.

VOLUME V
PART I
CHAPTER 13
WIRE REMOVAL AND REPLACEMENT

LISTING OF APPENDICES.

- A Wire Removal/Replacement Form MAT-2
 B **Submarine Wire Removal/Replacement Form MAT-3**

13.1 **PURPOSE.** To establish requirements, procedures and administrative tools to control work involving wire removal and connection.

13.1.1 **Discussion.** The disconnecting and reconnecting of electrical leads must be formally controlled to preclude inadvertent equipment configuration changes. Improper wire connections during maintenance have caused incidents of equipment malfunction and damage, and may result in increased personnel hazard.

13.2 **ACTION.** All operations which involve the physical removal or connection of one or more wires from their termination point will be documented using **either Appendix A or Appendix B** of this chapter. **Appendix B is to be used for submarines.** A separate form will be used for each separate component or system (e.g., maintenance on two instrumentation drawers should be documented on two separate forms).

- a. For maintenance actions which will result in an intentional wiring configuration change (e.g., Ship Alteration installation) Appendix A **or Appendix B** of this chapter shall be documented such that the disconnecting of old wiring and the reconnecting of new wiring is verified to be per print.
- b. Blueprints, drawings, and schematic diagrams will be reviewed prior to work. The expected configuration shall be entered on the Wire Removal/Replacement Form (Appendix A **or Appendix B** of this chapter) before any wires are disconnected or moved. This will identify any discrepancy between the reference drawing and the ship's wiring configuration. Temporary wire markings will be used for positive identification if necessary and all checks will include proper hardware stack-up (lugs, washers, fastener tightness, etc.).
- c. A clear method of identifying wire connections must be used (e.g., a worker who was not involved in the disconnection will be able to reconnect the wires without the need for further information sources). If necessary, a simple sketch can be generated and kept with the wire removal form to facilitate this, but the sketch is not intended to replace **the use of Appendix A or Appendix B.**
- d. Jumpers. Use of jumpers internal to cabinets requires use of Appendix A **or Appendix B** of this chapter, and if more than one jumper is used, a marking system must be used to identify them and prevent confusion (i.e., marked as Jumper-1, Jumper-2 or use different colored wires). When installing jumpers, fill out the "Wires Reconnected" blocks of Appendix A **or Appendix B** of this chapter first, then the "Wires Disconnected" blocks after the jumpers are removed. These procedures are not intended to replace any of the requirements of Section 4.d of Appendix F of the Tagout Users Manual.

(This Page Intentionally Left Blank)

(This Page Intentionally Left Blank)

APPENDIX B

SUBMARINE WIRE REMOVAL/REPLACEMENT FORM MAT-3

Page ____ of ____

Job Description _____ Date _____

Equipment/Component Affected _____

Wiring Diagram used _____

WIRES TO BE DISCONNECTED					DISCONNECTED		WIRES TO BE RECONNECTED					RECONNECTED	
Lead Number	Terminal Board#	Color Code	1 st CK	2 nd CK	1 st CK	2 nd CK	Lead Number	Terminal Board#	Color Code	1 st CK	2 nd CK	1 st CK	2 nd CK

Print name and initials for each 1st and 2nd checker listed above

Initials	Print Name		Initials	Print Name

Supervisor Review _____ Title _____ Date _____

(This Page Intentionally Left Blank)

VOLUME V**PART III****FOREWORD****SCOPE OF CERTIFICATION**LISTING OF APPENDICES.

- A List of Acronyms
- B Glossary of Terms

1 PURPOSE. Part III of this volume provides information to supplement Part I in the area of Scope of Certification. It provides processes and guidance to ensure, with a reasonable level of confidence, that work on Scope of Certification systems on Deep Submergence Systems (DSS) and Host Submarines and ships is accomplished with first time quality. It contains the necessary material and procedural requirements for DSS certification of manned noncombatant submersible, submarine oriented DSSs including diving systems, and the man rated portion of their handling systems.

2 SCOPE. This section is directive in nature and may be cited as authority for action. It is applicable to every ship and DSS in the fleet. Where higher authority imposes more stringent requirements, such requirements shall have precedence. When such conflicts are identified they should be reported immediately to the Type Commanders (TYCOM) or Immediate Superior In Command as appropriate. In the absence of any guidance, refer to the order of precedence listed in Part I, Foreword, paragraph 1.3.3 of this Volume.

3 NEED FOR SCOPE OF CERTIFICATION QUALITY MAINTENANCE PROCESSES.

- a. The Deep Submergence Systems Program (DSSP) resulted from the Deep Submergence System Review Group (DSSRG) which was formed after the loss of the USS THRESHER (SSN 593) with all hands in April 1963. The Secretary of the Navy directed the DSSRG to examine the Navy's plans for the development and procurement of components and systems related to location, identification, rescue from and recovery of deeply submerged vessels from the ocean floor and to recommend a program that would result in optimizing the future effectiveness of such components and systems.
- b. During the development of the DSSP, there were a number of mishaps that emphasized the importance of such a program. These incidents emphasize the need for properly designed systems, meeting design requirements and operating, maintaining and monitoring systems in accordance with approved procedures.
 - (1) In the early 1970s, two separate commercial incidents claimed three lives. The better known, the Johnson Sea Link entrapment, was where two lives were lost when a DSV became entangled on a scuttled destroyer.
 - (2) In 1982, five divers lost their lives when a vacuum was inadvertently drawn onboard USS GRAYBACK (SS 574). This led to redesign of diving systems to ensure a vacuum could not be drawn. It also led to ensuring Naval Sea Systems Command (NAVSEA) 00C is involved in the design of submarine oriented diving systems, in the approval of diving equipment, and in NAVSEA 07 SCA surveys of diving systems when NAVSEA 00C deems it necessary. Additionally, it led to requiring safety analysis during design for all systems within the Scope of Certification.
 - (3) In the 1980s, two Navy submersibles had casualties that did not result in any injuries but had the potential for serious implications. One DSS became entangled on the ocean floor when it began operating in an unauthorized area. In 1987, the other DSS lost buoyancy on sea trials after an overhaul as a result of a ballast tank valve being installed backwards. In 1987 a civilian submersible viewport failed due to improper design resulting in the death of one of the operators.

(This Page Intentionally Left Blank)

APPENDIX A
LIST OF ACRONYMS

ADS	Atmospheric Diving System
CMH	Controlled Material Handler
CMPO	Controlled Material Petty Officer
COC	Certificate of Compliance
COMNAVSPECWARGRU	Commander, Naval Special Warfare Group
COT	Certificate of Test
CSP	Certification Survey Plan
CWP	Controlled Work Package
DDS	Dry Deck Shelter
DFS	Departure From Specification
DSS	Deep Submergence System
DSSP	Deep Submergence Systems Program
DSSRG	Deep Submergence Systems Review Group
EHF	Electrical Hull Fitting
FADS	Fly Away Dive Systems
FBW	Fly-By-Wire
FFF	Form, Fit, Function
FMA	Fleet Maintenance Activity
HIP	Hull Integrity Procedure
ISIC	Immediate Superior In Command
JCN	Job Control Number
LWC	Lead Work Center
MCD	Material Control Division
MIC	Material Identification and Control
MOA	Memorandum of Agreement
MRC	Maintenance Requirement Card
MTT	Material Tracking Tag
NA or N/A	Not Applicable
NAVSEA	Naval Sea Systems Command
NSN	National Stock Number
OQE	Objective Quality Evidence
PMS	Planned Maintenance System
PTC	Personnel Transfer Capsule
QA	Quality Assurance
QAI	Quality Assurance Inspector
QAO	Quality Assurance Officer
REC	Re-Entry Control
RFI	Ready for Issue

SCA	System Certification Authority
SCS	Ship Control System
SDS	Salvage Dive Systems
SDV	Seal Delivery Vehicle
SMIC	Special Material Identification Code
SOC	Scope of Certification
SRC	Submarine Rescue Chamber
SRCFS	Submarine Rescue Chamber Fly Away System
SUBSAFE	Submarine Safety
TYCOM	Type Commander
URO	Unrestricted Operation
WSS	Weapons Systems Support

APPENDIX B**GLOSSARY OF TERMS**

<u>TERM</u>	<u>DEFINITION</u>
Atmospheric Diving System	The Atmospheric Diving System (ADS) is a one-man, one-atmosphere, dry, submersible used primarily for submarine rescue. It is a surface supported submersible with a primary mission of clearing debris from the hatch of a disabled submarine and connecting the downhaul cable for the Submarine Rescue Chamber.
Certification	The process of certification application, review, survey and approval of all items and procedures within a Deep Submergence System (DSS) Scope of Certification (SOC) that affect the safety of DSS personnel. Written statement attesting that an item, procedure or system meets specified requirements.
Certification Package	The certification package consists of the Objective Quality Evidence supporting conformance to certification requirements.
Certification Survey Plan	A detailed checklist derived from the SOC which is used to identify the description of requirements and the supporting documentation to substantiate the requirements. It is used as the basis for certification surveys. Certification Survey Plans replace Pre-Survey Outline Booklets which were previously used for this purpose.
Cognizant Technical Authority	The organization which the NAVSEA Chief Engineer has designated as having the authority to represent the Chief Engineer on a specific technical area.
Critical Explodable Item	Any explodable item, which by exploding, affects the safety of the DSS personnel.
Critical Implodable Item	Any implodable item, which by imploding, affects the safety of the DSS personnel.
Deep Submergence Rescue Vehicle	A non-combatant submersible, consisting of three spheres with the internal pressure of each sphere normally at one atmosphere, but slightly elevated internal pressures may be experienced, which carries crewmembers of a disabled submarine to the surface.
Deep Submergence System Certification	The authorization granted by the System Certification Authority (SCA) to operate a DSS within its prescribed parameters.
Deep Submergence System Personnel	The occupants or operators of the DSS. The safety of personnel involved with the external handling and external equipment operations of the DSS is not covered by the certification process unless a danger to their well being imperils DSS personnel.
Deep Submergence System Unit	Those systems and components which, when working together, provide the capability for manned underwater operations. Elements may include a manned vehicle, shore training facilities, designated support equipment, those systems that are a temporary or permanent part of a submarine that are used to disembark or recover personnel such as a Dry Deck Shelter (DDS) or Lockout Trunk, and handling equipment.

Differential Loading	The presence of pressure on the interior or exterior surface of a component, piping system, sphere, implodable or other object which is more or less than the pressure located on the opposite surface.
Dry Deck Shelter	A unit consisting of three spheres which can be attached to a submarine or operated at designated shore base training facilities. The DDS has a specified external test depth and has specific internal pressure limits to which each sphere is operated. The DDS can deploy Special Operating Forces and their equipment, including SEAL Delivery Vehicles, while submerged.
Explodable Volume	Any pressure housing containing a volume of gas at a pressure above the external ambient sea pressure (at any depth) which has the potential to burst. Note that some volumes may be explodable at shallow depths and implodable at deeper depths.
Flotation	The materials, components or equipment that provide buoyancy to the DSS. Syntactic foam is a type of generally used flotation/buoyancy material.
Functional Audits	A functional audit is an audit of an activity performing SOC work. It is a review of policies, processes, controls, procedures and associated functions used to perform specific certification related tasks. The SCA will develop (define) an audit plan. This audit supplements the DSS construction, availability and sustaining surveys performed using the Certification Survey Plan.
Hull Envelope	The external hull and its penetrations including plates, inserts, frames, tanks, etc. It is the primary boundary between operators and the environment.
Hull Integrity Fasteners	Hull Integrity Fasteners (HF) are male threaded items such as bolts, studs and cap screws loaded by the differential between sea pressure and DSS internal atmospheric pressure and which are a part of pressure hull integrity component or of systems penetrating the pressure hull integrity boundary from the hull to and including the inboard valve. Does not include nuts and lockwashers.
Hull Integrity Procedures (HIPs)	<p>A group of procedures (currently DDS only) that must be performed as scheduled to sustain certification. These procedures perform periodic tests and inspections to:</p> <ol style="list-style-type: none">1. Minimize the possibility of undetected degradation of hull integrity boundary materials due to their service environment.2. Provide evidence that acceptable material conditions are being maintained to provide confidence that safe operations may be continued.3. Provide specific guidance as to how the test or inspection shall be conducted, extent of inspection, procedure by which to measure the material conditions, criteria of acceptance and the required intervals between inspections for scheduling purposes.
Hull Openings	Openings in the pressure hull used for access, escape and logistics, which are designed to withstand the differential of sea pressure to internal hull pressure at collapse depth.

Hyperbaric Chamber	Pressure resistant structure, including reinforced openings, penetrations, hatches, piping, boundary valves and medical lock that experience differential pressures and provides space for personnel. Recompression chambers are examples of hyperbaric chambers.
Immediate Superior In Command	For Submarine Type Commander (TYCOM) DSS assets it is the Squadron or Group. For DDS units it is Commander, Naval Special Warfare Group (COMNAVSPECWARGRU) Three. When the DSS unit is attached to a host ship the Immediate Superior In Command shall be as identified in the Memorandum of Agreement.
Implodable Volume	Any pressure housing containing a non-compensated compressible volume at a pressure below the external sea pressure (at any depth down to the maximum operating depth) which has the potential to collapse. The outer shell volume is used when calculating the volume of an implodable. Subtracting the volume of items internal to the implodable is not allowed. Externally mounted lights, gauges, bottles/flasks, spheres/tanks and beacons are examples of implodable items.
Initial Certification	A certification process conducted on all DSSs procured for Navy use following demonstration of material and procedural adequacy.
Letter of Certification	A letter, message or other formal correspondence issued by the SCA, stating the terms and conditions of certification.
Life Support System	A structure (sphere, chamber or habitat at one atmosphere or greater internal pressure) which provides a livable environment for personnel or a piping system which provides and/or monitors a metabolic breathing mixture suitable and safe for use by divers and/or operators of DDS, Submarine Rescue Chambers or Recompression Chambers.
Manned Testing	The act of enclosing personnel inside a DSS asset and isolating them from the outside or host submarine atmosphere/environment, regardless of the time period involved during testing or training in accordance with a certification plan for initial certification or reinstatement of certification of the DSS as approved by the SCA per NAVSEA SS800-AG-MAN-010/P-9290, section 2.9.
Manned Use	The act of enclosing personnel inside a DSS asset and isolating them from the outside or host submarine atmosphere/environment, regardless of the time period involved during normal operations. This can include testing and training in pursuit of certification or recertification of the DSS as described in NAVSEA SS800-AG-MAN-010/P-9290, section 3.7.4.
Non-critical Explodable Item	Any explodable item, which by exploding, does not affect the safety of DSS personnel.
Non-critical Implodable Item	Any implodable item, which by imploding, does not affect the safety of DSS personnel.

Objective Quality Evidence	Any documented statement of fact, either quantitative or qualitative, pertaining to the quality of a product or service based on observations, measurements or tests that can be verified. Evidence will be expressed in terms of specific quality requirements or characteristics. These characteristics are identified on drawings, in specifications and other documents that describe the item, process or procedure.
Planning Yard	The Naval Shipyard or other activity designated by NAVSEA to perform technical services in design matters, maintaining up to date files of working drawings and Selected Record Drawings.
Program Manager	The organization or activity that acts for the DSS Sponsor and provides overall program management direction.
Reinstatement of Certification	The SCA will reinstate certification when the cause of the suspension has been thoroughly investigated and satisfactorily corrected and the material and procedural adequacy of the DSS has been re-established.
Scope of Certification	Those systems, subsystems and components and the associated maintenance and operational procedures required to provide maximum reasonable assurance that DSS personnel are not imperiled during system operations.
Scope of Certification Notebook	A document containing simplified diagrams which outline those structures, systems, subsystems and equipment within the DSS SOC and may provide guidance to ensure compliance with the certification requirements.
Scope of Certification Planned Maintenance System	PMS which must be satisfactorily performed within periodicity to maintain system SOC certification.
Skirt	A formed shape which is permanently attached to a sphere. The skirt is designed to mate the sphere or DSS unit to another object and the interior of the skirt is designed to be equalized to the same interior pressure as the sphere, allowing the sphere to be opened. When mated, the skirt is subjected to the same differential loading as the sphere.
Special Material Identification Code (SMIC)	<p>A two-digit letter or number code at the end of the National Stock Number or Navy Item Control Number to provide visibility to designated items to ensure maintenance of their technical integrity. The following SMICs from NAVSUPWSSINST 4355.5 Series are for material commonly used in the Fleet for DSS-SOC systems:</p> <p>D0 An item that requires special cleaning and packaging for oxygen/nitrogen service (MIL-STD-1330/MIL-STD-1622 critical clean) and is considered Deep Submergence Program Scope of Certification MCD "B" material. Each item has undergone receipt inspection to insure it meets the requirements of the applicable specification and/or drawing and is certified for use in DSS-SOC applications. Items shall have serialization markings identified on a securely attached Ready For Issue (RFI) tag. Material coded with SMIC D0 requires receipt inspection and segregated storage.</p> <p>D4 An item that supports the Deep Submergence Program and is considered Scope of Certification MCD "B" material. Each item has undergone receipt inspection to insure it meets the requirements of the applicable specification and /or drawing and is certified for use in DSS-SOC applications. Items shall have serialization markings identified on a securely attached RFI tag. Material coded with D4 SMIC requires receipt inspection and segregated storage.</p>

- D5 An item that supports the Deep Submergence Program and is considered Scope of Certification MCD “A” material. Each item has undergone receipt inspection to insure it meets the requirements of the applicable specification and /or drawing and is certified for use in DSS-SOC applications. Items shall be permanently marked or tagged with a unique number traceable to the OOE. Material coded with D5 SMIC requires receipt inspection and segregated storage.
- D6 An item that requires special cleaning and packaging for oxygen/nitrogen service (MIL-STD-1330/MIL-STD-1622 critical clean) and is considered Deep Submergence Program Scope of Certification MCD “A” material. Each item has undergone receipt inspection to insure it meets the requirements of the applicable specification and/or drawing and is certified for use in DSS-SOC applications. Items shall be permanently marked or tagged with a unique number traceable to the OOE. Material coded with D6 SMIC requires receipt inspection and segregated storage.
- D7 An item that supports the Deep Submergence Program and is considered Scope of Certification, MCD “C” material. Each item has undergone receipt inspection to insure it meets the requirements of the applicable specification and/or drawing and is certified for use in DSS-SOC applications. Items shall have serialization markings identified on a securely attached RFI tag.
- D8 An item that requires special cleaning and packaging for oxygen/nitrogen service (MIL-STD-1330/MIL-STD-1622 critical clean) and is considered Deep Submergence Program Scope of Certification MCD “C” material. Each item has undergone receipt inspection to insure it meets the requirements of the applicable specification and/or drawing and is certified for use in DSS-SOC applications. Items shall have serialization markings identified on a securely attached RFI tag.

Surveys	Initial and sustaining surveys verify the adequacy of the DSS for manned use to the limits for which certification is being requested or was issued. This is accomplished by examining Objective Quality Evidence, reviewing processes and procedures and inspecting equipment to validate compliance with approved procedural, design, fabrication, test and maintenance requirements.
Suspension of Certification	A prohibition on manned operation of the DSS until the cause of the prohibition has been resolved.
Sustaining Activity	The recipient of the Letter of Certification. The Sustaining Activity maintains and operates the DSS in the as certified condition per the Letter of Certification required by the appropriate NAVSEA technical specification or manual.
Sustaining Certification	To sustain certification, the DSS must be operated and maintained in the as certified condition in accordance with the Letter of Certification.
System Certification Authority	The code within NAVSEA assigned the responsibility for the manned DSS process by Naval Operations. The SCA has final authority and responsibility for granting certification for DSSs covered by this manual. The SCA resides with the Deputy Commander for Submarines (NAVSEA 07). The working responsibility for certification is vested in NAVSEA 07Q.

Technical Assistance Review	An overall or specific area review of certification related documentation, processes or practices conducted at the request of the Program Manager to provide SCA guidance in support of the assigned DSS or facility certification.
Technical Data	Recorded information (regardless of the form or method of recording) of a scientific or technical nature (including computer databases and computer software documentation). This term does not include computer software or financial, administrative, cost or pricing, or management data or other information incidental to contract administration. The term includes recorded information of a scientific or technical nature that is included in computer databases. For these purposes, technical data includes the characteristic of a particular science, trade or profession.
Type Commander	For Submarines and Submarine TYCOM DSS assets it is Commander Submarine Force Atlantic and Commander Submarine Force Pacific. For DDS units it is Commander, Naval Special Warfare Command. When the DSS unit is attached to the host ship the TYCOM shall be as identified in the Memorandum of Agreement.
User Activity	The activity that provides and exercises operational control for the DSS. In some instances the User Activity and the Sustaining Activity will be the same.
Waterline	The term “waterline” in this manual refers to where the hull of a ship meets the surface of water when afloat.
Work	<ol style="list-style-type: none">a. Any action that actually or potentially changes (including disassembly for the purposes of inspection or repair) the approved configuration of any part, component or ship’s system.b. Any action that removes or affects the ship’s ability to operate ship’s systems or components in accordance with ship’s systems/operating manuals or reactor plant manuals.c. Any testing or inspections required to establish, maintain or reestablish certification.d. Any design, engineering, planning or configuration management functions that involve the final review and/or approval of technical information. <p>Examples of work include the following:</p> <ol style="list-style-type: none">1. Action which disassembles or removes any part, component or ship’s system.2. Action specified in a Technical Work Document.3. Any action that removes or affects the ship’s ability to operate ship’s systems or components in accordance with ship’s systems manuals, operating manuals or reactor plant manuals, excluding tagout in accordance with the Tagout Users Manual, including but not limited to:<ol style="list-style-type: none">(a) Component or system tests.(b) Intrusive inspections (such as breaking the plane of electrical panels requiring electrical safety).

Work (Cont'd)

- (c) Valve line ups that alter the normal system line up not governed by operating procedures.
- (d) Removing valve hand wheels, disconnecting of reach rods.

(This Page Intentionally Left Blank)

VOLUME V
PART III
CHAPTER 1
ORGANIZATIONAL RESPONSIBILITIES

REFERENCES.

- (a) NAVSEA SS800-AG-MAN-010/P-9290 - System Certification Procedures and Criteria Manual for Deep Submergence Systems
- (b) COMSUBLANT/COMSUBPACINST 3502.1 - Submarine Force Internal Monitoring and Critiques

1.1 **PURPOSE.** To provide a list of responsibilities and duties of key personnel within the organizations that are involved in the Scope of Certification (SOC) Program. Responsibilities and/or duties listed in this section are SOC specific and are in addition to the responsibilities listed in Part I, Chapter 1 of this volume.

1.1.1 **Scope of Certification Organization.**

- a. Type Commander (TYCOM).
- b. Immediate Superior In Command (ISIC).
- c. Sustaining Activity.
- d. User Activity.

1.2 **RESPONSIBILITIES.**

1.2.1 **Type Commander.** The TYCOM for Deep Submergence Systems (DSS) is responsible for the following items:

- a. Obtain System Certification Authority (SCA) approval for exception to Re-Entry Control (REC) requirements in SOC systems.
- b. Administer a Departure from Specification (DFS) system to:
 - (1) Establish and maintain an auditable method of processing requests for approval of DFS.
 - (2) Review and evaluate DFS requests and obtain clarification of technical specifications from Naval Sea Systems Command (NAVSEA) where appropriate.
 - (3) Approve or disapprove Non-SOC DFS requests.
 - (4) Monitor all outstanding major DFS and ensure ISIC records agree with TYCOMs and pursue DFS clearance.
 - (5) Obtain Program Manager approval of all DFSs in DSS SOC systems, unless the Program Manager has delegated, in writing, authority to approve specific routinely recurring DSS SOC DFSs or authority to approve minor DSS SOC DFSs.
 - (6) Keep the Program Manager and SCA informed of all DFS requests.
 - (7) Liaison with the Program Manager on any outstanding DFS items requiring NAVSEA action. Provide a periodic status report to the Program Manager of those DFSs for which NAVSEA action is overdue.
- c. Perform assessments of ISICs responsible for DSSs annually not to exceed 18 months.
- d. At the discretion of the TYCOM perform random, unannounced User/Sustaining Activity Quality Assurance (QA) assessments and monitor visits.

NOTE: THE SCA, NOT THE TYCOM, ALSO APPROVES INITIAL DSS CERTIFICATION.

- e. Review and evaluate ISIC reports of corrective action taken on QA assessments to ensure compliance with this program.
- f. Perform an annual self evaluation of the QA program.
- g. Evaluate and analyze proposed changes to this volume.
- h. Recommend to the SCA suspension and reinstatement of DSS certification as appropriate.
- i. Perform annual SOC awareness training for staff members that routinely review SOC Objective Quality Evidence (OQE), make determinations on SOC DFSs and perform other SOC work oversight functions.

1.2.2 Immediate Superior In Command. The ISIC for the DSS and host submarines and ships is responsible for the following:

- a. Organize and implement a QA program to carry out the provisions of this volume.
- b. Organize and implement a program to verify performance of required maintenance to sustain the material condition necessary to support Unrestricted Operations to authorized operating depth in accordance with the applicable class Hull Integrity Procedure Maintenance Requirement Card manual and Volume VI of this manual.
- c. (Submarines only) Organize and implement a work request screening process such that those jobs requiring special controls are recognized and the supporting technical documentation is provided to the maintenance activity as required by this volume (not applicable to COMNAVSPECWARCOM).
- d. Ensure DSS certification continuity report, when required by this volume, is received and reviewed before DSS manned use. In particular, the ISIC will ensure all Hull Integrity Procedure planned maintenance is up to date. Discrepancies noted must be resolved prior to underway.
- e. In accordance with reference (a), paragraph 3.7.4, when performing manned operations (manned use) in pursuit of certification or reinstatement of certification, review and approve User/Sustaining Activity requests prior to conducting these operations, as applicable.
- f. Review and sign the Memorandum of Agreement (MOA) required by Volume II, Part I, Chapters 3 and 4, of this manual and reference (a). This agreement will list the responsibilities and actions of each party before start of any availability (e.g., Tiger Team repairs, technical assist visits) that involves work within SOC boundaries to ensure responsibilities for recertification of work performed is not split between maintenance activities and that each activity is responsible to certify the work they performed.
- g. Administer a DFS system to:
 - (1) Establish and maintain system of processing requests for DFSs.
 - (2) Review and evaluate DFS requests and obtain clarification of technical specifications from TYCOM/NAVSEA where appropriate.
 - (3) Approve or disapprove DFS requests as authorized by the applicable SOC Notebook.
 - (4) Obtain TYCOM/NAVSEA approval of DFS when required by the appropriate TYCOM/NAVSEA directive, technical specification or manual.
 - (5) (Submarines only) Ensure the deployed ISIC directing the supporting Fleet Maintenance Activity (FMA) will act as the cognizant ISIC for those actions required to approve, review and track DFSs for ships deployed. The parent ISIC, with concurrence from the deployed ISIC, may, on a case by case basis, perform these functions. In such cases, the parent ISIC will inform the deployed ISIC when such action(s) concurred upon is/are complete.
 - (6) (Submarines only) The parent ISIC will provide a complete file of all outstanding DFSs to the deployed ISIC, prior to any ship deployment. The deployed ISIC will provide a complete file of all outstanding DFSs to the parent ISIC at the end of deployment.
 - (7) Specify procedures for:

- (a) Submission of OPNAV form 4790/2K for DFSs that require a future maintenance action to clear the departed condition.
 - (b) Submission of OPNAV form 4790/CK for permanent repair DFSs which result in new Allowance Parts List and Coordinated Shipboard Allowance List support requirements.
- (8) (Submarines only) Keep parent ISIC apprised on the status of DFSs for deployed units.
- (9) Maintain files of outstanding DFSs.
- (10) Aggressively pursue clearing of DFSs.
- h. (Submarines only) Monitor the QA program and procedures of assigned FMA periodically and monitor corrective actions on discrepancies noted during the last TYCOM audit.
- i. (Submarines only) Schedule and conduct a QA Program assessment in conjunction with the Fleet Readiness Training Plan (or as determined by each TYCOM) of all assigned ships to ensure the repair actions undertaken by Ship's Force conform to the provisions of the QA Program as well as pertinent technical requirements.
- j. (Submarines only) Review and endorse TYCOM audit report of assigned FMA(s).
- k. Conduct periodic monitoring of Ship's Force work and QA program on all assigned DSS during maintenance periods.
 - (1) Perform at least one surveillance during each refit/upkeep/FMA availability.
 - (2) Conducting monitoring during industrial availabilities (e.g., Selected Restricted Availability, Drydocking Selected Restricted Availability, Extended Refit Period, Post Shakedown Availability, Phased Maintenance Availability, Docking Phased Maintenance Availability, Depot Modernization Period, Engineered Refueling Overhaul and Regular or Refueling Overhaul).
- l. Properly maintain certification on assigned DSS.
- m. Review and evaluate User/Sustaining Activity reports of corrective action taken on SCA Surveys to ensure compliance with this program. Retention of OQE to substantiate reviews or evaluations is not required except in the case where the review or evaluation of a Survey response was determined to be unsatisfactory.
- n. Ensure the Sustaining Activities properly perform internal surveys in accordance with reference (a).
- o. Ensure Sustaining Activities properly process requests for sustaining certification.
- p. Perform QA assessments of the Sustaining Activities/User Activities associated with the DSS and host submarines and ships annually not to exceed 18 months. Forward results of the assessments to the TYCOM and Program Manager.
- q. Route all appropriate DSS SOC DFSs to TYCOM and Program Manager for approval.
- r. Conduct a vertical audit of assigned DSS unit's OQE for all work within the SOC accomplished by the User Activity and the Sustaining Activity prior to the first sea trials or manned operation at the end of each major availability and after completion of any major repairs, modifications or alterations completed during non-depot level availability periods. Not required if an SCA Survey is scheduled at the conclusion of the availability.
- s. Perform annual SOC awareness training for staff members that routinely review SOC OQE, make determinations on SOC DFSs and perform other SOC work oversight functions.
- t. Ensure fact-finding critiques are held to establish underlying causes and pursue corrective actions when necessary. When major errors or problems occur during maintenance of DSS/SOC systems, a critique may be necessary. Examples include when significant problems or trends occur or those that did result or could result in incidents, significant unplanned rework, serious equipment damage, malfunction or

personnel injury. Minor problems are isolated deficiencies with minimal overall impact and no significant consequences; these should normally be corrected on the spot and without expending much time and effort.

- (1) Contact the TYCOM immediately of issues which will be result in a Submarine Safety (SUBSAFE)/Fly-By-Wire (FBW) Ship Control System (SCS)/DSS/SOC critique, SUBSAFE/FBW SCS/DSS/SOC trouble report and/or SUBSAFE/FBW SCS/DSS/SOC fact-finding.
- (2) (Submarines only) Additional guidance and direction for critiques is contained in reference (b).
- (3) (Submarines only) Copies of critiques and incident reports for DSS/SOC issues that result in a problem severity level of Level 1 (critical) will be sent to the TYCOM electronically.

1.2.3 Sustaining Activity/User Activity. Sustaining and User Activities in some cases may be the same organization. The Sustaining Activity is responsible for ensuring that the requirements established in the Letter of Certification and reference (a) are met. The Sustaining Activity and User Activity will:

- a. Follow REC procedures during re-entry of a certified component, system or a portion of a system.
- b. Document all deviations from the certification requirements in a form suitable for survey.
- c. Accomplish periodic maintenance actions as specified in the supporting requirements developed for each DSS and ensure that adequate OQE is available during surveys in a format conducive to review.
- d. Ensure accountability of maintenance for each DSS and establish an auditable system of scheduling, performing and reporting accomplishment of Maintenance Requirement Cards.
- e. Submit an official request to NAVSEA for continuation of certification for a specific time period and include written rationale for the continuation together with a status of maintenance and system condition.
- f. Sustaining Activities will conduct internal surveys in accordance with section 4.1.2 of reference (a) and:
 - (1) If the SCA sustaining certification survey periodicity is 15 months or greater, perform at least two internal surveys between the SCA surveys, not to exceed a 12 month periodicity.
 - (2) Prior to the SCA on-site survey, conduct an internal survey to evaluate compliance with certification requirements.
 - (3) For other than overhaul or new construction, complete the Sustaining Activity's internal survey and submit it to the Program Manager in accordance with the applicable SOC notebook or reference (a) section 4.1.2.
 - (4) Overhaul/New Construction. The activity's internal survey must be completed not more than 30 days prior to the SCA survey and the results of the internal survey must be submitted to NAVSEA at least 10 working days prior to the start of the SCA survey.
 - (5) Obtain NAVSEA approval of an updated Certification Survey Plan at least two weeks prior to the SCA survey for an SCA Certification Survey Only.
- g. Report to NAVSEA resolution of all survey deficiencies.
- h. Retain the completed maintenance and dive log, including, where required, pre-dive and post-dive check-off procedures for all evolutions from survey to survey. The procedures utilized must have prior Program Manager and SCA concurrence.
- i. Obtain NAVSEA approval for alterations to items within the SOC. This includes the addition of any mission-related equipment outside the defined lines of the DSS as deemed necessary by the SCA.
- j. Accomplish and report Maintenance Requirement Cards and Hull Integrity Procedures in accordance with assigned periodicities approved by the Program Manager and immediately resolve any unacceptable conditions found as a result of conducting the maintenance procedures or inspections.

- k. Review and sign the MOA required by Volume II, Part I of this manual. This agreement, as a minimum, shall define the activity's functions and responsibilities for implementing and administrating REC procedures. Volume II, Part I of this manual contains specific requirements for MOAs. All applicable activities must sign the MOA prior to the start of work.
- l. The User Activity must issue the DSS certification continuity report before manned operations (Not applicable when in pursuit of certification or reinstatement of certification per reference (a) paragraph 3.7.4.). For vehicles loaded on submarines the certification continuity report must be issued prior to the underway of the host ship (not required to issue DSS certification continuity report for work performed at sea).
- m. Obtain formal approval for any temporary modifications prior to installation in a DSS from the Program Manager. Submit the request to the Program Manager and include the items listed in section 5.4.4 of reference (a) and any other items as required by the Program Manager.
- n. Operate the DSS within the limits specified as part of the requirements for each sustaining certification.
- o. The Sustaining Activity shall report any violation of the DSS operating limits to NAVSEA stating the cause or justification for the violation.
- p. Keep the Program Manager and SCA advised of any failure or improper operation experienced by, or damages sustained to, any item or system within the SOC.
- q. The responsibilities listed in Part I, Chapter 1 Section 1.5 of this volume apply to the User/Sustaining Activity. Each activity shall comply with the applicable responsibilities listed in this section. For instance, DSSs are responsible for the duties listed in the Ship Commanding Officer section.
- r. When the sustaining Activity is different than the user activity, the Sustaining Activity will issue a written report to the User Activity, with a copy to parent ISIC, which addresses the status of SOC RECs, testing of SOC systems, Hull Integrity Procedure maintenance requirements completed and DFS items.
- s. Ensure fact-finding critiques are held to establish underlying causes and pursue corrective actions when necessary. When major errors or problems occur during maintenance of DSS/SOC work, a critique may be necessary. Examples include when significant problems or trends occur or those that did result or could result in incidents, significant unplanned rework, serious equipment damage, malfunction or personnel injury. Minor problems are isolated deficiencies with minimal overall impact and no significant consequences; these should normally be corrected on the spot and without expending much time and effort. Contact the ISIC immediately of issues which will result in a SUBSAFE/FBW SCS/DSS/SOC critique, SUBSAFE/FBW SCS/DSS/SOC trouble report and/or SUBSAFE/FBW SCS/DSS/SOC fact-finding (Submarines only) Additional guidance and direction for critiques is contained in reference (b). Copies of critiques and incident reports for DSS/SOC issues that result in a problem severity level of Level 1 (critical) will be sent to the TYCOM electronically.

Examples include, but are not limited to the following:

- (1) Noncompliant work or technical direction resulting in nonacceptable material within the DSS/SOC boundary (e.g., incorrect material installed, failure to complete recertification actions, incorrect torque applied, improper conduct of testing, wrong weld procedure, lack of/incorrect Nondestructive Test, unqualified welder, failure to use specified measuring device, etc.).
- (2) Inaccurate or missing information/data provided on deliverable DSS/SOC technical documents affecting the certification status (e.g., certification messages, Unrestricted Operations Maintenance Requirement Card data reports).
- (3) Conduct of work within the SOC boundary without required authorization or re-entry control.
- (4) Failure to accomplish mandatory SOC related PMS within the required periodicity.

- (5) Performance of DSS manned operations with an open Category 1A, Category 1B (unless as allowed by the card) or expired Category 1C system certification survey card, or outside of the allowed sustaining certification periodicity.
- (6) Operation of SOC systems contrary to/or without a NAVSEA approved procedure.

VOLUME V
PART III
CHAPTER 2
QUALITY MAINTENANCE PROCESSES

REFERENCES.

- (a) NAVSEA 0924-062-0010 - Submarine Safety (SUBSAFE) Requirements Manual
- (b) NAVSEA SS800-AG-MAN-010/P-9290 - System Certification Procedures and Criteria Manual for Deep Submergence Systems

2.1 APPLICABILITY. Use all of the quality maintenance processes specified in Part I, Chapter 2 of this volume.

2.2 CONTROLLED WORK PACKAGE. A Controlled Work Package is required for those items listed in Part I, Chapter 2, Paragraph 2.2.4 of this volume and the following items:

- a. Installation of Material Control Division A, B or C materials.
- b. Work within Scope of Certification (SOC)/hull integrity boundary, identified in reference (a), (b) and/or the applicable Deep Submergence System (DSS) SOC Notebook, including pressure hull grinding, cutting and welding.
- c. Painting in excess of 10% of any DSS compartment including the interior of the transition trunk on the host ship above the access hatch.
- d. Installation and maintenance on implodable items within the SOC boundary and all explodable items that meet the requirements of reference (b) and/or the applicable DSS SOC Notebook.

(This Page Intentionally Left Blank)

VOLUME V
PART III
CHAPTER 3
PERSONNEL QUALIFICATION AND TRAINING

REFERENCE.

- (a) NAVEDTRA 43523 - Personnel Qualification Standard for Quality Maintenance Program

3.1 APPLICABILITY. Use the training and qualification requirements specified in Part I, Chapter 3 of this volume as modified in the following paragraphs.

3.2 GENERAL. Personnel who screen, plan, perform, inspect and supervise maintenance as listed in Part I, Chapter 2, paragraph 2.2.1 and Part III, Chapter 2 of this volume shall be trained and qualified in accordance with this volume and reference (a).

3.3 DISCUSSION. For Deep Submergence Systems, modify the training specified in the qualification standard of reference (a) and the appendices of Part I, Chapter 3, of this volume to include Scope of Certification (SOC) knowledge and practical factors. Send the revised qualification cards to the applicable Type Commander via the Immediate Superior In Command. The Type Commander will standardize qualification requirements for all subordinate commands dealing with SOC issues.

3.4 QUALIFICATION REQUIREMENTS.

3.4.1 Qualifications. Most User Activities are too small and do not have billets for Quality Assurance Officers (QAO). However, the responsible Immediate Superior In Command will have a QAO qualified in accordance with Part 1, Chapter 3, paragraph 3.4.3 of this volume. The Sustaining Activity will have a QAO qualified in accordance with Part 1, Chapter 3, paragraph 3.4.4 of this volume.

3.4.2 Scope of Certification Quality Maintenance Qualifications. Use the qualification requirements for other qualifications as listed in Part I, Chapter 3 of this volume. Note that not all qualifications would apply.

3.5 TRAINING.

3.5.1 Scope of Certification Awareness Training (Submarines and Submarine Repair Facilities only). All maintenance crew members required to qualify as craftsman on board submarines with SOC systems or components shall receive SOC awareness training during initial indoctrination and annually thereafter. All personnel assigned to a command responsible for performing maintenance on submarine system(s) within the SOC boundary shall receive SOC awareness training during initial indoctrination and annually thereafter. Immediate Superior In Command and Type Commander staff members that routinely review SOC Objective Quality Evidence, make determinations on SOC Departures from Specifications and perform other SOC work oversight will receive annual SOC awareness training to keep knowledge and proficiency levels high.

(This Page Intentionally Left Blank)

VOLUME V

PART III

CHAPTER 4

WELDER, BRAZER AND NON-DESTRUCTIVE TESTING QUALIFICATIONS

4.1 APPLICABILITY. Use all of the welder, brazer and non-destructive testing qualifications as specified in Part I, Chapter 4 of this volume.

(This Page Intentionally Left Blank)

VOLUME V
PART III
CHAPTER 5
IN-PROCESS CONTROL

REFERENCES.

- (a) NAVSEA SS800-AG-MAN-010/P-9290 - System Certification Procedures and Criteria Manual for Deep Submergence Systems
- (b) NAVSEAINST 4790.8 - Ship's Maintenance and Material Management (3M) Manual
- (c) MIL-STD-1330 - Standard Practice for Precision Cleaning and Testing of Shipboard Oxygen, Helium, Helium-Oxygen, Nitrogen and Hydrogen Systems
- (d) NAVSEA S9086-CM-STM-010 - NSTM Chapter 078 (Gaskets, Packing and Seals)
- (e) NAVSEAINST 4720.23 - Deep Submergence Systems Temporary Modifications

LISTING OF APPENDICES.

- A Message Format for Certification Continuity for DSS
- B Letter Format for Certification Report to Tended DSS
- C Message Format for DDS Transfer of Custody Certificate of Continuity for Off-loads
- D Message Format for DDS Transfer of Custody Certificate of Continuity for On-loads
- E Message Format for DDS Acceptance of Custody

5.1 PURPOSE. To provide the requirements or direct the user to the appropriate references to ensure that maintenance performed during the Deep Submergence System's (DSS) life cycle supports certification at all times. Sustaining Activities, User Activities and Maintenance Activities should review specific system requirements for additional or superseding requirements. All material used within any DSS shall be as authorized for the specific DSS as required by reference (a).

5.2 EXCEPTIONS TO RE-ENTRY CONTROL. Exceptions to Re-Entry Control (REC) shall be listed in the applicable DSS Scope of Certification (SOC) Notebook.

5.3 PLANNED MAINTENANCE. Completion of Planned Maintenance System (PMS) is mandatory for continued certification of DSS units. Each DSS unit's PMS program will be administered per reference (a), reference (b) and the applicable SOC Notebook. **Any incomplete SOC PMS and/or SOC PMS not performed when scheduled requires a major Departure From Specification (DFS) to be processed and adjudicated prior to executing manned SOC operations.** The Program Manager will determine SOC-REC implementation based on the maintenance task complexity, system boundary and material control requirements. It is critically important to realize that even though a particular maintenance procedure does not require a REC, any repair or replacement of SOC components necessary to correct a deficient condition identified during that maintenance may require a REC. There are two documentation categories for SOC PMS:

- a. SOC - REC Required. Each SOC-REC PMS item requires the issuance of a REC Form and associated Controlled Work Package (CWP).
 - (1) Each SOC PMS Maintenance Requirement Card (MRC) card will utilize the following note or an equivalent note that has been approved by the System Certification Authority (SCA): "This maintenance involves equipment within the DSS SOC as defined by the SOC Notebook or applicable document. Performance of this maintenance requires that REC be utilized."
 - (2) This maintenance will be documented and audited using the REC as Objective Quality Evidence.
- b. SOC - NO REC Required. PMS items exempted from re-entry controls:
 - (1) Each SOC PMS Maintenance Requirement Card (MRC) will utilize the following note or an equivalent note that has been approved by the SCA: "This maintenance involves equipment within the DSS SOC as defined by the SOC Notebook or applicable document. Performance

of this maintenance does not require REC. However, if repair or replacement of any component is necessary, compliance with system certification requirements must be documented.”

- (2) The Sustaining Activity shall, depending on the frequency and complexity of the maintenance action, determine the methodology of documenting the accomplishment and completion of SOC PMS in a form suitable for audit. The maintenance requirements shall identify that documentation is required.

5.4 TEST, MEASUREMENT AND DIAGNOSTIC EQUIPMENT. Follow the requirements specified in Part I, Chapter 5, Section 5.2 of this volume regarding Test, Measuring and Diagnostic Equipment for in-process work.

5.5 TORQUE. Follow the requirements specified in system drawings and Part I, Chapter 5, Section 5.3 of this volume for torque applied to components.

5.6 INSPECTIONS.

5.6.1 General Requirements. This section provides the minimum requirements and guidance for the performance of inspections. Inspections during the performance of maintenance form one of the fundamental elements essential in assuring that the task is completed properly and in compliance with all specifications. Inspections occur during the in-process phase of repair/maintenance (disassembly, repair, and re-assembly) and the re-certification phase (testing). Inspections serve to provide a careful and critical examination of the areas being inspected and form one of the cornerstones of a successful Quality Assurance (QA) Program. Use of inspections have and will continue to establish the Objective Quality Evidence (OQE) necessary for ensuring compliance to technical requirements.

5.6.2 Inspection Records. Inspection records provide a lasting record that the inspection was performed and completed according to the applicable specifications. Inspection records will be maintained when required for OQE and will be documented on appropriate QA forms contained in this volume or as Certification Signature Blocks in the Formal Work Package (FWP).

5.6.3 Critical Inspections. An inspection on any system or component, which by its nature is so critical to the successful completion of the task, that the inspection requires verification by a separate individual, other than the craftsman, qualified as an inspector. These inspections will be annotated in the written work procedure by the presence of an (I) or circle I, or in the case of Cleanliness Inspections (CI) or circle CI in the margin next to the applicable paragraph requiring the inspection and will be documented as a signature in the FWP or on the appropriate QA form. Critical Inspections applicable to all DSS Systems or components are as follows:

NOTE: THESE ARE CONSIDERED MINIMUM REQUIREMENTS FOR USAGE OF AN INDEPENDENT INSPECTOR DURING THE PERFORMANCE OF SOC CONTROLLED WORK. IT MUST BE UNDERSTOOD THAT THE REQUIREMENTS FOR AN INDEPENDENT INSPECTOR DO NOT NECESSARILY MEAN THAT THE DATA PROVIDED IS RETAINABLE AS OQE. VARIOUS SOURCE DOCUMENTS ADDRESS RECORD RETENTION AND SHALL BE FOLLOWED FOR ENSURING THE PROPER OQE IS RETAINED.

- a. Inspections performed for all acceptance testing (e.g., hydrostatic testing, drop tests, joint tightness tests, weight tests) for certification of work completed under a CWP.
- b. Inspections performed to verify permanent traceability markings of SOC Material Control Division A material assigned and made locally at either a Fleet Maintenance Activity (FMA), a Sustaining Activity or at the User Activity. These inspections may also be performed by a Controlled Material Petty Officer.
- c. Inspections performed to verify permanent markings of Level I/SOC material (those which the FMA manufacture or transfer to smaller pieces of controlled material). These inspections may also be performed by a Controlled Material Petty Officer.
- d. Mechanical measurements used to verify wall thickness of components for work performed using a CWP.
- e. Inspections performed for post machining of any SOC component.
- f. All sealing surface inspections for work performed as a Controlled Assembly.

- g. Inspections for oxygen or nitrogen systems cleanliness as required by reference (c). These independent inspections are performed by personnel qualified as Oxygen Clean Workers per reference (c).
- h. Material receipt inspection. These inspections may also be performed by a Controlled Material Petty Officer.
- i. Weight testing or Pull Testing of SOC components.
- j. Performance of Emergent Controlled Work in accordance with Part I, Chapter 2 of this volume.
- k. Sealing surface inspections for all SOC pressure boundary joints.
- l. Hull Integrity joint body bound stud inspections. For new stud installations, this includes stud stand out measurements and break away torque verification. For studs that were not removed and are to be reused, this includes verification of markings of significance (.K. or KM) or completion of generic material identification check.
- m. Verification of body bound stud stand out measurements and break away torque for new stud installations in SOC systems.
- n. Final torque verification of SOC pressure boundary joints.
- o. Verification of new controlled material installed into the SOC boundary.
- p. Verification of proper software installation in SOC pressure boundary joints.
- q. Stack height measurement verification for hull packing installation.
- r. Seat tightness tests of SOC hull and backup valves. When seat tightness testing is impractical, verification of stack height and cavity dimensions or seat blue checks as applicable.
- s. Surface finish inspection and final torque verification of SOC Host interface non-pressure boundary bolted joints (i.e., DDS pedestals, etc.).

5.6.4 Cleanliness Inspections. Cleanliness controls are required to prevent the entry of foreign material which could interfere with the operation of any system or component. Cleanliness controls are essential during maintenance with the degree of control depending upon the system and work to be accomplished. Hydraulic system cleanliness controls are necessary to minimize degradation of components and system leaks. Life Support system cleanliness controls are necessary to ensure the safety of personnel. Improper cleanliness controls can result in personnel injury or damage to operating machinery or fouling of system components. The time spent making sure the work site is clean and system openings are properly controlled will help prevent premature component failure and rework.

- a. Cleanliness Inspectors are individuals who are trained and qualified to perform CI required by work procedures for systems/components requiring cleanliness controls. At the TRIDENT Refit Facilities, they are called Cleanliness Certifiers.

NOTE: ALL SYSTEMS REQUIRE VARYING DEGREES OF CLEANLINESS CONTROLS, BUT MAY NOT REQUIRE AN INDEPENDENT INSPECTOR. CRITICAL QUALITY CONTROL POINT INSPECTIONS BY SUPERVISORY PERSONNEL SHOULD BE USED WHERE APPROPRIATE.

- b. Acceptance inspections of cleanliness by an independent inspector (Cleanliness Certifier/Inspector) are required for the following as a minimum: Oxygen or nitrogen systems per reference (c).
- c. Results of cleanliness acceptance inspections required by paragraph 5.6.4.b of this chapter shall be documented in the Technical Work Document and certified by a signature. These inspections will be identified by a (CI) or circle CI in the left margin, if performed by an independent inspector.
- d. There are no specific requirements for independent CI/acceptance by a Cleanliness Certifier/Inspector, during many SOC maintenance actions. However, many jobs may be performed using a craftsman to verify cleanliness vice requiring independent Cleanliness Inspector presence. When the risk or consequence of loss of cleanliness is minimal during a maintenance action, such as work requiring bonnet removal from a small hydraulic valve, maintenance of cleanliness may be verified by the craftsman. When the risk or consequences of loss of cleanliness is significant, such as when removing

the bonnet from an oxygen or nitrogen valve or when the type or quantity of detrimental materials (e.g., cutting oils) pose a significant risk, the use of an independent inspector to verify maintenance of cleanliness should be considered by the Department Head, Quality Assurance Officer (QAO) and Planning Officer (if assigned).

- e. It is the responsibility of User Activity to ensure the appropriate cleanliness control requirements are incorporated in any maintenance for which clear responsibility for cleanliness is not assigned.

5.7 SOFTWARE.

5.7.1 Determination of Acceptability and Use of Piping System Software. For SOC system maintenance, software should always be selected per the approved plans and drawings. However, to assist in the determination of acceptability of non-metallic packing materials (e.g., O-Rings, wall seals) for installation in SOC systems, decision aids have been developed from reference (d) and are provided in Part I, Chapter 5, Appendix A of this volume. Because software can contain critical attributes in SOC systems, a Liaison Action Request (LAR) to the Planning Yard may be appropriate to resolve conflicts in requirements.

- a. It is Fleet policy that software (e.g., O-Rings, gaskets) will be reused only as a last resort. If new software is not available, software may be used after satisfactory inspection for damage, resiliency, discoloration or cracking in accordance with reference (d). This inspection will be documented in the CWP or FWP.
- b. In all cases, the guidance provided in applicable Naval Sea Systems Command (NAVSEA) technical documents (e.g., drawings, component technical manuals) for SOC systems and components will be followed.
- c. Reuse of software during daily PMS or other specified situations. The practice of not reusing software does not apply to items of daily PMS or items disturbed in the normal operation of a component per an approved operating procedure and, therefore, the O-Ring or gaskets may be reused provided the software has been inspected and is not damaged and new software is not required per the procedure.

5.8 SCOPE OF CERTIFICATION MAINTENANCE CERTIFICATION/RE-ENTRY CONTROL.

5.8.1 Purpose. To promulgate the policy and procedures for:

- a. Maintaining continuity of SOC certification during the operating cycle.
- b. General Maintenance Certification Record administrative requirements.

5.8.1.1 General.

- a. Reference (a) establishes the SOC certification criteria which must be accomplished on DSS in order for NAVSEA to certify the DSS for operation. Once the certification criteria are satisfied, NAVSEA will issue a letter of certification to the Sustaining Activity. Based upon the NAVSEA letter of certification, the Sustaining Activity and the User Activity will operate the DSS within the SOC as authorized by NAVSEA in the SOC Notebook, Operating Instructions, Operating Procedures, Emergency Procedures, technical manuals or other directives governing operations.
- b. Sustaining Certification for continued operation is dependent on:
 - (1) The positive control and re-certification of all re-entries into the SOC or hull integrity boundaries of the DSS, and
 - (2) The satisfactory and timely completion of Hull Integrity Procedure (HIP) requirements, and
 - (3) Completion of SOC PMS within periodicity and as written.

5.8.2 Re-Entry Control Program.

- a. Applicability. This section is applicable whenever work is accomplished within a SOC boundary as defined by reference (a), and as depicted in the specific DSS SOC Notebook.

NOTE: THE SCA IS THE FINAL AUTHORITY FOR DETERMINING IF AN ITEM IS WITHIN THE SOC BOUNDARY. THE SOC NOTEBOOK IS AN ILLUSTRATED REFERENCE TO AID IN THE DETERMINATION OF WHETHER AN ITEM IS SOC OR NOT.

- b. General. The REC Program includes those elements associated with maintenance and/or repair necessary to maintain the certification established by NAVSEA. The program provides auditable OQE of the following:
 - (1) What work was accomplished, including material and components used, re-test requirements, tests performed and test data.
 - (2) Why work was required.
 - (3) Who authorized and accepted the REC.
 - (4) Who did the work.
 - (5) When and where the work was accomplished, including the work and re-test boundaries.
- c. When it becomes necessary to re-enter a SOC certified system or structure, it will be accomplished in accordance with the requirements and procedures of paragraph 5.8.3 of this chapter. Specific direction on completing the Maintenance Certification Record (MCR) (QA form 9) is contained in the instructions for QA form 9 in Part I, Chapter 11 of this volume.
- d. Some exceptions to RECs are allowed due to frequent entry into the certified boundary for routine operations or maintenance actions. These exceptions and administrative and/or operational control requirements are contained in paragraph 5.8.6 of this chapter.
- e. NAVSEA DSS Grams are not authorized for use by sustaining activities or maintenance activities managed by the Type Commander (TYCOM). DSS Grams will be engineered into the Joint Fleet Maintenance Manual where appropriate.

5.8.3 Re-Entry Control Administrative Procedures.

- a. General. REC procedures provide a continuous, auditable record of work done on fully certified systems to provide positive assurance that they remain “certified”. Continuity of Certification is mandatory throughout the operational life of the DSS to ensure continued safe operation within design limits for personnel safety.
- b. REC. When re-entry of a SOC system or a portion of a SOC system (or component) is necessary, the work and re-certification of the work will be documented using the MCR/REC, QA form 9.
 - (1) An MCR/REC will be used for each re-entry of each certified system, certified component or portion thereof as defined by the SOC certification boundaries.
 - (2) An MCR/REC will be restricted to a single system within a single mapping plan, a single component removed from a system or a single component removed/worked that requires multiple mapping plans.
 - (3) When an MCR/REC is opened on a DSS to permit removal of a component by Sustaining/User Activity for repair by an FMA as a “ship to shop” job, an MCR/REC must be opened by the FMA to cover the work and retesting of the work center work performed.

NOTE: AN AUTHORIZED CONTRACTOR MAY BE PERFORMING WORK AS THE FMA OR DEPOT ACTIVITY. THE SPECIFIC MEMORANDUM OF AGREEMENT WILL FURTHER AMPLIFY THESE PROCEDURES AND THE INTERACTION WITH THE SUSTAINING/USER ACTIVITY.

- (4) Where other certified systems must be re-entered to accomplish an MCR/REC, each system will have its own MCR/REC, except as described in paragraph 5.8.3.b.(2) above.
- (5) The MCR/REC and records of MCR/REC will contain all of the OQE necessary to comply with paragraph 5.8.2.b. above.
- (6) The work procedures associated with an MCR/REC will contain sufficiently detailed instructions to assure that all requirements for certification are properly accomplished and documented.
- (7) Work and test boundaries will be defined in terms that are unique and directly identifiable with the specific mapping plan and/or task involved.

- (8) When work and test boundaries are different, both boundaries will be set forth. The work boundaries, test boundaries and pressure boundaries should be specified and should not be confused. Work boundaries define the limits to which work was performed. Test boundaries define the limits for testing to certify the work; these tests may involve actuators, indicators or components other than those actually repaired. Pressure boundaries define (perhaps by valve lineups) the limits of the system which were pressurized to hydrostatically test the work. The pressure boundaries and test boundaries may be the same.
- (9) On a “ship to shop” job the work boundaries may be best described by system joint designators even though those joints were not “disturbed” by the FMA (e.g., rebuild a Rubber Insert Sound Isolation Coupling, the work/test boundaries will be the end flanges that bolt up to the system, the joint identification numbers may be clearest identification of that boundary point).
- (10) Previously certified hardware will be reused when certification is not affected by the re-entry, or when it can be recertified. The words “replace”, “repair” and “re-install” should be used carefully. “Replace” means the use of a different/new component, while “re-install” indicates the use of the previously installed component, whether repaired or not. “Repair” indicates that some refurbishment, other than mere disassembly and/or cleaning, was performed.
- (11) Associated supporting documents such as Nondestructive Testing (NDT) records, material certification, test data, etc., will be specifically identified and referenced on the MCR/REC.
- (12) When it becomes necessary for an FMA to re-enter NON-Depot Level Repairable certified components (rotatable pool, bench spares) which will not be returned to the DSS from which it was removed, or when a component is re-entered when the DSS on which it will be installed is not present, the FMA will control the work and document the re-entry using a QA form 9, MCR/REC. The MCR/REC will be initiated and closed out by the FMA. A copy of the completed MCR/REC will accompany the component when it is installed in a SOC certified DSS or shipped to another activity as proof of certification. These controls are required whether the certified component is to be installed in certified SOC DSS or stored. Each component must retain its certification. These RECs are separate from and in addition to any MCR/REC required for removal of a component from a SOC system and are only necessary whenever the original component will not be returned during the current availability to the ship from which it was removed.
- (13) The CWP/REC Log, QA form 11, will be established and maintained by the QAO in accordance with the detailed instructions for QA form 11 in Part I, Chapter 11 of this volume. The QA form 11 shall be reviewed by the QAO to verify all MCR/RECs are closed prior to manned and/or submerged operations of the DSS, except as discussed in reference (a), paragraph 3.7.4. The FMA QAO will maintain a log for the FMA only and one for each tended ship RECs. The QA form 11 shall be reviewed by the FMA QAO to verify all FMA MCR/RECs are closed prior to manned and/or underway operations of each tended ship/DSS, except as discussed in reference (a), paragraph 3.7.4.
- (14) Revisions to the MCR/REC are required for the following:
 - (a) Change in work boundaries (e.g., breaking additional or new mechanical joints not previously identified on the MCR/REC). A REC revision is not required to delete undisturbed joints. Deletion of joints must be authorized by cognizant technical authority and documented in the REC package. Block 13 must be annotated to reflect joint deletions prior to signing REC Block 16.
 - (b) Change in NDT or test requirements (e.g., “J” vice H hydrostatic test, when “H” was originally specified). This does not include a DFS for unaccomplished testing. A REC revision is not required for NDT incidental to minor repairs as defined in paragraph 5.8.3.b.(14) (d) below. NDT results must be documented in the REC package.

- (c) Scope of work changes (e.g., originally replace software changed to weld repair sealing surfaces, originally replace software changed to metallic pressure boundary part replacement).
- (d) The REC does not require revision in order to conduct minor repairs in support of the original scope of work. These minor repairs must be authorized by cognizant authority and documented in the REC package, with appropriate OQE generated and added to Block 15 prior to the signing of Block 16 of the QA form 9. Hot work is not classified as a minor repair. Minor repairs authorized to be performed without a revision are:
 - 1 Minor machining such that the machining is within the limits of the technical drawing, Maintenance Standard or technical manual (e.g., taking a skim cut on an O-Ring groove such that the final machined dimensions are within the tolerances of the technical reference).
 - 2 Epoxy repairs.
 - 3 Electroplate repairs.
 - 4 Preventive coating application.
- (15) A revision cannot be used when a new MCR/REC is required (e.g., different system must be entered to conduct repair).
- (16) REC Cancellation and REC Administrative Closeout. In the event a CWP is prepared and the job is planned to be accomplished but for some reason it was cancelled or deferred, the following actions should be taken:
 - (a) If work was authorized to start, the CWP/REC must be revised to reflect that no work was accomplished and the REC was revised to close administratively. The QA form 11 log will be annotated that the job was "Cancelled".
 - (b) If work was not authorized to start, and the job has been cancelled, annotate the remaining blocks of the QA form 9 with "NA" and note that the REC was cancelled and no work was accomplished. Blocks 20 and 21 will be signed to formally close the REC. If the REC was prepared by a Repair Facility, a copy of the QA form 9 will be provided to the tended unit with the Certification Continuity Letter. QA form 11 log will be annotated that the job was "Cancelled".
 - (c) If work was not authorized to start and the job has been deferred to a future maintenance period, the REC is not required to be cancelled. The QA form 11 log will be annotated as "Deferred". This is not considered an open REC.
- (17) Prior to manned operations (and each submarine underway for submerged operations) except as discussed in reference (a) paragraph 3.7.4, the USER ACTIVITY will submit to the Immediate Superior In Command (ISIC), a written report in accordance with paragraph 5.8.7 of this chapter. An SOC certification letter is only required.
- (18) Ship's Force is responsible for providing "Buddy" SOC REC serial numbers to outside repair activities performing SOC work on the DSS systems. The Buddy REC number is issued from ship's QA form 11 log and will be documented on repair activities SOC/REC FORM.

5.8.4 Using a Departure from Specification to Close a Maintenance Certification Record/Re-Entry Control. If an MCR/REC is closed by transferring accountability for testing to an at-sea testing DFS, the DSS will be restricted as follows:

- a. The unit shall dive to the maximum depth at which it is to be certified or recertified to operate. The affected joints shall be inspected for joint tightness during initial submergence and subsequently at 200 foot intervals. Operations are restricted to that depth at which satisfactory joint tightness has been certified. Inspections shall be conducted at 200 foot intervals down to the maximum depth at which it is to be certified or recertified to operate. The test dive may be a single dive or a series of dives to

accomplish the same purpose. The DSS will stay at test depth for the time required as detailed in the normal retest procedure (i.e., 30 minutes if the normal joint tightness test is for 30 minutes) plus adequate time to permit inspections.

NOTE: THE DSS MAY BE MANNED OR UNMANNED WHILE THE UNIT IS PROGRESSING TO EACH DEPTH INCREMENT. IF THE UNIT IS UNMANNED, BILGE ALARMS OR OTHER MEANS OF DETECTING FAILURES MUST BE PROVIDED TO ALERT OPERATORS OF ANY DSS SYSTEM FAILURE. SUFFICIENT TIME MUST BE ALLOTTED AT EACH 200 FOOT DEPTH INCREMENT FOR A POTENTIAL LEAK TO REGISTER AN ALARM BEFORE PROCEEDING TO THE NEXT DEPTH. IF THE BILGE ALARM (OR OTHER MEANS) INDICATES A FAILURE, THE PROHIBITION AGAINST MANNED OPERATIONS AND DEPTH LIMITATIONS OF 5.8.4C. BELOW APPLY. FINAL INSPECTIONS OF AFFECTED JOINTS DURING UNMANNED TESTING WILL BE MADE AT 200 FEET OR SHALLOWER PROVIDING NO OTHER INDICATIONS OF POTENTIAL FAILURE WERE NOTED AT THE DEEPER DEPTHS.

- b. If inspections of the system/component during the controlled dive are satisfactory, the DSS is released for operations with no immediate report required. Clearance of the DFS will be reported as required by Part III, Chapter 8 of this volume.
- c. If inspections of the system/component during the initial submergence or subsequent deeper depths are unsatisfactory:
 - (1) The DSS is not authorized manned operations at any depth.
 - (2) The DSS is restricted to a depth of 200 feet unless specific authorization is received from the TYCOM approving unmanned operations at depths deeper than 200 feet.
 - (3) An immediate report of unsatisfactory inspections will be made to the ISIC.
- d. If unmanned operations at depths greater than 200 feet are required, the Commanding Officer/Officer-in-Charge shall provide justification and request approval from the TYCOM (info ISIC, NAVSEA, 07Q and applicable Program Executive Officer) to conduct unmanned operations at depths deeper than 200 feet.
- e. Deficiencies discovered that are not joints specified for inspection in the MCR/REC and DFS shall be dispositioned as required by Part III, Chapter 8 of this volume and are not cause for depth restrictions unless the Commanding Officer/Officer-in-Charge deem necessary.

5.8.5 Voyage or At-Sea Repairs. If emergent repairs or at-sea repairs involve REC work, the ship/DSS is limited to 200 feet or less until the ship's Commanding Officer has signed for the closed REC.

5.8.6 Exceptions to Re-Entry Control. Certain systems and equipment within the certified SOC boundary require frequent entry into the certified boundary for routine operations or maintenance actions in order to enable the ship to carry out its mission. These systems and components are listed in the DSS SOC Notebook. The operational requirements for these systems and equipment have been reviewed. Inherent operational controls in the present system are considered adequate and the items are considered safe exceptions to the formalized REC system. The operational control which is considered as meeting the intent of the REC requirements is specified in the DSS SOC Notebook and must be in effect in order to use the exception. Some REC exceptions permit removal of material from the installed system to perform maintenance or testing. The original material must be reinstalled or a complete REC (controlled work package) must be used to capture the installation of new Material Control Division A, B or C material and/or certification testing for new material.

NOTE: MCR/REC EXCEPTIONS ARE FOR USER ACTIVITY'S USE ONLY AND ARE NOT AUTHORIZED FOR USE BY REPAIR ACTIVITIES. REPAIR ACTIVITIES SHALL NOT REQUEST THE SHIP TO INVOKE A REC EXCEPTION IN CONJUNCTION WITH REPAIR ACTIVITY WORK UNLESS SPECIFICALLY AUTHORIZED BY THE USER ACTIVITY'S SOC NOTEBOOK.

5.8.6.1 Controlled Assembly Requirements for SOC REC Exceptions.

- a. An FWP in accordance with Part I, Chapter 2 of this volume, (e.g., PMS MRC, technical manual pages, detailed maintenance outline), will be used to control and document all work performed as a REC exception.
- b. Controlled Assembly requirements are:
 - (1) Verification that surface finishes of gasket/O-Ring sealing surfaces are in accordance with applicable specifications.
 - (2) Verification that fastener material and installation is in accordance with applicable specifications.
 - (3) Verification that gaskets/O-Rings are properly installed and in accordance with applicable specifications.
 - (4) Assembly is documented on a QA form 34 or 34B as applicable.
 - (5) Inspected by a Quality Assurance Inspector or Quality Assurance Supervisor.
 - (6) Verification that cleanliness was maintained in accordance with MIL-STD-1622 for critical applications or reference (c) (where applicable). Document "Cleanliness maintained per [MIL-STD-1622 or reference (c) (as applicable)]" and include the Craftsman's signature and date in the remarks block of the QA form 34.

5.8.7 Certification Continuity Report. In order to ensure continued certification of each DSS, periodic reports are required as follows:

- a. Prior to each manned operation, except as discussed in reference (a), paragraph 3.7.4, the User Activity will submit to the ISIC (deployed ISIC, if deployed), a written certification continuity report, which addresses the status of the DSS SOC RECs, testing of SOC RECs, HIPs completed and RECs closed by transferring actions to a DFS. Submarines shall submit this report to the ISIC prior to dockside manned operations and/or each underway for submerged operations (not required to issue DSS certification continuity report for work performed at sea). Appendix A provides the minimum requirements for the letter or message. If no SOC controlled work, testing or HIPs were accomplished, no report is required.
- b. Prior to the DSS submerged operations after an FMA availability, refit or inport period when SOC work was performed, the FMA Commanding Officer will issue a letter report to each tended DSS, with a copy to the Sustaining Activity and parent ISIC, which addresses the status of SOC CWPs, testing of SOC systems, HIP maintenance requirements completed and SOC non-conformances (i.e., DFS and LAR). Appendix B provides the minimum requirements for the letter or message.
- c. Prior to the DSS underway, activities other than FMAs which perform SOC maintenance on a DSS will issue a report to the DSS with a copy to the Sustaining Activity and parent ISIC, certifying that the maintenance performed meets the requirements of applicable specifications invoked by the governing document and the Memorandum of Agreement.
- d. In order to ensure continued certification of those DSSs that frequently change custody between activities such as the Dry Deck Shelters, off-loads and on-loads will use the format of Appendix C and D respectively to transfer custody of the vehicle. The receiving activity will conduct a review of the items identified in the transfer of custody letter/message and then report acceptance of custody using the format of Appendix E.

5.9 MATERIAL CONDITION MONITORING (SUBMARINES ONLY).

5.9.1 Hull Integrity Procedures Program.

- a. The HIP Program is applicable to specific DSS. The program provides the minimum material condition requirements to Sustain Certification, with an established periodicity to accomplish. It is one of the programs required to maintain SOC certification. Accomplishment of the HIP will identify changes within the SOC or hull integrity boundaries of the ship, which result from the degradation caused by the service environment.

- b. Administration, scheduling and reporting of the HIP program will be in accordance with the requirements of Volume VI, Chapter 38 of this manual. A summary of HIP status will be reported by the DSS User Activity in accordance with paragraph 5.8.7 of this chapter.
- c. When performing corrective maintenance the following guidance is provided with regard to HIPs:
 - (1) When performing corrective maintenance, associated HIP should be reviewed to determine if the HIP should be accomplished concurrently ahead of scheduled periodicity to preclude having to disassemble equipment again to accomplish the HIP. The DSS schedule or FMA resources may preclude concurrent, early accomplishment of HIPs.
 - (2) If HIP criteria are used, in total or in part, during corrective maintenance, and a measured parameter is found out of tolerance and not restored, a major DFS must be submitted, in accordance with Part III, Chapter 8 of this volume, even though the periodicity of the HIP MRC has not expired.
 - (3) When performing corrective maintenance that does affect a HIP measured parameter, perform that portion of the applicable HIP.
- d. Following installation of an alteration (Field Change, Temporary Modification) that modifies the structure of the DSS, such that access to vital equipment is or may be impacted, the Sustaining Activity shall evaluate the need to perform the Access to Vital Equipment DSS HIP. If access to vital equipment could be restricted, the Sustaining Activity shall perform the applicable DSS HIP. Partial accomplishment of the DSS HIP is acceptable if appropriate for the alteration. If partial accomplishment is performed, provide a copy to the installing activity and the ISIC. If the complete DSS HIP is accomplished, provide a copy to normal distribution.

5.10 TEMPORARY MODIFICATIONS. The User Activity/Sustaining Activity shall obtain formal approval from the Program Manager for any use of special equipment or modification of a DSS unit on a temporary basis.

5.10.1 Temporary Modification Program. NAVSEA PMS 399 and 07 have established a Temporary Modification Program. Each User Activity/Sustaining Activity shall manage Temporary Modifications to DSS as directed in reference (e).

NOTE: TEMPORARY MODIFICATIONS APPROVED FOR USE ON ONE DSS UNIT WILL NOT BE INSTALLED ON ANOTHER DSS UNIT WITHOUT PRIOR APPROVAL OF THE PROGRAM MANAGER WITH SCA CONCURRENCE.

5.10.2 Configuration Control. Installation of a previously approved temporary modification on the same unit is authorized only when the approval documentation is available and contains approval for re-installation for continuing use.

APPENDIX A

MESSAGE FORMAT FOR CERTIFICATION CONTINUITY FOR DSS

FM (SUBMITTING UNIT)
 TO (ISIC) (NOTE 1)
 (SUSTAINING ACTIVITY)
 (DEPLOYED ISIC) (IF APPLICABLE)
 INFO (PARENT ISIC) (APPLICABLE IN ALL CASES WHEN DEPLOYED)
 (ADDITIONAL ADDEES)
 BT
 (CLASSIFICATION)//N04790//
 SUBJ/CERTIFICATION CONTINUITY//
 MSGID/GENADMIN/_____ (DSS UNIT)//
 REF/A/DOC/COMUSFLTFORCOMINST 4790.3/DATE OF LATEST CHANGE//
 REF/B/DOC/NAVSEA/DATE OF LATEST LETTER//
 REF/C/DOC/NAVSEA/DATE OF LATEST LETTER//
 REF/D/DOC/NAVSEA/DATE OF LATEST CHANGE//
 AMPN/REF A IS JOINT FLEET MAINTENANCE MANUAL, REF B IS NAVSEA LTR FOR MISSION
 CONFIGURATION MATRIX, REF C IS NAVSEA CERTIFICATION LETTER, REF D IS SYSTEMS
 CERTIFICATION PROCEDURES AND CRITERIA MANUAL FOR DEEP SUBMERGENCE SYSTEMS//
 RMKS/1. IAW REF A ALL WORK PERFORMED WITHIN THE SCOPE OF CERTIFICATION BOUNDARY
 FOR DESIGNATED MISSION CONFIGURATION(S) HAS BEEN COMPLETED AND SATISFACTORILY
 RETESTED. ALL SYSTEM/SUB-SECTIONS AND COMPONENTS REQUIRED BY THE MISSION
 CONFIGURATION MATRIX ARE OPERATING WITHIN APPROVED PARAMETERS AS SPECIFIED IN
 REF B. THERE ARE NO OUTSTANDING RECS FOR SCOPE OF CERTIFICATION EQUIPMENT/SYSTEMS.
 2. THE MISSION CONFIGURATION, AS DEFINED IN REF B FOR INTENDED DIVES IS (ARE):
 3. THE FOLLOWING EXTERNAL JOINT TIGHTNESS TESTS WILL BE CONDUCTED DURING A
 CONTROLLED DIVE TO TEST DEPTH.
 4. THE FOLLOWING APPROVED DFS ITEMS ARE IN EFFECT:
 DEPARTURE NO./MAJOR/MINOR SYSTEM/COMPONENT OPERATIONAL LIMITATIONS
 5. THE FOLLOWING IS A LIST OF ALL APPROVED TEMPORARY MODIFICATIONS (TEMP MODS)
 WHICH ARE INSTALLED IN _____ (DSS UNIT):
 INCLUDE TEMP MOD NUMBER AND STATE COMBINED IMPACT OF INSTALLED TEMP MODS ON
 VEHICLE STABILITY INCLUDING WEIGHT/MOMENT AND ANY OPERATION RESTRICTIONS
 ASSOCIATED WITH A SPECIFIC TEMP MOD.
 6. ALL REQUIRED PMS WITHIN THE SCOPE OF CERTIFICATION BOUNDARY FOR _____ (DSS UNIT)
 HAS BEEN COMPLETED WITHIN THE REQUIRED PERIODICITY AND THE RESULTS ARE
 SATISFACTORY (EXCEPT AS NOTED BELOW).
 7. ALL URO/HIP MRC MANDATORY TESTS/INSPECTIONS HAVE BEEN SUCCESSFULLY
 ACCOMPLISHED WITHIN THE REQUIRED PERIODICITY. THE URO/HIP MRC DATA REPORT FORMS
 HAVE BEEN MAILED AND COPIES HAVE BEEN PROVIDED TO THE ISIC.
 8. THERE ARE NO OPEN CATEGORY IA, CATEGORY IB, OR CATEGORY IC SURVEY CARDS THAT
 AFFECT MANNED OPERATIONS. OPEN SURVEY CARDS ARE LISTED BELOW:
 INCLUDE CARD NUMBER, CATEGORY, DESCRIPTION, DUE DATE//
 BT

NOTE 1: THIS CERTIFICATION REPORT MAY BE PROVIDED TO THE ISIC IN THE FORM OF A MEMORANDUM, MESSAGE OR LETTER. DELIVER THE CONTINUITY CERTIFICATION REPORT VIA ANY MEANS SUITABLE FOR OFFICIAL CORRESPONDENCE AGREED TO BY THE ISIC.

NOTE 2: ENSURE MESSAGES ARE IN ACCORDANCE WITH CURRENT MESSAGE FORMAT AND CURRENT PLAIN LANGUAGE ADDRESS DIRECTORY (PLAD) IS UTILIZED.

(This Page Intentionally Left Blank)

APPENDIX B

LETTER FORMAT FOR CERTIFICATION REPORT TO TENDED DSS

From: Commanding Officer, _____ (Sustaining Unit/Fleet Maintenance Activity (FMA)/Ship Yard/Contractor)
 To: Commanding Officer/Officer in Charge _____ (TENDED DSS UNIT)
 Subj: CERTIFICATION CONTINUITY OF _____ (TENDED DSS UNIT)
 Ref: (a) COMUSFLTFORCOMINST 4790.3, Joint Fleet Maintenance Manual
 Encl: (1) Copies of completed Quality Assurance Certification Form/Re-Entry Control Forms
 (2) Copies of approved Departures from Specification

1. In accordance with reference (a), certification of those systems or portions of systems, on which (_____) performed maintenance has been sustained. All required re-certification of the maintenance has been completed except as noted in paragraph 2 and 3 below.

2. All CWPs opened for Scope of Certification maintenance have been closed. A copy of each completed QA-form 9 is forwarded as enclosure (1). RECs closed by transferring testing to a DFS are listed below:

<u>CWP/REC Serial Number</u>	<u>Task Description</u>	<u>Testing Required</u>
------------------------------	-------------------------	-------------------------

3. The following Departures from Specifications (DFS) and Liaison Action Requests (LAR) for deviations from specification were approved as part of maintenance in this availability. Copies of each are provided as enclosure (2):

<u>CWP Serial No.</u>	<u>DFS or LAR Serial No.</u>	<u>Type</u>	<u>Component</u>
-----------------------	------------------------------	-------------	------------------

4. The following HIP maintenance requirements were satisfied and are reported as complete by the (FMA/Ship Yard/Contractor). The original data report forms will be mailed to SUBMEPP with copies to your ISIC and TYCOM within 30 days.

<u>HIP</u>	<u>EGL (if applicable)</u>	<u>Component Identification</u>	<u>JCN</u>
------------	----------------------------	---------------------------------	------------

Signed by Fleet Maintenance Activity/
Ship Yard/Contractor

Copy to:
Parent ISIC
TYCOM

(This Page Intentionally Left Blank)

APPENDIX C

MESSAGE FORMAT FOR DDS TRANSFER OF CUSTODY
CERTIFICATE OF CONTINUITY FOR OFF-LOADS

FM (HOST SHIP)//
 TO (DDS UNIT)//
 INFO ISIC// (NOTE 1)//
 TYCOM// (NOTE 2)//
 (ADDITIONAL ADDEES)//
 BT
 (CLASSIFICATION)//
 SUBJ/TRANSFER OF CUSTODY OF DDS-____//
 MSGID/GENADMIN/(HOST SHIP)//
 REF/A/DOC/COMNAVSPECWARCOM/DATE OF LATEST CHANGE//
 REF/B/DOC/NAVSEA/DATE OF LATEST CHANGE//
 REF/C/DOC/NAVSEA/DATE OF LATEST CHANGE//
 REF/D/DOC/NAVSEA/DATE OF LATEST CHANGE//
 AMPN/REF A IS MOA BETWEEN COMNAVSPECWARCOM, COMSUBLANT, AND COMSUBPAC, REF B IS P-9290 SYSTEM CERTIFICATION PROCEDURES AND CRITERIA MANUAL FOR DEEP SUBMERGENCE SYSTEMS, REF C IS DDS SCOPE OF CERTIFICATION NOTEBOOK, REF D IS DDS (SSGN/688CL/VA CL) OPS AND EPS FOR DDS OPERATIONS.//
 POC/____/RANK/UNIT/LOCATION/EMAIL/
 RMKS/1. IAW REF (A), REQUEST (DDS UNIT) ACCEPT CUSTODY OF DDS-().
 2. DDS CERTIFICATION AND CLEANLINESS OF THE DIVERS AIR SYSTEM OF DDS-() HAVE BEEN MAINTAINED IN ACCORDANCE WITH THE REQUIREMENTS OF REFS (B) AND (C). ALL MAINTENANCE AND REPAIRS PERFORMED WHILE IN CUSTODY OF (HOST SHIP) HAVE BEEN COMPLETED IN ACCORDANCE WITH APPROVED SPECIFICATIONS AND TEST PROCEDURES.
 3. (HOST SHIP) WILL TURN OVER CUSTODY OF REC, DFS, EQUIPMENT STATUS AND TEMPMOD LOGS; REC EXCEPTION RECORDS; PMS SCHEDULES AND MRCS; CALIBRATION RECORDS; HIP RECORDS AND MRCS FOR DDS-() TO (DDS UNIT). CURRENT STATUS OF REC AND DFS AS FOLLOWS:
 A. IDENTIFY EACH OPEN REC INCLUDING A BRIEF DESCRIPTION OF THE WORK INVOLVED. IF NO RECs ARE OPEN AT THE TIME OF CUSTODY TRANSFER, STATE THIS FACT.
 B. IDENTIFY ALL ACTIVE DFSs INCLUDING A BRIEF DESCRIPTION, CRITERIA FOR CLEARANCE, ANY OPERATING RESTRICTIONS, APPROVAL AUTHORITY ASSOCIATED WITH EACH DFS. IF NO DFSs ARE ACTIVE AT THE TIME OF CUSTODY TRANSFER, STATE THIS FACT.
 4. CERTIFICATION REQUIREMENTS PERFORMED DURING HOST CUSTODY INCLUDE:
 A. IDENTIFY EACH DDS INTERNAL AUDIT AND SCA SURVEY DUE DURING THE CUSTODY PERIOD.
 B. IDENTIFY EACH HIP PERFORMED DURING THE CUSTODY PERIOD.
 C. IDENTIFY EACH OUTSTANDING SCA CAT IA, IB, AND IC SURVEY CARDS.
 5. GAS PODS (WILL/WILL NOT) BE INCLUDED IN THE TRANSFER.
 6. STATE THAT EITHER ALL PMS FOR DDS-() IS CURRENT AT THE TIME OF CUSTODY, OR IDENTIFY ANY REQUIRED PMS THAT HAS BEEN DEFERRED OR RESCHEDULED.
 7. DDS-() SHALL BE REMOVED IN ACCORDANCE WITH THE APPROPRIATE STANDARD OPERATING PROCEDURE OF REF (D). (DDS UNIT) IS RESPONSIBLE FOR ENSURING THAT ALL DDS PORTABLE EQUIPMENT IS INSTALLED, ALL PIPING INTERFACES AND ELECTRICAL HULL FITTINGS ARE PROPERLY HANDLED, AND ALL THREAD SAVERS AND PORTABLE FAIRING ARE PROPERLY REINSTALLED.//
 BT

- NOTE:
1. Office codes for ISICs are: COMNAVSPECWARGRU THREE N9; NSSC PEARL HARBOR HI N432; NSSC BANGOR WA N432; NSSC KINGS BAY GA N40A; COMREGSUPPGRU GROTON CT N40. Include NSW ISIC, Host Submarine home ISIC, and deployed ISIC (if applicable).
 2. Office codes for TYCOMs are: COMNAVSPECWARCOM CORONADO CA N844; COMSUBLANT NORFOLK VA N4322; COMSUBPAC PEARL HARBOR HI N4322.
 3. Include NAVSEA 07Q4 and PMS 399 Program Manager for informational purposes.
 4. Naval message is the preferred method to report transfer of custody. Naval correspondence may be used only if message traffic is unavailable. If correspondence is used, ensure message distribution list is followed.
- NOTE: ENSURE MESSAGES ARE IN ACCORDANCE WITH CURRENT MESSAGE FORMAT AND CURRENT PLAD IS UTILIZED.

APPENDIX D

MESSAGE FORMAT FOR DDS TRANSFER OF CUSTODY
CERTIFICATE OF CONTINUITY FOR ON-LOADS

FM (DDS UNIT)//
 TO (HOST SHIP)//
 INFO ISIC// (NOTE 1)//
 TYCOM// (NOTE 2)//
 (ADDITIONAL ADDEES)//
 BT
 (CLASSIFICATION)//
 SUBJ/TRANSFER OF CUSTODY OF DDS-____//
 MSGID/GENADMIN/(DDS UNIT)//
 REF/A/DOC/COMNAVSPECWARCOM/DATE OF LATEST CHANGE//
 REF/B/DOC/NAVSEA/DATE OF LATEST CHANGE//
 REF/C/DOC/NAVSEA/DATE OF LATEST CHANGE//
 REF/D/DOC/NAVSEA/DATE OF LATEST CHANGE//
 AMPN/REF A IS MOA BETWEEN COMNAVSPECWARCOM, COMSUBLANT, AND COMSUBPAC, REF B IS P-9290 SYSTEM CERTIFICATION PROCEDURES AND CRITERIA MANUAL FOR DEEP SUBMERGENCE SYSTEMS, REF C IS DDS SCOPE OF CERTIFICATION NOTEBOOK, REF D IS DDS (SSGN/688CL/VA CL) OPS AND EPS FOR DDS OPERATIONS.//
 POC/____/RANK/UNIT/LOCATION/EMAIL//
 RMKS/1. DDS-() IS SCHEDULED TO BE ON-LOADED TO (HOST SHIP) ON (ON-LOAD DATE). UPON INSTALLATION OF THE DDS ONTO (HOST SHIP) REQUEST (HOST SHIP) ACCEPT CUSTODY FROM (DDS UNIT) PER REF (A).
 2. DDS CERTIFICATION AND CLEANLINESS OF THE DIVERS AIR SYSTEM OF DDS-() HAVE BEEN MAINTAINED IN ACCORDANCE WITH THE REQUIREMENTS OF REFS (B) AND (C). ALL MAINTENANCE AND REPAIRS PERFORMED WHILE IN CUSTODY OF (DDS UNIT) HAVE BEEN COMPLETED IN ACCORDANCE WITH APPROVED SPECIFICATIONS AND TEST PROCEDURES.
 3. (DDS UNIT) WILL TURN OVER CUSTODY OF REC, DFS, EQUIPMENT STATUS AND TEMPMOD LOGS; REC EXCEPTION RECORDS; PMS SCHEDULES AND MRCS; CALIBRATION RECORDS; HIP RECORDS AND MRCS FOR DDS-() TO (HOST SHIP). CURRENT STATUS OF REC AND DFS AS FOLLOWS:
 A. IDENTIFY EACH OPEN REC INCLUDING A BRIEF DESCRIPTION OF THE WORK INVOLVED. IF NO RECs ARE OPEN AT THE TIME OF CUSTODY TRANSFER, STATE THIS FACT.
 B. IDENTIFY ALL ACTIVE DFSs INCLUDING A BRIEF DESCRIPTION, CRITERIA FOR CLEARANCE, ANY OPERATING RESTRICTIONS, APPROVAL AUTHORITY ASSOCIATED WITH EACH DFS. IF NO DFSs ARE ACTIVE AT THE TIME OF CUSTODY TRANSFER, STATE THIS FACT.
 4. CERTIFICATION REQUIREMENTS DUE DURING HOST CUSTODY INCLUDE:
 A. IDENTIFY EACH DDS INTERNAL AUDIT AND SCA SURVEY DUE DURING THIS PERIOD.
 B. IDENTIFY EACH HIP DUE DURING THIS PERIOD.
 C. IDENTIFY EACH OUTSTANDING SCA CAT IA, IB, AND IC SURVEY CARDS.
 5. GAS PODS (WILL/WILL NOT) BE INCLUDED IN THE TRANSFER.
 6. STATE THAT EITHER ALL PMS FOR DDS-() IS CURRENT AT THE TIME OF CUSTODY, OR IDENTIFY ANY REQUIRED PMS THAT HAS BEEN DEFERRED OR RESCHEDULED.
 7. DDS-() IS BEING INSTALLED IN ACCORDANCE WITH THE APPROPRIATE STANDARD OPERATING PROCEDURE OF REF (D). (DDS UNIT) IS RESPONSIBLE FOR ENSURING THAT ALL DDS PORTABLE EQUIPMENT IS INSTALLED, ALL PIPING INTERFACES AND ELECTRICAL HULL FITTINGS ARE PROPERLY HANDLED, AND ALL THREAD SAVERS AND PORTABLE FAIRING ARE PROPERLY CONTROLLED.//
 BT

- NOTE:
1. Office codes for ISICs are: COMNAVSPECWARGRU THREE N9; NSSC PEARL HARBOR HI N432; NSSC BANGOR WA N432; NSSC KINGS BAY GA N40A; COMREGSUPPGRU GROTON CT N40. Include NSW ISIC, Host Submarine home ISIC, and deployed ISIC (if applicable).
 2. Office codes for TYCOMs are: COMNAVSPECWARCOM CORONADO CA N844; COMSUBLANT NORFOLK VA N4322; COMSUBPAC PEARL HARBOR HI N4322.
 3. Include NAVSEA 07Q4 and PMS 399 Program Manager for informational purposes.
 4. Naval message is the preferred method to report transfer of custody. Naval correspondence may be used only if message traffic is unavailable. If correspondence is used, ensure message distribution list is followed.

NOTE: ENSURE MESSAGES ARE IN ACCORDANCE WITH CURRENT MESSAGE FORMAT AND CURRENT PLAD IS UTILIZED.

APPENDIX E**MESSAGE FORMAT FOR DDS ACCEPTANCE OF CUSTODY**

FM (HOST SUBMARINE OR DDS UNIT)
 TO (HOST SUBMARINE OR DDS UNIT)
 INFO ISIC// (NOTE 1)
 TYCOM// (NOTE 2)
 COMNAVSEASYSKOM WASHINGTON DC// (NOTE 3)
 (ADDITIONAL ADDEES)
 BT
 (CLASSIFICATION)//
 SUBJ/ACCEPTANCE OF CUSTODY OF DDS-____//
 MSGID/GENADMIN/_____ (HOST SUBMARINE OR DDS UNIT)//
 REF/A/ DOC/COMUSFLTFORCOMINST 4790.3/DATE OF LATEST CHANGE//
 REF/B/ MSG OR DOC/HOST SUBMARINE OR DDS UNIT/DATE OF LETTER OR MESSAGE DTG//
 AMPN/REF A IS JOINT FLEET MAINTENANCE MANUAL, REF B IS TRANSFER OF CUSTODY MESSAGE
 OR LETTER//
 RMKS/1. PER REF A, _____ (HOST SUBMARINE OR DDS UNIT) HAS REVIEWED THE CONTENT OF
 REF B AND ACCEPTS CUSTODY OF DDS-____.
 BT

- NOTE:
1. Office codes for ISICs are: COMNAVSPECWARGRU THREE N9; NSSC PEARL HARBOR HI N432; NSSC BANGOR WA N432; NSSC KINGS BAY GA N40A; COMREGSUPPGRUGROTON CT N40. Include NSW ISIC, Host Submarine home ISIC, and deployed ISIC (if applicable).
 2. Office codes for TYCOMs are: COMNAVSPECWARCOM CORONADO CA N844; COMNAVSUBFOR NORFOLK VA N4322; COMSUBPAC PEARL HARBOR HI N4322
 3. Include NAVSEA 07Q4 and PMS 399 Program Manager for informational purposes.
 4. Naval message is the preferred method to report acceptance of custody. Naval correspondence may be used only if message traffic is unavailable. If correspondence is used, ensure message distribution list is followed.
- NOTE: ENSURE MESSAGES ARE IN ACCORDANCE WITH CURRENT MESSAGE FORMAT AND CURRENT PLAD IS UTILIZED.

(This Page Intentionally Left Blank)

VOLUME V
PART III
CHAPTER 6
MATERIAL CONTROL

REFERENCES.

- (a) NAVSEA 0948-LP-045-7010 - Material Control Standard (Non-Nuclear)
- (b) NAVSEA SS800-AG-MAN-010/P-9290 - System Certification Procedures and Criteria Manual for Deep Submergence Systems
- (c) NAVSUPWSSINST 4355.5 - Level I/Subsafe (LI/SS) Deep Submergence Systems Scope of Certification (DSS-SOC) and Fly-By-Wire (FBW) Stock Program Material Procedures
- (d) NAVSEALOGCENINST 4355.14 - Receipt Inspection Requirements for Deep Submergence Systems-Scope of Certification (DSS-SOC) Stock Program Material
- (e) NAVSEA 0924-062-0010 - Submarine Safety (SUBSAFE) Requirements Manual

6.1 **PURPOSE.** To define responsibility and provide guidance for material control which includes procurement, receipt inspection, stowage, issue, in-process control and records for controlled material used in maintenance.

6.1.1 **Discussion.** Material Control Divisions (MCD) will be used to define levels of control and Objective Quality Evidence (OQE) within the Scope of Certification (SOC) boundary. Material will be controlled as either MCD A, B or C depending on its application. Controlled material is the term used in this manual to describe those materials designated for use in or removed from SOC boundary which are in the custody of the end-user work center, division Controlled Material Petty Officer (CMPO) or are undergoing receipt inspection, have been certified for use and are tagged with the appropriate Quality Assurance (QA) forms of this manual. Deep Submergence Systems (DSS)-SOC material in the custody of the Naval supply system, which includes supply departments onboard ships, Fleet Maintenance Activities (FMA) and contractors is identified as DSS-SOC stock program materials.

6.2 **CONTROLLED MATERIAL DETERMINATION.** This section describes the use of the specific references used to identify proper material for repair work. This section also provides references and guidance necessary to obtain this understanding and to determine if controlled material is required, and if so, the proper level of control.

6.2.1 **General Requirements.** In order to determine the correct material to be installed in a DSS and to properly certify the material prior to installation, the work center responsible for the specific area of the DSS must first gather the appropriate reference material as follows:

- a. Naval Sea Systems Command (NAVSEA) approved "List of Material" or "Component List" which may be part of a drawing, diagram or may be a separate document.
- b. System/Component technical manual.
- c. Applicable "Y" suffixed Allowance Parts List (APL) from the ship's Coordinated Shipboard Allowance List. Y suffixed APLs are specific to DSS-SOC systems and components.

6.2.2 **Scope of Certification Material Control Divisions.** SOC components will be controlled as MCD A, B or C. The definitions and scope of boundaries for each MCD are as listed below.

- a. Material Control Division A: Any material in a manned DSS whose single failure would result in DSS loss with DSS personnel on board or death of the DSS personnel. As such MCD-A is assigned to any component for which back-up protection is not feasible and therefore even a single failure is unacceptable. Types of MCD-A material are:
 - (1) Components exposed to the differential pressure between sea pressure and DSS internal atmospheric pressure.
 - (2) Components that operate at greater than 400 psig which are internal to the DSS and cannot be isolated from the pressure source either by a directly accessible or remotely operated shut off valve.

- (3) Any piping that penetrates the pressure hull from the pressure hull to and including the inboard flange of the first directly accessible or remotely operated shut-off valve.
 - (4) All oxygen and hydrogen systems with a design pressure of 100 psig and above.
 - (5) Components within an emergency or back-up system (e.g., jettison and emergency life support systems and release devices for external appendages) where maximum assurance that the system will operate when needed is essential to preventing a single failure in a primary system from resulting in the death or injury of DSS personnel.
 - (6) Components such as pressure hull (plate, forgings, castings, weld filler material, inserts and penetrations) hard structure, pressure storage tanks and flasks located in manned spaces, high pressure or sea connected piping components including mechanical joints and associated fasteners.
- b. Material Control Division B: Any material or component where failure would require immediate emergency corrective action, the activation of any emergency system or emergency return to the surface. MCD-B material includes:
- (1) Low pressure (<400 psig) piping and component assemblies in the primary and back-up life support systems.
 - (2) The portion of the electrical power distribution system exposed to sea pressure.
 - (3) Instruments and sensors used to monitor external ambient conditions.
 - (4) Instruments and sensors used to monitor or control DSS functions.
 - (5) Hoses, tethers and umbilicals providing life support or thermal protection.
 - (6) All SOC piping and piping components external to manned spaces.
 - (7) All other low pressure (<400 psig) SOC piping and piping components within the manned spaces not otherwise classified as MCD-A.
 - (8) Mechanical joints and fasteners, not otherwise classified as MCD-A, used on SOC piping systems and piping components.
- c. Material Control Division C: Any SOC material that is not classified as either MCD-A or MCD-B. MCD-C material includes:
- (1) Emergency electrical power distribution systems.
 - (2) Portions of the main electrical power distribution system and electrical components not classified as MCD-A or MCD-B.
 - (3) Soft goods such as O-rings, gaskets and seals.

6.3 RECEIPT INSPECTION OF CONTROLLED MATERIAL. This section provides the guidance and procedures for Sustaining Activities/User Activities and FMAs to conduct and document receipt inspections to certify controlled material as acceptable for installation.

NOTE: THE TECHNICAL INSPECTION REQUIREMENTS OF THE APPLICABLE TECHNICAL MANUAL, DRAWING OR OTHER TECHNICAL REFERENCE AND PIPING SYSTEM MATERIAL REQUIREMENTS (E.G., CLEANLINESS, DIMENSIONS, SURFACE FINISH) ARE THE RESPONSIBILITY OF THE END-USER (WORK CENTER SUPERVISOR/ CRAFTSMAN) TO ACCOMPLISH PRIOR TO INSTALLATION AND ARE NOT PART OF THE RECEIPT INSPECTION OF THIS MANUAL.

NOTE: IN SOME PROGRAMS, A CERTIFICATE OF CONFORMANCE (COC) IS ISSUED BY THE NAVY SUPPLY SYSTEM OR THE CONTRACTOR MANAGING THE STOCK PROGRAM FOR THE NAVY. NAVSEA HAS AUTHORIZED THE SUPPLY SYSTEM OR CONTRACTOR TO RETAIN ALL REQUIRED DOCUMENTS AND ISSUE THE COC TO THE SUSTAINING/USER ACTIVITY AS SUPPORTING DOCUMENTATION FOR RECEIPT INSPECTION. THE SUSTAINING/USER ACTIVITY MAY REQUEST ALL SUPPORTING DOCUMENTATION FROM THE CONTRACTOR AT ANYTIME.

6.3.1 General Requirements. Once the material ordered for use in SOC systems is received, the material must be receipt inspected. Receipt inspection of this material is required to establish positively that the material is the correct material for the job. For SOC MCD-A material, a unique marking system is required for “traceability” which links the material to OQE. OQE for the material is the quantitative and qualitative data proving that the material conforms to specified requirements. To meet the requirements for traceability, the following requirements are instituted:

- a. Receipt inspection of the material.
- b. Use of QA tags in association with the item(s).
- c. Segregated stowage for DSS-SOC stock program material and controlled material.
- d. Custody by CMPO/Controlled Material Handlers (CMH), Quality Assurance Inspectors (QAI) or qualified craftsman.
- e. Use of material verification procedures, as required by reference (a), during installation of the material.
- f. SOC material directly procured from Electric Boat or Electric Boat provided interim spares and initial outfitting may be received with special tags, titled “Record of DSS-SOC Receipt Inspection” (Figure 6-1) that denote all inspection and certification attributes have been met except a physical inspection to confirm the material was not damaged in shipping.
 - (1) The blue tags, if received, will be retained as OQE and used to receipt inspect material.
 - (2) The blue tags must have the part number and stock number of the material ordered and the material received must be the material ordered.
- g. Level I Stock Program material ordered for a DSS-SOC application, as defined by the ship’s Y-suffixed Allowance Parts List, and received from the Naval supply system with Material Identification and Control (MIC) numbers, may be used in DSS-SOC applications on all submarines.
- h. Level I material that was not procured per paragraph g. above may be used in DSS-SOC applications. Under this condition, the following conditions apply.
 - (1) The MIC satisfies:
 - (a) Material Marking Requirements
 - (b) Records of Chemical and Mechanical Tests
 - (2) The MIC does not satisfy:
 - (a) Unique DSS-SOC OQE
 - (b) Lubrication and Thread Locking
 - (c) Paints
 - (d) Unique Clean Requirements
 - (e) DSS-SOC required as required by the specification
 - (f) DSS-SOC required Nondestructive Testing
 - (g) Certification of Compliance and when applicable, Certificate of Test
- i. Navy supply stock program material with Special Material Identification Codes (SMIC) L1/C1/Q3/VG which are also used in DSS-SOC applications are identified by APLs that reflect a Y-suffix, e.g., 887056021Y. This material has been procured to meet any additional requirements of reference (b).

Record of DSS-SOC Receipt Inspection

Electric Boat hereby certifies that this material has been inspected to ensure conformance with the material specification and testing requirements as identified by the applicable VIRGINIA Class DSS-SOC Certification Requirements drawing (H547-0001/NS#7383858) and/or SSGN Class DSS-SOC Certification Requirements drawings (G547-0001/NS#7550477, G547-0002/NS#7550478, G547-0003/NS#7550479 and G547-0004/NS#7550480) and invoked procurement documents, and is ready for installation. The detailed Objective Quality Evidence (OQE) can be obtained through Electric Boat Supplier Quality Assurance Department D323, Groton, CT (860.433.3790) under the Purchase Order/Line Item numbers listed below.

Part Number: _____

NIIN: _____

Purchase Order: _____ Line Item: _____

Remarks: _____

GENERAL DYNAMICS _____

Electric Boat Inspector/Analyst Badge Date

84-09-5516 05/08 DSS-SOC-RDR1 Form A001 Apr 2008

Figure 6-1 Record of DSS-SOC Receipt Inspection

6.3.2 Quality Assurance Forms for Receipt Inspections. The QA forms necessary to complete and document receipt inspections (QA form 1, QA form 2 and QA form 3) and instructions are found in Part I, Chapter 11 of this volume and are further discussed in paragraph 6.3.4 of this chapter.

6.3.3 NAVSUP WSS DSS-SOC Stock Program Material. DSS-SOC Stock Program material requires the material to be shipped to Portsmouth Naval Shipyard (PNSY) for Receipt Inspection prior to issuance to the end user per references (c) and (d). Material received from PNSY is shipped with Ready-for-Issue (RFI) tags (Figure 6-2) which contain the Receipt Inspection serial number, MCD level, National Stock Number (NSN) with a SMIC (D0, D4, D5, D6, D7, or D8) and contract number. RFI tag (Figure 6-2) denotes all inspection and certification attributes have been met except a physical inspection to confirm the material was not damaged in shipping.

6.3.3.1 Material Objective Quality Evidence. Material previously procured by the NAVSUP Weapons Systems Support (WSS) DSS-SOC Stock Program required the OQE to be shipped with each item. Material currently held by activities in condition code “A” is acceptable for use providing the required OQE is packaged with the material.

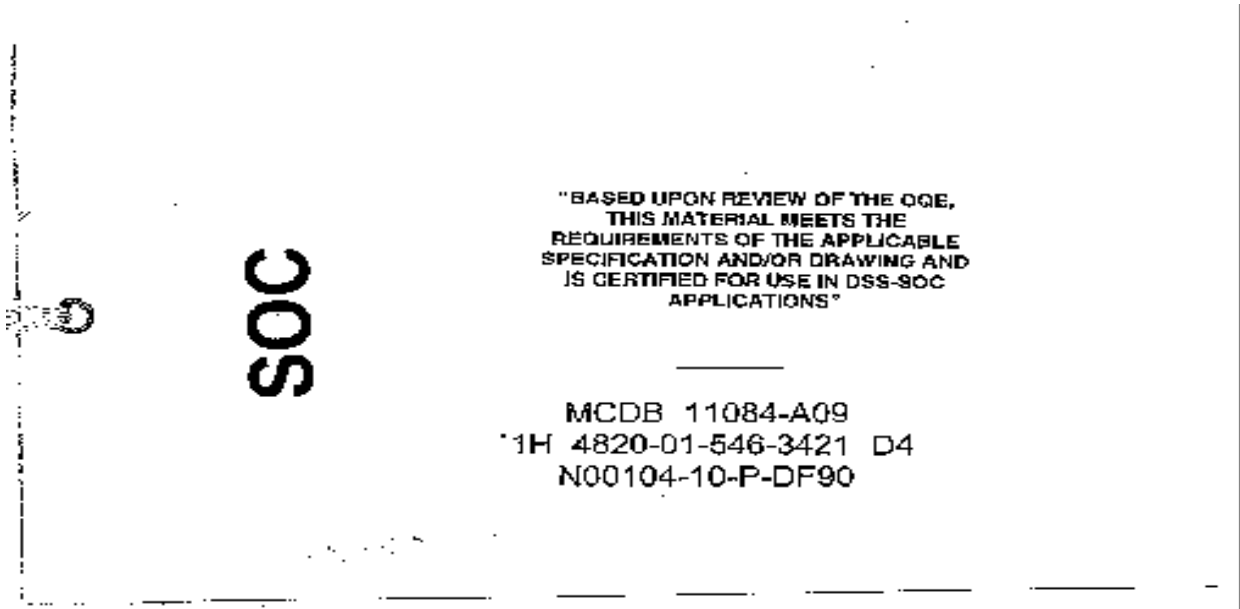

Figure 6-2 DSS-SOC Stock Program Material Ready-For-Issue (RFI) Tag (example)

6.3.4 General Requirements for Receipt of Scope of Certification Material. Material for SOC systems may be procured either through the Navy stock system or via contractors assigned by NAVSEA to supply the specific units. This section contains the requirements for receipt inspection and control of new materials. Section 6.5 of this chapter contains the requirements for handling controlled material removed from a DSS for maintenance purposes.

- a. MCD-A material received from the Navy supply system with either a D5 or D6 SMIC and an RFI tag, or an EB Blue tag, will be receipt inspected by the CMPO as follows:

Procedure

Responsibility

Visually inspect the material.

Sustaining/User Activity
CMPO/CMH

Check that quantity received is same quantity ordered.

Sustaining/User Activity
CMPO/CMH

Check for completeness (i.e., are all parts of a component present); disassembly is not required or desired.

Sustaining/User Activity
CMPO/CMH

Check NSN on part and verify that it is the NSN ordered.

Sustaining/User Activity
CMPO/CMH

Verify item has either 1) a RFI tag attached which contains the Receipt Inspection serial number, MCD level, NSN with a SMIC (D5 or D6), and contract number, or 2) an EB Blue tag. Navy supply material received that does not meet this criterion shall be receipt inspected using the receipt inspection process for Navy supply material received without a RFI tag attached in accordance with paragraph 6.3.4.c of this chapter.

Sustaining/User Activity
CMPO/CMH

Verify item is permanently marked with a receipt inspection number that matches the receipt inspection number on the RFI tag, and that is formatted in accordance with paragraph 6.3.7.2 of this chapter.

Sustaining/User Activity
CMPO/CMH

Verify that material received with a SMIC of D6 is packaged for special cleanliness (MIL-STD-1330/MIL-STD-1622) and that the package is securely sealed and the proper cleanliness tag is present.

Sustaining/User Activity
CMPO/Cleanliness Inspector/CMH

Fill out QA form 1 and attach the shipping papers, if provided.

Sustaining/User Activity
CMPO/CMH

NOTE: QA FORM 1 IS NOT REQUIRED FOR SHIP'S FORCE WHEN PERFORMING RECEIPT INSPECTION OF MATERIAL TO BE IMMEDIATELY INSTALLED FOR A SPECIFIC JOB. IF ALL MATERIAL IS NOT UTILIZED IN THE ONGOING JOB, QA FORM 1 MUST BE FILLED OUT PRIOR TO PLACING THE MATERIAL IN A STOWAGE LOCKER.

File QA form 1 with all applicable documents.

Sustaining/User Activity
CMPO/CMH

Fill out and attach QA form 2 to each unit of issue accepted. Turn over material to craftsman or stow in approved storage area.

Sustaining/User Activity
CMPO/CMH

If material fails any of above steps, reject and attach QA form 3.

Sustaining/User Activity
CMPO/CMH

Forward QA form 1 to QA Office when the material has been issued for installation.

CMPO/CMH

- b. MCD-B material received from the Navy supply system with either a D0 or D4 SMIC and an RFI tag, or an EB Blue tag, will be receipt inspected by the CMPO as follows:

Procedure

Responsibility

Visually inspect the material.

Sustaining/User Activity
CMPO/CMH

Check that quantity received is same quantity ordered.

Sustaining/User Activity
CMPO/CMH

Check for completeness (i.e., are all parts of a component present); disassembly is not required or desired.

Sustaining/User Activity
CMPO/CMH

Check NSN on part and verify that it is the NSN ordered.

Sustaining/User Activity
CMPO/CMH

Verify item has either 1) a RFI tag attached which contains the Receipt Inspection serial number, MCD level, NSN with a SMIC (D0 or D4), and contract number, or 2) an EB Blue tag. Navy supply material received that does not meet this criterion shall be receipt inspected using the receipt inspection process for Navy supply material received without a RFI tag attached.

Sustaining/User Activity
CMPO/CMH

Verify that material received with a SMIC of D0 is packaged for special cleanliness (MIL-STD-1330/MIL-STD-1622) and that the package is securely sealed.

Sustaining/User Activity
CMPO/Cleanliness Inspector/CMH

Fill out QA form 1 and attach the shipping papers, if provided.

Sustaining/User Activity
CMPO/CMH

NOTE: QA FORM 1 IS NOT REQUIRED FOR SHIP'S FORCE WHEN PERFORMING RECEIPT INSPECTION OF MATERIAL TO BE IMMEDIATELY INSTALLED FOR A SPECIFIC JOB. IF ALL MATERIAL IS NOT UTILIZED IN THE ONGOING JOB, QA FORM 1 MUST BE FILLED OUT PRIOR TO PLACING THE MATERIAL IN A STOWAGE LOCKER.

File QA form 1 with all applicable documents.

Sustaining/User Activity
CMPO/CMH

Fill out and attach QA form 2 to each unit of issue accepted. Turn over material to craftsman or stow in approved storage area.

Sustaining/User Activity
CMPO/CMH

If material fails any of above steps reject and attach QA form 3.

Sustaining/User Activity
CMPO/CMH

Forward QA form 1 to QA Office when the material has been issued for installation.

CMPO/CMH

- c. Receipt of MCD-A material without either an RFI tag, an EB Blue tag or received from a contractor/activity assigned by the Program Manager to supply the specific DSS will be receipt inspected by the CMPO and certified by the Quality Assurance Officer (QAO) as follows:

Procedure

Responsibility

Review vendor data, Military Standard (MIL-STD) and/or FMA manufacturing and test data to ensure that it all matches. See note at end of this table regarding vendor data.

Sustaining/User Activity
CMPO/CMH/QAI and QAO

Transfer MIC markings from accompanying OQE onto the item if the MIC is not already marked on the item. Disassembly of the item is not allowed or required.

Sustaining/User Activity
CMPO/CMH/QAI

Fasteners will be appropriately marked and color-coded if required.

Sustaining/User Activity
CMPO/CMH/QAI

Fill out QA form 1 to document the receipt inspection.

Sustaining/User Activity
CMPO/CMH/QAI

NOTE: QA FORM 1 IS NOT REQUIRED FOR SHIP'S FORCE WHEN PERFORMING RECEIPT INSPECTION OF MATERIAL TO BE IMMEDIATELY INSTALLED FOR A SPECIFIC JOB. IF ALL MATERIAL IS NOT UTILIZED IN THE ONGOING JOB, QA FORM 1 MUST BE FILLED OUT PRIOR TO PLACING THE MATERIAL IN A STOWAGE LOCKER.

NOTE: IF THE COMPONENT HAS A SHORTENED MIC MARKING, ENSURE THE FULL MIC MARKING FROM THE SHIPPING DOCUMENTS, TAGS, AND/OR PACKAGING IS ENTERED ON QA FORM 1 AND QA FORM 2.

File QA form 1 with all applicable documents.	Sustaining/User Activity Quality Assurance Supervisor/QAI/CMPO
Fill out and attach QA form 2 to the item. Turn over material to craftsman or stow in approved storage area.	Sustaining/User Activity CMPO/CMH/QAI
Forward QA form 1 to QA Office when the material has been issued for installation.	CMPO/CMH
If material fails any of above steps, reject the material and attach QA form 3.	CMPO/CMH

NOTE: VENDOR DATA - MATERIAL RECEIVED DIRECTLY FROM THE MANUFACTURER REQUIRES CERTIFICATION DOCUMENTATION IN ACCORDANCE WITH PARAGRAPHS 6.3.4.c.(1) THROUGH 6.3.4.c.(5) OF THIS CHAPTER AS A MINIMUM. A THOROUGH REVIEW OF THE PROCUREMENTS SPECIFICATIONS IS NECESSARY TO ENSURE ALL REQUIREMENTS ARE MET.

NOTE: IF ANY ITEM IS CERTIFIED AS LEVEL I, IT IS CONSIDERED AS MEETING THIS REQUIREMENT.

- (1) Chemical and mechanical testing is required for all metallic material. Chemical and mechanical testing for non-metallic materials as required by material specification.
- (2) Records of Nondestructive Testing as required by the specification.
- (3) Records of testing as required by the specification for implosion testing, cleanliness testing, toxicity or flammability testing, etc.
- (4) COC. Certifies that the components comply with the requirements of the procurement documents, invoked specifications and drawings. Asserts that the physical and chemical properties (material type, yield strength, tensile strength, elongation or hardness testing) are as specified in the contract specifications. The certificate will include:
 - (a) Contractor's name, address, phone number and date.
 - (b) The issuing agency's purchase order number.
 - (c) Item nomenclature of the purchased item (the product is identified by description, amount, lot number, etc.).
 - (d) Contractor's or authorized person's signature.

NOTE: INSTALLATION OF MATERIAL ON THE BASIS OF A COC SHALL NOT RELIEVE THE INSTALLING ACTIVITY OF THE RESPONSIBILITY FOR INCORPORATING MATERIAL WHICH CONFORMS TO THE REQUIREMENTS OF THE DRAWINGS AND SPECIFICATIONS. MATERIAL NOT CONFORMING TO THE REQUIREMENTS OF THE DRAWINGS AND SPECIFICATIONS WILL BE SUBJECT TO REJECTION WHETHER IN PLACE OR NOT.

- (5) In some cases a Certificate of Test (COT) may be required as evidence that testing was completed. The distinguishing characteristic of a COT is that it presents data which is the result of positive, reproducible testing performed to determine the quality of the product. It may be contained within the COC. The COT, issued by a test laboratory, states that a certain product was tested for certain qualities and shall include:
- (a) Contractors name, address, phone number and date.
 - (b) The issuing agency’s purchase order number.
 - (c) Item nomenclature of the purchased item (the product is identified by description, amount, lot number, etc.).
 - (d) Contractor’s or authorized person’s signature.
 - (e) Test data is given along with the conclusion on conformance or non-conformance.

NOTE: IF ALL TESTING REQUIRED BY REFERENCE (b) CAN NOT BE ACCOMPLISHED, THEN THE NEW COMPONENT CANNOT BE USED UNTIL A DEPARTURE FROM SPECIFICATION (DFS) IS SUBMITTED IN ACCORDANCE WITH PART I, CHAPTER 8 OF THIS VOLUME.

NOTE: MORE THAN ONE MIC NUMBER MAY BE ON A COMPONENT (E.G., VALVE BODY MAY HAVE ONE MIC NUMBER AND THE BONNET MAY HAVE ANOTHER MIC NUMBER). IF THE COMPONENT HAS A SHORTENED MIC MARKING, ENSURE THE FULL MIC MARKING IS AVAILABLE ON THE SHIPPING DOCUMENTS, TAGS AND/OR PACKAGING. VERIFY THAT THE SHORTENED MIC MARKING IS CORRECT IN ACCORDANCE WITH PARAGRAPH 6.3.7 OF THIS CHAPTER AND REFERENCE (a).

- d. Receipt of MCD-B material without an RFI tag, an EB Blue tag or received from a contractor/activity assigned by the Program Manager to supply the specific DSS will be receipt inspected by the CMPO and certified by the QAO as follows:

<u>Procedure</u>	<u>Responsibility</u>
Review vendor data (if provided with material), MIL-STD, and/or FMA manufacturing and test data to ensure that it all matches. See note at end of this table regarding vendor data.	Sustaining/User Activity CMPO/CMH/QAI/QAO
Fill out QA form 1 to document the receipt inspection.	Sustaining/User Activity CMPO/CMH/QAI
File QA form 1 with all applicable documents.	Sustaining/User Activity Quality Assurance Supervisor/QAI/CMPO

NOTE: QA FORM 1 IS NOT REQUIRED FOR SHIP’S FORCE WHEN PERFORMING RECEIPT INSPECTION OF MATERIAL TO BE IMMEDIATELY INSTALLED FOR A SPECIFIC JOB. IF ALL MATERIAL IS NOT UTILIZED IN THE ONGOING JOB, QA FORM 1 MUST BE FILLED OUT PRIOR TO PLACING THE MATERIAL IN A STOWAGE LOCKER.

NOTE: IF THE COMPONENT HAS A SHORTENED MIC MARKING, ENSURE THE FULL MIC MARKING FROM THE SHIPPING DOCUMENTS, TAGS, AND/OR PACKAGING IS ENTERED ON QA FORM 1 AND QA FORM 2.

<u>Procedure</u>	<u>Responsibility</u>
Fill out and attach QA form 2 to the item. Turn over material to craftsman or stow in approved storage area.	Sustaining/User Activity CMPO/CMH/QAI
Forward QA form 1 to QA Office when the material has been issued for installation.	CMPO/CMH
If material fails any of above steps, reject the material and attach QA form 3.	CMPO/CMH

NOTE: VENDOR DATA - MATERIAL RECEIVED DIRECTLY FROM THE MANUFACTURER REQUIRES CERTIFICATION DOCUMENTATION IN ACCORDANCE WITH PARAGRAPHS 6.3.4.d.(1) THROUGH 6.3.4.e. OF THIS CHAPTER AS A MINIMUM. A THOROUGH REVIEW OF THE PROCUREMENTS SPECIFICATIONS IS NECESSARY TO ENSURE ALL REQUIREMENTS ARE MET.

- (1) COC which indicates any of the tests, if required, for implosion testing, cleanliness test, toxicity or flammability testing etc., have been satisfactorily accomplished.
 - (2) Certification that Hull, Mechanical and Electrical testing was accomplished as required by the specification. The COC must state each contractually invoked test by name and that it was performed satisfactorily. Actual test records are not required to be sighted.
 - (3) COC that the components comply with the requirements of the procurement documents, including invoked specifications and drawings.
- e. There is no receipt inspection or unique storage requirements for MCD-C material. MCD-C material shall be inspected by the Craftsman and certified on the applicable QA form by the QAI at installation.

<u>Procedure</u>	<u>Responsibility</u>
Visual inspection at installation to ensure material conforms to specified requirements such as stock number, design dimensions, surface condition, compliance with technical work instructions or any vendor/manufacturer supplied information.	Sustaining/User Activity Craftsman and QAI

NOTE: VENDOR DATA - MATERIAL RECEIVED DIRECTLY FROM THE MANUFACTURER REQUIRES CERTIFICATION DOCUMENTATION IN ACCORDANCE WITH PARAGRAPH 6.3.5 OF THIS CHAPTER AS A MINIMUM.

6.3.5 Verification of Completion of Required Testing. This section is only applicable to DSS-SOC material received without a D0, D4, D5, D6, D7, or D8 SMIC and associated RFI tag, received without an EB Blue tag or contractor/activity assigned by NAVSEA. Regardless of the MCD, if implosion testing, cleanliness testing, toxicity or flammability testing etc., are required by the applicable specification or drawing, a review of the OQE for these tests will be conducted prior to installation. If a COC is received with the component, it should be carefully reviewed to ensure that testing was performed satisfactory.

6.3.6 Authorized Material Certification Activities. This section provides a list of those activities that are currently authorized to receipt inspect and accept DSS-SOC controlled material. This list is provided as a reference to be used in performance of receipt inspections of paragraph 6.3.4.a, 6.3.4.b, and 6.3.4.c of this chapter.

- a. NAVSEA has authorized the following activity to certify material as MCD-A, MCD-B and MCD-C per reference (b) and this material may be used for DSS-SOC applications without further receipt inspection, other than normal receipt inspections of paragraph 6.3.4.a, 6.3.4.b, and 6.3.4.c of this chapter. The activity and their designator are:

<u>Activity</u>	<u>Identification Code</u>
Portsmouth Naval Shipyard	A

6.3.7 Marking of DSS-SOC Stock Program Material.

6.3.7.1 General Requirements. DSS-SOC Stock Program Material passes from the manufacturers into the Navy supply system by way of a Navy receipt inspection activity, which examines the material and subjects it to a number of tests. DSS-SOC material which meets acceptance criteria is marked with a unique identifying number traceable to the OQE.

- a. The purpose of the unique identifying number is four-fold:
- (1) To denote that the marked material has been inspected, verified and accepted.
 - (2) To verify the material in hand by comparing it to the applicable drawings, plans, ordering requirements, and installing documents.
 - (3) To provide traceability from the installed material to OQE.
 - (4) To preclude complete re-inspection of material accepted by an approved activity.
- b. Two problems arise in application that can defeat the purpose of the unique identifying number:
- (1) Internal components of an assembly which is marked with a unique identifying number on the exterior, are usually not marked individually, and can lose their identity as DSS-SOC material if separated during disassembly. Strict adherence to “bag and tag” requirements, using fleet QA forms, overcomes this problem. Any part that becomes separated from its QA form (a loss of traceability) must be treated as uncontrolled material.
 - (2) Reference (d) permits the use of a securely attached RFI tag in cases where material is non-metallic, cannot be marked without disassembly, are too small for marking (less than 3/8 square inch), oxygen clean items, welding consumables, plated parts or hardened material and all MCD-B/MCD-C material. The complete unique identifying number is recorded during receipt inspection. Although the unique identifying number may not be visible once the item is installed, traceability is maintained through the retained QA paperwork and tags associated with the job, which will list the full unique identifying number.
- c. The unique identifying number is in addition to the required manufacturer’s marking.
- d. Altering of a DSS-SOC unique identifying number is prohibited.
- e. Method of marking DSS-SOC material. The physical marking method is described in reference (d).
- f. Items not physically capable of being marked. Items such as small parts are packaged in homogeneous lots (i.e., same heat, batch or melt; and same vendor traceability) and the package is marked. If the package is opened, the individual items removed must be tagged with QA form 2. The remaining items in the package will be controlled by the use of a single QA form 2 attached to the package.

6.3.7.2 SMIC DSS-SOC Material Acceptance Identification. Per reference (d), MCD-A metallic material shall be permanently marked. Items that cannot be marked due to physical limitations, and all MCD-B/MCD-C material, shall be identified as follows:

- a. Serialization marking shall be by use of a securely attached RFI tag. The RFI tag shall contain the Receipt Inspection serial number, MCD level, the NSN and the contract number. The RFI tag shall clearly state, “Based upon review of the OQE, this material meets the requirements of the applicable specification and/or drawing and is certified for use in DSS-SOC applications.”

- b. Serialization of MCD-A material shall bear a number consisting of a two digit year, three digit Julian day, a daily serial number between 001 and 099, the Receipt Inspecting Activity Certifying Activity Designator followed by "MCDA". For example: "08137-001A-MCDA".
- c. Serialization of MCD-B and MCD-C material shall utilized the Receipt Inspection Management System for technical inspection with the prefix "MCDB" or "MCDC", followed by the two digit year, a three digit Julian date, the Receipt Inspecting Activity Certifying Activity Designator and a daily serial number. For example: "MCDB 08137-A01" or "MCDC 08137-A06".

6.4 STORAGE, ISSUE AND HANDLING OF SCOPE OF CERTIFICATION MATERIAL. Refer to Part I, Chapter 6, paragraph 6.3.9 of this volume for process requirements related to storage, staging, issue and handling of SOC material.

6.5 RE-USE OF PREVIOUSLY CERTIFIED SCOPE OF CERTIFICATION MATERIAL.

6.5.1 Material Removed from a Deep Submergence System/Operating Ship. Material removed from a DSS/operating ship to be installed in a SOC application on another DSS/ship is acceptable under the following conditions:

- a. Re-Entry Control (REC) is used to document material removal from the supplying ship. The supplying DSS/ship must be certified and REC must still be in effect.
- b. The following shall be supplied by the supplying ship to the receiving ship:
 - (1) All outstanding DFS on the component.
 - (2) Any applicable technical variance documentation.
 - (3) The last accomplishment date and category of all applicable Maintenance Requirement Card (MRC) inspections.
 - (4) All legible component markings shall be documented.
 - (5) A copy of the supplying ship's REC.
- c. Positive control and identification shall be maintained from removal through reinstallation.
- d. All documentation listed in sub-paragraph b of this paragraph shall be maintained and filed with the REC package that installs the component on the receiving ship.
- e. The receiving activity shall conduct a material receipt inspection to verify the following:
 - (1) Received component came from a certified system and REC has been maintained and that positive control has been maintained since removal from the supplying activity.
 - (2) Material marking or tagging on hardware matches material marking on supporting software.
 - (3) Applicable MRC inspections or any other maintenance actions are current for the intended end use.
 - (4) End use installation is consistent with the previous service parameters such as the design pressure rating, design temperature rating or system applicability of the component.
- f. Receiving activity shall update applicable software to document information and records (e.g., DSS or Ship's Drawing Index for drawing revision) date of last MRC periodicity accomplishment and documentation of outstanding DFS into installing DSS or ship's Current Ship's Maintenance Project.

6.5.1.1 Non-Conforming Material. Material that is received from a DSS/operating ship to be installed in a SOC application that does not meet all the requirements of paragraph 6.5.1 of this chapter may be acceptable under the specific instances listed below.

- a. Material received which is not current with respect to the applicable MRC inspection or any other required maintenance actions that are not current for the intended use shall have the applicable maintenance actions completed. Any inspection or maintenance action not completed must be departed using the process of Part I, Chapter 8 of this volume.

- b. Material which has an end use that is not consistent with the previous service parameters shall be subject to and satisfy the testing requirements for a new component installed in the receiving DSS or ship, provided the design is consistent with the intended end use.

6.5.2 Reuse of Scope of Certification Material. Reuse of SOC material from a ship whose certification has lapsed by virtue of inactivation availability is acceptable under the following conditions:

- a. Prior to commencement of system disassembly, material identified for transfer must be included in an identification and transfer system designated for this application. This system must provide a means for tagging components to be transferred to preclude compromise of material control integrity through unauthorized re-entry. NAVSEA considers existing tag-out systems as an adequate template for this identification system, however, identification system tags must be durable and clearly discernible from existing "tag-out" system tags.
- b. The identification tags must include as a minimum:
 - (1) The statement that the component is SOC material and that the component is not to be removed until the tag is uniquely marked by the facility conducting the inactivation.
 - (2) The DSS/Ship hull number (e.g., SSN 752).
 - (3) System and item identification (e.g., MIC number, ASW-1, etc.).
 - (4) Activity unique identifier (e.g., PHNSY-657-001).
- c. The following shall be supplied by the supplying activity/ship to the receiving ship:
 - (1) All outstanding DFS on the component.
 - (2) Any applicable technical variance documentation.
 - (3) The last accomplishment date and category of all applicable MRC inspections.
 - (4) All legible component markings shall be documented.
 - (5) A copy of the supplying ship's REC.
- d. All work completed on the material/component after removal from the supplying DSS/ship shall be documented and controlled by a REC.
- e. Those fasteners removed which connect a transferred item to equipment or components remaining on board, such as valve flange fasteners, shall not be shipped with the item, since to do so needlessly complicates the certification process.
- f. The receiving activity shall conduct material receipt inspection to verify the following:
 - (1) Attached material identification tag and material marking on the material matches the documentation provided from the facility conducting the inactivation.
 - (2) End use installation is consistent with the previous service parameters such as the design pressure rating, design temperature rating or system applicability of the component.
- g. The receiving activity must complete any maintenance due or overdue for the material. Any inspection not performed or other maintenance action not completed must be departed.
- h. The receiving activity must maintain documentation of receipt, inspection, installation and testing of the provided material.
- i. The material will be installed using a REC.

6.5.3 Material Recertification Required.

- a. Material which does not satisfy the requirements of paragraphs 6.5.1 or 6.5.2 of this chapter shall require full component certification to all DSS program requirements prior to use. Documentation of this certification shall be traceable from the installing activity's REC.

- b. If the SOC material to be transferred is designated for non-SOC end use, and if the removal is to be accomplished subsequent to the Inactivation Availability start date, applicable non-SOC transfer requirements are in effect. These requirements for Submarine Safety components are in reference (e) and the requirements for Level I components are in reference (a).

6.5.4 Material Re-certification Following Transfer to Outside Agency (Excluding Naval Shipyards). Material transferred to and received from an outside maintenance organization which is not under Joint Fleet Maintenance Manual controls (to exclude Naval Shipyards audited by NAVSEA) will be handled in the following manner:

<u>Procedure</u>	<u>Responsibility</u>
Remove existing attached QA form 2 and retain in Controlled Work Package for OQE.	Sustaining/User Activity
Transfer existing material using DD 1149 to and from the Outside Agency.	Sustaining/User Activity Department Head
Upon receipt, review vendor data, COC and test data as required by applicable specifications.	Sustaining/User Activity CMPO/CMH/QAI/QAO
Fill out QA form 2 in accordance with Part III, Chapter 11 of this volume and attach to the item. Turn over material to craftsman or stow in approved storage area.	Sustaining/User Activity CMPO/CMH/QAI
Place COC in respective REC for material control documentation.	Sustaining/User Activity QAI/Quality Assurance Supervisor
If material fails any of above steps, reject the material and attach QA form 3.	Sustaining/User Activity CMPO/CMH

6.5.5 Material Re-certification Following Transfer to a Naval Shipyard. Material transferred to and received from a Naval Shipyard which is not under Joint Fleet Maintenance Manual controls but is audited by NAVSEA will be handled in the following manner:

<u>Procedure</u>	<u>Responsibility</u>
Existing QA form 2 will remain attached to the component. Fill out QA form 2 Blocks 13 through 16 to document transfer to the Naval Shipyard	Sustaining/User Activity
Attach Material Tracking Tag (MTT) or equivalent. The MTT (or equivalent) shall include component identification, Shipyard Task Group Instruction and any special requirements (e.g., maintain diver air clean in accordance with MIL-STD-1622 for critical applications).	Naval Shipyard
Upon receipt, fill out QA form 2 Blocks 13 through 16 to document receipt from the Naval Shipyard. Positively identify the material, review certification/test data and verify proper cleanliness controls have been met as required by applicable specifications. Document results on QA form 2 Block 15. Shipyard certification/test data that has been satisfactorily reviewed and recorded on QA form 2 Block 15 may be discarded.	Sustaining/User Activity CMPO/CMH/QAI/QAO

Turn over material to craftsman or stow in approved storage area.

Sustaining/User Activity
CMPO/CMH/QAI

Place QA form 2 and MTT (or equivalent) in respective REC for material control documentation. QA form 2 and MTT (or equivalent) may be discarded after the associated REC has been closed.

Sustaining/User Activity
QAI/Quality Assurance Supervisor

If material fails any of above steps, reject the material and attach QA form 3.

Sustaining/User Activity
CMPO/CMH

(This Page Intentionally Left Blank)

VOLUME V
PART III
CHAPTER 7
TESTING REQUIREMENTS

REFERENCES.

- (a) NAVSEA SS800-AG-MAN-010/P-9290 - System Certification Procedures and Criteria Manual for Deep Submergence Systems
- (b) NAVSEA SS521-AA-MAN-010 - U.S. Navy Diving and Manned Hyperbaric Systems Safety Certification Manual
- (c) NAVSEA S9505-AF-MMA-010 - Submarine Non-Nuclear Piping Systems Test Manual

7.1 **PURPOSE.** To provide additional guidance for Deep Submergence Systems (DSS) that cannot be found in Part I, Chapter 7 of this volume.

7.2 **TESTING REQUIREMENTS.** Testing shall be in accordance with Part I, Chapter 7 of this volume with the following additions/exceptions:

- a. Hydrostatic Testing Requirements:
 - (1) Implodable/explosive testing shall be in accordance with references (a) and (b), as applicable. Additional implodable/explosive requirements may be contained in the applicable Scope of Certification Notebook.
 - (2) Pipe and piping components whose pressure boundary is externally loaded by sea pressure, but whose internal maximum operating pressure is equal to or greater than DSS design test depth pressure, shall only require an internal hydrostatic test.
 - (3) Pipe and piping components whose pressure boundary is externally loaded by sea pressure, but whose internal maximum operating pressure is less than DSS design test depth pressure, shall only require an external hydrostatic test. Additional guidance on external hydrostatic test requirements is contained in reference (a).
 - (4) Pipe and piping components that penetrate any hull integrity boundary where a single failure could result in internal flooding of the DSS unit shall be hydrostatically tested from the hull integrity boundary penetration inboard to the first isolation valve at a pressure equal to 150% of DSS design test depth or 150% of system maximum operating pressure, whichever is greater.
 - (5) Pipe and piping components open to internally pressurized tanks and/or enclosures (including hyperbaric chambers) shall be hydrostatically tested internally from the tank and/or enclosure penetration outboard to the first isolation valve at a pressure equal to the pressure used to hydrostatically test the tank and/or enclosure. These requirements are not applicable to piping and piping components open to compressed gas flasks.
 - (6) External hydrostatic test acceptance criteria of “no permanent deformation” for pipe shall, in addition to a complete visual inspection, be verified by out of roundness measurements. Out-of-roundness measurements not within the pipe specification, approved drawing or Military Standard 1627 (for pipe bends) shall be cause for rejection of the item.
- b. Joint Tightness Testing.
 - (1) Pipe and piping components whose pressure boundary is externally loaded by sea pressure, but whose internal maximum operating pressure is equal to or greater than DSS design test depth pressure, shall only require an internal joint tightness test.

- (2) Pipe and piping components whose pressure boundary is externally loaded by sea pressure, but whose internal maximum operating pressure is less than DSS design test depth pressure, shall require both external and internal joint tightness testing. Note that the ability to conduct external joint tightness testing is extremely limited. This testing is normally deferred using a Controlled Assembly in accordance with Part I, Chapter 7 of this volume, documenting a minor Departure from Specification and retesting during a dive to design test depth.
 - (3) Pipe and piping components that penetrate any hull integrity boundary, where a single failure could result in internal flooding of the DSS unit, shall be joint tightness tested from the hull integrity boundary penetration inboard to the first isolation valve at a pressure equal to 100% of DSS design test depth pressure or 100% of system maximum operating pressure, whichever is greater.
 - (4) Pipe and piping components open to internally pressurized tanks and/or structural enclosures (including hyperbaric chambers) shall be joint tightness tested internally from the tank and/or enclosure penetration outboard to the first isolation valve at a pressure equal to 100% of the maximum internal operating pressure of the tank and/or enclosure. These requirements are not applicable to piping and piping components open to compressed gas flasks.
- c. Pressure Drop Testing.
- (1) Pressure drop testing for oxygen, helium, helium-oxygen, nitrogen and hydrogen diving systems shall be as specified in reference (b).
 - (2) Pressure drop testing of submarine compressed air systems shall be as specified in reference (c).
- d. Objective Quality Evidence. Objective Quality Evidence (OQE) documenting the satisfactory accomplishment of all required testing shall be available and maintained in a format suitable for review and audit. Reference (a), Appendix J contains a detailed list of information which must be documented as OQE for testing. Existing forms contained in Part I, Chapter 11 of this volume do not capture all required OQE data. Forms contained in Part III, Chapter 11 of this volume should be used to support documentation of all reference (a), Appendix J OQE data. All mechanical joint tightness and hydrostatic testing (both those utilizing an external pressure source or internal system pressure) should be documented on QA form 26A to ensure the requirements of reference (a), Appendix J are met. In the event standardized forms are not available, it is permissible to modify and use the forms in Part I, Chapter 11 of this volume and standardize these forms within the Sustaining Activity organization.
- e. Operational Test. A test of a system to nominal operating pressure using the system fluid, system pumps and installed system gage(s) vice test instrumentation to determine leak tightness.
- (1) A drop test meeting requirements of paragraph 7.2.c. above may be performed as an operational test.
 - (2) An operational test can be used to satisfy a mechanical joint tightness test.

VOLUME V
PART III
CHAPTER 8
DEPARTURE FROM SPECIFICATIONS

REFERENCES.

- (a) NAVSEA SS800-AG-MAN-010/P-9290 - System Certification Procedures and Criteria Manual for Deep Submergence Systems

8.1 **PURPOSE.** To establish standard procedures to be used for reporting and requesting approval and clearance, at the earliest opportunity, of all non-conforming/departable conditions, Departures from Specification (DFS) associated with Scope of Certification (SOC) systems on Deep Submergence Systems (DSS). The guidance of Part 1, Chapter 8 of this volume and reference (a) should be used for handling DFS situations with the modifications listed below.

8.2 **DEPARTURE FROM SPECIFICATION.**

- a. A DFS is a non-conformance of any certification attribute from the intended or as-certified condition of the DSS. This includes non-conformances to approved drawings, components, specifications, technical manuals, operating and emergency procedures, maintenance procedures and any other authoritative document specifying a certification attribute of the DSS. DFS are identified as either a Deviation or Waiver.
- (1) Deviation: A DFS which is requested prior to a planned non-conformance.
- (2) Waiver: A DFS which is requested subsequent to the non-conformance occurring.
- b. Should any system, equipment or component within the SOC fail to operate within specifications, regardless of how the deficiency is discovered, and repair at the Sustaining Activity level is not practicable prior to manned operations, a Major DFS shall be submitted.

8.2.1 **Reporting Departures from Specification.** It is incumbent upon User Activities, Sustaining Activities, Fleet Maintenance Activities and Immediate Superiors In Command to discuss potential DFS as early as possible (prior to the work close out or component assembly if possible) to determine direction of actions and alternatives to the DFS. Every effort must be made to correct each deficiency prior to equipment/system operation or underway of the DSS.

8.2.2 **Approval of Departures from Specification.** All SOC DFSs require Program Manager approval with System Certification Authority (SCA) concurrence prior to manned use of the DSS. Immediate Superiors In Command and Type Commanders are required to present all DFS items to the Program Manager for approval, except as noted in the SOC Notebook.

8.2.3 **Major and Minor Departure from Specification Classification.** These are specified in Part 1, Chapter 8 of this volume and each activities SOC notebook.

8.2.4 **General Administrative Requirements.** The following requirements pertain to all DFS:

- a. The User Activity and Sustaining Activity are responsible for all approved DFS relating to their systems/components until cleared or canceled. When a DFS is approved as a temporary repair requiring rework to correct the discrepancy, the ship referencing the DFS sequential number will initiate a Current Ship's Maintenance Project entry for correction of the discrepant condition. The ship's Quality Assurance Officer will ensure that this action is done.
- b. The Sustaining Activity shall maintain a master departure log (or computer program equivalent) of all waivers and deviations approved for each DSS. The log shall contain, as a minimum, the following:
- (1) DSS unique identifier.
- (2) Departure number.

- (3) Departure title.
 - (4) Classification (Major or Minor).
 - (5) Type of departure (Deviation or Waiver).
 - (6) Date requested.
 - (7) Date resolved/approved.
 - (8) Approval or disapproval status.
 - (9) Conditional approval comments (if applicable).
 - (10) A copy of all applicable Naval Sea Systems Command correspondence delegating local approval of DFSs.
- c. Each activity shall maintain all DFSs in a form suitable for audit including supporting justification, technical documentation, calculations, rationale and related correspondence.
 - d. When an activity performs work which results in a conditionally approved DFS or waiver which requires future action (e.g., re-inspection, repair), the ship will submit an OPNAV 4790/2K (or equivalent) with a new Job Sequence Number. This Job Sequence Number will be added to the DFS prior to submission to the Immediate Superior In Command. The Current Ship's Maintenance Project Job Sequence Number will be included in Block 17 of the DFS form.

8.2.5 Submission and Approval of Departures from Specification.

- a. A copy of the waiver or deviation shall be forwarded to the applicable asset and its planning yard. This applies to both approved and/or disapproved waivers and deviations to ensure the planning yard is kept fully informed and for maintenance of the asset historical file.
- b. The approval and routing actions are the same as listed in Part 1, Chapter 8, paragraph 8.3.7 of this volume with the User Activity performing the ship functions and the Sustaining Activity performing the Fleet Maintenance Activity functions.
- c. Unless specifically delegated by the Program Manager and approved by the SCA, the Program Manager must approve all DFSs and obtain SCA concurrence.

8.2.6 Departure from Specification Approval and Reporting for DSSs While at Sea. The Commanding Officer or Officer in Charge will evaluate any DFS and approve the corrective action to be taken including any necessary restrictions.

- a. The decision to continue manned operation of the DSS shall be made only after a careful review of the impact the deficiency will have on DSS personnel safety under all normal and emergency conditions. A report to the Program Manager via the chain of command will be made at the first opportunity.
- b. As a minimum, the report shall contain a description of the condition as well as the intended actions. If continued operation of the DSS is intended, the report shall include a statement of impact on the ability of the system to operate safely, specifics and any required temporary local changes to the operating and emergency procedures made as a result of the deficiency and any imposed operating restrictions.
- c. If the condition is not corrected during the next in-port period (i.e., a port with a fleet maintenance facility), it shall be forwarded as a DFS report for approval prior to the next manned use of the DSS.

VOLUME V**PART III****CHAPTER 9****AUDITS, SURVEILLANCE, EVALUATIONS, ASSESSMENTS AND SURVEYS****REFERENCES.**

- (a) SS800-AG-MAN-010/P-9290 - System Certification Procedures and Criteria Manual for Deep Submergence Systems
- (b) NAVSEA SS521-AA-MAN-010 - U.S. Navy Diving and Manned Hyperbaric Systems Safety Certification Manual

9.1 **PURPOSE.** Provide requirements, procedures and criteria for audits, surveillance, evaluations and assessments for Scope of Certification (SOC) systems. The requirements of Part I, Chapter 9 of this volume should be followed with the exception of the modified sections below.

9.2 **RESPONSIBILITIES AND PROCEDURES.**

9.2.1 **User Activity Surveillance and Evaluation Program.** The responsibilities and procedures listed for Ship's Force in Part I, Chapter 9, paragraph 9.3.1 of this volume should be used by the User Activity.

9.2.2 **Sustaining Activity Audit, Surveillance and Evaluation Program.** The responsibilities and procedures listed for Fleet Maintenance Activities in Part I, Chapter 9, paragraph 9.3.2 of this volume and reference (a) should be used by the Sustaining Activity with the modifications listed below.

- a. Deep Submergence Systems (DSS) Sustaining Activities shall schedule and conduct an internal survey within 12 months of the last sustaining survey. A second internal survey shall be performed not more than 30 days prior to the next sustaining survey unless otherwise directed by the program SOC Notebook. Results of all internal surveys shall be forwarded to Naval Sea Systems Command (NAVSEA) for review.

NOTE: IF THE SYSTEM CERTIFICATION AUTHORITY (SCA) SURVEY PERIODICITY FOR THE DSS IS 15 MONTHS OR GREATER, THE SUSTAINING ACTIVITY SHALL PERFORM AT LEAST TWO INTERNAL SURVEYS BETWEEN THE SCA SURVEYS. THE SUSTAINING ACTIVITY SHALL COMPLETE THE FIRST INTERNAL SURVEY WITHIN 12 MONTHS OF THE LAST SUSTAINING SURVEY.

- b. Results of audits and evaluations will be provided to the Commanding Officer or Officer in Charge.

9.2.3 **Immediate Superiors In Command Assessments, Audits and Surveillance.** The responsibilities and procedures listed for Immediate Superiors In Command (ISIC) in Part I, Chapter 9, paragraph 9.3.3 of this volume should be used with the modifications listed below.

- a. ISICs shall schedule and conduct a Quality Assurance (QA) Program assessment of all assigned User and Sustaining Activities. SOC and Hull Inspection Procedures should be substituted for Submarine Safety and Unrestricted Operation/Maintenance Requirement Cards respectfully where specified.
- b. ISICs will conduct the following additional periodic audits and surveillance:
 - (1) Conduct periodic monitoring of User Activity controlled work and QA program on all assigned DSSs during maintenance periods.
 - (a) Perform at least one surveillance during each refit/upkeep/fleet maintenance availability.
 - (b) Conduct monitoring during industrial availabilities.
 - (2) Conduct monitoring of assigned Sustaining Activity QA. This monitoring will include:
 - (a) Review of work procedures including opening and closing practices.

- (b) Monitoring of in progress work both on tended ships and in Sustaining Activity work centers.

9.2.4 Type Commander Assessments. Type Commanders (TYCOM) should follow the guidance of reference (b) and Part I, Chapter 9, paragraph 9.3.4 of this volume for assessments of ISICs associated with DSSs. The assessment will include a review of SOC controlled work packages.

9.3 SYSTEM CERTIFICATION AUTHORITY CERTIFICATION SURVEYS AND FUNCTIONAL AUDITS.

9.3.1 Certification Process. The below requirements define reference (a) certification processes for TYCOM Activities and is the process the SCA and NAVSEA Program Managers will use when certifying or auditing Fleet Deep Submergence System (DSS) Sustaining Activities. Surveys for Certification (Initial Certification), Reinstatement of Certification and Sustaining Certification (Sustaining Surveys) are performed by NAVSEA 07 as the SCA in accordance with reference (a). Functional Audits may be performed at the discretion of the SCA. TYCOM assessments performed in accordance with Part I, Chapter 9 of this volume meet Functional Audit requirements and shall be submitted, copy to the SCA, via the Program Manager.

9.3.2 Certification Survey Cards. SCA survey deficiencies noted during the survey and the recommended corrective action shall be documented in the form of certification survey cards.

9.3.2.1 Categorization of Certification Survey Cards. Survey cards for Certification or Functional audits of the DSS shall be categorized as follows:

- a. Category IA. Findings of such importance that manned use of the system will not be authorized and certification will be withheld until the deficiencies are satisfactorily resolved. These deficiencies must be satisfactorily resolved and the resolutions accepted by the Program Manager and SCA to ensure the material condition of the DSS is verified as satisfactory prior to manned use.
- b. Category IB. Findings which will allow manned use of the system for conduct of specific controlled evolutions, but will not allow issuance of the Letter of Certification until the deficiencies are satisfactorily resolved or required actions taken. These findings must be satisfactorily resolved and the resolutions accepted by the Program Manager and SCA to ensure the material condition of the system is verified as satisfactory for use prior to the issuance of the Letter of Certification.
- c. Category IC. Findings of such importance that satisfactory resolution must be accomplished prior to a specific date or event specified on the survey card to sustain certification. These items must be satisfactorily resolved and the resolutions accepted by NAVSEA or be granted an extension approval from the SCA prior to the date or event specified in order to sustain certification.
- d. Category II. Findings which, while not mandatory for resolution to obtain or maintain certification, identify systemic weaknesses in the DSS program. These deficiencies should be resolved in a timely manner.
- e. Category III. Items audited and found acceptable.

9.3.2.2 Categorization of Functional Audit Cards. Survey cards for functional audits of the DSS activity shall be categorized as follows:

- a. Certification. A non-compliance that affects or potentially affects the certification of a DSS; including a certified DSS. Resolution of a Certification item is mandatory prior to certifying DSS for manned operations.
- b. Non-Compliance. Any violation of documented requirements (e.g., local, NAVSEA or higher-tier instructions, procedures, specifications or contracts).
- c. Operational Improvements. A condition that while not a specific requirement violation, may cause a degradation in the effectiveness of the DSS program, or an observation expected to offer significant improvement in the effectiveness of the DSS program.

9.3.3 Administration of Survey/Audit Findings. Survey/audit findings shall be forwarded by official correspondence (i.e., letter). SCA surveys and Functional Audits of TYCOM activities will be forwarded from the Program Manager to the Sustaining Activity via the ISIC and an informational copy to the respective TYCOM. Responses from the Sustaining Activity shall be forwarded to the SCA via the ISIC and an informational copy to

the respective TYCOM and the Program Manager. When a survey or audit identifies program deficiencies at a TYCOM Fleet Maintenance Activity the routing of the findings and responses shall be made via the assigned chain of command. Findings identified at NAVSEA managed activities or contractors will be forwarded as defined by the Program Manager, copy to the Sustaining Activity and the assigned chain of command. Category IA, Category IB and applicable Category IC findings affecting manned operations shall be acted on immediately by the activity surveyed or audited regardless of the status of the official correspondence. While the Program Manager is responsible for the management and tracking of Category IA, Category IB and Category IC survey items, the ISIC will also track status of all survey findings.

9.3.4 Administration of Surveys for Initial Certification or Reinstatement of Certification. Initial Certification surveys are performed for certification of a DSS during new construction or new acquisition. Surveys performed to reinstate certification are performed following a suspension, such as failure to perform a Sustaining Survey on time or due to an event that causes decertification, such as a casualty or a major availability. The NAVSEA Program Manager will suspend certification when a Sustaining Survey due date is exceeded, when a significant casualty occurs or when major repairs, work or modifications defined during a maintenance period would affect certification of the DSS. The SCA will reinstate system certification when the cause for the suspension/decertification has been thoroughly investigated, satisfactorily corrected or restored, and the material and procedural adequacy of the DSS has been reestablished. A Certification Survey Plan (CSP) specified by the Program Manager and approved by the SCA identifies all of the surveys and testing required to be met to fulfill the certification or reinstatement of certification requirements of the DSS. When the CSP requirements are met, the SCA will define certification for a specific period of time or identify when the next Sustaining Survey will be performed.

9.3.4.1 Actions to Support Surveys for Initial Certification or Reinstatement of Certification. Internal surveys for initial certification or reinstatement of certification following overhaul or major availabilities, are normally performed by the Maintenance Activity to support the SCA survey in accordance with the CSP. For all other reinstatement of certification scenarios the Sustaining Activity will submit a CSP tailored to ensure all SOC work and all operations performed since the last survey receive an adequate review to the Program Manager for approval by the SCA via the ISIC and an informational copy to the respective TYCOM. The Program Manager, with SCA concurrence, will formally specify the requirements for reinstatement of certification. The following prerequisites have been established to ensure an activity is ready to support a certification survey:

- a. For initial certification, 85 percent of SOC Re-Entry Control (REC) work must have been completed. Complete work means all work, testing and recertification associated with the document has been completed.
- b. All SOC maintenance requirements must be current and, if requested, reports submitted to the SCA prior to the start of the survey.
- c. All maintenance logs must reflect the current status of maintenance actions.
- d. Deferred maintenance requirements must be appropriately approved and documented in accordance with existing documents.
- e. At least 90 percent of the SOC portion of all strength and tightness tests shall be completed. All SOC operational tests and inspections which are possible to complete shall be complete. At-sea and manned testing is excluded from these requirements.
- f. Provide a list of all open (unapproved or conditionally approved) Departures from Specification.
- g. Sustaining Activity must obtain NAVSEA approval of an updated Certification Survey Plan at least two weeks prior to the SCA survey.
- h. The activity's internal survey must be completed not more than 30 days prior to the SCA survey and the results of the internal survey must be submitted to NAVSEA at least 10 working days prior to the start of the SCA survey.
- i. An updated copy of the activity's internal survey reflecting actions taken as a result of the finding shall be available to the SCA at the time of the SCA survey.

- j. Key personnel must be present (Officer In Charge, Engineering Officer, etc.) to support the survey. It is also essential that qualified personnel knowledgeable in all aspects of the DSS be available and ready to assist the survey team.

9.3.4.2 Authorization of Operational Demonstration for Initial Certification or Reinstatement of Certification.

These surveys support Builder's Trials or Sea Trials to complete the initial certification or reinstatement of certification per reference (a), section 3.7. Satisfactory completion of trials is mandatory to achieve final certification. Contingent upon the DSS material condition and status of findings of the survey, the SCA will normally authorize manned dockside testing and manned at-sea testing in pursuit of certification via the Program Manager to the TYCOM of the Sustaining Activity. The TYCOM will forward the SCA recommendations to the Sustaining Activity and authorize the applicable operations.

NOTE: MANNED USE OF THE DSS WILL NOT BE AUTHORIZED UNTIL THE SCA CERTIFIES TO THE SUSTAINING ACTIVITY VIA THE ASSIGNED TYCOM THAT THE SYSTEM IS CERTIFIED TO SUPPORT THE REQUIRED TESTING.

- a. Survey findings will be formally forwarded to the Sustaining Activity via the ISIC and an informational copy to the respective TYCOM and maintenance activity as applicable. The Sustaining Activity response will be provided to the SCA via the ISIC and an informational copy to the respective TYCOM. Survey findings to allow manned operations will be processed as follows:
 - (1) When action identified by a specific card has been completed, a brief summary of the corrective action shall be written on the card and the card shall be signed by the Command responsible for the corrective action. All applicable Objective Quality Evidence documenting the corrective action taken shall be attached to the signed card, and forwarded to the SCA via the ISIC and an informational copy to the respective TYCOM.
 - (2) Category IA, Category IB and applicable Category IC findings affecting manned operations, will be accepted by the SCA in accordance with reference (a). The Program Manager will provide copies of all completed survey cards to the Sustaining Activity via the TYCOM and/or ISIC, as applicable.
- b. The User Activity or Sustaining Activity, as applicable, shall submit a trial schedule to operational chain of command for approval by the SCA via the Program Manager. Included shall be a description of general environmental considerations concerning safety (e.g., sea state limits, visibility limits, DSS handling capabilities, limits on diving under overhangs, cables, caves, etc.).

9.3.4.3 Certification/Reinstatement of Certification. Upon satisfactory completion of all testing identified by the CSP, and completion of all SCA/Program Manager actions specified to resolve any test deficiencies, the SCA will certify the DSS or reinstate certification of the DSS to the TYCOM via a Letter of Certification. TYCOM shall formally forward the Letter of Certification to the designated Sustaining Activity, copy to the operational chain of command, the Program Manager and the SCA.

9.3.5 Manned Use in Pursuit of Certification or Reinstatement of Certification.

- a. When pursuing initial certification or reinstatement of certification there may be occasion where manned testing or training is required prior to conducting operational demonstration/trials testing. An assessment of items that could impact operator safety is necessary prior to conducting manned testing or training without obtaining formal SCA approval. The assessment shall be provided to the activity immediately senior to the User Activity for approval. A copy of the assessment shall be provided to the SCA, via the Program Manager, for information only, at least 24 hours prior to the evolution. If conducting testing or training at greater than one atmosphere, this section does not apply and formal SCA approval shall be obtained.
- b. For manned testing with the DSS wet, the system will be tethered and in a pool, tethered to a certified lift system in port or in a certified captured lift system in port or at sea. Any other configuration while wet requires SCA approval prior to conducting the test. The following items must be assessed to support either wet or dry manned testing:
 - (1) Provide an impact assessment for any open Category IA survey cards.

- (2) Identify any outstanding deficiencies that may impact testing/dives.
 - (3) Identify all open RECs and their impact on planned testing/dives.
 - (4) Ensure life support and communications system testing has been completed satisfactorily and are functioning properly.
 - (5) Ensure the results of the closed boat atmosphere analysis (bomb sample) are satisfactory.
 - (6) Ensure Operating Procedures/Emergency Procedures that will be used during the test/training, including pre-dive and post-dive procedures, have been updated to reflect new installations and system modifications.
 - (7) Ensure preventive maintenance procedures that will be used prior to and during the test/dive, have been updated to reflect new installations and system modifications.
 - (8) Ensure the safety analysis of new installations or modified systems that will be operated or tested during the dive has been evaluated by NAVSEA and that there are no hazards that impact planned tests/dives.
 - (9) Ensure electrical system testing (e.g., continuity, insulation resistance and ground checks) have been accomplished to the extent necessary to ensure electrical hazards do not exist to the operators.
- c. For other than one atmosphere DSS systems, all manned testing or training conducted at other than one atmosphere requires SCA authorization.

9.3.6 Sustaining Certification Surveys. Sustaining Surveys conducted by the SCA are performed to verify that the DSS has been operated and maintained in the as-certified condition in accordance with the Letter of Certification. These surveys are granted for a specific time frame or are due on a specific date following initial certification or the last Sustaining Survey.

9.3.6.1 Scheduling. The Sustaining Survey shall be scheduled for completion before the survey due date on the Letter of Certification or the previous Sustaining Survey letter. The periodicity of Sustaining Surveys is negotiated between the Program Manager and the SCA, is based upon results of the last survey, with other oversight and performance indicators taken into account. The periodicity shall not be greater than that established in the DSSs Scope of Certification Notebook. If the SCA Sustaining Surveys occur more than 15 months apart, the Sustaining Activity shall perform at least two internal surveys between the SCA surveys, not to exceed 12 months apart. The Sustaining Activity is responsible for scheduling Sustaining Surveys with the SCA via the Program Manager and the ISIC and/or TYCOM (as applicable). If the Sustaining Survey cannot be conducted prior to the survey due date due to operational circumstances, and manned use is required, the Sustaining Activity shall submit a request for Continuation of Certification per section 9.3.7 of this chapter.

NOTE: IF THE SUSTAINING SURVEY DUE DATE IS EXCEEDED, MANNED OPERATIONS OF THE DSS SHALL BE SUSPENDED UNTIL AUTHORIZED BY THE SCA AND TYCOM (AS APPLICABLE).

9.3.6.2 Actions to Maintain Certification. Internal surveys are performed by the Sustaining Activity to support the SCA survey in accordance with the CSP. The Sustaining Activity will perform an internal survey of DSSs on an annual basis and prior to the sustaining survey in accordance with section 9.2.2 of this chapter. Copies of these internal surveys are to be forwarded to the SCA via the Program Manager and the ISIC and/or TYCOM (as applicable). The following prerequisites have been established to ensure an activity is ready to support a sustaining certification survey:

- a. If the survey coincides with an availability with a duration of 30 days or less, 60 percent of SOC REC work must have been completed. If the availability is greater than 30 days, 85 percent of SOC REC work must have been completed. Complete work means all work, testing and recertification associated with the document has been completed. If the sustaining survey does not coincide with an availability, no work completion requirement exists, however, a complete list of all SOC work performed since the last survey will be provided to the SCA.

- b. All SOC maintenance requirements must be current and, if requested, reports submitted to the SCA prior to the start of the survey.
- c. All maintenance logs must reflect the current status of maintenance actions.
- d. Deferred maintenance requirements must be appropriately approved and documented in accordance with existing documents.
- e. If the survey coincides with an availability, at least 90 percent of the SOC portion of all strength and tightness tests shall be completed. All SOC operational tests and inspections which are possible to complete shall be complete. At-sea and manned testing is excluded from these requirements.
- f. Provide a list of all open (unapproved or conditionally approved) Departures from Specification.
- g. Sustaining Activity must obtain NAVSEA approval of an updated Certification Survey Plan at least two weeks prior to the SCA survey.
- h. The activity's internal survey must be completed and the results submitted to NAVSEA at least two working days prior to the start of the SCA survey or as specified in the specific DSS SOC Notebook.
- i. Key personnel must be present (Officer In Charge, Engineering Officer, etc.) to support the survey. It is also essential that qualified personnel knowledgeable in all aspects of the DSS be available and ready to assist the survey team.
- j. Deficiencies noted during the survey and recommended corrective actions shall be documented in the form of certification survey cards.

9.3.6.3 Authorization for Manned Use Following a Sustaining Survey. Following formal reporting of the Sustaining Survey by the SCA, all Category IA, Category IB and applicable Category IC findings shall be completed and accepted by the SCA prior to continued manned operations. If no Category IA, Category IB or Category IC audit cards are generated by the survey, manned use of the DSS may continue with no reports. Upon completion of a Sustaining Survey, manned use can be continued if the following actions are completed:

- a. All Category IA, Category IB and Category IC findings affecting manned operations with completed corrective actions shall be presented to the SCA via the chain of command as described previously in section 9.3.4.2.a(1) of this chapter.
- b. Category IA, Category IB and Category IC findings affecting manned operations will be accepted by the SCA in accordance with reference (a). The Program Manager will provide copies of all completed survey cards to the Sustaining Activity via the TYCOM and/or ISIC, as applicable.

9.3.7 Continuation of Certification. If the Sustaining Survey cannot be conducted prior to the survey due date due to operational circumstances, and manned use is required, the Sustaining Activity shall submit a request for Continuation of Certification. The following actions are required:

- a. At least six weeks prior to the expiration date of certification, the Sustaining Activity must submit an official request to NAVSEA via the operational chain of command for continuation of certification for a specific time period, and include written rationale for the continuation together with a status of maintenance and system condition.
- b. NAVSEA may conduct on-site surveys to verify system material condition and ensure that existing certification requirements have been properly sustained.
- c. The Sustaining Activity reports by message to NAVSEA, via the ISIC and an informational copy to the respective TYCOM, completion of any Category IA, Category IB and applicable Category IC survey deficiencies affecting manned operations, as applicable.
- d. The SCA grants continuation of certification to the Sustaining Activity, via the TYCOM for a specific period of time contingent on the overall DSS material condition. TYCOM will authorize the operations noting all required restrictions associated with the special case certification.

VOLUME V
PART III
CHAPTER 10
QUALITY ASSURANCE RECORDS

REFERENCES.

- (a) NAVSEA SS800-AG-MAN-010/P-9290 - System Certification Procedures and Criteria Manual for Deep Submergence Systems
- (b) NAVSEAINST 4720.23 - Deep Submergence Systems Temporary Modifications

10.1 PURPOSE. Provide record keeping and retention requirements for the Quality Assurance records used in the Scope of Certification Program per reference (a). The requirements of Part I, Chapter 10 of this volume apply as modified below.

10.2 DEPARTURE FROM SPECIFICATION RECORD RETENTION.

- a. Each activity, Type Commander, Immediate Superior In Command, User Activity and Maintaining Activity is required to maintain an outstanding Departure From Specification (DFS) file. This file may be maintained on electronic media and will contain the following information:
 - (1) An index that reflects a Deep Submergence System unique identifier.
 - (2) Departure number.
 - (3) Departure title.
 - (4) Classification (Major or Minor).
 - (5) Type of Departure (Deviation or Waiver).
 - (6) Date requested.
 - (7) Date resolved.
 - (8) Approval or disapproval status.
 - (9) Conditional approval comments (if applicable).
 - (10) A copy of all applicable Naval Sea Systems Command correspondence delegating local approval of DFSs.
- b. A copy of each outstanding DFS and all applicable correspondence.
- c. A hard or electronic copy of cleared DFSs with an index will be retained for life of ship.

10.3 USER/SUSTAINING ACTIVITY QUALITY ASSURANCE RECORD RETENTION. User/Sustaining Activities will maintain records in accordance with record retention requirements of this volume Part 1, Chapter 10, Section 10.6 for Submarines, and Section 10.7 for Fleet Maintenance Activities.

10.3.1 Miscellaneous Records.

- a. Completed maintenance records dive log, including where required, pre-dive and post-dive check-off procedures for all evolutions must be retained from certification survey to survey or three years, whichever is longer.
- b. The marked up laminated pre-dive and post-dive sign off sheets which show valve and switch positions shall be retained until commencement of the next dive.
- c. Records of gas supply certifications required by the applicable Scope of Certification Notebook shall be retained for three years.

- d. Record of Temporary Modifications will be maintained per reference (b) and Volume II, Part I, Chapter 2 of this manual.

VOLUME V
PART III
CHAPTER 11
QUALITY ASSURANCE FORMS AND FORM INSTRUCTIONS

11.1 PURPOSE. Provide Quality Assurance (QA) forms for Scope of Certification items. Forms listed in Part 1, Chapter 11 of this volume should be used except for the QA-26 and QA-27 forms. Use the QA-26A and QA-27A forms listed in this chapter for Hydrostatic/Pneumatic Test Records and Drop Test Records respectively, and the QA form 34B listed in this chapter for the assembly of Electrical and Electronic Cable connector assemblies.

11.2 LIST OF FORMS. This chapter provides copies of the following QA forms with instructions on how to complete each form.

- a. Instructions for QA form 2 for existing controlled material received from an outside vendor not under Joint Fleet Maintenance Manual controls.
- b. QA form 26A - Hydrostatic/Pneumatic Test Record for Deep Submergence Systems.
Instructions for QA form 26A
- c. QA form 27A - Drop Test Record for Deep Submergence Systems.
Instructions for QA form 27A
- d. QA form 34B - Electrical/Electronic Cable Connector Assembly and Test Record.
Instructions for QA form 34B

(This Page Intentionally Left Blank)

QA FORM 2 INSTRUCTIONSMATERIAL IDENTIFICATION (ID)/CONTROL TAG

LANTFLT 4790/2 (8-01) S/N 0103-LF-981-0300

PURPOSE: Used for receipt inspection, certification and traceability of existing controlled material received from an outside vendor not under Joint Fleet Maintenance Manual controls.

PROCEDURE: The numbered blocks on QA form 2 correspond with the instructions listed below.

BLOCK 1 - **TAG (A) OF (B)**

- a. Block A - Enter "1". For additional tags used during the fabrication/transfer/installation process, number the tags in sequential order as used (2, 3, 4, etc.).
- b. Block B - The last number reflects the total number of tags used for this item during this maintenance action. This block is filled in by the QAI at the time Block 21 is signed on the last tag (e.g., 3 of 3).

BLOCK 2 - **MIC NO./SERIAL NO.**

NOTE: THE INFORMATION ENTERED FOR FASTENERS MAY NEED TO INCLUDE INFORMATION FROM BLOCKS 3 AND 8 FROM QA-1. DO NOT ENTER THE PNSY TRACE NUMBER FROM BLOCK 3 OF THE QA-1.

- a. New Material: Enter the Material Identification and Control (MIC) etched on the material. If the component has no MIC or a shortened MIC marking, ensure the full MIC marking from the shipping documents, tags, and/or packaging is entered.
- b. Fasteners: Document the markings from the fastener to include either:
 - (1) The color code and the heat/lot number, material type, and manufacturer's symbol (for nuts containing a self-locking insert, the color of the insert is the manufacturer's symbol).
 - (2) The MIC number (when MIC number is on the fastener or on the individual tag for some small fasteners).
- c. If the material is Material Control Division B, enter Markings on the material or documented on the shipping papers providing identification to material type or military specification.

BLOCK 3 - **MAT LEVEL**

Check the Existing block and the SOC block.

BLOCK 4 - **MATL DESCRIPTION**

Enter the quantity, size and noun name of the material (e.g., (6 each) 5/8" - 11 NICU studs, 10" O.D. CUNI barstock 6" long).

BLOCK 5 - **NSN/SMIC**

Enter "NA".

BLOCK 6 - **RECEIPT INSPECTION COMMENTS**

Enter receipt inspection results (i.e., SAT or UNSAT). If inspection results are UNSAT in Block 6, initiate a QA form 3. For UNSAT results in Block 6, the CMPO will only sign Block 7 of the QA form 2 if the QAO dispositions the item suitable for use on Block 12 of the QA form 3. For SAT receipt inspection, enter the following statement:

"Material Receipt Inspected SAT and is certified for re-use."

This entry will be signed by the QAO.

BLOCK 7 - **CMPO/CMH**

CMPO/CMH certifying the entries in Blocks 1-7 print name, enter signature and date.

NOTE 1: THE CMPO WILL VERIFY THAT THE ITEM IS WHAT IS REQUIRED FOR INTENDED USE PRIOR TO TURNING THE MATERIAL OVER TO CRAFTSMAN FOR FABRICATION AND/OR INSTALLATION AND FILL IN BLOCKS 8 THROUGH 12 AT THE TIME THE MATERIAL IS ISSUED.

BLOCK 8 - **UIC, WC, JSN AND CWP SERIAL NO.**

At the time of issue, enter the Job Control Number (JCN) [UIC, WC and Job Sequence Number (JSN)] and CWP serial number.

BLOCK 9 - **WC NO.**

Enter the number of the WC receiving material (e.g., EM01, 10C, 38A).

BLOCK 10 - **DATE**

Enter date the WC received the material.

BLOCK 11 - **REMARKS**

Enter the reason for issue (e.g., issued to 31A for manufacture of fitting, issued to EM01 for installation).

BLOCK 12 - **CRAFTSMAN/CMPO/CMH/QAI**

For Initial Material Issue: Print name, enter signature signifying issue of material by CMPO/CMH. For Fabrication/Transfer (Additional QA form(s) 2 required). Print name, enter signature signifying receipt of material.

NOTE: THE REMAINING SECTIONS OF THE TAG ARE COMPLETED BY THE COGNIZANT CRAFTSMAN/CMPO/CMH/QAI DURING THE FABRICATION/INSTALLATION PROCESSES.

NOTE: SATISFACTORY CONDITION OF MATERIAL EXCHANGED BETWEEN WCs IS ASSUMED, UNLESS AN ENTRY IS MADE IN REMARKS INDICATING MATERIAL IS REJECTED.

BLOCK 13 - **WC NO.**

Enter the number of the WC receiving material (e.g., 56A or EA01).

BLOCK 14 - **DATE**

Enter date material received.

BLOCK 15 - **REMARKS**

Record work performed while the material was in the custody of the WC (e.g., drilled screws and installed Nylock pellets).

BLOCK 16 - **CRAFTSMAN/CMPO/CMH/QAI**

Cognizant craftsman print name and sign to certify the above blocks are complete and correct.

NOTE: IF 2 OR MORE WCs ARE INVOLVED IN THE FABRICATION PROCESS, ADDITIONAL QA FORMS 2 WILL BE FILLED OUT AND NUMBERED IN ACCORDANCE WITH THE INSTRUCTIONS ABOVE FOR BLOCK 1.

NOTE: IF FOR ANY REASON THE COGNIZANT CRAFTSMAN REJECTS THE MATERIAL, HE/SHE WILL COMPLETE AND ATTACH A MATERIAL REJECT TAG (QA FORM 3) AND LEAVE THE QA FORM 2 ATTACHED.

NOTE: BLOCKS 17 THROUGH 21 WILL CONTAIN THE RECORD OF FINAL INSTALLATION. IF ADDITIONAL TAGS ARE REQUIRED FOR THE MATERIAL DURING THE FABRICATION AND TRANSFER PROCESS (MORE THAN TWO WCs/PROCESSES INVOLVED IN THE REPAIR), BLOCKS 9 THROUGH 12 AND BLOCKS 17 THROUGH 21 MAY BE USED.

BLOCK 17 - **WC NO.**

Enter the number of the WC responsible for installation of the material (e.g., 56A or EA01).

BLOCK 18 - DATE

Enter the date of installation.

BLOCK 19 - REMARKS

Enter the location where the material was installed into the system or component (e.g., installed in AHP-514, installed in system at joints ASW-70014(F) and ASW-70015(F), etc.).

BLOCK 20 - CRAFTSMAN

Cognizant craftsman print name and enter signature signifying that the material is the correct material, is installed correctly and in accordance with the applicable technical specifications. Remove the QA form 2 and file with the CWP if a QAI is not required.

NOTE: A QAI INSPECTION IS REQUIRED FOR MATERIAL INSTALLATIONS FOR JOINTS AND ASSEMBLIES WITHIN THE SOC BOUNDARY.

BLOCK 21 - INSPECTOR

When required, inspector print name and enter signature and date certifying that the material is the correct material, acceptable for application and correctly installed. Enter NA in QAI signature space when QAI is not required. Remove the QA form 2 and file with the CWP.

(This Page Intentionally Left Blank)

HYDROSTATIC/PNEUMATIC TEST RECORD FOR DEEP SUBMERGENCE SYSTEMS QA FORM 26A (DSS) <small>Planning shall fill in blocks identified by a ♦ prior to issuing</small>					PAGE 1 OF 2
♦1. DSS PLATFORM	HULL NO.	♦2. JCN	♦3. LWC/SHOP	♦4. CWP/REC SER NO.	♦5. SYSTEM/COMPONENT
♦6. REFERENCES (TEST PRESSURE DRAWINGS, REFERENCE MANUALS OR OTHER APPLICABLE REFERENCES)					
A.		B.		C.	
♦7. REQUIRED TEST AND INSPECTION – SPECIFY TEST REQUIREMENTS [i.e., TYPE OF TEST, ACCEPTANCE CRITERIA, JOINTS TO BE TESTED (IF ENTIRE COMPONENT/SYSTEM IS TESTED, SO STATE)].					
♦8. DIAGRAM OF TEST AREA INCLUDING GAGS AND BLANKS INSTALLED, VALVE POSITIONS, AND TEST GAGES/INSTR USED (DOCUMENT BELOW OR ATTACH SKETCH).					
9. GAGE DATA	RANGE (PSIG)	SERIAL #	CAL DATE	CAL DUE DATE	
PRIMARY					
BACKUP					
♦10. REQUIRED TEST FLUID:		♦11. REQUIRED TEST PRESSURE (PSIG):		12. ACTUAL TEST PRESSURE (PSIG):	
♦13. REQUIRED TEST DURATION:			14. ACTUAL TEST DURATION:		
♦15. ALLOWABLE LEAKAGE:			16. MEASURED LEAKAGE:		
17. INSPECTION RESULTS (CHECK ONE):			<input type="checkbox"/> SAT <input type="checkbox"/> UNSAT		
18. OUT-OF-ROUNDNESS MEASUREMENTS (CHECK ONE): EXTERNAL HYDROSTATIC TEST OF PIPE ONLY			<input type="checkbox"/> SAT <input type="checkbox"/> UNSAT <input type="checkbox"/> NA		
19. REMARKS:					
20. CERTIFICATION					
CERTIFICATION SIGNATURES SHALL BE MADE BY THE CRAFTSMAN WHO PERFORMED THE TEST AND THE QAI WHO WITNESSED THE TEST					
PERFORMED BY			INSPECTED BY		
CRAFTSMAN SIGNATURE	DATE (DATE TEST CONDUCTED)	QA INSPECTOR SIGNATURE	DATE		

QA FORM 26A INSTRUCTIONSHYDROSTATIC/PNEUMATIC TEST RECORD

PURPOSE: To document hydrostatic/pneumatic tests accomplished on Scope of Certification piping systems or portions of a system to recertify the system after maintenance. It also provides a method for the Fleet Maintenance Activity to specify the required retests for work they performed. This form should be utilized to document mechanical joint tightness testing utilizing both an external pressure source and internal system pressure.

PROCEDURE: The numbered blocks on QA form 26A correspond with the instructions listed below. Any block not used will be marked NA. The planning organization shall fill in blocks identified by a ♦ prior to issuing the Controlled Work Package (CWP).

BLOCK 1 - **DSS Platform/Hull Number**

Enter the Deep Submergence System (DSS) or ship's name and hull number.

BLOCK 2 - **JCN**

Enter the Joint Control Number (JCN).

BLOCK 3 - **LWC**

Enter the shop number of the Lead Work Center (LWC).

BLOCK 4 - **CWP SER. NO.**

Enter the CWP serial number.

BLOCK 5 - **SYSTEM/COMPONENT**

Enter the name of the system and component to be tested.

BLOCK 6 - **TEST REFERENCES**

Enter the applicable test reference and/or other applicable references (e.g., drawing number and revision used to obtain the required test pressure and conducting of the test).

NOTE: ENTER "S9505-AF-MMA-010/PIPING SYSTEMS" WHICH PROVIDES REQUIREMENTS FOR SHIP'S FORCE TO SET-UP AND CONDUCT TESTING.

BLOCK 7 - **REQUIRED TEST AND INSPECTION POINTS**

Enter the specific test requirements necessary to recertify the work. Specify test requirements (i.e., type of test, special valve position, duration, acceptance criteria, joints to be tested (if entire component/system is tested, so state)).

BLOCK 8 - **DIAGRAM OF TEST AREA**

Enter a diagram of the test area. Be specific. Include such things as relief valve locations, gage locations, blanks, gags, and valve positions, etc. The Quality Assurance Inspector (QAI) will verify the diagram prior to performance of the test.

NOTE: ALL VALVES WITHIN THE TEST BOUNDARIES MUST BE IDENTIFIED AND THEIR POSITION (OPEN/SHUT) DURING THE TEST ANNOTATED.

NOTE: IF DRAWINGS OR ADDITIONAL INFORMATION IS REQUIRED TO SUPPLEMENT THIS REPORT, EACH DRAWING, ETC., WILL BE NUMBERED AND AUTHENTICATED WITH THE SIGNATURE BY THE CRAFTSMAN AND QAI MAKING UP THE REPORT.

NOTE: LOCAL EXCEPTIONS TO GAGE RANGE AND OR INCREMENTS WILL BE APPROVED BY AN INDIVIDUAL WITH A TECHNICAL WARRANT.

NOTE: SHIPS, FLEET MAINTENANCE ACTIVITIES AND REGIONAL MAINTENANCE CENTERS MANAGED BY UNITED STATES FLEET FORCES COMMAND OR TYCOMS SHALL DISREGARD THE BLOCK 8 DIAMOND WHEN TESTING IS PERFORMED BY AN ACTIVITY OTHER THAN THE ACTIVITY PERFORMING REPAIR. THE ACTIVITY PERFORMING THE TESTING SHALL COMPLETE THE DIAGRAM REQUIRED BY BLOCK 8.

BLOCK 9 - GAGE DATA

Enter the Primary and backup gage data. Backup gage data is not required when performing an operational test as defined in Part I, Chapter 7 of this volume when a second system gage is not available.

BLOCK 10 - REQUIRED TEST FLUID

Enter the required test fluid.

BLOCK 11 - REQ'D TEST PRESSURE (PSIG)

Enter the required test pressure. If listing the value would classify the CWP then the symbols "J" or "H" with the applicable reference may be used instead of classifying the document.

BLOCK 12 - ACTUAL TEST PRESSURE (PSIG)

Enter the actual test pressure. If listing the value would classify the CWP then the symbols "J" or "H" with the applicable reference may be used instead of classifying the document.

BLOCK 13 - REQUIRED TEST DURATION

Enter the required test duration including units.

BLOCK 14 - ACTUAL TEST DURATION

Enter the actual test duration including units.

BLOCK 15 - ALLOWABLE LEAKAGE

Enter the allowable leakage including units for the leakage.

BLOCK 16 - MEASURED LEAKAGE

Enter the actual measured leakage including units for the leakage.

BLOCK 17 - INSPECTION RESULTS

- a. Check "SAT" block, if all inspections specified by Block 7 are complete and satisfactory.
- b. Check "UNSAT" block, if test results are unsatisfactory. Identify the specific inspection and reason for failure in the remarks section.

NOTE: IF A SATISFACTORY TEST CANNOT BE ACHIEVED, A DEPARTURE FROM SPECIFICATION MUST BE PROCESSED IN ACCORDANCE WITH PART 1, CHAPTER 8 OF THIS VOLUME OR THE TASK MUST BE REWORKED AND RETESTED.

BLOCK 18 - OUT-OF-ROUNDNESS MEASUREMENTS

Enter out-of-roundness measurements for external hydrostatic tests of pipes only.

BLOCK 19 - REMARKS

Remarks pertinent to this test will be entered in this block.

BLOCK 20 - CERTIFICATION

PERFORMED BY

Person performing the test print name, enter signature and date signifying accuracy of data recorded.

INSPECTED BY

QAI print name, enter signature and date verifying the accuracy of test results recorded and inspection performed satisfactory.

BLOCK 21 - VALVE/SYSTEM LINEUP FOR PRESSURE TESTING

List all the valves within the test boundary and those valves that make up the test boundary. The required position for adequate testing of the component/system will be listed. Each valve will have the initials of the initial positioner, or in the event the valve is in the correct position and does not require positioning "NA" will be marked. Each valve will have 1st and 2nd checkers initials. Personnel involved with initial positioning, 1st and 2nd checking will print their names, sign, initial and date the required blocks at the bottom of the form.

NOTE: SHIPS, FLEET MAINTENANCE ACTIVITIES AND REGIONAL MAINTENANCE CENTERS MANAGED BY UNITED STATES FLEET FORCES COMMAND OR TYCOMS SHALL DISREGARD THE BLOCK 21 DIAMOND WHEN TESTING IS PERFORMED BY AN ACTIVITY OTHER THAN THE ACTIVITY PERFORMING REPAIR. THE ACTIVITY PERFORMING THE TESTING SHALL COMPLETE THE VALVE LINEUP REQUIRED BY BLOCK 21.

(This Page Intentionally Left Blank)

DROP TEST RECORD FOR DEEP SUBMERGENCE SYSTEMS QA FORM 27A (DSS)					PAGE 1 OF 2
◆1. DSS PLATFORM	HULL NO.	◆2. JCN	◆3. LWC/SHOP	◆4. CWP/REC SER NO.	◆5. SYSTEM/COMPONENT
◆6. REFERENCES (TEST REFERENCE MANUAL(S) AND/OR OTHER APPLICABLE REFERENCES)					
A.	B.	C.			
D.	E.	F.			
◆7. REQUIRED TEST AND INSPECTION – SPECIFY TEST REQUIREMENTS [i.e., TYPE OF TEST, JOINTS TO BE TESTED (IF ENTIRE COMPONENT/SYSTEM IS TESTED, SO STATE)].					
◆8. DIAGRAM OF TEST AREA INCLUDING GAGS AND BLANKS INSTALLED, VALVE POSITIONS, AND TEST GAGES/INSTR USED (DOCUMENT BELOW OR ATTACH SKETCH).					
9. GAGE DATA	RANGE (PSIG)	SERIAL #	CAL DATE	CAL DUE DATE	
PRIMARY					
BACKUP					
◆10. REQUIRED TEST FLUID:					
◆11. REQUIRED TEST PRESSURE:		12. INITIAL TEST PRESSURE:		13. FINAL PRESSURE AT END OF TEST:	
14. TEMPERATURE AT START OF TEST:		15. TEMPERATURE AT END OF TEST:		16. CHANGE IN TEMPERATURE:	
◆17. REQUIRED TEST DURATION:			18. ACTUAL TEST DURATION:		
◆19. ALLOWABLE PRESSURE DROP% IN MINUTES/HOURS:			20. FINAL PRESSURE DROP CORRECTED FOR TEMPERATURE CHANGE:		
21. TEST RESULTS (CHECK ONE): <input type="checkbox"/> SAT <input type="checkbox"/> UNSAT					
22. REMARKS:					
23. CERTIFICATION					
CERTIFICATION SIGNATURES SHALL BE MADE BY THE CRAFTSMAN WHO PERFORMED THE TEST AND THE QAI WHO WITNESSED THE TEST					
PERFORMED BY:			INSPECTED BY:		
CRAFTSMAN SIGNATURE	DATE	QA INSPECTOR SIGNATURE	DATE		

QA FORM 27A INSTRUCTIONSDROP TEST RECORD

NOTE: PLANNING SHALL FILL IN BLOCKS IDENTIFIED BY A ♦ PRIOR TO ISSUING.

PURPOSE: To document drop tests accomplished on Scope of Certification piping systems or portions of a system to recertify the system after maintenance actions have been accomplished.

PROCEDURE: The numbered blocks on QA form 27A correspond with the instructions listed below. Any block not used will be marked NA. The planning organization shall fill in blocks identified by a ♦ prior to issuing the CWP.

BLOCK 1 - DSS Platform/Hull Number

Planner enter the DSS or ship's name and hull number.

BLOCK 2 - JCN

Planner enter the JCN.

BLOCK 3 - LWC

Planner enter the shop number of the LWC.

BLOCK 4 - CWP SER. NO.

Planner enter the CWP serial number.

BLOCK 5 - SYSTEM/COMPONENT

Planner enter the name of the system and component to be tested.

BLOCK 6 - TEST REFERENCES

Planner enter the applicable test reference and/or other applicable references (e.g., drawing number and revision used to obtain the required test pressure and conducting of the test).

NOTE: ENTER "S9505-AF-MMA-010/PIPING SYSTEMS" WHICH PROVIDES REQUIREMENTS FOR SHIP'S FORCE TO SET-UP AND CONDUCT TESTING.

BLOCK 7 - REQUIRED TEST AND INSPECTION POINTS

Planner enter the specific test requirements necessary to recertify the work. Specify test requirements (i.e., type of test, special valve position, duration, acceptance criteria, and joints to be tested (if entire component/system is tested, so state)).

BLOCK 8 - DIAGRAM OF TEST AREA

Planner enter a diagram of the test area. Be specific. Include such things as relief valve locations, gage locations, blanks, gags, and valve positions, etc. The QAI will verify the diagram prior to performance of the test. For nuclear tests identify major components to be isolated or vented to preclude unnecessary pressurization.

NOTE: ALL VALVES WITHIN THE TEST BOUNDARIES MUST BE IDENTIFIED AND THEIR POSITION (OPEN/SHUT) DURING THE TEST ANNOTATED.

NOTE: IF DRAWINGS OR ADDITIONAL INFORMATION IS REQUIRED TO SUPPLEMENT THIS REPORT, EACH DRAWING, ETC., WILL BE NUMBERED AND AUTHENTICATED WITH THE SIGNATURE BY THE CRAFTSMAN AND QAI MAKING UP THE REPORT.

NOTE: LOCAL EXCEPTIONS TO GAGE RANGE AND OR INCREMENTS WILL BE APPROVED BY AN INDIVIDUAL WITH A TECHNICAL WARRANT.

NOTE: SHIPS, FLEET MAINTENANCE ACTIVITIES AND REGIONAL MAINTENANCE CENTERS MANAGED BY UNITED STATES FLEET FORCES COMMAND OR TYCOMS SHALL DISREGARD THE BLOCK 8 DIAMOND WHEN TESTING IS PERFORMED BY AN ACTIVITY OTHER THAN THE ACTIVITY PERFORMING REPAIR. THE ACTIVITY PERFORMING THE TESTING SHALL COMPLETE THE DIAGRAM REQUIRED BY BLOCK 8.

BLOCK 9 - GAGE DATA

Craftsman enter the Primary and backup gage data. Backup gage data is not required when performing an operational test as defined in Part I, Chapter 7 of this volume when a second system gage is not available.

BLOCK 10 - REQUIRED TEST FLUID

Planner enter the required test fluid.

BLOCK 11 - REQ'D TEST PRESSURE (PSIG)

Planner enter the required test pressure. If listing the value would classify the CWP then the symbols "J" or "H" with the applicable reference may be used instead of classifying the document.

BLOCK 12 - INITIAL TEST PRESSURE

Craftsman enter initial test pressure achieved at start of test.

BLOCK 13 - FINAL PRESSURE AT END OF TEST

Craftsman enter final pressure reading when the required test time is completed.

BLOCK 14 - TEMPERATURE AT START OF TEST

Craftsman enter temperature at start of the test with units.

BLOCK 15 - TEMPERATURE AT END OF TEST

Craftsman enter temperature at the end of the test with units.

BLOCK 16 - CHANGE IN TEMPERATURE

Craftsman subtract temperature at the end of the test recorded in Block 15 from temperature at the start of the test recorded in Block 14.

BLOCK 17 - REQUIRED TEST DURATION

Planner enter the required test duration including units.

BLOCK 18 - ACTUAL TEST DURATION

Craftsman record actual duration of the test.

BLOCK 19 - ALLOWABLE PRESSURE DROP % IN MINUTES/HOURS

Planner enter the allowable pressure drop as a percentage of the test pressure in minutes or hours. Cross-out time measure not used.

BLOCK 20 - FINAL PRESSURE DROP CORRECTED FOR TEMPERATURE CHANGE

Craftsman record final pressure drop calculated with corrections for temperature change in the same units as Blocks 11 and 12.

BLOCK 21 - TEST RESULTS

Craftsman

- a. Check "SAT" block if all inspections specified by Block 7 are complete and satisfactory.
- b. Check "UNSAT" block, if test results are unsatisfactory. Identify the specific inspection and reason for failure in the remarks section.

NOTE: IF A SATISFACTORY TEST CANNOT BE ACHIEVED, A DEPARTURE FROM SPECIFICATION MUST BE PROCESSED IN ACCORDANCE WITH PART 1, CHAPTER 8, OF THIS VOLUME OR THE TASK MUST BE REWORKED AND RETESTED.

BLOCK 22 - REMARKS

Remarks pertinent to this test will be entered in this block.

BLOCK 23 - CERTIFICATION

PERFORMED BY

Craftsman performing the test print name, enter signature and date signifying accuracy of data recorded.

INSPECTED BY

QAI print name, enter signature and date verifying the accuracy of test results recorded and inspection performed satisfactory.

NOTE: SHIPS, FLEET MAINTENANCE ACTIVITIES AND REGIONAL MAINTENANCE CENTERS MANAGED BY UNITED STATES FLEET FORCES COMMAND OR TYCOMS SHALL DISREGARD THE BLOCK 24 DIAMOND WHEN TESTING IS PERFORMED BY AN ACTIVITY OTHER THAN THE ACTIVITY PERFORMING REPAIR. THE ACTIVITY PERFORMING THE TESTING SHALL COMPLETE THE VALVE LINEUP REQUIRED BY BLOCK 24.

BLOCK 24 - VALVE/SYSTEM LINEUP FOR PRESSURE TESTING

List all the valves within the test boundary and those valves that make up the test boundary. The required position for adequate testing of the component/system will be listed. Each valve will have the initials of the initial positioner, or in the event the valve is in the correct position and does not require positioning "NA" will be marked. Each valve will have 1st and 2nd checkers initials. Personnel involved with initial positioning, 1st and 2nd checking will print their names, sign, initial and date the required blocks at the bottom of the form.

(This Page Intentionally Left Blank)

**ELECTRICAL/ELECTRONIC CABLE CONNECTOR
ASSEMBLY AND TEST RECORD**

QA FORM 34B
(DSS)

PAGE 1 OF 1

A separate QA Form 34B must be used for each connector requiring controlled assembly documentation. The QA Form 34B shall be used to provide: 1) Stand alone documentation for cable connector reconnection when controlled assembly is required by authorized REC exception; or 2) QA Form 34B will be included in CWP/REC packages when documentation of controlled assembly is required as OQE for the work performed.
Planning shall fill in blocks identified by a ♦ prior to issuing.

♦1. DSS PLATFORM HULL NO.	♦2. JCN	♦3. LWC/SHOP	♦4. CWP/REC SER NO.	♦5. SYSTEM(S) COMPONENT
♦6. CONNECTOR DESIGNATION		♦7. CABLE DESIGNATION		♦8. CONNECTOR SIZE

♦9. REFERENCES

10. NEW MATERIAL

PC NO.	REF.	DESCRIPTION	QTY	LOE	IDENT (e.g., MIC NO/NSN/TRACEABILITY NO)	R/I

11. INSPECTION

PINS		SEALING SURFACES ♦ [] NOT APPLICABLE			THREADS ♦ [] NOT APPLICABLE		
PLUG SAT _____ UNSAT _____	JACK SAT _____ UNSAT _____	PLUG SAT _____ UNSAT _____	JACK SAT _____ UNSAT _____	VENT SCREW SAT _____ UNSAT _____	PLUG SAT _____ UNSAT _____	JACK SAT _____ UNSAT _____	VENT SCREW SAT _____ UNSAT _____

12. TORQUE DOCUMENTATION ♦ [] TORQUE DOCUMENTATION NOT REQUIRED

VENT SCREW ♦ [] NOT APPLICABLE	♦REQUIRED TORQUE	FINAL TORQUE	TORQUE DEVICE/INSTRUMENT USED		
	<input type="checkbox"/> IN-LB <input type="checkbox"/> FT-LB	<input type="checkbox"/> IN-LB <input type="checkbox"/> FT-LB	RANGE	SERIAL NUMBER	CAL DUE DATE
COUPLING RING	♦REQUIRED TORQUE	FINAL TORQUE	TORQUE DEVICE/INSTRUMENT USED		
	<input type="checkbox"/> IN-LB <input type="checkbox"/> FT-LB	<input type="checkbox"/> IN-LB <input type="checkbox"/> FT-LB	RANGE	SERIAL NUMBER	CAL DUE DATE

CRAFTSMAN SIGNATURE	DATE	QAI SIGNATURE	DATE

13. LOCKWIRE/LOCKING CABLE INSTALLATION	MATL. DESCRIPTION/NSN/PC NO.	CRAFTSMAN SIGNATURE	DATE
SAT _____ ♦NA _____			

14. REMARKS/RECORD OF REPAIRS, MODIFICATIONS, INSPECTIONS (e.g., LIST OF ASSOCIATED RECORDS)

15. RECORD HAS BEEN REVIEWED FOR COMPLETENESS	QAS SIGNATURE	DATE

(This Page Intentionally Left Blank)

QA FORM 34B INSTRUCTIONSELECTRICAL/ELECTRONIC CABLE CONNECTOR ASSEMBLY AND TEST RECORD

NOTE: **PLANNING SHALL FILL IN BLOCKS IDENTIFIED BY A ♦ PRIOR TO ISSUING.**

PURPOSE: To provide a standard form to document the assembly and test of Scope of Certification electrical and electronic cable connector assemblies.

PROCEDURE: The numbered blocks on QA form 34B correspond with instructions listed below. Any block not used will be marked N/A. The planning organization shall fill in blocks identified by a * prior to issuing the CWP.

BLOCK 1 - DSS PLATFORM/HULL NO.

Planner enter the DSS or ship's name and hull number.

BLOCK 2 - JCN

Planner enter the JCN.

BLOCK 3 - LWC

Planner enter the LWC.

BLOCK 4 - CWP/REC SER. NO.

Planner enter the CWP serial number.

BLOCK 5 - SYSTEM(S)/COMPONENT

Planner enter the noun name of the system(s) and component (if applicable).

BLOCK 6 - CONNECTOR DESIGNATION

Planner enter the designation of the connector as listed on prints or other reference material.

BLOCK 7 - CABLE DESIGNATION

Planner enter the designation of the cables entering the connector as listed on prints or other reference material.

BLOCK 8 - CONNECTOR SIZE

Planner enter the **type and size of the male** connector (ex. M24231/13-001, where the M24231 is the standard for the type of receptacle and the 13-001 is the size and number of contacts from the standard).

BLOCK 9 - REFERENCES

Planner enter all references used to identify component parts, joint, material, and assembly information. Include revision letter and, if applicable, the assembly number (e.g., Assy D, Assy RA, etc.). Revisions for technical manuals are not required. If joint numbers are assigned in a sketch in a Work Procedure, include the Work Procedure sketch number. For Electrical Hull Fittings, include both the assembly drawing and electrical hole assignment drawing.

BLOCK 10 - **NEW** MATERIAL

Craftsman

PC NO: Enter piece numbers of parts. List only the new replacement parts actually being installed.

REF: Record the reference letter of the drawing or document listed in Block 9 which provides the material specification or assembly information for the piece listed in the "PC NO." block.

DESCRIPTION: Describe all new parts associated with the assembly or joint. For O-rings: record the MIL SPEC and the size. Enter the stock number of the O-ring lubricant or any sealant used during assembly.

QTY: Record quantity of new material installed.

LOE: Identify the Level of Essentiality (MIC Level). Example: L1, NA. For SOC material, enter the appropriate Material Control Division (A, B or C).

IDENT: Record the National Stock Number or traceability number of the new materials that were used.

R/I (Receipt Inspection): Enter receipt inspection results from the QA form 2 (SAT). For non-controlled material enter "N/A". For SOC MCD C material, the craftsman will perform a receipt inspection per Part III Chapter 6 of this volume and document the inspection results in the R/I column of Block 10.

BLOCK 11 - INSPECTION

PINS: Craftsman record "SAT" or "UNSAT" for the plug and jack inspection using requirements of the references listed in Block 9.

SEALING SURFACE: Craftsman record "SAT" or "UNSAT" for the sealing surface inspection using requirements of the references listed in Block 9.

Planning. If the sealing surface is not required to be checked, mark the "NOT APPLICABLE" block.

THREADS: Craftsman record "SAT" or "UNSAT" for the fastening thread inspection using requirements of the references listed in Block 9.

Planning. If the thread inspection is not required to be checked, mark the "NOT APPLICABLE" block.

REMARKS: Enter any pertinent remarks or additional information related to the inspection of the pins, thread or sealing surfaces in Block 14. Each entry shall contain a signature and date except where the entry is pre-printed on the form by planning.

BLOCK 12 - TORQUE DOCUMENTATION

Not all electrical/electronic cable connectors require torque documentation. For those joints not requiring torque documentation, the Planner will mark the "NOT APPLICABLE" block. The craftsman will still sign indicating that the joint was assembled in accordance with specification and the correct O-ring was used.

For those electrical/electronic cable connectors which require torque documentation:

REQUIRED TORQUE: The Planner will list the required torque for the vent screw and coupling ring as applicable in accordance with the requirements of the reference(s) listed in Block 9.

FINAL TORQUE: The craftsman will record the final torque applied to the vent screw and/or coupling ring.

TORQUE DEVICE DATA: Craftsman record range, serial number and calibration due date for the torque wrench or other device used during the assembly of the connector.

CRAFTSMAN(S) AND QAI CERTIFICATION BLOCK FOR JOINT DATA: Craftsman(s) and QAI shall sign, record badge number and date of the signature after the satisfactory completion of assembly in accordance with the requirements. This signature provides certification that the joint meets the requirements for the following:

- (1) The applied lubricant is acceptable per the technical direction.
- (2) The final required pre-load torque has been applied in accordance with specified requirements.
- (3) Sealing surfaces meet the acceptance criteria of the applicable Maintenance Standard.

QAI CERTIFICATION BLOCK FOR JOINT DATA: QAI shall sign and date the signature after the satisfactory completion of assembly in accordance with the requirements. This signature provides certification that the joint meets the requirements for the following:

- (1) The applied lubricant is acceptable per the technical direction.
- (2) The final required pre-load torque has been applied in accordance with specified requirements.
- (3) Sealing surfaces meet the acceptance criteria of the applicable Maintenance Standard.

BLOCK 13 - LOCKWIRE/LOCKING CABLE/DEVICE INSTALLATION

NOTE: THIS BLOCK APPLIES TO LOCKING DEVICES OTHER THAN SELF-LOCKING NUTS, SELF-LOCKING INSERTS OR SELF-LOCKING BOLT/CAP SCREWS.

Planner enter an X in the "NOT APPLICABLE" box when not applicable. When an action is required to engage the locking device, enter a description of the required action.

NOTE: FOR MCD-C LOCKWIRE/LOCKING CABLE/DEVICE, THE QAI WILL UTILIZE SPACE IN BLOCK 14 TO DOCUMENT COMPLETION OF INSPECTION OF MCD-C MATERIAL DURING INSTALLATION.

Craftsman sign, date and check SAT when lockwire, locking cable or required locking device (e.g., locking ring for EHF's, barrel nut locking device, etc.) has been properly installed or the required action has been accomplished. Enter description (e.g., lockwire, locking cable, locktab) and ident (e.g., stock number, MIL-SPEC or piece number) of the lockwire/locking cable/locking device. Enter description and "Existing" for existing locking devices. If more than one locking device type (e.g., lockwire and locktab washers) exists on the assembly, record additional information in the Remarks block. When the installation of more than one of the same type of locking device is being documented in Block 13 (e.g., 2 locking devices), record the quantity in addition to the description (Block 14 may be used if additional space is needed). Recording the quantity is not required for lockwire/locking cable, nor when the locking device quantity is documented in Block 10.

QAI sign, print and date in Block 14 for new MCD-C material installed by craftsman in Block 13, to ensure material conforms to specified requirements.

BLOCK 14 - REMARKS/RECORD OF REPAIRS/MODIFICATIONS/INSPECTIONS

Enter any pertinent remarks or additional information related to the repair/assembly of the component. Each entry shall contain a signature and date except where the entry is pre-printed on the form by planning.

BLOCK 15 - RECORD HAS BEEN REVIEWED FOR COMPLETENESS

Quality Assurance Supervisor or Quality Assurance Officer will print name, enter signature and date for final review, signifying the accuracy of the completed form. If any entry is UNSAT, the Quality Assurance Officer will initiate action to resolve the unsat condition and indicate the action taken in the remarks block. Do not sign unless a satisfactory repair is completed or the UNSAT condition is accepted.

(This Page Intentionally Left Blank)

JOINT FLEET MAINTENANCE MANUAL
VOLUME VI
MAINTENANCE PROGRAMS
LIST OF EFFECTIVE PAGES

Page Numbers	Change in Effect	Page Numbers	Change in Effect
i thru vi	Change 5	VI-2-7	Change 5
vii thru viii	Change 2	VI-2-8 thru VI-2-10	Change 3
ix thru x	Change 3	VI-2A-1 thru VI-2A-2	Change 3
xi	Change 4	VI-2A-3 thru VI-2A-4	REV C
xii	Change 5	VI-2B-1 thru VI-2B-2	Change 4
xiii thru xvi	Change 2	VI-2C-1	REV C
xvii	Change 5	VI-2C-2	Change 2
xviii thru xx	Change 2	VI-3-1 thru VI-3-4	Change 2
xxi	Change 4	VI-3-5 thru VI-3-7	Change 5
xxii thru xxvii	Change 2	VI-3-8	Change 2
xxviii thru xxxii	Change 5	VI-3A-1 thru VI-3A-2	Change 2
VI-FWD-1 thru VI-FWD-2	REV C	VI-3B-1 thru VI-3B-2	Change 2
VI-FWD-A-1 thru VI-FWD-A-2	Change 2	VI-3C-1	Change 5
VI-FWD-A-3	Change 5	VI-3C-2	Change 2
VI-FWD-A-4	Change 2	VI-3D-1 thru VI-3D-2	Change 2
VI-FWD-A-5	Change 4	VI-3E-1 thru VI-3E-4	Change 2
VI-FWD-A-6 thru VI-FWD-A-9	Change 3	VI-3F-1 thru VI-3F-2	Change 2
VI-FWD-A-10	Change 1	VI-3G-1 thru VI-3G-2	Change 2
VI-1-1	Change 1	VI-4-1	Change 2
VI-1-2	REV C	VI-4-2 thru VI-4-6	REV C
VI-2-1	Change 3	VI-5-1 thru VI-5-11	REV C
VI-2-2 thru VI-2-3	Change 4	VI-5-12	Change 2
VI-2-4	Change 3	VI-5-13 thru VI-5-14	REV C
VI-2-5	Change 4	VI-5A-1 thru VI-5A-8	REV C
VI-2-6	Change 3	VI-6-1	Change 1

Page Numbers	Change in Effect	Page Numbers	Change in Effect
VI-6-2 thru VI-6-4	REV C	VI-13A-1 thru VI-13A-14	REV C
VI-6A-1 thru VI-6A-6	REV C	VI-14-1 thru VI-14-2	Change 2
VI-7-1 thru VI-7-34	REV C	VI-14-3 thru VI-14-4	REV C
VI-7A-1 thru VI-7A-4	REV C	VI-14A-1 thru VI-14A-2	Change 2
VI-7B-1 thru VI-7B-2	REV C	VI-15-1 thru VI-15-2	REV C
VI-7C-1 thru VI-7C-2	REV C	VI-16-1 thru VI-16-3	REV C
VI-8-1	REV C	VI-16-4 thru VI-16-5	Change 1
VI-8-2	Change 2	VI-16-6 thru VI-16-8	REV C
VI-8-3	Change 3	VI-16A-1 thru VI-16A-2	REV C
VI-8-4	Change 2	VI-16B-1 thru VI-16B-2	REV C
VI-8-5	REV C	VI-16C-1	Change 1
VI-8-6	Change 2	VI-16C-2	REV C
VI-8A-1 thru VI-8A-2	REV C	VI-17-1 thru VI-17-2	REV C
VI-8B-1 thru VI-8B-2	REV C	VI-18-1	REV C
VI-8C-1 thru VI-8C-2	REV C	VI-18-2	Change 3
VI-8D-1 thru VI-8D-2	REV C	VI-18-3 thru VI-18-4	REV C
VI-8E-1 thru VI-8E-2	REV C	VI-19-1 thru VI-19-2	Change 2
VI-8F-1 thru VI-8F-2	REV C	VI-19-3 thru VI-19-8	Change 3
VI-8G-1 thru VI-8G-2	REV C	VI-19-9 thru VI-19-12	Change 4
VI-9-1 thru VI-9-17	Change 5	VI-19A-1 thru VI-19A-12	REV C
VI-9-18	Change 2	VI-19A-13	Change 2
VI-10-1 thru VI-10-4	REV C	VI-19A-14 thru VI-19A-29	REV C
VI-11-1 thru VI-11-6	REV C	VI-19A-30	Change 1
VI-12-1	Change 1	VI-19A-31 thru VI-19A-40	REV C
VI-12-2 thru VI-12-4	REV C	VI-19B-1 thru VI-19B-2	REV C
VI-13-1	Change 3	VI-19C-1	Change 2
VI-13-2	REV C	VI-19C-2	REV C
VI-13-3	Change 5	VI-19C-3 thru VI-19C-9	Change 2
VI-13-4	REV C	VI-19C-10	Change 4

Page Numbers	Change in Effect	Page Numbers	Change in Effect
VI-19C-11	Change 2	VI-22-1 thru VI-22-2	REV C
VI-19C-12	REV C	VI-22-3	Change 2
VI-19C-13 thru IV-19C-19	Change 2	VI-22-4	REV C
VI-19C-20	Change 4	VI-22A-1 thru VI-22A-2	REV C
VI-19C-21 thru VI-19C-50	Change 2	VI-23-1	Change 1
VI-19C-51	Change 5	VI-23-2	REV C
VI-19C-52 thru VI-19C-68	Change 2	VI-23-3	Change 1
VI-19C-69	Change 4	VI-23-4	REV C
VI-19C-70 thru VI-19C-81	Change 2	VI-23-5	Change 1
VI-19C-82	Change 3	VI-23-6	REV C
VI-19C-83 thru VI-19C-88	Change 2	VI-23A-1 thru VI-23A-2	REV C
VI-19D-1 thru VI-19D-2	REV C	VI-23B-1 thru VI-23B-2	REV C
VI-19E-1	Change 5	VI-23C-1 thru VI-23C-10	REV C
VI-19E-2	REV C	VI-23C-11	Change 1
VI-19F-1 thru VI-19F-2	REV C	VI-23C-12	REV C
VI-20-1 thru VI-20-4	REV C	VI-23C-13	Change 2
VI-20A-1 thru VI-20A-2	REV C	VI-23C-14 thru VI-23C-18	REV C
VI-20B-1 thru VI-20B-2	REV C	VI-23C-19	Change 3
VI-20C-1 thru VI-20C-2	REV C	VI-23C-20	REV C
VI-21-1 thru VI-21-2	REV C	VI-23C-21	Change 3
VI-21-3	Change 4	VI-23C-22 thru VI-23C-30	REV C
VI-21-4	REV C	VI-23D-1 thru VI-23D-2	REV C
VI-21A-1 thru VI-21A-2	REV C	VI-23E-1	REV C
VI-21B-1 thru VI-21B-2	REV C	VI-23E-2	Change 3
VI-21C-1 thru VI-21C-2	REV C	VI-23E-3 thru VI-23E-4	REV C
VI-21D-1 thru VI-21D-2	REV C	VI-23F-1 thru VI-23F-2	REV C
VI-21E-1 thru VI-21E-6	REV C	VI-24-1	Change 2
VI-21F-1 thru VI-21F-4	REV C	VI-24-2	Change 1
VI-21G-1 thru VI-21G-6	REV C	VI-24-3	Change 2

Page Numbers	Change in Effect	Page Numbers	Change in Effect
VI-24-4 thru VI-24-5	Change 1	VI-27A-1 thru VI-27A-2	REV C
VI-24-6	Change 5	VI-27B-1 thru VI-27B-2	REV C
VI-24-7	Change 1	VI-27C-1 thru VI-27C-2	REV C
VI-24-8 thru VI-24-9	Change 2	VI-28-1 thru VI-28-4	REV C
VI-24-10	Change 1	VI-28A-1 thru VI-28A-2	REV C
VI-24A-1	Change 1	VI-29-1 thru VI-29-2	REV C
VI-24A-2	REV C	VI-29A-1 thru VI-29A-2	REV C
VI-24B-1	Change 1	VI-30-1 thru VI-30-2	REV C
VI-24B-2	REV C	VI-31-1	REV C
VI-24C-1 thru VI-24C-2	Change 1	VI-31-2 thru VI-31-3	Change 3
VI-24D-1 thru VI-24D-2	REV C	VI-31-4	REV C
VI-24E-1 thru VI-24E-2	Change 1	VI-31-5	Change 5
VI-24F-1 thru VI-24F-2	REV C	VI-31-6 thru VI-31-7	Change 3
VI-25-1	Change 1	VI-31-8 thru VI-31-10	Change 2
VI-25-2	Change 4	VI-31A-1	Change 3
VI-25-3 thru VI-25-4	Change 1	VI-31A-2	REV C
VI-25-5 thru VI-25-9	Change 4	VI-31A-3	Change 2
VI-25-10	Change 2	VI-31A-4	Change 3
VI-25A-1	Change 1	VI-31A-5 thru VI-31A-8	REV C
VI-25A-2	REV C	VI-32-1	REV C
VI-25B-1	Change 1	VI-32-2	Change 1
VI-25B-2	REV C	VI-32-3 thru VI-32-16	REV C
VI-25C-1 thru VI-25C-2	REV C	VI-32A-1 thru VI-32A-2	REV C
VI-25D-1 thru VI-25D-2	REV C	VI-33-1	Change 1
VI-25E-1 thru VI-25E-2	REV C	VI-33-2 thru VI-33-3	REV C
VI-25F-1 thru VI-25F-2	REV C	VI-33-4	Change 1
VI-26-1 thru VI-26-2	REV C	VI-33-5	Change 2
VI-27-1	Change 1	VI-33-6	Change 1
VI-27-2 thru VI-27-4	REV C	VI-33A-1 thru VI-33A-5	REV C

Page Numbers	Change in Effect	Page Numbers	Change in Effect
VI-33A-6 thru VI-33A-7	Change 3	VI-39A-1 thru VI-39A-2	Change 2
VI-33A-8 thru VI-33A-12	REV C	VI-40-1	Change 4
VI-34-1 For Future Use	Change 5	VI-40-2	Change 5
VI-35-1 thru VI-35-4	Change 2	VI-40-3	REV C
VI-35A-1 thru VI-35A-2	Change 2	VI-40-4	Change 3
VI-36-1 thru VI-36-3	Change 2	VI-40A-1	Change 5
VI-36-4 thru VI-36-5	REV C	VI-40A-2	Rev C
VI-36-6	Change 2	VI-40B-1	Change 5
VI-36-7 thru VI-36-8	REV C	VI-40B-2	Rev C
VI-36-9	Change 1	VI-40C-1	Change 5
VI-36-10 thru VI-36-12	REV C	VI-40C-2	Rev C
VI-36A-1 thru VI-36A-4	REV C	VI-40D-1 thru VI-40D-2	REV C
VI-36B-1 thru VI-36B-22	REV C	VI-40E-1 thru VI-40E-2	REV C
VI-36C-1 thru VI-36C-6	REV C	VI-41-1	Change 1
VI-36D-1 thru VI-36D-4	REV C	VI-41-2 thru VI-41-3	Change 2
VI-36E-1 thru VI-36E-4	REV C	VI-41-4	Change 3
VI-36F-1 thru VI-36F-4	REV C	VI-41-5	Change 2
VI-37-1 thru VI-37-2	REV C	VI-41-6	Change 3
VI-37-3	Change 2	VI-41-7	Change 2
VI-37-4	Change 1	VI-41-8	Change 4
VI-37-5	Change 3	VI-41-9	Change 3
VI-37-6	REV C	VI-41-10 thru VI-41-12	Change 2
VI-38-1 thru VI-38-2	Change 1	VI-41-13	Change 3
VI-38-3 thru VI-38-8	REV C	VI-41-14	Change 2
VI-38A-1 thru VI-38A-8	REV C	VI-41-15	Change 4
VI-38B-1 thru VI-38B-2	REV C	VI-41-16	Change 2
VI-38C-1 thru VI-38C-2	REV C	VI-41-17 thru VI-41-18	Change 4
VI-39-1 thru VI-39-3	Change 3	VI-41-19 thru VI-41-23	Change 2
VI-39-4 thru VI-39-6	Change 2	VI-41-24	Change 5

Page Numbers	Change in Effect	Page Numbers	Change in Effect
VI-42-1	Change 3		
VI-42-2	Change 2		
VI-42-3	Change 5		
VI-42-4 thru VI-42-8	Change 3		
VI-42A-1 thru VI-42A-4	REV C		
VI-42B-1 thru VI-42B-2	REV C		
VI-42C-1 thru VI-42C-2	REV C		
VI-42D-1 thru VI-42D-2	REV C		
VI-42E-1 thru VI-42E-2	REV C		
VI-43-1	Change 1		
VI-43-2	REV C		
VI-44-1 thru VI-44-2	Change 2		

JOINT FLEET MAINTENANCE MANUAL
VOLUME VI
MAINTENANCE PROGRAMS
RECORD OF CHANGES

CHANGE NO.	DATE	TITLE OR BRIEF DESCRIPTION	ENTERED BY (INITIALS)

(This Page Intentionally Left Blank)

JOINT FLEET MAINTENANCE MANUAL CHANGE REQUEST FORM
<p>FROM: ACTIVITY/SHIP _____ E-MAIL ADDRESS _____ CODE/DEPT/SHOP _____ DATE _____ ORIGINATOR _____ TEL EXT () _____</p>
<p>VOL-PART-PARA NO. _____ FIGURE _____ TABLE _____ PROCESSING NORMAL _____ URGENT* _____ * (Justify in rationale below if urgent is marked and transmit via e-mail as "High Importance") PROBLEM DESCRIPTION:</p>
<p>RECOMMENDED CHANGE: (Include any proposed text addition/deletion)</p>
<p>RATIONALE:</p>

E-mail to PTNH.SUBMEPP.JFMMMGR@Navy.Mil

(If mailing, fold on dotted line on reverse side and mail to Submarine Maintenance Engineering, Planning and Procurement (SUBMEPP) Activity or send facsimile to (207) 438-6210.)

FOLD

Commanding Officer

OFFICIAL BUSINESS

Commanding Officer
Submarine Maintenance Engineering,
Planning and Procurement (SUBMEPP) Activity
Attn: Code 1832JM
P.O. Box 2500
Portsmouth Naval Shipyard
Portsmouth, NH 03804-2500

FOLD

JOINT FLEET MAINTENANCE MANUAL
VOLUME VI
MAINTENANCE PROGRAMS
TABLE OF CONTENTS

	Page No.
LIST OF EFFECTIVE PAGES	i
RECORD OF CHANGES	vii
JOINT FLEET MAINTENANCE MANUAL CHANGE REQUEST FORM.....	ix
FOREWORD - INTRODUCTION	
1.1 Purpose	VI-FWD-1
1.2 Scope	VI-FWD-1
1.3 Changes and Corrections	VI-FWD-2
1.4 Request for Copies of the Manual	VI-FWD-2
Appendices	
A List of Acronyms	VI-FWD-A-1
CHAPTER 1 - WATERBORNE UNDERWATER HULL CLEANING	
1.1 Purpose	VI-1-1
1.2 Scope	VI-1-1
1.3 Policy	VI-1-1
1.4 Responsibilities	VI-1-1
1.5 Reports.....	VI-1-1
CHAPTER 2 - FLEET TECHNICAL ASSISTANCE	
2.1 Purpose	VI-2-1
2.2 Fleet Technical Assistance Definition	VI-2-1
2.3 Fleet Technical Assistance Exclusion Areas	VI-2-1
2.4 Fleet Technical Assistance Policy	VI-2-2
2.4.1 Requesting Assistance	VI-2-2
2.4.2 Required Fleet Technical Assistance Request Information	VI-2-2
2.4.3 Chief of Naval Operations Availability Fleet Technical Assistance Procedures	VI-2-3
2.4.4 Initial Response	VI-2-3
2.4.5 On-Sight Support	VI-2-3
2.5 Completion	VI-2-3
2.5.1 Fleet Technical Assistance Completion.....	VI-2-3
2.5.2 Transition to Repair	VI-2-3
2.6 Responsibilities	VI-2-3
2.6.1 Ship’s Commanding Officer.....	VI-2-3
2.6.2 Regional Maintenance Center Commanders.....	VI-2-4
2.6.3 Other Source of Support Providers	VI-2-5
2.6.4 Navy 311 Fleet Technical Assistance Request Processing Procedure.....	VI-2-5
2.7 Regional Maintenance Centers	VI-2-5

2.7.1	Regional Maintenance Centers	VI-2-5
2.7.2	Area Regional Maintenance Center Area of Responsibility Assignments.....	VI-2-5
2.7.3	Considerations for Providing Assistance	VI-2-8
2.7.3.1	Distance Support	VI-2-8
2.7.3.2	On-Site Support.....	VI-2-8
2.7.3.3	Fleet Technical Assistance Support Transfer and Acceptance.....	VI-2-8
2.7.3.4	Transferring Regional Maintenance Center	VI-2-8
2.7.3.5	Accepting Source of Support	VI-2-8
2.7.3.6	Support Coordination	VI-2-8
2.7.4	Funding.....	VI-2-8
2.7.4.1	On-Site Support.....	VI-2-9
2.8	Post-Fleet Technical Assistance Administrative Requirements.....	VI-2-10
Appendices		
A	Area Regional Maintenance Center Fleet Technical Assistance Contact Information	VI-2A-1
B	Sample Technical Assistance Visit Report (TAVR) Message.....	VI-2B-1
C	Sample E-Mail Technical Assistance Visit Report (E-TAVR).....	VI-2C-1

CHAPTER 3 - SUBMARINE MODERNIZATION

3.1	Purpose	VI-3-1
3.1.1	Scope	VI-3-1
3.1.2	Definition.....	VI-3-1
3.2	Responsibilities.....	VI-3-2
3.2.1	Immediate Superior In Command (Squadron/Naval Submarine Support Command).....	VI-3-2
3.2.2	Fleet Maintenance Activity.....	VI-3-3
3.2.3	Ship's Alteration Coordinator.....	VI-3-4
3.3	Alteration Programs	VI-3-5
3.3.1	Reactor Plant Ship Alteration Package Program (Nuclear Powered Ships only)	VI-3-5
3.3.2	Alteration Installation Team Program	VI-3-5
3.3.3	Type Commander Alteration Kit Program.....	VI-3-5
3.3.4	Alteration and Improvement Item Program.....	VI-3-6
3.3.4.1	Message Alterations and Improvements	VI-3-6
3.3.4.2	Alteration and Improvement Category Codes.....	VI-3-6
3.3.5	Command, Control, Communications, Computer, Combat Systems, Intelligence, Surveillance and Reconnaissance (C5ISR) Modernization Program (C5IMP)	VI-3-6
3.4	Monitoring of Alteration Status	VI-3-6
3.4.1	Type Commander Alteration Management System.....	VI-3-6
3.4.2	Navy Data Environment - Navy Modernization	VI-3-6
3.4.3	Navy Tool for Interoperability Risk Assessment, Submarine Modernization and Alteration Requirements Tool.....	VI-3-6
3.4.4	Nuclear Alteration Technical Documentation Compact Disk.....	VI-3-6
3.5	Liaison Action Request.....	VI-3-6
3.6	Alteration Feedback.....	VI-3-7
3.7	Alteration Requests.....	VI-3-7
3.8	TYCOM Modernization Websites	VI-3-7
3.9	Permanent Modifications to Tenders with Nuclear Support Facilities	VI-3-7
Appendices		
A	Major Ship Alteration Types Executive Summary	VI-3A-1
B	Submarine Alteration Request Format.....	VI-3B-1
C	Sample TEMPALT/OPALT Reporting Message	VI-3C-1
D	TYKIT Requisition Form	VI-3D-1
E	TYCOM Alteration Management System Interpretation Guide	VI-3E-1

F	Liaison Action Request (LAR) Form	VI-3F-1
G	Sample Alteration Feedback Message/Email Format	VI-3G-1

CHAPTER 4 - SHIPBOARD ELECTROMAGNETIC COMPATIBILITY

4.1	Purpose	VI-4-1
4.1.1	Background.....	VI-4-1
4.2	Electromagnetic Compatibility Assessments or Surveys.....	VI-4-1
4.2.1	Shipboard Electromagnetic Compatibility Assessments	VI-4-1
4.2.1.1	Surface Force Ships and Aircraft Carriers	VI-4-1
4.2.1.2	Submarines.....	VI-4-2
4.3	Fleet Electromagnetic Compatibility Support Tools.....	VI-4-3
4.4	Engineer Electromagnetic Interference Fixes	VI-4-3
4.4.1	Shipboard Full-scale Electromagnetic Compatibility Evaluations	VI-4-3
4.5	Electromagnetic Compatibility Certification	VI-4-3
4.5.1	System Electromagnetic Compatibility Certification	VI-4-3
4.5.1.1	System Electromagnetic Compatibility Certification Requirements.....	VI-4-3
4.5.2	Ship Electromagnetic Compatibility Certification.....	VI-4-3
4.5.2.1	Ship Electromagnetic Compatibility Certification Requirements	VI-4-4
4.6	Electromagnetic Compatibility Certification Maintenance.....	VI-4-4
4.6.1	Fleet Maintenance Activity.....	VI-4-4
4.7	Shipboard Electromagnetic Compatibility Improvement Program Technical Assistance Network	VI-4-4
4.8	Responsibilities.....	VI-4-4

CHAPTER 5 - DEFICIENCY DOCUMENTATION AND REPORTING

5.1	Purpose	VI-5-1
5.1.1	Background.....	VI-5-1
5.1.2	Scope	VI-5-2
5.1.3	Definitions	VI-5-2
5.1.3.1	Material Readiness.....	VI-5-2
5.1.3.2	Maintenance Figure of Merit Index Value	VI-5-2
5.1.3.3	Maintenance Worthy	VI-5-2
5.1.3.4	Current Ship's Maintenance Project	VI-5-3
5.1.3.5	Ship Maintenance Action Form	VI-5-3
5.1.3.6	Casualty Report.....	VI-5-3
5.1.3.7	Department of Defense Readiness Reporting System.....	VI-5-3
5.1.3.7.1	Joint Mission Essential Tasks.....	VI-5-4
5.1.3.7.2	Navy Capabilities Readiness Reporting System	VI-5-4
5.1.3.8	Item Unique Identification	VI-5-4
5.2	Responsibilities.....	VI-5-4
5.2.1	Ship's Force.....	VI-5-4
5.2.2	Immediate Superior in Command.....	VI-5-4
5.2.3	Maintenance Team.....	VI-5-4
5.2.4	Type Commander	VI-5-4
5.2.5	Fleet Maintenance Activity.....	VI-5-5
5.3	Guidance	VI-5-5
5.3.1	Generation of a Ship Maintenance Action Form OPNAV 4790/2K.....	VI-5-5
5.3.1.1	Required Instance for Documenting.....	VI-5-5
5.3.1.2	Procedures for Documenting a Maintenance Action.....	VI-5-5
5.3.2	Generation of a Casualty Report.....	VI-5-10
5.3.2.1	Guidance on Initial Documenting with a Casualty Report.....	VI-5-10
5.3.2.2	Guidance on Updating a Casualty Report	VI-5-13

5.3.2.3	Guidance on Deferral of a Casualty Report	VI-5-13
5.3.2.4	Guidance on Correction of a Casualty Report.....	VI-5-13
5.3.2.5	Guidance on Cancellation of a Casualty Report.....	VI-5-14

Appendices

A	Equipment Operational Capability Range of Values and Definitions	VI-5A-1
---	--	---------

CHAPTER 6 - INDUSTRIAL PLANT EQUIPMENT

6.1	Purpose	VI-6-1
6.1.1	Scope	VI-6-1
6.1.2	Background.....	VI-6-1
6.2	Definitions	VI-6-1
6.2.1	Plant Equipment - Classes Three and Four Plant Property	VI-6-1
6.2.2	Class Three Plant Property - Other Plant Equipment.....	VI-6-2
6.2.3	Class Four Plant Property - Industrial Plant Equipment	VI-6-2
6.3	Procurement Requirements.....	VI-6-2
6.3.1	Requesting Activities.....	VI-6-2
6.3.1.1	New Procurement.....	VI-6-2
6.3.1.2	Urgent Replacement.....	VI-6-2
6.3.1.3	Receipt of Plant Property	VI-6-2
6.4	Responsibilities.....	VI-6-3
6.4.1	Fleet Commander.....	VI-6-3
6.4.2	Type Commander	VI-6-3
6.5	Reports.....	VI-6-3

Appendices

A	Plant Equipment Project Form.....	VI-6A-1
---	-----------------------------------	---------

CHAPTER 7 - SUBMARINE FORCES AFLOAT PAINTING AND PRESERVATION GUIDELINES FOR NON-NUCLEAR SPACES AND COMPONENTS

7.1	Introduction	VI-7-1
7.1.1	Applicability	VI-7-1
7.1.2	Technical Point of Contact	VI-7-1
7.2	Scope	VI-7-2
7.2.1	Ship's Force Responsibilities.....	VI-7-2
7.2.2	Fleet Maintenance Activity Responsibilities	VI-7-2
7.2.3	Quick Reference	VI-7-3
7.2.4	Scheduled Preservation Upkeep Coordinated Effort	VI-7-3
7.3	General Safety Precautions	VI-7-3
7.3.1	Hazards.....	VI-7-3
7.3.2	Precautions	VI-7-3
7.4	Inspection of Existing Paint and Base Metal	VI-7-3
7.4.1	Required Tools	VI-7-3
7.4.2	Failure Locations	VI-7-3
7.4.2.1	Percent of General Corrosion	VI-7-3
7.4.2.2	Corrosion	VI-7-4
7.4.2.3	Percent of Blistering	VI-7-4
7.4.3	Cosmetic Paint Failure.....	VI-7-4
7.4.4	The Difference Between Rust and Rust Staining	VI-7-4
7.5	General Surface Preparation	VI-7-5
7.5.1	Surface Cleaning Methods.....	VI-7-5
7.5.2	Solvent Cleaning.....	VI-7-5
7.5.3	Detergent Cleaning	VI-7-6

7.5.4	Hand Tool Cleaning.....	VI-7-6
7.5.5	Power Tool Cleaning.....	VI-7-6
	7.5.5.1 Safety Warning.....	VI-7-6
	7.5.5.2 Power Tool Cleaning Procedure.....	VI-7-6
	7.5.5.3 Types of Power Tools.....	VI-7-7
	7.5.5.4 Power Tool Allowance.....	VI-7-7
7.5.6	Feathering Edges.....	VI-7-7
7.5.7	Aged Paint.....	VI-7-7
7.5.8	Surface Salt Concentration.....	VI-7-7
7.5.9	Equipment Maintenance.....	VI-7-7
7.6	General Mixing and Paint Application.....	VI-7-8
7.6.1	Product Data Sheet/Material Safety Data Sheet.....	VI-7-8
	7.6.1.1 Product Data Sheet.....	VI-7-8
	7.6.1.2 Material Safety Data Sheet.....	VI-7-8
7.6.2	Mixing Area.....	VI-7-9
7.7	Specific Painting Regulations for Submarines.....	VI-7-9
7.7.1	Motor Generator Units.....	VI-7-9
7.7.2	Coating Material.....	VI-7-9
7.7.3	Items Not To Be Painted.....	VI-7-9
7.7.4	Shelf Life of Paints.....	VI-7-11
7.8	Mixing Procedures.....	VI-7-11
7.8.1	Pre-Packaged Paint.....	VI-7-11
7.8.2	Mixing Observations.....	VI-7-11
7.8.3	Mixing and Application Procedures for the Navy Epoxy Paint System.....	VI-7-11
7.8.4	Mixing and Application Procedures for Commercial Epoxy Paint Systems.....	VI-7-12
7.9	Paint Application.....	VI-7-12
7.9.1	General Considerations.....	VI-7-12
7.9.2	Brush Application.....	VI-7-13
7.9.3	Roller Application.....	VI-7-13
7.9.4	Wet Film Thickness Check.....	VI-7-14
7.9.5	Overcoating.....	VI-7-15
7.10	Quick Reference Section.....	VI-7-16
7.10.1	Surface Preparation and Paint Application in Specific Areas.....	VI-7-16
7.10.2	Bilges.....	VI-7-16
	7.10.2.1 Surface Preparation.....	VI-7-16
	7.10.2.2 Paint Application.....	VI-7-17
	7.10.2.3 Summary.....	VI-7-18
7.10.3	Sail (Interior).....	VI-7-19
	7.10.3.1 Surface Preparation.....	VI-7-19
	7.10.3.2 Paint Application.....	VI-7-20
7.10.4	Non-Skid Areas.....	VI-7-21
	7.10.4.1 Areas That Are Not Tiled With Special Hull Treatment.....	VI-7-21
	7.10.4.1.1 Surface Preparation.....	VI-7-21
	7.10.4.1.2 Paint Application.....	VI-7-22
	7.10.4.2 Special Hull Treatment Tiled Areas (Non-Skid).....	VI-7-23
	7.10.4.2.1 Surface Preparation.....	VI-7-23
	7.10.4.2.2 Paint Application.....	VI-7-24
	7.10.4.3 Special Hull Treatment Tiles - Topside, Sail and Rudder.....	VI-7-25
	7.10.4.3.1 Cleaning of Formula 187 Urethane Camouflage Coating.....	VI-7-25
	7.10.4.3.2 Surface Preparation.....	VI-7-26
	7.10.4.3.3 Paint Application.....	VI-7-26
7.10.5	High Temperature Piping (and Components Near the 12k Evaporator).....	VI-7-27
	7.10.5.1 Surface Preparation.....	VI-7-27

7.10.5.2	Paint Application	VI-7-28
7.10.6	Underway Painting - Rust Converters	VI-7-29
7.10.6.1	Maintenance During Operational Cycle	VI-7-29
7.10.6.2	Restricted Use	VI-7-29
7.10.6.3	Surface Preparation.....	VI-7-29
7.10.6.4	Paint Application	VI-7-30
7.10.6.5	Overcoating Upon Return To Port.....	VI-7-30
7.10.7	Touch-Up of Miscellaneous Areas of General Corrosion	
	Including New High Solids Coatings	VI-7-31
7.10.7.1	Surface Preparation.....	VI-7-31
7.10.7.2	Paint Application	VI-7-31

Appendices

A	Submarine Paint Guide	VI-7A-1
B	Coating Inspection Report Form	VI-7B-1
C	Shipboard Power Cleaning Tools	VI-7C-1

CHAPTER 8 - MINIATURE/MICROMINIATURE ELECTRONIC REPAIR PROGRAM

8.1	Purpose	VI-8-1
8.1.1	Scope	VI-8-1
8.1.2	Policy	VI-8-2
8.1.3	Background.....	VI-8-2
8.2	Responsibilities.....	VI-8-2
8.2.1	Fleet Commander.....	VI-8-2
8.2.2	Type Commander/Immediate Superior In Command.....	VI-8-2
8.2.3	Commanding Officer/Officer In Charge.....	VI-8-2
8.2.4	Miniature/Microminiature Repair Program Coordinator/Module Test and Repair Facility Coordinator	VI-8-2
8.2.5	Commander, Navy Regional Maintenance Center.....	VI-8-3
8.2.5.1	Regional Maintenance Center	VI-8-3
8.3	Authorized Miniature/Microminiature Outfitting	VI-8-3
8.4	Miniature/Microminiature Personnel and Station Requirements	VI-8-3
8.5	Progressive Repair Process	VI-8-3
8.5.1	Repair Process	VI-8-3
8.5.2	Ship's Force Process.....	VI-8-4
8.5.3	Fleet Maintenance Activity Process.....	VI-8-4
8.5.4	Certification of Miniature/Microminiature Repaired Assets as Ready for Issue	VI-8-4
8.5.5	Miniature/Microminiature Module Test and Repair Piece Parts.....	VI-8-4
8.6	Unique Miniature/Microminiature Guidance (Naval Air Force Only)	VI-8-5
8.6.1	Aviation Intermediate Maintenance Department	VI-8-5
8.6.2	Aircraft Carrier Fleet Maintenance Activity Module Test and Repair Facility	VI-8-5
8.7	Unique Miniature/Microminiature Guidance (Submarine Force Only).....	VI-8-6
8.7.1	Module Screening and Repair Activity.....	VI-8-6
8.7.2	Fleet Maintenance Activity/Submarine Base.....	VI-8-6
8.7.3	OHIO Class Organizational Repair Capability	VI-8-6
8.7.4	Reports.....	VI-8-6

Appendices

A	Emergency 2M Repair Process	VI-8A-1
B	Normal 2M Repair Process.....	VI-8B-1
C	MTRF 3-M Reporting (Aircraft Carriers Only).....	VI-8C-1
D	Sample MTRF Amplifying Procedures Message	VI-8D-1
E	Sample CVN MTRF Repair Request Message.....	VI-8E-1
F	Sample MTRF Quarterly Report Message (Aircraft Carriers Only).....	VI-8F-1
G	MTRF Equipment Configuration.....	VI-8G-1

CHAPTER 9 - METROLOGY AND CALIBRATION PROGRAM

9.1	Purpose	VI-9-1
9.1.1	Scope	VI-9-1
9.1.2	Policy	VI-9-1
9.2	Responsibilities	VI-9-1
9.2.1	Fleet Commanders	VI-9-1
9.2.2	Type Commander	VI-9-2
9.2.3	NAVSEA Technical Authority	VI-9-2
9.2.4	Immediate Superior In Command	VI-9-3
9.2.5	Commanding Officers All Forces	VI-9-3
9.2.6	Commanding Officers Surface Force	VI-9-4
9.2.7	Commanding Officers Naval Air Force	VI-9-4
9.2.8	Regional Maintenance Center Metrology and Calibration Coordinators	VI-9-5
9.2.9	Regional Maintenance Center/Regional Calibration Center	VI-9-5
9.3	Calibration Management	VI-9-5
9.3.1	Shipboard Gage Calibration Program Field Calibration Activity (Surface Force only)	VI-9-5
9.3.2	Calibration Accounting	VI-9-6
9.3.2.1	Shipboard Calibration Recall Inventories for MEASURE, TCR, and MCMS (Surface Forces)	VI-9-6
9.3.3	Submarine Forces Management Policy	VI-9-6
9.4	Regional Loan Pools	VI-9-7
9.5	Replacement of General Purpose Electronic Test Equipment/Calibration Standards	VI-9-7
9.5.1	Depot Level Repairables	VI-9-7
9.5.2	Navy Stock Funded	VI-9-7
9.6	Test Measurement Diagnostic Equipment Management	VI-9-8
9.6.1	Ship's Portable Electronic Test Equipment Requirements List	VI-9-8
9.6.2	Test Measurement Diagnostic Equipment Index	VI-9-8
9.6.3	Sub-Category Code	VI-9-8
9.6.4	Ship's Configuration and Logistics Support Information System Index	VI-9-8
9.6.5	Consolidated Test, Measurement and Diagnostic Equipment Readiness Assessment	VI-9-8
9.6.5.1	Consolidated Test, Measurement and Diagnostic Equipment Readiness Assessment Program	VI-9-8
9.6.5.2	Type Commander Metrology and Calibration Program Managers	VI-9-8
9.6.5.2.1	Consolidated Test, Measurement and Diagnostic Equipment Readiness Assessment Review Process	VI-9-8
9.6.5.2.2	Consolidated TMDE Readiness Assessment Test, Measurement and Diagnostic Equipment Redistribution	VI-9-9
9.6.5.2.3	Completion and Corrective Action Reporting (Submarines only)	VI-9-9
9.7	Shipboard Instrumentation and System Calibration	VI-9-9
9.7.1	Calibration Requirements List	VI-9-11
9.7.2	Calibration Interval	VI-9-11
9.7.2.1	Switch Settings	VI-9-12
9.7.3	Markings for Test, Measurement and Diagnostic Equipment	VI-9-12
9.7.4	SISCAL System Level Calibration Guidance for Ship Conversion Navy Platforms and Platforms in CNO or other Maintenance Availabilities	VI-9-12
9.8	LHA and LHD Class Ship Metrology and Calibration Program	VI-9-13
9.8.1	Purpose	VI-9-13
9.8.2	Background	VI-9-13
9.8.3	Discussion	VI-9-14
9.8.4	Scope	VI-9-14
9.8.5	Applicability	VI-9-14
9.8.6	Action	VI-9-14

9.9 Nuclear Propulsion Calibration Requirements VI-9-17

CHAPTER 10 - MOTOR GASOLINE HANDLING AND STORAGE

10.1 Purpose VI-10-1
 10.1.1 Discussion VI-10-1

10.2 Characteristics VI-10-1

10.3 Personnel Hazards VI-10-1

10.4 Storage and Handling VI-10-1
 10.4.1 Tank Conditions VI-10-1
 10.4.2 Loading and Off-loading VI-10-2
 10.4.3 Identification and Sampling Requirements VI-10-2
 10.4.4 Safe Handling of Motor Gasoline VI-10-3
 10.4.5 Containerized Motor Gasoline VI-10-3
 10.4.6 LPD 17 Class MOGAS System VI-10-3
 10.4.6.1 Storage and Handling VI-10-3
 10.4.6.2 Firefighting and Safety Requirements VI-10-3

10.5 Motor Gasoline Assessment Program VI-10-3

CHAPTER 11 - MAINTENANCE, REPAIR AND OVERHAUL OF SERVICE CRAFT, LANDING CRAFT AND SMALL BOATS

11.1 Purpose VI-11-1
 11.1.1 Policy VI-11-1

11.2 Material Readiness VI-11-1

11.3 Maintenance of Landing Craft and Small Boats Assigned to Afloat Units VI-11-2
 11.3.1 Landing Craft and Small Boat Repairs During Chief of Naval Operations Maintenance Availability VI-11-2

11.4 Maintenance of Service Craft, Landing Craft and Small Boats Assigned to Shore Activities, Group and Squadron Commanders VI-11-3
 11.4.1 Unit Level Maintenance VI-11-3
 11.4.2 Fleet Maintenance Activity Level/Contractor Assist Maintenance VI-11-3
 11.4.3 Overhaul of Service/Landing Craft and Small Boats VI-11-3

11.5 Responsibilities VI-11-4
 11.5.1 Type Commander VI-11-4
 11.5.2 Immediate Superior In Command VI-11-4
 11.5.3 Commanding Officers of Parent Commands VI-11-4

11.6 Repair and Overhaul of Small Boat Engines VI-11-5
 11.6.1 Boat Alterations VI-11-5

11.7 Operation of Small Boat Engines VI-11-5

CHAPTER 12 - DEGAUSSING

12.1 Purpose VI-12-1

12.2 Degaussing Definitions VI-12-1
 12.2.1 Deperming VI-12-1
 12.2.2 Installed Degaussing System VI-12-1
 12.2.3 Magnetic Compass Compensation VI-12-1
 12.2.4 Check Ranging VI-12-1
 12.2.5 Degaussing Folder VI-12-1

12.3 Ships and Submarines With Installed Degaussing Systems VI-12-1
 12.3.1 Check Ranging VI-12-2

12.3.2 Responsibilities VI-12-2
 12.3.2.1 Type Commander/Immediate Superior In Command VI-12-2
 12.3.2.2 Ship Commanding Officer VI-12-3
 12.4 Submarines Without Installed Degaussing Systems VI-12-3
 12.4.1 Responsibilities VI-12-3
 12.4.1.1 Type Commander/Immediate Superior In Command VI-12-3
 12.4.1.2 Ship Commanding Officer VI-12-3

CHAPTER 13 - SURFACE SHIP CORROSION CONTROL

13.1 Purpose VI-13-1
 13.2 Background VI-13-1
 13.3 Policy VI-13-1
 13.4 Responsibilities VI-13-2
 13.4.1 Type Commanders VI-13-2
 13.4.2 Fleet Maintenance Activity/Regional Maintenance Center VI-13-2
 13.4.3 Surface Force Ships and Aircraft Carriers VI-13-3

Appendices

A Preservation Departures from Specifications Process Decision Tree VI-13A-1

CHAPTER 14 - CANNIBALIZATION

14.1 Purpose VI-14-1
 14.1.1 Policy VI-14-1
 14.2 Definitions VI-14-1
 14.2.1 Self-Cannibalization VI-14-1
 14.2.2 System Cannibalization VI-14-1
 14.2.3 Active Ship Cannibalization VI-14-1
 14.3 Authorization (Active Ship) VI-14-1
 14.3.1 Commander Naval Surface Force Ships VI-14-2
 14.3.2 Naval Air Force Ships VI-14-2
 14.3.3 Submarine Force Ships VI-14-2
 14.4 Request and Authorization VI-14-2
 14.4.1 Requesting Ship VI-14-2
 14.5 Ship's Responsibilities VI-14-2
 14.5.1 Requesting Ship VI-14-3
 14.5.2 Cannibalized Ship VI-14-3
 14.6 Surface Force Ships' Specific Instructions VI-14-3
 14.6.1 Immediate Superior In Command VI-14-3
 14.6.2 Type Commander VI-14-3
 14.7 Procedures VI-14-3
 14.7.1 Type Commander VI-14-3
 14.7.2 Immediate Superior In Command VI-14-3

Appendices

A Sample Cannibalization Request Message (Aircraft Carriers and Surface Force Ships Only) VI-14A-1

CHAPTER 15 - AMMUNITION OFF-LOAD

15.1 Purpose VI-15-1
 15.1.1 Policy VI-15-1

15.2 Action VI-15-1
 15.3 Notification..... VI-15-2

CHAPTER 16 - HABITABILITY

16.1 Purpose VI-16-1
 16.1.1 Policy VI-16-1
 16.1.2 Discussion..... VI-16-1
 16.2 Habitability Improvement Programs..... VI-16-1
 16.2.1 Ship’s Force Habitability Improvement Projects..... VI-16-1
 16.2.2 Habitability Programs Under the Technical Sponsorship of Naval Sea Systems Command..... VI-16-2
 16.2.2.1 Program Responsibilities VI-16-3
 16.2.2.1.1 Chief of Naval Operations VI-16-3
 16.2.2.1.2 Naval Sea Systems Command VI-16-3
 16.2.2.1.3 Type Commander VI-16-4
 16.2.2.1.4 Regional Maintenance Center or Other Agent as Tasked and
 Funded by Type Commander..... VI-16-4
 16.2.2.1.5 Supply Activity..... VI-16-5
 16.2.2.1.6 Ship Commanding Officer..... VI-16-5
 16.2.2.2 Project Milestones VI-16-5
 16.2.2.2.1 Advance Planning Notice (Surface Force Ships Only)..... VI-16-5
 16.2.2.2.2 Advance Planning Notice (Aircraft Carriers Only) VI-16-5
 16.2.2.2.3 Project Confirmation Notice..... VI-16-5
 16.2.2.2.4 Project Authorization..... VI-16-5
 16.2.2.3 Project Completion Report..... VI-16-6
 16.2.2.4 Integrated Logistics Support Reporting VI-16-6
 16.3 New Construction Ships VI-16-6
 16.4 Naval AirPac/Lant Specific Habitability Improvement Programs..... VI-16-6
 16.4.1 Aircraft Carrier Climate Control Improvement Team VI-16-6
 16.4.2 Food Service and Laundry (Commander, Naval Air Force Pacific)/
 Enhanced Quality Of Life Program (Commander, Naval Air Force Atlantic) VI-16-6

Appendices

A Table of Habitability Project Technical Requirements and Actions VI-16A-1
 B Sample Habitability OPTAR Augment Funding Request VI-16B-1
 C Advance Planning Milestones VI-16C-1

CHAPTER 17 - IMPRESSED CURRENT CATHODIC PROTECTION

17.1 Purpose VI-17-1
 17.1.1 Applicability VI-17-1
 17.2 Cathodic Protection Logs..... VI-17-1
 17.2.1 Surface Force Ships VI-17-1
 17.2.2 Naval Air Force Ships VI-17-1
 17.2.3 Submarine Force Ships VI-17-1
 17.3 Post Drydocking Activation..... VI-17-1

CHAPTER 18 - INFLATABLE LIFE RAFTS

18.1 Purpose VI-18-1
 18.1.1 Discussion..... VI-18-1
 18.2 Fleet Life Raft Program VI-18-1
 18.2.1 Types of Inflatable Life Rafts VI-18-1
 18.2.2 Commercial Life Rafts..... VI-18-1
 18.3 Recertification..... VI-18-1

18.4 Contingency Pools VI-18-2

18.5 Automated Tracking System VI-18-2

18.6 Responsibilities VI-18-2

 18.6.1 Commanding Officer/Officer In Charge VI-18-2

 18.6.2 Regional Maintenance Center/Regional Repair Center VI-18-3

 18.6.3 Regional Maintenance Center VI-18-3

18.7 Unserviceable/Rejected Life Rafts VI-18-4

18.8 Records VI-18-4

CHAPTER 19 - MAINTENANCE AND MATERIAL MANAGEMENT

19.1 Purpose VI-19-1

 19.1.1 Policy VI-19-1

 19.1.2 Scope VI-19-1

19.2 Ship Maintenance and Material Management VI-19-1

 19.2.1 Responsibilities VI-19-1

 19.2.1.1 Type Commander VI-19-1

 19.2.1.2 Type Commander 3-M Regional Representatives (Submarines only) VI-19-2

 19.2.1.3 Immediate Superior In Command VI-19-3

 19.2.1.4 In-Service Engineering Activity VI-19-3

 19.2.1.5 Naval Sea Logistics Center Detachments VI-19-3

 19.2.1.6 Submarine Maintenance Engineering, Planning and Procurement Activity
 (Submarines only) VI-19-3

 19.2.1.7 Afloat Training Group (Surface Force Ships only) VI-19-4

 19.2.1.8 Ship's Maintenance and Material Management Coordinator/
 Officer VI-19-4

 19.2.1.8.1 Optimally Manned Ships VI-19-4

 19.2.1.9 Command Maintenance Availability Coordinator/Ship's Material
 Maintenance Officer VI-19-4

 19.2.2 Qualifications VI-19-5

 19.2.3 Maintenance and Material Management Operation and Administration VI-19-5

 19.2.3.1 Standard Force Work Center Numbering System VI-19-5

 19.2.3.2 Job Control Number VI-19-5

 19.2.3.3 Job Sequence Number VI-19-6

 19.2.3.4 Scheduling VI-19-6

 19.2.3.5 Execution VI-19-6

 19.2.3.6 Accountability VI-19-7

 19.2.4 Preventive Maintenance Feedback Reports VI-19-7

 19.2.4.1 Technical Feedback Report Reporting (Submarine Force only) VI-19-7

 19.2.4.2 Preventive Maintenance System Feedback Reports VI-19-7

 19.2.4.3 Feedback Report Types VI-19-7

 19.2.4.4 Feedback Report Screening VI-19-7

 19.2.4.5 Preventive Maintenance System Technical Feedback Reports VI-19-8

 19.2.4.6 Preventive Maintenance System Coordinating Activities VI-19-8

 19.2.4.7 In-Service Engineering Activities VI-19-8

 19.2.4.8 Action Activities VI-19-8

 19.2.4.9 Urgent Technical Feedback Reports VI-19-8

 19.2.4.10 Routine Technical Feedback Reports VI-19-8

 19.2.4.11 Type Commander Screening of Technical Feedback Reports VI-19-9

 19.2.5 Submarine Safety/Scope of Certification/Survivability and Escape
 (Submarine Force only) VI-19-9

 19.2.6 Evaluation VI-19-10

 19.2.6.1 Assessments VI-19-10

 19.2.6.2 Assessment Reporting VI-19-11

Appendices

A	3-M System Assessment/Evaluation Procedures	VI-19A-1
B	Format for Reporting 3-M Assessments	VI-19B-1
C	Listing of Standard Work Center Codes	VI-19C-1
C ₁ A	Standard Work Center Codes for Naval Air Force Ships (CVN-68 Class)	VI-19C-3
C ₁ B	Standard Work Center Codes for Naval Air Force Ships (CVN-78 Class)	VI-19C-13
C ₂	Standard Work Center Codes for Naval Expeditionary Combat Command	VI-19C-21
C ₃	Standard Work Center Codes for Naval Submarine Force Ships	VI-19C-49
C ₄	Standard Work Center Codes for Naval Surface Force Ships and Shore Commands	VI-19C-61
D	Listing of Standard Work Center Codes for Master Job Catalog Items Contained in Ship's CSMP (Surface and Submarine Forces only)	VI-19D-1
E	Job Originator Values	VI-19E-1
F	Sample Situational Requirement Reference Sheet.....	VI-19F-1

CHAPTER 20 - WEIGHT AND MOMENT CONTROL FOR SUBMARINES

20.1	Purpose	VI-20-1
20.1.1	Discussion.....	VI-20-1
20.2	Ballast Changes	VI-20-2
20.2.1	Naval Sea Systems Command Notification	VI-20-2
20.2.2	Ballast Types	VI-20-2
20.3	Unusual Conditions	VI-20-3

Appendices

A	Sample Ship Message to ISIC Concerning Removal or Reinstallation of DDS Lead	VI-20A-1
B	Sample Ship Message to ISIC Concerning Audit of DDS Lead Loading.....	VI-20B-1
C	Sample Ship Message to ISIC Concerning Audit of Cargo Lead Documentation.....	VI-20C-1

CHAPTER 21 - SUBMARINE STORAGE BATTERIES

21.1	Purpose	VI-21-1
21.1.1	Background.....	VI-21-1
21.1.2	Discussion.....	VI-21-1
21.2	Action	VI-21-2
21.3	Casualty Reporting	VI-21-3
21.3.1	Purpose	VI-21-3
21.3.2	Background	VI-21-3
21.3.3	SSN/SSGN Class Submarine Main Storage Battery	VI-21-3
21.3.4	SSBN Class Submarine Main Storage Battery	VI-21-3

Appendices

A	Temperature Versus TVG Table.....	VI-21A-1
B	Temperature Versus MCV Table.....	VI-21B-1
C	TCV Calculation Table.....	VI-21C-1
D	Capacity Test Discharge Data Sheet.....	VI-21D-1
E	Main Storage Battery Inspection Check-Off	VI-21E-1
F	Instructions for Completing Submarine Battery Quarterly Reports - NAVSEA 9320/3	VI-21F-1
G	Instructions for Maintaining the Submarine Battery Record Book - NAVSEA 9320/1 (3-92).....	VI-21G-1

CHAPTER 22 - TRIDENT SYSTEM AND EQUIPMENT MAINTENANCE PLANS

22.1	Purpose	VI-22-1
22.2	TRIDENT System and Equipment Maintenance Plans	VI-22-1
22.2.1	TRIDENT Planned Equipment Replacement	VI-22-1
22.2.2	Deployed SSGN Unplanned TRIPER Change Out	VI-22-2

22.2.2.1	TRIPER Asset Segregation.....	VI-22-2
22.2.2.2	TRIPER Information Notebook.....	VI-22-2
22.2.2.3	Responsibilities.....	VI-22-2
22.2.3	Major Shore Spares.....	VI-22-3
22.2.4	Fleet Logistics Agent.....	VI-22-3
22.2.5	Updating of Submarine Logistics Technical Data.....	VI-22-3
22.2.6	Planned Refit Work Lists.....	VI-22-3

Appendices

A	TRIPER Information Sheet.....	VI-22A-1
---	-------------------------------	----------

CHAPTER 23 - SUBMARINE NOISE REDUCTION

23.1	Purpose.....	VI-23-1
23.1.1	Scope.....	VI-23-1
23.1.2	Background.....	VI-23-1
23.2	Noise Reduction Program Elements.....	VI-23-2
23.2.1	Radiated Noise Surveys.....	VI-23-2
23.2.1.1	Naval Sea Systems Command Acoustic Trials.....	VI-23-2
23.2.1.2	Coordinated Submarine Radiated Noise Analysis Exercise.....	VI-23-2
23.2.1.3	Coordinated Submarine Exercises (KILOEX/JTFEX/INT-2/TRACKEX/ GUNSLINGER).....	VI-23-2
23.2.1.4	Beartrap Acoustic Radiated Trials.....	VI-23-2
23.2.2	Onboard Noise Surveys.....	VI-23-3
23.2.2.1	Platform Noise Survey.....	VI-23-3
23.2.2.2	Topside and Housekeeping Survey.....	VI-23-3
23.2.2.2.1	Topside Survey.....	VI-23-3
23.2.2.2.2	Housekeeping Survey.....	VI-23-3
23.2.2.3	Machinery Vibration Survey.....	VI-23-3
23.2.2.4	Hull Vibration Survey.....	VI-23-3
23.2.2.5	Isolation System Survey.....	VI-23-3
23.2.2.6	Damping Material Survey.....	VI-23-3
23.2.2.7	Predeployment Noise Inspections.....	VI-23-3
23.2.2.8	Technical Onboard Monitoring Assist.....	VI-23-4
23.2.2.9	Sound Absorption Material Survey.....	VI-23-4
23.2.2.10	Airborne Noise Survey.....	VI-23-4
23.2.3	Shipboard Noise Reduction Program.....	VI-23-4
23.2.3.1	Noise Reduction Officer.....	VI-23-4
23.2.3.2	Noise Deficiency Log.....	VI-23-4
23.2.3.3	Noise Related Maintenance Records.....	VI-23-4
23.2.4	Training.....	VI-23-5
23.3	Responsibilities.....	VI-23-5
23.3.1	Immediate Superior In Command.....	VI-23-5
23.3.2	Industrial Activity.....	VI-23-5
23.3.3	Submarine Commanding Officer.....	VI-23-5

Appendices

A	Supplemental Noise Measurements.....	VI-23A-1
B	Beartrap Acoustic Radiated Trials (BART).....	VI-23B-1
C	Shipboard Noise Reduction Instruction.....	VI-23C-1
D	Predeployment Noise Inspection.....	VI-23D-1
E	Submarine Silencing Publications.....	VI-23E-1
F	Sample Propeller Changeout Message.....	VI-23F-1

CHAPTER 24 - PERIODIC MAINTENANCE REQUIREMENT PROGRAM

24.1	Purpose.....	VI-24-1
24.2	Type Commander Scheduling System.....	VI-24-1
24.2.1	Periodic Maintenance Requirements Schedule.....	VI-24-2

24.2.2	Scheduling Periodic Maintenance Requirements Work	VI-24-2
24.2.3	Periodic Maintenance Requirements Calldown/Brokering.....	VI-24-2
24.2.4	Calculating Adjusted Last Maintenance Action Date.....	VI-24-2
24.2.5	Calculating Due Dates	VI-24-2
24.3	Periodic Maintenance Requirements Accomplishment	VI-24-2
24.4	Material Support for Fleet Maintenance Activity Accomplished Periodic Maintenance Requirements	VI-24-3
24.4.1	Mandatory Parts.....	VI-24-3
24.4.2	Contingency Parts.....	VI-24-3
24.4.3	Requisitioning Procedures	VI-24-3
24.4.4	Material Support Provided by the Advance Equipment Repair Program	VI-24-3
24.4.5	Material Support Provided by the TRIDENT Planned Equipment Replacement Program	VI-24-3
24.5	Corrective Maintenance of Equipment Using Periodic Maintenance Requirements	VI-24-3
24.6	Periodic Maintenance Requirements Accomplishment During Chief of Naval Operations Maintenance Availabilities	VI-24-4
24.6.1	Operating Cycle/Interval Extension.....	VI-24-5
24.7	Responsibilities.....	VI-24-5
24.7.1	Type Commander	VI-24-5
24.7.2	Submarine Maintenance Engineering, Planning and Procurement Activity	VI-24-5
24.7.3	Immediate Superior In Command.....	VI-24-6
24.7.4	Fleet Maintenance Activity.....	VI-24-8
24.7.5	Submarine Commanding Officer.....	VI-24-9
Appendices		
A	SUBMEPP Maintenance and Shipwork Planning (MSWP) Periodic Maintenance Schedule - I Level	VI-24A-1
B	SUBMEPP Maintenance and Shipwork Planning (MSWP) Inventory of Periodic Maintenance Requirements - I Level	VI-24B-1
C	SUBMEPP Maintenance and Shipwork Planning (MSWP) Inventory of Periodic Maintenance Requirements - I/D Level	VI-24C-1
D	Submarine Periodic Maintenance Requirement (PMR) Management Process.....	VI-24D-1
E	Work Package Supplement - Shipyard Planning and Feedback Report	VI-24E-1
F	Work Package - Ship's System Work Description Part 4.13	VI-24F-1

CHAPTER 25 - UNRESTRICTED OPERATIONS

25.1	Purpose	VI-25-1
25.2	Unrestricted Operation Maintenance Scheduling, Planning and Reporting.....	VI-25-1
25.2.1	Maintenance Requirements for Continued Unrestricted Operation to Design Test Depth	VI-25-1
25.2.2	Scheduling and Reporting.....	VI-25-1
25.2.2.1	Non-SSBN/SSGN 726 Class Ships	VI-25-1
25.2.2.2	SSBN/SSGN 726 Class Ships	VI-25-2
25.2.2.3	Submarine Maintenance Engineering, Planning and Procurement Activity Inventories, and Schedules.....	VI-25-2
25.2.3	Baseline and Due Dates	VI-25-2
25.2.3.1	Last Maintenance Action Date.....	VI-25-2
25.2.3.2	Calculating Due Dates.....	VI-25-2
25.2.4	Periodicity Extensions	VI-25-2
25.2.5	Scheduling, Planning and Reporting Unrestricted Operation Accomplishment at Ship/Fleet Maintenance Activity Level	VI-25-3
25.2.5.1	Scheduling.....	VI-25-3
25.2.5.2	Planning	VI-25-3
25.2.5.3	Reporting to the Maintenance and Material Management (3-M) System	VI-25-3
25.2.6	Unrestricted Operation Maintenance Requirement Card Accomplishment During Chief of Naval Operations Maintenance Availabilities	VI-25-3
25.2.7	Unrestricted Operation Maintenance Requirement Card Completion Reporting	VI-25-4

25.2.8 Operating Cycle/Interval Extensions VI-25-4

25.3 Responsibilities VI-25-4

25.3.1 Type Commander VI-25-4

25.3.2 Submarine Maintenance Engineering, Planning and Procurement Activity VI-25-4

25.3.3 Immediate Superior In Command VI-25-5

25.3.4 Submarine Commanding Officer VI-25-8

Appendices

A URO MRC Automated Work Request for Ship’s Force Accomplishment VI-25A-1

B URO MRC Automated Work Request for FMA Accomplishment VI-25B-1

C SUBMEPP URO MRC Inventory VI-25C-1

D SUBMEPP URO MRC Schedule VI-25D-1

E Request for URO MRC Periodicity Extension Format VI-25E-1

F Sample Work Package Supplement VI-25F-1

CHAPTER 26 - OPERATING DEPTH POLICY

26.1 Purpose VI-26-1

26.1.1 Background VI-26-1

26.2 Initial Tightness Dive VI-26-1

26.3 Deep Dive/Controlled Dive VI-26-1

26.3.1 Depth Limitations VI-26-2

26.3.2 Conduct of Deep Dives/Controlled Dives VI-26-2

26.3.3 Deep Submergence Bill VI-26-2

26.3.4 Valve Operation VI-26-2

CHAPTER 27 - SCHEDULED PRESERVATION UPKEEP COORDINATED EFFORT

27.1 Purpose VI-27-1

27.2 Scheduling VI-27-1

27.3 Responsibilities VI-27-2

27.3.1 Type Commander VI-27-2

27.3.2 Immediate Superior In Command VI-27-2

27.3.3 Fleet Maintenance Activity VI-27-2

27.3.4 Submarine Commanding Officer VI-27-2

Appendices

A SPRUCE Key Event Schedule VI-27A-1

B SPRUCE Report Form VI-27B-1

C SPRUCE Check List VI-27C-1

CHAPTER 28 - CABLEWAY ASSESSMENT

28.1 Purpose VI-28-1

28.2 Hazard Categories VI-28-1

28.3 Deficiency Correction VI-28-1

28.4 Assessment Scheduling VI-28-1

28.4.1 Initial Assessment VI-28-1

28.4.2 Follow-up Assessments VI-28-1

28.4.3 Partial Assessments VI-28-1

28.5 Cableway Assessment/Assist Team Composition and Procedures VI-28-2

28.6 Responsibilities VI-28-2

28.6.1 Immediate Superior In Command VI-28-2

28.6.2 Regional Maintenance Center VI-28-2

28.6.3 Fleet Maintenance Activity..... VI-28-2
 28.6.4 Cableway Assessment Team VI-28-2
 28.6.5 Ship Commanding Officer..... VI-28-3
 28.7 Reports..... VI-28-3

Appendices

A Sample Cableway Assessment Message..... VI-28A-1

CHAPTER 29 - HEAT STRESS CONTROL AND REPAIR OF THERMAL INSULATION

29.1 Purpose VI-29-1
 29.2 Heat Stress VI-29-1
 29.2.1 Measurement of Insulation Surface Temperatures VI-29-1
 29.2.2 Heat Stress Area Stay Times VI-29-2
 29.3 Industrial Availability Lagging Plan..... VI-29-2
 29.4 Asbestos Lagging/Insulation..... VI-29-2
 29.4.1 Asbestos Control and Safety..... VI-29-2
 29.4.2 Repairs to Asbestos Lagging/Insulation VI-29-2
 29.4.3 Removal of Asbestos Lagging/Insulation VI-29-2

Appendices

A Inspection Guide for Excessive Heat..... VI-29A-1

CHAPTER 30 - PORTABLE TOOL ASSISTANCE PROGRAM

30.1 Purpose VI-30-1
 30.2 Portable Tool Inventory Policy VI-30-1
 30.2.1 Distribution Priorities VI-30-1
 30.2.2 Borrowing Procedures VI-30-1
 30.2.3 Borrowing Ship’s Responsibilities VI-30-1

CHAPTER 31 - SURFACE FORCE SHIP MAINTENANCE PLACEMENT AND OVERSIGHT BUSINESS RULES

31.1 Purpose VI-31-1
 31.2 Background..... VI-31-1
 31.3 Ship Maintenance Funding Management Business Rules VI-31-1
 31.3.1 Scope VI-31-1
 31.3.2 Ship and Maintenance Team Business Responsibilities VI-31-1
 31.3.3 Regional Maintenance Center Business Responsibilities VI-31-3
 31.3.4 Type Commander Responsibilities VI-31-4
 31.4 Maintenance Proposal Review..... VI-31-4
 31.4.1 Concept..... VI-31-5
 31.4.2 Business Rules VI-31-5
 31.4.3 Continuous Estimating Incremental Planning Review Process VI-31-5
 31.4.3.1 Concept VI-31-5
 31.4.3.2 Business Rules VI-31-6
 31.4.3.3 Schedule Modification VI-31-7
 31.5 Guidance for Firm Fixed Price Contracts VI-31-7
 31.5.1 Overall Process VI-31-7
 31.5.2 Firm Fixed Price Planning VI-31-7
 31.5.3 Firm Fixed Price Placement..... VI-31-7

Appendices

A RMC Spotlight Reports VI-31A-1

CHAPTER 32 - TOP MANAGEMENT ATTENTION TOP MANAGEMENT ISSUES

32.1 Purpose VI-32-1

32.2 Background..... VI-32-1

32.3 Applicability and Scope..... VI-32-1

32.4 Responsibilities VI-32-2

32.4.1 Commander, United States Fleet Forces Command VI-32-2

32.4.1.1 Duties VI-32-2

32.4.2 Naval Sea Systems Command VI-32-2

32.4.2.1 Duties VI-32-2

32.4.2.1.1 Commander, Naval Sea Systems Command (05)..... VI-32-2

32.4.2.1.2 Naval Sea Systems Command 07/Program
Executive Officer Submarines VI-32-2

32.4.2.1.3 Commander, Naval Sea Systems Command Program Offices VI-32-3

32.4.2.1.4 Program Executive Officers and Direct Reporting
Program Managers..... VI-32-3

32.4.2.1.5 Top Management Attention/Top Management Issues Panels..... VI-32-3

32.4.2.1.5.1 Top Management Attention Panels..... VI-32-3

32.4.2.1.6 Top Management Attention/Top Management Issues
Working Groups..... VI-32-5

32.4.2.1.7 Review VI-32-5

32.4.3 Top Management Attention/Top Management Issues Analysis Center..... VI-32-5

32.4.3.1 Candidate Identification VI-32-5

32.4.3.2 Candidate Expanded Metrics VI-32-5

32.4.4 Type Commanders..... VI-32-5

32.5 Metrics VI-32-5

32.5.1 Top Management Attention/Top Management Issues Candidate Selection VI-32-5

32.5.1.1 Top Management Attention/Top Management Issues Ranking Matrix Method.... VI-32-6

32.5.1.1.1 Ranking Matrix Calculation..... VI-32-6

32.5.1.2 Impact Chart..... VI-32-9

32.5.1.3 Balanced Score Card VI-32-9

32.5.1.4 Time (problem free)..... VI-32-10

32.5.1.4.1 Time (problem free) Assessment VI-32-11

32.5.1.5 Failure Trend..... VI-32-12

32.5.1.6 Parts Ranking VI-32-13

32.5.1.7 Ship’s Logistics Indicator Computerized Report VI-32-13

32.5.1.8 Ranking Matrix VI-32-14

Appendices

A Top Management Attention and Top Management Issues Flowchart VI-32A-1

CHAPTER 33 - MAINTENANCE AND MODERNIZATION BUSINESS PLAN

33.1 Maintenance and Modernization Business Plan VI-33-1

33.2 MMBP Responsibilities VI-33-1

33.2.1 Maintenance Team Responsibilities VI-33-1

33.2.2 NSA Responsibilities..... VI-33-1

33.2.3 TYCOM Responsibilities (Surface Force Ships only)..... VI-33-2

33.2.4 TYCOM Responsibilities (Aircraft Carriers and Submarines only)..... VI-33-2

33.2.5 Ship Program Manager Responsibilities..... VI-33-2

33.3 The MMBP Submission..... VI-33-3

33.3.1 MMBP Spreadsheet VI-33-3

33.3.1.1 General Description VI-33-3

33.3.1.2 Executive Summary Sheet VI-33-3

33.3.1.3 Controls and Phasing Sheet..... VI-33-3

33.3.1.4	Unfunded Requirements Sheet	VI-33-3
33.3.2	Prioritization	VI-33-4
33.3.3	Maintenance Summary and Risk Assessment	VI-33-4
33.4	Budget Process and MMBP Development Timeline	VI-33-4
33.4.1	Guidance	VI-33-4
33.4.2	Initial Budget Guidance (March).....	VI-33-4
33.4.3	Provide Controls to Maintenance Team (April).....	VI-33-4
33.4.4	Execution Strategy Adjustments (May).....	VI-33-5
33.4.5	(Surface Ships only) Maintenance Team Submit MMBPs for Approval via NSA (June)	VI-33-5
33.4.6	TYCOM Approves MMBPs (July).....	VI-33-5
33.4.7	Submit Phasing Plans (August)	VI-33-5
33.5	Business Plan Resources.....	VI-33-5
33.5.1	Resources.....	VI-33-5
Appendices		
A	Executive Summary Sheet	VI-33A-1

CHAPTER 34 - SUBMARINE FLY-BY-WIRE SHIP CONTROL SYSTEM MAINTENANCE AND CERTIFICATION **CHAPTER DELETED - SAVE FOR FUTURE USE**

CHAPTER 35 - REGIONAL MAINTENANCE CENTER I-LEVEL MAINTENANCE CAPABILITIES

35.1	Purpose	VI-35-1
35.2	Background.....	VI-35-1
35.2.1	Onboard Support.....	VI-35-1
35.2.2	Applicable Regional Maintenance Centers.....	VI-35-1
35.3	Responsibilities	VI-35-1
35.3.1	Fleet Commanders	VI-35-1
35.3.2	Commander, Navy Regional Maintenance Center.....	VI-35-2
35.3.3	Regional Maintenance Center.....	VI-35-3
35.4	Regional Maintenance Center Performance Measures	VI-35-3
35.4.1	Reporting	VI-35-3
Appendices		
A	Regional Maintenance Center I-Level Maintenance Capability Matrix	VI-35A-1

CHAPTER 36 - SURFACE FORCE SHIP/AIRCRAFT CARRIER MODERNIZATION PROGRAM

36.1	Scope	VI-36-1
36.2	Purpose	VI-36-1
36.3	Background.....	VI-36-1
36.4	Process	VI-36-2
36.4.1	Key Elements.....	VI-36-2
36.4.2	Decision Points	VI-36-3
36.4.3	Ship Change Document	VI-36-3
36.4.3.1	Phase I.....	VI-36-3
36.4.3.2	Phase II.....	VI-36-4
36.4.3.3	Phase III	VI-36-4
36.4.4	Technical Assessment Teams	VI-36-4
36.4.4.1	Technical Assessments.....	VI-36-4
36.4.4.2	Technical Assessment Business Rules	VI-36-4
36.4.4.3	Phase I Technical Assessment Rules	VI-36-4
36.4.4.4	Technical Assessment Teams.....	VI-36-4
36.4.4.5	Changes.....	VI-36-5

36.4.4.6	Phase II Technical Assessment Rules	VI-36-5
36.4.4.7	Phase II (a) Update Technical Assessment	VI-36-5
36.4.4.8	Phase III Technical Assessment Rules	VI-36-5
36.4.5	Cost Benefit Analysis	VI-36-5
36.4.5.1	Phase I Preliminary Analysis Business Rules	VI-36-5
36.4.5.2	Phase II Concept Design Cost Benefit Analysis Update.....	VI-36-5
36.4.5.3	Phase III Design Development Cost Benefit Analysis Update	VI-36-6
36.4.6	Alteration Figure of Merit.....	VI-36-6
36.4.7	Annual Assignment of Weights	VI-36-6
36.4.8	Combining of Phases	VI-36-7
36.5	Voting Rules	VI-36-8
36.5.1	Voting Database Rules.....	VI-36-8
36.5.2	Initiate Ship Change Document Business Rules.....	VI-36-8
36.6	Decision Boards.....	VI-36-8
36.6.1	Board Specific Rules	VI-36-8
36.7	Approval for Fleet Alterations	VI-36-9
36.8	Execution Year Changes to Modernization Plans.....	VI-36-9
36.9	Metrics	VI-36-9
36.9.1	Evaluation.....	VI-36-10
36.9.1.1	Process Effectiveness	VI-36-10
36.9.1.2	Process Efficiency.....	VI-36-10
36.9.1.3	First Pass Yield	VI-36-11
36.9.1.4	Productivity.....	VI-36-11
36.9.1.5	Sunk Cost	VI-36-12
36.10	Milestones.....	VI-36-12
Appendices		
A	Modernization Plan Flowchart.....	VI-36A-1
B	Ship Change Document Template	VI-36B-1
C	Technical Assessment Flowchart.....	VI-36C-1
D	Cost Benefit Analysis Flowchart	VI-36D-1
E	Alteration Figure of Merit Flowchart	VI-36E-1
F	Voting Database Flowchart	VI-36F-1

CHAPTER 37 - REGIONAL MAINTENANCE CENTER PASSIVE COUNTERMEASURE SYSTEM SUPPORT REQUIREMENTS

37.1	Purpose	VI-37-1
37.1.1	Background.....	VI-37-1
37.2	Passive Countermeasure System Event Description.....	VI-37-1
37.3	Passive Countermeasure System Personnel Certification.....	VI-37-2
37.3.1	Passive Countermeasure System In-Service Engineering Activity.....	VI-37-2
37.3.2	Training Requirements	VI-37-2
37.3.3	Support Personnel.....	VI-37-2
37.3.4	Japan Regional Maintenance Center and Pearl Harbor Naval Shipyard.....	VI-37-2
37.3.5	Ship's Force Personnel	VI-37-2
37.4	Passive Countermeasure System Technical Assistance	VI-37-2
37.4.1	Technical Assistance	VI-37-2
37.5	Responsibilities.....	VI-37-2

CHAPTER 38 - DEEP SUBMERGENCE SYSTEMS HULL INTEGRITY PROCEDURES

38.1	Purpose	VI-38-1
------	---------------	---------

38.2	Hull Integrity Procedures Maintenance Scheduling, Planning and Reporting.....	VI-38-1
38.2.1	Maintenance Requirements for Continued Certification	VI-38-1
38.2.2	Scheduling and Reporting.....	VI-38-1
38.2.2.1	Dry Deck Shelter.....	VI-38-1
38.2.2.2	Submarine Maintenance Engineering, Planning and Procurement Activity Inventories and Schedules	VI-38-1
38.2.3	Baseline and Due Dates	VI-38-1
38.2.3.1	Last Maintenance Action Date	VI-38-2
38.2.3.2	Calculating Due Dates.....	VI-38-2
38.2.4	Periodicity Extensions	VI-38-2
38.2.5	Scheduling, Planning and Reporting Hull Integrity Procedure Accomplishment at Sustaining Activity/Fleet Maintenance Activity Level.....	VI-38-2
38.2.5.1	Scheduling.....	VI-38-2
38.2.5.2	Planning	VI-38-2
38.2.5.3	Reporting to the Maintenance and Material Management (3-M) System	VI-38-2
38.2.6	Deep Submergence System Hull Integrity Procedures Accomplishment During Maintenance Availabilities	VI-38-3
38.2.7	Deep Submergence System Hull Integrity Procedures Completion Reporting.....	VI-38-3
38.2.8	Operating Cycle/Interval Extensions	VI-38-3
38.3	Responsibilities.....	VI-38-3
38.3.1	Type Commander	VI-38-3
38.3.2	Submarine Maintenance Engineering, Planning and Procurement Activity	VI-38-4
38.3.3	Immediate Superior In Command.....	VI-38-4
38.3.4	Deep Submergence System Commanding Officer	VI-38-6
Appendices		
A	SUBMEPP DSS HIP Inventory.....	VI-38A-1
B	SUBMEPP DSS HIP Schedule.....	VI-38B-1
C	Request for DSS HIP Periodicity Extension Format	VI-38C-1

CHAPTER 39 - MAINTENANCE AND MODERNIZATION PERFORMANCE REVIEW AND LESSONS LEARNED CONFERENCE FOR SURFACE FORCE SHIPS

39.1	Purpose	VI-39-1
39.2	Maintenance and Modernization Performance Review Overview.....	VI-39-1
39.2.1	MMPR Objective.....	VI-39-1
39.2.2	MMPR Key Membership.....	VI-39-1
39.2.3	MMPR Action Items.....	VI-39-2
39.2.4	Further Guidance	VI-39-2
39.3	Lessons Learned Conference Overview.....	VI-39-2
39.3.1	Lessons Learned Conference Concept.....	VI-39-2
39.3.2	Lessons Learned Conference Objective.....	VI-39-2
39.3.3	Lessons Learned Conference Key Membership	VI-39-2
39.4	Preparing for the Lessons Learned Conference	VI-39-3
39.4.1	Preparation.....	VI-39-3
39.4.2	Lessons Learned Conference Presentation Overview.....	VI-39-4
39.5	Conducting a Lessons Learned Conference.....	VI-39-4
39.5.1	Lessons Learned Conference Schedule.....	VI-39-4
39.5.2	Agenda.....	VI-39-4
39.5.3	Lessons Learned Conference Focus Areas	VI-39-4
39.5.4	Invitees.....	VI-39-4
39.5.5	Invites and Announcement	VI-39-4
39.5.6	Lessons Learned Conference Documents	VI-39-4
39.5.7	Lessons Learned Conference Minutes	VI-39-4
39.5.8	Lessons Learned Conference Website.....	VI-39-4

39.6 Interaction Among Feedback Processes..... VI-39-5
 39.6.1 Relationships VI-39-5
 39.6.2 Consistency..... VI-39-5
 39.7 Lessons Learned Conference Application and Knowledge Sharing VI-39-5
 39.7.1 Communication of Lessons Learned , Barriers and Action Items VI-39-5

Appendices

A Access to Lessons Learned Conference and MMPR Sites on the ST1 Portal..... VI-39A-1

CHAPTER 40 - SUBMARINE MESSAGE REPORTING

40.1 Purpose VI-40-1
 40.2 Background..... VI-40-1
 40.3 Scope VI-40-1
 40.4 Policy VI-40-1
 40.5 Responsibilities VI-40-2
 40.5.1 Type Commanders..... VI-40-2
 40.5.2 Immediate Superior In Command..... VI-40-2
 40.5.3 Ship’s Commanding Officer..... VI-40-2
 40.6 Message Requirements VI-40-3

Appendices

A Sample (SUBS) Initial Message VI-40A-1
 B Sample (SUBS) Update Message VI-40B-1
 C Sample (SUBS) Final/Closeout Message VI-40C-1
 D Sample (SUBS) Shipalt/Tempalt Installation Message VI-40D-1
 E Sample (SUBS) Shipalt/Tempalt Removal Message..... VI-40E-1

CHAPTER 41 - MAINTENANCE AND PROJECT TEAM

41.1 Purpose VI-41-1
 41.2 Maintenance Team..... VI-41-1
 41.2.1 Crew Swap..... VI-41-1
 41.2.2 Maintenance Team Members..... VI-41-1
 41.2.3. The Principal Roles of the Maintenance Team VI-41-2
 41.2.4 Specific Duties of Maintenance Team Members VI-41-3
 41.2.4.1 Ashore Ship’s Maintenance Manager..... VI-41-3
 41.2.4.2 Ship’s Commanding Officer..... VI-41-4
 41.2.4.3 I-Level Ship Superintendent..... VI-41-5
 41.2.4.4 Project Manager..... VI-41-6
 41.2.4.5 Ship’s Material Maintenance Officer VI-41-6
 41.2.4.6 Contractor Program Manager VI-41-7
 41.3 Project Team..... VI-41-8
 41.3.1 Specific Duties of Project Team Members VI-41-9
 41.3.1.1 Project Manager..... VI-41-9
 41.3.1.2 Contract Specialist..... VI-41-13
 41.3.1.3 Quality Assurance Specialist VI-41-14
 41.3.1.4 NSA Logistical Representative VI-41-15
 41.3.1.5 SEA 21 Hull, Mechanical and Electrical and AEGIS Combat Systems On Site Logistician (Surface Force Ships only) VI-41-15
 41.3.1.6 Project Support Engineer..... VI-41-15
 41.3.1.7 Integrated Test Engineer..... VI-41-16
 41.3.1.8 Assessment Director VI-41-17
 41.3.1.9 Technical Matter Expert..... VI-41-17
 41.3.1.10 Shipbuilding Specialist..... VI-41-18
 41.3.1.11 AIT On-Site Installation Coordinator..... VI-41-20

41.3.1.12	AIT Manager	VI-41-20
41.3.1.13	Combat Systems Project Engineer (Surface Force Ships only)	VI-41-20
41.3.1.14	SEA 21 Hull Manager (Surface Force Ships only).....	VI-41-22
41.4	Planning Process Support	VI-41-22
41.5	Planning Board for Maintenance	VI-41-23
41.5.1	Business Rules	VI-41-23
41.6	Work Force Development Program (RMC only).....	VI-41-23
41.7	Integrated Project Team Development (Surface Force Ships only).....	VI-41-24
41.7.1	Program Events.....	VI-41-24

CHAPTER 42 - MATERIAL READINESS ASSESSMENT

42.1	Purpose.....	VI-42-1
42.2	Applicability.....	VI-42-2
42.3	Objectives.....	VI-42-2
42.4	Principles.....	VI-42-2
42.5	Material Assessment Process	VI-42-3
42.5.1	Discussion	VI-42-3
42.5.2	Material Assessments	VI-42-3
42.5.2.1	Submarine TSRA Material Assessments	VI-42-3
42.5.2.2	Surface Force TSRA Material Assessments	VI-42-3
42.5.3	Assessment Authorizing	VI-42-3
42.5.4	Assessment Planning	VI-42-4
42.5.5	Assessment Execution	VI-42-4
42.5.6	Assessment Reporting	VI-42-5
42.5.7	Standard Assessment Tool Kit.....	VI-42-5
42.5.8	Assessment Personnel.....	VI-42-5
42.6	Responsibilities.....	VI-42-6
42.6.1	Fleet Commander.....	VI-42-6
42.6.2	Type Commander	VI-42-6
42.6.3	Material Assessment Executing Activity.....	VI-42-6
42.6.4	Commanding Officer	VI-42-7

Appendices

A	Assessment Process	VI-42A-1
B	“Prerequisites and Test Requirements” Message (Example).....	VI-42B-1
C	“Readiness to Commence” Message (Example).....	VI-42C-1
D	“Completion Quicklook” Message (Example)	VI-42D-1
E	Job Originator Identification Table.....	VI-42E-1

CHAPTER 43 - GUIDANCE FOR ENHANCED MODERNIZATION AND ALTERATION INSTALLATION TEAM INTEGRATION DURING AVAILABILITIES

43.1	Concept.....	VI-43-1
43.2	Availability Planning Business Rules	VI-43-1
43.3	Availability Execution Business Rules	VI-43-2

CHAPTER 44 - MAINTENANCE AND MODERNIZATION PERFORMANCE REVIEW MEETINGS FOR SURFACE FORCE SHIPS

THIS CHAPTER MOVED INTO CHAPTER 39 OF THIS VOLUME

VOLUME VI
FOREWORD
INTRODUCTION

REFERENCES.

- (a) OPNAVINST 3120.32 - Standard Organization and Regulations of the U.S. Navy
- (b) OPNAVINST 4700.7 - Maintenance Policy for U.S. Naval Ships
- (c) COMLANTFLTINST 5400.2 - U.S. Atlantic Fleet Regulations
- (d) COMPACFLTINST 5400.3 - U.S. Pacific Fleet Regulations
- (e) NAVSEAINST 4790.8/OPNAVINST 4790.4 - Ships' Maintenance and Material Management (3-M) Manual
- (f) SSPINST 4720.1 - Policies and Procedures for Alteration of Strategic Weapon System Equipment

LISTING OF APPENDICES.

- A List of Acronyms

1.1 PURPOSE. To provide guidance in the execution and management for maintenance programs applicable to units of the Navy.

- a. The Foreword of this manual contains a master listing of all references used throughout the Joint Fleet Maintenance Manual. These references are arranged in alphanumeric order to facilitate their procurement for use with this manual. References used in specific chapters of this volume are listed at the beginning of each chapter in the order in which they appear in the chapter text.
- b. Acronyms are identified when they are initially used in each chapter of this volume. Appendix A of this chapter contains a master listing of acronyms used throughout all chapters of this volume.
- c. References (a) through (e) shall be used in conjunction with this manual, however, the requirements of this manual shall **not** take precedence over these higher authority directives, or technical directives from applicable Systems Commands (SYSCOM). Where conflicts exist with previously issued Fleet Commander, Commander, Naval Reserve Force (COMNAVRESFOR), Type Commander (TYCOM) letters, transmittals and instructions, other than references (c) and (d), this manual shall take precedence. Conflicts shall be reported to the cognizant TYCOM for resolution.

1.2 SCOPE. This volume applies to all ships and shore activities under the cognizance of Commander, Atlantic Fleet (COMLANTFLT), Commander, Pacific Fleet (COMPACFLT) and COMNAVRESFOR. This volume is not intended to be all encompassing, since the guidance for many elements of the maintenance programs and their execution are promulgated by higher/technical authority (e.g., Naval Ships' Technical Manuals (NSTM), Office of the Chief of Naval Operations Instruction (OPNAVINST)).

- a. This volume contains general programs applicable to all ships and units under the cognizance of COMLANTFLT or COMPACFLT. In those cases where chapters, sections and/or paragraphs of chapters are not applicable to certain Forces, an applicability statement has been used for clarification.
- b. Equipment under the cognizance of Naval Sea Systems Command Nuclear Propulsion Directorate (NAVSEA 08) is maintained in accordance with NAVSEA 08 directives.
- c. Nuclear-Powered Ballistic Missile Submarine (SSBN) Strategic Weapon System (SWS) and Nuclear-Powered Guided Missile Submarine (SSGN) Attack Weapons Systems (AWS) equipment under the cognizance of Strategic Systems Programs (SSP) is operated, maintained, modified and/or modernized in accordance with approved SSP directives/instructions.
 - (1) Reference (f) defines policies, controls, processes and procedures for the accomplishment of all SSP Alterations (SPALT) issued by the Director, Strategic Systems Programs for all SSP cognizant equipment on both SSBNs and SSGNs. Reference (f) further defines the methodology and processes to plan, document, coordinate, install, and test SWS/AWS hardware, software and/or modernization SPALTs.

- (2) Adherence to reference (f) ensures that all related or affected Equipment, Fleet Documentation, Training, Logistic and Maintenance functions under the cognizance of SSP are fully integrated as part of the SPALT. Only SSP authorized SWS/AWS SPALTs are installed on SSBNs and SSGNs.
- (3) Applicable and required local support services such as Crane, Riggers, Power Isolation/Tag-Out, Hazardous Material, Quality Assurance/Critical Skill requirements, etc., for the conduct of a SPALT shall be identified within the Director, Strategic Systems Programs SPALT document, related Ordnance Document, and/or SPALT installation pre-brief. This information shall be communicated/provided to all involved and affected local activities in accordance with the SPALT process no later than forty-five (45) days prior to the conduct of a SPALT, as outlined and defined within reference (f).
- (4) As SSP Contractor/Government Team shall provide the required operational and engineering support for all SPALT, Maintenance and Repair Activities to SWS/AWS equipment under the cognizance of SSP. The respective responsibilities of SSP Contractor/Government Teams, the Fleet Maintenance Activity and other local Commands for the execution of the SSP SPALT program shall be documented in an overarching Memorandum of Agreement in order to define areas of responsibility for all activities involved in the accomplishment of authorized alterations in a timely, efficient, and coordinated manner.

1.3 CHANGES AND CORRECTIONS. Changes and corrections will be issued as required. Comments and suggestions for improving or changing this volume are invited. Address comments, recommendations, and requested changes to Submarine Maintenance Engineering, Planning and Procurement (SUBMEPP) Activity utilizing the change request form located in the front of this manual. If changes are submitted in electronic format, facsimile or E-mail, each change request shall contain the information required on the change request form.

1.4 REQUEST FOR COPIES OF THE MANUAL. Activities on distribution for the Joint Fleet Maintenance Manual (JFMM) that require additional copies or activities wanting to be added to distribution should submit a letter to their applicable TYCOM, identifying CD-ROM/paper requirements along with justification for the request. To the maximum extent possible, technical publications libraries at each activity will receive all copies of the manual for that activity and coordinate local distribution and updates.

APPENDIX A
LIST OF ACRONYMS

2-Kilo	3-M Maintenance Action Form
2M	Miniature/Microminiature
3-M	Maintenance and Material Management
3-MC	Maintenance and Material Management Coordinator
3-MPR	3-M Performance Rate
A&I	Alteration and Improvement
ACAT	Acquisition Category
ACCCIT	Aircraft Carrier Climate Control Investigating Team
ACF	Accomplishment Confidence Factor
ACN	Advance Change Notice
ACO	Administering Contracting Officer
ADP	Automated Data Processing
AEL	Allowance Equipage List
AER	Alteration Equivalent to Repair
AERP	Advanced Equipment Repair Program
AF	Advance Funding
AFOM	Alteration Figure of Merit
AIMD	Aviation Intermediate Maintenance Department
AIS	Automated Information Systems
AIT	Alteration Installation Team
Ao	Operational Availability
AOR	Area of Responsibility
AP	Advance Planning
APL	Allowance Parts List
APPN/PE	Appropriation/Preliminary Engineering
ARRS	Analysis, Records and Reports Section
ASI	Automated Shore Interface
ASTM	American Society for Testing and Materials
ATE	Automated Test Equipment
AWP	Availability Work Package
AWR	Automated Work Request
AWS	Attack Weapons Systems
BAF	Business Adjustment Factor
BART	Beartrap Acoustic Radiated Trials
BAWP	Baseline Availability Work Package
BCA	Business Case Analysis
BCE	Battery Charging Electrician
BCEF	Battery Charging Electrician Forward
BCR	Billet Change Request
BER	Beyond Economical Repair
BRB	Battery Record Book
BSC	Balanced Score Card
C4I	Command, Control, Communications, Computers and Intelligence
C5IMP	C5ISR Modernization Process
C5ISR	Command, Control, Communications, Computer, Combat Systems, Intelligence, Surveillance and Reconnaissance
C5RA	Command, Control, Communications, Computers and Combat Systems
CAL STD	Readiness Assessment Calibration Standard

CAQAP	Contract Administration Quality Assurance Program
CAR	Corrective Action Request
CAS	Contract Administration Services
CASCAN	CASREP Cancellation or Cancellation of Casualty Report
CASCOR	CASREP Correction or Correction of the Casualty in the Casualty Report
CASREP	Casualty Report
CBA	Cost Benefit Analysis
CCA	Commercial Calibration Activity
CCT	Customer Contract Team
CD-ROM	Compact Disk - Read Only Memory
CEIPRP	Continuous Estimating Incremental Planning Review Process
CFOSS	Cargo Fuel Operational Sequencing System
CFT	Cross Functional Team
CHENG	Chief Engineer
CM	Continuous Maintenance
CMAV	Continuous Maintenance Availability
CMF	Confidence Management Factor
CMO	Contract Management Office
CMP	Class Maintenance Plan
CNO	Chief of Naval Operations
CNRMC	Commander, Navy Regional Maintenance Center
COMUSFLTFORCOM	Commander, United States Fleet Forces Command
COMLANTFLT	Commander, Atlantic Fleet
COMLOGWESTPAC	Commander Logistics Western Pacific
COMNAVAIRFOR	Commander Naval Air Forces
COMNAVAIRLANT	Commander Naval Air Force Atlantic
COMNAVAIRPAC	Commander Naval Air Force Pacific
COMNAVAIRSYSCOM	Commander, Naval Air Systems Command
COMNAVRESFOR	Commander Naval Reserve Force
COMNAVSEASYSYSCOM	Commander, Naval Sea Systems Command
COMNAVSURFGRUMIDPAC	Commander Naval Surface Group Middle Pacific
COMNAVSURFGRUPACNORWEST	Commander Naval Surface Group Pacific North West
COMNAVSURFLANT	Commander Naval Surface Force Atlantic
COMNAVSURFOR	Commander Naval Surface Forces
COMNAVSURFPAC	Commander Naval Surface Force Pacific
COMPACFLT	Commander, Pacific Fleet
COMPATRECONFORLANT	Commander Patrol Reconnaissance Forces Atlantic
COMPATRECONFORPAC	Commander Patrol Reconnaissance Forces Pacific
COMSPAWARSSYSCOM	Commander, Space and Naval Warfare Systems Command
COMSUBGRU	Commander Submarine Group
COMSUBLANT	Commander Submarine Force Atlantic
COMSUBPAC	Commander Submarine Force Pacific
COMSUBRON	Commander Submarine Squadron
COMUSFLTFORCOM	Commander United States Fleet Forces Command
COSAL	Coordinated Shipboard Allowance List
CPARS	Contractors Performance Appraisal Reporting System
CPO	Chief Petty Officer
CPR	Calibration Problem Report
CQA	Contract Quality Assurance
CREI	Cost Reduction and Effectiveness Improvement
CRES	Corrosion Resistant Steel
CRL	Calibration Requirements List
CS	Combat Systems
CS/CCS	Command and Control Systems
CSMP	Current Ship's Maintenance Project
CSP	Commercial Service Provider

CSPE	Combat Systems Project Engineer
CTL	Class Team Leader
CTRA	Consolidated TMDE Readiness Assessment
CVF	CSMP Validity Factor
CVN	Nuclear Powered Aircraft Carrier
CWP	Controlled Work Package
CYBERFOR	Cyber Force
DCMA	Defense Contract Management Agency
Det/DET	Detachment
DFS	Departure From Specification
DIRSSP	Director, Strategic Systems Programs
DLR	Depot Level Repairable
DMP	Depot Modernization Period
DO	Duty Officer
DoD	Department of Defense
DPP	Deployment Preparation Period
DRRS	Defense Readiness Reporting System
DS	Dry Deck Shelter
DSN	Defense Switched Network
DSRA	Dry-Docking Selected Restricted Availability
DSS	Deep Submergence System
EDO	Engineering Duty Officer
EGL	Equipment Guide List
EIC	Equipment Identification Code
EM	Electronic Module
EMC	Electromagnetic Compatibility
EMI	Electromagnetic Interference
EMO	Electronics Material Officer
EOC	Equipment Operational Capability
EPCP	Electric Plant Control Panel
EPY	Expanded Planning Yard
EQOL	Enhanced Quality Of Life
ERR	Engineering Readiness Review
ESC	Executive Steering Committee
ESD	Electrostatic Discharge
ESL	Equipment Status Log
ETR	Estimated Time to Repair
FC	Field Change
FCA	Field Calibration Activity
FCFBR	Fleet COSAL Feedback Report
FDRMC	Forward Deployed Regional Maintenance Center
FFP	Firm Fixed Price
FLR	Field Level Repairable
FMA	Fleet Maintenance Activity
FMP	Fleet Modernization Program
FMPMIS	Fleet Modernization Program Management Information System
FPY	First Pass Yield
F RTP	Fleet Response Training Plan
FS&L	Food Service and Laundry
FTA	Fleet Technical Assistance
FY	Fiscal Year
GDSC	Global Distance Support Center

GFM	Government Furnished Material
GPETE	General Purpose Electronic Test Equipment
GSI	Government Source Inspection
HIP	Hull Integrity Procedure
HM&E	Hull, Mechanical and Electrical
HMERA	Hull, Mechanical, Electrical Readiness Assessment
HRMC	Hawaii Regional Maintenance Center
HW	Hot Wash
HWAT	Hot Wash Analysis Team
ICAS	Integrated Condition Assessment System
ICCP	Impressed Current Cathodic Protection
ICR	Independent Cost Review
ICV	Individual Cell Voltage
IGE	Independent Government Estimate
ILRRR	Inflatable Life Raft Recertification Record
ILS	Integrated Logistics Support
IMA	Intermediate Maintenance Activity
IMF	Intermediate Maintenance Facility
IMI	Intermodulation Interference
INSURV	Board of Inspection and Survey
IPE	Industrial Plant Equipment
IPTD	Integrated Project Team Development
ISEA	In-Service Engineering Activity
ISIC	Immediate Superior In Command
IT	Information Technology
ITP	Integrated Test Plan
IUID	Item Unique Identification
JCN	Job Control Number
JFMM	Joint Fleet Maintenance Manual
JQR	Job Qualification Requirement
JRMC	Japan Regional Maintenance Center
JSN	Job Sequence Number
LAR	Liaison Action Request
LCAC	Landing Craft Air Cushion
LCM	Life Cycle Manager
LCS	Littoral Combat Ships
LCSRON	Littoral Combat Ships Squadron
LDS	Logistics Data System
LLC	Lessons Learned Conference
LLTM	Long Lead Time Material
LMA	Last Maintenance Action
LMA	Lead Maintenance Activity
LOA	Light Off Assessment
LOD	Letter of Delegation
LOEP	List Of Effective Pages
LSD	Logistics Support Data
LTD	Logistics Technical Data
LWC	Lead Work Center
MACHALT	Machinery Alteration
MARMC	Mid Atlantic Regional Maintenance Center
MAT	Maintenance Assist Team

MCF	MDS Confidence Factor
MCMS	METBENCH Calibration Management System
MCV	Maximum Corrected Voltage
MDCO	Maintenance Document Control Office
MDS	Maintenance Data System
MDT	Mean Down Time
MEASURE	Metrology Automated System for Uniform Recall and Reporting
METCAL	Metrology and Calibration
MFOM	Maintenance Figure of Merit
MFOM _a	Average Maintenance Figure of Merit
MFOM _w	Weighted Maintenance Figure of Merit
MILCON	Military Construction
MILSPEC	Military Specification
MIP	Maintenance Index Page
MJC	Master Job Catalog
MMBP	Maintenance and Modernization Business Plan
MMP	Major Maintenance Period
MMPR	Maintenance and Modernization Performance Review
MOA	Memorandum of Agreement
MOGAS	Motor Gasoline
MP	Modernization Plan
MPR	MDS Performance Rate
MR	Maintenance Requirement
MRC	Maintenance Requirement Card
MRI	Machine-Readable Information
MRMS	Maintenance Resource Management System
MS	Maintenance Standard
MSDS	Material Safety Data Sheet
MSF	Magnetic Silencing Facility
MSRA	Module Screening and Repair Activity
MSS	Major Shore Spares
MTBF	Mean Time Between Failures
MTR	Module Test and Repair
MTRF	Module Test and Repair Facility
NACE	National Association of Corrosion Engineers
NAMTS	Navy Afloat Maintenance Training Strategy
NAVAIR	Naval Air Systems Command
NAVICP	Naval Inventory Control Point
NAVSEA	Naval Sea Systems Command
NAVSEA 08	Naval Sea Systems Command Nuclear Propulsion Directorate
NAVSEALOGCEN	Naval Sea Logistics Center
NAVSUP	Naval Supply Systems Command
NC	Critical Noise Deficiency
NCR	No Calibration Required
NDE	Navy Data Environment
NDE-NM	Navy Data Environment-Navy Modernization
NDT	Nondestructive Testing
NEC	Navy Enlisted Classification
NFE	No Fault Evident
NIIN	National Item Identification Number
NMD	Navy Maintenance Database
NMP	Navy Modernization Process
NP	Potential Noise Deficiency

NPBI	NAVSEA Paint Basic Inspector
NPV	Net Present Value
NRMD	Nuclear Regional Maintenance Department
NRPO	Noise Reduction Petty Officer
NSA	Naval Supervisory Authority
NSN	National Stock Number
NSSC	Naval Submarine Support Center
NSTM	Naval Ship's Technical Manual
NSWC	Naval Surface Warfare Center
NSWCCD	Naval Surface Warfare Center, Carderock Division
NSY	Naval Shipyard
NTIRA	Navy Tool for Interoperability Risk Assessment
NUCALT	Nuclear Alteration
NWRMC	Northwest Regional Maintenance Center
OARS	Open Architecture Retrieval System
OEM	Original Equipment Manufacturer
OJT	On the Job Training
OMMS	Organizational Maintenance Management System
OMMS-NG	Organizational Maintenance Management System – Next Generation
OOC	Out Of Commission
OOD	Officer Of the Deck
OPALT	Operational Alteration
OPNAV	Office of the Chief of Naval Operations
OPNAVINST	Office of the Chief of Naval Operations Instruction
OPTAR	Operating Target
OQE	Objective Quality Evidence
ORATA	Other Restricted Availability/Technical Availability
ORDALT	Ordnance Alteration
PARM	Participating Acquisition Resource Managers
PCD	Production Completion Date
PCMS	Passive Countermeasure System
PCP	Process Control Procedures
PDS	Product Data Sheet
PE	Procedure Evaluation
PEO	Program Executive Officer
PEP	Plant Equipment Project
PFR	Periodic Force Revision
PHD	Port Hueneme Detachment
PHNSY	Pearl Harbor Naval Shipyard
PHNSY-IMF	Pearl Harbor Naval Shipyard and Intermediate Maintenance Facility
PIRA	Pre-Inactivation Restricted Availability
PLAD	Plain Language Address Directory
PM	Program Manager
PMR	Periodic Maintenance Requirement
PMS	Planned Maintenance System
PMSCA	Preventive Maintenance System Coordinating Activity
PMT	Performance Monitoring Team
POC	Point of Contact
POM	Pre-Overseas Movement
P-OMMS	Propulsion - Organizational Maintenance Management System
PPE	Personal Protective Equipment
PPR	PMS Performance Rate
PQS	Personnel Qualification Standard

PR	Procedure Review
PRWL	Planned Refit Work List
PSIA	Private Sector Industrial Activity
PSNS	Puget Sound Naval Shipyard
PSNS-IMF	Puget Sound Naval Shipyard and Intermediate Maintenance Facility
PT	Project Team
PVI	Product Verification Inspection
PY	Planning Yard
QA	Quality Assurance
QAR	Quality Assurance Representative
QBR	Quarterly Battery Report
QC	Quality Control
QOS/QOL	Quality of Service/Quality of Life
RAB	Registrar Accreditation Board
RAF	Reporting and Automated Shore Interface Processing Confidence Factor
RAR	Recorded Accomplishment Rate
RCC	Regional Calibration Center
RCM	Reliability Centered Maintenance
RCP	Recommended Change Package
REC	Re-Entry Control
RFI	Ready For Issue
RH	Relative Humidity
RIP	Readiness Improvement Program
RLP	Regional Loan Pool
RMAIS	Regional Maintenance Automated Information System
RMC	Regional Maintenance Center
ROI	Return On Investment
ROV	Repair Other Vessel
RPCCR	Reactor Plant Configuration Change Report
RPPO	Repair Parts Petty Officer
RPSM	Reactor Plant Ship Modification
RSG	Regional Support Group
SC	Ship Change
SCAT	Sub-Category
SCD	Ship Change Document
SCLSIS	Ship's Configuration and Logistics Support Information System
SCN	Ship Conversion Navy
SCP	System Calibration Procedures
SDI	Ship's Drawing Index
SEF	Ship's Equipment File
SEMAT	Systems and Equipment Material Assessment Team
SEMCIP	Shipboard Electromagnetic Compatibility Improvement Program
SEOC	Submarine Engineered Operating Cycle
SERMC	Southeast Regional Maintenance Center
SF	Ship's Force
SFWL	Ship's Force Work List
SG	Specific Gravity
SGCP	Shipboard Gage Calibration Program
SHIPALT	Ship Alteration
SHIPMAIN	Ship Maintenance
SHW	Super Hot Wash
SISCAL	Shipboard Instrumentation System Calibration

SKED	Scheduling Software
SLICR	Ship's Logistics Indicator Computerized Report
SMART	Submarine Modernization and Alteration Requirements Tool
SME	Subject Matter Expert
SNAP	Ship's Non-Tactical Automated Data Processing System
SOC	Scope of Certification
SOS	Source of Support
SOVT	System Operation Verification Testing
SPALT	Strategic Systems Programs Alteration
SPAWAR	Space and Naval Warfare Systems Command
SPETE	Special Purpose Electronic Test Equipment
SPETERL	Ship's Portable Electronic Test Equipment Requirements List
SPM	Ship's Program Manager
SPRUCE	Scheduled Preservation Upkeep Coordinated Effort
SRA	Selected Restricted Availability
SRF	Ship Repair Facility
SRF-JRMC	Ship Repair Facility and Japan Regional Maintenance Center
SSBN	Nuclear-Powered Ballistic Missile Submarine
SSES	Ship Systems Engineering Station
SSGN	Nuclear-Powered Guided Missile Submarine
SSM	Ship Systems Manual
SSP	Strategic Systems Programs
SSPC	Society for Protective Coatings
SSPINST	Strategic Systems Programs Instruction
SSR	Ship's Selected Records
ST1	Surface Team One
STAARS	Submarine Technical Assistance Assessment and Reporting System
STAN	Shipboard Electromagnetic Compatibility Improvement Program Technical Assistance Network
STSC	Submarine Technical Support Center
SUBMEPP	Submarine Maintenance Engineering, Planning and Procurement Activity
SUBSAFE	Submarine Safety
SUPSHIP	Supervisor of Shipbuilding
SUPSHIP NN	Supervisor of Shipbuilding Newport News
SURFMEPP	Surface Maintenance Engineering Planning Program
SURFOR	Surface Force
SWE	Surface Warfare Enterprise
SWLIN	Ship Work List Item Number
SWRMC	Southwest Regional Maintenance Center
SWS	Strategic Weapon System
SYSCOM	Systems Command
TA	Technical Analyst
T/A	Type of Availability
TAAS-INFO	Tech Assist, Assessments and Scheduling Information
TAMS	TYCOM Alteration Management System
TAMS	Test and Monitoring System
TAR	Technical Analysis Report
TAT	Technical Assessment Team
TAVR	Technical Assistance Visit Report
TCV	Total Corrected Voltage
TDC	TYCOM Discretionary Change
TDMIS	Technical Document Management Information System
TEMPALT	Temporary Alteration

TFBR	Technical Feedback Report
TFBR H/T	Technical Feedback Report History Tracking
TMA	Top Management Attention
TMDE	Test, Measurement and Diagnostic Equipment
TMDER	Technical Manual Deficiency/Evaluation Report
TMI	Top Management Issues
TOMA	Technical Onboard Monitoring Assist
T(pf)	Time (problem free)
TPOC	Technical Point of Contact
TPS	Test Program Set
TRF	TRIDENT Refit Facility
TRID	TRIDENT Alteration
TRIPER	TRIDENT Planned Equipment Replacement
TRIREFFAC	TRIDENT Refit Facility
TRS	Technical Repair Standard
TSRA	Total Ship's Readiness Assessment
TVG	Temperature Voltage Gassing
TWH	Technical Warrant Holder
TYCOM	Type Commander
TYKIT	TYCOM Alteration Kit
TZ	Type Zero
UIC	Unit Identification Code
UPCP	Universal Process Control Procedure
URO	Unrestricted Operation
VIDS/MAF	Visual Information Display/Maintenance Action Form
WC	Work Center
WCS	Work Center Supervisor
WCWL	Work Center Work List
WFD	Work Force Development
WFT	Wet Film Thickness
WP	Work Package
WPER	Work Package Execution Review
WPIC	Work Package Integration Conference
WPS	Work Package Supplement
WSS	Weapons System Support

(This Page Intentionally Left Blank)

VOLUME VI**CHAPTER 1****WATERBORNE UNDERWATER HULL CLEANING****REFERENCES.**

- (a) NAVSEA S9086-CQ-STM-010 - NSTM Chapter 081 R4 (Waterborne Underwater Hull Cleaning of Navy Ships)
- (b) NAVSEA 389-0288 - Radiological Controls
- (c) NAVSEA S0600-AA-PRO-010 - Underwater Ship Husbandry Manual

1.1 **PURPOSE.** To implement the program requirements delineated in references (a), (b) and (c) and to provide guidance for waterborne hull cleaning of naval ships. This process applies to all surface force ships, submarines and aircraft carriers.

1.2 **SCOPE.** As stated in reference (a), commercial and Naval experience has demonstrated that appreciable savings in energy are obtainable by maintaining smooth underwater hull and propeller surfaces through periodic waterborne hull cleaning. Additionally, a hull cleaning program provides a means in which hull damage can be detected in early stages and corrective action can be taken. The hull cleaning and propeller polishing requirements of this instruction apply to all ships. It is intended to conserve fuel, restore effectiveness of sonar systems, and reduce ship self-noise, which increases anti-submarine warfare effectiveness. Reference (a) provides necessary criteria, methodology, and guidelines for waterborne underwater ship inspection and cleaning. Reference (a) provides a rating scale for inspecting and reporting fouling, fouling thresholds to initiate cleaning, approved cleaning equipment for various underwater ship systems (i.e., hull sections, appendages, dome, masker/prairie air), cleaning requirements, safety precautions and procedures for cleaning, guidelines for establishing cleaning intervals and documentation and reporting requirements. To meet the objectives of reference (a), special attention will be given to ensure that appropriate action will be taken to clean ships within 30 days of deployment.

1.3 POLICY.

- a. Scheduling of periodic cleaning will be the responsibility of the Type Commander (TYCOM) and accomplished in accordance with reference (a). Full, partial and interim cleaning shall be accomplished by diving activities (military and civilian) certified by Naval Sea Systems Command (NAVSEA) code 00C.
- b. Full hull cleaning will only be accomplished by NAVSEA divers contracted for world wide waterborne underwater hull cleaning services. Interim or partial hull cleaning will be done by a certified navy activity or NAVSEA contracted service.
- c. The execution of waterborne underwater hull cleaning operations shall follow best management practices delineated in reference (c) to maximize hull cleaning effectiveness and to minimize the release of hull cleaning by-products into surrounding waters.

1.4 **RESPONSIBILITIES.** An effective hull cleaning program that ensures the delivery of reliable, environmentally sound, and quality services to the Fleet requires the well-coordinated effort of several organizations. Together, these groups must manage the planning, execution, quality assurance, inspection and condition-reporting functions necessary to ensure the work is performed efficiently and in accordance with technical specifications. Reference (c), Appendix A, Section II specifies the responsibilities for each organization (NAVSEA code 00C, Commander United States Fleet Forces Command, TYCOMs, On-Scene Navy Representative, and the Ship's Chief Engineer) involved in the hull cleaning program.

1.5 **REPORTS.** All waterborne underwater hull cleaning and inspection shall be documented and submitted to the respective TYCOM and NAVSEA 00C for review. Documentation for cleaning submarines shall also be transmitted to SUBMEPP Code 1844. Documentation for cleaning and inspection of aircraft carrier hulls shall also be transmitted to PMS 312C Carrier Planning Activity, Code 22. Inspection results shall be recorded on the standard Diver Hull Inspection Data form (NAVSEA 4730 available on-line at <http://www.supsalv.org>). The inspection documentation may be mailed or electronically stored and transmitted to the appropriate organizations.

Mailing addresses are as follows:

COMNAVSEASYSKOM

Attn: NAVSEA 00C5

1333 Isaac Hull Avenue S.E. Stop 1075

Washington Navy Yard, DC 20376-1075

Commanding Officer

SUBMEPP Activity

PO Box 2500

Portsmouth Naval Shipyard

Portsmouth, NH 03804-2500

Commanding Officer

PEO Carriers PMS 312C

Bldg 33

Portsmouth, VA 23709-5091

VOLUME VI

CHAPTER 2

FLEET TECHNICAL ASSISTANCE

REFERENCES.

- (a) COMUSFLTFORCOM/COMPACFLTINST 3501.3 - Fleet Training Continuum
- (b) OPNAVINST 3000.15 - Fleet Response Plan (FRP)

LISTING OF APPENDICES.

- A Area Regional Maintenance Center Fleet Technical Assistance Contact Information
- B Sample Technical Assistance Visit Report (TAVR) Message
- C Sample E-MAIL Technical Assistance Visit Report (E-TAVR)

2.1 PURPOSE. This chapter provides policy, procedures and guidance regarding utilization of Fleet Technical Assistance (FTA) program resources in support of all surface ships, aircraft carriers, submarines and craft. Commander, U. S. Fleet Forces Command and Commander, U.S. Pacific Fleet (COMPACFLT) Fleet Maintenance Officers (N43) will ensure that appropriate Fleet resources are available to provide technical assistance to the Naval operating forces under their cognizance.

2.2 FLEET TECHNICAL ASSISTANCE DEFINITION. FTA is the help that surface ships, aircraft carriers, submarines and craft request when they are unable to resolve equipment or software deficiencies using their own ships resources or other means available within their Strike Group. Paragraph 2.4.2 of this chapter lists FTA program exclusion items. Use of Regional Maintenance Center (RMC) or RMC-obtained resources for other purposes, such as non-Ship's Force repairs, assessments, Board of Inspection and Survey inspections, etc., is not considered FTA but is addressed elsewhere in this manual or other policy guidance. All FTA requests will be responded to by the RMCs as defined in paragraph 2.4.1 of this chapter.

2.3 FLEET TECHNICAL ASSISTANCE EXCLUSION AREAS. RMCs are not responsible for technical assistance in the following areas:

- a. Naval Sea Systems Command (NAVSEA) 08 cognizant equipment.
- b. TRIDENT missile weapons systems.
- c. Aircraft.
- d. Catapults and arresting gear - Aircraft Launch and Recovery Equipment.
- e. Ordnance and munitions.
- f. Submarine Safety systems/components.
- g. Nuclear weapons.
- h. Special clearance carry-on equipment.
- i. Undersea and land-based surveillance equipment.
- j. Flight deck certification related systems and equipment.
- k. Diver life support systems.
- l. Non-Program of Record (pre-prototype) programs.
- m. Naval Supply Systems Command (NAVSUP) (e.g., Navy Cash)
- n. Navy Personnel Command (NAVPERS) (e.g., RAPIDS, MIAP, NSIPS)

2.4 FLEET TECHNICAL ASSISTANCE POLICY.

NOTE: WHEN CONTACTING THE NAVY 311 OR AN AREA RMC, UTILIZE SECURE COMMUNICATIONS AS APPROPRIATE TO MAINTAIN SECURITY OF CLASSIFIED EQUIPMENT AND OPERATIONAL PARAMETERS.

2.4.1 Requesting Assistance. It is important that ships develop and exercise self-sufficiency for shipboard system maintenance to the fullest extent possible. If unable to resolve a technical problem internally, or by other means available within their Strike Group, the ship shall contact the Navy 311, who will route their request to the cognizant Area RMC. If unable to contact the Navy 311, contact the Area RMC and follow up with Navy 311 when able. Ships will use the following specific procedures when requesting FTA:

- a. When a technical assistance requirement is identified, contact the Navy 311 as described in paragraph 2.4.1.b of this chapter. The Navy 311 will then record the FTA request and forward to the appropriate RMC as outlined in paragraph 2.7.2 of this chapter using the contact information in Appendix A. Provide pertinent information listed in paragraph 2.4.2 of this chapter.
- b. Navy 311 can be contacted 24-hours a day via the worldwide web, by E-mail, via Naval message or via toll-free numbers as follows:
 - (1) SIPR Web site: <https://www.navy311.navy.smil.mil/navy311/>
 - (2) NIPR Web site: <http://www.navy311.navy.mil/>
 - (3) SIPR E-mail: Navy311@Navy.Smil.Mil
 - (4) NIPR E-mail: Navy311@Navy.Mil
 - (5) Message PLAD: NAVY THREE ONE ONE NORFOLK VA
 - (6) Telephone: Comm 1-855-NAVY-311 (1-855-628-9311), DSN 510-NAVY-311 (510-628-9311)

2.4.2 Required Fleet Technical Assistance Request Information. A Casualty Report (CASREP) solely to establish an FTA, is not required. When requesting Technical Assistance, the following information is **necessary** to assist in a timely and accurate response:

- a. Job Control Number (JCN) (required) and Casualty Report (if applicable) numbers.
- b. Equipment identification: (Noun name, nomenclature, model, MK/MOD, etc.).
- c. Equipment failure mode: Detailed description of the nature of failure or casualty, including symptoms and operational condition at time of casualty, current symptoms and indications and any other relevant information available to assist in diagnosing the problem.
- d. Repair actions taken to date: [Include any extra-unit assistance (e.g., Ship Repair Facility, Tender, etc.)].
- e. Parts status: (Indicate spare parts required, estimated delivery date, document numbers, document status, etc., if known).
- f. Technical manual: (NAVSEA/NAVSHIPS/NAVORD Technical manual number or Commercial Off-The-Shelf manufacturer's publication identification, if available).
- g. Dates: (Include earliest through latest possible dates assist is required. Provide alternate dates if possible).
- h. Location: (Country, port, Naval Base, pier, berth, etc.).
- i. Contact information: (Ship/staff Point of Contact name(s) and rate/rank, DSN/INMARSAT/commercial phone numbers, FAX number, SIPRNET/NIPRNET E-mail addresses).
- j. Manufacturer of equipment for which assistance is required (if known).
- k. Equipment Allowance Parts List/Record Identification Number.
- l. Commanding Officer assessment as to effect on ship's mission in the event Distance Support is unsuccessful.

2.4.3 Chief of Naval Operations Availability Fleet Technical Assistance Procedures. Fleet units may request technical assistance while in a Chief of Naval Operations scheduled maintenance availability. The request must be submitted to the cognizant Area RMC, which will coordinate with the appropriate Naval Supervising Authority (NSA) (if not the same as the cognizant Area RMC) for technical assistance related to systems/equipment that are under the NSA's cognizance or are part of an availability work package. When the cognizant Area RMC is the NSA, the RMC will provide technical support. If not the NSA, the cognizant Area RMC may also do so, as necessary/coordinated with the NSA.

2.4.4 Initial Response. The initial response to all FTA requests will be via Distance Support. If the Operational Commander or Type Commander (TYCOM) determines on-site support is necessary, it is incumbent on them to inform the cognizant area RMC that on-site support is required.

2.4.5 On-Site Support. In a port without a RMC or underway, if Distance Support is determined unsuccessful by the RMC, the Operational Commander or TYCOM will determine whether the cognizant Area RMC will transition to on-site assistance. In a port with a RMC, the RMC may determine transition to on-site support, as prioritized by guidance in paragraph 2.7.4a. of this chapter.

2.5 COMPLETION.

NOTE: THERE WILL BE OCCASIONS WHEN AN UNDERWAY SHIP MAY NOT REQUIRE ALL SYSTEMS TO BE FULLY OPERATIONAL. SUCH SYSTEM DEFICIENCIES MAY BE THE SUBJECT OF A CASREP OR THEY MAY ONLY BE DOCUMENTED IN THE SHIP'S CURRENT SHIP'S MAINTENANCE PROJECT.

2.5.1 Fleet Technical Assistance Completion. To complete the FTA the ship must concur that the cognizant RMC has completed one of the following:

- a. The fault is resolved.
- b. Parts identified to resolve the fault.
- c. Original fault troubleshooting is complete and the deficiency is identified (i.e., Ship understands what needs to be repaired).

2.5.2 Transition to Repair. A completed FTA may require a subsequent deferral (TA-1, TA-2) for repair activity action or Ship's Force corrective maintenance (TA-4).

2.6 RESPONSIBILITIES.

2.6.1 Ship's Commanding Officer. Ship's Commanding Officer will:

- a. Ensure all FTA requests are accurate, complete and timely.
- b. Ensure all FTA requests reference a JCN and contain a detailed problem description in accordance with paragraph 2.4.2 of this chapter to enable technical assistance personnel to adequately research the problem and provide timely and accurate technical assistance. Ensure the 2-kilo is up-lined.
- c. For FTA requests associated with systems that are not required to meet current/projected mission tasking, ensure associated CASREP and/or 2-Kilo address whether or not on-site assistance will be required if Distance Support is unable to resolve the issue.
- d. Ensure that TYCOM, Immediate Superior In Command (ISIC) and Operational Commander are kept informed of technical issues and technical assistance requests in accordance with existing guidance.
- e. While a ship is underway or in another port without a RMC, ensure Distance Support alternatives are exhausted before on-site technical assistance is requested. This policy is in place to ensure satisfactory crew and technical assistance personnel Distance Support procedure training and proficiency so they are able to efficiently use Distance Support when the ship is deployed.
- f. Ensure Ship's Force technicians who are qualified on the systems/equipment in question are available to support technical assistance personnel.
- g. Immediately upon completion of an on-site FTA visit per paragraph 2.5.1 of this chapter, the Fleet unit will release the FTA personnel. When redirection of the same personnel to other problems is desired, the Fleet unit will coordinate with the cognizant Area RMC.

- h. Ships will establish a central, secure E-mail account that will be available to all appropriately cleared technical assistance personnel who visit the ship. The account will be used by visiting technical representatives to communicate with their home office or detachment for technical support/information. The account will be RMCTECHASSIST@Ship.navy.smil.mil where "Ship" is the name of the vessel.
- i. Ship will issue arrival/departure message keeping all apprised of technical representative movement.

2.6.2 Regional Maintenance Center Commanders. RMC Commanders will ensure:

- a. Sufficient capability exists to provide timely response to all requests for technical assistance, either with RMC personnel or other sources of support. The RMC is responsible for coordinating the response from other sources of support as detailed in paragraph 2.6.3 of this chapter.
- b. RMC mission funds are used to fund all FTA efforts in accordance with paragraph 2.7.4 of this chapter.
- c. Technical support is provided to Fleet units in accordance with this directive. In the event there is a work priority conflict, the Area RMC will coordinate resolution with the appropriate TYCOM, Operational Commander or Fleet Maintenance Officer Staff, as necessary.
- d. The initial response to FTA requests is via Distance Support whether in port or at-sea. The use of Distance Support while the ship is in a port with a RMC is encouraged, although not required. It is a tool that can be utilized by the RMC in order to prioritize work assignments and service a wider customer base. On-site support while a ship is in a port with a RMC can allow for quicker identification of the problem and training of Ship's Force technicians. When Distance Support fails to meet the requirements of paragraph 2.5.1 of this chapter, the distance support provider will notify the cognizant Area RMC at the earliest opportunity. The cognizant Area RMC will determine what level of additional support is required and if on-site assistance is appropriate, based on guidance in paragraph 2.7.4.1 of this chapter. If appropriate, the Area RMC will provide on-site FTA from RMC resources or coordinate provision of on-site support from other government/contractor organizations as discussed in paragraph 2.6.3 of this chapter.
- e. Personnel responding to a request for technical assistance are thorough in their review of the specific technical problem, including system trouble shooting, fault isolation, root cause analysis, failed parts identification, logistic support and system restoration assistance while imparting the maximum amount of onboard maintenance training to Ship's Force personnel. Troubleshooting shall be conducted in accordance with Volume V, Part I, Chapter 2, paragraph 2.4 of this manual.
- f. Acknowledgment and response to all FTA requests within 24 hours, via phone conversation, e-mail or Naval Message.
- g. Personnel providing on-site technical assistance keep the cognizant ship's department head or designated representative informed of the scope of the problem and the recommended corrective action.
- h. A message Technical Assistance Visit Report (TAVR) (Naval), in the format provided in Appendix B, is required at the completion of an on-site FTA anytime one or more of the following criteria are met:
 - (1) Personnel or Equipment safety issue.
 - (2) Submarine FTA.
- i. An E-mail TAVR (E-TAVR), in the format provided in Appendix C, is required at the completion of an on-site FTA on Surface Force Ships/Carriers anytime one or more of the following criteria are met:
 - (1) C3/C4 CASREP.
 - (2) Repetitive system/equipment failure and/or long term improvement recommendations.
 - (3) FTA responsibility passed to another RMC or other Source of Support.
 - (4) Loss of mission capabilities. (e.g., AAW, MOB, ASW).
 - (5) Significant follow-on repair recommendations.
 - (6) High visibility.

- j. Task other Source of Support provider who responds to an on-site FTA, coordinated by his/her RMC, to submit a TAVR as required by paragraph 2.6.3.e of this chapter or task them to provide the technical information necessary for the cognizant RMC to generate a TAVR.
- k. Submission of a message report if an on-site assist visit is terminated. Technicians who are not adequately supported by Ship's Force personnel shall immediately notify the ISIC/TYCOM. If the lack of support by Ship's Force personnel cannot be resolved, then the technicians are authorized to depart the ship and terminate the visit. Termination of the ship visit under these circumstances will be detailed in a follow-up message to the appropriate TYCOM/ISIC with information to the appropriate Fleet Commander (N43).
- l. Except for Ship Repair Facility (SRF) - Japan Regional Maintenance Center (JRMCM), track all requests for FTA using approved FTA software. Currently, this is the Tech Assist, Assessments and Scheduling Information (TAAS-INFO) for surface ships, and Submarine Technical Assistance Assessment and Reporting System (STAARS) for submarines.
- m. Ensure Submarine Warfare Federated Tactical System/Non-Propulsion Electronic System technicians providing FTA to submarines with systems/subsystems/equipment postured at the Sensitive Compartmented Information level are eligible for access to Sensitive Compartmented Information based on a current Single Scope Background Investigation.

2.6.3 Other Source of Support Providers. Other source of support providers include any non-Area RMC activity that responds to a technical assistance request. Examples of other source of support providers include: Naval Warfare Center, Original Equipment Manufacturer, commercial repair firms, Systems Command, non-RMC Naval Shipyard, Propulsion Plant Engineering Activity, etc. Other source of support providers will:

- a. Acknowledge receipt of FTA assignment to the tasking Area RMC and the requesting unit.
- b. First, use Distance Support to resolve the problem. Provide the tasking Area RMC with timely Distance Support status and results.
- c. Coordinate with the tasking Area RMC and execute an on-site technical assist if Distance Support is unable to resolve the problem. Ensure personnel providing on-site technical assistance are thorough in their review of the specific technical problem, including system trouble shooting, fault isolation, root cause analysis, failed parts identification, logistic support and system restoration assistance, while imparting the maximum amount of onboard maintenance training to Ship's Force personnel.
- d. Ensure that personnel providing on-site technical assistance keep the cognizant ship's department head or designated representative and Area RMC informed of the scope of the problem and the recommended corrective action.
- e. At the completion of on-site technical assistance, comply with administrative requirements addressed in paragraph 2.8 of this chapter within 5 working days of the visit completion.

2.6.4 Navy 311 Fleet Technical Assistance Request Processing Procedure. Initial FTA requests received by the Navy 311 will be recorded by a Customer Service Representative. The Customer Service Representative must ensure the request is sent to the cognizant Area RMC (if different from the homeport RMC) and notify the cognizant area RMC. This will enable the cognizant Area RMC to commence immediate action on the FTA request.

2.7 REGIONAL MAINTENANCE CENTERS.

2.7.1 Regional Maintenance Centers. RMCs will serve as the primary source of Fleet Technical Assistance. For purposes of this specific FTA policy, use of the term "RMC" includes Regional Support Group New London and TRIDENT Refit Facility Kings Bay since these two activities will be serving as "Area RMCs" in providing FTA as noted in Table 2-1 of this chapter.

2.7.2 Area Regional Maintenance Center Area of Responsibility Assignments. Area RMC Area of Responsibility (AOR) assignments are listed in Table 2-1 below. Figure 2-1 graphically supplements Table 2-1 in depicting the AOR for each RMC. The AOR in which a ship is operating at the time an FTA request is initiated will dictate which Area RMC is responsible for coordinating/providing that FTA (becomes the "cognizant Area RMC"). If a ship is located in an AOR other than their homeport AOR, and the ship initiates a routine FTA request (one that does

not require the cognizant Area RMC to expend travel or overtime funds for on-site support in the event Distance Support is unsuccessful), the homeport Area RMC will assume cognizance of that FTA request and accomplish it as a routine priority via Distance Support or, if necessary, via on-site FTA when the ship returns to homeport.

AREA RMC	AREA OF RESPONSIBILITY (AOR)
Southwest Regional Maintenance Center (SWRMC), San Diego, CA	Ships, SSNs*, aircraft carriers and craft in port or operating off the U.S. West Coast from the San Francisco Bay area south to the southern point of South America and selected mine warfare systems worldwide.
Puget Sound Naval Shipyard & Intermediate Maintenance Facility (IMF), Bremerton, WA	Ships, SSNs, aircraft carriers and craft in port or operating in the PACNORWEST area from North of San Francisco, CA, to northern Pacific/Alaska area and all SSBN/SSGN units in PACFLT.
Pearl Harbor Naval Shipyard & IMF, Pearl Harbor, HI	Ships, aircraft carriers, craft and SSN 688 and SSN 774 Class submarines in port or operating in the MIDPAC area and all non-SSBN/SSGN submarines (excluding SSN 21 Class) and submarine tenders operating in the Seventh Fleet AOR (excluding those SSN 688 and SSN 774 Class submarines operating in port or operating out of Diego Garcia, UK).
Ship Repair Facility (SRF) and Japan Regional Maintenance Center (JRMCM), Yokosuka, Japan	Ships, aircraft carriers and craft in port or operating in the Seventh Fleet AOR.
Mid-Atlantic Regional Maintenance Center (MARMC), Norfolk, VA	Ships, aircraft carriers and craft in port or operating in the Atlantic Ocean from Charleston, SC, latitude northward extending to the Azores longitude eastward. Submarines* in port and all SSN 688 and SSN 774 Class submarines operating in the Second, Fourth, Fifth and Sixth Fleet AOR and those submarines operating in port or out of Diego Garcia, UK, excluding those submarines in port or in the Groton and New London, CT regional waters.
Forward Deployed Regional Maintenance Center (FDRMC) Naples, Italy FDRMC Detachment Bahrain FDRMC Detachment Rota, Spain	Ships, aircraft carriers and craft in port or operating from the Azores longitude eastward to include the Fifth Fleet and Sixth Fleet AOR.
Regional Support Group/Submarine Technical Support Center (STSC) Groton, CT	SSN 688 and SSN 774 Class submarines* in port or operating in the Groton/New London, CT regional waters.
TRIDENT Refit Facility, Kings Bay, GA	All Atlantic Fleet SSBN/SSGN units.
Southeast Regional Maintenance Center (SERMC), Mayport, FL	Ships, aircraft carriers and craft in port or operating south of the Charleston, SC latitude in the Atlantic Ocean to the southern tip of South America.

* Puget Sound Naval Shipyard & Intermediate Maintenance Facility has responsibility for all SSN 21 Class submarines regardless of location.

Table 2-1 RMC Area of Responsibility Assignments

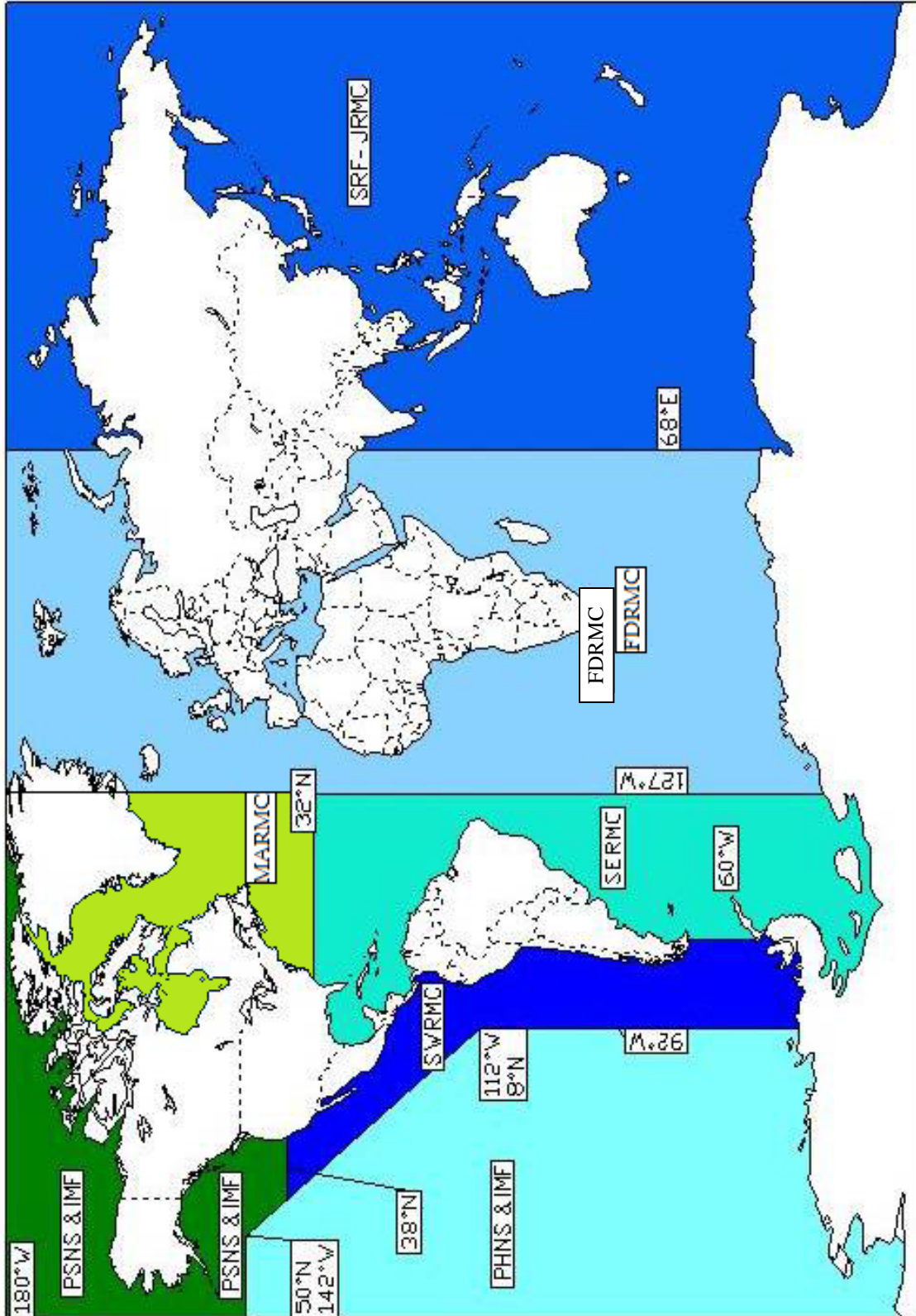

Figure 2-1 RMC Area of Responsibility

2.7.3 Considerations for Providing Assistance.

2.7.3.1 Distance Support. Costs to provide FTA can be dramatically reduced using Distance Support especially when a ship is underway or is not in a port with a RMC. Distance Support may include various forms of two-way communication such as telephone, email, web "chat", streaming video, etc. Additionally, its use has facilitated more effective use of limited technical resources to service a larger number of customers more efficiently. Normally, the cognizant Area RMC will have a subject matter expert available to respond to FTA requests via Distance Support, but in the event that such an expert is not readily available, the cognizant Area RMC is encouraged to contact another Area RMC to enlist their assistance in providing such Distance Support. In support of the Chief of Naval Operation's guidance to shift away from a risk averse culture in the Navy, not all FTA requests will be responded to with on-site support. However, the Operational Commander or TYCOM may direct immediate on-site support, if warranted.

2.7.3.2 On-Site Support. If the use of on-site support is warranted, the cognizant Area RMC will provide or obtain personnel to affect on-site assistance. When a ship transits from one AOR to another, the cognizant area RMC will validate the need for on-site support before transitioning from Distance Support provided by the homeport. The cognizant Area RMC will take into account the ship's operational schedule, as well as ship, ISIC, Operational Commander and TYCOM requirements, when determining if and at what point to shift from Distance Support to on-site support. Paragraph 2.7.4.1 of this chapter provides additional specific guidance regarding when on-site support will be provided and the prioritization of such responses should there be multiple requirements for the same FTA support personnel.

2.7.3.3 Fleet Technical Assistance Support Transfer and Acceptance. The cognizant Area RMC is responsible for providing or obtaining FTA support and is responsible for its completion. If the cognizant area RMC has neither the capability nor capacity to provide the FTA support required, the cognizant RMC will request FTA support from another source of support.

2.7.3.4 Transferring Regional Maintenance Center. The RMC transferring the FTA will transmit a TAVR via appropriately classified email or Naval message, using the samples provided as Appendix B or C of this chapter, synopsising actions taken to date on the FTA after reaching agreement with another source of support to accept responsibility for the FTA. The accepting source of support and new Point of Contact information will be identified in the TAVR. For Surface Ships and Carriers, the transferring RMC will document all time and actions taken and will pass the task to the accepting source of support in approved FTA software. For submarines, the ship's homeport will broker the 2-kilo to the accepting source of support.

2.7.3.5 Accepting Source of Support. The accepting source of support for the FTA assumes responsibility to provide the necessary support to resolve the FTA. If the source of support cannot resolve the FTA, they shall request the cognizant Area RMC obtain the necessary support to resolve the FTA. The accepting source of support will also document all time and actions taken related to the FTA, and inform the cognizant Area RMC on the status of the FTA.

2.7.3.6 Support Coordination. If another source of support is required, close coordination should be maintained between the supporting activity providing such assistance and the cognizant Area RMC to ensure the highest level of responsiveness is being provided. Assistance from another Area RMC does not abrogate the cognizant Area RMC's responsibility to ensure completion of the FTA request and the cognizant Area RMC retains full responsibilities as outlined in this manual.

2.7.4 Funding.

- a. Expenditure of funds for on-site FTAs has been significantly reduced by increased use of Distance Support. The source selection to provide on-site FTA must consider overall resource availability and total cost to the Government (e.g., labor, travel, per diem, administration, etc.) balanced against criticality of need and required speed of response. Resources to meet on-site FTA needs should be considered in the following priority order:
 - (1) cognizant Area RMC personnel.
 - (2) other Area RMC personnel.
 - (3) other government resources.

- (4) private sector.
- b. If personnel from another Area RMC are used to support the FTA requirement, the Area RMC providing the personnel will pay all costs for those personnel including base salary, overtime, travel and per diem. For all other sources of support, the cognizant Area RMC will pay all costs for providing the on-site support. Area RMCs will notify the Fleets if their total FTA related expenditures in support of ships home ported in other RMC locations become significant. The Fleets will review these submissions and determine if funds transfer(s) are required to ensure RMC mission completion.

NOTE 1: IN ACCORDANCE WITH REFERENCE (a), FORWARD DEPLOYED NAVAL FORCES UNDER C7F CONTINUOUSLY OPERATE WITHIN THE INTEGRATED/ SUSTAINMENT PHASE OF THE SEVENTH FLEET TRAINING PLAN IN SUPPORT OF REFERENCE (b) UNLESS IN A CNO AVAILABILITY.

NOTE 2: IF U.S. COAST GUARD OR FOREIGN NAVY VESSELS ARE PART OF A CARRIER STRIKE GROUP OR EXPEDITIONARY STRIKE GROUP, EITHER IN WORK-UP PHASE OR DEPLOYMENT, THEY WILL RECEIVE FTA SUPPORT PRIORITIZATION AS THOUGH THEY WERE UNITED STATES NAVY SHIPS (PRIORITIES 1-7 APPLY). REIMBURSEMENT FOR ALL COSTS TO PROVIDE SUCH FTA SERVICES WILL BE IN ACCORDANCE WITH THE MEMORANDUM OF AGREEMENT/MEMORANDUM OF UNDERSTANDING THAT IS NORMALLY SIGNED BETWEEN THE SERVICES/GOVERNMENTS WHEN SUCH JOINT OPERATIONAL ARRANGEMENTS EXIST.

2.7.4.1 On-Site Support. If Distance Support is unsuccessful or if the nature of the FTA request warrants immediate transition to on-site support, the cognizant Area RMC will coordinate and provide such on-site support as prioritized below:

Priority 1 - Casualties requiring clear and immediate action to offset personnel safety hazards and/or catastrophic equipment damage.

Priority 2 - Services to deployed ships. If resource constrained when there are multiple requirements to provide on-site support to deployed ships, prioritization of response will be:

- (1) SSBN FTAs;
- (2) FTAs associated with a CASREP as determined by the TYCOM;
- (3) Other FTA requirements as determined by the Operational Commander and TYCOM.

Priority 3 - Services to ships that are classified as within the pre-deployment or post-deployment part of the Sustainment Phase of reference (b). If resource constrained when there are multiple requirements to provide on-site support, prioritization of response will be:

- (1) SSBN FTAs;
- (2) FTAs associated with a CASREP as determined by the TYCOM;
- (3) Other FTA requirements as determined by the Operational Commander and TYCOM.

Priority 4 - Services to ships that are classified as within the Integrated phase of reference (b), or ship's that are classified as Independent Unit Ready for Tasking. If resource constrained when there are multiple requirements to provide on-site support, prioritization of response will be:

- (1) SSBN FTAs;
- (2) FTAs associated with a CASREP as determined by the TYCOM;
- (3) Other FTA requirements as determined by the Operational Commander and TYCOM.

Priority 5 - Services to ships that are classified as within the Basic phase of reference (b). If resource constrained when there are multiple requirements to provide on-site support, prioritization of response will be:

- (1) SSBN FTAs;
- (2) FTAs associated with a CASREP as determined by the TYCOM;
- (3) Other FTA requirements as determined by the Operational Commander and TYCOM.

Priority 6 - Other U.S. Navy FTA requests not addressed in one of the above priorities (e.g., FTA support during Chief of Naval Operations availabilities addressed in paragraph 2.4.3 of this chapter).

Priority 7 - Technical assistance requests from non-Navy organizations (e.g., Coast Guard, U.S. Army, U.S. Air Force, Foreign Military Sales, etc.).

2.8. POST-FLEET TECHNICAL ASSISTANCE ADMINISTRATIVE REQUIREMENTS.

- a. At the conclusion of an on-site technical assistance visit, the cognizant Area RMC representative(s) will assist the ship in completing the 2-Kilo and provide a final debrief to the ship's cognizant Department Head, or his/her designated representative, prior to departing the ship. Information collected for the FTA shall be uploaded to 3M history.
- b. A TAVR is required at the completion of on-site FTA visits as addressed in paragraph 2.6.2.h and 2.6.2.k of this chapter. TAVRs should be submitted within 5 working days of visit completion.

APPENDIX A

**AREA REGIONAL MAINTENANCE CENTER FLEET TECHNICAL ASSISTANCE
CONTACT INFORMATION**

AREA RMC	COVERAGE HOURS	PHONE	E-mail/Message PLADs
Mid-Atlantic Regional Maintenance Center (MARMC) Norfolk, VA	24/7/365	Comm: 757-443-3872 Secure: 757-443-3872, ext 2451 CDO: 757-443-3663	NIPRNET: marmc_tsd@navy.mil SIPRNET: nssa_sipr_tsd@navy.smil.mil MSG PLAD: MARMC NORFOLK VA
Forward Deployed Regional Maintenance Center Naples, Italy (FDRMC NAPLES)	0600-1800 WEEKDAYS 0800-1200 WEEKENDS & HOLIDAYS CDO after hours	Comm: 011-39-081-568-7857 DSN: 314-626-7857 Fax: 011-39-081-568-7866 CDO: 011-39-335-725-1657	NIPRNET: FDRMCNAPLESCDO@EU.NAVY.MIL SIPRNET: FDRMCNAPLESCDO@EU.NAVY.SMIL.MIL MSG PLAD: FDRMC NAPLES IT//
FDRMC Detachment Bahrain	Hours: 0730-1600 Sunday-Thursday (TD available after normal hours)	Comm: 011-973-17-853-777 DSN: 318-439-3777 TD: 011-973-3-945-9128 Fax: 011-973-17-854-447	NIPRNET: M-BA-FDRMCBAHASST@ME.NAVY.MIL SIPRNET: M-BA-FDRMCBAHASST@ME.NAVY.SMIL.MIL MSG PLAD: FDRMC DET BAHRAIN//
FDRMC Detachment Rota, Spain	Hours: 0730-1600 Monday-Friday (TD available after normal hours)	Comm: 011-34-956-822-725 DSN: 314-727-2725 TD: 011-34-606-705-865	NIPRNET: RMCDETROTA.TECHASSIST@EU.NAVY.MIL SIPRNET: RMCDETROTA.TECHASSIST@EU.NAVY.SMIL.MIL MSG PLAD: FDRMC DET ROTA SP//

AREA RMC	COVERAGE HOURS	PHONE	E-mail/Message PLADs
Regional Support Group Groton/Submarine Technical Support Center (STSC) Groton, CT	0700-1630 WEEKDAYS CDO after hours	Comm: 860-694-7872 Admin: 860-694-4714 DSN: 694-7872/4714 STSC groton CDO after hours: 860-625-3230	MSG PLAD: COMREGSUPPGRU STSC GROTON CT NIPRNET: nwl_n_stsc_prod@navy.mil
Puget Sound Naval Shipyard & IMF (North West Regional Maintenance Center) (NWRMC) Bremerton, WA	0630-1500 WEEKDAYS CDO - 24/7	425-304-5449 DSN: 727-5449 CDO: 425-870-0042 Everett 360-340-0106 Bremerton	NIPRNET: techassistnw@navy.mil MSG PLAD: NAVSHIPYD AND IMF PUGET SOUND WA//210/290//
Pearl Harbor Naval Shipyard and IMF Hawaii Regional Maintenance Center (HRMC) Pearl Harbor, HI	24/7/365	Comm: 808-630-7762 DSN: 315-473-0129 Code 210 DO: 808-630-7762	NIPRNET: hrmc.techassist@navy.mil SIPRNET: hrmc.techassist@navy.smil.mil MSG PLAD: NAVSHIPYD AND IMF PEARL HARBOR HI//101/200/210//
Ship Repair Facility (SRF) and Japan Regional Maintenance Center (JRMCM) Yokosuka, Japan	0730-1630 Mon-Fri CDO after hours	DSN: 315-243-5362 CDO DSN: 315-243-5488 CDO Cell: 81-90-1851-8817	NIPRNET: TECHASSIST_JRMC@srf.navy.mil SIPRNET: TECHASSIST_JRMC@fe.navy.smil.mil MSG PLAD: NAVSHIPREPFAC AND JAPAN RMC YOKOSUKA JA
Southeast Regional Maintenance Center (SERMC) Mayport, FL	Call CDO. If no CDO contact, call Quarterdeck.	CDO: 904-591-8008 Quarterdeck: 904-270-5126 DSN: 960-XXX-XXXX	NIPRNET: sermc-cdo.fct@navy.mil MSG PLAD: SOUTHEAST RMC MAYPORT FL

AREA RMC	COVERAGE HOURS	PHONE	E-mail/Message PLADs
South West Regional Maintenance Center (SWRMC) San Diego, CA	24/7/365	DSOC: 619-556-3608 DSN: 526-3608 Secure: 619-556-8710 CDO CELL: 619-921-6249	NIPRNET: swrmctechassist@navy.mil SIPRNET: swrmctechassist.fct@navy.smil.mil MSG PLAD: SOUTHWEST RMC SAN DIEGO CA
Trident Refit Facility (TRF) Kings Bay, GA	24/7/365	CDO: 912-674-3125	NIPRNET: cdo.trfkb@navy.mil MSG PLAD: TRIREFFAC KINGS BAY GA

(This Page Intentionally Left Blank)

APPENDIX B**SAMPLE TECHNICAL ASSISTANCE VISIT REPORT (TAVR) MESSAGE**

FROM ON-SITE FTA PERFORMING ACTIVITY// (Could be RMC, NSY, NWC, etc.)
TO: SHIP REQUESTING ASSISTANCE
ADDITIONAL ACTION ADDRESSEES (AS APPROPRIATE, TO INCLUDE ACCEPTING RMC FOR FTA TRANSFERS)
INFO: COMUSFLTFORCOM NORFOLK VA// (AS APPROPRIATE)
COMPACFLT PEARL HARBOR HI// (AS APPROPRIATE)
NUMBERED FLEET COMMANDER
TYCOM
GROUP
SQUADRON
COMNAVSEASYS COM WASHINGTON DC// (PROGRAM MANAGER)//
ISEA/PROGRAM MANAGER//
COMSPAWARSSYS COM SAN DIEGO CA// (FOR ASSISTS ON C4I)
OTHER REGIONAL MAINTENANCE CENTER (AS APPROPRIATE)
RMC DET (AS APPROPRIATE)
NSWC CORONA CA// (FOR ASSISTS ON C4I/COMBAT SYSTEM)
COMNAVSAFECEN NORFOLK VA// (SAFETY RELATED ITEMS ONLY)
NETC PENSACOLA FL// (TRAINING ISSUES ONLY)
SERVSCOLCOM GREAT LAKES IL// (TRAINING ISSUES ONLY)
FLEASWTRACEN SAN DIEGO CA// (ASW TRAINING ISSUES ONLY)
FCTCLANT DAM NECK VA// (FOR ASSISTS ON C4I/COMBAT SYSTEM)
SWRMC// (FOR PACFLT SSN ONLY)
NAVSUBSCOL GROTON CT// (FOR SUBMARINES ONLY)
TRITRAFAC KINGS BAY GA// (FOR SSBN/SSGN SUBMARINES)
NWRMC// (FOR SSBN/SSGN SUBMARINES)
SUBMEPP// (AS APPLICABLE)
SURFMEPP// (AS APPLICABLE)
CPA// (AS APPLICABLE)
OTHERS (AS APPROPRIATE)
BT
UNCLAS //N0XXXX//
MSGID/GENADMIN/RMC XXXX//
SUBJ/USS XXXX (HULL) EQUIPMENT NAME-NOMENCLATURE TECH ASSIST VISIT REPORT//
REF/A/CASREP/MSG/TELCON REQUESTING TECH ASSIST//
REF/B/DOC/APPLICABLE TECH MANUAL/(OPTIONAL)//
REF/C/OTHER REFS AS NECESSARY//
NARR/REF A IS SHIP MESSAGE OR TELCON BETWEEN XXXX/X AND XXXX/X.//
POC/NAME/CIV/CODE/-/TEL:DSN XXX-XXXX/TEL:XXX XXX-XXXX//
RMKS/1. BACKGROUND: REF A REPORTED (PROBLEM). AS REQ REF A, RMCXXXX REP, (NAME) PROVIDED TECH ASSIST (DATE) AT (LOCATION) TO ASSIST WITH CORRECTION OF THE PROBLEM.
REF B IS THE APPLICABLE TECHNICAL MANUAL.
2. FINDINGS:
A. BRIEF PROBLEM DESCRIPTION:
B. SUMMARIZE FINDINGS & CORRECTIVE ACTION ON HARDWARE. (STATE WHY DISTANCE SUPPORT WAS UNABLE TO RESOLVE THIS ISSUE. IF THIS TAVR IS TO DOCUMENT AN FTA TRANSFER, SO STATE AND INCLUDE FTA ACCEPTING RMC COMMAND TITLE AND SPECIFIC POC INFO.).
C. SUMMARIZE FINDINGS & CORRECTIVE ACTION ON LOGISTICS (IF ANY).
3. CONCLUSION:
A. STATEMENT ON CAUSE OF PROBLEM (IF NOT OBVIOUS).
B. SOMETIMES CONVENIENT TO COMBINE WITH FINDINGS.

4. LEVEL OF SHIP'S FORCE SUPPORT:

- A. ABOVE AVERAGE/AVERAGE/BELOW AVERAGE.
- B. NUMBER OF SHIP'S FORCE PERSONNEL TRAINED DURING VISIT.

5. RECOMMENDATIONS:

- A. FOR USS XXXXX:
 - (1) IDENTIFY FOLLOW-ON ACTION.
 - (2) ABOVE DISCUSSED WITH (NAME) PRIOR TO DEPARTING SHIP.
- B. FOR TYCOM/RMC:
 - (1) IDENTIFY FOLLOW-ON ACTION.
 - (2) ABOVE DISCUSSED WITH (NAME) ON (DATE).
- C. FOR NAVSEA/ISEA:
 - (1) IDENTIFY FOLLOW-ON ACTION.
 - (2) ABOVE DISCUSSED WITH (NAME) ON (DATE).

6. INFORMATION FOR BLOCK 35 OF 2-KILO PROVIDED TO SHIP DURING DEBRIEF.
JCN _____ APPLIES.

- 7.
 - A. MAN HOURS EXPENDED FOR TECHNICAL ASSISTANCE.
 - B. MAN HOURS EXPENDED FOR TRAINING.
 - C. MATERIAL COSTS.

8. EVALUATION OF NECESSITY FOR TECHNICAL ASSISTANCE:

- A. WAS ADEQUATE TECHNICAL DOCUMENTATION AVAILABLE TO SHIP'S FORCE TO CORRECT PROBLEM?
- B. WERE ADEQUATE TOOLS AVAILABLE TO SHIP'S FORCE TO CORRECT THE PROBLEM?
- C. WERE ADEQUATE MATERIALS/SPARE PARTS AVAILABLE TO SHIP'S FORCE TO CORRECT THE PROBLEM?
- D. WAS SHIP'S FORCE LEVEL OF KNOWLEDGE ADEQUATE TO CORRECT THE PROBLEM?

BT

NOTE: ENSURE MESSAGES ARE IN ACCORDANCE WITH CURRENT MESSAGE FORMAT AND CURRENT PLAIN LANGUAGE ADDRESS DIRECTORY (PLAD) IS UTILIZED.

APPENDIX C**SAMPLE E-MAIL TECHNICAL ASSISTANCE VISIT REPORT (E-TAVR)**

E-mail TAVR distribution will include the following:

TO: SHIP REQUESTING ASSISTANCE (C.O., X.O., DEPT HEADS)

ADDITIONAL ACTION ADDRESSEES (AS APPROPRIATE, TO INCLUDE ACCEPTING RMC FOR FTA TRANSFERS)

CC:

U.S. FLEET FORCES COMMAND N43

COMMANDER U.S. PACIFIC FLEET N43

FLEET COMMANDERS: (as appropriate)

TYPE COMMANDERS: (as appropriate)

NAVSEA/SPAWAR PROGRAM MANAGERS: (as appropriate)

NSWC/SSC IN-SERVICE ENGINEERING AGENTS: (as appropriate)

RMCS: (as appropriate)

TRAINING COMMANDS: (TRAINING ISSUES ONLY, as appropriate)

NAVAL SURFACE WARFARE CENTER CORONA (QA33)

Email TAVR format will be as follows:

SUBJ/USS XXX (HULL) EQUIPMENT NAME TECH ASSIST VISIT REPORT// (Insert brief equipment description; for ex. T 1348 Transmitter)

REF/A/CASREP/DTG// (Reference Designation, change as necessary/Change as necessary/Date Time Group of reference)

REF/B/DOC/2-KILO//

REF/C/TEL/TELCON INFO//

NARR/REF A IS XXXXXXXX. REF B IS XXXXXXXX. REF C IS XXXXXXXX.// (Summary of Tech Assist request.

For ex., REF A is CASREP Initial 04003 request for tech assist)

POC/NAME/GRADE-RATE/TEL:DSN /TEL: // (Identify RMC Technician/RMC Technician Grade/Rank. For ex., GS-12 or E7 / RMC Technician DSN/extension/RMC Technician Comm/extension)

1. BACKGROUND: REF A REPORTED (Problem). AS REQUESTED REF A, RMCXXXC REP, (Name)

PROVIDED TECH ASSIST (Date) AT (Location) TO ASSIST WITH CORRECTION OF THE PROBLEM. REF B IS THE APPLICABLE TECH MANUAL.

2. FINDINGS/CORRECTIVE ACTION:

A. BRIEF PROBLEM STATEMENT.

B. SUMMARIZE FINDINGS AND CORRECTIVE ACTIONS. (State why distance support was unable to resolve problem. If this TAVR is to document an FTA transfer, so state and include FTA accepting RMC command title and specific poc info.).

3. CONCLUSION:

A. STATEMENT ON CAUSE OF PROBLEM/ROOT CAUSE.

B. SOMETIMES CONVENIENT TO COMBINE WITH FINDINGS.

4. LEVEL OF SF SUPPORT:

A. ABOVE AVERAGE/AVERAGE/BELOW AVERAGE

B. NUMBER OF SHIPS FORCE PERSONNEL TRAINED DURING VISIT

5. RECOMMENDATIONS:

A. FOR USS XXXX:

(1) IDENTIFY FOLLOW-ON ACTION

(2) ABOVE DISCUSSED WITH (Name) PRIOR TO DEPARTING SHIP

B. FOR TYCOM/RMC:

(1) IDENTIFY FOLLOW-ON ACTION

(2) ABOVE DISCUSSED WITH (Name) ON (Date)

C. FOR NAVSEA/ISEA:

(1) IDENTIFY FOLLOW-ON ACTION

(2) ABOVE DISCUSSED WITH (Name) ON (Date)

6. INFORMATION FOR THE 2-KILO PROVIDED TO SHIP DURING DEBRIEF. JCN _____
APPLIES.

7. A. MANHOURS EXPENDED FOR TECH ASSIST.

B. MANHOURS EXPENDED FOR TRAINING.

8. EVALUATION OF NECESSITY FOR TECHNICAL ASSISTANCE:

A. WAS ADEQUATE TECHNICAL DOCUMENTATION AVAILABLE TO SHIP'S FORCE TO
CORRECT THE PROBLEM?

B. WERE ADEQUATE TOOLS AVAILABLE TO SHIP'S FORCE TO CORRECT THE PROBLEM?

C. WERE ADEQUATE MATERIAL/SPARE PARTS AVAILABLE TO SHIP'S FORCE TO CORRECT
THE PROBLEM?

D. WAS SHIP'S FORCE LEVEL OF KNOWLEDGE ADEQUATE TO CORRECT THE PROBLEM?

**NOTE: DEFAULT TO NAVAL MESSAGE TAVR IF NECESSARY EMAIL ADDRESSES ARE NOT
KNOWN.**

VOLUME VI
CHAPTER 3
SUBMARINE MODERNIZATION

REFERENCES.

- (a) NAVSEA SL720-AA-MAN-030 - Navy Modernization Process Management and Operations Manual (NMP MOM)
- (b) NAVSEAINST 9210.4 - Changes, Repairs and Maintenance to Nuclear Powered Ships
- (c) NAVSEAINST 4790.8/OPNAVINST 4790.4 - Ships' Maintenance and Material Management (3-M) Manual
- (d) NAVSEA 0989-LP-037-2000 - Commissioned Submarine General Reactor Plant Overhaul and Repair Specification
- (e) NAVSEA S9213-45-MAN-000 - Navy Nuclear Material Management Manual
- (f) NAVSEAINST 4720.14 - Temporary Alterations to Active Fleet Submarines; Control of
- (g) NAVSEA Technical Specification 9090-310 - Ship Alteration Accomplishment by Installation Teams
- (h) NAVSEA T9044-AD-MAN-010 - Requirements Manual for Submarine Fly-By-Wire Ship Control Systems
- (i) COMUSFLTFORCOMINST/COMPACFLTINST 4720.3 - Commander United States Fleet Forces Command (COMUSFLTFORCOM)/Commander Pacific Fleet (COMPACFLT) C5ISR Modernization Policy
- (j) COMSUBFORINST 4720.15 - Submarine C5ISR Modernization Policy
- (k) NAVSEA Technical Specification 9090-100A - Liaison Action Record
- (l) NAVSEA 0989-LP-058-1000 - Destroyer Tender and Submarine Tender Nuclear Support Facilities Overhaul and Repair Specification

LISTING OF APPENDICES.

- A Major Ship Alteration Types Executive Summary
- B Submarine Alteration Request Format
- C Sample TEMPALT/OPALT Reporting Message
- D TYKIT Requisition Form
- E TYCOM Alteration Management System Interpretation Guide
- F Liaison Action Request (LAR) Form
- G Alteration Feedback Form

3.1 **PURPOSE.** To establish procedures, policy and responsibilities for fleet level management and execution of the Navy Modernization Program (NMP) as it pertains to the Submarine Force. Additional information is contained in references (a) and (b).

3.1.1 **Scope.** The scope of this chapter is limited to Ship Alterations (SHIPALT), Naval Sea Systems Command Nuclear Propulsion Directorate (NAVSEA 08) Alterations (NUCALT), Alteration and Improvement (A&I) Items, Type Zero (TZ) Improvements, Engineering Changes, Field Changes (FC), Ordnance Alterations (ORDALT), Temporary Alterations (TEMPALT), Operational Alterations (OPALT), TRIDENT Command and Control System Modifications, Temporary Engineering Changes and Type Commander (TYCOM) Discretionary Changes (TDC). Appendix A of this chapter provides an executive summary of these major alteration types.

3.1.2 **Definition.** An alteration is defined as any modification in the hull, machinery, equipment or fittings that involves a change in design, materials, number, location or relationship of an assembly's component parts, whether the change is separate from, incidental to, or in conjunction with repairs. All modifications affecting ship's configuration, both major and minor, are prohibited without the applicable Systems Command technical approval and TYCOM authorization.

3.2 RESPONSIBILITIES.

3.2.1 Immediate Superior In Command (Squadron/Naval Submarine Support Command). The Immediate Superior In Command (ISIC) will assign an Alteration Coordinator who is responsible for managing the alteration program for each assigned unit as follows:

- a. Informing the Fleet Maintenance Activity (FMA) of upcoming availabilities.
- b. Monitoring FMA long range modernization and availability planning.
- c. Establishing installation priorities.
- d. Ensuring no action is taken to accomplish alterations which are not authorized for accomplishment. TYCOM concurrence is required for exceptions.
- e. Maintaining a file of active alteration briefs and other related documentation.
- f. Assisting units in the preparation of alteration requests (Appendix B) and reviewing them for technical adequacy, applicability and recommended level of accomplishment. Alteration requests should be limited to alterations affecting safety or providing a substantial maintenance or operational benefit.
- g. Identifying design deficiencies, changes to hull applicability, or non-availability of material/design for alterations.
- h. Ensuring that only TYCOM authorized (including partially completed alterations) appear on the individual ship's Current Ship's Maintenance Project (CSMP). Review the Type Availability Code to ensure alterations have been properly screened for either FMA or Ship's Force accomplishment (Type Availability Two for FMA or Type Availability Four for Ship's Force). Reference (c) provides detailed Maintenance and Material Management (3-M) Program requirements.
- i. Ensuring that the Master Job Catalog (MJC) contains all alterations authorized for accomplishment. The Maintenance Document Control Office (MDCO) or comparable local organization is responsible for the retrieval of authorized alteration information from the MJC and its addition to the Regional Maintenance Automated Information System (RMAIS)/Logistics Data System (LDS) master CSMP or appropriate maintenance database. If an authorized alteration is not contained in the MJC, contact the TYCOM/SUBMEPP or take appropriate steps to locally add it. Reference (c) provides detailed 3-M Program requirements.
- j. Ensuring that all OPNAV 4790/CKs are collected three days prior to the end of the availability. Within two days of receipt, the MDCO (or equivalent maintenance document processing office) will input the original OPNAV 4790/CK into the on-site RMAIS/LDS computer or appropriate maintenance database.
- k. Ensuring that a Reactor Plant Configuration Change Report (RPCCR) Completion Report summarizing reactor plant configuration changes accomplished by a shipyard organization, Nuclear Regional Maintenance Department (NRMD) or FMA are forwarded to the ship's Commanding Officer either electronically or by hard copy at the end of each availability. Ensure the ship's engineer acknowledges the report back to the installing activity and that a copy of the RPCCR Completion Report is provided to the ISIC alteration manager and Squadron Engineer so the NUCALTs can be closed out in RMAIS/LDS or appropriate maintenance database. Additional details are available in references (d) and (e).
- l. Ensuring situational alterations are accomplished when conditions warrant.
- m. Informing ships of alterations planned during an availability in the pre-arrival message. Include alterations being accomplished by outside activities (industrial activity, vendor, Alteration Installation Team (AIT), etc.).
- n. Verifying reports of alteration completions provided by the industrial activity during Chief of Naval Operations (CNO) Maintenance Availabilities.
- o. Ensuring that alterations authorized for Forces Afloat accomplishment are completed to the maximum extent possible prior to ship entry into a CNO Maintenance Availability.

- p. Ensure a Memorandum of Agreement (MOA) is in place for any alteration or TEMPALT/OPALT scheduled for accomplishment before installation begins. Ensure the MOA provides the duration of installation and scheduled removal date for TEMPALTs/OPALTs. Reference (f) provides detailed TEMPALT Program requirements.
- q. Ensuring installation of TEMPALTs/OPALTs are in accordance with reference (f) and installation/removal is reported in the format provided in Appendix C of this chapter.
- r. Ensuring installation of alterations by the AIT is in accordance with reference (g).
- s. Ensuring that the FMA requisitions Ready for Issue (RFI) TYCOM Alteration Kits (TYKIT) using a TYKIT Requisition Form provided in Appendix D.
- t. Ensuring that Category "A" A&Is are completed within 12 months of the date of authorization. Category "A" items affect the structural or operational capability of the ship such that non-accomplishment would result in unsafe ship conditions. Failure to complete a Category "A" A&I within 12 months will require the ISIC to submit a major Departure From Specification (DFS) in accordance with Volume V, Part I, Chapter 8 of this manual. Category "A" A&I items will be assigned to the parent FMA for management. In addition to submitting a DFS, provide a Quarterly Plan of Action and Milestones for the accomplishment of overdue Category "A" A&Is to the TYCOM Modernization Program Manager.
- u. Ensuring that Category "B" A&Is are completed within 24 months of the date of authorization. Category "B" A&Is affect personnel and equipment safety and failure to complete a Category "B" A&I within 24 months could result in personnel injury or equipment damage. Provide a Quarterly Plan of Action and Milestones for the accomplishment of overdue Category "B" A&Is to the TYCOM Modernization Program Manager.
- v. Ensuring all Fly-By-Wire Ship Control System alterations are planned and installed in accordance with the requirements of reference (h) and Chapter 34 of this volume.

3.2.2 Fleet Maintenance Activity. The FMA will establish and maintain an Alteration Management Group. This group will be responsible for:

- a. Using the priorities set by the TYCOM/ISIC, commence alteration planning and material procurement in time to permit on time accomplishment.
- b. Ensuring required ship checks are conducted in a timely manner.
- c. Ensuring no action is taken to accomplish alterations which are not authorized for accomplishment. TYCOM concurrence is required for exceptions.
- d. Notifying the ISIC that an alteration is ready to work when all procedures have been prepared and all material is on hand.
- e. Upon completion of each non-reactor plant alteration, ensure that the OPNAV 4790/CK is completely filled in by the Lead Work Center in accordance with reference (c) and returned with the signed off Automated Work Request to the Analysis, Records and Reports Section. The OPNAV 4790/CK will be forwarded by the Analysis, Records and Reports Section to MDCO (or equivalent maintenance document processing office) for entry into RMAIS/LDS or appropriate maintenance database and then forwarded to the ship for follow-up. Reference (c) provides detailed 3-M Program requirements.
- f. Ensuring that an RPCCR Completion Report summarizing reactor plant configuration changes accomplished by the NRMD or FMA are forwarded to the ship's Commanding Officer either electronically or by hard copy at the end of each availability. Ensure the ship's engineer acknowledges the report back to the installing activity and that a copy of the RPCCR Completion Report is provided to the ISIC alteration manager and Squadron Engineer so the NUCALTs can be closed out in RMAIS/LDS or appropriate maintenance database. Once the ship's engineer acknowledges the report, distribute the RPCCR(s) electronically via the Enterprise Business System RPCCR application. Additional details are available in references (d) and (e).

- g. Maintaining a current scheduling and completion status of alterations on assigned units.
- h. Maintaining the status of alteration planning for all alterations authorized for Forces Afloat accomplishment.
- i. Requisitioning RFI TYKITs using Appendix D.
- j. Ensuring material necessary for the installation of alterations is procured in sufficient time to ensure availability during scheduled upkeeps. This includes obtaining all hardware and software required for Ship's Force responsible alterations.
- k. Providing for proper stowage of TYKITs and other alteration material pending installation.
- l. Ensuring all Fly-By-Wire Ship Control System alterations are planned and installed in accordance with reference (h).
- m. Upon completion of each installation, ensure that red lined drawings (if required) are provided to the ship and planning yard in accordance with reference (a).
- n. Ensure delivery of all required Integrated Logistics Support (ILS) documentation to the ship in accordance with reference (a) and the approved ILS Certification Form. Inform ISIC/TYCOM if all ILS is not available prior to the start of the installation so a TYCOM Risk Assessment can be conducted.

3.2.3 Ship's Alteration Coordinator. Ships will designate the Ship's Maintenance Manager, the 3-M Coordinator or a designated assistant as the Alteration Coordinator. Responsibilities will include:

- a. Acting as the central point of contact for all matters relating to alterations.
- b. Responding to specific requests for ship checks made by the TYCOM/ISIC or FMA.
- c. Ensuring no alteration is attempted by Ship's Force until the alteration appears in the unit's CSMP as planned for accomplishment by the appropriate work center.
- d. Ensuring that all OPNAV 4790/CK forms provided by the installing activity are expeditiously completed and submitted to MDCO or equivalent maintenance document processing office in accordance with reference (c) three days prior to end of upkeep.
- e. For reactor plant alterations completed by the Shipyard/NRMD, an RPCCR Completion Report will be provided by the shipyard/NRMD and within four weeks of receipt, the ship's engineer must acknowledge receipt and return the report to the Naval Supply Systems Command (NAVSUP) Code N87 Waterfront Representative. The shipyard/NRMD will be responsible for electronically processing these RPCCRs via the Enterprise Business System RPCCR application.
- f. For reactor plant alterations completed by Ship's Force, RPCCRs will be processed as follows:
 - (1) RPCCRs for Ships with Propulsion - Organizational Maintenance Management System (P-OMMS). Ship's Force updates and reports configuration changes in P-OMMS. The P-OMMS coordinator shall record all updated configuration information and transmit the e-RPCCR data in accordance with references (d) and (e). In addition, provide a list of NUCALTs completed by Ship's Force to the ISIC Alteration Manager and Squadron Engineer so they can be closed out in RMAIS/LDS or appropriate maintenance database.
 - (2) RPCCRs for Ships without P-OMMS. Paper RPCCRs provided with the alteration shall be completed by Ship's Force and scanned to a .pdf format and submitted as uploads via the Naval Reactors Information Portal in accordance with references (d) and (e). In addition, provide a list of NUCALTs completed by Ship's Force to the ISIC Alteration Manager and Squadron Engineer so they can be closed out in RMAIS/LDS or appropriate maintenance database.
- g. Monitoring the accomplishment of alterations during Depot Maintenance Availabilities by both the industrial activity and Ship's Force and reviewing alteration completion reports provided by the industrial activity. Report any discrepancies to the ISIC/TYCOM.

- h Ensuring proper 3-M reporting by monitoring the submission of OPNAV 4790/CK forms regardless of the installing activity or availability. If an OPNAV 4790/CK form has not been submitted for a completed alteration, obtain one. The certification letter of alterations accomplished by a shipyard or AIT will be processed as OPNAV 4790/CKs as required by reference (c).
- i Ensuring an MOA is in place before installation of an alteration or TEMPALT/OPALT by any industrial activity. Ensure the MOA provides the duration of installation and scheduled removal date for TEMPALTs/OPALTs.
- j Ensuring installation of TEMPALTs/OPALTs is in accordance with reference (f) and installation/removal is reported in the format provided in Appendix C.
- k Ensuring TEMPALTs are removed and the ship is returned to its original configuration by the scheduled removal date.
- l Ensuring all TEMPALTs are removed and the ship is returned to its original configuration prior to a CNO Maintenance Availability.
- m Ensuring installation of alterations by an AIT is in accordance with reference (g).
- n Verifying the accuracy of the TYCOM Alteration Management System (TAMS) Report, a Non-Nuclear Title "K" SHIPALT Report (available from TYCOM) and a NUCALT Technical Documentation CD report and reporting any discrepancies to the ISIC/TYCOM.
- o Ensuring onboard repair parts are ordered in sufficient time to ensure availability prior to a reactor plant SHIPALT installation.
- p Ensuring all Fly-By-Wire Ship Control System alterations are planned and installed in accordance with the requirements of reference (h).
- q Following installation of an alteration that modifies the structure of the ship, such that access to vital equipment is or may be impacted, the ship shall evaluate the need to perform Unrestricted Operation (URO)-29. If access to vital equipment could be restricted, the ship shall perform URO-29 and provide a copy to the installing activity and the ISIC. Partial accomplishment of URO-29 is acceptable if appropriate for the alteration.

3.3 ALTERATION PROGRAMS.

3.3.1 Reactor Plant Ship Alteration Package Program (Nuclear Powered Ships only). A NAVSEA 08 program to package and position reactor plant alteration material at the NAVSUP Weapons System Support (WSS) Mechanicsburg for requisition and installation by Forces Afloat. RFI reactor plant alteration packages should be requisitioned via fax to (717) 605-7706 or official correspondence to the below address. All requests must include National Stock Number, alteration number, hull number and name, complete shipping address, point of contact (including phone number), and required delivery date.

Naval Supply Systems Command Weapons System Support (NAVSUP WSS)
Code 009
P.O. Box 2020
Mechanicsburg, PA 17055-1788

3.3.2 Alteration Installation Team Program. A program to support the installation of alterations by an industrial team normally outside of a CNO Maintenance Availability. Specific guidelines governing AITs are contained in reference (g). AIT installations are scheduled and authorized through the Navy Tool for Interoperability Risk Assessment (NTIRA), Submarine Modernization and Alteration Requirements Tool (SMART).

3.3.3 Type Commander Alteration Kit Program. A TYCOM program which packages all hardware and software required to plan, install and report completion of the alteration. No action should be taken by Forces Afloat to obtain material to accomplish an alteration designated as a TYKIT. Accomplishment will be authorized in TAMS when the TYKIT becomes available. In addition, TYKIT inventories are available on the SUBLANT/SUBPAC SIPRNET/NIPRNET Websites. The installing activity should request shipment of RFI TYKITs from the TYCOM using Appendix D.

3.3.4 Alteration & Improvement Item Program. A TYCOM program to promulgate NAVSEA approved changes to the fleet which are different from SHIPALTs in that they do not normally result in significant design changes, have no logistically significant material requirements, no significant ILS Requirements and no significant industrial production work or support requirements. Joint COMSUBLANT/ COMSUBPAC A&Is are issued by COMSUBLANT.

3.3.4.1 Message Alterations and Improvements. In the event that operational concerns require an immediate configuration change to ships at sea, a Naval Message may be used to direct specific actions with an assigned A&I number.

3.3.4.2 Alteration and Improvement Category Codes.

Category A: Mandatory/Safety of Ship - Accomplish within one year of authorization or submit a Major DFS.

Category B: Mandatory/Safety (Personnel, Equipment, etc.) - Accomplish within two years of authorization.

Category C: Mandatory/Maintenance Improvement - Accomplish within three years of authorization.

Category D: Optional/Habitability.

Category E: Optional/Minor Improvement.

Category F: Situational - Accomplish when the condition outlined in the A&I occurs.

3.3.5 Command, Control, Communications, Computer, Combat Systems, Intelligence, Surveillance and Reconnaissance (C5ISR) Modernization Program (C5IMP). The Submarine Force C5IMP was established to manage configuration baselines, ensure critical C5ISR interoperability and manage operational risks associated with C5ISR modernization. The C5IMP is scheduled and authorized through the NTIRA/SMART. C5I modernization is normally accomplished during CNO Maintenance Availabilities or by an AIT during pier side availabilities. Additional details are available in references (i) and (j).

3.4 MONITORING OF ALTERATION STATUS.

3.4.1 Type Commander Alteration Management System. An automated system operated by the TYCOMs containing information relating to an alteration's authorization, completion status, scheduling and designated accomplishing activity for all A&I Items, TZ Improvements and SHIPALTs. TAMS is the instrument by which the TYCOM authorizes the accomplishment of TYCOM alterations and maintains completion status. Appendix E provides a TAMS Interpretation Guide.

3.4.2 Navy Data Environment - Navy Modernization. The official automated system supporting the information and decision support requirements of NMP managers Navy wide. Navy Data Environment - Navy Modernization (NDE-NM) contains data related to ships and their availability schedules, alteration applicability, alteration material requirements and procurement status and installation and outfitting costs for non-nuclear alterations. Submarine TYCOM alterations and SSBN/SSGN alterations are not scheduled in NDE-NM at this time.

3.4.3 Navy Tool for Interoperability Risk Assessment, Submarine Modernization and Alteration Requirements Tool. NTIRA/SMART is the authoritative tool for the Submarine Force C5IMP. All C5I modernization planning, scheduling and authorization is conducted utilizing NTIRA/SMART. SMART is available on NIPRNET for SSNs and SSGNs and on SIPRNET for SSBNs. In addition, the TYCOM uses NTIRA/SMART to schedule and authorize all Hull, Mechanical and Electrical non-nuclear alterations being accomplished by AIT.

3.4.4 Nuclear Alteration Technical Documentation Compact Disk. The NUCALT Technical Documentation CD provides information required to accomplish nuclear SHIPALTs and A&I items. It is issued to applicable ships, ISICs and FMAs quarterly. It provides information on all outstanding nuclear alterations applicable to each individual ship.

3.5 LIAISON ACTION REQUEST. A Liaison Action Request (LAR) is to be submitted to the appropriate Planning Yard or Reactor Plant Planning Yard, with copy to the TYCOM Modernization Program Manager, when a technical problem is encountered during the planning for or installation of an alteration. Appendix F provides a generic LAR which contains the minimum information required. Locally modified LARs can be used as long as they provide the minimum information outlined in Appendix F. Reference (k) provides more detail on LARs. Non-technical issues should be addressed to the TYCOM via Alteration Feedback in accordance with paragraph 3.6 below.

3.6 ALTERATION FEEDBACK. An Alteration Feedback message or email (Appendix G) is to be submitted to the TYCOM Modernization Program Manager when a non-technical or administrative problem is encountered during the planning for or installation of an alteration. Technical issues should be addressed to the appropriate planning yard via LAR in accordance with paragraph 3.5 above.

3.7 ALTERATION REQUESTS. Requests for new alterations should be made using the format provided in Appendix B. Alteration requests should be limited to alterations affecting safety or those providing a substantial warfighting or maintenance benefit. Initiator must provide adequate justification or the alteration request will be returned disapproved. ISIC endorsement of Alteration Requests from the fleet is required.

3.8 TYCOM MODERNIZATION WEBSITES. Both the COMSUBLANT and COMSUBPAC NIPRNET and SIPRNET Websites provide a wealth of modernization information to include periodic TAMS Reports, TYKIT Inventory and Requisition Form, Alteration Document (SHIPALT, A&I, TZ Improvement) Archives and general information.

3.9 PERMANENT MODIFICATIONS TO TENDERS WITH NUCLEAR SUPPORT FACILITIES. Rearrangement or modification to spaces within or adjacent to the Nuclear Support Facility shall be accomplished in accordance with reference (1).

(This Page Intentionally Left Blank)

APPENDIX A

MAJOR SHIP ALTERATION TYPES EXECUTIVE SUMMARY

TYPE ALTERATION	BRIEF	WHO FUNDS FMP INSTALLATION
Title K SHIPALT	Most complex military characteristic change; requires Industrial Activity (including AIT) expertise.	Program Office
Title K-P SHIPALT	Approved package alteration for AIT or forces afloat accomplishment.	Program Office
Title D SHIPALT	Less complex fleet responsible Alteration Equivalent to a Repair. May require Industrial Activity or FMA expertise. Reactor Plant Title "D" SHIPALTs are situational - to be accomplished only when the situation outlined in the SHIPALT occurs.	Fleet Commander/TYCOM
Title F SHIPALT	Less complex fleet responsible Alteration Equivalent to a Repair. May require FMA or Ship's Force expertise. Only used for Reactor Plant alterations.	Fleet Commander/TYCOM
ORDALT	Modification of ordnance equipment/systems after establishment of the product baseline which involves a change in design, material, quantity, installed location, ILS, or the relationship of the component parts of an assembly within the ship. ORDALTs are normally accomplished by an AIT.	Program Office
MACHALT NOTE: Submarines no longer issue MACHALTs but will retain this definition to support legacy MACHALTs.	Hull, Mechanical and Electrical changes within strict equipment/system boundaries and with limited system ramifications managed by the In-Service Engineering Activity.	Program Office or TYCOM
Engineering Changes, Field Changes (FC)	A mechanical, electronic or electrical change, made to electronic equipment after establishment of the product baseline and delivery to the government, including software changes, which do not impact interfaces to other equipment within the ship, change the footprint, form or fit, change power, weight or air conditioning requirements. Engineering Changes and FCs are normally installed by AIT or Ship's Force.	Program Office
Alteration & Improvement (A&I) Item	Tests, inspections and minor alterations to submarines and submarine tenders; no significant ILS impact.	Fleet Commander/TYCOM
Type Zero (TZ) Improvements	Minor alterations to SSBN/SSGN 726 Class submarines; no significant ILS impact.	Fleet Commander/TYCOM
TYCOM Discretionary Changes (TDC) NOTE: Submarines no longer issue TDCs but will retain this definition to support legacy TDCs.	Minor alteration to SSBN/SSGN 726 Class submarines at the discretion of the TYCOM/ISIC; no significant ILS impact.	Fleet Commander/TYCOM
TRIDENT Command and Control System Modification	Alterations on the TRIDENT Command and Control System.	Program Office

TYPE ALTERATION	BRIEF	WHO FUNDS FMP INSTALLATION
Temporary Engineering Changes	Emergent temporary modification to the TRIDENT Command and Control System.	Program Office
TEMPALT	Emergent, proof of concept or mission related temporary modification to submarines; installed for short, predetermined time frame not normally to exceed 18 months or one deployment.	Technical Sponsor
OPALT	TEMPALTs with ILS requirements (usually an interim installation pending SHIPALT development).	Technical Sponsor
TRIDENT Alteration (TRID)	Major alteration to SSBN/SSGN 726 Class submarines. Significant ILS impact.	Program Office

APPENDIX B
SUBMARINE ALTERATION REQUEST FORMAT

4720
Ser
Date

From: Commanding Officer, USS (Ship's Name and Hull No.)
 To: Commander, Naval Sea Systems Command
 Via: ISIC (as appropriate)
 TYCOM (as appropriate)

Subj: USS (Ship's Name and Hull No.) ARN (Hull No.-CY-Ser No.) REQUEST FOR ALTERATION TO
 (PROVIDE/REMOVE/REPLACE/RELOCATE/INSTALL/CORRECT/etc.) IN (Ship Type/Class)

Ref: (a) COMUSFLTFORCOMINST 4790.3; Joint Fleet Maintenance Manual

Encl: (1) (Photographs, sketches, etc. to fully describe the proposed alteration)
 (2) Recommended Changes to Technical Documentation

1. Existing Deficiency/Condition. Statement of circumstances which warrant initiation of alteration request.
2. Alteration Request. In accordance with Volume VI, Chapter 3 of reference (a), request that the following alteration be approved for (Ship Type/Class) ships and be authorized for accomplishment on USS (Ships Name and Hull No.).
 - a. Brief: Description of alteration desired.
 - b. Justification: Statements that the alteration meets one or more of the following criteria:
 - (1) Significant improvement in ship/equipment safety.
 - (2) Significant improvement in equipment/system reliability and/or reduction in maintenance requirements.
 - (3) Significant benefits to health/safety of personnel.
 - (4) Significant improvement in mission capability.
 - c. Applicable Plans/Publications: List applicable technical manuals, drawings, correspondence, maintenance documentation, etc.
 - d. Priority: Defined by TYCOM instructions.
 - e. Relationship to other issued alterations:
 - f. Manual Changes: Recommended manual changes (attached as enclosure (2)).
 - g. Effect on Habitability.
 - h. Materials.
 - i. Work to be accomplished by:

**ISIC ENDORSEMENT OF SUBMARINE
ALTERATION REQUEST FORMAT**

**4720
Ser
Date**

FIRST ENDORSEMENT on Commanding Officer, USS (Ship's Name and Hull No.) Itr 4720 (Ser No. and Date)

From: ISIC (as appropriate)

To: Commander, Naval Sea Systems Command

Via: TYCOM (as appropriate)

Subj: USS (Ship's Name and Hull No.) ARN (Hull No.-CY-Ser #) REQUEST FOR ALTERATION TO
(PROVIDE/REMOVE/REPLACE/RELOCATE/INSTALL/CORRECT/ETC.) IN (Ship Type/Class Ships).

1. Forwarded, concurring with the basic correspondence (with the following comments).
2. The alteration should be applicable to (Type/Class/Hulls).
3. This alteration should be issued as an (A&I/Title D/F/K/P SHIPALT).
4. This alteration should be accomplished by (Forces Afloat/industrial activity).

Copy to:

USS (Ship's Name and Hull No.) (requesting ship)

APPENDIX C

SAMPLE TEMPALT/OPALT REPORTING MESSAGE

FM (INSTALLING ACTIVITY)//
 TO COMNAVSEASYS COM WASHINGTON DC//PMS392 (SSN/SSBN/SSGN)//
 TYCOM//N42T// (AS APPROPRIATE)
 INFO COMSUBRON (SQUADRON NO.)//
 USS (SHIP'S NAME AND HULL NO.)//
 BT
 UNCLAS //N04720//
 MSGID/GENADMIN/(INSTALLING ACTIVITY)//
 SUBJ/(SUBS) INSTALLATION/REMOVAL OF TEMPALT (TEMPALT NO.) (ON/FROM) USS (SHIP'S NAME
 AND HULL NO.)//
 REF/A/LTR/(ORIGINATOR, SERIAL NO.)/(DATE)//
 REF/B/LTR/(ORIGINATOR, SERIAL NO.)/(DATE)//
 NARR/REF A APPROVED DESIGN OF TEMPALT (TEMPALT NO.). REF B APPROVED INSTLN OF
 TEMPALT (TEMPALT NO.)//
 POC/(NAME)/(RANK/RATE/TITLE)/(LOCATION)/(DSN/COMM TELEPHONE)//
 RMKS/1. TEMPALT (TEMPALT NO. AND NARRATIVE DESCRIPTION), DESIGN APPROVED BY REF A,
 INSTALLATION APPROVED BY REF B, WAS (INSTALLED/REMOVED)(ON/FROM) USS (SHIP'S NAME
 AND HULL NO.) ON (DATE). INSTALLATION WAS IAW NAVSEA APPROVED TECHNICAL DATA
 PACKAGE (TDP). DEVIATIONS WERE APPROVED BY _____. THIS TEMPALT IS SCHEDULED FOR
 REMOVAL ON (DATE)//
 RMKS/2. URO-29 WAS OR WAS NOT ACCOMPLISHED//
 BT

NOTE: ENSURE MESSAGES ARE IN ACCORDANCE WITH CURRENT MESSAGE FORMAT AND CURRENT PLAIN LANGUAGE ADDRESS DIRECTORY (PLAD) IS UTILIZED.

(This Page Intentionally Left Blank)

APPENDIX D
TYKIT REQUISITION FORM

DATE:

FROM:

TO: TYCOM (as appropriate)

1. REQUEST SHIPMENT OF BELOW LISTED TYKIT(S):

TYKIT#

HULL#

2. COMPLETE SHIPPING ADDRESS:

3. POINT OF CONTACT:

4. TELEPHONE (VOICE/FAX):

5. DATE REQUIRED:

6. SPECIAL INSTRUCTIONS:

(This Page Intentionally Left Blank)

CAP: Capability Code/Recommended Level of Accomplishment

- S/F = Ship's Force
- FMA = Fleet Maintenance Activity
- SY = Shipyard (Industrial Activity)
- AIT = Alteration Installation Team
- FA = Forces Afloat

CAT: Category Code/(non-reactor plant A&I items only)

- A = Mandatory/Safety of Ship - Accomplish within one year of authorization or submit major DFS in accordance with Volume V, Part I, Chapter 8 of this manual. Invoke SUBSAFE/Submarine Flight Critical Component Boundary work requirements and document SUBSAFE/REC or Submarine Flight Critical
- B = Mandatory/Safety (Personnel, Equipment, etc.) - Accomplish within two years of authorization.
- C = Mandatory/Maintenance Improvement - Accomplish within three years of authorization.
- D = Optional (Habitability).
- E = Optional (Minor Improvement).
- F = Situational - Accomplish when specific situation occurs.

ALT NARR: Narrative description of the alteration.

TYST: TYCOM Status

- A = Applicable but not yet authorized. No action should be taken to accomplish this alteration without TYCOM concurrence.
- B = Applicable and Authorized.
- C = Alteration has been fully completed in accordance with the alteration document. For non-reactor plant alterations, "C" is assigned only after the completion report has been upline reported in the 3-M System. For reactor plant alteration, "C" is assigned only after the RPCCR has been distributed in accordance with reference (c) and all applicable FCs/RPSMs have been completed.
- D = Deferred. No action should be taken to accomplish without TYCOM concurrence.
- E = Intent of the alteration has been equivalently accomplished via a method other than the alteration document.
- H = May or may not have been accomplished during new construction/Post Shakedown Availability via Headquarters or Field Modification Request. A shipcheck is required to determine status.
- I = Incomplete Reactor Plant Alteration (all applicable FCs/RPSMs have not been completed).
- J = Title P SHIPALT package scheduled for installation by the FMA.
- K = Title P SHIPALT package scheduled for installation by an industrial activity during Depot Maintenance Availabilities.
- L = Title P SHIPALT package scheduled for AIT installation.
- N = Not Applicable.
- P = Partially complete.
- Q = A reactor plant alteration reported complete via paper RPCCR.
- T = Technically applicable, however, requirement to accomplish has been negated by another alteration.
- V = Not required within five years of inactivation.
- X = Cancelled.
- Z = Interim completion. For non-reactor plant alterations, awaiting feedback from the 3-M system that the completion has been upline reported. For reactor plant alterations, awaiting RPCCR.

FYPR: Fiscal Year Programmed - Fiscal year in which alteration is to be accomplished (** denotes situational alteration).

PRRMK: Programming Remarks - Assigned Accomplished Level

AIT	=	Alteration Installation Team
ARP	=	Advance Equipment Repair Program
CMA	=	Continuous Maintenance Availability
CNX	=	Cancelled
CON	=	New Construction
DCA	=	Depot Conversion Availability
DEF	=	Deferred
DMA	=	Docking Maintenance Availability
DMP	=	Depot Modernization Program
DPM	=	Docking Phased Maintenance Availability
DRA	=	Depot Restricted Availability
EOH	=	Engineered Overhaul (Not Refueling)
ERO	=	Engineered Refueling Overhaul
ERP	=	Extended Refit Period
FA	=	Forces Afloat
FMA	=	Fleet Maintenance Activity
IDD	=	Interim Dry-docking
MAC	=	MACHALT
MMP	=	Major Maintenance Period
MTS	=	Moored Training Ship
NKT	=	Nuclear Alteration Kit for Forces Afloat Installation
NSY	=	Nuclear Alteration Kit for Depot Installation
PIA	=	Pre-Inactivation Selected Availability
PKG	=	Title P Package SHIPALT
PMA	=	Phased Maintenance Availability
POU	=	Post Overhaul Upkeep Period
PSA	=	Post Shakedown Availability
PSC	=	Status Confirmed by Shipcheck
RAV	=	Restricted Availability
ROH	=	Regular Overhaul
SAV	=	Special Availability
SCA	=	Surface Craft Availability
S/F	=	Ship's Force
SIT	=	Submarine Installation Team
SMP	=	Submarine Extended Operating Cycle Modernization Program
SRA	=	Selected Restricted Availability
SY	=	Shipyard
TAT	=	TYKIT for AIT Installation
TAV	=	Technical Availability
TKT	=	TYCOM Alteration Kit
TOA	=	TYCOM Opportunity Availability
TRF	=	Trident Refit Facility
TSY	=	TYKIT for Depot Level Installation
TYC	=	No Installing Activity Assigned
VFS	=	Vendor Field Service
XXX	=	Cancelled

SHIPCK: Shipcheck Indicator

REQD	=	Shipcheck is required
COMP	=	Status has been confirmed by Shipcheck

AUTH/COMP: If alteration is outstanding, this date is the authorization date. If the alteration is complete, this date is the completion date.

DUE DATE: Date the alteration is required to be completed.

LAST
UPDATE: Date the record was the last updated by TYCOM.

REMARKS: Used to record information relating to hull status or situational requirements.

APPENDIX F

LIAISON ACTION REQUEST (LAR) FORM

LIAISON ACTION REQUEST		ACTION NO. _____
		DATE _____
From:		
To:		
Subj:		
Ref:		
ORIGINATOR		CODE
	APPROVED	
Question or Action Required		Reply is required by _____
COMPLETED BY		APPROVED BY (BRANCH HEAD)
	DATE	
TELE. NO.		SIGNATURE
Answer or Action Taken		

(This Page Intentionally Left Blank)

APPENDIX G

SAMPLE ALTERATION FEEDBACK MESSAGE/EMAIL FORMAT

FM ORIGINATING ACTIVITY//
TO TYCOM//
INFO ISIC//
BT
UNCLAS//N04720//
MSGID/GENADMIN/(SHIP'S NAME AND HULL NO.)//
SUBJ/ALTERATION FEEDBACK//
REF/A/(ALTERATION NUMBER)//
AMPN/REF A IS (DESCRIPTION OF ALTERATION)//
RMKS/1. DURING (PLANNING/ACCOMPLISHMENT) OF REF A THE FOLLOWING NON-TECHNICAL
PROBLEMS WERE ENCOUNTERED:
 A. INSTALLATION DOES NOT ACCOMPLISH THE INTENT OF ALTERATION
 B. MATERIAL IS NOT ADEQUATELY IDENTIFIED OR AVAILABLE TO SUPPORT THE
 INSTALLATION
 C. ALTERATION IS/IS NOT APPLICABLE
 D. ALTERATION IS/IS NOT WITHIN FMA OR SHIP'S FORCE CAPABILITY
2. DETAILS OF PROBLEM AREAS NOTED IN PARAGRAPH 1 OR OTHER PROBLEMS ENCOUNTERED
3. RECOMMEND CORRECTIVE ACTIONS/IMPROVEMENTS/COMMENTS
4. RECOMMEND SCHEDULING/PROGRAMMING CHANGES//
BT

**NOTE: ALTERATION FEEDBACK FORMS MAY BE SUBMITTED VIA EMAIL TO THE TYCOM
MODERNIZATION PROGRAM MANAGER**

**NOTE: ENSURE MESSAGES ARE IN ACCORDANCE WITH CURRENT MESSAGE FORMAT AND
CURRENT PLAD IS UTILIZED.**

(This Page Intentionally Left Blank)

VOLUME VI

CHAPTER 4

SHIPBOARD ELECTROMAGNETIC COMPATIBILITY

REFERENCES.

- (a) NAVSEA STD DWG 407-5291780 - Standard Electromagnetic Interference (EMI) Survey Procedures
- (b) SUBMEPP Test Procedure 441-5-7001 - SSN 688 Class Submarine, Systems EMI Measurements, Dockside
- (c) Maintenance Plan 4100-02-01 - Command and Control System (CCS) Electromagnetic Interference (EMI) Testing
- (d) NAVSEA STD DWG 407-5287556 - Electronics Material Officer's Guide to Shipboard Electromagnetic Interference Control
- (e) NWP 1-03.1 - Naval Warfare Publication Operational Report
- (f) NAVSEA S9040-AA-GTP-010 - Shipboard Systems Certification Requirements for Surface Ship Industrial Periods (Non-Nuclear)
- (g) COMNAVSEASYS COM WASHINGTON DC 031440Z MAR 03 - Submarine Industrial EMC and EMI Control Interim Guidance
- (h) N6-NTSP-S-70-8003 - Navy Training System Plan (NTSP) for Electromagnetic Interference (EMI) Control
- (i) NAVSEA STD DWG 407-5287561 - Industrial Electromagnetic Compatibility (IEMC) Work Process Instructions

4.1 PURPOSE. To provide guidance in the execution of a shipboard Electromagnetic Compatibility (EMC) or the Shipboard Electromagnetic Compatibility Improvement Program (SEMCIP) program in the U.S. surface force, aircraft carrier and submarine fleets.

4.1.1 Background. The SEMCIP was established by Naval Sea Systems Command (NAVSEA) under the sponsorship of the Chief of Naval Operations (CNO). The goals of SEMCIP are to rectify mission degrading Electromagnetic Interference (EMI) problems, support fleet EMC training, and maintain shipboard EMC. SEMCIP is divided into five major elements; Up-front Systems Engineering, Fleet Response and EMI Problem Quantification, Spectrum Management/EMC in the D30 Process, Engineer EMI Fixes and Fleet EMC Support Tools. One of the Fleet tools is the SEMCIP Technical Assistance Network (STAN), a database containing current and historical information on all known shipboard submarine and Strike Force EMI problems. Since some SEMCIP elements are normally associated with the development of new systems, all elements will not be discussed here.

4.2 ELECTROMAGNETIC COMPATIBILITY ASSESSMENTS OR SURVEYS. EMC assessments are an important line of defense against shipboard EMI problems and are performed by NAVSEA or NAVSEA qualified activities for the purpose of testing various ship's systems for EMI degradation. During an EMC assessment or Survey, EMI problems are investigated and evaluated, applicable EMI fixes are installed and effects of EMI on each system tested is ascertained.

4.2.1 Shipboard Electromagnetic Compatibility Assessments. Deploying surface force ships and aircraft carriers will receive an EMC assessment from Regional Maintenance Center (RMC) as part of a Command, Control, Communications, Computers and Combat Systems Readiness Assessment (C5RA) approximately 4 to 6 months prior to deployment. Non-deploying ships may submit requests for an EMC assessment to the RMC or by submitting an OPNAV 4790/2K to their Regional Support Group (RSG)/RMC. Submarines will receive an EMI survey or EMI groom within two months prior to deployment during Pre-Overseas Movement 2 portion of the submarine deployment cycle. The surface force ship and aircraft carrier EMC assessment and the submarine EMI survey address different types of ship's systems and therefore will be discussed separately.

4.2.1.1 Surface Force Ships and Aircraft Carriers. EMC assessments should not be scheduled coincidental with evolutions that restrict either antenna radiation or personnel movement about the ship. EMC assessments must be performed per the requirements of reference (a), and include, but are not limited to:

- a. Using STAN to verify that all available EMI fixes have been installed, or if not installed, documented in ship's Current Ship's Maintenance Project.

- b. Performing topside visual surveys to ensure the ship conforms to the applicable topside electromagnetic control drawing as specified in STAN for that ship.
- c. Performing Intermodulation Interference (IMI) test.
- d. Performing instrumented IMI source location when IMI level exceeds the 19th order.
- e. Performing broadband noise test.
- f. Identifying source location when broadband noise is detected.
- g. Performing Time-Domain or Frequency-Domain Reflectometer measurements on all high frequency, very high frequency, and ultra high frequency transmission lines.
- h. Conducting Voltage Standing-Wave Ratio tests on all high frequency, very high frequency, and ultra high frequency transmit antennas. Where transmission lines and antennas are coupled and cannot be easily separated, reconnected and weather-proofed, testing of transmission line/antenna combinations may be performed via Time-Domain Reflectometer/Frequency-Domain Reflectometer, satisfying the testing requirements of this paragraph and paragraph 4.2.1.1g.
- i. Performing insulation resistance tests on high frequency antennas, where required by the Planned Maintenance System (PMS).
- j. Documenting all discrepancies noted on OPNAV 4790/2Ks.
- k. Assisting Ship's Force with hands-on training and technical guidance in correcting discrepancies as appropriate.

4.2.1.2 Submarines. EMI surveys require up to four working days depending on the ship class being evaluated. EMI surveys can be accomplished concurrently with most submarine work but must not be scheduled coincidental with evolutions that would impede access to the forward sonar and communications system units or cause power-down of systems during the EMI survey without prior notification of the EMC technician conducting the survey. If equipment must be powered down, the EMC technician will determine if further EMI testing can be accomplished. For an accurate assessment of the submarine EMI posture, the ship's forward electronics must be energized as close as possible to the ship's at sea lineup. The electronics and hydraulics for both multifunction mast antennas must be operational. In addition, crane service is required to lift two antenna shields (approximate weight 130 lbs. each) to cover both partially raised multifunction mast antennas for testing. Major sonar, communications, fire control or navigation system casualties will cause test data to be invalid. EMI surveys must be performed per references (b) and (c) by qualified NAVSEA or NAVSEA designated activities and include but not limited to:

- a. Using STAN to verify all available EMI fixes have been installed.
- b. Briefing Ship's Force on the details of the EMI survey and discussing testing time-lines and potential impacts to the EMI survey.
- c. Coordinating antenna shield installation and removal with the ship, RSG/RMC and port services.
- d. Performing a visual survey in the submarine to verify EMI corrective action installations in sonar and communications equipment and to look for potential EMI coupling areas associated with these systems.
- e. Energizing forward electronics in accordance with the equipment energized list, provided in reference (b) for SSN Class submarines or reference (c) for TRIDENT Class submarines.
- f. Conducting EMI surveys on sonar and communications equipment.
- g. Installing and/or repairing any EMI corrective action needed to produce EMI reduction in order to improve the total shipboard EMC of all shipboard electronic equipment and systems. This will include a retest to determine the actual reduction achieved.
- h. Analyzing test data, noting all discrepancies, and generating a Naval Departure Message documenting the results of the EMI survey.
- i. Providing EMC posture debrief to the designated submarine's officers and leading petty officers. The Naval Departure Message will also be provided to the ship at the debrief for transmission from the ship.

- j. Assisting ship with hands-on training and technical guidance in correcting discrepancies as appropriate.

4.3 FLEET ELECTROMAGNETIC COMPATIBILITY SUPPORT TOOLS. SEMCIP provides Fleet EMC Support Tools to help eliminate emergent EMI problems between C5RAs. When a ship encounters an EMI problem beyond the scope of Ship's Force and Fleet Maintenance Activity (FMA) capabilities, outside technical assistance can be arranged on short notice. The problem should be reported using a standard message format or by Casualty Report (CASREP), as outlined in reference (d) and in accordance with reference (e). In addition to the normal message addressees the message should also be sent to COMNAVSEASYS COM WASHINGTON DC//05H3//, NAVSURFWARCENDIV DAHLGREN VA//J54//, NAVUNSEAWARCENDIV NEWPORT RI//3431// (submarines only), and COMSPAWARSYS COM SAN DIEGO CA //051-1C//.

4.4 ENGINEER ELECTROMAGNETIC INTERFERENCE FIXES. SEMCIP EMC engineers identify and characterize new EMI problems and develop and formalize solutions for these problems. When new EMI problems are detected through testing per references (a), (b), and (c), SEMCIP Engineering will develop a fix. SEMCIP engineering also updates standard EMI test procedures for references (a), (b), and (c).

4.4.1 Shipboard Full-scale Electromagnetic Compatibility Evaluations. Shipboard full-scale EMC evaluations are performed by NAVSEA in the lead ship of a class or in individual ships at the conclusion of any major event (such as conversion, modernization, or overhaul) which could affect the EMC status of the ship. SEMCIP engineering teams energize, test, and evaluate the capability of electromagnetic emitters and sensors to operate simultaneously on the same ship without interference.

4.5 ELECTROMAGNETIC COMPATIBILITY CERTIFICATION. NAVSEA 05H3 coordinates EMC Certification in new construction ships, ships undergoing industrial availabilities and ships receiving new systems both in and outside of industrial availabilities. The EMC Certification testing is conducted by NAVSEA or NAVSEA qualified activities. There are two types of EMC Certification; System and Ship EMC Certification. Each type is addressed below.

4.5.1 System Electromagnetic Compatibility Certification. System EMC Certification ensures all newly installed electrical/electronic systems are compatible with previously installed systems. System EMC Certification will be accomplished in accordance with references (f) for surface force ships and (g) for submarines:

- a. For electrical/electronic systems installed by Fleet or Program Alterations in accordance with the Navy Modernization Process, Management and Operations Manual (NMP-MOM).
- b. Following the System Operation Verification Test or other operation test for the newly installed system.
- c. By NAVSEA 05H4 test team for the first two ships of a class, flight or baseline.
- d. By Program Acquisition Resource Manager, Ship Program Manager, Naval Supervisory Authority, FMA or a contractor witnessed by a government activity for the subsequent System EMC Certifications using test procedures provided in references (a) and (b).

4.5.1.1 System Electromagnetic Compatibility Certification Requirements. System EMC Certification mandates:

- a. The system has an approved (Stage 4) Application for Frequency Allocation (JF-12).
- b. No mission-degrading EMI has been introduced by installation of the system.
- c. EMI fixes have been installed to correct mission-degrading EMI caused by the installation of the system.

4.5.2 Ship Electromagnetic Compatibility Certification. Ship EMC Certification ensures all shipboard systems are compatible with each other and topside EMI mitigation treatments are in place. Ship EMC Certifications will be accomplished in accordance with references (f) and (g):

- a. For all Ship Construction Navy ships to establish an initial EMC Baseline.
- b. For deployers after Target Configuration Date, typically 6 months prior to deployment for surface force ships and aircraft carriers and within two months prior to deployment for submarines (during Pre-Overseas Movement 2).
- c. Following industrial availabilities greater than 120 days.

- d. Every three years for non-deployers.

4.5.2.1 Ship Electromagnetic Compatibility Certification Requirements. Ship EMC Certification mandates that:

- a. All “available EMI fixes” that correct mission degrading EMI problems are installed. Available EMI fixes are fixes that have been developed and listed in the STAN database. An “available EMI fix” is required for certification even if the kit/parts are not in stock. In that case, priority would be given for procurement and installation of the fix required for certification.
- b. All mission degrading EMI problems that remain uncorrected due to non-availability of EMI fixes, must be identified and reported to the ship’s Commanding Officer.
- c. All discrepancies causing IMI above the 19th order must be corrected. IMI levels are defined in reference (a).

4.6 ELECTROMAGNETIC COMPATIBILITY CERTIFICATION MAINTENANCE. System Commands provide support during ship construction and CNO Maintenance Availabilities at industrial activities to achieve EMC certification. It is the responsibility of the Type Commander, the FMA and Ship’s Force to maintain EMC at the highest level practical.

4.6.1 Fleet Maintenance Activity. EMC technical billets (NEC ET-1419 surface) have been established in reference (h) for FMAs, Aircraft Carriers and selected larger ships to provide technical assistance to Ship’s Force in maintaining EMC. These technicians conduct EMI inspections, install known fixes, test for problems and investigate new problems.

4.7 SHIPBOARD ELECTROMAGNETIC COMPATIBILITY IMPROVEMENT PROGRAM TECHNICAL ASSISTANCE NETWORK. STAN is NAVSEA’s computer-based EMC information network that resides on the World Wide Web at <https://www.semcip.com>. Each user is required to obtain a User ID and password.

- a. STAN contains information required to help a ship maintain EMC. This includes but is not limited to:
 - (1) A listing of all EMI problems for an individual ship.
 - (2) A listing of Category 1 and 2 problems for an individual ship.
 - (3) A listing of Category 1 and 2 fixable problems, where a fix has been identified for an individual ship.
 - (4) Brief sheet listings for an individual ship, containing a description of each problem and the solution and/or status.
 - (5) Topside electromagnetic control drawings for all surface force ships and aircraft carriers.
 - (6) Reference (a), Standard EMI Survey Procedures.
 - (7) Individual Shipboard EMI Assessment Reports.
 - (8) EMC certification data and EMI/EMC reports.
 - (9) Hazards of Electromagnetic Radiation to Personnel and Fuel certifications and reports.
- b. EMC technicians at the FMAs, Aircraft Carriers and various other maintenance commands have access to STAN and will provide applicable information upon request.
- c. Requests for access to STAN may be obtained by contacting the STAN Manager, NAVSEA 05H3 at (202) 781-3554, Defense Switched Network (DSN) 326-3554 or via the STAN website (<https://www.semcip.com>).
- d. Assistance can also be obtained by contacting Navy Distance Support at 1-877-418-6824 or by e-mail at help@anchordesk.navy.mil.

4.8 RESPONSIBILITIES.

- a. Type Commander shall:
 - (1) Coordinate with the System Commands in identifying, solving and correcting operational EMI deficiencies.

- (2) Arrange for SEMCIP services when required and schedule SEMCIP EMC technician training/qualification visits for FMA technicians.
 - (3) Prior to promulgation, review and authorize all documents prepared by technical agencies that contain procedures relative to EMI reduction and the fleet EMC process.
 - (4) Evaluate comments and recommendations regarding EMI reduction and the fleet EMC process. If necessary, promulgate changes to existing policy and procedures.
 - (5) Ensure that FMAs have adequate EMC technicians to support EMI surveys. If qualified EMC Technicians are not available at local FMA, NAVSEA personnel will be contacted to perform the EMC assessment or survey.
- b. Group/Squadron/RSG/FMA/SSSU Commanders shall:
- (1) Schedule FMA EMC assessments or EMI surveys prior to deployment for each unit. For submarines the EMI survey should be within two months of deployment during Pre-Overseas Movement 2, take up to four days to perform and can be scheduled concurrently with most shipboard evolutions provided power is not secured to a major system. NAVSEA personnel will be contacted to perform the EMI survey.
 - (2) Review and take the appropriate action to correct EMI discrepancies on EMC reports for subordinate units.
 - (3) Request SEMCIP engineering assistance when determined necessary.
- c. FMAs shall:
- (1) Maintain qualified EMC personnel (NEC-1419/Surface Force Ships and Aircraft Carriers) in coordination with NAVSEA 05H3 and ensure that test equipment assets are available to perform EMC assessments and surveys.
 - (2) Assist aircraft carriers, surface force/submarines in conducting EMC related PMS procedures when requested.
 - (3) Conduct EMC assessments and surveys in accordance with applicable references (a) through (g) and (i).
 - (4) Install authorized limited corrective actions when required in STAN.
 - (5) Write a departure message describing the results of the EMI survey using the latest message formats. Message is submitted to the aircraft carrier and surface force/submarine during the EMI survey departure briefing.
 - (6) Ensure participation of each aircraft carrier and surface force/submarine EMC technician in at least one EMI survey every 6 months. Qualified EMC technicians must meet this requirement to retain qualification status.
 - (7) Maintain an active account on STAN.
 - (8) Maintain an up to date file of EMI/EMC information, which includes Naval Messages generated on tended submarines, and original data recorded during the EMI Surveys.
- d. Aircraft carrier, surface force/submarine Commanding Officers shall:
- (1) Ensure EMI PMS is conducted. Request FMA assistance when required.

NOTE: EMI SURVEYS CONDUCTED WITHIN ONE MONTH PRIOR TO DEPLOYMENT WILL PROVIDE THE BEST EMI DATA SINCE THE MAJORITY OF NEW EQUIPMENT INSTALLS WOULD BE ACCOMPLISHED BY THEN.

- (2) Request an EMI survey within six months of deployment or when any new indications of EMI in ship's electrical/electronic systems appear.

- (3) Transmit the EMC departure message promulgating the results of the EMI survey to all cognizant activities.
- (4) Maintain an up-to-date file of EMI/EMC information that includes EMC departure messages from the last three surveys.

VOLUME VI

CHAPTER 5

DEFICIENCY DOCUMENTATION AND REPORTING

REFERENCES.

- (a) OPNAVNOTE 4700 - Representative Intervals, Durations, Maintenance Cycles, and Repair Mandays for Depot Level Maintenance Availabilities of U.S. Navy Ships
- (b) OPNAVINST 4780.6 - Policy for Administering Service Craft and Boats in the U.S. Navy
- (c) OPNAVINST 4700.7 - Maintenance Policy for U.S. Naval Ships
- (d) NAVSEA S0400-AD-URM-010/TUM – Tag-Out Users Manual
- (e) NAVSEAINST 4790.8 - Ship's Maintenance and Material Management (3M) Manual
- (f) NWP 1-03.1 - Naval Warfare Publication Operational Report
- (g) MIL-STD-130N - Identification Marking of U.S. Military Property

LISTING OF APPENDICES.

- A Equipment Operational Capability Range of Values and Definitions.

5.1 PURPOSE. The purpose of this chapter is to provide guidance on accurately documenting ship's material condition and on ensuring that this documentation is done in a timely and expeditious fashion. Deficiency documentation is used for determining and reporting a ship's material condition to ensure maximum operational readiness, maintain an adequate quality of life for embarked personnel, maximize safety for all personnel and ensure the ship reaches its designed service life. This documentation will be used for:

- a. Accurate and timely material readiness reporting.
- b. Reporting ship material deficiencies, requests for maintenance assistance or support equipment from off-ship maintenance activities and the documentation of completed maintenance actions.
- c. Maintaining an accurate Current Ship's Maintenance Project (CSMP).
- d. Maintaining an accurate and current ship's configuration database.

5.1.1 Background.

- a. The Navy has identified the need for a more near real time, accurate and comprehensive understanding of an activity's material condition in a more timely fashion to support fleet material readiness reporting. Additionally, this information is used in developing, planning and executing more thorough and comprehensive maintenance availability work packages and to better project future material condition readiness and actionable trends.
- b. Using existing maintenance documentation (Casualty Reports (CASREP), 3M Maintenance Action Forms (2 Kilo), Class Maintenance Plan (CMP), etc.), material readiness is calculated for equipment, systems, activities, ships or ship classes against various tasks, missions and warfare areas. This information is used by Navy leadership to determine an activity's ability to perform a desired mission or task, and to make recommendations for maintenance actions that can improve the ship's readiness to perform a mission or task. Further, it allows the maintenance community working with constrained budgets, to better prioritize maintenance that can most improve the activity's material readiness for a known mission or task.
- c. Ship operations involve performing various Naval Tasks when, where and how required. While there may be multiple alternate means to accomplish any particular Naval Task to adequately support operations, equipment and systems must function as designed. Constrained resources (time, funds, and manpower) require better synchronization and prioritization of the maintenance effort.
- d. Not all 4790/2Ks impact current material readiness reporting.

- (1) Condition Based Maintenance (i.e., degraded equipment). Condition Based Maintenance deficiencies drive activity material readiness reporting. The reality of Naval operations is that equipment breaks and system performance is impacted. Condition Based Maintenance is the art of managing material failures. Condition Based Maintenance items run the scope from administrative requirements (placards, stenciling, etc.), run to fail items (e.g., light bulbs, fuses, etc.), gracefully degrading distributed systems (e.g., deck covering, lagging, corrosion, minor leaks, etc.) through catastrophic failures. The Equipment Operational Capability (EOC) Value, Descriptions and Example Table (Appendix A) describes graduations of material condition (fix it after it breaks, fix it before it breaks or fix it because it is about to break).
- (2) Engineered Maintenance (i.e., CMP or Planned Maintenance System (PMS)). Until they exceed periodicity, engineered maintenance does not impact activity material readiness reporting. Typically time directed maintenance actions encompass the art of anticipating failure. Engineered maintenance includes both push and pull CMP items, items written to arrange services or order parts to support future PMS and Baseline Automated Work Packages written by life cycle managers as placeholders for historically anticipated depot work.
- (3) Modernization (i.e., alterations). See Chapter 3 (Submarine Fleet Modernization Program) and Chapter 36 (Surface Force Ship/Aircraft Carrier Modernization Program of this volume. Planned modernization does not impact activity material readiness reporting. Modernization encompasses replacing obsolete equipment or systems, increasing capacity beyond installed design or adding new capabilities. However, because material deficiencies on replaced/removed equipment or systems are no longer applicable to the activity, material readiness may be positively impacted once modernization is accomplished.
- (4) Services (i.e., tasks that support maintenance). Services do not impact activity material readiness. Services are overhead items (force protection, berthing ashore, cranes, etc.) in support of maintenance availabilities.

5.1.2 Scope. Except where indicated, this chapter applies to all ships and activities of the Navy (active and reserve). It does not apply to civilian operated ships assigned to the Military Sealift Command. Throughout this chapter, the term “ship” refers to all surface ships, aircraft carriers, submarines, shore activities and service craft specified in reference (a) and the term “activity” refers to both ship and shore activities. Ship’s Force refers to personnel assigned to any “activity”. Reference (b) provides policy and guidance for maintenance of service craft and boats not addressed in reference (c).

5.1.3 Definitions.

5.1.3.1 Material Readiness. Material Readiness, a term interchangeably used with Material Condition, is a value relative to the observed performance of a single component up to and including a system. The value is obtained through a process of the operator’s observation of the parameters for a component and comparing this measurement to a standard (e.g., design criteria or normal operating parameters). The result of the comparison is the value of Material Readiness or Material Condition. The Fleet Measure of Effectiveness is called the EOC. Found in Appendix A, for the full range of this dimensionless value is the Color Representation when displayed, a specific Definition, a Description and Shipboard Examples.

5.1.3.2 Maintenance Figure of Merit Index Value. The Maintenance Figure of Merit (MFOM) was developed as part of the Defense Readiness Reporting System (DRRS) to provide an objective measure of the true material condition of an activity. The MFOM Index Value is an objectively calculated value where the scale of values and definitions are the same as the EOC as described in Appendix A.

5.1.3.3 Maintenance Worthy. Maintenance Worthy is any object (system, equipment, component, sub component, part, etc.) that is Danger/Caution tagged or part of a tag out (i.e., tag hung on it) in accordance with reference (d), has maintenance performed on it that is either planned (e.g., PMS, calibration, CMP, etc.) or corrective and has maintenance information (e.g., material history, meter readings, test information) recorded about it. Maintenance Worthy is contextually different from Configuration Worthy. Traditionally, Configuration Worthy was a term used

to describe the sparing plan requirements associated with onboard repair parts that enabled ships to be “maintenance self-sufficient” for periods of time away from home port or parent tender. Accordingly, the Consolidated Onboard Shipboard Allowance List provided great merit or support to self-sufficiency. The support of accurate and timely material readiness reporting necessitates the use of a broader term.

5.1.3.4 Current Ship's Maintenance Project. The CSMP, in accordance with references (c) and (e), is the primary repository of information concerning the material condition of the activity. The CSMP consists of two files, shipboard (local) file and the master (shore) file.

- a. The Shipboard File shall be maintained by Ship's Force in a complete and current status at all times. The CSMP shall be used by the activity to document all completed without prior deferral preventive and corrective maintenance requirements. These deferred items shall be validated by Ship's Force and entered into the CSMP in accordance with reference (e) guidelines.
- b. The Master File contains the material deficiencies uploaded from the shipboard (local) file, other work identified by shore-based managers and tasks from CMPs.
- c. Reconciliation of the Shipboard File and Master File is the process of insuring that the two files are essentially the same.

NOTE: THE TERMS “4790/2K”, “2K”, “2 KILO”, “AWR”, “AUTOMATED WORK REQUEST”, “AUTOMATED WORK NOTIFICATION”, “NOTIFICATIONS”, “AWN” AND “WORK CANDIDATE” ARE USED GENERICALLY THROUGH OUT THIS CHAPTER AND THIS MANUAL TO DESCRIBE ANY SHIP MAINTENANCE ACTION FORM.

5.1.3.5 Ship Maintenance Action Form. The Ship Maintenance Action Form (4790/2K), located in reference (e), is the principal means used to document material deficiencies and completed maintenance actions.

- a. A Maintenance Ready 4790/2K contains correct and complete information, and provides an accurate diagnosis of the deficiency affecting the object.
- b. Validated Maintenance Ready 4790/2K properly supports the planning and executing activities ability to understand the maintenance requirement; does not require the expenditure of additional manpower or time to obtain missing required data or information.
- c. Completion 4790/2K contains:
 - (1) A detailed and comprehensive description of the "as found" condition.
 - (2) A synopsis of tasks and actions taken to complete the maintenance requirement.
 - (3) Failure Mode and Root Cause identified.
 - (4) Documentation of labor and material costs.

5.1.3.6 Casualty Report. The CASREP, in accordance with reference (f), is used to both notify the chain of command and the readiness stakeholders of degradations to operational readiness caused by deficiencies in an activity’s material condition and alert support activities to the nature of outside assistance required for correction. A CASREP is made on a system or equipment which has a maintenance requirement that can not be corrected within 48 hours and the maintenance requirement reduces the activity’s ability to perform an assigned task or mission (primary or secondary). The CASREP category (C2, C3, and C4) shall be determined in accordance with reference (f).

5.1.3.7 Department of Defense Readiness Reporting System. The DRRS was established by the Department of Defense (DoD) Directive 7730.65 (June 2, 2002) establishing the requirement and means to manage and report the readiness of the DoD and its subordinate components to execute the National Military Strategy as assigned by the Secretary of Defense in the Defense Planning Guidance, Contingency Planning Guidance, Theater Security Cooperation Guidance, and the Unified Command Plan. All DoD components will align their readiness reporting processes to DRRS. The DRRS will build upon processes and readiness assessment tools used in the DoD to

establish a capabilities-based, adaptive, near real-time readiness reporting system. All DoD Components will use the DRRS to identify critical readiness deficiencies, develop strategies for rectifying these deficiencies and ensure they are addressed in program/budget planning and other DoD management systems.

5.1.3.7.1 Joint Mission Essential Tasks. Joint Mission Essential Tasks are developed in support of missions as assigned by the Secretary of Defense. The Joint Mission Essential Tasks will be based on tasks derived from mission analysis using the language of the Universal Joint Task List. Additionally, the DoD components will develop Mission Essential Tasks or similar indicators for all assigned missions, and use information technology to collect near real-time data on the readiness of military forces and support organizations to perform these missions. The Mission Essential Tasks are based on mission analysis and approved by the commander as absolutely necessary, indispensable or critical to the success of a mission. For a given mission there is generally more than one Mission Essential Task that the object supports.

5.1.3.7.2 Navy Capabilities Readiness Reporting System. Subsequent guidance (NAVADMIN 172345ZAUG05) identified DRRS-N (Navy) as Navy's Capabilities Readiness Reporting System, identified OPNAV N4 as Resource Sponsor and identified United States Fleet Forces Command as executive agent.

5.1.3.8 Item Unique Identification. Item Unique Identification (IUID) is an asset identification system instituted by the United States DoD to uniquely identify a discrete tangible item or asset and distinguish it from other like and/or unlike tangible items. Reference (g) provides evolving clarification, increased insight and guidance regarding implementation of Machine-Readable Information (MRI) for item identification marking and automatic data capture associated with IUID. The IUID is used by MFOM and the Navy's Configuration Data Base of Record, Ship's Configuration and Logistics Support Information System to uniquely differentiate an object from other objects. IUIDs are either installed by the original manufacture or for legacy items, through the use of the eSOMS software and in accordance with reference (d).

5.2 RESPONSIBILITIES. Chapter 19 of this volume provides detailed responsibilities with respect to the implementation of policies for the Maintenance and Material Management (3-M) system as set forth in reference (e). The responsibilities delineated below represent an overview of those policies.

5.2.1 Ship's Force.

- a. Ship's Force will comply with the guidance provided in reference (c) and paragraphs 5.3.1 through 5.3.1.2 of this chapter when submitting a 4790/2K.
- b. Ship's Force will comply with guidance provided in reference (f) and paragraph 5.3.2 of this chapter when submitting a CASREP.

5.2.2 Immediate Superior In Command.

- a. The Immediate Superior In Command is responsible for screening and technically reviewing all submitted 4790/2Ks.
- b. The Immediate Superior In Command is responsible for technically reviewing all submitted CASREPs.

5.2.3 Maintenance Team. The Maintenance Team is responsible for reviewing and validating all submitted 4790/2Ks for content and technical correctness. When directed by the Type Commander (TYCOM), members of the Maintenance Team are responsible for validating, screening and brokering all 4790/2Ks.

5.2.4 Type Commander.

- a. The TYCOM is responsible for validating, screening and brokering all 4790/2Ks.
- b. The TYCOM is responsible for brokering all 4790/2Ks associated with any outstanding C3/C4 CASREP during the next scheduled maintenance availability if it has not previously been corrected as an emergent availability.

- c. The TYCOM is responsible for:
 - (1) Complying with the policy provided in paragraph 5.3.2.3 of this chapter.
 - (2) Enforcing compliance with the policy of paragraph 5.3.2.2 of this chapter.

5.2.5 Fleet Maintenance Activity. The Fleet Maintenance Activity, as described in Volume II, Part I, Chapter 4 of this manual, will comply with paragraph 5.1.3.5.c of this chapter when preparing end of availability completion data associated with each 4790/2K.

5.3 GUIDANCE.

5.3.1 Generation of a Ship Maintenance Action Form OPNAV 4790/2K. The 4790/2K is the principal means used to document material deficiencies and completed maintenance actions. These actions require the highest degree of accuracy and accomplishment in a timely and expeditious fashion. This chapter provides policy and assigns responsibility applicable to specified 4790/2K data elements critical to obtaining outside support and material readiness reporting.

5.3.1.1 Required Instance for Documenting. A 4790/2K or Fleet approved equivalent is required:

- a. To document a material deficiency.
- b. When requesting help from outside activities (technical assistance, repair, calibration, etc.).
- c. When ordering parts or materials.
- d. For Selected Level Reporting.
- e. When requesting special support or test equipment (hydrostatic pumps, rigging equipment, etc.).
- f. For documenting a completed maintenance action (corrective or preventative).
- g. When submitting a CASREP.
- h. When submitting a temporary Departure From Specifications (DFS).
- i. For any change in system or equipment configuration. (i.e., 4790/CK).
- j. For documenting the results of an inspection or assessment.
- k. For installation of a Ship Alteration (SHIPALT).
- l. For support services during a maintenance availability.
- m. For a CMP maintenance action.

5.3.1.2 Procedures for Documenting a Maintenance Action. A 4790/2K shall be filled out in accordance with reference (e) and the Software Users Guide for the Automated Information System being used. All Unclassified Non-Nuclear Naval Propulsion Information will be handled in accordance with current regulations and standing guidance from NAVSEA 08. The following policy guidance for data elements is provided:

- a. The 4790/2K associated with a CASREP will remain open, even after the CASREP is cancelled, until repairs have been completed.
- b. Every active CASREP must have at least one active associated 4790/2K. To ensure timely, accurate material readiness reporting when the CASREP is updated, the 4790/2K shall be updated concurrently. If circumstances dictate, a more appropriate active 4790/2K may be associated with the CASREP and the existing 4790/2K closed/canceled.
- c. The associated 4790/2K to the CASREPs shall have a comparable or equivalent severity coding in accordance with reference (e). In particular, Ship's Force will ensure that the Equipment Status Code corresponds directly to the equipment configuration (Allowance Parts List (APL)/Equipment Identification Code (EIC)/Location) that the 4790/2K is written against. Examples where attention to detail is particularly warranted:

- (1) 4790/2K written against the Main Engine when a thermometer is Out Of Commission (OOC). Equipment Status Code 2 (non-operational) should not be used since it indicates the Main Engine is OOC.
 - (2) 4790/2K written against a Weapons System when construction of storage space was requested. Assigning a Status Code 2 indicates the Weapons System is OOC.
- d. Job Control Number (JCN). Only the approved Work Center codes found in Chapter 19 of this volume are to be used.
- e. Attention to detail when selecting equipment configuration is critical. To support repair part ordering, some configuration data may be generic (e.g., circuit breaker in the Consolidated Onboard Shipboard Allowance List could have multiple applications). For readiness reporting purposes it's important to specify which application. Determine if the reported configuration would support an equipment Tag-Out. Configuration elements include:
- (1) APL/Allowance Equipage List (AEL). Shall be written against the sub APL/AEL where applicable. Avoid using just any higher level APL/AEL for the system or equipment.
 - (2) EIC. Shall be for the lowest affected assembly, not just any higher level EIC for the system or equipment. The selected level of assembly should be lowest that fully encompasses the material deficiency.
 - (3) Equipment Serial Number: When multiple equipment (fire pumps, main engines, radio transceivers) have the same APL/EIC, ensure the serial number designation is appended.
 - (4) Location.
 - (5) Equipment Noun Name. Shall be the same name that would be used on a Danger/Caution Tag in accordance with reference (d).
- f. Type of Availability (T/A).
- (1) T/A recommended for performance of a deferral, reference (e), is provided in Table 5-1.

Table 5-1

T/A Code	Description
1	Depot (shipyard or ship repair facility)
2	Intermediate Maintenance Activity (tender, repair ship, etc.)
3	TYCOM Support Unit (floating dry dock, etc., or technical assistance from Systems Command, Organic Technical Authority or contractor representative)
4	Ship's Force
0	Not Applicable
U	(Mission Degrading) (entered on 2K) Used by Board of Inspection and Survey, field identifies certain deficiencies which are considered as preventing the activity from carrying out some part of its mission.

- (2) Table 5-2 provides guidance for documenting deferred maintenance actions.

Table 5-2

Scenario/Issue	Use T/A Code
When requesting technical assistance from off-hull activities.	3
When requesting repair (industrial) from outside activities.	1 or 2
When requesting calibration from outside activities.	1 or 2
When ordering parts or materials for Ship's Force use.	4
For data reporting.	3
When requesting special support or test equipment (hydrostatic pumps, rigging equipment, etc.).	3
Completed without prior deferral.	4
When submitting a CASREP.	1, 2, 3 or 4
When submitting a temporary DFS.	1, 2 or 4
For any change in system or equipment configuration.	3
For documenting the results of an inspection or assessment.	3
For installation of a SHIPALT/Ship Change Document.	1, 2 or 4
For support services during a maintenance availability.	3
For a CMP maintenance action.	1, 2, 3 or 4

g. Status Code (STA).

- (1) OPERATIONAL shall be selected when the system or equipment is operational with only minor discrepancies that do not impact performance. (Similar to EOC 0.8 – 1.0: See Appendix A)
- (2) NON-OPERATIONAL shall be selected when the system or equipment is totally inoperative, or is severely degraded with major operation restrictions and may be a threat to personnel safety. (Similar to EOC 0.0 - 0.4: See Appendix A)
- (3) REDUCED CAPABILITY shall be selected when the system or equipment is operational with discrepancies that could potentially impact performance, or has minor operational restrictions that are not a threat to personnel safety. (Similar to EOC 0.5 - 0.7: See Appendix A)
- (4) NOT APPLICABLE (Equivalent to EOC 1.0) shall be selected:
 - (a) When ordering parts for PMS.
 - (b) When updating a 4790/2K and the object has been repaired, but the JCN cannot be closed due to awaiting parts.
 - (c) When requesting services such as printing, plaques, special support equipment, test equipment, etc.

- (d) For data reporting.
 - (e) For SHIPALTs/Ship Change Documents.
 - (f) For system or equipment configuration changes (4790/CK).
 - (g) When requesting support services in a maintenance availability.
 - (h) For future time directed CMP and PMS maintenance tasks.
- h. Safety Hazard Code. Enter the applicable Safety code in accordance with reference (e).
- i. Ship's Force Man-Hours expended (S/F MHRS. EXP). Accurately document Ship's Force man-hours expended. Do not include man-hours expended by outside agencies as those agencies will document their own man-hour expenditures.
- j. Ship's Force Man-Hours Remaining (S/F MHRS. REM.). Enter only the estimate of future required Ship's Force man-hours remaining. If estimate changes, update the 4790/2K.
- k. Deadline Date.
 - (1) Depot (shipyard or ship repair facility) (T/A-1) the Deadline Date is required. The date entered is the end of the scheduled maintenance availability.
 - (2) Intermediate Maintenance Activity (tender, repair ship, etc.) (T/A-2) the Deadline Date is required. The date entered is the end of the scheduled maintenance availability.
 - (3) TYCOM Support Unit (floating dry dock, etc., or technical assistance from Systems Command, organic technical agents or contractor representative) (T/A-3) is required. Date entered is the entry date plus a realistic estimated time to repair. Update to the Deadline Date is required if the estimate changes.
 - (4) Ship's Force (T/A-4) is required. Date entered is the entry date plus a realistic estimated time to repair. Updates to Deadline Date are required if the estimate changes.
- l. Meter Reading. A meter reading is required for components or equipment outfitted with a meter whenever a 4790/2K is submitted or updated.
- m. Remarks/Description. Comments shall be accurate and concise with clarity. The wording must accurately portray present and potential impacts on the object or system material condition. Classified or Navy Nuclear Power Information is prohibited from being entered into the work candidate. If a full description of the material deficiency requires the use of classified information, a separate message should be generated with the required data and the message referred to in block 35 by message Date Time Group. The following are minimum requirements for Block 35:
 - (1) Depot (shipyard or ship repair facility) (T/A-1):
 - (a) Concisely describe the failure or malfunction and what caused it. Include how and when the casualty was discovered. Provide description of the casualty to include information on operating configuration symptoms and indications.
 - (b) Concisely describe the actions taken by Ship's Force and outside activities to troubleshoot and correct the failure or malfunction. Include initial follow-up and troubleshooting, Ship's Force repair efforts or technical assistance received.
 - (c) Include any test results from troubleshooting.
 - (d) Include the reason for deferral to an off ship maintenance activity.
 - (2) Intermediate Maintenance Activity (tender, repair ship, etc.) (T/A-2):
 - (a) Concisely describe the failure or malfunction and what caused it. Include how and when the casualty was discovered. Provide description of the casualty to include information on operating configuration symptoms and indications.

- (b) Concisely describe the actions taken by Ship's Force and outside activities to troubleshoot and correct the failure or malfunction. Include initial follow-up and troubleshooting, Ship's Force repair efforts or technical assistance received.
 - (c) Include any test results from troubleshooting.
 - (d) Include the reason for deferral to an off ship maintenance activity.
- (3) Technical Assistance in troubleshooting (T/A-3):
- (a) Concisely describe the failure or malfunction and what caused it. Include how and when the casualty was discovered. Provide description of the casualty to include information on operating configuration symptoms and indications.
 - (b) Concisely describe the actions taken by Ship's Force to troubleshoot and correct the failure or malfunction. Include initial follow-up and troubleshooting, Ship's Force repair efforts or previous technical assistance.
 - (c) Include any test results from troubleshooting.
 - (d) Clearly specify the type of outside assistance and the time frame desired by the activity.
- (4) Technical Assistance in obtaining special support or test equipment (T/A-3):
- (a) Describe the special support or test equipment required by the activity.
 - (b) Describe the maintenance action for which the equipment will be used.
 - (c) Include any assistance the activity may need from the requesting activity (e.g., training, assistance in operating the equipment, etc.).
 - (d) Clearly specify the dates the equipment is needed and estimated time the equipment will be returned.
- (5) Technical Assistance documenting the results of an inspection or assessment (T/A-3):
- (a) The inspection or assessment activity shall provide the activity with a maintenance ready 4790/2K.
 - (b) Documentation of assessment results by the equipment Subject Matter Expert will include all the technical data needed to complete a 4790/2K as specified in Chapter 42 of this volume.
- (6) Technical Assistance in obtaining support services during a maintenance availability (T/A-3):
- (a) Describe the support service required by the activity.
 - (b) Describe the maintenance action for which the support service will be used.
 - (c) Include any assistance the activity may need from the requesting activity (e.g., training, assistance in operating the equipment, etc.).
 - (d) Clearly specify the dates the support services are needed and estimated time the support services will no longer be required.
- (7) Ship's Force maintenance action (T/A-4):
- (a) Concisely describe the failure or malfunction, and what caused it. Include how and when the deficiency was discovered. Provide description of the deficiency to include information on operating configuration symptoms and indications.
 - (b) Concisely describe the actions taken by Ship's Force to correct the failure or malfunction. Include initial follow-up and troubleshooting, Ship's Force repair efforts or previous technical assistance.
 - (c) Include any test results from either troubleshooting or post repair testing.

- n. Priority code is required.
- (1) **Mandatory.** The system or equipment is not functioning within designed parameters and may only be operated under emergency conditions. May be a threat to personnel safety or is a critical damage control item. Required to sustain bare minimum acceptable level of human needs and sanitation. The system or equipment failure/malfunction causes a major degradation or total loss of primary mission (C-4 CASREP equivalent).
 - (2) **Essential.** The system or equipment is severely degraded with major operational restrictions and may only be operated under emergency conditions. Further damage may result from continued operations. Poses no threat to personnel safety. Extremely important safety or damage control item. Required to sustain normal level of basic human needs and sanitation. Will contribute so markedly to efficient and economical operation and maintenance of a vital system that the payoff in the next year will overshadow the cost to accomplish. Required for minimum acceptable level of preservation and protection. Required for sustained performance of activity's mission. Required to maintain overall integrity of activity or a system essential to activity's mission. Under emergency. The system or equipment failure/malfunction causes a major degradation but not the total loss of primary mission (C-3 CASREP equivalent).
 - (3) **Highly Desirable.** The system or equipment is operable with deficiencies that affect performance. No restrictions on operation. The system or equipment is capable of performing intended functions, but not to all designed performance standards, or not capable of performing required functions in all operating modes. Important safety or damage control item. Required for normal level of human comfort. Required for efficient performance of activity's mission. Required for overall integrity of equipment or systems that are not essential, but are required as backups in case of primary system failure. Will contribute so markedly to efficient and economical operation and/or maintenance of a vital system that the payoff in the next year will at least equal the cost to accomplish. Will effect major reduction in future maintenance in an area or system that presently cannot be maintained close to acceptable standards. Required to achieve minimum acceptable level of appearance. The system or equipment failure/malfunction causes a major degradation or total loss of a secondary mission (C-2 CASREP equivalent).
 - (4) **Desirable.** The system or equipment is operable with minor discrepancies that do not impact performance. Required for overall integrity of other than an essential system or its backup system. Some contribution to efficient performance. Some contribution of normal level of human comfort and welfare. Will contribute to appearance in an important area. Will significantly reduce future maintenance.

5.3.2 Generation of a Casualty Report. The CASREP is used to both notify the chain of command and readiness stakeholders of degradations to operational readiness caused by deficiencies in an activity's material condition and alert outside support activities to the nature of outside assistance required for correction. The CASREP is not a one time report, but has four distinct types; initial, update, correct or cancel, as specified and described in reference (f). Submitting a CASREP does not relieve the requirement for timely submission of work notifications (OPNAV 4790/2K) or material requisitions.

5.3.2.1 Guidance on Initial Documenting with a Casualty Report. A CASREP shall be prepared in accordance with reference (f) and the Software Users Guide for the Automated Information System being used. This section does not apply to Fleet Ballistic Missile systems under the cognizance of Strategic Systems Programs. All Unclassified Non-Nuclear Naval Propulsion Information will be handled in accordance with current regulations and standing guidance from NAVSEA 08. The following policy guidance is provided:

- a. C3/C4 CASREPs identify severe task or mission degradation that generally requires emergent repairs be effected at the earliest opportunity. C2 CASREPs are less severe and are generally corrected during scheduled maintenance availabilities. C2 CASREPs requiring Fleet Technical Assistance (i.e., Distance Support or onboard Technical Assistance) in determining repairs should result in the technical assistance completed well enough in advance of the scheduled maintenance availability to facilitate repairs during the maintenance availability.

- (1) CASREP category shall be assigned in accordance with reference (f). It shall not be elevated solely to expedite onboard technical assistance, services, parts delivery or repairs.
 - (2) Any outstanding C3/C4 CASREP requiring repair assistance should be repaired during the next scheduled maintenance availability if it has not previously been corrected in an emergent availability.
 - (3) If an outstanding C2 CASREP requiring repair assistance is not scheduled for repairs during the next scheduled maintenance availability, it should not be canceled and repairs should be pursued following the normal C2 CASREP procedures.
- b. Submitting a CASREP during maintenance availabilities is only justified if repairs to the system or equipment resulting in the task or mission degradation will not be corrected during the maintenance availability.
 - c. An activity shall submit a cancellation CASREP (Casualty Cancellation (CASCAN)) upon the commencement of a maintenance availability for which the effected system or equipment is scheduled for repair.
 - d. Do not CASREP hardware or software that have not completed system operational testing or have not been turned over to the activity for operational use (e.g., System Operation Verification Testing, Acceptance Trials, post availability testing).
 - e. Ship's Force or others may not submit a CASREP for installation of an alteration that will provide for either modernization of existing systems or equipment, or add new capability. CASREPs are used to document material readiness issues with installed systems or equipment. See Volume II, Part I, Chapter 2, Section 2.6 of this manual for questions concerning alterations.
 - f. Any system or equipment casualty that would threaten to cause or cause a discharge of oil or oily waste to sea shall be reported with a CASREP.
 - g. Any equipment mishap involving damages or losses exceeding \$50,000 shall be reported with a CASREP. The CASREP alerts the Naval Safety Center an incident has occurred that requires a mishap investigation.
 - h. Estimated Time to Repair (ETR). The ETR must be realistic and an accurate ETR is required for all repairs. Simply extending the ETR by three days (or 30 days for C2) every update period does not support the intent of providing an ETR. If the problem will not be corrected within 24 hours of the ETR, send an update to change the ETR.
 - i. A 4790/2K is required to receive off-ship assistance (technical, repair, parts) or to document Ship's Force work. Every active CASREP shall be associated with an active JCN – no exceptions.
 - (1) CASREPs shall never be generated with associated 4790/2Ks that have an Equipment Status Code of 1 (operational) or 0 (N/A), or a Priority code of 4 (routine). If the CASREP is required, then the Equipment Status Code and Priority code for the 4790/2K need to be updated.
 - (2) The associated 4790/2K must have the correct configuration data (e.g., APL, EIC) to the lowest assembly and that configuration data must be reported on the CASREP.
 - (3) To associate multiple 4790/2Ks with a CASREP, pick a primary 4790/2K to list as JCN and list the remaining 4790/2Ks in the remarks section. If parts are ordered against other APLs than the APL used on the primary associated 4790/2K, those APLs shall be listed in the amplification line of the parts section.
 - j. An assist line is mandatory for an initial CASREP and optional on subsequent updates. In the ASSIST AMPN line clearly specify type of off-ship assistance and the time frame desired by the activity. Clearly identify Distance Support efforts. The following options are acceptable:
 - (1) Assist/Technical/Distance.

- (2) Assist/other/Distance.
 - (3) Assist/none.
- k. CASREP description and remarks should be concise and consistent with the 4790/2K without sacrificing clarity. The system or equipment listed in the casualty line shall indicate the affected assembly. Wording shall accurately portray present and potential impacts on the task or mission. The remarks section for an initial CASREP shall contain the paragraphs below. Indicate the classification at the beginning of individual sub-paragraphs to facilitate access to non-classified information.
- (1) Summary/Impact: Brief executive overview of casualty and impact to the activity's task or mission is clearly identified in the opening paragraph. (e.g., Summary/Impact: 2 of 5 fire pumps degraded (OOC) with 2 of 2 fire pumps in Fire Zone 2 degraded (OOC). CASREP 2009001 refers. Loss of redundancy in supplying firemain. Major degradation in MOB-D. Fully Mission Capable.)
 - (a) Indicate if this message reflects a downgrade to C2 or upgrade to C3/C4.
 - (b) Identify any loss of operational capabilities such as speed, power output, detection range, self defense, loss of a sensor, etc.
 - (c) Equipment serial number, location and number of similar equipment (backup or redundancy).
 - (d) Identify warfare areas degraded and assess capability to perform current or future scheduled missions.
 - (2) Technical Description: Concise synopsis of sufficient granularity to facilitate future Distance support or prepare shore maintenance support services.
 - (a) How and when the casualty was discovered. Provide description of the casualty to include information on operating configuration, symptoms and indications, initial follow-up and troubleshooting.
 - (b) Repair efforts completed to date, or technical assistance received.
 - (c) To facilitate distance support, include any test results from troubleshooting.
 - (3) Pending Actions: Any ongoing or anticipated actions to be taken by Ship's Force or any outside activity.
 - (4) Activity Point of Contact: Include name, best time period and the best way to contact the Point of Contact in Zulu time. Typically phone numbers and E-mail addresses are provided.
 - (5) Mishap Report: (If required) Is required to identify whether it has been completed or is still in progress. If in progress, an estimated completion time should be provided.
 - (6) Ships Schedule: For the next 30 days at a minimum. Where appropriate, indicate next scheduled maintenance availability.
 - (7) Minimize Considered: (When required) Ensure this statement is included inside the remarks section.
- l. CASREP transmission/receipt/processing.
- (1) Ship's Force is responsible to verify CASREPs reach the intended recipients. There have been incidents where a CASREP has been released via naval message, but has not reached the intended recipients intact. Attention to detail with respect to Plain Language Addressees (PLAD), a well trained Radio Central and a controlled chop process are key to success. At a minimum, COMUSFLTFORCOM Norfolk VA (AIG 6842 or 6843) shall be included on all CASREPs to ensure the CASREP is captured in the shore based CASREP Automated Information System.
 - (2) Ship's Force shall ensure CASREPs are forwarded in a timely manner when requested.

5.3.2.2 Guidance on Updating a Casualty Report. Follow the format guidelines defined in paragraph 5.3.2.1 of this chapter for Initial CASREPs. CASREP update is required for:

- a. Revisions to previously submitted information.
- b. Changes in parts status including receipt of parts.
- c. Requests for additional assistance (an assist line is mandatory).
- d. Substitution of an alternate active 4790/2K in place of a closed/canceled one.
- e. Changes to ship's schedule.
- f. Changes to ETR (CASREP updates are to me made 24 hours prior to the expiration of the ETR).
- g. C4 CASREP, at least every 72 hours.
- h. C3 CASREP at least every 10 days.
- i. **C2 CASREP every 30 days.**

NOTE: IF A DEFERRED CASREP IS CORRECTED AT ANYTIME DURING THE DEFERRED PERIOD, A CASCOR SHALL BE SUBMITTED.

5.3.2.3 Guidance on Deferral of a Casualty Report. The TYCOM is required to approve any planned delay of action on a CASREP. In the event that the delay effectively constitutes a CASREP deferral, the activity will forward the deferral recommendation to the TYCOM for approval. A CASREP Deferral is submitted when it is determined that the CASREP will not be corrected while the activity is in the Sustainment Phase (i.e., deployment or surge). This action places the CASREP in an inactive status which reduces the support and eliminates the activity's requirement for updating the CASREP.

- a. The activity shall not report a CASREP as deferred until directed by the TYCOM or his designated representative.
- b. The activity shall submit a CASREP update with the word DEFERD in the estimated time of repair section of a CASREP update. See reference (f) for details.

NOTE: CASREPS SHALL NOT REMAIN OPEN FOR RECEIPT OF PARTS IF THE SYSTEM OR EQUIPMENT IS OPERATIONAL. SENDING A CASUALTY CORRECTION (CASCOR) WITH PARTS REQUESTED VIA A WHISKEY NUMBER WILL NOT CANCEL THE PARTS REQUISITION.

5.3.2.4 Guidance on Correction of a Casualty Report.

- a. CASREP Correction is required:
 - (1) After repairs are completed to the affected system or equipment to restore to operational condition. If the system or equipment subsequently fails operational testing, a new CASREP shall be submitted.

NOTE: MAINTENANCE ASSIST MODULES INSTALLED ASSEMBLIES ARE CONSIDERED TEMPORARY REPAIRS.

- (2) After temporary repairs have been accomplished, and the system or equipment restored to operational status to support the task or mission. Most temporary repairs will require a DFS (see Volume V, Part I, Chapter 8 of this manual) with its associated active 4790/2K until permanent repairs are completed in accordance with all technical requirements.
- b. Include in the remarks section of the CASCOR:
 - (1) A detailed but concise summary of repairs. If operational testing was not completed, include an estimated date for accomplishment.

- (2) Ship's Force understanding of what the root cause was for the failure (e.g., normal wear and tear, inadequate design, power transient, etc.). Normally the root cause will mirror the input for block 8 on the 4790/2K.
- (3) Hours since last failure of the system or equipment prior to the initiation of the CASREP.
- (4) Adequacy of Ship's Force resources to prevent or correct the CASREP. Details should be provided as to what contributed to the CASREP (e.g., troubleshooting procedures, PMS coverage, parts support, test equipment, conduct of drills, operational policy, technical documentation, training, manning, etc.). Include actions taken to correct lack of resources.

5.3.2.5 Guidance on Cancellation of a Casualty Report.

- a. An activity shall submit a cancellation CASREP (CASCAN) upon the commencement of a maintenance availability for which the affected system or equipment is scheduled for repair. Ensure the maintenance availability for which repairs are scheduled is recorded in the remarks section of the CASCAN.
- b. If all associated 4790/2Ks are closed or cancelled without repairs being affected, the corresponding CASREP must be cancelled (CASCAN).

APPENDIX A

EQUIPMENT OPERATIONAL CAPABILITY RANGE OF VALUES AND DEFINITIONS

Examples are found below:

<p>EOC Value - 1.0 (Green)</p> <p>EOC Description – Configuration or maintenance worthy object appears to be in very good material condition. It has no evidence of corrosion or noticeable discrepancies. Notification created only for Preventive Maintenance actions or ordering parts.</p> <p>Actions – Document man-hour expenditures.</p>	<p>EOC DEFINITION - Fully Operable.</p>
<p>EOC Value - 0.9 (Green)</p> <p>EOC Description – Maintenance worthy object works with only cosmetic discrepancies. It may have slight corrosion. The documented discrepancy does not affect performance. There are no anticipated problems or a need for troubleshooting.</p> <p>Actions - Equipment requires cleaning or minor maintenance that may be accomplished by Ship's Force. Document man hour expenditures.</p> <p>Shipboard Examples:</p> <ul style="list-style-type: none"> AIR - Minor leaks (moisture, drips) that do not present a safety hazard. Missing label plates and/or stenciling. Worn paint/scratches on consoles. Surface Dirty. Minor Surface rust present. C4I/CS - Minor leaks (moisture, drips) that do not present a safety hazard. Missing label plates and/or stenciling. Worn paint/scratches on consoles. Surface Dirty. Minor Surface rust present. HM&E - Minor leaks (moisture, drips) that do not present a safety hazard. Missing label plates and/or stenciling. Worn paint/scratches on consoles. Surface Dirty. Minor Surface rust present. Corrosion - Minor Surface rust present. Few corroded topside fasteners. Tank coatings recently inspected. Lifelines have light rust. 	<p>EOC DEFINITION - Fully Operable with Cosmetic Discrepancies.</p>
<p>EOC Value - 0.8 (Green)</p> <p>EOC Description - Maintenance worthy object works with no loss in performance but has minor discrepancies or minimal corrosion. Problems are anticipated or troubleshooting is necessary. Minor redundancy impacted with no effect on performance.</p> <p>Actions – Document man-hour expenditures and 4790/2K deferral for future Ship’s Force actions.</p> <p>Shipboard Examples:</p> <ul style="list-style-type: none"> AIR - Centrifugal pumps cavitate too much. Indicator lights are burnt out. Filters need to be changed. C4I/CS - Centrifugal pumps cavitate too much. A minor number of redundant modules within electronic systems (SLQ-32, SPY-1, etc.) are inoperative. Indicator lights are burnt out. Filters need to be changed. 	<p>EOC DEFINITION – Fully Operable with No Performance Impacting Discrepancies.</p>

<p>HM&E - Centrifugal pumps cavitate too much. Indicator lights are burnt out. Filters need to be changed.</p> <p>Corrosion - Some running rust topside. Bilge foundations need preservation. Discolored deck non-skid. Vent plenums have some minor corrosion damage</p>	
<p>EOC Value - 0.7 (Yellow)</p>	<p>EOC DEFINITION - Operable with minor discrepancies that do not impact performance.</p> <p>EOC Description – Maintenance worthy object works with no loss in performance but has significant discrepancies that need to be corrected or monitored. One of many modes may be inoperative. Minor corrosion.</p> <p>Actions – 4790/2k notification needs to be created for discrepancies or requesting outside activity assistance in troubleshooting. Troubleshooting procedures should be initiated. Consult reference (d) for proper usage of Yellow Caution Tags.</p> <p>Shipboard Examples:</p> <p>AIR - Vibration levels for rotating equipment are approaching limits or rising. Object running hotter than normal. Pressure drops more than maximum. Radar fails minimum transmit power specification by a small amount. Significant leakage of fluid(s). Expansion tank levels dropping. Chemistry difficult to maintain.</p> <p>C4I/CS - Vibration levels for rotating equipment are approaching limits or rising. Object running hotter than normal. Pressure Drops more than maximum. Radar fails minimum transmit power specification by a small amount. Significant leakage of fluid(s). Expansion tank levels dropping. Chemistry difficult to maintain.</p> <p>HM&E - Vibration levels for rotating equipment are approaching limits or rising. Object running hotter than normal. Pressure drops more than maximum. Significant leakage of fluid(s). Expansion tank levels dropping. Chemistry difficult to maintain.</p> <p>Corrosion - Running rust in several topside areas. Fasteners in topside boxes need replacement. Tank coating work package close to availability maximum. Watertight Door hinges and latches rusted.</p>
<p>EOC Value - 0.6 (Yellow)</p>	<p>EOC DEFINITION - Operable with discrepancies that could potentially impact performance in the future. No Restrictions.</p> <p>EOC Description – Maintenance worthy object works with no current loss in performance but performance degradation is anticipated. Significant discrepancies need to be corrected or troubleshooting initiated to prevent performance degradation. Corrosion could impact performance if not corrected.</p> <p>Actions – A standing order must be issued to ensure all watch standers are aware of the work around modification to operating instructions and procedures. 4790/2K notification needs to be created for discrepancies. Consult Volume V, Part I, Chapter 8 of this manual for requirements for submitting a DFS.</p> <p>Shipboard Examples:</p> <p>AIR - Leaks that can be controlled (prevented from becoming a safety issue) by wiping up. Temperature that can be controlled by using artificial cooling. Electronic cooling water low flow alarm bypassed because of a faulty flow switch and flow must be monitored by a designated watch stander.</p>

<p>C4I/CS -</p> <p>HM&E -</p> <p>Corrosion -</p>	<p>Leaks that can be controlled (prevented from becoming a safety issue) by wiping up. Temperature that can be controlled by using artificial cooling. Electronic cooling water low flow alarm bypassed because of a faulty flow switch and flow must be monitored by a designated watch stander.</p> <p>Leaks that can be controlled (prevented from becoming a safety issue) by wiping up. Temperature that can be controlled by using artificial cooling. Electronic cooling water low flow alarm bypassed because of a faulty flow switch and flow must be monitored by a designated watch stander. Testing salinity manually/sounding tanks manually with alarms disabled. Shifting steering could only be accomplished in after steering with bridge syncro OOC.</p> <p>Incipient damage to structure due to corrosion. Tank work package at limit for next availability. Bilges have loose rust. Fasteners broken due to heavy corrosion. Crew engaged in extensive topside preservation. Some cause code 8 2Ks in CSMP. Vent Plenums significant rusting.</p>
<p>EOC Value - 0.5 (Yellow)</p> <p>EOC Description –</p> <p>Actions –</p> <p>Shipboard Examples:</p> <p>C4I/CS -</p> <p>HM&E -</p> <p>Corrosion -</p>	<p>EOC DEFINITION - Operable with discrepancies that effect performance. No restrictions on operation.</p> <p>Maintenance worthy object is capable of performing intended functions, but not to all designed performance standards, or not capable of performing required functions in all operating modes.</p> <p>A standing order must be issued to ensure all watch standers are aware of the work around modification to operating instructions and procedures. 4790/2K notification needs to be created for discrepancies. Based on status of related equipment/systems, consult reference (f) for requirements for submitting a CASREP. Consult reference (d) for proper usage of Red Tags for troubleshooting.</p> <p>Primary power to weapons system has failed and system is operating on alternate power.</p> <p>Ship speed degraded due to hull fouling. Evaporators operating at reduced capacity (less than 50% of optimum capacity).</p> <p>Corrosion induced structural damage. Hull thinning based on UT measurements. Loose topside fixtures due to missing or corroded fasteners. Localized non-skid coating failures.</p>
<p>EOC Value - 0.4 (Red)</p> <p>EOC Description –</p> <p>Actions –</p> <p>Shipboard Examples:</p> <p>AIR -</p> <p>C4I/CS -</p> <p>HM&E -</p>	<p>EOC DEFINITION - Restricted operation. Significant discrepancies.</p> <p>Maintenance worthy object not operating correctly and no means or work arounds allow the object to do everything it was designed to perform.</p> <p>4790/2K notification needs to be created for discrepancies. Based on status of related equipment/systems, consult reference (f) for requirements for submitting a CASREP. Consult reference (d) for proper usage of Red Tags.</p> <p>Radar operates but to a reduced range.</p> <p>Radar operates but to a reduced range.</p> <p>Main Engine Lube Oil Pump sequencing not consistent.</p>

<p>Corrosion - Tank contents contaminated due to leakage. Ladder corrosion limits personnel access. Many tanks require immediate preservation. Non-skid Coefficient of Friction failures.</p>		
<p>EOC Value - 0.3 (Red)</p> <p>EOC Description – Maintenance worthy object not operating correctly or performing intended functions. Not a threat to personnel safety but further equipment damage may occur from continued operation.</p> <p>Actions – 4790/2K notification needs to be created for discrepancies. Based on status of related equipment/systems, consult reference (f) for requirements for submitting a CASREP. Consult reference (d) for proper usage of Red Tags.</p> <p>Shipboard Examples:</p> <ul style="list-style-type: none"> AIR - Can operate a piece of equipment in local manual subject to the watch stander's response time, but not in remote automatic as designed. Remote operators are all inoperative, so space isolation can only be accomplished locally. C4I/CS - Can operate a piece of equipment in local manual subject to the watch stander's response time, but not in remote automatic as designed. Weapons system cannot accept engagement orders from Combat Direction System, but can be operated manually. Remote operators are all inoperative, so space isolation can only be accomplished locally. HM&E - Can operate a piece of equipment in local manual subject to the watch stander's response time, but not in remote automatic as designed. Remote operators are all inoperative, so space isolation can only be accomplished locally. Corrosion- Structural damage to superstructure due to corrosion that restricts access. Corroded and inoperable combat systems equipment. Corrosion to key sensors. Watertight doors inoperable due to corroded hinges. 	<p>EOC DEFINITION - Severely degraded with major operational restrictions.</p>	
<p>EOC Value - 0.2 (Red)</p> <p>EOC Description – Maintenance worthy object not functioning within designed parameters and may only be operated under emergency conditions.</p> <p>Actions - Secure or turn off object. Use object only in an operational emergency. 4790/2K notification needs to be created for discrepancies. Based on status of related equipment/systems, consult reference (f) for requirements for submitting a CASREP. Consult reference (d) for proper usage of Red Tags.</p> <p>Shipboard Examples:</p> <ul style="list-style-type: none"> AIR - Certified Inspector identifies a RBO discrepancy. Loss of dry air system (or electronic cooling water) to a Radar. C4I/CS - Certified Inspector identifies a RBO discrepancy. Loss of dry air system (or electronic cooling water) to a Radar. HM&E - Certified Inspector identifies a RBO discrepancy. Boiler inspection device not available. Corrosion - Significant tank leakage due to corroded structure. Evidence of cracking in structural elements. Lifelines corroded through. 		<p>EOC DEFINITION - Repair Before Operation (RBO).</p>

<p>EOC Value - 0.1 (Red)</p> <p>EOC Description – Maintenance worthy object not functioning. Secure or turn off immediately.</p> <p>Actions - Secure or turn off immediately. 4790/2K notification needs to be created for discrepancies. Based on status of related equipment/systems, consult reference (f) for requirements for submitting a CASREP. Consult reference (d) for proper usage of Red Tags.</p> <p>Shipboard Examples:</p> <ul style="list-style-type: none"> AIR - Steam Receiver alarms are all cut out. C4I/CS - Safety Cutouts missing on gun mount. HM&E - Generator vibrates, arcs and sparks. Boiler alarms are all cut out. Corrosion - Critical tanks corroded so that they cannot be used (Fuel Oil Service, Potable Water, JP-5 or Reserve Feed). 	<p>EOC DEFINITION - Should not be operated/Battle Short.</p>
<p>EOC Value - 0.0 (Red)</p> <p>EOC Description – Maintenance worthy object does not work at all.</p> <p>Actions – 4790/2K notification needs to be created for discrepancies. Based on status of related equipment/systems, consult reference (f) for requirements for submitting a CASREP. Consult reference (d) for proper usage of Red Tags.</p> <p>Shipboard Examples:</p> <ul style="list-style-type: none"> AIR - Turn on/off switch on and no response. Pump or equipment removed. C4I/CS - Turn on/off switch on and no response. Pump or equipment removed. HM&E - Turn on/off switch on and no response. Pump or equipment removed. Corrosion - Corrosion in hull such that leakage from sea is occurring. 	<p>EOC DEFINITION - Totally Inoperative.</p>

The EOC range of values and definitions are provided below:

Title	EOC value or range	Description/Definition
Fully Operable	1.0 (Green)	Configuration or maintenance worthy object appears to be in very good material condition. It has no evidence of corrosion or noticeable discrepancies. Notification created only for Preventive Maintenance actions or ordering parts.
Fully Operable with Cosmetic Discrepancies	0.9 (Green)	Maintenance worthy object works with only cosmetic discrepancies. It may have slight corrosion. The documented discrepancy does not affect performance. There are no anticipated problems or a need for troubleshooting.
Fully Operable with no Performance impacting discrepancies	0.8 (Green)	Maintenance worthy object works with no loss in performance but has minor discrepancies or minimal corrosion. Problems are anticipated or troubleshooting is necessary. Minor redundancy impacted with no effect on performance.
Operable with minor discrepancies that do not impact Performance	0.7 (Yellow)	Maintenance worthy object works with no loss in performance but has significant discrepancies that need to be corrected or monitored. One of many modes may be inoperative. Minor corrosion.
Operable with discrepancies that could potentially impact Performance in the future. No Restrictions	0.6 (Yellow)	Maintenance worthy object works with no current loss in performance but performance degradation is anticipated. Significant discrepancies need to be corrected or troubleshooting initiated to prevent performance degradation. Corrosion could impact performance if not corrected.
Operable with discrepancies that effect Performance. No restrictions on operation.	0.5 (Yellow)	Maintenance worthy object is capable of performing intended functions, but not to all designed performance standards, or not capable of performing required functions in all operating modes.
Restricted operation. Significant discrepancies.	0.4 (Red)	Maintenance worthy object not operating correctly and no means or work around allows the object to do everything it was designed to perform.

Severely degraded with major operational restrictions.	0.3 (Red)	Maintenance worthy object not operating correctly or performing intended functions. Not a threat to personnel safety but further equipment damage may occur from continued operation.
Repair Before Operation	0.2 (Red)	Maintenance worthy object not functioning within designed parameters and may only be operated under emergency conditions.
Should not be operated/Battle Short	0.1 (Red)	Maintenance worthy object not functioning. Secure or turn off immediately.
Totally Inoperative	0.0 (Red)	Maintenance worthy object does not work at all.

(This Page Intentionally Left Blank)

VOLUME VI
CHAPTER 6
INDUSTRIAL PLANT EQUIPMENT

REFERENCES.

- (a) NAVSO P 1000 - Navy Comptroller Manual
- (b) NAVCOMPTINST 7000.38 - Productivity Enhancing Incentive Fund (PEIF)/The Productivity Enhancement Capital Investment Fast Payback Program
- (c) NAVSUP 5009 (DLAM 4215.1) - Management of Defense-Owned Industrial Plant Equipment
- (d) NAVSO P 3635 - Federal Acquisition Regulation, Section 13, Chapter 312
- (e) SECNAVINST 4855.3 - Product Data Reporting and Evaluation Program (PDREP)

LISTING OF APPENDICES.

- A Plant Equipment Project Form

6.1 **PURPOSE.** To define the responsibilities and procedures for the acquisition and management of Class Three and Class Four Plant Property (inactive equipment) as defined in reference (a).

6.1.1 **Scope.** This instruction applies to Class Three and Class Four Plant Property as defined in reference (a) with the following exclusions:

- a. Alterations. Develop and submit requests for alterations in accordance with Volume VI, Chapter 3 of this manual. Requests for additional shipboard equipment that will be permanently installed require an approved alteration.
- b. Productivity enhancement/fast paybacks. Develop and submit requirements in accordance with reference (b). Due to payback documentation requirements the Productivity Enhancement Incentive Fund is most often used in requesting new technology equipment for the establishment of major new capabilities. This fund is also used for the implementation of radical procedural, productivity or efficiency improvements to current maintenance capabilities.
- c. Plant property assigned an active National Stock Number (NSN). Forward requirements by requisition through the supply system to the cognizant Inventory Control Point. Acquisition of new equipment discussed in this chapter pertains only to items that are not assigned an active NSN.
- d. Operating Forces Support Equipment. Submit requirements to the cognizant Area Commander for funding consideration and local procurement by the requesting activity.
- e. Materials Handling Equipment is under the single manager control of the Naval Supply Systems Command (NAVSUP) (see Volume IV, Chapter 13 of this manual). Civil engineering support equipment is under the single manager control of the Naval Facilities Engineering Command. General Purpose Electronic Test Equipment (GPETE) is under the single manager control of Naval Sea Systems Command (NAVSEA) 04DS (see Volume VI, Chapter 9 of this manual).

6.1.2 **Background.** The program for acquisition of Class Three and Class Four Plant Property (as defined in section 6.2 of this chapter) is managed and funded by NAVSEA PMS 335. References (a) and (c) provide instructions to facilitate procurement and management of Class Three and Class Four Plant Property within the Department of the Navy.

6.2 **DEFINITIONS.**

6.2.1 **Plant Equipment - Classes Three and Four Plant Property.** Navy owned plant property of a capital nature (consisting of equipment, machine tools, test equipment, furniture, vehicles, accessories and auxiliary items, but excluding special tooling and special test equipment) used or capable of use in the manufacture of supplies or in the performance of services or for any administrative or general purpose.

6.2.2 Class Three Plant Property - Other Plant Equipment. That part of plant equipment, with an acquisition cost of \$100,000 or more, used in or in conjunction with the manufacture of components or end items relative to maintenance, supply processing, assembly or research and development operations, but excluding items categorized as Industrial Plant Equipment (IPE).

6.2.3 Class Four Plant Property - Industrial Plant Equipment. That part of plant equipment with an acquisition cost of \$100,000 or more, used for the purpose of cutting, abrading, grinding, shaping, forming, joining, testing, measuring, heating, treating or otherwise altering the physical, electrical or chemical properties of materials, components, or end items entailed in manufacturing, maintenance, supply processing, assembly or research and development operations as identified by noun name in references (a) and (d).

6.3 PROCUREMENT REQUIREMENTS.

6.3.1 Requesting Activities. All requesting activities shall submit requests for plant property as follows:

6.3.1.1 New Procurement. Submit all replacement (new equipment) requirements, with an acquisition cost of \$100,000 or more, to the cognizant Type Commander (TYCOM). Use the Plant Equipment Project (PEP) form, Appendix A of this chapter, to submit requirements one calendar year prior to the start of the fiscal year in which equipment is actually required (e.g., 1 October 1995 for Fiscal Year 1997).

- a. Identify each different requirement by individual project format. Instructions for completing the PEP form are included in Appendix A of this chapter.
- b. Provide a priority listing of all projects with each annual submission.
- c. Activities, such as Fleet Maintenance Activities, having an IPE Management System or IPE Maintenance Module Program shall submit PEPs on computer disk accompanied by a hard copy.
- d. New procurement requirements, with an acquisition cost of less than \$100,000 and Other Plant Equipment/IPE Maintenance Requirements (e.g., major repairs or overhaul) shall be forwarded to the cognizant TYCOM for funding consideration.

6.3.1.2 Urgent Replacement. Submit previously unidentified requirements to the cognizant TYCOM. Use the PEP form of Appendix A of this chapter, or message format if the replacement is associated with correcting a Casualty Report. Assign an integrated priority position for each requirement. If message format is used, justification and all relevant data for equipment acquisition must be provided.

- a. All PEPs shall be prioritized and evaluated to ensure compatibility with maintenance capability requirements/configuration.
- b. PEPs for replacement of currently installed equipment shall be screened to ensure there is no conflict with other maintenance actions.
- c. Cancel any project which is no longer required. Notify the TYCOM by letter of any canceled requirements.

6.3.1.3 Receipt of Plant Property. Upon receipt of plant property, comply with the procedures described below:

- a. Receive the equipment from the staging area.
- b. Notify the procurement activity immediately if deficient conditions are found after receipt. Notifications will be made via a Product Quality Deficiency Report with an information copy to the cognizant TYCOM. Product Quality Deficiency Report preparation and processing instructions are available in reference (e).
 - (1) When timing is critical, such as near the end of the warranty period, or when an urgent need to correct the problem exists, notify the procurement activity by the most expedient method (i.e., telephone or message).
 - (2) Provide the contract number, model and serial number of the plant property, date accepted, date problem developed, nature of the problem and local point of contact (name and telephone numbers).
- c. Notify the TYCOM of actual equipment delivery date.

- d. Notify the TYCOM when installation is satisfactorily completed.
- e. Submit an OPNAV 4790/CK and/or Allowance Change Request as required to initiate Coordinated Shipboard Allowance List support for new equipment and, if appropriate, to stop Coordinated Shipboard Allowance List support for IPE replaced by new equipment.
- f. Submit requests for excess IPE/Other Plant Equipment disposition instructions to the cognizant TYCOM.

6.4 RESPONSIBILITIES.

6.4.1 Fleet Commander. Fleet Commanders shall:

- a. Review all PEPs submitted by the TYCOMs.
- b. Prioritize and assign a Project Number to PEPs and forward the approved requests to NAVSEA PMS 335. Return the unapproved requests to the TYCOM.
- c. Upon notification from NAVSEA PMS 335, forward the information regarding disposition (approval/disapproval), acquisition status and delivery dates for PEPs to the submitting activities with an information copy to the cognizant TYCOM.

6.4.2 Type Commander. TYCOMs shall:

- a. Review all PEPs submitted by cognizant afloat and shore activities for technical accuracy and completeness.
- b. Review each PEP that requests replacement of currently installed equipment to ensure there is no conflict with other maintenance actions (e.g., separate repair, rebuild or replacement action).
- c. Prioritize all PEPs and evaluate each project to ensure compatibility with the requesting activity's maintenance capability requirements and site configuration.
- d. Forward the approved requests to the Fleet Commander for consolidation. Return unapproved requests to the submitting activity.
- e. Schedule an annual assessment of assigned activity's IPE and coordinate repairs.

6.5 REPORTS. Information forwarded on forms pertaining to the requirements of PEP, as required in this chapter, are exempt from the report controls required by reference (e).

(This Page Intentionally Left Blank)

**APPENDIX A
PLANT EQUIPMENT PROJECT FORM**

PLANT EQUIPMENT PROJECT						
1. Activity, UIC & Location		2. Activity Priority		3. Type Commander Priority		4. MILCON Proj Number
5. Project Number			6. Fiscal Year		7. Date	
8. Description				9. Plant Equipment Code (12 Digits)		
				10. Number of Equip Items/Systems Requested		
				11. DD Form 1419 (List Req Numbers for each)		
12. ESTIMATED COST - PROJECT				13. JUSTIFICATION CATEGORY (Check Approp. Block)		
(1) Total Cost	(2) Equipment	(3) Transportation	(4) Installation	<input type="checkbox"/> A. Additional		<input type="checkbox"/> B. Replacement
<input type="checkbox"/> C. Economic	<input type="checkbox"/> D. Mandatory		<input type="checkbox"/> E. Safety/OSHA	<input type="checkbox"/> F. Pollution Abatement		
14. SPECIAL PROGRAM						
A. <input type="checkbox"/> FORCES AFLOAT		B. <input type="checkbox"/> SHIPALT		C. <input type="checkbox"/> PRODUCTIVITY ENHANCEMENT/FAST PAYBACK		
D. <input type="checkbox"/> NUCLEAR SUPPORT		E. <input type="checkbox"/> COLLATERAL EQUIP.				
15. PROCUREMENT				16. LOCATION OF EQUIPMENT		
<input type="checkbox"/> A. Procured by NAVSEA		<input type="checkbox"/> B. Procured Locally by Activity		A. Shop/Code	B. WC	C. Bldg.
17. Purpose, Description and Justification of Project (Identify other special projects here)						
18. Typed Name of Project Preparer			19. Signature of Preparer		20. Date Signed	21. APL No.
						PAGE of

(This Page Intentionally Left Blank)

INSTRUCTIONS FOR COMPLETION OF PLANT EQUIPMENT PROJECT FORM

1. **(Block 1) Activity, Unit Identification Code (UIC) and Location.**
 - a. **Activity.** The name of the military facility (and hull number if applicable) where the proposed equipment is to be used. (mandatory)
 - b. **UIC.** (mandatory)
 - c. **Location.** For shore activities: building number, street, city, state and zip code. (mandatory)
For ships: homeport and building number (if applicable), street, city, state and zip code. (mandatory)
 2. **(Block 2) Activity Priority.** Priority of requested equipment. (Example: 001-94) (mandatory)
 3. **(Block 3) Type Commander Priority.** Priority order for TYCOM. (mandatory)
 4. **(Block 4) Military Construction (MILCON) Project Number.** MILCON Project Number if equipment requested is to be installed as part of a MILCON project.
 5. **(Block 5) Project Number.** Assigned by the cognizant Fleet Commander.
 6. **(Block 6) Fiscal Year.** The fiscal year in which the equipment is requested to be purchased. (mandatory)
 7. **(Block 7) Date.** Record the month, day and year the PEP is developed. (mandatory)
 8. **(Block 8) Description.** Description title of the proposed equipment or system. Include capacity or size. (mandatory)
 9. **(Block 9) Plant Equipment Code.** Use Plant Equipment Code number and include all 12 digits, if possible. Plant Equipment Code numbers are assigned in accordance with reference (e). For Class Three, use NSN (preferred), or Federal Supply Class.
 10. **(Block 10) Number of Equipment Items or Systems Requested.** The total number of items or systems in Block 8 required by this project. (mandatory)
 11. **(Block 11) DD Form 1419.** Required only for surplus Class Four equipment acquisition.
 12. **(Block 12) Estimated Costs - Project.**
 - (1) The total estimated cost including equipment, transportation and installation. (mandatory)
 - (2) The estimated cost of the equipment includes all desired accessories. (mandatory)
 - (3) The estimated cost of transportation shipping from the supplier to the activity. (mandatory)
 - (4) The estimated installation cost. (mandatory)
 13. **(Block 13) Justification Category.** Check Appropriate Block. (mandatory)
 - A. Indicate if equipment is an additional requirement (additional shipboard requirements to be permanently installed require an approved alteration).
 - B. Indicate if equipment is a replacement requirement. For shipboard activities this requires entering the Allowance Parts List (APL) number (if assigned) in Block 21 when replacing existing equipment. A copy of the APL page shall be attached with the PEP submission.
- NOTE: CHECK ONLY ONE OF THE ABOVE TWO CHOICES.**
- C. Indicate if equipment is being replaced or added for economic reasons. Economic reasons may include frequent and costly maintenance or an advanced equipment design that makes the installed version obsolete.
 - D. Indicate if equipment replacement or addition is mandatory. This block should be checked if new or additional equipment is required to meet significant increases in, or new, tasking.

- E. Indicate if equipment is being replaced or added to meet safety or Occupational Safety and Health Administration requirements. Reasons for checking this block could include replacement of equipment that has become unsafe to operate or is required to meet new safety/Occupational Safety and Health Administration regulations.
- F. Indicate if equipment is being replaced or added to meet pollution abatement standards. This block should be checked if the replacement or addition of equipment will facilitate significant reduction in the generation of hazardous waste or is required to satisfy newly levied pollution abatement criteria.

NOTE: MORE THAN ONE BLOCK (C THROUGH F) MAY BE CHECKED.

14. (Block 14) Special Program.

- A. Indicate if equipment is for Forces Afloat Program.
- B. Indicate if equipment is for Ship Alteration Program.
- C. Indicate if equipment is for Productivity Enhancement/Fast Payback Program.
- D. Indicate if equipment is for Nuclear Support.
- E. Indicate if equipment is Collateral Equipment for MILCON.

15. (Block 15) Procurement. (mandatory)

- A. Indicate if project is recommended for procurement by NAVSEA.
- B. Indicate if project is recommended for procurement locally by requesting activity.

16. (Block 16) Location of Equipment.

- A. Shop/Code. The shop number, activity code, cost center or organizational segment, as applicable, where the proposed equipment or system is to be used. (mandatory if applicable)
- B. Work Center. Work Centers where the equipment will be assigned. (mandatory if applicable)
- C. Building. The building number where the proposed equipment or system is to be used. (mandatory if applicable)

17. (Block 17) Purpose, Description and Justification of Project.

NOTE: BLOCK 17 MAY BE CONTINUED ON THE BACK OF THE FORM OR ON ADDITIONAL PAGES. IF BLOCK 17 IS CONTINUED ON ADDITIONAL PAGE(S), REPEAT BLOCKS 1 AND 8 ON EACH PAGE. ENSURE ADDITIONAL PAGE(S) ARE ANNOTATED IN THE SPACE PROVIDED BELOW BLOCK 21.

- a. Purpose. Purpose for which the new equipment or system is to be used. In addition, state increased capacities and/or capabilities (increased power, speeds, feeds, safety, state of the art improvements, pollution abatement features, etc.). An alteration may be required for shipboard applications if other than a "one-for-one" replacement (mandatory).
- b. Description. Include a complete technical description and specifications in sufficient detail to ensure procurement of the exact equipment required (include necessary accessories and attachments). If any of the description is restrictive or proprietary to one manufacturer, underline this portion and give adequate justification for the proprietary requirement. State the manufacturer, model number(s), size, weight, or utility restrictions (mandatory).
- c. Justification. Information and data concerning the following items will constitute the basis of the requirements. Each item should be addressed as fully as possible and in the same sequence in which they are listed below: (A positive or negative statement should be used in lieu of yes or no answers) (mandatory.)
 - (1) Reason for the replacement of the equipment. Identify item being replaced (include manufacturer, model number, serial number, plant account number (where applicable), size and capacity).

- (2) Is additional space required for the installation? If so, where will the installation be made? Submit sketches, complete with size restrictions, including hatch sizes to be considered if equipment must pass through them.
 - (3) Is military or minor construction required? If MILCON, give the title of the MILCON project and beneficial occupancy date, if available. If MILCON, ensure the project number is in Block 4.
 - (4) Indicate the particular electrical characteristics from which the equipment is to be powered (voltage, frequency, phase, number or wires, and if power source is grounded or ungrounded). Also state whether or not sufficient power is available.
 - (5) Is the need for the requested equipment generated wholly or partially by the assignment of new tasks or by new or tightened specifications for existing task(s)? If so, give details.
 - (6) Will the new equipment produce products of better usable quality (products which will last longer, perform better, ensure ready interchangeability, etc.)? If so, give details.
 - (7) What would happen if the present equipment failed? Also, answer the following:
 - (a) What is the remaining life expectancy of present equipment?
 - (b) Is the present equipment worn? To what extent?
 - (c) Is the present equipment unsafe? To what extent?
 - (d) Does the present equipment have an adequate capacity and/or capability?
 - (8) Is the proposed equipment a mandatory requirement (capability increase)? If so, give reason.
 - (9) Is the proposed equipment recommended for local procurement? Block 15B must be checked. If so, give justification.
 - (10) Does the requested equipment require an hour meter?
 - (11) Will this equipment or system be installed in a secure area thus requiring the prime contractor to provide the installer(s) with current security clearance requirements to enable the timely accomplishment of installation services, training, or warranty repairs?
18. (Block 18) Typed Name of Project Preparer. (mandatory)
 19. (Block 19) Signature of Preparer. (mandatory)
 20. (Block 20) Date Signed. (mandatory)
 21. (Block 21) APL Number.

(This Page Intentionally Left Blank)

VOLUME VI

CHAPTER 7

**SUBMARINE FORCES AFLOAT PAINTING AND PRESERVATION GUIDELINES
FOR NON-NUCLEAR SPACES AND COMPONENTS**

REFERENCES.

- (a) NAVSEA S9086-VD-STM-010 - NSTM Chapter 631 (Preservation of Ships In-Service - General)
- (b) URO-MRC 003 - Conduct Hull Structural Survey
- (c) SUBMEPP MS 6310-081-015 - SUBMEPP Maintenance Standard - Submarine Preservation
- (d) COMNAVSUBFORINST 5400.39 - Standard Submarine Organization and Regulations Manual
- (e) OPNAVINST 5100.19 - Navy Occupational Safety and Health (NAVOSH) Program Manual for Forces Afloat
- (f) SSPC Painting Manual - Society for Protective Coating Standards and Specifications
- (g) NAVSEA 6310-081-015 - Technical Handbook for Special Hull Treatment Maintenance and Repair for Submarines

LISTING OF APPENDICES.

- A Submarine Paint Guide
- B Coating Inspection Report Form
- C Shipboard Power Cleaning Tools

7.1 INTRODUCTION. The objective of this document is to provide Fleet Maintenance Activities (FMA) with the procedures necessary to perform preservation maintenance between major shipyard availabilities. It has consolidated all the necessary knowledge from reference (a) for submarine crews that may be inexperienced in the areas of surface preparation and touch-up painting to maintain protective coating systems. This document is to be used in maintaining and repairing preservation systems on non-nuclear components and spaces of U.S. Navy submarines. Appendix A is a guide to assist with preparing, handling and applying paint to interior submarine surfaces.

7.1.1 Applicability.

- a. This document is not to be used during regular shipyard work, where all prevailing technical requirements of reference (a) applies. This includes preservation of tanks, voids and underwater hull, otherwise referred to as critical coated areas. Critical coated areas are defined as areas that cannot be easily accessed and represerved without drydocking of the ship. Many of these areas are also monitored under the reference (b) inspection program. Ship's Force should not be conducting preservation of these areas unless addressed in this manual. FMAs who are supporting shipyard availabilities should utilize a trained workforce to accomplish work in critical coated areas and/or to complete preservation work associated with reference (b). The lead maintenance activity (shipyard, Regional Maintenance Center, Intermediate Maintenance Facility) executing the availability should promulgate to the FMA the qualifications required of personnel who can accomplish preservation in these areas. These qualifications shall meet the requirements of references (a) through (g) and be acceptable to the lead maintenance activity.
- b. Occasionally tanks are entered for other reasons by the FMA or Ship's Force. National Association of Corrosion Engineers (NACE) Level I and Naval Sea Systems Command (NAVSEA) Paint Basic Inspector (NPBI) training does not instruct on how to inspect an in-service coating system. The Navy is implementing new training and requirements for "coating evaluators". If a tank is entered for any reason, it shall be inspected. If significant defects or paint failure is found, the Type Commander or shipyard shall be contacted. A Departure from Specification may need to be submitted to evaluate deferring repair to a future availability. If immediate repairs are needed, NAVSEA will provide the proper guidance.

7.1.2 Technical Point of Contact. Point of Contact for technical questions regarding this chapter is Karen Furrer, NAVSEA PMS392T122, (202) 781-4341. E-mail: karen.furrer@navy.mil.

7.2 SCOPE. This manual provides information to the FMA with basic step-by-step instructions for:

- a. Inspecting and reporting areas of coating failure.
- b. Providing oversight during the paint process.
- c. Identifying the required surface preparation method.
- d. Preparing the surface for repainting using hand or power tools.
- e. Selecting proper paint(s) for a given application.
- f. Becoming familiar with the Product Data Sheet (PDS) or American Society for Testing and Material (ASTM) F-718 sheet and Material Safety Data Sheet (MSDS) for a given paint.
- g. Mixing and applying the paints.
- h. Using a Wet Film Thickness (WFT) gauge to determine if the proper coating thickness was applied.
- i. Knowing when to apply overcoats in a two (or more) coat system.

7.2.1 Ship's Force Responsibilities. This document assumes that Ship's Force personnel are being assisted by an FMA and:

- a. Will apply all coatings using a brush or roller.
- b. Will not be required to measure environmental conditions such as surface temperature, dew point and Relative Humidity (RH). Personnel should be instructed, during the training program established in Chapter 27, paragraph 27.3.2 of this Volume, that environmental conditions are important when painting and to consult a NACE or NPBI from the FMA if conditions are questionable.
- c. Will not be required to measure surface salt contamination, but should be instructed, as part of the Chapter 27, paragraph 27.3.2 of this Volume, training, that excessive surface salt contamination will shorten the service life of a coating system and to consult a NACE or NPBI paint inspector from the FMA to determine if surface salt concentrations are within the acceptable range for paint application. Also ensures that the surface is washed with clean water.
- d. Will not use spray equipment to apply paint.
- e. Will not use abrasive blast or hydroblasting equipment to prepare the surface.

7.2.2 Fleet Maintenance Activity Responsibilities. This document assumes that the FMA:

- a. Will maintain the tools needed by Ship's Force to accomplish the preservation process and instruct Ship's Force in their proper use.
- b. Will maintain and be familiar with NACE or Society For Protective Coatings surface preparation and cleanliness standards (NACE Level 1 or NPBI inspectors).
- c. Will assist Ship's Force in accomplishing inspections and prioritizing work.
- d. Will maintain copies of reference (f), (VIS-2 Standard Method of Evaluating Degree of Rusting on Painted Steel Surfaces), to use when accomplishing inspections.
- e. Will assist in the training of Ship's Force in the preservation process.
- f. Will be onboard when painting operations are underway to monitor that the various steps of the process are being properly accomplished (NACE Level 1 or NPBI inspector).
- g. Will perform spot checks of surface cleanliness, surface profile and WFTs during the coating process (NACE Level 1 or NPBI inspector).
- h. Will monitor environmental conditions, temperature, humidity, dew point, to ensure they are within required limits during the coating process (NACE Level 1 or NPBI inspector).
- i. Will conduct soluble salt testing when needed (NACE Level 1 or NPBI inspector).

- j. Will advise Scheduled Preservation Upkeep Coordinated Effort (SPRUCE) Manager or ship's designated representative if required environmental conditions cannot be met (NACE Level 1 or NPBI inspector).

7.2.3 Quick Reference. A Quick Reference, section 7.10 of this chapter, provides concise steps for surface preparation and coating application in specific areas such as the sail and bilges as well as a "catch all" entitled "Miscellaneous Areas of General Corrosion". This manual is structured so that additional "Quick Reference" entries can be added as needed.

7.2.4 Scheduled Preservation Upkeep Coordinated Effort. The SPRUCE program has been established to ensure that internal and sail preservation is maintained at the highest possible level throughout the life of the ship. SPRUCE barge or FMA personnel are being trained as (NACE or NBPI) coating inspectors. They are a resource to Ship's Force during a SPRUCE availability, providing tools, consumables, services, required support personnel, as well as around the clock technical guidance and monitoring by a trained coating inspector. Ship's Force should seek guidance from SPRUCE barge or FMA personnel whenever they are uncertain about any phase of the surface preparation or coating application, but particularly in the following instances:

- a. Measurement of environmental conditions (substrate surface temperature, dew point, relative humidity) to determine if painting may be conducted under the current conditions.
- b. Measurement of surface salts. Painting over excess salt contamination is poor painting practice that may result in premature coating failure.
- c. Information concerning specifications or requirements for coating systems.

7.3 GENERAL SAFETY PRECAUTIONS.

7.3.1 Hazards. Every painting assignment exposes maintenance personnel to conditions and situations that represent actual or potential danger to them and to others in the area. The frequent necessity to use toxic and flammable materials, pressurized equipment, ladders, scaffolding and rigging always presents a potential hazard. Hazards may also be inherent in the very nature of the environment or caused through ignorance or carelessness of the operator. It is, therefore, extremely important to be aware of all potential hazards, since continuous and automatic precautionary measures will minimize the problem and improve both efficiency and morale of the painting crew.

NOTE: THE PRECAUTIONS CONTAINED IN THIS MANUAL ARE IN ADDITION TO, AND DO NOT SUPERSEDE, OTHER SAFETY REQUIREMENTS THAT HAVE BEEN ESTABLISHED IN REFERENCE (d), SECTION D AND REFERENCE (e).

7.3.2 Precautions. This document highlights safety precautions for surface preparation and the mixing, handling and application of coatings. The local environmental, safety and health organization has cognizance over the safety precautions to be implemented during all phases of the painting process.

7.4 INSPECTION OF EXISTING PAINT AND BASE METAL.

7.4.1 Required Tools. The purpose of this section is to describe how to report the condition of the coating system in various ship areas. The inspector will need the following tools:

- a. Flashlight.
- b. Inspection mirror (to see hard-to-reach areas, such as behind beams).
- c. Pocket knife.
- e. Rag.
- f. Paint stick/non-grease marker.

7.4.2 Failure Locations. Where practical, circle areas of failure with a paint stick/non-grease marker. Record location and type of failure on Appendix B. The following failure types should be reported:

7.4.2.1 Percent of General Corrosion. The extent of corrosion in the inspection area will determine how much surface preparation and painting is required. Therefore, the prime objective of the inspection is to accurately report the extent of corrosion. To facilitate accurate evaluation and reporting, reference (f) is available from the FMA and

shall be used. Reference (f), (VIS-2 Standard Method of Evaluating Degree of Rusting on Painted Steel Surfaces), is a series of photographs showing various extents of corrosion. To use the reference photos, examine the surfaces in the area being inspected and then select one of the reference photographs that most closely resembles the extent of rust in the area being inspected. Enter the percent on Appendix B in the column labeled, "Percent General Corrosion". If reference (f) is not available, estimate the amount of rust and indicate on the form that the standard was not used in the estimation.

7.4.2.2 Corrosion. After removing the corrosion scale with a scraper, look for structural steel defects such as visible metal loss, pitting or large corroded areas. If any defects are discovered, report findings to cognizant supervisor or hull survey team for further instructions and enter "Y" in column labeled, "Pitting Corrosion". Mark the pits with a paint stick/non-grease marker and make a note in the "Notes" column on Appendix B.

7.4.2.3 Percent of Blistering. Enter percentage of the total area showing blistering. Even though the pictorial representations contained in reference (f), (VIS-2 Standard Method of Evaluating Degree of Rusting on Painted Steel Surfaces), are intended for evaluating the degree of rusting, they can also be used as a guide in determining the percentage of an area that has blistered paint. Use the "General Rusting" diagrams (not the photographs) and select the diagram that most closely resembles the pattern of blistering in the area being inspected. Enter the percent on Appendix B in the column labeled "Percent Blistering". Work should be prioritized as follows:

- a. Order of importance for type of failure: pitting > corrosion > blistering.
- b. Order of importance for areas: pressure hull > non-pressure hull.

7.4.3 Cosmetic Paint Failure. Cosmetic paint failures may also be observed and should be repaired only after all other types of preservation failures have been repaired. Repeated cosmetic painting can cause excessive film build that will lead to premature paint failure. Stained or discolored paint should first be washed with detergent and lightly hand sanded to attempt to remove stains. If a cosmetic topcoat is applied, it should be applied in as thin a layer as possible to avoid excessive film build over time.

7.4.4 The Difference Between Rust and Rust Staining. It is necessary to know the difference between rust and rust staining. Dirt, residue or rust staining may be mistaken for rust. Stained, intact paint does not require removal and touch-up. Figures 1 and 2 show two photographs taken in the same location. The top photograph shows what may appear to be extensive rust, especially in a poorly lit area. However, the bottom photograph shows that, after rubbing a small circular area with a rag, the discoloration was caused by dirt and residue, not rusted metal.



Figure 1. Stained area before wiping a small area with a rag.



Figure 2. Stained area after wiping a small, circular area with a rag.

7.5 GENERAL SURFACE PREPARATION.

NOTE: POOR SUFACE PREPARATION IS THE CAUSE OF 95% OF COATING FAILURES. PREPARING THE SURFACE PROPERLY MAY WELL PREVENT RE-DOING THE SAME JOB.

7.5.1 Surface Cleaning Methods. The most important factor affecting the service performance of a coating is the degree of care taken in preparing the surface for painting. When scheduling surface preparation work, ensure that sufficient time will be available to paint all surfaces that have been prepared and allow the paint to fully cure before placing the surfaces into service. The goal of surface cleaning is to provide a roughened surface that is free of contamination and gouges or sharp projections. Roughening is necessary to attain the necessary anchor pattern for good paint adhesion. Surface cleaning methods vary with the type of surface preparation needed, location and size of the area being cleaned. These different cleaning methods are described in the following paragraphs. The steps required to prepare a surface for painting are:

- a. Solvent cleaning to remove oil, grease, dirt, chemicals and water-soluble contaminants. If solvents are prohibited, use detergent and fresh water.
- b. Mechanical cleaning (Hand Tool or Power Tool Cleaning) to remove rust and loose paint and to roughen or profile the surface for better coating adhesion.
- c. Feathering edges.
- d. Sweeping or vacuuming loosened material.
- e. Solvent cleaning, if necessary. Check to see if oil was deposited on the surface during power tool cleaning.
- f. Schedule paint application as soon as possible.

7.5.2 Solvent Cleaning. Solvent cleaning prepares surfaces by removing oil, grease, dirt and other foreign matter prior to mechanical cleaning or painting. The simplest procedure is to first remove soil and other dry material with a wire brush. The surface is then scrubbed with rags saturated with solvent. Clean rags are then used to rinse and wipe dry. Solvent cleaning shall be accomplished only when allowed by local air quality regulations. Recommended solvents: Super high-flash naphtha; Mineral spirits, NSN 010-00-558-7026 (alkyd paints). Surface preparation accomplished by solvent cleaning shall meet the requirements of reference (f), (SP-1 Solvent Cleaning).

7.5.3 Detergent Cleaning.

- a. If solvent cleaning is prohibited, detergent cleaning may be substituted. A recommended detergent is MIL-D-16791, Type 1, Liquid Detergent. The procedure is:
 - (1) Mix detergent in fresh water according to packaging instructions.
 - (2) Wash substrate surface.
 - (3) Rinse with fresh water.
 - (4) Dry surface with clean dry rags to remove residual water.
- b. Several non-specification cleaners such as Simple Green (produced by Sunshine makers, Inc.) have also been used successfully for smaller areas.

7.5.4 Hand Tool Cleaning.

- a. Hand tools such as scrapers and wire brushes are used on surfaces in confined spaces (corners) that cannot be reached with power tools. Hand tool cleaning will remove only loose or loosely adhering surface contaminants, including rust scale, loose mill scale, loose rust and loosely adhering paint. Hand tool cleaning is not to be considered an appropriate procedure for removing tight mill scale and all traces of rust. It is primarily recommended for spot cleaning in areas where corrosion is not a serious factor. Surface preparation accomplished by hand tool cleaning shall meet the requirements of reference (f), (SP-2 Hand Tool Cleaning).
- b. Before hand tool cleaning, the surface shall be free of oil, grease, dirt, chemicals and water-soluble contaminants, all of which may be removed with solvent cleaners and fresh-water rinsing. For small areas, clean dirt, soil, dust or other surface contaminants by using a detergent wash and freshwater rinse. Wipe the surface with rags or a stiff brush as necessary to remove any residue that does not wash off. Impact tools, such as chipping hammers, chisels or scalers shall be used to remove rust scale and any heavy buildup of old coatings. Start painting as soon as possible after cleaning.
- c. In those situations where areas are not accessible to power tools, hand tool cleaning methods may have to be used. Since hand tool cleaning will remove only the loosest contamination, careful application of primers is required, preferably by brushing, to thoroughly wet the surface. To achieve satisfactory results, all applied coats shall be capable of overcoming the interference of contaminants left behind after hand tool cleaning.

7.5.5 Power Tool Cleaning.

7.5.5.1 Safety Warning. Before power tool cleaning, the surface shall be free of oil, grease, dirt, chemicals and water soluble contaminants, all of which may be removed with solvent cleaners and freshwater rinsing. Never try to remove oil or grease by the use of power tools. This causes the grease to become further imbedded in the metal surface, thus preventing good paint adhesion.

7.5.5.2 Power Tool Cleaning Procedure. The proper procedures for cleaning surfaces prior to the use of power tools are as follows:

- a. For small areas, clean dirt, soil, dust or other surface contaminants by using a detergent wash and freshwater rinse. Wipe the surface with rags or a stiff brush as necessary to remove any residue that does not wash off.
- b. To remove embedded grease, oil or soil from small areas, clean the surface with a clean cloth wetted with solvent. After final application of the solvent, wipe dry with a clean cloth.
- c. Power tool cleaning will prepare surfaces faster and better than hand tool methods. Surface preparation accomplished with power tools shall conform to the requirements of the Steel Structures Painting Council Surface Preparation Specification No. 11, "Power Tool Cleaning to Bare Metal". Power tool cleaning to bare metal is defined as removal of all rust, loose mill scale and paint to bare metal (except for slight residue in pits if surface is pitted) by chipping, scraping, sanding or wire brushing. Power tools are used for removing small amounts of tightly adhering contaminants that hand tools cannot remove.

- d. If oil residue is detected after power tool cleaning, solvent cleaning should be repeated.
- e. Painting shall be started and completed as soon as possible after completion of power tool cleaning.

7.5.5.3 Types of Power Tools. Power tools are driven either electronically or pneumatically and the basic units include a variety of attachments. Chipping hammers are used to remove tight corrosion, mill scale and old paint from large metallic and masonry areas. Wire brushes (cup or radial) are used to remove loose mill scale old paint, weld flux, slag and dirt deposits. Grinders and sanders are used to smooth excessively rough surfaces. As with hand tools, care should be exercised with power impact and grinding tools so they do not remove metal or cut too deeply into the surface, resulting in burrs that are difficult to cover and protect satisfactorily. Care should be taken when using wire brushes and sanders to avoid polishing metal surfaces, which would prevent adequate adhesion of subsequent coatings.

7.5.5.4 Power Tool Allowance. The Master Allowance List, Part II, Group S92-1, contains the base allowances of power preservation tools for all ships. Changes in shipboard allowances may be implemented by direction of the Type Commanders. Common shipboard power tools are shown in Appendix C.

7.5.6 Feathering Edges. After mechanical cleaning (hand, power tool cleaning) is complete, edges of the intact paint surrounding the mechanically prepared area must be "feathered" into the metal. Feathering eliminates the "step" from the intact paint to bare metal. If this "step" is not removed, newly applied paint may crack as it dries leading to premature coating failure. The procedure for feathering an area of exposed metal surrounded by intact paint is as follows:

- a. Lightly abrade the edges of intact paint with a power disk sander or rough sand paper.
- b. Taper the edges to make a gradual transition from intact paint to bare metal so that the underlying coats are exposed at the edges.
- c. Solvent (or detergent) clean.
- d. Apply paint.

7.5.7 Aged Paint. Old paint in good condition is an excellent base for repainting. When a surface is to be repainted and the old paint is not to be removed, the surface must be roughened with abrasive and thoroughly cleaned and dried before new paint is applied. When only localized areas of spots require repainting, it is essential that the removal of the old paint be carried back around the edges of the spot or area until an area of completely intact and adhering paint film with no rust or blisters is attained. Edges of tightly adherent paint remaining around the area to be recoated must be "feathered". Painting should not be done over loose and cracked paint. When painted surfaces show evidence of corrosion, peeling, blistering, checking, scaling or general disintegration, remove the paint down to the bare surfaces.

7.5.8 Surface Salt Concentration. Coatings will fail prematurely if excess surface salts are not removed prior to coating application. Ship's Force personnel are not expected to measure surface salt concentration. However, you are expected to know where to find qualified help (SPRUCE barge or Quality Assurance personnel (Code 340)) at TRIDENT Refit Facilities.

7.5.9 Equipment Maintenance. To assure the safe and proper operation of surface preparation equipment, the following are provided:

- a. Power Tools.
 - (1) Ensure that no oil or grease is left exposed after completing maintenance work on surface preparation equipment. The slightest amount of oil or grease on the equipment will contaminate the surface and cause poor paint adhesion.
 - (2) Replace the disk on the disk sander when it no longer cuts through the paint film or when dirty. Replace the head of the wire brush unit when the wires are bent, worn, broken or frayed. Clean wires when dirty.
 - (3) Replace the head of the needle gun when over one-half of the needles become bent.
- b. Hand Tools.

- (1) Maintain a sharp and smooth edge on the scraper.
 - (2) Clean wire brush when dirty.
 - (3) Discard wire brush when wires become frayed or broken.
- c. Care and Maintenance of Paint Brushes.
- (1) Brushes that are to be reused the following day should be marked for white, light colors or dark colors.
 - (2) The weight of the brush should not rest on the bristles.
 - (3) Brushes not to be immediately reused should be cleaned with at least three washings of thinner or solvent, then washed with detergent and water.
 - (4) Brushes should be stored by suspending them from the handle on racks or wrapped in paper and stored flat.
 - (5) Paint rollers should be disposed.

7.6 GENERAL MIXING AND PAINT APPLICATION.

NOTE: PRIOR TO USING ANY PAINT, THE TWO FOLLOWING DOCUMENTS, ISSUED BY THE PAINT MANUFACTURER, SHOULD BE READ AND UNDERSTOOD.

7.6.1 Product Data Sheet/Material Safety Data Sheet. The PDS (or ASTM F-718 sheet) and MSDS provide the information to use the coating properly and safely. To obtain the PDS (or ASTM F-718 sheet) and MSDS, call the coating manufacturer and request them to FAX the PDS (or ASTM F-718 sheet) and MSDS. ASTM F-718s can also be obtained from the National Surface Treatment Center website, <http://www.nstcenter.com>. Some paint manufacturers may provide an ASTM F-718 sheet instead of a PDS. The use of ASTM F-718 sheets is preferred because they have been approved by NAVSEA. Both documents generally provide similar information.

7.6.1.1 Product Data Sheet. This document provides information about the proper use of the paint including:

- a. Mixing instructions including mix ratio (for a two-part system).
- b. Induction period (if required).
- c. Application methods.
- d. Pot life.
- e. Drying and over coat times.
- f. Wet and Dry Film Thickness (DFT) requirements.

7.6.1.2 Material Safety Data Sheet. This document provides information concerning safe use of the paint including the following sections:

- a. Product identification.
- b. Hazardous ingredients.
- c. Physical data.
- d. Fire and explosion data.
- e. Health hazard data.
- f. Reactivity data.
- g. Spill or leak procedures.
- h. Special protection information including Personal Protective Equipment (PPE).
- i. Special precautions.

7.6.2 Mixing Area.

- a. Shore Facilities.
 - (1) Painters should have detached shops or detached temporary structures where all paint should be mixed, and where paint buckets, brushes and rags can be temporarily stored.
 - (2) Only the quantity of paint needed for one day's work shall be taken into the mixing area.
- b. Forces Afloat.
 - (1) Paint shall not be stowed in the mixing area.
 - (2) Mixing of paints and their solvents shall be confined to the paint mixing room or other designated compartment.
 - (3) Paint shall not be mixed aboard a submarine.

7.7 SPECIFIC PAINTING REGULATIONS FOR SUBMARINES.

7.7.1 Motor Generator Units. Prior to any interior painting, Positive Pressure Unit must be activated if the Motor Generator is not sealed or is open within five days of paint application. This will prevent solvent from damaging motor generators.

7.7.2 Coating Material.

- a. Mix all paints BEFORE bringing it aboard the submarine. The use of paint pre-packaged in cartridge dispensing systems is encouraged because the paint is mixed in the static mixer as it is dispensed from the cartridge and open containers of paint are eliminated. MIL-DTL-24441 and VACTAN are currently the only paints that are used by Ship's Force available in cartridges.
- b. With the exception of topside boot or other areas that do not vent to the submarine interior, all appreciable painting described in this document shall be completed at least five days prior to departure for sea. (The date of departure, as it relates to painting, shall be the date of the first dive after departure for a period of operation. The Commanding Officer of the submarine involved should determine the "date of departure" whenever the question arises.)
- c. Bring onboard only the amount of paint than can be used in the immediate painting operation. The use of paint pre-packaged in cartridge dispensing systems is encouraged because a partially used cartridge can be capped and reused.
- d. Where paint is applied to surfaces that later will be heated (e.g., thermal piping and lagging), the systems shall be activated (heated) prior to sealing the boat.

7.7.3 Items Not To Be Painted. The following surfaces are not to be painted and, therefore, should be masked off when paint is applied in the vicinity:

- a. Corrosion Resistant Steel (CRES) on decks, CRES galley equipment and CRES bulkheads in wet spaces.
- b. Decorative plastic surfaces such as on bulkheads or table tops.
- c. Dogs and/or operating gear of watertight doors, hatches, scuttles and similar items.
- d. Hatch and door rubber gaskets.
- e. Labels (e.g., identification plates).
- f. Insulators.
- g. Knife edges of watertight doors and hatches.
- h. Tiled areas.
- i. Threaded parts, such as adjusting threads and take-up threads that, if painted, would not function properly.

- j. Anodic and cathodic protectors (zincs).
- k. Composition metal water ends of pumps.
- l. Condenser heads and outside surfaces of condensers when of composition metal.
- m. Exposed composition metal parts of any machinery.
- n. Glands, stems, yokes, toggle gear and all machined external parts of valves.
- o. Heat exchange surfaces of heating or cooling equipment.
- p. Joint faces of gaskets and packing surfaces.
- q. Lubricating gear, such as oil holes, oil or grease cups, lubricators and surfaces in contact with lubricating oil.
- r. Lubricating oil reservoirs.
- s. Charging water tanks.
- t. De-mineralized water tanks.
- u. Amine storage tanks.
- v. Machined metal surfaces of reciprocating engines or pumps and all "oil wetted" surfaces of internal combustion engines.
- w. Metal lagging.
- x. Rods, gears, universal joints and couplings of valve operating gear.
- y. Expansion joints, pipe hangers, flexible hose connections, items partially fabricated of rubber and rubber resilient elements of isolation mounts.
- z. Springs.
- aa. Strainers.
- ab. Turbine casing joints, nuts and bolts.
- ac. Working surfaces.
- ad. Brass, bronze, gun metal and copper where used in submarine systems.
- ae. Foundation bearing surfaces where alignment or sliding is required.
- af. Electrical outlets, terminals, activating mechanisms of electrical safety devices, control switchboards on machinery elevators and grounding contact surfaces.
- ag. Joints and contact surfaces of explosion-proof enclosures.
- ah. The following interior surfaces (aluminum surfaces may be waxed where desired for appearance).
- ai. Bins, shelves, dressers, drawers, cabinets, battens and fittings.
- aj. Interior gratings, hand rails and floor plates.
- ak. Internal surfaces of ventilation ducts.
- al. Sight glasses, gauge faces or identification plates or other markings, which, if painted, would be illegible.
- am. Faces of sonar transducers, hydrophones, no-foul rubber shelling, sonar dome rubber windows, rubber sonar domes and glass reinforced plastic domes.
- an. Any other components or surfaces where the application of paint would affect the fit, form or function.
- ao. When in doubt, contact the technical authority for guidance.

7.7.4 Shelf Life of Paints. Shelf life is the period after manufacture when the paint can be used. The date of manufacture is printed on the paint can. Refer to the PDS (or ASTM F-718 sheet) to determine the shelf life of the paint being used. Do not use paint that has passed the shelf life given on the PDS (or ASTM F-718 sheet). Partially used cartridges can be reused if the paint is still within the shelf life.

7.8 MIXING PROCEDURES.

7.8.1 Pre-Packaged Paint. The use of paint prepackaged in cartridge dispensing systems is encouraged because it eliminates mixing of paint. The cartridges may have to be shaken using a mechanical shaker designed for the cartridges. Cartridges are an alternative form of packaging and the dispensing system eliminates mixing. The properties of the paint remain the same with regard to WFT, spread rates, dry times, overcoat times, etc.

7.8.2 Mixing Observations. The following steps should be observed when mixing paint:

- a. Prior to mixing paint, read and understand information in the manufacturer's PDS or ASTM F-718.
- b. Mix all paints BEFORE bringing them aboard the submarine.
- c. Paints should be thoroughly mixed (3 to 5 minutes with a mechanical mixer) and free of lumps, cakes and sediments prior to use. Multiple component paints require thorough mixing of each component before they are combined.
- d. Mixing is best accomplished by the use of mechanical shakers or stirrers. Ground all mixing equipment shakers, stirrers, containers and platforms prior to use.
- e. If a mechanical device is not available, a manual method, such as the boxing method, may be used. The boxing method is a manual paint mixing technique that is used in combination with manual stirring as described below:
 - (1) Pour the top two-thirds of the paint from the original can (#1) into a clean empty can (#2).
 - (2) Stir the pigment and liquid left in can #1 with a paddle until smooth.
 - (3) Gradually pour the paint in can #2 into can #1 while stirring.
 - (4) Pour the paint from can #1 into can #2. Reverse this step and repeat until the paint is uniformly smooth.
 - (5) If any particles do not dissolve after stirring and mixing, strain the paint through a wire screen or two layers of cheesecloth.
- f. The following list of "DO NOTS" should be observed when mixing paints:
 - (1) DO NOT make any assumptions about the correct procedure for mixing paints. Consult the paint manufacturer's PDS or ASTM F-718 sheet.
 - (2) DO NOT mix more paint than can be used during the pot life time period. Read PDS (or ASTM F-718 sheet) for pot life.
 - (3) DO NOT mix components of different paint formulas.
 - (4) DO NOT use paint with large undissolved particles.
 - (5) DO NOT dilute paints with solvents (thinners).
 - (6) DO NOT keep epoxy paints out in the sun in warm weather, including epoxy paint pre-packaged in cartridges.

7.8.3 Mixing and Application Procedures for the Navy Epoxy Paint System. Navy epoxy Formula 150 is a primer coat that can be applied to bare metal or to sound paint. Topcoats of various colors (Formulas 151-156) are used for specific applications. Formula 151 is the gray color most commonly used. The following procedures should be followed in mixing these paints. Read and understand the manufacturer's current PDS or ASTM F-718 sheet.

- a. The Navy epoxy paints are supplied in kits containing two components. One container is labeled Component A and the other is labeled Component B. These components are mixed in a 1:1 ratio by volume, i.e., for one gallon of component A add an equal amount of component B. Check the designation on both containers before mixing to ensure that the proper components are being used. The components of the various formula numbers are NOT interchangeable.
- b. Both components in an epoxy paint kit must be stirred separately prior to mixing them together. After combining equal volumes of the two components, the mixture must be thoroughly stirred until well blended, and then allowed to react for the appropriate "induction" stand-in time as stated in the PDS (or ASTM F-718 sheet). Type IV does not require an induction period, but earlier formulations (Types I and III) require induction.
- c. If an induction period is required, the paint should be stirred or agitated for at least 2 minutes every 30 minutes during the induction period. Two minutes of stirring or agitation are required at 4-hour intervals during the application process.
- d. When Navy epoxy paints are used at a work site having temperatures in the range 35° to 50°F, it is essential that the paint components be pre-warmed to 70°F, mixed, and then allowed to stand for 2 hours prior to delivery to the work site. The preferred method of pre-warming is to store unmixed paint at 70°F for 24 hours prior to the job.
- e. After being mixed, epoxy paints must be used within the pot life period, as specified in the PDS (or ASTM F-718 sheet).
- f. During maintenance painting, brush application is recommended for the first coat of paint over mechanically cleaned surfaces such as hand-cleaned bilges. The brushing forces the paint into surface contaminants or displaces them. The MIL-P-24441 paints do not require thinning before application. Apply the topcoat(s) after the first coat has dried.
- g. If more than seven days elapse before over coating, the surface should be cleaned with water and detergent (if required) for grease and oil removal. This should be followed by a fresh water rinse and wiped dry. Then, a tack coat (1 to 2 wet mils) of the last coat applied or Formula 150 is reapplied to the hard epoxy coat and allowed to dry approximately four hours before application of the next full coat of the system.
- h. If more than 30 days elapse before over coating, clean and roughen the aged topcoat before new paint application.

7.8.4 Mixing and Application Procedures for Commercial Epoxy Paint Systems. Read and understand the manufacturer's current PDS or ASTM F-718 sheet. Specific items that vary depending on the coating manufacturer include:

- a. Mix ratio. Mixing the two components in the proper ratio is absolutely vital.
- b. Induction period. Refer to PDS (or ASTM F-718 sheet) for induction times.
- c. Both components in an epoxy paint kit must be stirred separately prior to mixing them together. In short, there are several qualified commercial epoxy coating systems that are authorized for touch-up painting. They vary depending on the manufacturer. Follow instructions in the PDS or ASTM F-718 sheet for the particular coating being used.

7.9 PAINT APPLICATION.

7.9.1 General Considerations.

- a. Inspect cleaned areas of the ship to determine the suitability of the surfaces for applicable touch-up or repainting operations. Surfaces shall be free of rust, deteriorated paint, dust, scale, oil, grease, salt deposits or other surface contaminants.
- b. Do not paint over oily, damp or icy surfaces.
- c. Never paint over loose, badly cracked or blistered paint. Old paint in good condition is an excellent base and should be cleaned, roughened and dried before repainting.

- d. Under normal circumstances, the following environmental conditions apply:
 - (1) Surface temperature shall be at least 5° F higher than the dew point.
 - (2) Paint should not be applied at temperatures of 35°F or lower; check the PDS or ASTM D-718 sheet for the low temperature application limit.
 - (3) Wind velocity should be below 15 miles per hour (exterior work).
 - (4) Relative humidity below 85 percent.
- e. When successive coats of the same paint are used, different colors should be applied to visually facilitate complete coverage.
- f. Apply paint as soon as possible after surface preparation has been completed. Bare metal surfaces will flash rust soon after exposure to the atmosphere.
- g. When painting over a fully cured epoxy paint film, use a "tie coat" to ensure proper adhesion of the overcoat to the existing paint. A tie coat is a thin layer of paint (generally the same type of paint as the preceding coat) that is applied to the surface by brush or roller. The coat should be applied to a DFT of approximately 1 mil (2 mils WFT).
- h. When painting over welds or in hard-to-get-at spaces that could not be cleaned to the proper surface cleanliness, brush on the first coat of paint to obtain the best adhesion. This comment applies to corners behind stiffeners or over weld seams. Hidden areas should be inspected with a pocket mirror to ensure total coverage before applying each succeeding coat and after the final coat.
- i. Do not store paints and solvents inside submarines. Remove paint from the submarine when painting is completed or interrupted.
- j. When replacing anodes, ensure that the area under the anode is adequately painted, but **DO NOT PAINT THE ANODES** themselves.

7.9.2 **Brush Application.** In larger areas, start work on overhead areas first, and then work downward. Begin painting at a corner or some other logical vertical division. Cover only that area which can be easily reached without moving ladders. Work downward, painting progressive sections to the deck level, then start at the top of the adjacent area and work down again. Paint trim, doors or similar areas after bulkheads and other major surfaces are completed.

- a. Dip the brush into the paint up to ½ the bristle length. Withdraw the brush and tap it against the inside of the bucket to remove excess paint. Hold the brush at a 45° angle to the surface to be painted. Make several light strokes in the area to be painted. This will transfer much of the paint to the surface. Then spread the paint evenly and uniformly. Do not bear down on the brush.
- b. When using paint dispensing cartridges, apply a small amount to an area and spread evenly with a brush. It is better to start with a small amount and apply additional paint, than to dispense a large amount which may have to be spread into areas that were not prepared for painting.
- c. When one section of the surface is painted, adjacent areas should be painted so that the brush strokes are completed by sweeping the brush into the wet edge of the paint previously applied. This helps eliminate lap marks and provides a more even coating.
- d. Finally, cross-brush lightly to smooth the painted surface and to eliminate brush or sag marks. Very fast drying finishes will not permit much brushing and cross-lapping; in such cases, the paint shall be applied, spread rapidly and then allowed to dry undisturbed. Going back over a fast drying finish will cause piling up of the coating.

7.9.3 **Roller Application.** To apply paint with a roller, pour the premixed paint into the tray to about ½ tray depth. Immerse the roller and then roll it back and forth along the ramp to coat the roller cover completely. (A specially designed galvanized mesh screen positioned vertically in a 5-gallon bucket may be used instead of a paint tray.) The first load of paint should be worked out on a newspaper to remove trapped air from the roller cover. It is then ready to apply to a surface. Always roll paint onto the surface, working from the dry area into the area just painted. Never roll completely in the same direction. One good technique is to roll the paint onto the surface in a "W" pattern while

the roller is very wet. Distribute the paint using horizontal or vertical strokes. Pressure must be applied when rolling or the paint will not adhere and will soon peel off. Do not roll too fast. Avoid spinning the roller at the end of a stroke. Always feather out final strokes to pick up any excess paint on the surface. Feathering is done by rolling out the final stroke with minimal pressure. Paint from cartridge dispensing systems can be poured into trays for roller application.

NOTE: SPRUCE BARGE AND FMA PERSONNEL ARE TRAINED IN THE USE OF WFT GAUGES AND SHOULD BE CONSULTED FOR ASSISTANCE.

7.9.4 Wet Film Thickness Check. The performance of the coating depends on applying the proper thickness. The proper thickness, called DFT, is stated in the PDS or ASTM F-718 sheet. In order to obtain the proper DFT, WFT must be measured and controlled during application. The required WFT for a coating is stated in the PDS or ASTM F-718 sheet. A WFT gauge is used to measure the thickness of a coat of paint that is still wet to the touch. A typical wet film gauge (Figure 3) has several legs, with each of the inner legs (measuring legs) of varying known lengths and somewhat shorter than the two outer legs (support posts). When the gauge edge is pressed into the wet film (Figure 4), the two outer legs penetrate through the wet film to the substrate. Depending on the thickness of the wet film, some of the inner legs will dip into the wet film while others will not touch it. The length of longest inner leg that is wetted by the coating is the WFT (Figure 5). Proper use of the wet film gauge includes the following:

- a. Measure WFT during coating application to determine if sufficient paint has been applied. The PDS or ASTM F-718 sheet will provide the required WFT.
- b. Use the WFT gauge only on a flat surface. Both end legs must be firmly touching the steel surface.
 - (1) On a vertical surface, such as a bulkhead, hold the gauge in a north-south (vertical) position with the longer legs at the top.
 - (2) On a pipe, place the gauge along the length. Both legs must touch the surface.
- c. Lift the gauge from the surface without sliding. Slipping and sliding will give an inaccurate reading because extra paint will be picked up on the legs.
- d. Use only a clean, dry gauge. Clean the gauge after each reading. Dirt or old paint on the bottoms of the legs adds to their length giving lower readings.



Figure 3. Wet Film Thickness Gauge.



Figure 4. WFT Gauge Positioned in Wet Paint Film.



Figure 5. WFT Gauge Showing a Reading of 4-5 Mil.

1. Notice black paint on outer support posts and on measuring legs 1, 2, 3 and 4. No paint on measuring legs 5 and 6.
2. Wet film gauges may be purchased from:
www.elcometer.com (From home page: "Film Thickness Gauge"; then "Wet Film Thickness".) Elcometer 154 Plastic Wet Film Combs may be an inexpensive option.

Also, vendors from various coating companies often offer wet film gauges.

7.9.5 Overcoating. Most paint systems consist of more than one coat of paint. Proper steps for overcoating include the following:

- a. Consult the PDS or ASTM F-718 sheet to determine the necessary "wait time" before overcoating.
- b. Remember that the time before overcoating is dependent on the temperature. Generally, as the temperature increases, the time before overcoating decreases.
- c. Remember - PDS (or ASTM F-718 sheet) guidance for time before overcoating is only an estimate.

- d. Always check the applied coating before overcoating. If the applied coating is wet, allow more time.
- e. Check the WFT using a WFT gauge (Paragraph 7.9.4 of this chapter).

7.10 QUICK REFERENCE SECTION.

7.10.1 Surface Preparation and Paint Application in Specific Areas. A summary of areas expected to be maintained by Ship's Force is shown in Table 1. Along with each area is a reference for surface preparation and the required coating system. For each area, a summary procedure is provided.

AREA	SURFACE PREP	COATING
Bilge	Paragraph 7.10.2.1	1 ct - F-150, Type IV (MIL-DTL-24441/29A) 1 ct - F-151, Type IV (MIL-DTL-24441/30A)
Sail (interior)	Paragraph 7.10.3.1	1 ct - F-150, Type IV (MIL-DTL-24441/29A) 1 ct - F-151, Type IV (MIL-DTL-24441/30A)
Non-skid (not tiled)	Paragraph 7.10.4.1.1	1 ct - primer (proprietary or F-150, Type IV) 1 ct - MIL-PRF-24667B non-skid
Non-skid (tiled)	Paragraph 7.10.4.2.1	2 cts - F-184 (MIL-DTL-24631/1C) 1 ct - F-187 (MIL-DTL-24631/7)
SHT-Topside, sail and rudder	Paragraphs 7.10.4.3.1 7.10.4.3.2	1 ct - F-187 (MIL-DTL-24631/7)
High temperature piping	Paragraph 7.10.5.1	TT-P-28G (Low VOC heat resisting aluminum)
Underway painting	Paragraph 7.10.6.3	VACTAN or UNITED 303 TRIUMPH
Miscellaneous areas of general corrosion (including high solids coatings)	Paragraph 7.10.7.1	1 ct - F-150, Type IV (MIL-DTL-24441/29A) 1 ct - F-151, Type IV (MIL-DTL-24441/30A)
Interior decks/walking surfaces	Section 7.5	1 ct - F-84 (TT-P-645B) 2 cts - MIL-PRF-24635C
Interior bulkheads/overheads	Section 7.5	1 ct - F-84 (TT-P-645B) 2 cts - F-124 (white), F-125 (pastel green), F-126 (bulkhead gray), F-131 (MIL-DTL-24607) <u>OR</u> 2 cts - F-25A (MIL-PRF-24596A)
Painting behind equipment (interior)	Section 7.5	2 cts - F-84 (TT-P-645B)
Exterior of motors, generators and electronic equipment	Section 7.5	1 ct - F-84 (TT-P-645B) 2 cts - F-111 (MIL-DTL-15090D)

Table 1. Summary of Areas for Touch-Up Painting by Ship's Force.

7.10.2 Bilges.

7.10.2.1 Surface Preparation.

- a. Required Tools:
 - (1) Needle gun.
 - (2) Inspection mirror (for seeing hard-to-reach areas such as the backsides of beams).

- (3) Brush and dust pan.
 - (4) Shop-Vac type vacuum cleaner.
- b. Process:
- (1) Read and understand Section 7.3 of this chapter, "General Safety Precautions".
 - (2) Read and understand Section 7.5 of this chapter, "General Surface Preparation".
 - (3) Solvent clean to remove oil, grease, dirt, chemicals and water-soluble contaminants. If solvents are prohibited, use detergent and fresh water. When implementing these procedures, work sections no larger than 6 feet by 6 feet (36 square feet) should be cleaned at a time. Longitudinal and transverse structural members can be used as boundaries to define the work section. Each section should be fully cleaned and primed before starting work on the next section.
 - (4) Use a needle gun to remove loose paint and rust. A needle gun is most effectively used by holding it 90° to the surface, making 2-3 passes about 6-8 inches in length over the same path, then moving over and repeating the process until the entire area is completed. The goal is removal of all rust, loose mill scale and paint to bare metal.
 - (5) Feather the edges (Paragraph 7.9.3 of this chapter).
 - (6) Brush and vacuum loose pieces and dust.
 - (7) Check the surface for oil that may have been deposited during surface preparation. If necessary, solvent clean to remove oil. The presence of excess salts on the surface will cause premature coating failure. Therefore, surface conductivity measurements should be made at this point. Contact SPRUCE barge, FMA or other knowledgeable personnel if help is needed. If excessive surface conductivity is measured, wash the area with fresh water and repeat Step (7).
 - (8) Apply paint as soon as possible (ideally, the same day) after surface preparation has been completed. Bare metal surfaces will flash rust soon after exposure to the atmosphere. If flash rusting occurs prior to coating application, repeat Steps (3)-(8).

7.10.2.2 Paint Application. Prior to any interior painting, Positive Pressure Unit must be activated. This will prevent solvent from damaging Motor Generators.

- a. Required Tools:
- (1) Rollers.
 - (2) Brushes.
 - (3) Rags.
 - (4) Manufacturer's PDS or ASTM F-718 sheet for the following paints:
 - (a) Formula 150, Type IV (MIL-DTL-24441, Formula 150, Type IV, green primer).
 - (b) Formula 151, Type IV (MIL-DTL-24441, Formula 151, Type IV, haze gray).
 - (5) Manufacturer's MSDS for the following paints:
 - (a) Formula 150, Type IV, Component A (MIL-DTL-24441, Formula 150, Type IV, green primer, component A).
 - (b) Formula 150, Type IV, Component B (MIL-DTL-24441, Formula 150, Type IV, green primer, component B).
 - (c) Formula 151, Type IV, Component A (MIL-DTL-24441, Formula 151, Type IV, haze gray, component A).

- (d) Formula 151, Type IV, Component B (MIL-DTL-24441, Formula 151, Type IV, haze gray, component B).
- b. Process:
- (1) Read and understand Section 7.6 of this chapter, "General Mixing and Paint application".
 - (2) Read and understand the PDS (or ASTM F-718 sheet) and MSDS for the two paint systems to be used.
 - (a) F-150, Type IV, green primer and F-151.
 - (b) Type IV, haze gray top coat.
 - (3) Ensure proper ventilation is in place. Maintain ventilation through the curing of the applied coatings.
 - (4) Check environmental conditions. Ask for help from SPRUCE barge or FMA personnel.
 - (5) Surface temperature shall be at least 5° F higher than the dew point.
 - (6) Paint shall not be applied at temperatures of 35°F or lower.
 - (7) Relative humidity shall be below 85 percent.
 - (8) Mix F-150, Type IV, green primer according to manufacturer's instructions. Mix ratio is 1:1 by volume. (Paragraph 7.8.3 of this chapter, Mixing and Application Procedures for the Navy Epoxy Paint System (MIL-DTL-24441)).

7.10.2.3 Summary. Table 2 summarizes mixing, application and re-coat parameters.

Paint	Induction Period (hours)	Mix Ratio (volume)	Pot Life (hours)	Time Before Overcoating (hours)	Time to Handle (hours)	Wet Film Thickness (mils)	Dry Film Thickness (mils)
F-150, green primer	N/A	1 : 1	6 @ 70° F	Minimum of 3 @ 40° F 3 @ 70° F @ 50% RH	Minimum of 24 @ 40° F 5 @ 70° F @ 50% RH	6-7	4-5
F-151, gray topcoat	N/A	1 : 1	6 @ 70° F	Minimum of 3 @ 40° F 3 @ 70° F @ 50% RH	Minimum of 24 @ 40° F 5 @ 70° F @ 50% RH	6-7	4-5

Table 2. Mixing, Application and Re-Coat Parameters for Bilges.

- a. Apply by brush. Be certain to force coating into corners, behind beams and areas that are difficult to reach. Pay particular attention to newly installed components such as pipe hangers and clamps. (Paragraph 7.9.2 of this chapter, "Brush Application")
- b. Check WFT to assure proper thickness (Paragraph 7.9.4 of this chapter).
- c. Wait until the first coat is dry, a minimum of 3 hours, before overcoating. If, after 3 hours, coating is not dry, check hourly by pressing thumbnail into surface. Coating is dry when thumbnail does not penetrate.
- d. When first coat is dry, apply a "stripe" coat on welds, corners and edges. The "stripe" coat should be a different color than either the first coat (green) or the topcoat (gray) to facilitate coverage. F-153, Type IV, a black coating, is a good choice. If a different color is not available, use F-151, Type IV, gray as the "stripe" coat.
- e. When the "stripe" coat is adequately dry, mix F-151, Type IV, gray topcoat according to manufacturer's instructions. Mix ratio is 1:1 by volume. (Paragraph 7.8.3 of this chapter, Mixing and Application Procedures for the Navy Epoxy Paint System (MIL-DTL-24441).)

- f. Apply by brush or roller if a roller can reach all areas that need paint. (Paragraph 7.9.2 of this chapter, "Brush Application"; Paragraph 7.9.3 of this chapter "Roller Application".) If F-151 was used as the "stripe" coat, pay particular attention to completely cover the "stripe" coat since there is no color difference to provide visual contrast.
- g. Check WFT to assure proper thickness (Paragraph 7.9.4 of this chapter).
- h. Freshly painted areas should be roped off to prevent contamination during the curing process. Allow coating to cure per the curing schedule given in the PDS (or ASTM F-718 sheet).
- i. Ventilation should be in place during the curing process as it will facilitate curing and prevent build-up of hazardous vapors.

7.10.3 Sail (Interior).

7.10.3.1 Surface Preparation.

- a. Required Tools:
 - (1) Needle gun.
 - (2) Long-handled paint scraper.
 - (3) Coarse sand paper.
 - (4) Inspection mirror (for seeing hard-to-reach areas such as the backsides of beams).
 - (5) Brush and dust pan.
 - (6) Shop-Vac type vacuum cleaner.
- b. Process:
 - (1) Read and understand Section 7.5 of this chapter, "General Surface Preparation".
 - (2) Solvent clean to remove oil, grease, dirt, chemicals and water-soluble contaminants. If solvents are prohibited, use detergent and fresh water.
 - (3) Use the long-handled scraper to remove any areas of exfoliated metal. Because many areas in the sail are difficult to preserve, advanced corrosion, including exfoliation may occur. In the periscope bay, the bulkhead just forward of the bearing frame is a typical area. Exfoliation is the "delamination" of metal into layers. All exfoliated layers must be removed by scraping them off.
 - (4) Starting at the top of a bay and working to the bottom, use a needle gun to remove loose rust and paint. A needle gun is most effectively used by holding it 90° to the surface, making 2-3 passes about 6-8 inches in length over the same path, then moving over and repeating the process until the entire area is completed. The goal is removal of all rust, loose mill scale and paint to bare metal. In areas not accessible by needle gun, use scrapers followed by coarse sand paper. Feather the edges.
 - (5) When needle gunning and sanding are complete, brush and vacuum loose pieces and dust from the area. Be sure to get "shelves" and "throughs" and other "collection points".
 - (6) Check the surface for oil that may have been deposited during surface preparation. If necessary, solvent clean to remove oil.
 - (7) The presence of excess salts on the surface will cause premature coating failure. Therefore, surface conductivity measurements should be made at this point (Paragraph 7.5.8 of this chapter) if the area is exposed to seawater. Contact SPRUCE barge, FMA or other knowledgeable personnel if help is needed. If excessive surface conductivity is measured, wash the area with fresh water and repeat the step.
 - (8) Apply paint as soon as possible (ideally, the same day) after surface preparation has been completed. Bare metal surfaces will flash rust soon after exposure to the atmosphere. If flash rusting occurs prior to coating application, repeat Steps (5)-(8).

7.10.3.2 Paint Application.

- a. Required Tools:
 - (1) Rollers.
 - (2) Brushes.
 - (3) Rags.
 - (4) WFT gauge.
 - (5) Manufacturer's PDS or ASTM F-718 sheet for the following paints:
 - (a) Formula 150, Type IV (MIL-DTL-24441, Formula 150, Type IV, green primer).
 - (b) Formula 151, Type IV (MIL-DTL-24441, Formula 151, Type IV, haze gray).
 - (6) Manufacturer's MSDS for the following paints:
 - (a) Formula 150, Type IV, Component A (MIL-DTL-24441, Formula 150, Type IV, green primer, component A).
 - (b) Formula 150, Type IV, Component B (MIL-DTL-24441, Formula 150, Type IV, green primer, component B).
 - (c) Formula 151, Type IV, Component A (MIL-DTL-24441, Formula 151, Type IV, haze gray, component A).
 - (d) Formula 151, Type IV, Component B (MIL-DTL-24441, Formula 151, Type IV, haze gray, component B).
- b. Process:
 - (1) Read and understand Section 7.6 of this chapter, "General Mixing and Paint Application".
 - (2) Read and understand the PDS (or ASTM F-718 sheet) and MSDS for the two paint systems to be used.
 - (a) F-150, Type IV, green primer.
 - (b) F-151, Type IV, haze gray top coat.
 - (3) Check environmental conditions. Ask for help from SPRUCE barge or FMA personnel.
 - (a) Surface temperature shall be at least 5° F higher than the dew point.
 - (b) Paint shall not be applied at temperatures of 35°F or lower.
 - (c) Relative humidity shall be below 85 percent.
 - (4) Mix F-150, Type IV, green primer according to manufacturer's instructions. Mix ratio is 1:1 by volume. (Paragraph 7.8.4 of this chapter, Mixing and Application Procedures for the Navy Epoxy Paint System (MIL-DTL-24441)).
- c. Summary.

Table 3 summarizes mixing, application and overcoat parameters.

Paint	Induction Period (hours)	Mix Ratio (volume)	Pot Life (hours)	Time Before Overcoating (hours)	Time to Handle (hours)	Wet Film Thickness (mils)	Dry Film Thickness (mils)
F-150, green primer	N/A	1 : 1	6 @ 70° F	Minimum of 3 @ 40° F 3 @ 70° F @ 50% RH	Minimum of 24 @ 40° F 5 @ 70° F @ 50% RH	6-7	4-5
F-151, gray topcoat	N/A	1 : 1	6 @ 70° F	Minimum of 3 @ 40° F 3 @ 70° F @ 50% RH	Minimum of 24 @ 40° F 5 @ 70° F @ 50% RH	6-7	4-5

Table 3. Mixing, Application and Overcoat Parameters for Sail (Interior).

- (1) Apply by brush. Be certain to force coating into corners, behind beams and areas that are difficult to reach. (Paragraph 7.9.2 of this chapter, "Brush Application".)
- (2) Check WFT to assure proper thickness (Paragraph 7.9.4 of this chapter). Wait until the first coat is dry, a minimum of 3 hours, before overcoating. If, after 3 hours, coating is not dry, check hourly until coating is dry. REMEMBER - PDS (or ASTM F-718 sheet) and Table 3 guidance for overcoating interval is an estimate. You must be able to walk on the first coat without damaging it.
- (3) When first coat is dry, apply a "stripe" coat on welds, corners and edges. The "stripe" coat should be a different color than either the first coat (green) or the topcoat (gray) to facilitate coverage. F-153, Type IV, a black coating, is a good choice. If a different color is not available, use F-151, Type IV, gray as the "stripe" coat.
- (4) When the "stripe" coat is adequately dry, mix F-151, Type IV, gray topcoat according to manufacturer's instructions. Mix ratio is 1:1 by volume. (Paragraph 7.8.3 of this chapter, Mixing and Application Procedures for the Navy Epoxy Paint System (MIL-DTL-24441)).
- (5) Apply by brush or roller (if a roller can reach all areas that need paint). (Paragraph 7.9.2 of this chapter, "Brush Application"; Section 7.9.3 of this chapter "Roller Application".) If F-151 was used as the "stripe" coat, pay particular attention to completely cover the "stripe" coat since there is no color difference to provide visual contrast.
- (6) Check WFT to assure proper thickness (Paragraph 7.9.4 of this chapter). Freshly painted areas should be roped off to prevent contamination during the curing process.
- (7) Allow coating to cure per the curing schedule given in the PDS (or ASTM F-718 sheet). Ventilation should be in place during the curing process as it will facilitate curing and prevent build-up of hazardous vapors.

7.10.4 Non-Skid Areas.

7.10.4.1 Areas That Are Not Tiled With Special Hull Treatment. Non-skid paints are not to be applied to hatch covers, Submarine Rescue Diving Recompression System seating surfaces, safety tracks, life line sockets, deck fittings and gear, faying surfaces of hatches, contact or bearing surfaces, and approximately 1 inch around the periphery of hatches, cleats and access covers.

7.10.4.1.1 Surface Preparation.

a. Required Tools:

- (1) Dull putty knife.
- (2) Needle gun.

- (3) Brush and dust pan.
- (4) Shop-Vac type vacuum cleaner.
- b. Process:
 - (1) Read and understand Section 7.5 of this chapter, "General Surface Preparation".
 - (2) When a coating failure is detected, the area shall be probed with a dull putty knife or similar instrument, to determine the extent of failure. Once the failure area is identified, the area to be repaired shall extend slightly (at least 3 inches) outside the perimeter of the failing area to ensure the problem is corrected.
 - (3) Clean the surface by removing foreign matter such as oil, grease, dirt and other contaminants. Solvent cleaning is recommended. If solvent cleaning is not permitted, use a commercial cleaner, such as Simple Green or Spray 9. Use only clean, white, lint-free rags and change rags often.
 - (4) Use a needle gun to remove all loose paint and rust from the failed area. A needle gun is most effectively used by holding it 90° to the surface, making 2-3 passes about 6-8 inches in length over the same path, then moving over and repeating the process until the entire area is completed. The goal is removal of all rust, loose mill scale and paint to bare metal.
 - (5) Feather the edges.
 - (6) When needle gunning and sanding are complete, brush and vacuum loose pieces and dust from the area. Again, clean the surface. Solvent cleaning is recommended. If solvent cleaning is not permitted, use a commercial cleaner, such as Simple Green or Spray 9. Use only clean, white, lint-free rags and change rags often.
 - (7) The presence of excess salts on the surface can cause premature coating failure. Therefore, surface conductivity measurements should be made at this point. Contact SPRUCE barge or FMA personnel if help is needed.
 - (8) Apply paint as soon as possible (ideally, the same day) after surface preparation has been completed.

7.10.4.1.2 Paint Application.

- a. Required Tools:
 - (1) Rollers.
 - (2) Brushes.
 - (3) Rags.
 - (4) WFT gauge.
 - (5) Manufacturer's PDS or ASTM F-718 sheet for the MIL-C-24667 non-skid paint system.
 - (6) Manufacturer's MSDS for the MIL-C-24667 non-skid paint system.
- b. Process:

NOTE: THE USE OF F-150 (MIL-DTL-24441) PRIMER IS PROHIBITED UNLESS A NON-SKID SYSTEM HAS BEEN QUALIFIED WITH A SPECIFIC MANUFACTURER'S F-150 AS A PRIMER.

- (1) Read and understand the PDS (or ASTM F-718 sheet) and MSDS for the non-skid paint systems. Most non-skid systems require a primer system. If a primer is required, check with the manufacturer to determine if MIL-DTL-24441, Formula 150, Type IV, green primer is authorized. The qualified products list of the specification being used shall be consulted to determine if a particular Formula 150 can be used as a primer. SPRUCE barge or FMA personnel can provide this information.

- (2) Check environmental conditions. Ask for help from SPRUCE barge or FMA personnel.
 - (a) Surface temperature shall be at least 5° F higher than the dew point.
 - (b) Paint shall not be applied at temperatures of 50°F or lower.
 - (c) Relative humidity shall be below 85 percent.
- (3) Mix the primer according to manufacturer's instructions. Be sure to check for an induction period. If an induction period is required, mix for one minute after induction. If F-150 is authorized and is being used as a primer, see Paragraph 7.8.3 of this chapter (Mixing and Application Procedures for the Navy Epoxy Paint System (MIL-DTL-24441)).
- (4) Apply primer by brush or roller. (Paragraphs 7.9.2, "Brush Application" and 7.9.3 "Roller Application" of this chapter.)
- (5) Check WFT to assure proper thickness (Paragraph 7.9.4 of this chapter).
- (6) Wait until the primer coat is dry before mixing the MIL-C-24667 non-skid coating system. Thoroughly mix the base material of the non-skid using the type of mixer specified in the manufacturer's ASTM F-718 sheets. Make sure that all materials which may have settled during storage (pigments, fillers, aggregate) are lifted from the bottom of the container and are uniformly mixed. Slowly pour the contents of the can of converter (also called hardener, accelerator or curing agent) into the base material. Scrape the bottom of the base material can. Mix converter and base material for 3 to 5 minutes or until uniform color and appearance. Scrape the bottom of the can and mix again for 3 to 5 minutes. If an induction period is required, stir again for one minute after the induction period. Thinning non-skid is strictly prohibited.
- (7) Apply by roller or trowel. If a roller is used, roll across (not along) welds. Cross-rolling shall extend 3 to 6 inches on each side of the weld. If troweling, consult the manufacturer's PDS (or ASTM F-718 sheet) for recommended trowel size.
- (8) Check WFT to assure proper thickness (Paragraph 7.9.4 of this chapter).
- (9) Freshly painted areas should be roped off to prevent contamination during the curing process.
- (10) Allow coating to cure per the curing schedule given in the PDS (or ASTM F-718 sheet).
- (11) Ventilation should be in place during the curing process as it will facilitate curing and prevent build-up of hazardous vapors.

7.10.4.2 Special Hull Treatment Tiled Areas (Non-Skid). Non-skid paints are not to be applied to hatch covers, Submarine Rescue Diving Recompression System seating surfaces, safety tracks, life line sockets, deck fittings and gear, faying surfaces of hatches, contact or bearing surfaces and approximately one inch around the periphery of hatches, cleats and access covers.

7.10.4.2.1 Surface Preparation.

- a. Required Tools:
 - (1) 80-100 grit aluminum oxide paper.
 - (2) Shop-Vac type vacuum cleaner.
 - (3) Manufacturer's MSDS for PF-145 HP solvent.
- b. Process:
 - (1) Read and understand Section 7.3 of this chapter, "General Safety Precautions".
 - (2) Read and understand Section 7.5 of this chapter, "General Surface Preparation".
 - (3) Clean the surface of any grease, oil, salt or other residue with a detergent solution and rinse with fresh water.

CAUTION: THE COVERPLY OF THE TILES CONTAINS APPROXIMATELY 10% BY WEIGHT LEAD OXIDE, AN ADDITIVE USED TO CONTROL THE RATE OF WATER ABSORPTION BY THE TILES. WHENEVER SANDING OR GRINDING TILE SURFACES, BE CERTAIN TO WEAR PROPER PPE.

- (4) Hand sand the surface using 80-100 grit aluminum oxide paper to roughen the surface of the tiles for better adhesion. Be sure to remove all old paint in the touch-up area.
- (5) Vacuum up dust.
- (6) Clean surface of remaining dust by wiping with PF-145 HP solvent poured directly onto a clean rag. Do not dip the rag into the solvent. Change rags frequently.
- (7) Apply paint as soon as possible (ideally, the same day) after surface preparation has been completed.

7.10.4.2.2 Paint Application.

a. Required Tools:

- (1) Short nap rollers.
- (2) Brushes.
- (3) Rags.
- (4) Manufacturer's PDS or ASTM F-718 sheet for MIL-A-22262 abrasive grit material.
- (5) Manufacturer's PDS or ASTM F-718 sheet for the following paints:
 - (a) Formula 184 (black flexible epoxy).
 - (b) Formula 187 (black polyurethane camouflage).
- (6) Manufacturer's MSDS for the following paints:
 - (a) Formula 184, Component A (black camouflage epoxy).
 - (b) Formula 184, Component B (black camouflage epoxy).
 - (c) Formula 187, Component A (black polyurethane camouflage).
 - (d) Formula 187, Component B (black polyurethane camouflage).

b. Process:

- (1) Read and understand Section 7.8 of this chapter, "General Mixing and Paint application".
- (2) Read and understand the PDS (or ASTM F-718 sheet) and MSDS for the Formula 184 and Formula 187 paint systems.
- (3) Check environmental conditions. Ask for help from SPRUCE barge or FMA personnel.
 - (a) Surface temperature shall be at least 5° F higher than the dew point.
 - (b) Paint shall not be applied at temperatures of 50°F or lower.
 - (c) Relative humidity shall be below 75 percent.

CAUTION: MIXING SHOULD BE PERFORMED AT A TEMPERATURE OF 50⁰ F OR ABOVE.

- (4) Thoroughly mix the A and B components of Formula 184 (black epoxy) in their individual containers by hand stirring. Mix the A and B components together in a 1:1 ratio by volume.

c. Summary.

- (1) Table 4 summarizes mixing, application and overcoat parameters.

Paint	Induction Period (minutes)	Mix Ratio (volume)	Pot Life (hours)	Time Before Overcoating (hours)	Time to Handle (hours)	Wet Film Thickness (mils)	Dry Film Thickness (mils)
F-184, black epoxy camouflage	30 @ 70-90° F 45 @ 55-70° F	1 : 1 (Mix at 50° or above)	2 (maximum)	6 hours (minimum) - 6 months	24 (maximum)	8 - 9	4 -5
F-187, black polyurethane camouflage	None	4 : 1 (Mix at 50° or above)	1 (minimum)	18 hours - 7 days	18 (maximum)	4-5	3

Table 4. Mixing, Application and Overcoat Parameters for Non-Skid Areas.

- (2) Apply the F-184 paint in a smooth uniform layer using a paint brush or roller. (Paragraphs 7.9.2, "Brush Application" and 7.9.3 "Roller Application" of this chapter.) Due to difficulty in removing old paint from depressed tile seam areas, "stripe" these areas with a wide brush prior to roller application.
- (3) Check WFT to assure proper thickness (Paragraph 7.9.4 of this chapter). WFT should be 8-9 mils.
- (4) While the epoxy paint is still wet, sprinkle the abrasive grit material onto the freshly painted film to achieve a uniform roughness over the entire area.
- (5) When the first coat is dry, apply a second coat of Formula 184 black epoxy paint.
- (6) When the second coat of Formula 184 black epoxy is dried, a sealer coat of Formula 187 polyurethane paint must be applied.
- (7) Mix the A and B components of the Formula 187 black polyurethane paint together in a 4:1 ratio by volume. Mix entire gallon of A with entire quart of B. The mixture should be thoroughly blended for two minutes after which it can be used immediately. (There is no induction time for the polyurethane paint.)
- (8) Due to difficulty in removing old paint from depressed tile seam areas, "stripe" these areas with a wide brush prior to roller application.
- (9) Apply the F-187 paint in a smooth uniform layer using a paint brush or roller. (Paragraphs 7.9.2, "Brush Application" and 7.9.3 "Roller Application" of this chapter.)
- (10) Allow 24 hours for paint to cure before permitting foot traffic. Freshly painted areas should be roped off to prevent contamination of the coating.
- (11) Paint should cure for a minimum of 5 days prior to submerging.

7.10.4.3 Special Hull Treatment Tiles - Topside, Sail and Rudder. Due to poor performance of epoxy camouflage paint (Formula 184, old DTRC 2844-1118 formula) when exposed to sunlight, Formula 187, a non-fading polyurethane camouflage paint is used in areas exposed to sunlight, i.e., topside, sail and rudder. This paint is expected to retain its black color for at least two years. It is therefore NOT recommended to recoat the urethane camouflage for at least two years after application. Within the first two years, only cleaning is recommended. Reference (g) clearly identifies the potential lead hazard associated with Special Hull Treatment (SHT) work and outlines procedures necessary to mitigate this hazard when preparing exterior submarine surfaces for repainting.

7.10.4.3.1 Cleaning of Formula 187 Urethane Camouflage Coating.

- a. Required Tools: "Greenie pads".
- b. Process:
 - (1) Apply fresh water from firehose or other source to dirty SHT surfaces.

- (2) Lightly scour the surface with a damp "Greenie Pad" or other similar material to loosen dirt and debris.
- (3) Hose down surface with fresh water to restore original black color.

NOTE: AFTER TWO YEARS OF SERVICE OR SIGNIFICANT MECHANICAL DAMAGE, FORMULA 187 MAY BE TOUCHED UP.

7.10.4.3.2 Surface Preparation.

- a. Required Tools:
 - (1) 80-100 grit aluminum oxide paper.
 - (2) Shop-Vac type vacuum cleaner.
 - (3) Manufacturer's MSDS for PF-145 HP solvent.
- b. Process:
 - (1) Read and understand Section 7.3 of this chapter, "General Safety Precautions".
 - (2) Read and understand Section 7.5 of this chapter, "General Surface Preparation".
 - (3) Clean the surface of any grease, oil, salt or other residue with a detergent solution and rinse with fresh water.
 - (4) In accordance with reference (c), Ship's Force should only remove paint when required to accomplish preservation of corroded surfaces or when bare metal is necessary for an inspection or welding. SHT tiles on 688 Class submarines contain 10 percent lead by weight. The generation of airborne SHT dust may have an adverse effect on worker health and contaminate the surrounding environment. In the case where removal of SHT coverply paint is authorized, special work controls must be followed to ensure appropriate worker protection and prevent environmental contamination.
 - (5) Hand sand the surface using 80-100 grit aluminum oxide paper to roughen the surface for adhesion. Polyurethane will not adhere to itself unless the previous coat has been sanded.
 - (6) Vacuum up dust.
 - (7) Clean surface of remaining dust by wiping with PF-145 HP solvent poured directly onto a clean rag. Do not dip the rag into the solvent. Change rags frequently.
 - (8) Apply paint as soon as possible (ideally, the same day) after surface preparation has been completed.

7.10.4.3.3 Paint Application.

- a. Required Tools:
 - (1) Short nap rollers.
 - (2) Brushes.
 - (3) Rags.
 - (4) Manufacturer's PDS or ASTM F-718 sheet for Formula 187, (black polyurethane camouflage).
 - (5) Manufacturer's MSDS for the following paints:
 - (a) Formula 187, Component A (black polyurethane camouflage).
 - (b) Formula 187, Component B (black polyurethane camouflage).
- b. Process:
 - (1) Read and understand Section 7.6 of this chapter, "General Mixing and Paint Application".

- (2) Read and understand the PDS (or ASTM F-718 sheet) and MSDS for the F-187 paint system.
- (3) Check environmental conditions. Ask for help from SPRUCE barge or FMA personnel.
 - (a) Surface temperature shall be at least 5° F higher than the dew point.
 - (b) Paint shall not be applied at temperatures of 50°F or lower.
 - (c) Relative humidity shall be below 75 percent.
- c. Summary.
 - (1) Table 5 summarizes mixing, application and overcoat parameters.

Paint	Induction Period (hours)	Mix Ratio (volume)	Pot Life (hours)	Time Before Overcoating (hours)	Time to Handle (hours)	Wet Film Thickness (mils)	Dry Film Thickness (mils)
F-187, black polyurethane camouflage	None	4 : 1 (Mix at 50° or above)	At least 1	18 hours - 7 days	At least 2	4-5	3

Table 5. Mixing, Application and Overcoat Parameters for Special Hull Treatment Tiles.

CAUTION: MIXING SHOULD BE PERFORMED AT A TEMPERATURE OF 50° F OR ABOVE.

- (2) Thoroughly mix the A and B components in their individual containers by hand stirring. Mix the A and B components together in a 4:1 ratio by volume. Mix entire gallon of A with entire quart of B. The mixture should be thoroughly blended for two minutes after which it can be used immediately. (There is no induction time for the polyurethane paint.)
- (3) Due to difficulty in removing old paint from depressed tile seam areas, “stripe” these areas with a wide brush prior to roller application.
- (4) Apply the F-187 paint in a smooth uniform layer using a paint brush or roller. (Paragraphs 7.9.2, “Brush Application” and 7.9.3 “Roller Application” of this chapter.)
- (5) Check WFT to assure proper thickness (Paragraph 7.9.4 of this chapter). WFT should be 4-5 mils.
- (6) Allow 24 hours for paint to cure before permitting foot traffic. Freshly painted areas should be roped off to prevent contamination of the coating. Paint should cure for a minimum of 5 days prior to submerging.

7.10.5 High Temperature Piping (and Components Near the 12k Evaporator).

- a. To minimize corrosion of carbon steel piping and other components in the vicinity of the 12k evaporator it is important to reduce the accumulation of salt on the surfaces and ensure the heat-resistant paint is applied at the recommended film thickness.
- b. When paint repairs are conducted on high temperature piping or other components in the vicinity of the 12k evaporator, the evaporator **MUST NOT BE OPERATING** (cool).

7.10.5.1 Surface Preparation.

- a. Required Tools:
 - (1) 180 grit sand paper.
 - (2) Shop-Vac type vacuum cleaner.
 - (3) Manufacturer’s MSDS for mineral spirits, TT-T-291.
- b. Process:

- (1) Read and understand Section 7.5 of this chapter, "General Surface Preparation".
- (2) Wash the area to be painted with deionized water. This step removes excess salt.
- (3) Clean with an approved solvent (mineral spirits, TT-T-291, NSN 8010-00-558-7026) to remove oil and grease.
- (4) Remove any loosely adherent paint and rust with a wire brush.
- (5) Lightly abrade with 180-grit sandpaper. Take care to minimize the amount of steel removed. Ensure any residual dust from sanding is removed.
- (6) Wash the area again with deionized water.
- (7) Dry the area and check surface for surface salt concentration. SPRUCE personnel are trained in the measurement of surface salt contamination. If required, consult the SPRUCE barge or FMA personnel for help. If the salt concentration limit is exceeded, wash the area again with fresh water. Pay particular attention to crevices, pits and welds. Dry affected area and measure soluble salt level again to verify that salt concentration is below the maximum level. Repeat this step until soluble salt levels are acceptable.
- (8) Apply paint immediately after the surface has been prepared to prevent re-contamination.

7.10.5.2 Paint Application.

NOTE: PRIOR TO ANY INTERIOR PAINTING, POSITIVE PRESSURE UNIT MUST BE ACTIVATED. THIS WILL PREVENT SOLVENT FROM DAMAGING MOTOR GENERATORS.

a. Required Tools:

- (1) Rollers.
- (2) Brushes.
- (3) Rags.
- (4) WFT gauge.
- (5) Manufacturer's PDS or ASTM F-718 sheet for TT-P-28G (Low VOC heat resisting aluminum).
- (6) Manufacturer's MSDS for TT-P-28G (Low VOC heat resisting aluminum).

CAUTION: HEAT RESISTANT PAINT IS EXTREMELY FLAMMABLE AND SHOULD NOT BE APPLIED AT TEMPERATURES ABOVE 85 °F.

b. Process:

- (1) Read and understand Section 7.3 of this chapter, "General Safety Precautions".
- (2) Read and understand Section 7.6 of this chapter, "General Mixing and Paint application".
- (3) Read and understand the PDS (or ASTM F-718 sheet) and MSDS for the TT-P-28G paint systems.
- (4) Check environmental conditions. Ask for help from SPRUCE barge or FMA personnel.
 - (a) Surface temperature shall be at least 5° F higher than the dew point.
 - (b) Paint shall not be applied at temperatures of 50° F or lower.
 - (c) Relative humidity shall be below 85 percent.

c. Summary.

- (1) Table 6 summarizes mixing, application and overcoat parameters.

Paint	Induction Period (hours)	Mix Ratio (volume)	Pot Life (hours)	Time Before Overcoating (hours)	Time to Handle (hours)	Wet Film Thickness (mils)	Dry Film Thickness (mils)
TT-P-28G	N/A	N/A	N/A	1 @ 400° F	7 minutes @ 400° F	2	0.7-1.0

Table 6. Mixing, Application and Overcoat Parameters for High Temperature Piping.

- (2) Apply two thin coats of TT-P-28G at a WFT of 2.0 mils per coat. During application (brushing), use a WFT gauge to ensure the film thickness is not exceeded. If the paint is too thick, it will delaminate (pop off) when the system comes up to temperature.
- (3) Freshly painted areas should be roped off to prevent contamination during the curing process. This paint does not fully cure until it is heated. Plan painting when all other work in the area is complete to minimize damage to the coating.

7.10.6 Underway Painting - Rust Converters.

7.10.6.1 Maintenance During Operational Cycle. Preservation maintenance performed during the operational cycle should only be performed to arrest and prevent corrosion problems. The two rust converters listed below are approved for use on non-nuclear surfaces with NAVSEA-approved epoxy (MIL-DTL-24441 and MIL-DTL-23236) and enamel (Formula 111) paints.

Rust Converter Paint	Vender
VACTAN	RAYCO Services, Inc. 2512 Broad Bay Road Virginia Beach, VA 23451 (757) 481-0373
UNITED 303 TRIUMPH	United Laboratories 320 37 th Avenue St. Charles, IL 60174 (800) 323-2594

7.10.6.2 Restricted Use. These rust converters are approved under the Submarine Atmosphere Control Program in the LIMITED usage category and may be used with the following restrictions:

- a. Rust converters authorized for use on reactor compartment components which are governed by the Reactor Propulsion Plant Schedules are provided by separate correspondence.
- b. Rust converters are approved for use on all classes of submarines.
- c. Rust converters may be applied to fasteners that are permitted to be painted.
- d. Rust converters are water-based products and should not be used on wetted surfaces or on surfaces of continuous immersion.
- e. Rust converters are used for touch-up not to exceed 10 square feet of surface area per day.
- f. Rust converters are to be applied by brush.
- g. VACTAN should not be applied to surfaces that experience a service temperature greater than 149° F.
- h. TRIUMPH can be used for temperatures up to 200° F.
- i. The minimum temperature during application of TRIUMPH is 38° F; of VACTAN is 50° F.
- j. The maximum quantity to be stored on board while underway is 2 gallons.

7.10.6.3 Surface Preparation.

- a. Required Tools:
 - (1) Needle gun.
 - (2) Inspection mirror (for seeing hard-to-reach areas such as the backsides of beams).
- b. Process:
 - (1) Read and understand Section 7.3 of this chapter, "General Safety Precautions".
 - (2) Read and understand Section 7.5 of this chapter, "General Surface Preparation".
 - (3) Remove loose rust, scale and other contaminants using power and hand tool cleaning methods.
 - (4) Detergent wash the area to remove all oil and grease followed by a fresh water wash/rinse to remove any residual detergent and soluble salts.
 - (5) Allow surface to dry prior to applying rust converter.

7.10.6.4 Paint Application.

- a. Required Tools:
 - (1) Brushes.
 - (2) Rags.
 - (3) Manufacturer's PDS or ASTM F-718 sheet for VACTAN or TRIUMPH.
 - (4) Manufacturer's MSDS for VACTAN or TRIUMPH.
- b. Process:
 - (1) Water-based rust converters must be applied on a dry surface by brush only while underway in a closed ship environment.
 - (2) Two coats of the rust converter should be applied according to manufacturer's directions.
 - (3) Freshly painted areas should be roped off to prevent contamination during the curing process.

7.10.6.5 Overcoating Upon Return To Port. Upon return to port, intact properly adhering rust converters must be overcoated with two coats of paint (either epoxy (MIL-DTL-24441, Type IV) or enamel (Formula 111), depending on the area. The following procedure shall be followed:

- a. Read and understand Section 7.5 of this chapter, "General Surface Preparation".
- b. Use detergents to remove as much oil and grease as possible followed by a fresh water wash/rinse to remove any residual detergent and soluble salts.
- c. Allow surface to dry.
- d. Sand surface to be overcoated using 80 grit paper to provide adequate surface profile for paint adhesion.
- e. Wipe surface and vacuum after sanding to remove any loose paint, dirt or dust.
- f. Read and understand Section 7.3 of this chapter, "General Safety Precautions".
- g. Read and understand Section 7.6 of this chapter, "General Mixing and Paint application".
- h. Read and understand the PDS (or ASTM F-718 sheet) and MSDS for either epoxy (MIL-DTL-24441, Type IV) or enamel (Formula 111) paint systems.
- i. Apply two coats of paint (either epoxy (MIL-DTL-24441, Type IV) or enamel (Formula 111), depending on the surface being painted. The final coat should be the same color as the surrounding area to maintain color uniformity. The combination of rust converter/specified overcoat paint system is considered permanent.

7.10.7 Touch-Up of Miscellaneous Areas of General Corrosion Including New High Solids Coatings.

7.10.7.1 Surface Preparation.

- a. Required Tools:
 - (1) Needle gun.
 - (2) Inspection mirror (for seeing hard-to-reach areas such as the backsides of beams).
 - (3) Brush and dust pan.
 - (4) Shop-Vac type vacuum cleaner.
- b. Process:
 - (1) Read and understand Section 7.5 of this chapter, "General Surface Preparation".
 - (2) Solvent clean to remove oil, grease, dirt, chemicals and water-soluble contaminants. If solvents are prohibited, use detergent and fresh water.
 - (3) Use a needle gun to remove loose paint and rust. A needle gun is most effectively used by holding it 90° to the surface, making 2-3 passes about 6-8 inches in length over the same path, then moving over and repeating the process until the entire area is completed. The goal is removal of all rust, loose mill scale and paint to bare metal.
 - (4) Feather the edges.
 - (5) When needle gunning and sanding are complete, brush and vacuum loose pieces and dust.
 - (6) Check the surface for oil that may have been deposited during surface preparation. If necessary, solvent clean to remove oil.
 - (7) The presence of excess salts on the surface will cause premature coating failure. Therefore surface conductivity measurements should be made at this point. Contact SPRUCE barge, FMA or other knowledgeable personnel if help is needed. If excessive surface conductivity is measured, wash the area with fresh water and repeat Step (7).
 - (8) Apply paint as soon as possible (ideally, the same day) after surface preparation has been completed. Bare metal surfaces will flash rust soon after exposure to the atmosphere. If flash rusting occurs prior to coating application, repeat Steps (3)-(8).

7.10.7.2 Paint Application.

- a. Required Tools:
 - (1) Rollers.
 - (2) Brushes.
 - (3) Rags.
 - (4) Manufacturer's PDS or ASTM F-718 sheet for the following paints:
 - (a) Formula 150, Type IV (MIL-DTL-24441, Formula 150, Type IV, green primer).
 - (b) Formula 151, Type IV (MIL-DTL-24441, Formula 151, Type IV, haze gray).
 - (5) Manufacturer's MSDS for the following paints:
 - (a) Formula 150, Type IV, Component A (MIL-DTL-24441, Formula 150, Type IV, green primer, component A).
 - (b) Formula 150, Type IV, Component B (MIL-DTL-24441, Formula 150, Type IV, green primer, component B).
 - (c) Formula 151, Type IV, Component A (MIL-DTL-24441, Formula 151, Type IV, haze gray, component A).

- (d) Formula 151, Type IV, Component B (MIL-DTL-24441, Formula 151, Type IV, haze gray, component B).

b. Process:

- (1) Read and understand Section 7.6 of this chapter, "General Mixing and Paint Application".
- (2) Read and understand the PDS (or ASTM F-718 sheet) and MSDS for the two paint systems to be used.
 - (a) F-150, Type IV, green primer.
 - (b) F-151, Type IV, haze gray top coat.
- (3) Check environmental conditions. Ask for help from SPRUCE barge or FMA personnel.
 - (a) Surface temperature shall be at least 5° F higher than the dew point.
 - (b) Paint shall not be applied at temperatures of 35°F or lower.
 - (c) Relative humidity shall be below 85 percent.
- (4) Mix F-150, Type IV, green primer according to manufacturer's instructions. Mix ratio is 1:1 by volume. (Paragraph 7.8.3 of this chapter, Mixing and Application Procedures for the Navy Epoxy Paint System (MIL-DTL-24441).

c. Summary.

- (1) Table 7 summarizes mixing, application and re-coat parameters.

Paint	Induction Period (hours)	Mix Ratio (volume)	Pot Life (hours)	Time Before Overcoating (hours)	Time to Handle (hours)	Wet Film Thickness (mils)	Dry Film Thickness (mils)
F-150, green primer	N/A	1 : 1	6 @ 70° F	Minimum of 3 @ 40° F 3 @ 70° F @ 50% RH	Minimum of 24 @ 40° F 5 @ 70° F @ 50% RH	6-7	4-5
F-151, gray topcoat	N/A	1 : 1	6 @ 70° F	Minimum of 3 @ 40° F 3 @ 70° F @ 50% RH	Minimum of 24 @ 40° F 5 @ 70° F @ 50% RH	6-7	4-5

Table 7. Mixing, Application and Re-Coat Parameters for Touch-Up of Miscellaneous Areas.

- (2) Apply by brush. Be certain to force coating into corners, behind beams and areas that are difficult to reach. Pay particular attention to newly installed components such as pipe hangers and clamps. (Paragraph 7.9.2 of this chapter, "Brush Application".)
- (3) Check WFT to assure proper thickness (Paragraph 7.9.4 of this chapter).
- (4) Wait until the first coat is dry, a minimum of 3 hours, before overcoating. If, after 3 hours, coating is not dry, check hourly until coating is dry. REMEMBER - PDS (or ASTM F-718 sheet) and Table 7 guidance for overcoating interval is an estimate. You must be able to walk on the first coat without damaging it.
- (5) When first coat is dry, apply a "stripe" coat on welds, corners and edges. The "stripe" coat should be a different color than either the first coat (green) or the topcoat (gray) to facilitate coverage. F-153, Type IV, a black coating, is a good choice. If a different color is not available, use F-151, Type IV, gray as the "stripe" coat.

- (6) When the "stripe" coat is adequately dry, mix F-151, Type IV, gray topcoat according to manufacturer's instructions. Mix ratio is 1:1 by volume. (Paragraph 7.8.3 of this chapter, Mixing and Application Procedures for the Navy Epoxy Paint System (MIL-DTL-24441.)
- (7) Apply by brush or roller (if a roller can reach all areas that need paint). (Paragraphs 7.9.2, "Brush Application" and 7.9.3 "Roller Application" of this chapter.) If F-151 was used as the "stripe" coat, pay particular attention to completely cover the "stripe" coat since there is no color difference to provide visual contrast.
- (8) Check WFT to assure proper thickness (Paragraph 7.9.4 of this chapter).
- (9) Freshly painted areas should be roped off to prevent contamination during the curing process.
- (10) Allow coatings to cure per the curing schedule given in the PDS (or ASTM F-718 sheet).
- (11) Ventilation should be in place during the curing process as it will facilitate curing and prevent build-up of hazardous vapors.

(This Page Intentionally Left Blank)

APPENDIX A

SUBMARINE PAINT GUIDE

REFERENCES.

- (a) OPNAVINST 5100.19 - NAVOSH Program Manual for Forces Afloat, Chapter D12, Painting and Preservation
- (b) Naval Ships Technical Manual (NSTM), Chapter 631 - Preservation of Ships in Service - General
- (c) Hazardous Material User's Guide (HMUG), Group 12 - Paint Materials

1. SCOPE. This information is intended for use by Ship's Force when preparing, handling and applying paint to interior submarine surfaces. A copy of this guide is available on the Shipboard Environmental Information Clearinghouse (SEIC) website at: <https://navyseic.dt.navy.mil> under Pollution Prevention for Submarines.

NOTE: BE SURE TO FOLLOW THE GENERAL SAFETY PRECAUTIONS SPECIFIED IN REFERENCE (a) OF THIS APPENDIX AND THE DETAILED PROCEDURES AND PRECAUTIONS SPECIFIED IN REFERENCE (b) OF THIS APPENDIX.

2. SURFACE PREPARATION.

- a. According to the Rohm and Haas Paint Quality Institute (PQI) website at: www.paintquality.com, inadequate surface preparation is the leading cause of premature exterior paint failures. Paint performance depends on a properly prepared surface, the benefits of which include:
 - (1) Improved adhesion (less blistering, flaking or peeling).
 - (2) Longer service life.
 - (3) Resistance to corrosion.
- b. More information on surface preparation for specific substrates and a list of relevant specifications and standards are available at: <http://www.industrialpaintquality.com/education/surfaceprep.html>

CAUTION: AVOID MIXING PAINT PRODUCTS IN AN ENCLOSED COMPARTMENT WITHOUT ADEQUATE VENTILATION. PER OPNAVINST 5090.1C PARAGRAPH 22-4.3.2.11E, THE USE OF PAINT THINNER IS PROHIBITED. REFERENCE (c) OF THIS APPENDIX PROVIDES A HAZARDOUS MATERIAL USER'S GUIDE.

3. PAINT MIXING. There are numerous considerations for effective paint mixing:

- a. Always mix paints and their solvents in a designated compartment or mixing room before boarding the submarine.
- b. Prior to mixing paint, read and understand the information in the manufacturer's Product Data Sheet (PDS).
- c. Thoroughly mix each component of multiple component paint before combining.
- d. Mix in Navy epoxy paint components at a 1:1 ratio by volume (MIL-PRF-24441).
- e. Thoroughly mix paints until free of lumps, cakes and sediments.
- f. MIL-DTL-24441, Type IV does not require induction, and may be used immediately.

4. PAINT APPLICATION.

- a. Apply paints under the following environmental conditions:
 - (1) Surface temperature at least 5°F higher than the dew point.
 - (2) Temperature greater than 35°F.
 - (3) Relative humidity below 85%.
- b. Other recommendations for proper paint application include:
 - (1) Apply paint as soon as possible following surface preparation. Two minutes of stirring or agitating is required at 4-hour intervals during the application process.
 - (2) To visually facilitate complete coverage, apply different colors of the same paint when successive coats are used.
 - (3) Use a “tack coat” of Formula 150 when painting over a fully cured epoxy paint film. The coat should be applied to a DFT of 1 mil (2 mils WFT).
 - (4) Paint trim, doors or similar areas after major surfaces (e.g., bulkheads) are completed.
 - (5) If more than seven days elapse before overcoating, the surface should be cleaned, rinsed and wiped dry. This should be followed by either: (1) a tack coat (1 to 2 wet mils) of the last coat applied, or (2) a tack coat of Formula 150 to the hard epoxy coat. Allow to dry approximately four hours before application of the next full coat of the system.
 - (6) If more than 30 days elapse before overcoating, clean and roughen the aged topcoat before new paint application.

5. SAFETY CONCERNS. Painting is an inherently dangerous activity. Remember to always be aware of potential hazards in the area, heed warning signs, and to follow safety guidelines and procedures.

- a. Do not store paints and solvents onboard the submarine.
- b. Activate the positive pressure unit prior to any interior painting.
- c. Terminate all internal painting with oil based paints 5 days prior to sealing the ship. Terminate painting with latex or water based paint 3 days prior to sealing.
- d. Consult the Submarine Material Control List (SMCL) for additional restrictions at:
<https://smcl.dt.navy.mil>

6. VOLUME ESTIMATION. Use Table 1 to estimate the volume of paint required to cover a given surface area. For example: 10.0 pints of MIL-PRF-24441 Epoxy topcoat is needed to cover 280 square feet of surface area.

Surface Area in Square Feet	Pints of Paint Required			
	<i>MIL-PRF-24441 Primer</i>	<i>MIL-PRF-24441 Epoxy Topcoat</i>	<i>MIL-PRF-24635 Enamel Topcoat</i>	<i>TPD-24607 Enamel Topcoat</i>
20	0.5	0.7	0.3	0.3
40	1.1	1.4	0.6	0.6
60	1.6	2.1	0.9	0.9
80	2.1	2.9	1.2	1.1
100	2.6	3.6	1.4	1.4
120	3.2	4.3	1.7	1.7
140	3.7	5.0	2.0	2.0
160	4.2	5.7	2.3	2.3
180	4.7	6.4	2.6	2.6
200	5.3	7.1	2.9	2.9
220	5.8	7.9	3.2	3.1
240	6.3	8.6	3.5	3.4
260	6.8	9.3	3.8	3.7
280	7.4	10.0	4.1	4.0
300	7.9	10.7	4.3	4.3
320	8.4	11.4	4.6	4.6
340	8.9	12.1	4.9	4.9
360	9.5	12.9	5.2	5.1
380	10.0	13.6	5.5	5.4
400	10.5	14.3	5.8	5.7
420	11.1	15.0	6.1	6.0
440	11.6	15.7	6.4	6.3
460	12.1	16.4	6.7	6.6
480	12.6	17.1	7.0	6.9
500	13.2	17.9	7.2	7.1

Table 1

7. COMMON PAINTING TERMS.

- a. Pot Life - The length of time that a catalyzed resin system retains a viscosity low enough to be used. Also known as working life or usable life.
- b. Relative Humidity - The amount of water in the air compared with how much the air can hold at the current temperature.
- c. Induction Time - The waiting period required between the time a two-part paint is mixed and the time it can be used. Also known as sweat-in.
- d. Dew Point - The temperature at which moisture will begin to condense out of the air.
- e. Wet Film Thickness (WFT) - Paint thickness of a wet coating (immediately after application). Measured in mils or thousandths of an inch.

- f. Dry Film Thickness (DFT) - Paint thickness of a cured (dried) coating. Measured in mils or thousandths of an inch.
- g. Tack Stage - The point where a slight impression remains when the paint is pressed lightly with a fingertip.
- h. Tack coat - A thin layer of paint applied when painting over fully cured epoxy paint.
- i. Feathering - The process of making a tapered edge between the edges of intact paint and an area that has been mechanically cleaned to allow for proper adhesion of the paint to all surfaces.

APPENDIX B
COATING INSPECTION REPORT FORM

USS _____ DATE _____

Inspection Area Name/Number: _____

Inspector: _____

Location *	Percent General Corrosion	Structural Steel Defects (Pitting, Corrosion)? (Y/N)	Percent Blistering	Notes

* NOTE: Identify frame and location in relation to ship's centerline or general location within the tank or space.

(This Page Intentionally Left Blank)

**APPENDIX C
SHIPBOARD POWER CLEANING TOOLS**

Vendor	Description	Type Category
Honsa Ergonomic Technologies Inc.	Pneumatic Chipping Hammers: HTC-93-1-H	Chipping Hammer
Tool Crib of the North	DW997K-2: 1/2" Extreme Drill/Driver/Hammerdrill Kit	Drill
Tool Crib of the North	DW4PAK-2K 18V Extreme contractor's Combo Package: 1/2" drill/hammerdrill, 5 3/8" Trim Saw, Recip. Saw, Floodlight, 2 Batteries, charger, & Case	Drill/Recip & Trim Saw
DESCO Manufacturing Co., Inc.	Rt Angle Sander Kit w/Dust Collector Outlet, 7" (151.217)	Grinder
DESCO Manufacturing Co., Inc.	Rt Angle Sander Kit w/Dust Collector Outlet, 4.5" (150.217)	Grinder
DESCO Manufacturing Co., Inc.	Rt Angle Sander Kit w/Dust Collector Outlet, 4" (150.317)	Grinder
DESCO Manufacturing Co., Inc.	VersaTool (170.181)	Grinder/Polisher
DESCO Manufacturing Co., Inc.	Model GD1010 - Navy HEPA Vac System (305.014)	HEPA Vacuum
DESCO Manufacturing Co., Inc.	5" Tile Stripper (180.029)	Long Handle Scaler
McMaster-Carr Supply Company	Screwdriver-Handle Flat-Blade Scraper Offset, 9/16" Blade Width, 8-1/16" Overall Length (3645A4)	Misc. Hand Tool
McMaster-Carr Supply Company	Ceramic-Blade Scraper Plastic Handle, 6-3/4" Overall Length (35685A65)	Misc. Hand Tool
McMaster-Carr Supply Company	3"W X 4-3/4"L Chisel-Edge Bent-Blade Scraper (3668A25)	Misc. Hand Tool
McMaster-Carr Supply Company	Curved Handle Brush W/Stainless Steel Bristles, 4 X 19 Rows (7187T8)	Misc. Hand Tool
McMaster-Carr Supply Company	Stainless Steel Laced Scratch Brush 7 X 4 Rows, 11/16" Trim Length, 8-3/8" Overall Length (7251T97)	Misc. Hand Tool
McMaster-Carr Supply Company	Scaling Hammer 1 lb Head, 12-1/4" Overall Length (5933A11)	Misc. Hand Tool
DESCO Manufacturing Co., Inc.	Needle Scaler System - Model 24 (130.2246)	Needle Scaler (Gun)
Northern Tool & Equipment	1350 PSI Electric Pressure Washer (157421-NET)	Pressure Washer
DESCO Manufacturing Co., Inc.	Mini-Flushplate System (100.216)	Rotary Scaler (2.25" Mini Deck Crawler)
DESCO Manufacturing Co., Inc.	FX-Flushplate System (110.216)	Rotary Scaler (4.25" Mini Deck Crawler)
EDCO Equipment Company, Inc.	EDCO Pro-Scaler, Model PS-GD-2563	Tight-Area Tool
Imperial Tool Company	Straight Geared Die Grinder, .3 HP, 5000 RPM, DOTCO #10S1093A-01	Tight-Area Tool
Imperial Tool Company	90 Degree Die Grinder, .3 HP, 12000 RPM, DOTCO # 10S1200B-36	Tight-Area Tool
Imperial Tool Company	Extended Head 90 Degree Die Grinder, .3 HP, 12000 RPM, DOTCO # 10S1290B-36	Tight-Area Tool

Vendor	Description	Type Category
D. L. Thurrott Co., Inc.	Bilge Pump, Wilden Pump, Model M1/PT/TF/TF/KT	Tight-Area Tool, Bilge Pump
McMaster-Carr Supply Company	Mini Tank Air-Powered Wet/Dry Vacuum 6 Gallon Tank, 110 Cfm, 116" Water Lift (6433T73)	Wet/Dry Vacuum
Sears Power and Hand Tools	Craftsman 2 Gal 1.5 HP Portable Wet/Dry Vacuum (17711)	Wet/Dry Vacuum

VOLUME VI

CHAPTER 8

MINIATURE/MICROMINIATURE ELECTRONIC REPAIR PROGRAM

REFERENCES.

- (a) NAVSUP Publication 485 - Afloat Supply Procedures
- (b) NAVSEAINST 4790.17 - Fleet Test and Repair of Shipboard Electronic Equipment
- (c) NAVSEA SE004-AK-TRS-010/2M Marine Corps TM 5895-45/1B - Standard Maintenance Practices 2M Electronic Assembly Repair
- (d) NAVSEAINST 4790.8/OPNAVINST 4790.4 - Ships' Maintenance and Material Management (3-M) Manual
- (e) COMNAVAIRLANTINST 4790.42/COMNAVAIRPACINST 4790.54 - CV/CVN Intermediate Maintenance Activity (IMA) Module Test and Repair Facility (MTRF)
- (f) NAVSEA TE000-AA-MAN-010/2M - Certification Manual for Miniature/Microminiature (2M)/Module Test and Repair (MTR) Program
- (g) MIL-HDBK-263 - Electrostatic Discharge Control Handbook for Protection of Electrical and Electronic Parts, Assemblies and Equipment
- (h) COMNAVAIRLANTINST 4790.34 - Electrostatic Discharge (ESD) Control Program
- (i) NAVSUP 484 - Supply Afloat Fleet and Field Packaging Procedures
- (j) OPNAVINST 5100.19 - Navy Occupational Safety and Health (NAVOSH) Program Manual for Forces Afloat
- (k) NAVPERS 18068 - Manual of Navy Enlisted Manpower and Personnel Classification and Occupational Standards
- (l) OPNAVINST 4700.7 - Maintenance Policy for U.S. Naval Ships
- (m) COMNAVSURFLANT/COMNAVSURFPACINST 4400.1 - Surface Force Supply Procedures
- (n) MIL-STD 1686 - Electrostatic Discharge Control Program for Protection of Electrical and Electronic Parts, Assemblies and Equipment
- (o) MIL-HDBK-773 - Electrostatic Discharge Protective Packaging
- (p) SPCCINST 4441.170 - COSAL Use and Maintenance Manual
- (q) NAVAIR 01-1A-23 - Electronic Assembly Repair Standard Maintenance Practice
- (r) NAVAIR 17-15-99 - Operations and Maintenance O and I Level
- (s) NAVAIR 17-600-193-6-1 - Pre-operational Check List
- (t) NAVAIR 17-600-193-6-2 - Periodic Maintenance Requirements Manual
- (u) COMNAVAIRLANTINST 13650.1 - Individual Material Readiness List (IMRL) Program
- (v) COMSUBLANTINST 4419.1 - Module Screening and Repair Activity (MSRA) Repairables Management Procedure

LISTING OF APPENDICES.

- A Emergency 2M Repair Process
- B Normal 2M Repair Process
- C MTRF 3-M Reporting (Aircraft Carriers Only)
- D Sample MTRF Amplifying Procedures Message
- E Sample CVN MTRF Repair Request Message
- F Sample MTRF Quarterly Report Message (Aircraft Carriers Only)
- G MTRF Equipment Configuration

8.1 PURPOSE. To promulgate policy, guidelines and procedures for the management of the Miniature/Microminiature (2M) Electronic Repair Program.

8.1.1 Scope. This chapter applies to all activities engaged in the repair of electronic equipment, assemblies, subassemblies, and modules. This chapter does not apply to electronic equipment under the cognizance of Naval Sea Systems Command Nuclear Propulsion Directorate (NAVSEA 08) or the Strategic Systems Project Office.

8.1.2 Policy. All failed Circuit Card Assemblies (CCA)/Electronic Modules (EM) are candidates for 2M screening and repair using Automated Test Equipment (ATE), General Purpose Electronic Test Equipment (GPETE) (including AN/USM-674(V)(2) and the Huntron 2000), and test bed installations. CCAs/EMs may be certified Ready For Issue (RFI) per reference (a).

8.1.3 Background. The 2M Electronic Repair Program, established by reference (b), supports the test and repair of electronic equipment at the Fleet level. Reference (c) describes 2M capabilities which include the performance of high quality repairs on CCAs and EMs. This 2M repair capability includes training, tools, techniques, technical documentation and certification.

8.2 RESPONSIBILITIES.

8.2.1 Fleet Commander. Fleet Commanders shall:

- a. Operationally administer the 2M Electronic Repair and the Module Test and Repair Programs.
- b. Inspect and certify 2M repair facilities and technicians in accordance with reference (b) in conjunction with the Command, Control, Communications, Computers and Combat Systems Readiness Assessment (C5RA)/Total Ship's Readiness Assessment (TSRA).
- c. Ensure all 2M maintenance actions are documented in accordance with reference (d).

8.2.2 Type Commander/Immediate Superior In Command. Type Commanders (TYCOM)/Immediate Superiors in Command shall:

- a. Coordinate and manage the 2M program.
- b. Monitor the effectiveness of the 2M program and provide recommendations concerning 2M equipment, tools, and training.
- c. Implement progressive repair procedures.
- d. Coordinate logistic support, outfitting requirements, and deployment priorities for 2M repair stations and associated test equipment.
- e. Monitor 2M certification status and direct corrective actions as required.
- f. Schedule 2M certifications in conjunction with the C5RA/TSRA prior to deployment, or as required.
- g. (Aircraft Carriers only) Conduct Module Test and Repair Facility (MTRF) inspections in accordance with reference (e) during the C5RA/TSRA, as required, or prior to deployment.

8.2.3 Commanding Officer/Officer In Charge. Commanding Officers/Officers In Charge shall:

- a. Establish a 2M program under the cognizance of the Electronics Material Officer (EMO) and the Combat Systems Officer. For Fleet Maintenance Activities (FMA), utilize the Electronics Repair Officer as the overall coordinator.
- b. Maintain certified 2M stations and technicians.
- c. Screen and repair all CCAs/EMs using the progressive repair process. Submit CCAs/EMs beyond Ship's Force repair capability to the FMA.
- d. (Aircraft Carriers only) Establish a MTRF with the EMO, Combat Systems Officer, or, for FMAs, the Electronics Repair Officer as the overall coordinator.
- e. (Aircraft Carriers only) Maintain an active MTRF. Use the Module Test and Repair (MTR) Tracking System to maintain the ship's MTR performance and production database. Ensure quarterly production/performance reports are submitted in accordance with reference (e).

8.2.4 Miniature/Microminiature Repair Program Coordinator/Module Test and Repair Facility Coordinator. The 2M/MTRF Coordinator shall:

- a. Coordinate and monitor the effectiveness of the 2M Work Center (WC) and the repair program.
- b. Provide adequate space with environmental controls to support the 2M WC using the guidance of references (c) and (f).

- c. Submit additional/new 2M and test equipment requirements to the TYCOM Representative, providing complete justification (e.g., workload, documented manhours, added capabilities with addition of new equipment).
- d. Ensure adequate numbers of 2M trained and technically qualified personnel support the WC.
- e. Ensure 2M personnel and station requirements are met per the criteria of Section 8.4 of this chapter.
- f. Ensure 2M WC personnel are formally trained in the operation and maintenance of all ATE and MTRF equipment.
- g. Maintain an up to date library inventory of Gold Disks for the AN/USM-674(V)(2) and test documentation for other installed ATE, in accordance with TYCOM outfitting requirements. Develop and submit Silver Disks to Naval Undersea Warfare Center, Fleet Engineering Office for CCAs/EMs which are not supported by Gold Disks.
- h. Ensure all 2M repair actions are documented per reference (d).
- i. Ensure the Electrostatic Discharge (ESD) procedures of references (g) and (h) are implemented within the 2M WC to provide adequate protection for ESD sensitive CCAs/EMs.
- j. Coordinate with supply to ensure all CCAs/EMs meet the packaging requirements of per reference (i).
- k. Ensure all CCAs/EMs certified RFI are processed as discussed in Section 8.5 of this chapter.
- l. Maintain a complete inventory of 2M, ATE, AN/USM-674(V)(2), materials and consumables.
- m. Ensure compliance with all applicable safety procedures in accordance with reference (j).
- n. Ensure that the MTR Tracking System is used to record all maintenance actions and produces required production reports.

8.2.5 Commander, Navy Regional Maintenance Center. The Commander, Navy Regional Maintenance Center shall maintain qualified 2M/MTR Fleet Coordinators at Mid-Atlantic Regional Maintenance Center (MARMC)/Southwest RMC. Fleet Coordinators are responsible for 2M/MTR Inspections and Certifications in their respective geographical areas (i.e., MARMC is responsible for Atlantic and Southwest RMC is responsible for Pacific).

8.2.5.1 Regional Maintenance Center. The RMC 2M/MTR Inspection and Certification Branch (MARMC, Southeast RMC, Southwest RMC, Pearl Harbor, Sasebo, Yokosuka, Everett) shall:

- a. Maintain a certified laboratory for the purposes of recertifying technicians, where Field Service Engineers are assigned.
- b. Maintain certified 2M/MTR Inspectors.
- c. Test operate and certify all 2M/MTR related equipment and report inspection results to the appropriate TYCOM.
- d. Conduct technician recertifications and issue operator proficiency cards to qualified 2M technicians.

8.3 AUTHORIZED MINIATURE/MICROMINIATURE OUTFITTING. Authorized 2M outfitting is identified in reference (b).

8.4 MINIATURE/MICROMINIATURE PERSONNEL AND STATION REQUIREMENTS. References (f) and (k) provide certification criteria for all 2M stations and technicians. Reference (f) contains information on 2M repair stations and the Quality Assurance (QA) standards for workmanship.

8.5 PROGRESSIVE REPAIR PROCESS. The progressive repair process is the sequential attempt to test and repair CCAs/EMs. Reference (l) requires repairs at the lowest possible level. Reference (a) describes Repairables Management for Depot Level Repairables (DLR) and Field Level Repairables (FLR). 2M repair technicians will screen and attempt to repair all CCAs/EMs within their training and capability, regardless of cognizance or the Source Maintenance and Recoverability code.

8.5.1 Repair Process. The two principal categories of 2M repair are normal and emergency as defined in reference (l). Appendices A and B of this chapter define the emergency and normal processes respectively.

8.5.2 Ship's Force Process. An activity's repair capability and the type of 2M station may differ depending upon TYCOM outfitting. Such differences include the type of 2M station (MN or MC) and outfitting of test capability (AN/USM-674(V)(2), Huntron 2000, GPETE, etc.). These factors plus 2M technicians' training/certification dictate Ship's Force ability to screen and repair CCAs/EMs. Regardless of these differences, an attempt should be made to repair all CCAs/EMs prior to their forwarding to the FMA.

- a. The 2M WC shall be designated as CSE3 for surface ships, (OE15 for Aircraft Carriers) and NE02 for SSBN/SSGN Class submarines. All 2M work will be documented using these WCs. Final action codes will use "7 series" in accordance with reference (d).
- b. Submit Beyond Capability Maintenance to the FMA using an OPNAV 4790/2K or MJC-OXCA-C028. The WC responsible for the system will forward the CCA/EM to the FMA if the CCA/EM repair is beyond the capability of the 2M WC.
- c. Supply Officers have different responsibilities for DLRs or FLRs, per references (a) and (m).
 - (1) DLRs. Carcass tracking procedures are delineated in local command instructions and will identify supply/maintenance personnel responsibilities for tracking CCAs/EMs either at the Ship's Force 2M WC or the FMA WC. Supply Officers are authorized to delay stock issue, replenishment, and non-RFI turn-in for up to 72 hours pending testing and repair. Aircraft Carrier WC OE15 MTRF will use the Progressive Repair Program with the MTR Tracking System to support Supply/MTRF interaction.
 - (2) FLRs. Disposal of FLRs can be accomplished by either Ship's Force or the FMA.

8.5.3 Fleet Maintenance Activity Process. FMAs have additional 2M repair and ATE capabilities exceeding the Ship's Force level. The FMA will conduct repairs to CCAs/EMs if it is within their capability.

- a. An OPNAV 4790/2K or Master Job Catalog item will be submitted to the local Regional Support Group/Regional Maintenance Center for brokering. The organizational WC/MTRF will advise the Regional Support Group/Regional Maintenance Center if the CCA/EM is time sensitive (i.e., Casualty Report (CASREP)) to prioritize for immediate scheduling.
- b. CASREP driven OPNAV 4790/2Ks will be accepted by the FMA on the same day the job is submitted and worked to support a 24 hour turn-around.
- c. Non-CASREP driven OPNAV 4790/2Ks will be screened to support activities and worked to support a 72-hour time limit or deadline date.
- d. If the FMA is unable to repair the CCA/EM, it is condemned according to Repairables Management procedures in accordance with the requirements of reference (a).

8.5.4 Certification of Miniature/Microminiature Repaired Assets as Ready for Issue. Reference (a) describes the definition and certification criteria for RFI items. Repaired CCAs/EMs will meet the following basic RFI requirements:

- a. Packaging and preservation.
 - (1) Repaired items from the 2M WC/MTRF will be packaged to meet the minimum standards of reference (a).
 - (2) A repair unit identification label shall be affixed to the body of each repaired unit in accordance with reference (a). The label must specify the command/activity performing the repair, the date repaired and the name of the 2M technician.
- b. ESD protection. ESD sensitive CCAs/EMs will be handled, prepared, and packaged in accordance with references (g) and (n). Ensure all CCAs/EMs are packaged for shipment per reference (o).

8.5.5 Miniature/Microminiature Module Test and Repair Piece Parts. Piece parts required for 2M repairs have been formalized into Allowance Parts Lists (APL) for each ship class having 2M/MTR repair capability. These APLs contain unique high usage piece parts such as resistors, diodes, capacitors, transistors, and integrated circuit chips determined from Fleet wide demand data, TYCOM recommendations and from the latest Gold Disk release which support, and are part of, the equipment and/or systems installed on a specific ship class. 2M/MTR piece part APLs are divided into two distinct groups, Baseline and Augmented APLs.

- a. Intermediate-Level Baseline APL. The Intermediate-Level Baseline APL is supply coded Operating Space Item. 2M/MTR piece parts listed in this APL are ordered, staged in three VIDMAR-type cabinets and delivered onboard selective intermediate level ships to the 2M work center. These 2M/MTR piece parts have been identified as maintenance critical. Operating Space Item parts consumed during 2M repairs must be reordered on a one-for-one basis as usage is reported and are eligible for demand base stocking by the supply department.
- b. Organizational-Level Baseline APL. The Organizational-Level Baseline APL is supply coded Storeroom Item and contains an Allowance Note Code to ensure that 100% of the listed 2M piece parts are stocked on board regardless of stocks presently on hand and/or past usage.
- c. Augmented APL. To ensure that sufficient piece parts are authorized to support increases in 2M/MTR repairs, additional APLs have been developed to support both I- and O-Level 2M/MTR ships and shore facilities. These APLs, labeled "Augmented APLs" list all 2M/MTR piece parts appearing in the latest Gold Disk release and are applicable to a ship's class and/or maintenance capability. These APLs are supply coded Storeroom Item and allowances will be computed using normal Fleet Logistics Support Improvement Program computations. Augmented APLs will continue to be updated as the number of Gold Disks continues to increase. Parts needed for a 2M/MTR repair but not listed in 2M/MTR APLs should be reported by Fleet Coordinated Shipboard Allowance List Feedback Report in accordance with reference (p).

8.6 UNIQUE MINIATURE/MICROMINIATURE GUIDANCE (NAVAL AIR FORCE ONLY).

8.6.1 Aviation Intermediate Maintenance Department.

- a. Use reference (q) as the standard maintenance instruction when repairing aircraft or aircraft support equipment CCAs/EMs. Copies of references (q), (r), (s), and (t) shall be maintained in each 2M WC.
- b. Ensure all 2M Collateral Duty Inspectors demonstrate in-depth knowledge of 2M repairs. All micro repair should be inspected by Collateral Duty Inspectors familiar with micro repair standards.
- c. Initial support equipment outfitting for 2M stations is accomplished under the Individual Material Readiness List Program in accordance with reference (u).

8.6.2 Aircraft Carrier Fleet Maintenance Activity Module Test and Repair Facility.

- a. The mission of the MTRF WC OE15 shall be to enhance the parent Aircraft Carrier and Battle Group units' Combat Systems readiness through onboard I-Level electronics repair of CCAs/EMs.
- b. MTRF evaluations will be conducted by the Naval Underwater Warfare Center, Fleet Engineering Office during the C5RA/TSRA or prior to deployment in accordance with reference (e).
- c. Ensure all MTRF WC repair actions are documented under the Maintenance and Material Management (3-M) system per reference (d) and the procedures delineated in Appendix C of this chapter, using a pre-formatted OPNAV 4790/2K. Maintain a file copy of the OPNAV 4790/2K with the completed QA Form 17 for a period of 12 months or until the next C5RA/TSRA or QA audit, whichever is the longer period.
- d. Ensure the ESD control procedures of references (g), (h), and (i) are instituted at the MTRF WC and all departments (less Aviation Intermediate Maintenance Department) to provide for the adequate protection of ESD sensitive CCAs/EMs.
- e. Ensure that the MTR Tracking System is used to record all repairs, maintain the production database and to produce required reports.
- f. Aircraft Carrier Combat Systems Material Officers will promulgate amplifying procedures by message for Battle Group units to request MTRF WC assistance. A sample format is provided in Appendix D of this chapter.
- g. Units requesting CVN MTRF repairs submit "IMMEDIATE" message in the format of Appendix E of this chapter. MTRFs will not accept CCAs/EMs for repair without prior notification.

- h. Each MTRF shall provide Commander, Naval Air Force Atlantic (COMNAVAIRLANT)/Commander, Naval Air Force Pacific (COMNAVAIRPAC) a quarterly summary report of MTRF accomplishments, by message or Naval Telegram, due by the 15th day of the month following the end of each quarter. A sample format is provided in Appendix F of this chapter.
- i. Employ the Progressive Repair Program to establish and support the interface between the Supply Department and Combat Systems MTRF in repair of all ship systems CCAs/EMs.

8.7 UNIQUE MINIATURE/MICROMINIATURE GUIDANCE (SUBMARINE FORCE ONLY).

8.7.1 Module Screening and Repair Activity. The Module Screening and Repair Activity (MSRA) has been developed to support the AN/BSY-1(V), AN/BQQ-15D/E, and CCS MK1/2 programs (WC 84). Parts supported by the MSRA Module Support List are managed in accordance with reference (v).

- a. MSRAs are located at the Naval Submarine Support Facility New London, CT, Submarine Base Pearl Harbor, HI, and Engineering Development Model, Norfolk, VA.
- b. The MSRA suite of test equipment includes a Teradyne tester for digital CCAs/EMs, an LTX for analog CCAs/EMs, a UTS-625 for power supplies, an Amplifier Test Set for Modular Power Amplifiers, and the Display Assembly Test for displays.
- c. (Submarine Base & Naval Submarine Support Facility only) FMAs shall establish and maintain an MTRF consisting of the combined capabilities of WCs 67L, 67M, and 84A.

8.7.2 Fleet Maintenance Activity/Submarine Base.

- a. Designate the R-4 Division Officer through the Production Officer to be the overall coordinator for the MTRF.
- b. FMAs are to maintain 2M/ATE/GPETE repair capability. The minimum acceptable capability is two 2M repair stations, one of which will be microminiature capable.
- c. Promulgate amplifying procedures for out-of-area or inter-service customers to request MTRF assistance using the guidance of Appendix D of this chapter.
- d. Maintain a complete inventory of MTRF using Appendix G of this chapter.

8.7.3 OHIO Class Organizational Repair Capability.

- a. OHIO CLASS SSBNs and SSGNs outfitted with 2M MTR capabilities are to maintain two trained and certified technicians that have completed the AN/USM-674 Operators Training (CIN: A-100-0076) and Miniature Electronic Repair Training (CIN: A-100-0072) for each Blue-Gold crew. Designate one of these technicians from each crew as the 2M MTR Program Coordinator. Responsibilities are cited in paragraph 8.2.4 of this chapter.
- b. In accordance with 2M MTR Certification requirements of reference (f), 2M MTR technicians shall complete re-certification every 18 months. Site reviews shall be conducted every 18 months. Site reviews and personnel re-certifications are conducted by certified 2M MTR Inspectors.
- c. Additional 2M MTR program management responsibilities are cited in sections 8.2 and 8.3 of this chapter.
- d. Submit Module Test and Repair Tracking System Reports (backup file) to NUWCDET Norfolk after completion of each patrol/crew turnover (2mtrdata@navy.mil).
- e. For submarines that possess the organic electronics repair capability (2M), utilize work center NE02.

8.7.4 Reports. FMAs shall utilize the appropriate turn-in repairable tracking system to generate a quarterly Mandatory Turn-in Repairable Summary Package, with option (1) of the MTRF accomplishments, forwarded to the TYCOM (N42). This summary package is due by the 15th day of the month following the end of each quarter.

APPENDIX A
EMERGENCY 2M REPAIR PROCESS

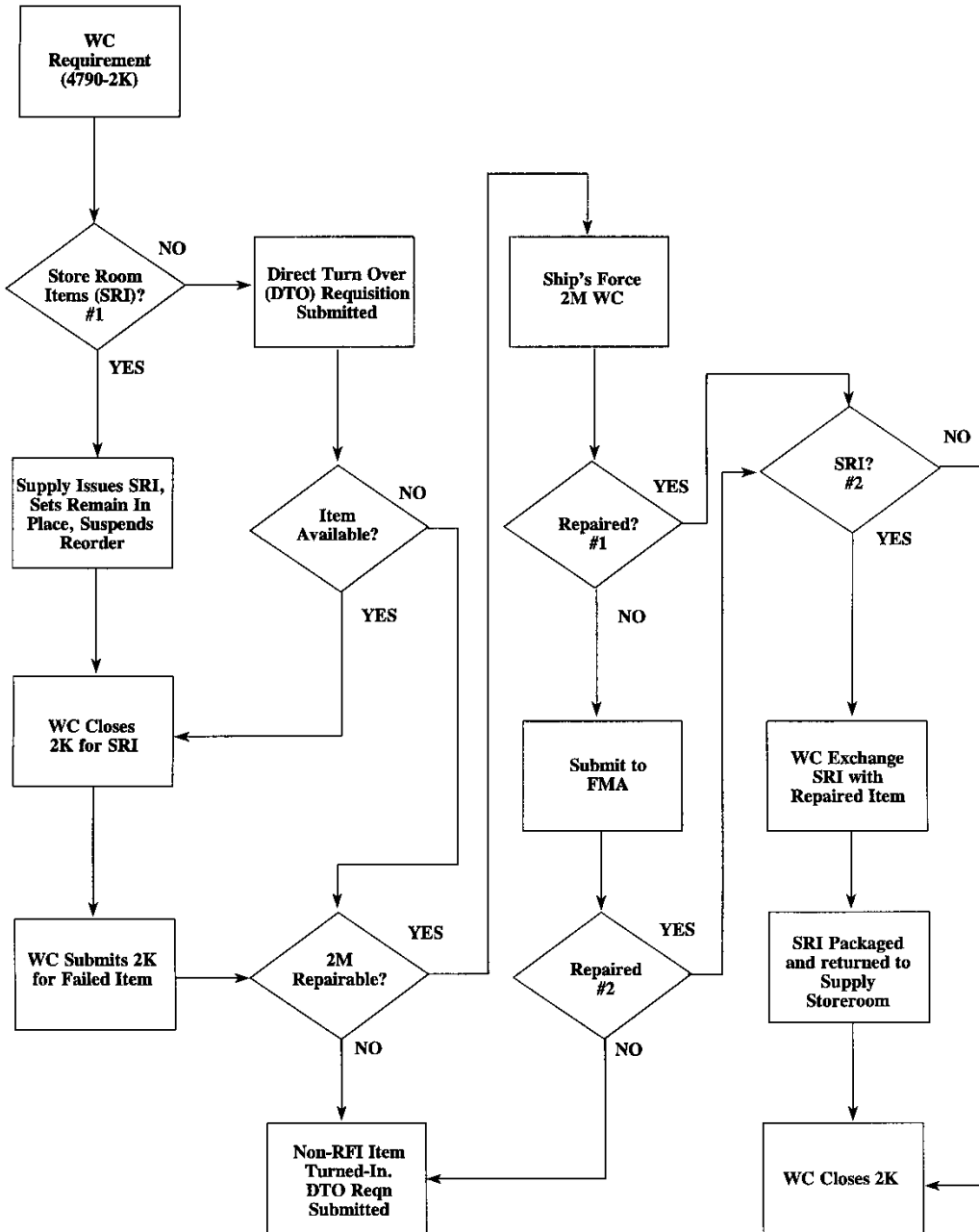

(This Page Intentionally Left Blank)

APPENDIX B
NORMAL 2M REPAIR PROCESS

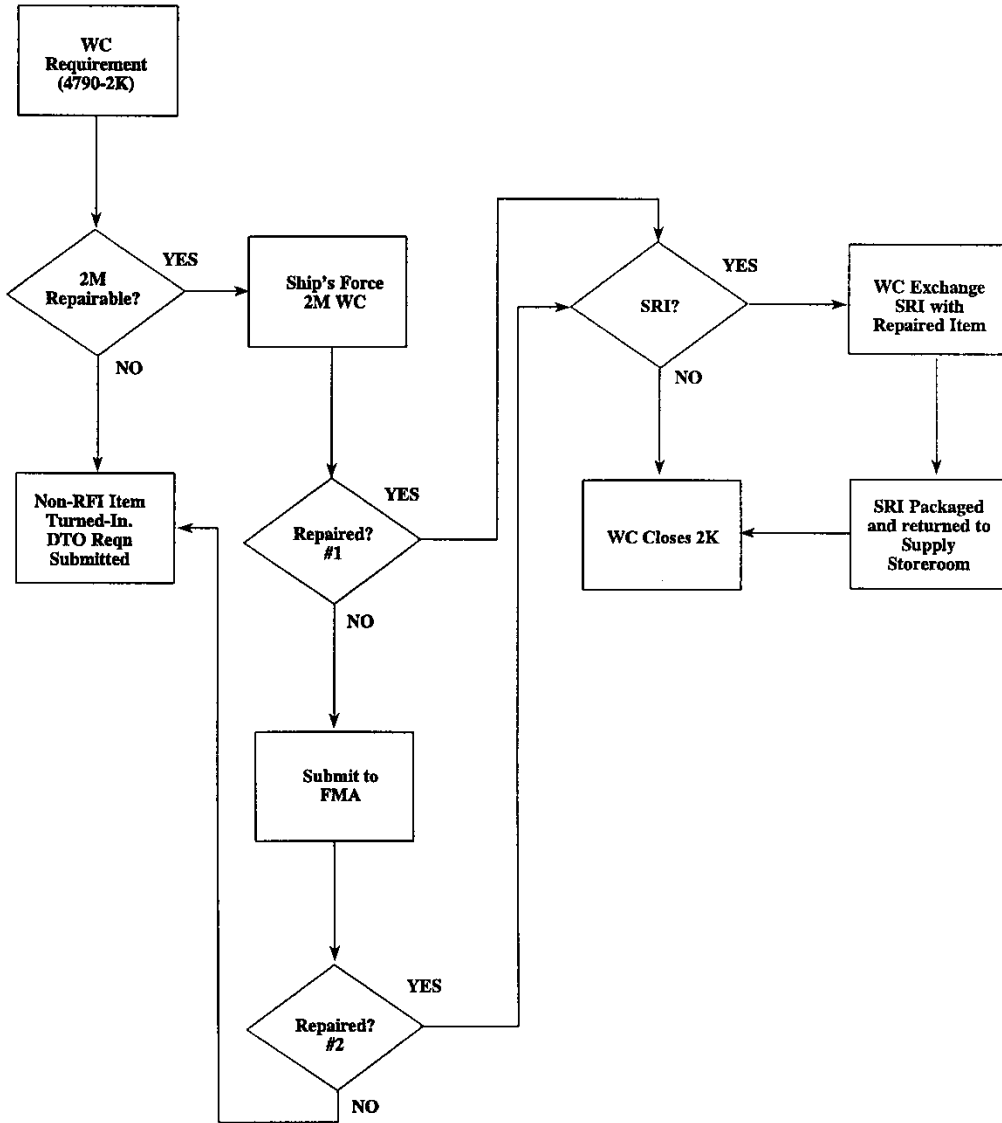

(This Page Intentionally Left Blank)

APPENDIX C**MTRF 3-M REPORTING
(Aircraft Carriers Only)**

1. All diagnostic screening and troubleshooting on non-aviation CCAs/EMs or components utilizing the MTRF suite of testers or other GPETE/Special Purpose Electronic Test Equipment in non-aviation WCs shall be documented via the 3-M system using a pre-formatted OPNAV 4790/2K as either a deferred action or a completed action. OE15 will be the Repair WC (Block 49) or Originating WC (Block 02) depending upon how the job was inducted into the MTRF. This includes CCAs/EMs that are screened "No Fault Evident" (NFE). OE15 will be the Repair WC unless repairing its own equipment; then they would be the Lead Work Center. The pre-formatted OPNAV 4790/2K shall be closed out in the Fleet Maintenance Activity Maintenance Management System and copies retained in OE15 WC files (regardless of Originating WC) for one year. Deferred action OPNAV 4790/2Ks received from tended ships (with failed CCA or EM) will be entered into the Fleet Maintenance Activity Maintenance Management System by OE15 as written, followed by initiation of an OPNAV 4790/2K worksheet to be processed as previously described. Aviation CCAs/EMs should be forwarded to the Aircraft Carrier Aviation Intermediate Maintenance Department with accompanying Visual Information Display System/Maintenance Action Form (OPNAV Form 4790/60).
2. Sections I, II and III of the OPNAV 4790/2K shall be completed per reference (d).
3. Section IV, Block 35 of the OPNAV 4790/2K is pre-formatted in fields. The following guidance shall be used when completing these fields:

a.	<u>FIELD IDENTIFIER</u>	<u>DESIRED ENTRY</u>
	PN	Enter CCA/EM Part Number
	NSN	Enter CCA/EM NSN
	RSN	Enter CCA/EM Reference Symbol Number
	COST	Enter CCA/EM Cost rounded to nearest dollar; enter no cost if DLR
	DE	Enter diagnostic equipment utilized to fault isolate CCA/EM (i.e., AN/USM-465, Huntron 2000, Huntron ProTrack, Fluke 77AN)
	TPS	Enter Test Program Sets (TPS) number if TPS is available; enter "NA" if TPS is not available
	GD	Enter Gold Disk number if Gold Disk is available; enter "NA" if Gold Disk is not available
	NFE	Enter "Y" if NFE; "N" otherwise
	QA	Enter "QA" level
	CA	Enter "Y" if CASREP averted; "N" otherwise (see Note)
	CC	Enter "Y" if CASREP corrected; "N" otherwise

<u>FIELD IDENTIFIER</u>	<u>DESIRED ENTRY</u>
TST	Enter troubleshooting time in hours and tenths of hours (i.e., 0.3, 1.6)
2MT	Enter 2M repair time in hours and tenths of hours (i.e., 0.3, 1.6)
AWPT	Enter delay of CCA/EM repair, in days, due to awaiting parts status

b.

<u>COMPONENTS REPLACED</u>	<u>DESIRED ENTRY</u>
RSN	Enter reference symbol number of component replaced
NSN/PN	Enter NSN or component replaced; if no NSN, enter part number
COST	Enter cost of component replaced
AEL	Enter "Y" if component replaced is included in piece parts Allowance Equipage List; "N" otherwise
COMMENTS	Comment on effectiveness of TPS and Gold Disk if applicable; if "Y" entered in CC field, include CASREP number and the Date Time Group of the message

NOTE:

A CASREP HAS BEEN AVERTED WHEN A CCA/EM HAS BEEN:

- A. REPAIRED OR FOUND NFE.**
- B. REPLACEMENT CCA/EM IS NOT CARRIED IN ONBOARD STOCK.**
- C. INSTALLED IN ANY COMBAT, ENGINEERING, AVIATION OR NON-TACTICAL SYSTEM RESTORING THE SYSTEM TO OPERATION.**

APPENDIX D

SAMPLE MTRF AMPLIFYING PROCEDURES MESSAGE

FM USS (SHIP'S NAME AND HULL NO.)//
 TO BATTLE GROUP//
 INFO TYCOM//(AS APPROPRIATE)
 CTF//(AS APPROPRIATE)
 CTG//(AS APPROPRIATE)
 BT
 UNCLAS //N04790//
 MSGID/GENADMIN/USS (SHIP'S NAME AND HULL NO.) EMO//
 SUBJ/MTRF ADVISORY//
 REF/A/DOC/NWP 1-03.1//
 REF/B/DOC/NAVSUP P-485//
 REF/C/DOC/CNALINST 4790.42/CNAPINST 4790.54//(AS APPROPRIATE)
 NARR/REF A SPECIFIES REPORTING PROCEDURES TO BE USED WHEN REPORTING SIGNIFICANT
 EQUIPMENT CASUALTIES. REF B DETAILS MATERIAL REQUISITION AND HANDLING
 PROCEDURES. REF C PROVIDES INST FOR OBTAINING MTRF ASSIST//
 POC/(NAME)/(RANK/RATE)/(LOCATION)/(DSN/COMM TELEPHONE NO.)//
 RMKS/1. MTRF CONTINUES TO BE FULLY OPERATIONAL ONBOARD USS (SHIP'S NAME AND HULL
 NO.). MTRF ENHANCES BATTLE GROUPS COMBAT SYSTEM READINESS THROUGH ONBOARD FMA
 ELECTRONICS REPAIR. USS (SHIP'S NAME AND HULL NO.) HAS THE CAPABILITY TO FAULT
 ISOLATE AND REPAIR MAJORITY OF SUSPECT FAILED CCA/EM FOR THE BATTLE GROUP. MTRF
 ASSETS INCLUDE: (TAILOR LIST TO MTRF CONFIGURATION)
 A. HUNTRON TRACKER MODELS 2000 AND AN/USM-674(V)(2) (ProTrack)
 B. AN/USM-465 ATE
 C. 2M ELECTRONICS REPAIR
 D. 2M PIECE PARTS ELECTRONICS SUPPORT
 E. RIPLE CROWN 700 MICRO-COMPUTER BASED DRAM AND EPROM IC TEST SETS
 F. SENCORE LC-77 CAPACITANCE/INDUCTANCE TESTER
 2. BRIEF DESCRIPTION OF (CARRIER/FMA) REPAIR CAPABILITIES (TAILOR LIST TO MTRF
 CONFIGURATION)
 A. AN/USM-674(V)(2) (ProTrack) INTERFACES WITH A DEDICATED DESKTOP PC TO
 ASCERTAIN AND STORE CHARACTERISTICS OF KNOWN GOOD CCAS/EMS ON MAGNETIC DISK OR
 CD-ROM FOR FUTURE USE AS A COMPARISON STANDARD FOR SUSPECT CCAS/EMS
 B. USS (SHIP'S NAME AND HULL NO.) HOLDS MOST CURRENT AN/USM-674(V)(2) TPS.
 MAINTENANCE SUPPORT GUIDES ARE AVAILABLE TO FULLY SUPPORT TEST AND PIECE PART
 REPAIR FOR THE BATTLE GROUP
 C. LIMITED CRYPTO REPAIR
 D. XEROX COPIER REPAIRS FOR MODELS 2830/1048/1090 AND SAVIN MODEL 7020S
 E. FULL MICRO COMPUTER TEST AND REPAIR FOR DESKTOP PC PRINTERS AND
 ASSOCIATED PERIPHERALS JOTS POST TIMS AND VARIOUS OTHER RAPID PROTOTYPE PC BASED
 SYSTEMS
 3. AN/USM-674(V)(2) (ProTrack) GOLD DISK LIBRARY OF LEARNED CCAS/EMS IS AVAILABLE
 TO ENHANCE BATTLE GROUP COMBAT SYSTEMS AND OTHER ELECTRONIC SYSTEMS SELF
 SUFFICIENCY
 4. MTRF WILL ATTEMPT TO REPAIR ANY AND ALL CCAS/EMS WITH FOLLOWING
 EXCEPTIONS
 A. CCA/EM UNIDENTIFIABLE DUE TO:
 (1) LACK OF TECHNICAL DOCUMENTATION
 (2) LACK OF COMPONENT OR CIRCUIT IDENTIFICATION
 (3) UNAVAILABILITY OF KNOWN GOOD CCA/EM
 B. CCA/EM GREATER THAN FIFTY PERCENT DESTROYED

- C. COMPLEX RADIO FREQUENCY CCAS/EMS
 - D. EPROM CCA/EM WITHOUT DOCUMENTATION OR DUPLICATE CCA/EM
 - E. UNIQUE EXPERIMENTAL CIRCUITRY
5. MTRF IS GUIDED BY THE FOLLOWING RULES:
- A. UPON RECEIPT OF NON-RFI CCA/EM MTRF WILL EVALUATE PROGNOSIS FOR COMPLETING REPAIRS AND PROVIDE ECD TO ALCON BY IMMEDIATE MSG WITHIN 48 HOURS. MTRF CANNOT ACCEPT CCAS/EMS OR OTHER MATERIALS REQUIRING REPAIR WITHOUT PRIOR MTRF NOTIFICATION AND DIRECTIONS PROVIDED FOR SHIPMENT BY MATCONOFF
 - B. REPAIRED ITEMS WILL BE TAGGED RFI AND RETURNED TO THE REQUESTING UNIT
 - C. CASREPS WILL BE SUBMITTED IAW REF A CONCURRENT WITH MTRF REPAIR REQUEST. CASREP WILL IDENTIFY MTRF REQUIREMENTS IN THE ASSIST AND AMPN BLOCKS WHEN APPLICABLE. WHEN MTRF REPAIR IS SUCCESSFUL CASREP REQUISITION WILL BE CANX IAW REF B AND CASCOR SUBMITTED IAW REF A. IF MTRF IS UNSUCCESSFUL NON-RFI ASSET WILL BE RETURNED TO REQUESTING UNIT
 - D. ITEMS SUBMITTED TO MTRF WILL NOT BE HELD IN AWAITING PARTS STATUS. IF PARTS ARE UNAVAILABLE FROM MTRF PRE-EX BINS CVN SUPPLY OR MATCONOFF SCREEN NON-RFI ASSET WILL BE RETURNED TO ORIG AS NOT REPAIRABLE BY MTRF
6. UNITS REQUESTING MTRF ASSIST SEND IMMEDIATE MSG IAW ENCL 7 OF REF C
7. ADDITIONAL INFORMATION
- A. PACKAGE AND MARK ALL ELECTROSTATIC DEVICES PROPERLY FOR SHIPMENT
 - B. INCLUDE COPY OF MTRF REPAIR REQUEST MSG WITH OPNAV 4790/2K AND ORIG DD 1348-1 IN SHIPPING CONTAINER. SHIP TO USS (SHIP'S NAME AND HULL NO.) MARKED ATTN EMO FOR MTRF REPAIR. USS (SHIP'S NAME AND HULL NO.) WILL PROVIDE RED STRIPE MTRF REPAIR STICKERS TO ALCON VIA SEPCOR
 - C. ALL NON-RFI AND RFI ASSETS WILL BE COORDINATED BY MATCONOFF//

BT

NOTE: ENSURE MESSAGES ARE IN ACCORDANCE WITH CURRENT MESSAGE FORMAT AND CURRENT PLAIN LANGUAGE ADDRESS DIRECTORY (PLAD) IS UTILIZED.

APPENDIX E

SAMPLE CVN MTRF REPAIR REQUEST MESSAGE

FM USS (SHIP'S NAME AND HULL NO.)/(TENDEED SHIP)
TO USS (SHIP'S NAME AND HULL NO.)//
INFO CTF//(AS APPROPRIATE)
CTG//(AS APPROPRIATE)
MATCONOFF//
BT
UNCLAS //N04790//
MSGID/GENADMIN/USS (SHIP'S NAME AND HULL NO.)/(TENDEED SHIP)
SUBJ/MTRF REPAIR REQUEST//
REF/A/DOC/CNALINST 4790.42/CNAPINST 4790.54//(AS APPROPRIATE)
AMPN/REF A SPECIFIES PROCEDURES FOR REQUESTING CVN MTRF ASSIST//
RMKS/1. IAW REF A, REQ MTRF ASSIST AS FOLLOWS:
A. PRIME EQUIPMENT/(AN/SPS-49, MK-86, AN/UYQ-21(V) ETC.)
B. CIRCUIT SYMBOL AND PN OF CCA/EM/ITEM TO BE TESTED
C. NSN OF CCA/EM/ITEM TO BE TESTED
D. DOCUMENT NUMBER/JSN/APL
E. PRIORITY
PRI ONE - CASREP/(ITEM REQUIRED TO CORRECT CASUALTY (A, C-4 B, C-3 C, C-2 D,
ANORS))
PRI TWO - SYSTEM/EQUIPMENT IS OPERABLE FROM ONBOARD OR BATTLE GROUP
STOCK. FWD NON-RFI CCA/EM TO MTRF FOR REPAIR
PRI THREE - REPAIR TO SPARE CCA/EM
F. BRIEF DESCRIPTION OF EQUIPMENT FAILURE
G. AVAILABLE TECH DOCUMENTATION
H. DISPOSITION OF NON-RFI IF NOT REPAIRABLE//
BT
**NOTE: ENSURE MESSAGES ARE IN ACCORDANCE WITH CURRENT MESSAGE FORMAT AND
CURRENT PLAD IS UTILIZED.**

(This Page Intentionally Left Blank)

APPENDIX F

**SAMPLE MTRF QUARTERLY REPORT MESSAGE
(Aircraft Carriers Only)**

FM USS (SHIP'S NAME AND HULL NO.)//
 TO TYCOM//(COMNAVAIRLANT OR COMNAVAIRPAC AS APPROPRIATE)
 INFO CNO WASHINGTON DC//
 COMLANTFLT NORFOLK VA//
 COMPACFLT PEARL HARBOR HI//
 COMNAVSEASYS COM WASHINGTON DC//
 NUWC DET NORFOLK VA//
 NAVSURFWPCEN CRANE IN//
 COMSPAWARSYS COM WASHINGTON DC//
 COMNAVSUPS COM WASHINGTON DC//
 BT

UNCLAS //N04790//

SUBJ/CVN MTRF (OE15) WORK CENTER QUARTERLY SUMMARY REPORT//
 MSGID/GENADMIN/USS (SHIP'S NAME AND HULL NO.)//
 REF/A/DOC/CNALINST 4790.42/CNAPINST 4790.54//(AS APPROPRIATE)
 AMPN/REF A CONTAINS REQ FOR MTRF QUARTERLY REPORT//
 RMKS/1. IAW REF A FOL DATA PROVIDED FOR 01JAN - 31MAR/

	CVN EQUIP	BG EQUIP
A. MTRF REPAIRS REQUESTED	(QTY)	(QTY)
B. MTRF REPAIRS INDUCTED	(QTY)	(QTY)
C. MTRF REPAIRS COMPLETED	(QTY)	(QTY)
D. CASREPS AVERTED/CORRECTED	(QTY)	(QTY)
E. CCAS/EMS TESTED WITH NO FAULT EVIDENT	(QTY)	(QTY)
F. OE15 WORK CENTER REPAIRS DOCUMENTED VIA 3-M SYSTEM	(QTY)	
G. TOTAL ESTIMATED MONETARY SAVINGS	(AMOUNT)	
H. SURFACE MOUNT TECHNOLOGY STATION UTILIZATION		(QTY)
I. PRIMARY DIAGNOSTIC EQUIPMENT USED FOR REPAIR		
(1) AN/USM-465		(QTY)
(2) AN/USM-674(V)(2) (ProTrack)		(QTY)
(3) HUNTRON TRACKER 2000/1000		(QTY)
(4) OTHER (SPECIFY EQUIPMENT)		(QTY)
J. RETURNED TO SUPPLY RFI (PART NO.) (NSN) (EQUIP/SYSTEM)		
K. CVN DEPARTMENT/DIVISION/WORKCENTER/SUPPORT DEPT (DEPT) (DIV) (WC/SD) (EQUIP/SYSTEM)		
L. RECOMMENDATIONS/COMMENTS//		

BT

NOTE: ENSURE MESSAGES ARE IN ACCORDANCE WITH CURRENT MESSAGE FORMAT AND CURRENT PLAD IS UTILIZED.

(This Page Intentionally Left Blank)

APPENDIX G
MTRF EQUIPMENT CONFIGURATION

1. The following list comprises the minimum MTRF WC equipment and accessory configuration.

a. Digital and Analog Testing Capability:

GPETE.

Huntron Tracker AN/USM-674(V)(2) (ProTrack)
Huntron Tracker 2000
Huntron Switcher 410
Huntron Shortracker Model 90

b. Personal Computer:

386 microprocessor with math co-processor
4MB RAM
3.5 or 5.25 inch floppy disk drive
80MB hard drive
Compact Disk - Read Only Memory (CD-ROM)
VGA monitor
Mouse
2 serial ports
1 parallel port

c. 2M Repair Station.

d. Modular Transfer Kits.

e. ESD Protection (Mat, Support Accessories).

f. Piece Parts Support:

Allowance Equipage List configured to site requirements.
VIDMAR parts cabinet.

g. Gold Disks for Huntron ProTrack.

(This Page Intentionally Left Blank)

VOLUME VI
CHAPTER 9
METROLOGY AND CALIBRATION PROGRAM

REFERENCES.

- (a) OPNAVINST 3960.16 - Navy Test, Measurement and Diagnostic Equipment (TMDE), Automatic Test Systems (ATS), and Metrology and Calibration (METCAL)
- (b) COMNAVAIRFORINST 4790.2 - Naval Aviation Maintenance Program
- (c) OPNAVINST 4700.7 - Maintenance Policy for U.S. Naval Ships
- (d) OPNAVINST 4000.57 - Logistic Support of the TRIDENT and POSEIDON Fleet Ballistic Missile (FBM) Systems
- (e) NAVSEAINST 4734.1 - NAVSEA Test, Measurement, and Diagnostic Equipment (TMDE) and Calibration Programs
- (f) NAVSEA ST700-AA-LST-010/NAVAIR 17-35NCA-1 - Navy Calibration Activity (NCA) List
- (g) NAVSEA OD 45845/NAVAIR 17-35MTL-1 - Metrology Requirements List (METRL)
- (h) NAVSEA ST000-AG-IDX-010 - Test, Measurement and Diagnostic Equipment Index (TMDEI) CD-ROM Version
- (i) NAVSEA ST700-AM-GYD-010/METCAL - METCAL Calibration Laboratory Requirements and Certification Guide
- (j) NAVAIR 17-35QAL-15 - Naval Aircraft Carrier and Amphibious Assault Ships Metrology and Calibration (METCAL) Program Manual
- (k) OPNAV 43P6 - MEASURE Users Manual
- (l) NAVSEAINST 4790.8/OPNAVINST 4790.4 - Ships' Maintenance and Material Management (3-M) Manual
- (m) NAVSUP Publication 485 - Afloat Supply Procedures
- (n) COMNAVSEASYS COM WASHINGTON DC 03004Z FEB 09 - SISCAL Policy Guidance - Level 2 Calibrations
- (o) NAVSEA S0400-AD-URM-010/TUM - Tag-Out Users Manual
- (p) NAVSEAINST C9210.4 - Changes, Repairs and Maintenance to Nuclear Powered Ships

9.1 **PURPOSE.** To promulgate policy and assign responsibility for the management of the Navy Test, Measurement and Diagnostic Equipment (TMDE) which includes the associated Metrology and Calibration (METCAL) program, in accordance with reference (a).

9.1.1 **Scope.** This instruction applies to all Navy commands whose maintenance policy and practices fall under the cognizance of references (b), (c) and (d) and Fleet shore activities such as Fleet Area Control and Surveillance Facilities. Excluded are calibration activities and equipment under the technical cognizance of the Radiation Detection, Indication and Computation program.

9.1.2 **Policy.** The Chief of Naval Operations (CNO), Office of the Chief of Naval Operations (OPNAV) N4, sets policy to ensure all TMDE used for quantitative measurements are maintained and calibrated at the lowest practical level. Specific CNO policy is stated in reference (a).

NOTE: TMDE IS GENERAL PURPOSE ELECTRONIC TEST EQUIPMENT (GPETE), SPECIAL PURPOSE ELECTRONIC TEST EQUIPMENT (SPETE), SUPPORT EQUIPMENT, CALIBRATION STANDARDS AND INSTALLED INSTRUMENTATION THAT SUPPORT HULL, MECHANICAL AND ELECTRICAL (HM&E), WEAPONS SYSTEMS, ETC.

9.2 RESPONSIBILITIES.**9.2.1 Fleet Commanders.**

- a. Operationally administer the TMDE and METCAL programs in accordance with reference (a).
- b. Ensure that TMDE calibration and repair is performed at the lowest level practical using certified laboratories and trained technicians.

- c. Calibrate all TMDE within the capability of the Regional Calibration Centers (RCC), Type Commander (TYCOM) and shipboard calibration activities.
- d. Assign a Fleet Representative to the TAMS Executive Board.
- e. Chair Fleet TMDE - METCAL Working Groups. Commander, Atlantic Fleet chair Test and Monitoring Systems (TAMS) Executive Board Fleet Support Standing Committee.
- f. Establish the Shipboard Instrumentation System Calibration (SISCAL) program in accordance with reference (e) as required.
- g. Provide funding for calibration and repair of TMDE including calibration standards, except as follows:
 - (1) Naval Air Systems Command (NAVAIR) will fund for fleet aviation TMDE calibration and repair.
 - (2) Strategic Systems Programs (SSP) will fund for TRIDENT TMDE calibration and repair.
- h. Evaluate Regional Maintenance Center (RMC)/RCC and coordinate with Naval Sea Systems Command (NAVSEA) for standards to support new capabilities.
- i. Provide funding for audit and certification of Fleet Navy calibration laboratories and Field Calibration Activities (FCA).

9.2.2 Type Commander.

- a. Assign a METCAL Manager to administer TMDE and METCAL program requirements in accordance with references (a) and (b). Serve as a voting member to the Fleet TMDE - METCAL Working Group.
- b. Review Fleet Forces Allowance Change Requests and forward to the TMDE Allowance Manager. TMDE Allowance Managers are: TYCOM for aviation activities, SSP for TRIDENT activities and NAVSEA 04 for all remaining activities.
- c. Redistribute excess TMDE. Aviation activities and TRIDENT activities will follow the guidance of NAVAIR and SSP respectively in redistributing TMDE. The Atlantic and Pacific Fleets will use the Consolidated TMDE Readiness Assessment (CTRA) Program.
- d. Provide properly trained personnel to authorized calibration activities for the repair and calibration of assigned TMDE. Manage assigned calibration standards and calibration laboratories and FCAs in accordance with reference (a) and the guidance provided by the appropriate Systems Command (SYSCOM). **Coordinate with the appropriate SYSCOM during pre-commissioning to verify if Establishment of Field Calibration Activity Request has been submitted and approved in accordance with reference (a).**
- e. Perform Quality Assurance reviews of laboratories and ensure compliance with this instruction and appropriate SYSCOM instructions.
- f. Budget and manage funds to support calibration overflow for calibration support beyond the capability of RMC/RCC, TYCOM and shipboard calibration activities.
- g. Ensure that Regional Loan Pools (RLP) are established in RMC/RCC.
- h. Coordinate with NAVSEA 04RM34 for Sub-Category (SCAT) assignments and Ship's Portable Electrical/Electronic Test Equipment Requirements List (SPETERL) revisions.
- i. Assist Fleet Commander representatives in managing the Fleet TMDE and METCAL programs.
- j. Assist platforms with their Departure From Specification (DFS) requests and coordinate approval of DFSs that require NAVSEA Technical Warrant Holder (TWH) approvals.

9.2.3 NAVSEA Technical Authority.

- a. The NAVSEA METCAL TWH is the Technical Authority for all equipment/systems under the NAVSEA technical cognizance.

- b. Naval Surface Warfare Center (NSWC) Corona Division is the TWH's Engineering Agent (EA) for metrology and calibration. NSWC Corona performs acceptance tests for new equipment for induction into the METCAL program, sets and modifies calibration intervals for non-installed TMDE and publishes metrology associated documents such as the Naval Calibration Activity List and the Metrology Requirements List (references (f) and (g)) in accordance with SYSCOM directives. NSWC Corona may be contacted by telephone or message for resolution of urgent technical problems related to calibration standards or Instrument Calibration Procedures.
- c. Naval Surface Warfare Center, Carderock Division, Ship Systems Engineering Station (NSWCCD-SSES) is the TWH's EA for all shipboard installed instrumentation. NSWCCD-SSES determines shipboard instrumentation calibration workload (cal "YES" or "NO") by applying the principles of Reliability-Centered Maintenance, sets and modifies calibration intervals for shipboard instrumentation/systems, develops and validates associated calibration procedures and publishes related calibration documentation such as ship-specific Calibration Requirements Lists (CRL), calibration procedures that are promulgated via the Planned Maintenance System (PMS) (Maintenance Requirement Cards (MRC)), and System Calibration Procedures (SCP) in accordance with NAVSEA directives (see paragraph 9.7 of this chapter). NSWCCD-SSES may be contacted by telephone or message for resolution of urgent technical problems related to calibration of shipboard instrumentation, calibration PMS and/or SCPs. (SSES).
- d. **Naval Air Warfare Center, China Lake** is the TWH EA for TMDE, prepares specifications for new TMDE and makes technical recommendations to the TMDE Program Manager on what instruments are listed in the TMDE Index. Seal Beach Detachment may be contacted by telephone or message for resolution of urgent technical problems related to all Navy TMDE.

9.2.4 Immediate Superior In Command.

- a. Monitor calibration readiness status within their respective organizations, especially ships in a pre-deployment status. Forward requests for assistance to the TYCOM METCAL Manager.
- b. Monitor the effectiveness of Shipboard Gage Calibration Program (SGCP) FCAs.
- c. Ensure that ships with FCAs extend their service to other ships in company, as appropriate, to reduce cost and turn-around time of calibration.
- d. Ensure that each ship with an FCA has all the necessary standards, documentation and trained personnel to maintain current certification.
- e. Coordinate resolution of calibration problems found by the TYCOM designated support activity for assigned ships.
- f. (Submarine Force only) Ensure each activity actively supports the TYCOM Calibration Program of Record by maintaining at least 95% accomplishment rate for all TMDE in its inventory. The TYCOM Calibration Program of Record readiness reports will be used to monitor the accomplishment rates.
- g. (Submarine Force only) Support and participate in the TYCOM's CTRA process. Ensure corrective actions resulting from the conduct of a CTRA are completed for activities under the Immediate Superior In Command's (ISIC) cognizance.

9.2.5 Commanding Officers All Forces.

- a. Maintain a high degree of TMDE calibration readiness including installed instruments.
- b. Appoint in writing, a calibration coordinator/test equipment manager responsible for all matters related to the calibration of ship's TMDE. Separate coordinators may be appointed for electronic and mechanical equipment.
- c. Maintain TMDE allowances in the SPETERL. Advise the TYCOM METCAL Manager and contact the CTRA to fill deficiencies prior to submitting requisitions for replacement test equipment through the supply system.
- d. (Submarine Force only) Prior to the completion of a CTRA, deliver excess, rejected and obsolete (PRI 95) test equipment for the designated CTRA center.

- e. Use only standard test equipment listed in reference (h). Inform the TYCOM METCAL Manager of system maintenance requirements that are not supported by standard test equipment. SPETE that is approved per reference (e) is authorized for designated systems only. SPETE shall not be used as a general purpose test requirement.
- f. Ensure TMDE is submitted for calibration prior to the calibration due date, with all accessories, power cords and technical manuals required to complete calibration.
- g. Submit pre-deployment calibration requirements to the RMC METCAL Coordinator at least 60 days before deployment. Conduct an inventory of all SPETE to confirm material condition and calibration due dates.
- h. Calibration Readiness Goal: Submarine Force - 95%
Air Force and Surface Force - 85%

9.2.6 Commanding Officers Surface Force.

- a. Ensure the SGCP FCA is currently certified and properly staffed with trained personnel, documentation and calibration standards (allowance quantities listed in the SPETERL).
- b. Ship's Force is responsible for the calibration of all instrumentation within their SGCP FCA capability. SGCP trained technicians are the only authorized personnel to accomplish calibration using SGCP calibration standards. The SGCP calibration procedures are found in the shipboard Planned Maintenance System (PMS), workcenter FCA1, Maintenance Index Page (MIP) 9802 series. SGCP calibration standards allowance quantities are listed in the SPETERL per reference (i).
- c. Ensure the CRL is used as a technical authority guidance to determine calibration requirements for all installed instruments. The calibration requirement determines whether an installed instrument is either critical or non-critical. Critical instruments are defined as instrumentation that monitors a parameter which is required to be within a specified operating range, or limits, to minimize hazards to human safety or failure of a mission essential equipment or system. These instruments are calibrated at a specific frequency (e.g., 12, 18, 24 or 36 months). All other instruments are classified as non-critical, No Calibration Required (NCR).
- d. Use a TYCOM approved formal recall system for scheduling, planning and monitoring the ship's calibration status.
- e. Ensure FCA equipped ships offer support to other ships in company on a not-to-interfere basis with own ship's work schedules.
- f. Request calibration services, beyond the capability of the onboard FCA, from the RMC METCAL Coordinator.
- g. Maintain liaison with the RMC METCAL Coordinator to make sure TMDE scheduled for off-ship calibration are delivered and returned according to the agreed upon schedule.
- h. Use the RLP for maintenance requirements while the ship's test equipment is being calibrated or as indicated in the SPETERL (borrow from Regional Loan Pool).
- i. Ensure all TMDE has a current calibration sticker, reference (i).
- j. Ensure all calibration is conducted at the lowest level of calibration feasible.
- k. Ensure all ship's instrumentation appears in a formal calibration accounting and recall system. This data should reflect CRL information such as system, nomenclature, periodicity, etc. The CRL should also be validated annually and these updates (adds/deletes) should be forwarded via Technical Manual Deficiency/Evaluation Report (TMDER) to correct the hull specific CRL.
- l. SGCP FCA calibration procedures are listed in MIP 9802 series and should be listed under PMS work center FCA1.

9.2.7 Commanding Officers Naval Air Force. Naval Air Force activities shall also follow the detailed procedures outlined in reference (j) for TMDE management and for operation of the consolidated FCA.

9.2.8 Regional Maintenance Center Metrology and Calibration Coordinators.

- a. Coordinate and schedule off-ship calibration or repair services for ships within their geographic area of responsibility. Specific lack of capability is the only justification for off-ship calibration.
- b. Maintain close liaison with the RMC/RCC shipboard calibration coordinators and the ISIC to prevent or resolve calibration scheduling and readiness problems.
- c. Review ship's calibration work requests to ensure that TMDE within the calibration capability of the ship's FCA are not sent to a higher-level calibration laboratory.
- d. Contact all deploying ships that have not delivered a pre-deployment calibration work package at least 45 days before deployment to determine ship's requirements.
- e. Notify TYCOM METCAL Managers, as applicable, of all changes in RMC/RCC calibration capability.
- f. Assist RMC/RCC calibration laboratories in obtaining calibration or repair services for laboratory standards.
- g. Identify TMDE calibration requirements beyond the technical capability of the RMC/RCC. Coordinate with TYCOM METCAL Managers for scheduling of TMDE overflowed to an approved calibration laboratory.

9.2.9 Regional Maintenance Center/Regional Calibration Center.

- a. In the absence of an approved Instrument Calibration Procedure for TMDE within the general range of the laboratory capability, develop a Local Calibration Procedure in accordance with reference (e), and then calibrate the instrument. Technical manuals, manufacturers' guides or other equipment technical documentation may be used to develop the interim procedure. Forward the locally developed procedure to NSWC Corona for review and approval.
- b. Calibrate and/or repair TMDE including calibration standards assigned by the RMC METCAL Coordinators. Document all calibration actions using the **METBENCH Calibration Management System (MCMS)**, Metrology Automated System for Uniform Recall and Reporting (MEASURE) or the TYCOM directed data collection method.
- c. Ensure that electronic TMDE submitted by the Fleet is standard test equipment listed in reference (h). Contact the submitting activity and the TYCOM METCAL Manager when non-standard TMDE is submitted for calibration. Non-standard TMDE will not be calibrated or repaired unless approved by the TYCOM.
- d. Ensure all laboratory standards are properly calibrated at the lowest appropriate level. Notify the TYCOM METCAL Manager of any lost or reduced laboratory capability.
- e. Ensure all TMDE repaired by the RMC/RCC are completely recalibrated before being returned to service. Calibration of a repaired instrument will serve as Quality Assurance of an accomplished repair.
- f. Prepare and submit Calibration Problem Reports to NSWC Corona for assistance or guidance concerning calibration problems encountered during operation of the calibration laboratory.
- g. Refer to Section 9.5 of this chapter for replacing malfunctioning calibration standards certified by a repair facility to be Beyond Economical Repair (BER), (i.e., having a repair cost in excess of 50% of the replacement cost).

9.3 CALIBRATION MANAGEMENT.

9.3.1 Shipboard Gage Calibration Program Field Calibration Activity (Surface Force only). The SGCP provides onboard calibration capability for TMDE in the following measurement areas: temperature (high and low), pressure, vacuum and torque (selected ship classes only).

- a. Only certified SGCP FCAs are authorized to calibrate installed instrumentation within their capability as designated in the CRL. Beyond capability calibration is submitted to the RMC Calibration Coordinator for scheduling and accomplishment.

- b. The SGCP technicians are responsible for placing the appropriate METCAL label on the installed instruments. The SGCP Calibration Coordinator is responsible for adding the calibration data into the TYCOM directed recall program.
- c. SGCP FCAs shall establish PMS work center FCA1. PMS MIP 9802 series are the calibration procedures for SGCP FCAs.
- d. Non-critical instrumentation will have an NCR METCAL label attached. When a NCR instrument's reliability is suspect, it will be sight compared with a critical instrument or a SGCP standard. When a NCR instrument is repaired or replaced, it will be installed and sight compared with a critical instrument or SGCP standard. If a primary instrument is out of commission, a NCR instrument may be calibrated at the discretion of the inspection team to validate system parameters.
- e. The SGCP Calibration Coordinator is responsible for ensuring that the CRL data is aligned with ship's configuration and ensuring that instrumentation identified in the TYCOM calibration recall inventory matches CRL data: system, nomenclature, periodicity, etc. Recommended changes shall be forwarded to the EA via MCMS or TMDERS.

9.3.2 Calibration Accounting. TMDE calibration actions are recorded in the TYCOM directed Calibration Recall Program. Surface force ships use one of the three different programs: MEASURE (LHA/LHD), MCMS, or the TYCOM Calibration Recall Program (TCR).

- a. Measure implementation and operation guidance, reference (k).
- b. MCMS supports surface force ships and provides shipboard personnel with the capability to update inventory files using LAN access. MCMS also provides the capability to generate reports and upload data to the master server through distance support. Readiness information and inventory status is readily available to Ship's Force and TYCOM METCAL Managers.
- c. TCR program (Excel file) is used on those ships that do not yet have MCMS installed. The file provides inventory information to track calibration status.

9.3.2.1 Shipboard Calibration Recall Inventories for MEASURE, TCR, and MCMS (Surface Forces).

- a. MEASURE and TCR.
 - (1) "S" inventory: All installed instrumentation identified in the CRL and mechanical TMDE that is not SCAT coded (i.e., torque wrenches, micrometers, etc.). The SGCP calibration standards are included in this inventory.
 - (2) "E" inventory: All portable test equipment including electronic and mechanical SCAT coded test equipment that appears in the SPETERL (excluding the SGCP calibration standards).
- b. MCMS.
 - (1) "S" inventory: All installed instrumentation identified as CAL=Y in the CRL. (All installed instruments i.e., both Cal = Y or N are in the "CRL" tab.)
 - (2) "E" inventory: All portable test equipment including electronic and mechanical SCAT coded test equipment that appears in the SPETERL (excluding the SGCP calibration standards).
 - (3) "P" inventory: All mechanical TMDE that is not SCAT coded (i.e., torque wrenches, micrometers, etc.). The SGCP calibration standards are included in this inventory.

9.3.3 Submarine Forces Management Policy.

- a. Personnel certified as submarine FCA technicians will use PMS MIPs/MRCs to accomplish shipboard in-place calibrations.
- b. Personnel certified as FCA Technicians for platforms assigned to COMSUBLANT/COMSUBPAC are to utilize PMS MIP 9802 series for the performance of in-place shipboard instrument calibration.

- c. The scheduling and reporting of calibration actions will be accomplished via **MCMS** and MEASURE systems as directed by the appropriate TYCOM. All assigned MIPs/MRCs are to be maintained in accordance with the requirements of reference (l).
- d. All components being calibrated using a calibrator (i.e., 3666, 3461, 1127, 3604, 3605, etc.) will have a calibration sticker affixed. The system calibration periodicity will be governed by the CRL.
- e. A certified FCA technician is required for the operation of calibration equipment called out for use in the performance of any PMS requirement.
- f. System calibration will utilize the miniature yellow “Special Calibration” sticker annotated to reflect system calibration and the components tested. This Special Calibration sticker is to be located on the “readout component”. When the “readout component” is a flat panel display, PLC interface display, laptop or similar display method, apply the label to the instrument vice the “readout component”. Also, in those cases where a transducer provides an alarm or shutdown function but no indication or parameter measurement (i.e., air compressor high pressure shutdown), apply the calibration sticker to the transducer.

9.4 REGIONAL LOAN POOLS. RLPs are established at the RMC/RCC to alleviate shipboard maintenance support shortfalls caused by a lack of shipboard GPETE due to calibration or repair requirements.

- a. RLPs include a wide variety of calibrated, Ready For Issue items stocked in sufficient quantity to ensure continuous availability.
- b. GPETE from the RLPs may be checked out for a specific purpose (i.e., repair of the AN/SPS-73 Radar, PMS of the AN/WSC-3, etc.) or to satisfy a temporary requirement for special purpose items not normally included in the ship’s allowance. Pool items are intended as short-term substitutes for unavailable shipboard items. Pool items may be checked out for ten working days; however, the RMC METCAL Coordinator may authorize an extension of the ten day limit on a case basis.
- c. All GPETE returned to the RLP shall be inspected by representatives of the lending RMC/RCC and the borrowing command. The original inventory receipt is checked to see if the GPETE has been damaged or is missing accessories provided at the time of the loan. GPETE lost, damaged beyond repair or destroyed must be surveyed by the borrowing command using procedures established in reference (m). A copy of the completed survey report shall be forwarded to the appropriate TYCOM METCAL Manager.

9.5 REPLACEMENT OF GENERAL PURPOSE ELECTRONIC TEST EQUIPMENT/CALIBRATION STANDARDS.

9.5.1 Depot Level Repairables. GPETE/Calibration Standards (CAL STD) (7Z Cog), certified by a RMC/RCC or a higher-level activity as BER will be turned into the Naval Supply System. (Note: NAVAIR CAL STDs will not fall under these instructions.) For BER NAVAIR CALSTDs, RMC/RCC and Customer activities are required to contact TYCOM METCAL manager.

- a. The RMC/RCC certifying the GPETE/CAL STD as BER may turn the defective unit in to the Navy Supply System for the customer activity, provided the customer has given the RMC/RCC a requisition number under which a replacement will be ordered. If the RMC/RCC turns the defective GPETE/CAL STD in to the Naval Supply System, all turn-in data must be given to the customer to assist in any future carcass tracking follow-up investigations by the Naval Supply System.
- b. The customer activity may accept return of the defective GPETE/CAL STD from the RMC/RCC and initiate turn-in and replacement procedures through the normal Navy Supply System process.
- c. Depot Level Repairable GPETE/CAL STD will not be processed for survey by a RMC/RCC.

9.5.2 Navy Stock Funded. GPETE (1H or 9N Cog), certified by an RMC/RCC or a higher-level authority as BER will be processed for survey.

- a. The RMC/RCC certifying the GPETE/CAL STD that is BER must notify the customer of a requirement to survey the defective GPETE/CAL STD. The customer is responsible for initiating a survey action and requisitioning a replacement item through normal Operating Target funded supply channels.

- b. The RMC/RCC certifying the GPETE/CAL STD as BER may retain the carcass for cannibalization of repair parts provided the customer has acknowledged that the survey process has been initiated and has provided a copy of the survey document to the RMC/RCC.

9.6 TEST MEASUREMENT DIAGNOSTIC EQUIPMENT MANAGEMENT.

9.6.1 Ship's Portable Electronic Test Equipment Requirements List. The SPETERL is the allowance document for all GPETE, SPETE and FCA calibration standards. Test equipment and FCA calibration standards allowance requirements (quantity and type) are computed on an individual ship's entire configuration of installed electrical and electronic equipment, with due consideration for function, quantity, usage and location of prime equipment. The Allowance Change Request form, NAVSUP 1220-2, is used to request an increase or decrease in the SPETERL allowance.

9.6.2 Test Measurement Diagnostic Equipment Index. Reference (h) is the primary source for determining test equipment uses and requirements. Consult reference (h) to determine the preferred model of test equipment needed to fill a specific deficiency. Test equipment deficiencies fall into two categories, initial outfitting and replacement.

9.6.3 Sub-Category Code. Defines a family of test and measurements parameters. Test equipment within the SCAT code is prioritized in accordance with reference (m), with the lowest priority number assigned to the TMDE currently being procured to fill outstanding deficiencies. SCAT codes are the basis for identifying TMDE on MRCs.

9.6.4 Ship's Configuration and Logistics Support Information System Index. The primary test equipment inventory document for ships. The Ship's Configuration and Logistics Support Information System (SCLISIS) Index must be kept current by the submission of completed OPNAV 4790/CK forms.

9.6.5 Consolidated Test, Measurement and Diagnostic Equipment Readiness Assessment.

9.6.5.1 Consolidated Test, Measurement and Diagnostic Equipment Readiness Assessment Program. The CTRA Program is a joint fleet program that improves fleet and shore command non-Aviation TMDE readiness. The CTRA Program also includes the receipt, staging and redistribution of Fleet excess electronic test equipment, mechanical test equipment and calibration standards used to replace equipment that is missing or BER.

9.6.5.2 Type Commander Metrology and Calibration Program Managers. TYCOM METCAL Program Managers are responsible for the following:

- a. Scheduling a CTRA during ship Fleet Readiness Training Plan or Integrated Logistics Overhaul and every 18 to 24 months for shore commands.
- b. Budget for the CTRA program as necessary.
- c. Develop and promulgate CTRA schedule as required.
- d. Maintain excess test equipment and calibration standards at CTRA staging area for redistribution to fleet activities.

9.6.5.2.1 Consolidated Test, Measurement and Diagnostic Equipment Readiness Assessment Review Process.

- a. Brief ship's department heads, division officers and technicians.
- b. Conduct training for TMDE management and the calibration recall software.
- c. Review SPETERL and electronic (E) TMDE inventory with the ship's Combat Systems Test Equipment manager. Review will include: Configuration verification of prime systems and Fleet Supplemental Test Equipment Requirements, verification of shipboard TMDE inventory and revisions to the TYCOM approved calibration recall system inventory, prime system and test equipment updates to Navy configuration database (if during Integrated Logistics Overhaul availability), identification of SPETERL allowance changes based on actual configuration, listing of inoperable items and coordination of repair of items that fill deficiencies, removal of excess equipment from the ship and filling of deficient equipment from CTRA staging assets. Deficient initial outfitting items will be coordinated through NAVSEA.
- d. Review Mechanical "S" inventory with the SGCP Coordinator using the CRL to determine calibration requirements (TCR and MEASURE ships only). Mechanical test equipment will be listed on this mechanical inventory. Use the CRL to validate the recall inventory (TCR and MEASURE ships only).

- e. (Submarine Force only) Prior to the completion of a CTRA, coordinate the delivery of identified excess test equipment to the designated CTRA facility.
- f. Provide the results of the assessment to the ship.

9.6.5.2.2 Consolidated TMDE Readiness Assessment Test, Measurement and Diagnostic Equipment Redistribution.

The CTRA Center manages the redistribution of Fleet TMDE to fill allowance deficiencies or replace equipment that is missing or BER. Excess TMDE and decommissioned ships' assets are received and made available for redistribution to FLEET activities. Fleet activities are required to forward all excess TMDE to the CTRA Center and to utilize the CTRA Center for the initial requests to fill replacement or deficient SCAT coded TMDE.

9.6.5.2.3 Completion and Corrective Action Reporting (Submarines only). Executive Director, Submarine Maintenance Engineering, Planning and Procurement (SUBMEPP) Activity issue a CTRA Completion Report, via the parent ISIC with TYCOM on copy, outlining corrective actions to be taken by the assessed command as a result of the CTRA. The assessed command will issue a corrective action letter within 90 days of receipt of the CTRA Completion Report, via the parent ISIC with TYCOM on copy, to Executive Director, SUBMEPP Activity.

9.7 SHIPBOARD INSTRUMENTATION AND SYSTEM CALIBRATION. The SISCAL Program, which includes SGCP, is responsible for the calibration and maintenance support for installed instrumentation and machinery control system calibration requirements per reference (e). Installed instrumentation calibration support parameters are documented in the ship specific CRL as follows:

- a. Calibration Activity. Defines responsibility for calibration of shipboard installed instrumentation for the following three calibration activities.
 - (1) Calibration Activity 1 (Level 1). Shipboard FCA is responsible for calibrating stand-alone instrumentation (i.e., gages, thermometers and switches). Instruments are typically calibrated onboard (in place/onsite) by the certified SGCP technicians using PMS MIP 9802 calibration procedures per the hull specific CRL. On submarines, shipboard FCA also perform transducer calibrations (system calibration) using H coded calibration cards in the PMS deck.
 - (2) Calibration Activity 2 (Level 2). (Applicable to Surface Force ships, aircraft carriers and Landing Craft Air Cushion (LCAC)) SISCAL teams perform calibration support for machinery control system components (i.e., pressure transducers, temperature transducers, signal conditioners, display devices, meters, etc.). Except during yard/industrial periods when testing is mandated, these components are not calibrated as individual items. Instead, the entire measurement chain is calibrated as a single entity using Navy approved calibration standards and SCPs. Only SISCAL teams are authorized to use SCPs. Level 2 calibrations are performed onboard (in place/onsite) by SISCAL teams certified by the SISCAL EA, SSES 953. These teams are:
 - (a) Surface Ships and aircraft carriers - NSWC SSES, NAVSHIPYD and IMF Pearl Harbor and NAVSHIPREPFAC Japan. These teams will be augmented by RMC I-Level Production.
 - (b) Landing Craft Air Cushion (LCAC) - certified SISCAL teams at Assault Craft Units.
 - (3) Calibration Activity 3 (Level 3). RCC calibrates those instruments which require the use of unique calibration standards or facilities.
- b. SISCAL Team Scheduling. (Not applicable to Sub platforms) SISCAL scheduling begins approximately six months before expiration date and is coordinated between the Port Engineer/CVN Maintenance Manager/SHIPSUP and the SISCAL scheduler. The SISCAL team workload is the Calibration Activity 2 instruments listed in the ship's CRL and is accomplished only by the NAVSEA authorized calibration agents listed above. SISCAL visits are scheduled for both triennial SISCALs and subsequent return visits (call-back). If a ship is in an industrial environment then reference (n) applies until SISCAL effort can commence within the six months post industrial availability period.
- c. SISCAL Dashboard. A bi-weekly document issued by the SISCAL EA via email to all SISCAL stakeholders provides the following:
 - (1) Triennial SISCAL visit scheduled on or before the calibration due date.

- (2) SISCAL Report. A SISCAL report is provided to the ship after the triennial SISCAL visit. The report identifies the results of the calibration effort and includes a listing of all instruments that were not calibrated during the visit. Instruments that were not calibrated are listed under the following categories:
 - (a) Rejected (broken or out of tolerance).
 - (b) Previously rejected (PRE_REJ), left over from last SISCAL.
 - (c) Not Installed (NI), instrument missing.
 - (d) Not Done Due to Ship Operations (NDSO).
 - (e) Not Done at Ship's Request (NDSR).
 - (f) Not Done Due to Shipyard (NDSY).
 - (g) Could Not Be Isolated (CNI).
 - (h) Equipment Out Of Commission (OOC).
 - (i) Not On Site Capable (NOSC), No Procedure (NOPRO) or No Calibration Standard (NS). NSWV SSES will coordinate with NAVSEA Program Offices to resolve.
 - (3) Call-back SISCAL visit. Listed as either a SISCAL call-back or SISCAL II. SISCAL II is used when more than 100 instruments require calibration. Visit is requested by ship, SHIPSUP or Port Engineer/CVN Maintenance Manager via OPNAV 4790/2K or AWR. Call-back requests citing multiple instruments are preferred to maximize SISCAL manpower availability and minimize cost. Non-specific requests (e.g., calibrate various instruments) should be avoided since the task breadth (quantity of instruments) and scope (type of instruments) cannot be readily determined. The 2K also identifies the deferred maintenance for the instrumentation in the Current Ships Maintenance Project (CSMP).
- d. Departure From Specification (DFS). DFS messages are requests for temporary departures and are submitted in accordance with Volume V, Part I, Chapter 8 of this manual.
- (1) A DFS for deferring SISCAL could be submitted for the following reasons:
 - (a) Extending the periodicity of the ship's SISCAL requirement. TYCOM approves DFS up to six months. DFS in excess of six months requires NAVSEA 04RM concurrence.
 - (b) Extending the periodicity for individual Level 2 and 3 instruments with expired calibration due dates or replaced while away from homeport/calibration facility.
 - (c) Level 2 instruments that were not calibrated during SISCAL due to lack of a calibration procedure or calibration standard.
 - (d) Other shipboard SISCAL DFS requests will be evaluated on a case-by-case basis.
 - (2) DFS requests will not be approved for the following:
 - (a) Instrumentation within the calibration capability of the SGCP FCA.
 - (b) Instrumentation not calibrated during a SISCAL visit due to an out of commission or rejected status.
- e. Shipboard Level 1 calibration workload beyond shipboard FCA capability or capacity must be submitted to their respective TYCOM and/or RMC calibration coordinator for scheduling and accomplishment. When contracted out to a Commercial Calibration Activity (CCA) or Commercial Service Provider (CSP) or an Original Equipment Manufacturer (OEM), the CCA/CSP/OEM calibrating such instruments must meet the NAVSEA METCAL TWH guidance for certification/accreditation, traceability and Test Accuracy Ratio/Test Uncertainty Ratio/Probability of False Accept. Commercial activities must provide the results of all calibrations performed by them and must use periodicities listed in the CRL for installed instruments. Commercial activities must also

provide calibration event data to Ship's Force and TYCOM in a Microsoft Excel format for easy entry into the TYCOM Calibration Recall Program. Entries in the calibration events file shall not be abbreviated. For existing, permanently installed instruments, the calibration events file data set shall include the nomenclature, CRL reference number, condition received (i.e., In Tolerance (IT) or Out of Tolerance (OOT)), date calibrated, date due, procedure used, calibration standard used, servicing lab code and service label applied (i.e., calibrated, special calibration, rejected, etc., in accordance with reference (i)).

9.7.1 Calibration Requirements List. The CRL is the technical authority document for installed calibration requirements and includes data pertinent to each instrument (e.g., nomenclature, system, periodicity, calibration activity, etc.).

- a. The CRL is the specific primary technical authority guidance for shipboard installed instrumentation. CRLs are uploaded and maintained in the MCMS. For those ships that don't have MCMS, a CD-ROM will be distributed.
- b. CRL Validation. Ship's Force and/or TYCOM validate the CRL to identify any gaps or required modifications for their platform's unique configuration. Submit TMDERs for CVNs, Technical Feedback Reports for submarines and MCMS feedback for surface ships for conflicts in nomenclature, function, range, location or calibration requirement. SISCAL teams are responsible for validating Level 2 instruments on surface ships and LCACs, LHA/LHDs/CVNs.

Hardcopy TMDER changes shall be addressed to:

COMMANDER, CODE 310
TMDER BLDG 1388
NAVSURFWARCENDIV NSDSA
4363 MISSILE WAY
PORT HUENEME CA 93043-4307

TMDERs can also be generated and sent electronically at the NSDSA website:

<https://nsdsa2.phdnswc.navy.mil/tmder/tmder.asp?lvl=1>

- c. **For Calibration Recall and Inventory Systems other than MCMS**, Ship's Force should match CRL data to the METCAL Automated Information System or Calibration Recall **and Inventory System inventory** and submit changes to the MEASURE Operational Control Center if the CRL and METCAL Automated Information System do not have matching data elements. **Refer to the CRL CD-ROM Users Guide.**
- d. The CRL is the technical authority document for all shipboard instrumentation calibration requirements. To preclude continuous and duplicative review of TMDERs, inspecting activities are to coordinate directly with NAVSEA METCAL TWH, regarding any instrument believed to be critical but indicates No Calibration Required in the CRL. **Ship's Force shall not calibrate these instruments unless specifically approved by NAVSEA METCAL TWH.**
- e. Broken or inoperative Level 2 installed instruments identified as CAL=Y in the CRL that are replaced during deployment must be calibrated prior to use. Broken or inoperative Level 2 instruments replaced during deployment must be calibrated as stand-alone instruments if they cannot be system calibrated prior to use. If unable to calibrate due to lack of Calibration Standard, qualified personnel or calibration procedure, submit a DFS in accordance with paragraph 9.7d. of this chapter and use an "Out-of-Cal" label in accordance with reference (o). Extreme care should be exercised when using "Out-of-Cal" instruments.

9.7.2 Calibration Interval. Since calibration intervals are identified in different technical documents, use the following order of precedence for determining and assigning the proper calibration interval:

- a. Reactor Plant Manual.
- b. PMS documentation.
- c. CRL.

- d. Reference (g) of this chapter. Unless superseded by PMS, the generic calibration intervals for all other instruments found in Section 2 of reference (g) will be used.
- e. System or equipment technical manuals.

9.7.2.1 Switch Settings. Switch settings shall be in accordance with the applicable values listed in the CRL/MCMS for surface ships/Air Capable Ships and PMS system MRCs for submarines. If there is “To Be Determined” or no value listed, consult the applicable equipment technical manual and submit TMDER/Technical Feedback Report or MCMS feedback to get the documentation updated. Provide CRL Reference Number, setting used and the reference document used to derive the setting.

9.7.3 Markings for Test, Measurement and Diagnostic Equipment.

- a. Installed Instrumentation. All instrumentation will have easily read serial numbers and be clearly labeled with current calibration labels per NAVAIR 17-35-TR8 except the Level 1 instruments that are calibrated by CCAs, CSPs or OEMs meeting the requirements of 9.7e. of this chapter will be affixed with their own labels showing their unique identifiers instead of the Navy METCAL labels. If the instrument does not have a serial number inscribed by the manufacturer, Ship’s Force must inscribe a ship-generated serial number in a clearly visible location. Attached tags are acceptable for instruments without space for inscribing a serial number. Serial number should include: Hull Number + CRL reference number (i.e., DDG5100025).
- b. Serial Numbers for TMDE other than Installed Instrumentation. All TMDE will have easily read serial numbers and be clearly labeled with current calibration labels per NAVAIR 17-35-TR8 except TMDE that is calibrated by CCAs, CSPs or OEMs meeting the requirements of 9.7e. of this chapter will be affixed with their own labels showing their unique identifiers instead of the Navy METCAL labels. If the TMDE item does not have a serial number inscribed by the manufacturer, Ship’s Force must inscribe a ship-generated serial number in a clearly visible location. Attached tags are acceptable for TMDE without space for inscribing a serial number. Serial number should include: Hull Number + Work Center + four digit sequential number starting with 0001 (i.e., DDG51OE010001). The new serial number should be annotated in the TYCOM Calibration Program, either by the SGCP FCA for mechanical instrumentation or the Test Equipment Petty Officer for electronic test equipment.
- c. The “Out-of-Cal” label listed in reference (o) is not a METCAL label but rather an operational label used to make watch standers aware of abnormalities that require additional attention. Please refer to reference (o) for proper use of the label. Extreme care should be exercised when using “Out-of-Cal” instruments.

9.7.4 SISCAL System Level Calibration Guidance for Ship Conversion Navy Platforms and Platforms in CNO or other Maintenance Availabilities.

- a. The purpose of this section is to address the calibration of shipboard installed instrumentation requiring system calibration (Level 2) for new construction ships, ships in availability/overhaul and ships in their Fleet Response Training Plan (FRTP). This section does not apply to systems/instruments that are calibrated using the reactor plant manual guidance.
- b. For Ship Conversion Navy (SCN) platforms, the CRL is promulgated within 90 days of delivery and a baseline SISCAL team visit should occur as soon as practicable but must be completed within six months of Post Shake-Down Availability or availability completion. Prior to system/equipment acceptance testing and turnover to the Navy, the SCN program managers shall ensure that all installed instrumentation requiring Level 2 calibration has been verified/tested by the shipyard/repair activity to ensure that they meet manufacturer’s performance specification.
- c. For COMNAVSURFOR and COMNAVAIRFOR FRTP platforms, no changes have been made to the current Level 2 calibration requirements for ships in their FRTP cycle. Ships shall submit a work request as needed to maintain current periodicity requirements.
- d. Any work package authorizing modernization (i.e., accomplishment of a Ship Change Document outside of a scheduled availability), shall include a requirement for calibration of Level 1 components as stand-alone individual items before turnover to the Navy and is the responsibility of the sponsor of the specific modernization item. These components shall have valid calibration labels per NAVAIR

17-35-TR8 or calibration labels from CCA/CSP/OEM that meet NAVSEA METCAL TWH requirements. In addition, work packages that modify or install either complete or partial “measurement/signal chains” consisting of individual components (e.g., sensors, signal conditioners, displays) shall also include a requirement for a Level 2 (system-level) calibration by a NAVSSES certified SISCAL team after completion of system acceptance testing by the Navy. All installed instrumentation requiring Level 2 calibration should be verified/tested by the shipyard/repair activity to ensure that they meet manufacturer’s performance specification. The Level 2 calibration must be completed within six months of system turnover to the ship. Should this requirement not be identified in existing planned and budgeted modernization efforts, it should be handled individually with sponsor. Work packages which only replace individual measurement chain components that are designated as NCR in the CRL such as Remote Temperature Detectors, thermocouples, magnetic pickups, etc., would not require Level 2 system calibration.

- e. To mitigate warranty and contractual issues on ships in industrial availabilities (i.e., maintenance availabilities or SCN overhauls), the NAVSEA Metrology and Calibration TWH has authorized a six month temporary DFS for system calibration of systems designated as Level 2 per the ship’s CRL. To facilitate equipment testing and acceptance by the Navy during the industrial period, the following actions should be taken:
 - (1) Systems requiring system level calibration which are not affected by the availability or overhaul shall be calibrated prior to start of the availability/overhaul to ensure that such systems are not in overdue status upon completion of the yard period.
 - (2) Systems or equipment that are added or modified with either complete or partial “measurement/signal chains” consisting of individual components (e.g., sensors, signal conditioners, displays) shall include a requirement for the components to be verified/tested by shipyard/repair activity to ensure that they meet manufacturer’s performance specification before system/equipment acceptance testing and turnover to the Navy. Note that while the TWH has authorized a DFS for system level calibration during the industrial period, the DFS must be approved by the TYCOM in accordance with Volume V, Part I, Chapter 8 of this manual.
 - (3) Validity of all calibration labels shall be verified during start-up maintenance.
 - (4) The Level 2 system calibrations must be scheduled and completed within six months of system turnover to the ship.
- f. It should be recognized that individually calibrated components, which are part of a measurement chain requiring system calibration, may not adequately represent the measurement accuracy normally provided by the system calibration process. Therefore, care should be exercised when using systems under temporary departure from system level calibration requirements.
- g. Inspection teams, assessment organizations and training groups shall not require ships coming out of an availability, overhaul or new construction to have Level 2 calibrations completed prior to the ship’s first post maintenance period SISCAL visit unless the 6 month period has passed.

9.8 LHA AND LHD CLASS SHIP METROLOGY AND CALIBRATION PROGRAM.

9.8.1 Purpose. To establish the consolidated METCAL program for LHA and LHD class ships. This guidance implements policy and responsibility for the management of TMDE onboard these ship classes. The CNO METCAL policy is promulgated in reference (a).

9.8.2 Background. LHA and LHD class ships have formerly operated three distinct calibration programs: AIMD FCA for aviation Support Equipment; Combat Systems Electronic FCA supporting GPETE and SPETE for the ship’s non-aviation electronic/electrical and weapons systems; and the Engineering SGCP for installed instrumentation associated with HM&E systems. This guidance establishes and describes a consolidation of the three programs into a single program for shipboard calibration support. For the purpose of this section, TMDE are considered to be all shipboard GPETE, SPETE, Support Equipment, calibration standards and the installed instrumentation that support HM&E systems.

9.8.3 Discussion. The forces afloat METCAL program for LHA and LHD class ships is intended to improve force readiness and self-sustainability through the consolidation of the three existing, separate calibration programs laboratories into a single management entity under the management of the AIMD Officer. This guidance preserves the positive aspects of all previous calibration programs and results in a more efficient use of personnel, a conservation of physical space and a reduction of expenditures for calibration standards.

9.8.4 Scope. This guidance is directive in nature and may be cited as authority for actions as the need dictates. Reference (j) is a parallel effort onboard aircraft carriers, and may be used as an authoritative reference for overlapping procedures and responsibilities. Reference (k) provides MEASURE documentation procedures. Reference (g) remains the authoritative reference document for all general procedural issues relating to calibration. Reference (b) addresses CNO concepts, policies, organizations, maintenance support procedures and organizational/intermediate maintenance. In the event the contents of this guidance or reference (j) conflict with any directive issued by higher authority, the latter shall prevail.

9.8.5 Applicability. This guidance is applicable for all calibration performed by LHA and LHD class Ship's Force personnel, with the exception of technical matters pertaining to Radiation Detection, Indication and Computation equipment, which are the responsibility of Commander, Naval Sea Systems Deputy for Logistics (SEA 04). Nothing in this directive detracts from these responsibilities.

9.8.6 Action.

- a. Commanding Officers shall have the overall responsibility for maintaining a high degree of calibration readiness for all TMDE.
- b. AIMD Officers shall:
 - (1) Be the shipboard METCAL program manager.
 - (2) Be the consolidated FCA manager.
 - (3) Provide calibration, per the intervals and procedures of reference (g), except as noted in paragraph 9.7 of this chapter, where the CRL takes precedence for SISCAL instrumentation calibration intervals and procedures. Provide repair services for all qualifying shipboard TMDE per reference (j).
 - (4) Maintain custody of, and be accountable for, all shipboard standards for calibration of TMDE.
 - (5) Use MEASURE to plan, schedule, monitor and document the calibration of all TMDE per reference (k).
 - (6) Staff the shipboard FCA with qualified calibration technicians and provide training to maintain their proficiency.
 - (7) Ensure all approved calibration standards are available to support the authorized workload.
 - (8) Ensure all documentation required to support calibration is current and available to personnel operating the FCA.
 - (9) Produce appropriate documentation or document the repair requirement and record repair accomplishment into MEASURE and the aviation Maintenance and Material Management system.
 - (10) Calibrate all TMDE within the capability of the onboard FCA. Calibration standards have first priority for calibration, with all other priorities based on mission requirements determined in coordination with affected department heads.
 - (11) Schedule required calibration and repair requirements beyond the capability of the shipboard FCA to another calibration laboratory. Calibration of NAVAIR Standards and Support Equipment beyond the capability of the FCA shall be authorized and scheduled in accordance with reference (b).
 - (12) Coordinate the calibration of TMDE that is beyond FCA capability with external resources based on accessibility and cost effectiveness. Five general categories of external resources are available to the FCA. The resources, in order of precedence to be used, are:

- (a) Ashore AIMDs and RCCs.
 - (b) System Command sponsored Navy Calibration Laboratories.
 - (c) Navy depot level activities.
 - (d) Other Department of Defense calibration laboratories approved for use by TYCOM.
 - (e) Navy Certified commercial calibration laboratories.
- (13) Coordinate all TMDE repairs with outside resources. The precedence (based on cost effectiveness) for selecting the outside resource for repairs is:
- (a) AIMD and RCC.
 - (b) COMNAVAIRSYSCOM Depot Level Rework Program for Support Equipment and Items (Individual Material Readiness List).
 - (c) Naval shipyards and ship repair facilities.
 - (d) Designated Overhaul Points listed in the Master Repairable Item List.
 - (e) Naval Systems Command field activities.
 - (f) Navy Certified commercial repair facilities.

NOTE: REPAIR OF NAVAIR STANDARDS AND SUPPORT EQUIPMENT BEYOND THE CAPABILITY OF THE FCA SHALL BE AUTHORIZED AND SCHEDULED IN ACCORDANCE WITH REFERENCE (b).

- (14) Submit only operational TMDE for off-ship calibration. All functions and ranges to be calibrated must be operating and usable unless special calibration is requested. Verify all necessary accessories, power cords, and technical manuals, as required to complete the calibration, are included with the instruments at the time of calibration.
 - (15) Request TYCOM authorization (COMNAVAIRFORCE) for repair of NAVAIR assigned calibration standards per the NAVAIR METCAL Scheduling Letter, NAVAIR Ltr 13640 Ser 3.9.2/series. Contact information for COMNAVAIRFORCE:
 Phone - Commercial (757) 445-4434, DSN 565-4434
Fax - Commercial (757) 444-1690, DSN 564-1690
Message - COMNAVAIRFORCE SAN DIEGO CA//N421Q/N421QC//
 - (16) Coordinate with Commander, Regional Support Center METCAL manager for SISCAL scheduling. AIMD is authorized to calibrate all instrumentation within the capability of the FCA except instruments requiring SCPs per the CRL. SCPs will be performed by SISCAL teams. Ensure SISCAL instrumentation is calibrated at the periodicity with the procedure listed in the CRL.
 - (17) Ensure the FCA provides support under the Strike Force Intermediate Maintenance Activity concept.
- c. Engineer Officers shall:
- (1) Report all TMDE which require calibration to the AIMD Officer for inclusion in the ship's calibration recall schedule upon request.
 - (2) Deliver portable TMDE for calibration to the FCA per the AIMD managed calibration recall schedule.
 - (3) Coordinate in-place calibration requirements for non-portable TMDE with the AIMD Officer.
 - (4) Ensure only operational TMDE are submitted for calibration. All functions and ranges to be calibrated must be operating and usable unless special calibration is requested. Verify all necessary accessories, power cords, and technical manuals, as required to complete the calibration, are included with the instruments at the time of submission.

- (5) Notify the AIMD Officer and, when applicable, the Combat Systems Officer, of any TMDE inventory changes, TMDE configuration changes, CRL changes that may affect the calibration recall schedule or require additional calibration procedures or standards.
 - (6) Maintain the allowance quantities of authorized TMDE.
 - (7) Report the inventory and configuration of all TMDE supporting HM&E systems and combat support systems using the SCLISIS.
 - (8) Maintain a ship specific CRL or Critical Instruments List for ship HM&E systems and combat support systems.
 - (9) Submit all TMDE repair requirements to the AIMD Officer. A formal repair request, such as a Visual Information Display System/Maintenance Action Form (VIDS/MAF) or an OPNAV 4790/2K, is not required for repair by the shipboard FCA. MEASURE METER cards will be provided by the ship's calibration laboratory.
- d. Air Officers shall:
- (1) Report all TMDE eligible for calibration to the AIMD Officer for inclusion in the ship's calibration recall schedule.
 - (2) Deliver portable TMDE for calibration to the FCA per the AIMD managed calibration recall schedule.
 - (3) Ensure only operational TMDE are submitted for calibration. All functions and ranges to be calibrated must be operating and usable unless special calibration is requested. Verify all necessary accessories, power cords, and technical manuals, as required to complete the calibration, are included with the instruments at the time of submission.
 - (4) Coordinate in-place calibration requirements for non-portable TMDE with the AIMD Officer.
 - (5) Notify the AIMD Officer and, when applicable, the Combat Systems Officer, of any TMDE inventory changes, TMDE configuration changes that may affect the calibration recall schedule, in-place calibration requirements or require additional calibration procedures or calibration standards.
 - (6) Maintain the allowance quantities of authorized TMDE.
 - (7) Submit all TMDE repair requirements to the AIMD Officer. A formal repair request, such as a VIDS/MAF or an OPNAV 4790/2K, is not required for repair by the shipboard FCA. MEASURE meter cards will be provided by the ship's calibration laboratory.
- e. Combat Systems Officers shall:
- (1) Report all portable and installed GPETE or SPETE eligible for calibration to the AIMD Officer for inclusion in the ship's calibration recall schedule.
 - (2) Deliver portable TMDE for calibration to the FCA per the AIMD managed calibration recall schedule.
 - (3) Ensure only operational TMDE are submitted for calibration. All functions and ranges to be calibrated must be operating and usable unless special calibration is requested. Verify all necessary accessories, power cords, and technical manuals, as required to complete the calibration, are included with the instruments at the time of submission.
 - (4) Notify the AIMD Officer of any TMDE inventory changes, TMDE configuration changes that may affect the calibration recall schedule or require for additional calibration procedures or calibration standards.
 - (5) Maintain GPETE/SPETE inventories in quantities allowed in the SPETERL. Include funding procurement of TMDE when assets are not available through CTRA programs.
 - (6) Report the inventory and configuration of all TMDE supporting combat systems using SCLISIS.

- (7) Submit all TMDE repair requirements to the AIMD Officer. A formal repair request, such as VIDS/MAF or an OPNAV 4790/2K, is not required for repair by the shipboard FCA.

9.9 NUCLEAR PROPULSION CALIBRATION REQUIREMENTS. Nuclear propulsion plant gages, meters, thermometers and other instruments in those reactor plant systems specified by reference (p) must be calibrated in accordance with the requirements of the applicable Reactor Plant Manual. Other nuclear-powered ship's system calibration must be performed per the requirements of reference (a).

(This Page Intentionally Left Blank)

VOLUME VI
CHAPTER 10
MOTOR GASOLINE HANDLING AND STORAGE

REFERENCES.

- (a) NAVSEA S9086-SP-STM-010 - NSTM Chapter 542 (Gasoline and JP-5 Fuel Systems)
- (b) COMNAVAIRLANT/COMNAVAIRPACINST 3400.4 - Air Department Standard Operating Procedures
- (c) NAVSEA S9086-WK-STM-010-NSTM - Chapter 670 (Stowage, Handling and Disposal of Hazardous General Use Consumables)
- (d) OPNAVINST 5100.19 - Navy Occupational Safety and Health (NAVOSH) Program Manual for Forces Afloat
- (e) LPD 17 MOGAS System Technical Manual
- (f) CNSFINST 4020.1 - Motor Gasoline (MOGAS) Certification Program for L-Class Ships

10.1 **PURPOSE.** To provide guidance and safety requirements for the storage, handling and loading of Motor Gasoline (MOGAS) aboard ship.

10.1.1 **Discussion.** In view of the special hazards involved in the handling of MOGAS, Commanding Officers must ensure strict compliance with all MOGAS handling safety instructions, Cargo Fuel Operational Sequencing System (CFOSS) (as applicable), references (a) through (f) and this chapter. The Commanding Officer's approval shall be obtained prior to any MOGAS operation. The Aviation Fuels Officer, or other officer as may be directed by the Commanding Officer, shall be directly responsible for the planning of all MOGAS operations (i.e., loading, off-loading or transfer of gasoline, etc.), and the operation of the MOGAS system, including the training of all MOGAS operation and handling personnel. Any deviation from the safety precautions and procedures of reference (a) or this chapter shall have the approval of the appropriate Type Commander. Additionally, the Commanding Officer may specify any additional safety precautions to be taken as the situation dictates.

10.2 **CHARACTERISTICS.**

- a. Gasoline is a highly volatile liquid that gives off vapors under all environmental conditions. This vapor, when combined with air in the proper proportion (approximately 1.4 to 7.6 percent by volume), forms an explosive mixture that can be set off by any ignition source such as a slight spark or flame. If liquid gasoline is present, the violent explosion will be followed by fire.
- b. Air, at ordinary atmospheric temperature, can absorb as much as 28 percent gasoline vapor. Gasoline vapors are three to five times heavier than air, and when released, will tend to sink to the lowest level of a compartment. Liquid gasoline will expand 0.7 percent for each ten degree increase in temperature.

10.3 **PERSONNEL HAZARDS.** Gasoline and gasoline vapors are extremely toxic; breathing air that is rich in gasoline vapor can and has caused unconsciousness and in some cases death. Gasoline vapors, even in concentrations of less than 1.0 percent, may cause nausea and headaches if inhaled for any length of time. Strong concentrations of gasoline vapors produce an excited state leading to unconsciousness. Gasoline saturated clothing will cause irritation and severe burns to the skin and will ignite if exposed to a source of ignition. Gasoline splashed in the eyes can cause blindness. Severe physical and mental complications may result from inhalation or body absorption. Ship's personnel shall be instructed in the characteristics of MOGAS and the necessary precautions to prevent personnel injury by exposure to MOGAS or its vapor.

10.4 **STORAGE AND HANDLING.**

10.4.1 **Tank Conditions.** Ships with installed MOGAS tanks/systems will maintain them in one of the following conditions at all times.

- a. Tank is empty and gas free certified.
- b. Tank is filled with water (Cofferdam may or may not be inert).

- c. Tank is filled with gasoline and water (Cofferdam must be inert).
- d. Gasoline has been pumped off and the tank is full of water with trace amounts of gasoline. The Cofferdam will remain inert until the tank has been flushed three times in accordance with the CFOSS and has been turned over to an industrial activity or contractor. In no case will the tank be emptied until the industrial activity or contractor is ready to gas free the tank.

10.4.2 Loading and Off-loading.

- a. Before transferring MOGAS, the planning phase must include:
 - (1) Time the operation will start and its expected duration.
 - (2) CFOSS training of all involved personnel for their respective watch stations. All involved personnel must be Personnel Qualification Standard qualified for their assigned operating stations. A CFOSS talk-through and walk-through must be completed prior to commencing any MOGAS evolution.
 - (3) Stationing of special fire fighting personnel and their equipment, as required by the CFOSS, plus any additional requirements mandated by the Commanding Officer.
 - (4) Control of the smoking lamp.
 - (5) Setting of material condition "YOKE".
 - (6) Use of non-ferrous (spark-proof) tools.
- b. Loading and off-loading of MOGAS to or from the installed ship's system shall be conducted pier-side. Since the MOGAS tanks overflow directly overboard, any single tank shall normally never be filled above 80 percent capacity. Operational necessity, as dictated by the appropriate Type Commander, may require the tank to be filled to 95 percent. During this time, additional precautions must be taken as follows:
 - (1) MOGAS pumping shall be reduced to the minimum rate.
 - (2) Posting of additional overboard discharge watches.
 - (3) Loading only that amount of gasoline that has been calculated to fill the tank to 95 percent.
- c. Most MOGAS inventory requirements are controlled by the Fleet Marine Force. They will make necessary arrangements for the delivery and/or pickup of the MOGAS. The ship will be responsible for requesting, by message, an on-load/off-load date and time, and an alternate date and time, for the evolution to commence. This message information will be provided to the local Naval Base Commander and Base Fire Marshal.
- d. The Base Fire Marshal shall ensure that all fire fighting equipment is in position, rigged and properly manned. Additionally, the Base Fire Marshal shall ensure that all MOGAS connections are tight, and that no leaks are apparent when the pumps are started.
- e. Constant communication shall be maintained between all operating stations throughout the evolution.
- f. The Ship's Fire Marshal will ensure that fire fighting equipment is rigged and manned in accordance with the CFOSS and ship's regulations.
- g. Sample MOGAS per the requirements identified in paragraph 10.4.3.b below.

10.4.3 Identification and Sampling Requirements.

- a. Only unleaded gasoline is used aboard naval ships with installed gasoline tanks. MOGAS color can range from light red to a straw color.
- b. MOGAS samples shall be taken for laboratory analysis during on-load evolutions at the following times; just prior to starting the evolution, at approximately the mid point, and just prior to completion. During off-load, laboratory samples need only be taken just prior to commencing the off-load evolution. Gasoline samples must be clearly marked and handled with extreme care.

10.4.4 Safe Handling of Motor Gasoline.

- a. Maintain all portable and installed fire fighting equipment and alarm systems in proper operational condition.
- b. Maintain all grounding cables in proper operational condition.
- c. Conduct frequent inspections to ensure system integrity and tightness.
- d. Hold frequent fire fighting drills, with particular emphasis on the MOGAS system and storage tanks.
- e. Immediately clean up any spilled or leaked gasoline and dispose of any rags or other cleanup material in accordance with ship's instructions.
- f. Gasoline shall not to be used for cleaning purposes under any circumstances.
- g. When the MOGAS system is in use, maintain a security watch in accordance with the requirements of the CFOSS. When the system is secured, the aviation fuels watch shall inspect the MOGAS system to ensure that there are no leaks, and that the inert readings and pressures are satisfactory.

10.4.5 Containerized Motor Gasoline. Gasoline in drums, bladders or cans shall be located on the weather deck only, and stored so that the containers can be readily jettisoned as described in reference (a).

10.4.6 LPD 17 Class MOGAS System.

10.4.6.1 Storage and Handling. The LPD 17 Class MOGAS System has the capability of storing MOGAS containers up to 1500 gallons (combination of 18 and 6 gallon bladders, 55 gallon drums and 5 gallon cans), in the MOGAS Service and Bladder Storeroom (Compartment Number 4-145-4-G) and three 500 gallon bladders (bulk fuel) on a jettison rack, for a total of 3000 gallons. The passageway (Compartment Number 4-143-2-L) adjacent to the MOGAS Ready Service and Bladder Storeroom was modified to support MOGAS transfer from 55 gallon drums to portable containers, or between containers.

10.4.6.2 Firefighting and Safety Requirements. The LPD 17 Class ships are designed to store MOGAS fuel containers inside the MOGAS Ready Service and Bladder Storeroom. The MOGAS storeroom and transfer room firefighting and safety systems have been installed, satisfactorily tested and validated to satisfy all required NAVSEA Safety and Firefighting requirements, to include:

- a. Eductor Sweep hose for dedicated drainage.
- b. Standard Navy Gasoline Spill Clean-up Kit.
- c. AFFF Fire Protection System.
- d. HFP System.
- e. Smoke and Heat Detection System.
- f. Explosion proof electrical equipment (storeroom only).
- g. Any electrical equipment (including switches and power outlets) in the transfer room that were not explosion proof or intrinsically safe were relocated to be at least 48 inches above the deck.
- h. Dedicated Ventilation System.
- i. Vapor Detection System.

10.5 MOTOR GASOLINE ASSESSMENT PROGRAM.

- a. The MOGAS Assessment Program has been established to assist Ship's Force personnel in the operation and maintenance of the installed MOGAS systems. This program requires an assessment to be conducted on each MOGAS equipped ship; annually, prior to on-load or off-load of MOGAS evolutions, and prior to an industrial or fleet maintenance availability.
- b. The MOGAS Assessment Program shall be conducted by the ISIC, and will consist of the following elements:

- (1) Conducting required assessments, and providing assessment reports to the appropriate Type Commander and Fleet Commander.
 - (2) Taking corrective action on minor discrepancies and providing guidance for repairs of major discrepancies.
 - (3) Providing On the Job Training for operators and maintenance personnel, as requested.
 - (4) Reviewing and validating the Coordinated Shipboard Allowance List, CFOSS, Planned Maintenance System, Personnel Qualification Standard and the associated technical manuals.
 - (5) Providing assistance during MOGAS on-load or off-load evolutions, as requested.
 - (6) Performing assist visits when requested by the ship.
- c. LPD 17 Class MOGAS Assessment and Certification should be conducted in accordance with reference (f).

VOLUME VI

CHAPTER 11

**MAINTENANCE, REPAIR AND OVERHAUL OF
SERVICE CRAFT, LANDING CRAFT AND SMALL BOATS**

REFERENCES.

- (a) OPNAVINST 4780.6 - Policy for Administering Service Craft and Boats in the U.S. Navy
- (b) OPNAVNOTE 4780 - Service Craft and Boats Accounting Report (SABAR)
- (c) NAVSEA S9086-TX-STM-010 - NSTM Chapter 583 (Boats and Small Craft)
- (d) NWP 1-03.1 - Naval Warfare Publications Operational Report
- (e) NAVSEA S9086-HB-STM-010 - NSTM Chapter 233 (Diesel Engines)

11.1 PURPOSE. To provide guidance and assign responsibilities for the maintenance and repair of service craft, landing craft and small boats.

11.1.1 Policy.

- a. Personnel assigned to individual ships, service craft or responsible shore based activities shall perform all landing craft, service craft and boat maintenance within their capabilities.
- b. Landing craft, small boats and service craft shall be maintained with the same care that naval ships receive. This is particularly true for boats which also serve as ready lifeboats.
- c. (Submarine Force only) If there is no Unit Identification Code (UIC) assigned to the craft, the parent command's UIC and a unique Work Center will be used for Current Ship's Maintenance Project control and any related OPNAV 4790/2K (see Chapter 19, Appendix E of this volume).

11.2 MATERIAL READINESS.

- a. Regular periodic inspections of landing craft, small boats and service craft shall be conducted by the command to which the craft is assigned (referred to hereafter as the "parent command"). Use Fleet Maintenance Activity (FMA) facilities to conduct the required periodic inspections, whenever possible. The results of these inspections will determine the need for repairing a craft or boat. Submit overhaul and major maintenance items (i.e., engine overhauls and hull repairs beyond the ability of the parent command) to the appropriate Type Commander (TYCOM), no later than 15 January for the current and following two years. The requests for maintenance must cite the boat or craft hull number and the fiscal year quarter in which the overhaul or major maintenance availability is desired. Any significant changes to previously submitted maintenance requests must be discussed in detail (i.e., material condition of the craft affected by the change, operational commitments requiring changes, etc.).
- b. To conserve repair funds and assets, and to maintain craft and boats in a satisfactory state of material readiness, Commanding Officers of ships and shore activities shall set up a training program for all personnel connected with the operation and maintenance of craft and boats. Pride of ownership should be instilled in boat crews and assigned unit personnel. Use available personnel and funds to the fullest extent possible before requesting help from the FMA to perform routine or emergent repairs.
- c. Active service craft are inspected by the Service Craft Material Inspection Board, per reference (a), to support industrial availability planning. Deficiencies identified by the Service Craft Material Inspection Board must be entered in the Current Ship's Maintenance Project prior to the Work Definition Conference. Service craft parent commands shall ensure reference (b) accurately reflects the current status of requested availabilities.
- d. TYCOMs will aid parent commands with landing craft, small boat and service craft industrial availabilities by:
 - (1) Scheduling availabilities.

- (2) Establishing overhaul cycles including, budgeting, scheduling, and funding per the requirements of reference (b).

11.3 MAINTENANCE OF LANDING CRAFT AND SMALL BOATS ASSIGNED TO AFLOAT UNITS.

- a. Commanding Officers are urged to take full advantage of the FMA facilities for Ship's Force upkeep and repair of their landing craft and boats. A limited quantity of hand and power tools and air compressors are available at the FMA for Ship's Force use. Ships may borrow these tools by sending a properly prepared work request (OPNAV 4790/2K) directly to the FMA/Regional Support Group (RSG)/Regional Maintenance Center (RMC). Depending on the workload, assist teams from the FMA/RSG/RMC may be available to assist with the inspection of boats and craft. COMNAVSURFLANT and COMNAVSURFPAC ships and units shall obtain tools from the FMA per the requirements of Chapter 30 of this volume.
- b. Ship personnel desiring to make use of FMA/RSG/RMC facilities should send a work request (OPNAV 4790/2K) to the FMA/RSG/RMC requesting crane services to handle the craft or boat and stowage space for accomplishing the work. Limited repair material not normally available on board ship, may be obtained from the FMA/RSG/RMC by including required items in the work request.
- c. If long usage or extensive damage to any boat or landing craft is such that repairs by Ship's Force cannot keep a boat or craft in a proper state of readiness, a work request (OPNAV 4790/2K) must be submitted to the FMA/RSG/RMC via the TYCOM or Immediate Superior In Command (if assigned). The work request must show the following additional information in Section IV of the OPNAV 4790/2K:
 - (1) Boat or landing craft registry number.
 - (2) Complete description of the work requested.
- d. The FMA/RSG/RMC will accept such requests, provided that:
 - (1) The ship is not scheduled for a routine Chief of Naval Operations (CNO) Maintenance Availability in the immediate future.
 - (2) The repairs are beyond the capacity and/or capability of Ship's Force to accomplish.
 - (3) Enough time in advance of the ship's next scheduled operation is allowed for the FMA to perform the repairs and return the boat or landing craft to the ship before departure.
- e. When a boat or landing craft is badly damaged, a statement of the circumstances surrounding the damage must be submitted with the request for repairs.
- f. Before delivery of a boat or landing craft to the FMA for repairs, Ship's Force must accomplish the following:
 - (1) Remove all items of outfitting and all portable parts invoiced with the hull, including compass, tools, batteries, and portable lights.
 - (2) Drain and clean the bilges of dirt, diesel fuel, and oil. When it is not possible to deliver the boat or landing craft in the above condition, the repair activity will be notified in advance so that arrangements can be made for gas free inspections.
- g. Reference (c) provides details for transfer, receipt, disposal and survey of boats and landing craft. Replacement boats or landing craft are normally available from Naval Sea Systems Command (NAVSEA), via the TYCOM, upon receipt of a valid Boat Inspection Report per reference (c).
- h. If the FMA cannot accomplish the requested boat or landing craft repairs, the Commanding Officer of the FMA will advise the ship to request an availability from the TYCOM.

11.3.1 Landing Craft and Small Boat Repairs During Chief Of Naval Operations Maintenance Availability.

- a. Hull repairs affecting strength and watertight integrity beyond the capability of Ship's Force are considered urgent items. Ship's Force shall ensure that the required repairs are included in the work package for screening at the Work Definition Conference.

- b. Boats and landing craft which do not require work by an industrial activity should normally accompany the ship during the availability. Stowage areas can usually be made available at the industrial facility for accomplishment of Ship's Force work. Commanding Officers should not overlook the facilities available at FMAs for accomplishment of this work while the ship is undergoing a CNO Maintenance Availability.
- c. Tests of landing craft and boat lifting gear shall be accomplished during the ship's CNO Maintenance Availability in accordance with reference (c) and Volume IV, Chapter 13 of this manual.

11.4 MAINTENANCE OF SERVICE CRAFT, LANDING CRAFT AND SMALL BOATS ASSIGNED TO SHORE ACTIVITIES, GROUP AND SQUADRON COMMANDERS.

11.4.1 Unit Level Maintenance.

- a. Maintenance and repair of craft and boats within the capability of the parent command should be budgeted, scheduled, and accomplished to maintain a high state of material readiness. Commands and activities shall appoint a Maintenance Officer as a sole point of contact for all matters relating to boat and craft maintenance. The Maintenance Officer shall be capable of making maintenance decisions based on engineering and operational parameters and should actively participate in the planning and execution of all maintenance actions affecting the parent command.
- b. Annual budget proposals submitted by the parent commands to their TYCOM shall address anticipated funding requirements to maintain the material condition of all assigned boats and craft, the accomplishment of approved modifications and modernization work (within the parent command's capability), and must discuss in detail how these funds will be applied to specific craft or boats.
- c. Request for changes to boat or craft inventories, resulting from mission requirement changes, must be assessed in terms of maintenance capabilities and budget constraints. Approval of such changes may require the TYCOM to adjust the units Operating Target allocation for maintenance. The impact on maintenance support for changes in inventory must be assessed for each unit by the TYCOM before instituting changes.

11.4.2 Fleet Maintenance Activity Level/Contractor Assist Maintenance.

- a. Repairs to craft and boats which are beyond the capabilities of the parent command, shall be documented on work requests (OPNAV 4790/2K) and submitted to the cognizant FMA/RSG/RMC for accomplishment. Repair funds for craft and boats are budgeted for FMA activities, on a quarterly basis, by the TYCOM. Individual craft and boat work packages will be screened by the TYCOM to ensure accomplishment within allocated funding.
- b. Work requests which are screened as beyond the capability of the FMA will be submitted to the TYCOM for screening to an industrial activity. Industrial repairs are normally programmed for accomplishment during scheduled craft or boat overhauls or other availabilities, unless the repairs are of an emergent nature and have been documented with a Casualty Report in accordance with reference (d). FMAs/RSGs/RMCs will accept emergent work requests, to clear Casualty Reports, on a case basis with TYCOM approval.
- c. Shore based commands which have craft or boat repairs being accomplished by industrial activities retain the responsibility for these repairs. The parent command is responsible for maintaining liaison with the industrial activity and keeping the TYCOM informed, via the RSG/RMC/Immediate Superior In Command, of problems or potential problems.

11.4.3 Overhaul of Service/Landing Craft and Small Boats.

- a. A four to five year overhaul cycle has been established by the CNO for self-propelled service craft, high value boats and landing craft (e.g., SLWTs, service craft and LCUs). For other craft and boats, the necessity for overhaul is determined by usage and material condition and will generally be conducted every four to five years or as required by reference (a).

- b. Service/landing craft and boats undergo CNO Maintenance Availabilities to accomplish major maintenance and modernization items which, in the judgment of the TYCOM, are beyond the unit or FMA capability. All high value boats, landing craft and service craft receive complete and thorough availabilities within the available funding. The primary goal is to accomplish all outstanding repairs and major maintenance items to ensure reliable operations during the craft's projected operational cycle.
- c. There are basically two distinct types of availabilities applicable to boats and service/landing craft:
 - (1) Supervisor of Shipbuilding administered industrial availabilities using a work package consisting of OPNAV 4790/2Ks.
 - (2) CNO Maintenance Availabilities administered through the Naval Supply Center (contracting agency) by the FMA/RSG/RMC for smaller craft/boats with less extensive maintenance and repair packages.
- d. After the Work Definition Conference, and before the contracting authority (Supervisor of Shipbuilding/Naval Supply Center) issues the Invitation for Bids to potential bidders, the TYCOM and parent command will review the copies of the bid specifications for accuracy and completeness. The parent command must complete the review quickly and report any discrepancies to the TYCOM. The TYCOM will resolve any discrepancies in the bid specifications with the contracting authority before the Invitation for Bids is released.
- e. Post-repair trials for craft and boats are conducted, as applicable, per Volume II, Part I, Chapter 3 of this manual.

11.5 RESPONSIBILITIES. For both types of industrial availabilities identified in paragraph 11.4.3.c of this chapter the following responsibilities are assigned:

11.5.1 Type Commander.

- a. Coordinate all aspects of the advance planning.
- b. Authorize all new industrial work items.
- c. Authorize all growth in an existing industrial work item.
- d. Provide funding to accomplish all authorized work.
- e. Monitor and approve all changes in established milestones (internal milestones, used by the industrial activity to monitor schedule progress, are not subject to TYCOM approval).
- f. Direct appropriate action when the quality or completeness of the industrial activity work is in question.

11.5.2 Immediate Superior In Command. (if not assigned, these functions will revert to the TYCOM)

- a. Review overhaul progress reports.
- b. Review Ship's Force and FMA concurrent work.
- c. Ensure pertinent directives are followed concerning the safety of personnel and equipment.
- d. Attend sea trial and overhaul completion review conferences.
- e. Assist in all aspects of the planning and monitoring of industrial availabilities.

11.5.3 Commanding Officers of Parent Commands.

- a. Coordinate all planning aspects of craft and/or boat overhauls with the TYCOM and Immediate Superior In Command (where assigned).
- b. Prepare and submit overhaul progress reports in accordance with Volume II, Part I, Chapter 3 of this manual.
- c. Ensure enough trained personnel are assigned to on-site monitoring of craft or boats while in an industrial availability.
- d. Fulfill all responsibilities for safety of craft and personnel.

11.6 REPAIR AND OVERHAUL OF SMALL BOAT ENGINES.

- a. Boat and craft custodians shall repair and maintain engines on a continuing basis, using their Operating Target. Replacement parts shall be obtained through the Navy Stock system, when available, to prevent the potential for using erroneous parts and to simplify stocking of parts.
- b. Craft and boat engine overhaul intervals are determined by engine operating hours as specified in reference (e) and/or, for engines over 400 Brake Horsepower, by trend analysis.
- c. Boat Alterations are issued for the replacement of engines no longer supported by the supply system. Direct questions concerning the status of obsolete engines to NAVSEA (PMS 325) or the TYCOM.
- d. All spare boat engines, or engines being turned in for replacement, must be preserved in accordance with reference (e) and stored in an enclosed protective compartment.

11.6.1 Boat Alterations.

- a. Submit Boat Alteration requests to NAVSEA, (PMS 325) via the chain of command.
- b. The accomplishment and funding of approved Boat Alteration shall be managed by the TYCOM.

11.7 OPERATION OF SMALL BOAT ENGINES. The operation and maintenance of all diesel engines on boats and craft shall be in accordance with reference (e).

(This Page Intentionally Left Blank)

VOLUME VI
CHAPTER 12
DEGAUSSING

REFERENCES.

- (a) OPNAVINST S8950.2 - Magnetic Silencing
- (b) NAVSEA S9086-QN-STM-010 - NSTM Chapter 475 (Magnetic Silencing)
- (c) NAVSEA S9475-AC-PRO-010 - Degaussing Forms, Records and Reporting Procedures
- (d) NAVSEA S5475-AL-PRO-010 - Principles and Procedures for Magnetic Treatment of Ships
- (e) SSPINST 8950.2 - Procedure for Fleet Ballistic Missile (FBM)/Strategic Weapons System (SWS) Components During Flash-Deperm Treatment of an SSBN

12.1 **PURPOSE.** To provide magnetic silencing and deperming requirements, and the check ranging and reporting procedures defined by reference (a). Reference (b) provides the basic principles and background of degaussing.

12.2 **DEGAUSSING DEFINITIONS.**

12.2.1 **Deperming.** Deperming is the magnetic treatment of a ship's hull to minimize permanent magnetism and is also performed to place the ship's permanent magnetization into a standard condition such that it is approximately the same as the other ships in the class. All newly constructed ships require deperming. The deperming needs of operational ships are established by check ranging.

12.2.2 **Installed Degaussing System.** A shipboard system which reduces the residual permanent and induced magnetic signature of the ship, and is the ship's primary passive mine countermeasure system. Different combinations of degaussing coils, type of controls and power supplies help to identify a degaussing system.

12.2.3 **Magnetic Compass Compensation.** Magnetic field from a ship's degaussing system can interfere with a ship's magnetic compass heading and make the system useless for navigation. Per reference (b), a compensating coil is set up around the magnetic compass to neutralize the effect of degaussing coil field in the vicinity of the compass. Magnetic compasses that use fluxgate technology have a degaussing compensation system that does not rely on compensation coils.

12.2.4 **Check Ranging.** The action of a ship making reciprocal range runs over an instrumented array, at a Magnetic Silencing Facility (MSF), for purposes of measuring the ship's degaussed magnetic signature. Check ranging is the principle method of determining the effectiveness and reliability of installed degaussing systems. A satisfactory check range is two range runs on reciprocal headings within a six week period which are determined to be magnetically satisfactory while ship's degaussing equipment is operating properly. Underwater Electromagnetic Measurement Systems for check ranging are available at the following locations:

San Diego, CA	Norfolk, VA
Pearl Harbor, HI	Mayport, FL
Yokosuka, Japan	New London, CT
Kings Bay, GA	

12.2.5 **Degaussing Folder.** The Degaussing Folder (NAVSEA 8950/1) is an official ship log. It contains instructions for operation of the degaussing system, degaussing charts, values for current and turn settings, installation forms, compass compensation forms, and a log section showing all pertinent details of magnetic treatment and of action taken on the ship's degaussing system for the information of degaussing authorities. The degaussing folder is issued to a ship by the MSF that renders the initial magnetic treatment and system calibration. Reference (c) provides the detailed requirements for maintaining the degaussing folder.

12.3 **SHIPS AND SUBMARINES WITH INSTALLED DEGAUSSING SYSTEMS.**

- a. Reference (a) mandates check ranging for ships. To meet minimum requirements, a satisfactory check range is required every six or twelve months depending on the type of system installed. Requirements for the check ranging of ships are as follows:

- (1) After new construction.
 - (2) Before and after a major dry-docking availability.
 - (3) After a major shock to the hull from a nearby explosion.
 - (4) After grounding or collision.
 - (5) As feasible, before entering mined waters.
 - (6) Before issuing a Casualty Corrected of any Casualty Report degaussing equipment.
 - (7) At every opportunity, when entering or leaving a port with ranging facilities. **Declining use of range facilities is not an option.**
 - (8) After a major alteration to the hull and superstructure.
- b. When ranging facilities are not available in the home port, ships will satisfactorily check range annually.
- (1) Ships forward deployed to areas without ranging facilities are exempted from check range requirements by reference (a).
 - (2) Surface ships not equipped with an installed degaussing system are not required to check range (except LCS 2 class).
- c. A ship which receives notification from an MSF of unsatisfactory magnetic condition and the reason for unsatisfactory signature is a degaussing equipment failure, the ship is required by reference (a) to report via Casualty Report as directed by Chapter 5 of this volume.
- d. Installed degaussing systems will be operated at all times while underway.

12.3.1 Check Ranging.

- a. Before check ranging, contact the range facility by voice radio. Range crossings will be considered invalid unless the range is clear of other traffic (including tugboats) before crossing.
- b. Ranging facility requires the following information:
 - (1) Coil Settings. Once the ship is on course, and before the ship crosses the range, inform the facility of actual ammeter currents and polarities. Ensure the meter readings are correct for both zone and polarity. Actual coil currents in effect during the crossing **MUST** be recorded and reported to the MSF for satisfactory check ranging.
 - (2) Ships with Advanced Degaussing systems. Due to the large number of coil currents required to be reported, ships with these systems must make arrangements with the MSF to deliver this information by facsimile or other electronic methods after the crossing occurs.
 - (3) Ship's Draft. Forward and aft drafts. Provide actual keel drafts, vice navigational drafts.
 - (4) Ship's heading. If more than five degrees off channel course, provide the range with the actual ship's heading. Once the course is established, maintain a steady course and constant speed between 8 to 10 knots, or as the range operator directs.

12.3.2 Responsibilities.

12.3.2.1 Type Commander/Immediate Superior In Command.

- a. Monitor the degaussing readiness of assigned ships.
- b. Ensure that ships "check range" as required by paragraph 12.3 of this chapter.
- c. Issue waivers to check ranging and deperming requirements if necessary. The Technical Warrant Holder (NAVSEA 05P1) may be contacted if advice on impact to ship susceptibility is needed.

12.3.2.2 Ship Commanding Officer.

- a. Maintain ship's installed degaussing system. Ensure ship's magnetic signature is minimized by periodic check ranging.
 - (1) Ships unable to check range or unable to establish communications with the MSF shall make comments as appropriate in the remarks section of the daily Operational Reports.
 - (2) **Ships with installed systems may not decline check ranging.**
 - (3) Submit a minor Departure From Specification per Volume V, Part I, Chapter 8 of this manual if range checking requirements of paragraph 12.3 of this chapter are not met.
- b. Maintain ship's Degaussing Folder.

12.4 **SUBMARINES WITHOUT INSTALLED DEGAUSSING SYSTEMS.** The submarine force shall maintain all units in the best degaussed condition within expected areas of operation. Expected areas of operation include zones .22, .33, .44, and .55 as shown in reference (d). Operations in zone .55 will necessitate additional treatment, since presently used flashing procedures are designed to provide protection only in zones .22, .33, and .44. Normally, ships are automatically ranged by degaussing facilities as they transit channels between the hours of 0800-1600 weekdays only. Weekend ranging can be arranged with the MSF on a case basis. Reference (a) mandates check ranging for ships. To meet minimum requirements, a satisfactory check range is required annually during peacetime or semi-annually during war time. Other requirements for check ranging of ships are as follows:

- a. Before and after Post Shakedown Availability (following new construction).
- b. After a CNO Maintenance Availability.
- c. After a major shock to the hull from a nearby explosion.
- d. After grounding or collision.

NOTE: THE ABOVE ARE THE MINIMUM RANGING REQUIREMENTS. EVERY OPPORTUNITY FOR RANGING SHOULD BE USED TO ENSURE EARLY IDENTIFICATION AND CORRECTION OF MAGNETIC SILENCING DEFICIENCIES.

12.4.1 Responsibilities.

12.4.1.1 Type Commander/Immediate Superior In Command.

- a. Ensure that ships check range as required by paragraph 12.4 of this chapter.
- b. Issue waivers to check ranging and deperming requirements if necessary. The Technical Warrant Holder (NAVSEA 05P1) may be contacted if advice on impact to ship susceptibility is needed.
- c. Schedule ships with unsatisfactory magnetic signatures for flash deperming at the earliest opportunity.

12.4.1.2 Ship Commanding Officer.

- a. Ensure ship's magnetic signature is minimized by periodic check ranging.
- b. Inform the ISIC upon receipt of an unsatisfactory ranging.
- c. Maintain the ship's Degaussing Folder.
- d. Undergo flash deperming as directed by the ISIC or TYCOM.
- e. Before flash deperming prepare ship's equipment and off-load/protect material in accordance with references (b) and (e). Additional guidance can be obtained from the MSF.
- f. Submit a minor Departure From Specification per Volume V, Part I, Chapter 8 of this manual if range checking requirements of paragraph 12.4 of this chapter are not met.

(This Page Intentionally Left Blank)

VOLUME VI
CHAPTER 13
SURFACE SHIP CORROSION CONTROL

REFERENCES.

- (a) NAVSEA S9086-DA-STM-010 - NSTM 100, Hull Structures
- (b) NAVSEA S9086-VD-STM-010 - NSTM Chapter 631 (Preservation of Ships In-Service - General)
- (c) NAVSEA Technical Publication T-9630-AB-MMD-010/ALL USN HULLS - Corrosion Control Assessment and Maintenance Manual (CCAMM) for the Corrosion Control Information Management System (CCIMS)
- (d) COMNAVSURFOR Instruction 3120.1 - Zone Inspections
- (e) COMNAVAIRFORINST 4790.1 - Commander Naval Air Forces Surface Maintenance and Material Management (3-M) System Manual

LISTING OF APPENDICES.

- A Preservation Departures from Specifications Process Decision Tree

13.1 **PURPOSE.** To provide basic guidelines necessary to maintain an effective Corrosion Prevention and Control Program. Guidance for inspection, prevention and repair of corrosion on ships is contained in references (a), (b) and (c), which supersedes all previous class specific Corrosion Control Manuals distributed by Naval Sea Systems Command. In addition, this chapter requires the use of the Corrosion Control Information Management System (CCIMS) database as the repository for all inspection and maintenance data. The maintenance of coating integrity to prevent structural degradation is necessary to ensure the safe and proper operation of the ship. Maintenance of areas with severe corrosion require enhanced and targeted surveillance due to the highly corrosive conditions that can lead to higher risk of accelerated structural degradation. Reference (a) provides structural system survey and inspections criteria for surface ships and aircraft carriers. Reference (c) provides specific requirements for inspecting tanks and voids and provides condition based maintenance guidance for availability planning.

13.2 **BACKGROUND.** Protective coatings are the most widely used method of corrosion control and have specific applications. Therefore, the physical location and operating environment shall be taken into consideration when choosing a coating system. Through the application of improved corrosion prevention and control techniques, procedures, and materials, longer lasting and more effective results can be obtained with a reduction in man-hours spent on preservation. The Department of Defense "Annual Cost of Corrosion for Navy Ships" study identified corrosion control/preservation as a high cost driver for ship life cycle maintenance. In order to reduce this life cycle maintenance cost, an accurate database of coating conditions is required to facilitate timely and appropriate maintenance decisions. The failure to identify, track, and repair a preservation system deficiency can result in coating failure and can result in damage to the structure, substantially increase repair costs and adversely impact both the seaworthiness and combat worthiness of the hull. The CCIMS database was developed to document coating conditions to assist in maintenance planning. The CCIMS database is located at <https://ccims.dc3n.navy.mil> and can be accessed to record the results of tank, void and general structural inspections, coating systems installed, and all repairs conducted.

13.3 **POLICY.**

- a. All Level 1 and 2 corrosion control structural system surveys and inspections shall be accomplished in accordance with reference (a).
 - (1) Level I Structural System Surveys are defined as scheduled inspections per the Class Maintenance Plan specific to each ship class and are focused on ship structure and foundations.
 - (2) Condition-directed Level 2 structural inspections shall be conducted if warranted by deficiencies identified by a Level 1 survey. The Level 2 inspection shall include, but is not limited to, thickness gauging measurements and Non-Destructive Testing as applicable to the structural condition to allow for adequate assessment.

- b. The CCIMS database shall be used for documenting coating system inspections, maintenance and repairs.
- c. All inspectors and surveyors shall be qualified in accordance with reference (c) requirements.
- d. Whenever a tank or void is opened for manned entry, an inspection shall be performed. The inspection shall be performed in accordance with reference (c). All inspection results will be entered into the CCIMS database.
- e. For surface force ships and aircraft carriers, the CCIMS database will be used for ship maintenance availability planning.

NOTE: ANY OUT-OF-SPECIFICATION CONDITION FOUND IS TO BE MITIGATED IN ACCORDANCE WITH APPENDIX A OF THIS CHAPTER AND IN ACCORDANCE WITH VOLUME V, PART I, CHAPTER 8 OF THIS MANUAL.

13.4 RESPONSIBILITIES.

13.4.1 Type Commanders.

- a. Port Engineers and Maintenance Program Managers (MPM) schedule and screen corrosion control work items to the appropriate repair activities during industrial availabilities and upkeeps with sufficient length to accommodate the work.
- b. Port Engineers and MPMs screen tank, void and general structural inspection Automated Work Requests (AWR) in Availability Work Packages to the repair activities capable of performing the inspections including in-house Type Commander resources as applicable.
- c. When tasked by Port Engineers and MPMs, inspectors and surveyors assigned by Fleet Maintenance Activity/Regional Maintenance Center (RMC)/Type Commander will perform inspections using references (a) and (c). Inspector/surveyor will ensure all inspection data is entered into CCIMS database within three working days upon completion of inspection.
- d. (Aircraft Carriers only) Provide to Ship's Force:
 - (1) Self help information on corrosion control information.
 - (2) Technical assistance on setting up and updating a ship's Corrosion Prevention and Control Program.
 - (3) Coordinate and/or provide training in accordance with reference (c) for inspection personnel assigned by the Repair Officer (Ship's Corrosion Control Officer for Aircraft Carriers).

13.4.2 Fleet Maintenance Activity/Regional Maintenance Center.

- a. Maintain facilities and sufficient qualified personnel to apply protective coatings.
- b. Conduct Technical Assist Visits upon request from a ship during a fleet maintenance availability, or at other times as the workload permits, to include:
 - (1) Identification of shipboard topside corrosion problem areas.
 - (2) Recommendations for methods and means of corrosion problem correction.
 - (3) Informing Ship's Force of local industrial assets, including local Fleet Maintenance Activity/RMC, other industrial facilities (i.e., industrial activities) or Commercial Industrial Services assets.
 - (4) Self-help information for Ship's Force.
 - (5) Technical assistance on setting up and updating a ship's Corrosion Prevention and Control Program.

- c. Perform tank, void and general structural inspections as tasked by the Port Engineers and MPMs. Inspections on surface ships and aircraft carriers will use references (a) and (c). Inspector/surveyor will ensure all inspection data is entered into the CCIMS database within three working days upon completion of inspection.

13.4.3 Surface Force Ships and Aircraft Carriers.

- a. Set up an ongoing corrosion prevention and control program, including all topside structure, equipment, machinery, fixtures, combat and weapons systems, and components.
 - (1) For Commander, Naval Surface Force, use reference (d) as guidance.
 - (2) For Commander, Naval Air Force, use reference (e) Chapter 8 as guidance.
 - (3) Additional guidance can be found in references (a), (b), Maintenance Index Page (MIP) 1500, MIP 6300 and MIP 6641.
- b. Take planned and/or corrective action on all potential discrepancies, and enter all significant discrepancies into the Current Ship's Maintenance Project.
- c. Ensure scheduled AWRs requesting tank, void and general structural inspections are conducted by RMC or Type Commander assigned inspectors and surveyors as required by work center Planned Maintenance System. Ensure the AWR includes requirements for cleaning and gas free services as required.
- d. (Aircraft Carriers only) Aircraft carrier Type Commanders (TYCOM) shall employ **Level 1 Surveyors (Coatings Inspectors) certified in accordance with the requirements of reference (c). These Certified TYCOM Level 1 Surveyors shall** train and assist Ship's Force with **performance of Level 1 Surveys** and documentation of **survey findings** in support of the availability planning process **in accordance with reference (c)**. These **certified TYCOM Level 1 Surveyors** will also provide **additional Shipboard Corrosion Assessment and Reporting (SCAR) training to designated Ship's Force personnel who can assist other Ship's Force personnel** in areas of surface preparation, coating selection and application and Quality Control process for the preservation of spaces and equipment. The overall collection, input and management of the CCIMS database by **certified Level 1 Surveyors** at the TYCOM is required throughout the 32 month availability cycle to fully support Maintenance Program Managers in the life cycle management of shipboard preservation.
- e. (Aircraft Carriers only) The Repair Officer is designated as the Ship's Corrosion Control Officer and is responsible to ensure divisions outlined in reference (e) (or series) Chapter 8 **have sufficient numbers of Ship's Force personnel certified as Level 1 Surveyors in accordance with reference (c) to conduct Level 1 Structural and Coating Condition Surveys**. All inspection results will be entered into the CCIMS database. Departures From Specifications (DFS) shall be submitted in accordance with this manual and as defined in reference (c). The Repair Office will accomplish a joint inspection with the Supervisor and the Commanding Officer's designated representative (i.e., either **a qualified Ship's Force Level 1 Surveyor** or **TYCOM Level 1 Surveyor**) upon completion, inspection and acceptance, by the contractor, of work within each compartment.
- f. (Aircraft Carriers only) For any tanks and/or voids which are not normally filled with seawater and/or not designed to be exposed to seawater, Ship's Force will ensure the following:
 - (1) Only fresh water may be used in any tanks and/or voids which are not normally exposed to seawater (e.g., water transferred to peak tanks and/or dry voids for use in controlling list and/or ballasting the ship must be fresh water).
 - (2) Report to the TYCOM those tanks and/or voids in which fresh water is being used for controlling list and/or ballasting the ship.

(This Page Intentionally Left Blank)

APPENDIX A

PRESERVATION DEPARTURES FROM SPECIFICATIONS PROCESS DECISION TREE

NOTE: THIS DECISION TREE DOES NOT CHANGE ANY TECHNICAL REQUIREMENTS. THE LEVEL OF AUTHORITY REQUIRED INDICATES AT WHAT LEVEL AN OUT-OF-SPECIFICATION CONDITION CAN BE APPROVED WHEN PROPERLY DOCUMENTED AND WITH AN ACKNOWLEDGED INCREASE IN THE RISK OF PREMATURE FAILURE. THIS DOES NOT MEAN THAT THE OUT-OF-SPECIFICATION CONDITION WILL NECESSARILY BE ACCEPTED. THE DECISION TO ACCEPT OR REJECT WORK WILL BE MADE BASED ON THE APPLICABLE REQUIREMENTS AND OTHER CONSIDERATIONS.

General Usage of the Table

- A. This decision tree does not change any technical requirements. The “Level of Authority Required” indicates at what level an out-of-specification condition can be approved. Mitigation guidance on out-of-specification requirements does not imply that a particular out-of-specification condition will be accepted. The decision to accept or reject an out-of-specification requirement will be made at the level indicated in the table.
- B. Minor out-of-specification conditions as described in the columns for “Mitigation Only” and “Local Chief Engineer (CHENG)” in this table represent a low risk of premature coating failure as long as required mitigation actions are taken and the out-of-specification condition is limited with respect to the area being worked. More significant out-of-specification conditions require a formal Waiver/Deviation (Departure from Specification (DFS)) for adjudication of the condition.
- C. With the exception of submarines, the “Mitigation Only” category must be adjudicated by the local Technical Authority (shipyard or Regional Maintenance Center engineering code) at the first occurrence of an out-of-specification condition during a particular work item after which the government Quality Assurance (QA) activity/representative can apply the same mitigation guidance for the specified requirement (for submarines, see K, below). Re-occurrences of a previously mitigated condition require documentation at each occurrence (see J, below).
- D. All DFSs (minor or major, temporary or permanent) must be adjudicated in accordance with Naval Sea Systems Command (NAVSEA) 5400.95 Enclosure 2.
- E. Unless otherwise specified, this table applies only to critical-coated areas.
- F. This table does not apply to NAVSEA 08 cognizant spaces as described in NAVSEA Instruction C9210.4, which specifically includes potable water tanks and reserve feed tanks.
- G. When using this decision tree for submarine preservation, the local technical authority is required to evaluate the nonconformance in accordance with the appropriate Unrestricted Operation/Maintenance Requirement Card requirements.
- H. Repeated waiving of the same out-of-specification requirements shall be cause for the applicator, with the assistance of the local Technical Authority (shipyard or Regional Maintenance Center engineering code), to determine and eliminate the root cause of the noncompliance. If it is determined that the applicator cannot meet the stated requirements, notify NAVSEA accordingly.
- I. The local Technical Authority shall decide when multiple out-of-specification conditions or repeated (same) out-of-specification conditions on the same work item warrant a minor or major DFS. In particular, if multiple out-of-specification “Mitigation Only” and/or “Local CHENG” conditions exist and/or affect an area in excess of 0.3% of the total surface area of a work item, the local Technical Authority will submit a minor or major DFS, depending on the severity/risk of the cumulative out-of-specification conditions.
- J. Unless otherwise specified, action to “document” an out-of-specification condition requires submittal of the NAVSEA Standard Item 009-32 QA inspection forms (included in the appendices of 009-32). These forms become part of the Objective Quality Evidence and shall be retained.
- K. Submarines must document all deviations with the appropriate DFS, no exceptions.

PRESERVATION DEPARTURES FROM SPECIFICATIONS PROCESS DECISION TREE

TABLE A

Surface Preparation					
QA Element	Requirement	Level of Authority Required			
		NAVSEA		Local CHENG	
		Major DFS	DFS	DL/DR/ESR/etc.	Mitigation Only
A. Surface Profile					
1. Critical-Coated Areas (except nonskid)					
a. Average (mils)	2 ≤ profile ≤ 4	<2 ⁽²⁾	>6	5 ≤ profile ≤ 6	4 < profile < 5
b. Individual gage readings (mils)	1 ≤ gage reading ≤ 5	<0.6 ⁽²⁾	>6	0.6 ≤ profile ≤ 1 and 5 ≤ profile ≤ 6	n/a
2. Nonskid (flight deck, hangar bay and weather decks only)					
a. Average (mils)	3 ≤ profile ≤ 4.5	<3	>6	4.5 < profile ≤ 6	n/a
b. Individual gage readings (mils)	None	<2	>6	5.5 < profile ≤ 6	n/a
3. QA Readings	(1)	≥10% missing	5% < missing < 10%	0% < missing < 5%	n/a
Notes:					
1. Documentation Requirement: measurements are to be taken in accordance with Method “C” of American Society for Testing and Materials (ASTM) D 4417 with a sampling rate of five (5) readings for the first 1000 ft ² or portion thereof; two (2) for each additional 1000 ft ² or portion thereof. For individual areas of less than 25 ft ² two (2) readings are required. If several small areas are combined on one QA record, at least one (1) tape is required from each area not to exceed five (5) readings per 1000 ft ² . In accordance with Method “C” of ASTM D 4417 one “reading” is defined as the average of three (3) tapes taken in one area.					
2. Only when discovered during a record review; otherwise the condition should be corrected as it represents extremely high risk.					

VI-13A-2

COMUSFLTFORCOMINST 4790.3 REV C

PRESERVATION DEPARTURES FROM SPECIFICATIONS PROCESS DECISION TREE

Surface Preparation

Rationale for Allowing Departure:

- **Profiles below the limit:** The greatest risk of coating failure due to improper profile is if the profile is insufficient. If an inspection reveals that a profile is too low, local engineering or the inspector shall direct the area to be reblasted. A major departure will be written for a low profile only if the low profile is discovered during a record review. NAVSEA will then be consulted to weigh the various factors contributing to the decision and to determine if the risk of premature failure is justified based on the known schedule impact and cost of rework.
- **Profiles above the limit:** There is low risk of coating failure due to an excessively thick profile, but it does indicate that Quality Control has failed. With solvent based coatings, however, the risk of solvent entrapment increases with excessive profile as more coating must be applied to cover the high peaks with the proper WFT. Excessive profile may indicate a poor choice of abrasive and typically increases the cost of the job due to additional raw materials (paint and abrasive) and labor hours for blasting and clean up. When Dry-Film-Thickness (DFT) readings are performed per Society for Protective Coatings (SSPC)-PA 2, one of the requirements is to “zero” the gage on a blasted, unpainted area. This ensures that the gage readings reflect the coating thickness above the top of the profile peaks, which ensures that the coating thickness is adequate regardless of the surface profile.

Mitigation:

- When high profiles are allowed, mitigation efforts shall be documented and shall include: increased frequency of WFT gage use, special attention to DFT gage calibration, and increased primer thickness when deemed necessary. For paints with lower solids (e.g., MIL-DTL-24441), additional cure time may be necessary to ensure the complete release of solvent as the film cures.

PRESERVATION DEPARTURES FROM SPECIFICATIONS PROCESS DECISION TREE

TABLE B

Surface Preparation					
QA Element	Requirement	Level of Authority Required			
		NAVSEA Major DFS	DFS	Local CHENG DL/DR/ESR/etc.	Mitigation Only
1. Staining a. SSPC-SP 10, SSPC-WAB 10 (L) and SSPC-SP 12 WJ-2 (L)	random staining of an area ≤5%	n/a	random staining of an area >15%	10% < random staining of an area ≤15%	5% < random staining of an area ≤10%
2. Tightly Adherent Coating ⁽¹⁾ a. SSPC-SP 10, SSPC-WAB 10 (L) and SSPC-SP 12 WJ-2 (L)	none remaining	>0.05% remaining or size of largest tightly adherent area >5in ²	Area Affected ≤0.05% <i>and</i> Size of Largest Area <5in ²	Area Affected ≤0.02% <i>and</i> Size of Largest Area <2in ²	n/a
3. Flash Rusting a. SSPC-WAB 10 (L) and SSPC-SP 12 WJ-2 (L)	flash rust no greater than "L" on entire surface ⁽²⁾	5% < not "L"	2% < not "L" ≤5%	0.5% < not "L" ≤2%	not "L" <0.5%

Notes:

- As defined by SSPC-SP 7.
- NAVSEA allows SSPC-WJ-2 and SSPC-WAB-10 surfaces to flash rust to "L" or "Light" for application of coatings on Naval vessels. SSPC defines flash rust as discoloration that develops within a few hours of completion of blasting as the surface dries. Any rust that develops over several hours or days after the surface has completely dried is defined as rust-back, not flash rust. Immediately after the surface has dried, the amount of flash rust that has developed shall be determined, and shall not be greater than "Light", as defined below. Immediately prior to painting, however, if rust-back has occurred such that rust is present in excess of the amounts allowed by SP-10, WJ-2, or WAB-10 (whether tightly adherent or not), the surface must be re-blasted to remove this rust and bring the surface back into the required condition. Rust-back is also an indication that chlorides remain present on the surface, which will directly negatively impact the final coating system performance, even if the rust itself is tightly adherent.

VI-13A-4

COMUSELTFORCOMINST 4790.3 REV C

PRESERVATION DEPARTURES FROM SPECIFICATIONS PROCESS DECISION TREE

Surface Preparation

Rationale for Allowing Departure:

- **Staining:** Paragraph 5.4.7.3 of NSTM 631 states in part that SSPC-SP-6 (which allows 33% random staining) will result in a degree of cleaning that is adequate for the majority of conventional coating systems under normal exposure conditions. The current requirement for dry abrasive blasted areas is SSPC-SP 10 (which allows 5% random staining) - allowing up to 15% staining with adjudication and mitigation at the local level does not represent a high risk.
- **Staining and Productivity:** If a small area of out-of-specification cleanliness is discovered prior to complete cleaning of the tank or area, the inspector or local engineering code normally direct further blasting. If the condition is discovered after completion of the final cleaning, reblasting would normally involve the loss of two to three production days (as much as 60% of the original production blasting cost) to reblast and reclean the area. The cost of reblasting and recleaning generally is not cost effective since the small amount of surface prepared to SSPC-SP-6 is not expected to impact the coating performance.
- **Tightly Adherent Coating:** Paragraph 7.2.4.4 of NSTM 631 states in part, "Brush-off blasting (SSPC-SP-7) may be used instead of blasting to bare metal in those instances where an epoxy coating is in good condition and has been applied over a well-prepared surface. This method should result in a surface retaining all paint films, but free from all corrosion products, scale, and foreign matter". SSPC-SP-7 is considered an adequate surface preparation method when the remaining coating is in good condition.
- **Excessive Flash Rust:** During preparation of a large area with wet abrasive or Ultra high pressure, some of the adjoining area will flash to "M" or "H". Recovery from flash rusting often requires an effort equivalent to the initial preparation of the surface. In cases where a small area has excessive flash rust bloom adjoining a larger area of acceptable surface, the rework to recover the required surface condition will result in contamination of the adjoining surface with water, "mud" from the removed surface corrosion, grit and dust if an abrasive is used. Once an area is contaminated, the potential to leave some contaminant on the surface is increased, regardless of the recovery actions to clean the surface. The allowance above requires the area to be generally within specification with small areas of flash rusting in excess of "L", resulting in a very low risk of coating failure.

Mitigation:

- **Tightly Adherent Coating:** Mitigation of this condition consists of: 1) documenting the size and general location of remaining coating, 2) ensuring that the remaining coating is truly "tightly adherent" as defined by SSPC-SP 7, 3) ensuring remaining coating has a visible profile, and 4) ensuring that the estimates of size and percent area covered are as accurate as possible.
- **Excessive Staining:** Documentation of the extent of staining.
- **Excessive Flash Rust:** Flash rust must be minimized in areas that are prone to coating failure, e.g., edges, beneath overboard discharges, weld beads, etc. Document extent and location of flash rust.

PRESERVATION DEPARTURES FROM SPECIFICATIONS PROCESS DECISION TREE

TABLE C

Surface Preparation					
QA Element	Requirement	Level of Authority Required			
		NAVSEA Major DFS	Local CHENG DFS	DL/DR/ESR/etc.	Mitigation Only
A. Surface Contamination					
1. Conductivity					
a. All Immersed Areas	<30μS	>35μS	30μS< conductivity ≤35μS	n/a	n/a
b. Flight Decks, Weather Decks, Hangar Bay and All Other Areas	<70μS	>85μS	70μS conductivity ≤85μS	n/a	n/a
2. Hydrocarbons					
a. SSPS-SP 1 (before and after surface preparation)	none visible	when mitigation efforts fail and area contaminated >0.03%	when mitigation efforts fail and area contaminated ≤0.03%	n/a	n/a
3. Dust (ISO 8502-3)	dust quantity ≤2 dust particle size ≤2	dust quantity >3 dust particle >3	n/a	2< dust quantity <3 2< dust particle <3	n/a
4. QA Readings	(1)	missing >25%	10%≤ missing ≤25%	missing ≤10%	
Notes:					
1. Documentation requirement for conductivity: five (5) readings for each 1000ft ² of surface being prepared. Documentation requirement for dust test: three (3) tapes for the first 1000ft ² , one (1) tape per 1000ft ² thereafter, minimum of three (3) tapes per area being preserved.					

VI-13A-6

COMUSFLTFORCOMINST 4790.3 REV C

PRESERVATION DEPARTURES FROM SPECIFICATIONS PROCESS DECISION TREE

Surface Preparation

Rationale for Allowing Departure:

- **Conductivity:** Excessive chloride contamination can result in blistering of the coating in an immersion area, and can accelerate corrosion under the coating in immersion or non-immersion areas. Because chloride contamination presents a significant risk for premature spot coating failure there is very little tolerance for an out of specification condition. The values that will be resolved by NAVSEA approach a level where premature coating failure may occur, therefore NAVSEA involvement is required to ensure adequate recovery actions, process control and inspection is invoked.
- **Hydrocarbon Contamination:** Hydrocarbon contamination on a surface is a more significant cause for premature spot coating failure than chlorides. When contamination is discovered prior to surface preparation or upon completion of surface preparation, the surface will be rejected and re-cleaned. Local engineering codes and the inspectors will not authorize surface preparation or coating in cases where there is known contamination. The only time a DFS (local or off station) will be processed is if the contaminant is discovered after the surface preparation is completed and there is suspicion that the contaminant has been driven into the surface during surface preparation.
- **Dust:** Dust remaining on the surface prior to coating can significantly impact the long-term adhesion of the coating. The rationale for the high percentage of missing readings allowed prior to NAVSEA involvement is that normally very few readings are required. 25% missing readings may be only 1 reading less than the required number of readings.

PRESERVATION DEPARTURES FROM SPECIFICATIONS PROCESS DECISION TREE

TABLE D

Surface Preparation and Coating Application					
QA Element	Requirement	Level of Authority Required			
		NAVSEA		Local CHENG	
		Major DFS	DFS	DL/DR/ESR/etc.	Mitigation Only
A. Environmental Conditions (times are cumulative)					
1. % Relative Humidity					
a. Tanks	RH ≤50%	>55% for >2 hours	n/a	50% < RH ≤55% for ≥2 hours	50% < RH ≤55% for <2 hours
b. Other Areas	RH ≤85%	>90% for >2 hours	n/a	85% < RH ≤90% for ≥2 hours	85% < RH ≤90% for <2 hours
2. Substrate Temperature					
a. High, Out of Specification	varies by application	temperature during painting <i>or</i> curing >110% of maximum allowed ⁽³⁾	n/a	100% < temperature during painting <i>or</i> curing ≤110% ⁽³⁾	n/a
b. Low, Out of Specification	varies by application	temperature during painting <i>or</i> curing <90% of minimum required ⁽³⁾	n/a	90% ≤ temperature during painting <i>or</i> curing <100% with no mitigation ^(2, 3)	90% ≤ temperature during painting <i>or</i> curing <100% ⁽³⁾
c. Flight Deck Temperature	varies by application	any noncompliance	n/a	n/a	n/a
d. At or Close to Dew Point	substrate temperature >5°F above the dew point	at or below dew point during painting <i>or</i> curing	n/a	temperature <5°F above the dew point with no mitigation ⁽²⁾	temperature <5°F above the dew point (<i>not</i> allowed on submarines)
3. QA Readings	(1)	missing >25%	10% < missing ≤25%	missing ≤10%	n/a

VI-13A-8

COMUSFLTFORCOMINST 4790.3 REV C

PRESERVATION DEPARTURES FROM SPECIFICATIONS PROCESS DECISION TREE

Surface Preparation and Coating Application

Notes:

1. Varies by application, review technical documentation for specific documentation requirements.
2. This would occur when the condition was discovered during a record review of completed or in-process preservation.
3. Temperature in °F only.

Rationale for Allowing Departures:

- **Substrate Temperature:** When the substrate temperature is out of specification (except for high temperature), additional cure time within specification can be added prior to application of the next stripe or full coat of paint to mitigate “out of specification” conditions (additional cure time required is the amount of time the environmental conditions were out-of-specification). This additional cure time must be documented properly. Additional cure time after application of a subsequent coat of paint does not satisfy the curing requirement. For excessive temperature conditions, local engineering resolution is required.

Mitigation:

- **Substrate Temperature, At Or Close To Dew Point:** Painting or blasting when the substrate temperature is less than 5°F above the dew point may be acceptable in some circumstances, e.g., during the early morning when temperatures are clearly rising. Proper mitigation for this condition is a documented increase in dew point/substrate temperature measurement to ensure that the substrate temperature does not fall below the dew point and frequent visual inspection to ensure that moisture has not condensed on the surface.

PRESERVATION DEPARTURES FROM SPECIFICATIONS PROCESS DECISION TREE

TABLE E

COMUSFLTFORCOMINST 4790.3 REV C

Coating Application					
QA Element	Requirement	Level of Authority Required			
		NAVSEA	DFS	Local CHENG	Mitigation Only
		Major DFS		DL/DR/ESR/etc.	
A. Receipt Inspection	(1)	product applied, no receipt inspection possible	n/a	coating applied and sufficient coating remaining to perform receipt inspection	n/a
B. Shelf Life	verify coating shelf life not expired prior to application of coating	product applied, no shelf life extension possible	n/a	coating applied and sufficient coating remaining to perform shelf life extension inspection	n/a
C. Mixing (mixing temperature and ratio)					n/a
1. All Paint (except nonskid)	varies by application	improperly mixed or off-ratio paint applied	n/a	mixing temperature out of- specification ⁽²⁾	n/a
2. Nonskid	varies by application	any noncompliance	n/a	n/a	n/a
<p>Notes:</p> <p>1. Receipt inspection requirements: 1) surface ships require Certificate of Conformance for all coatings, and 2) submarine requirements are covered in NSTM Chapter 631, Table 11-1.</p> <p>2. This would occur when the condition was discovered during a record review of completed or in-process preservation.</p> <p>Rationale for Allowing Departure:</p> <ul style="list-style-type: none"> • Shelf Life: Coatings must be certified based on receipt inspection for submarines per NSTM Chapter 631, or based on receipt inspection or a Certificate of Compliance for surface craft per SI 009-32. In some cases due to logistical problems the coating is received without receipt inspection, or with an expired shelf life, just prior to when it must be applied. 					

VI-13A-10

**PRESERVATION DEPARTURES FROM SPECIFICATIONS PROCESS DECISION TREE
TABLE E (CON'T)**

Coating Application					
QA Element	Requirement	Level of Authority Required			
		NAVSEA		Local CHENG	
		Major DFS	DFS	DL/DR/ESR/etc.	Mitigation Only
D. DFT (measured IAW SSPC-PA 2)					
1. Ultra-High Solids (UHS) Coatings (per coat or full system) ⁽³⁾	varies by application	overall average coating applied >30mils	system maximum< overall average coating applied ≤30mils	localized average coating applied ≤50mils on ≤20% of the surface ⁽²⁾ <i>and</i> area covered by runs, drips, and sags >1% <i>or</i> of thickness >50mils	area covered by runs, drips, and sags ≤1% of thickness ≤50mils
2. Solvent Based Coatings (per coat or full system) ⁽³⁾	varies by application	measured DFT >150% of maximum allowed	n/a	100%< measured DFT ≤150% of maximum allowed	n/a
3. All Coatings					
a. Total System	varies by application	low, out-of-specification	n/a	n/a	n/a
b. Individual Coat DFT	varies by application	n/a	n/a	low, out-of-specification	
4. QA Readings	(1.)	missing >25%	0%< missing ≤25%	n/a	n/a
Notes:					
1. SSPC-PA 2 requires five (5) DFT measurements over the first 100 ft ² , and, for areas up to 300 ft ² , each 100ft ² area shall be measured. For areas up to 1000ft ² , three (3) 100ft ² areas shall be measured. For areas larger than 1000ft ² , measure three (3) 100ft ² areas in the first 1000ft ² , and one (1) 100ft ² for each additional 1000ft ² thereafter.					
2. This is intended to allow for film thickness variations caused by stripecoating and overspray during coating adjacent areas, not for poor workmanship.					

VI-13A-11

COMUSFLTFORCOMINST 4790.3 REV C

PRESERVATION DEPARTURES FROM SPECIFICATIONS PROCESS DECISION TREE

Coating Application

Notes:

3. Film thickness indicated does not include stripe coat thickness unless specifically referenced.

Rationale for Allowing Departure:

- **High Solids Coatings:** Currently NSTM 631 Table 11-1 Note 7 allows coatings to be applied to 150% of the required coating thickness. Based on discussions with representatives, "required" thickness refers to the range if a range is stated. The result is that coatings can be applied up to 150% of the maximum range identified by the manufacturer. This interpretation has been common practice by the Naval Shipyards as well as contractors, in accordance with the understanding stated above with NAVSEA.
- **Solvent Based Coatings:** For solvent-based coatings there is a potential for solvent entrapment when a coating is applied at a higher DFT than the manufacturer recommends. The change in interpretation requires closer control for excessive thickness of solvent-based coatings. The risk of solvent entrapment may be mitigated by ventilation, temperature, humidity and the amount of cure time between coats. The new interpretation is somewhat more restrictive for solvent-based coatings, and requires engineering review if the coating is not applied within manufacturer's recommendations.

Mitigation:

- **High DFT Readings:** Mitigation of high DFT values is mitigated by taking additional DFT readings (as necessary) to identify the extent of the nonconforming condition, documenting these findings, reducing the thickness of follow-on coats when appropriate, and increased attention to application processes (nozzle sizes, stand-off distances, etc.) to prevent recurrence.

**PRESERVATION DEPARTURES FROM SPECIFICATIONS PROCESS DECISION TREE
TABLE E (CON'T)**

Coating Application					
		Level of Authority Required			
QA Element	Requirement	NAVSEA Major DFS	DFS	Local CHENG DL/DR/ESR/etc.	Mitigation Only
E. Overcoat Window	see ASTM F-718 datasheet	time for cure insufficient <i>or</i> >125% of maximum time allowed	time for cure insufficient <i>or</i> 115%< of maximum time allowed ≤125%	time for cure insufficient <i>or</i> 100%< of maximum time allowed ≤115%	n/a
F. Cure to Service	see ASTM F-718 datasheet	insufficient	n/a	n/a	n/a
G. Amine Bloom					
1. Prime, Intermediate or Stripe Coat	none present	no corrective action taken	n/a	corrective action taken	n/a
2. Topcoat	n/a	n/a	n/a	condition documented	n/a
<p>Rationale for Allowing Change:</p> <ul style="list-style-type: none"> • Overcoat Windows: Temperature changes during curing can change the minimum and maximum overcoat windows. Local engineering oversight is directed for overcoat window problems because often the contractor or paint shop believes that there is an overcoat window problem in cases where close scrutiny of the environmental records show that there is additional overcoat window remaining. If there is an overcoat window problem the recovery may be to solvent wipe the coating, abrade the coating, or abrasive blast the coating. The local engineering code is to consult with the coating manufacturer to determine the appropriate recovery action, if recovery is possible. 					

VI-13A-13

COMUSFLTFORCOMINST 4790.3 REV C

**PRESERVATION DEPARTURES FROM SPECIFICATIONS PROCESS DECISION TREE
TABLE F**

Surface Preparation					
QA Element	Requirement	Level of Authority Required			
		NAVSEA Major DFS	DFS	Local CHENG DL/DR/ESR/etc.	Mitigation Only
A. Blasters	SSPC-C 7	no certification	out of date certification	n/a	n/a
B. Equipment Operators and Sprayers Utilizing Plural Component Equipment	MPCAC	no certification	out of date certification	n/a	n/a
C. Contractors Performing Preservation Work	QP-1	no certification	out of date certification	n/a	n/a
D. Coating Inspectors	NPBI or NACE CIP Level 1	no certification	out of date certification	n/a	n/a

VI-13A-14

COMUSFLTFORCOMINST 4790.3 REV C

VOLUME VI
CHAPTER 14
CANNIBALIZATION

REFERENCES.

- (a) COMSUBLANT/COMSUBPACINST 4406.1 - Submarine Supply Procedures Manual
- (b) NWP 1-03.1 - Naval Warfare Publication Operational Report
- (c) OPNAVINST 4440.19F - Policies and Priority Rules for Cannibalization of Operational Equipment and Diversion of Material at Contractor Plants to Meet Urgent Operational Requirements

LISTING OF APPENDICES.

- A Sample Cannibalization Request Message (Aircraft Carriers and Surface Force Ships Only)

14.1 PURPOSE. To provide guidance for active ship cannibalization and the resultant payback process between ships and Type Commander (TYCOM) cannibalization reporting requirements.

14.1.1 Policy. Cannibalization between active Fleet units is not a normal peacetime practice and will not occur unless:

- a. A significant degraded readiness condition has been reported.
- b. All possible actions have been taken to satisfy the material requirement through other means.
- c. The impact on maintenance personnel has been considered.

14.2 DEFINITIONS.

14.2.1 Self-Cannibalization. When a component is available on board the ship, but in a less essential or already inoperative piece of equipment, it may be desirable for the ship to disable the equipment/system to correct a casualty to a more critical piece of equipment or system. Such self-cannibalization is the prerogative of the Commanding Officer. Self-cannibalization is a temporary measure to return a more critical piece of equipment to an operational status. Replacement of the cannibalized component may or may not be required.

14.2.2 System Cannibalization. System cannibalization is cannibalization of system assets beyond the TYCOM's purview, including other TYCOM end-use material and inactive ship equipment and components. System cannibalizations are a supply system action whereas active cannibalizations are a maintenance action. TYCOM expeditors will initiate all system cannibalizations.

14.2.3 Active Ship Cannibalization. Active ship cannibalization is removal of component(s)/equipment installed in an active ship (or component(s)/equipment removed for overhaul from an active ship) for installation in another active ship. Because of the adverse effects of active ship cannibalization, such action will be taken as a last resort and only in exceptional cases when all other sources have been exhausted. When active ship cannibalization is authorized, the primary source for cannibalization is ships in Chief of Naval Operations Maintenance Availabilities, with recourse to operational ships only as a last resort.

14.3 AUTHORIZATION (Active Ship). Conditions upon which authorization decisions are based, include the following criteria.

- a. There is an urgent operational requirement for the equipment and the existing degradation to the equipment/system is considered to be unacceptable to meet the specific operational commitments.
- b. A Casualty Report (CASREP) and a Not Operationally Ready Supply requisition for the material or component to be cannibalized have been issued. The scheduled or estimated delivery date must be such that the parts will not be available from the designated supply stocking point in time to achieve satisfactory material readiness at least seven days prior to an underway date or operational commitment. The required part must not be available from other equipment on board the ship, where such equipment is not essential for the ship to accomplish its mission.

- c. All other sources, including screening of all ashore supply support sources, afloat inventory assets, local fabrication and system cannibalization have been exhausted.
- d. Operational alternatives such as delays in deployment and gapping requirements have been considered. Routine operations may not be sufficient cause to justify active ship cannibalization.
- e. Immediate Superiors in Command (ISIC) will normally initiate the cannibalization when special circumstances or urgent operational commitments exist.

14.3.1 Commander Naval Surface Force Ships.

- a. Cannibalization Not Involving Ships in Overhaul. When a system asset is not available and if the degree of readiness degradation (normally a CASREP) warrants such action, the only remaining alternative is to cannibalize from an active ship. Approval of active ship cannibalization request (not involving ships in overhaul) required to satisfy CASREP requirements will be authorized by the appropriate TYCOM.
- b. Cannibalization Involving Ships in Availabilities. Cannibalization from ships in availabilities will be minimized since such actions often affect maintenance/operational schedules for several ships. Cannibalization may be initiated only after non-availability of materials through the supply system or alternate sources has been ascertained. Cannibalization from ships in overhaul/availability must be approved through the appropriate TYCOM. Requests must be submitted via the normal chain of command.
- c. COMNAVSURFLANT/COMNAVSURFPAC (N43) and (N4111) will be included as information addressees for tracking purposes on all cannibalization request and approval messages.

14.3.2 Naval Air Force Ships. All cannibalization shall be requested from and authorized by the TYCOM. The request and authorizations will be via message. The requesting message will specify the source of replacement parts, and will reference communications indicating the cannibalized ship's Commanding Officer's concurrence with the cannibalization action. The message shall further specify the method of replacement.

14.3.3 Submarine Force Ships. In all cases cannibalization actions shall be in strict compliance with Appendix K of reference (a).

14.4 REQUEST AND AUTHORIZATION. The following procedures apply when requesting authorization for active ship cannibalization:

14.4.1 Requesting Ship.

- a. Submit a CASREP in accordance with reference (b) on equipment involved.
- b. Submit a Not Operational Ready Supply requisition for the parts.
- c. Specify the required delivery date. Verify, through the supply system, the part will not be available in time to correct the casualty.
- d. Determine that the required parts are not available from on board stock, other ships of the force in the same port, or other non-essential equipment on board the requesting ship.
- e. Initiate an active ship cannibalization request via naval message. Appendix A of this chapter contains a sample cannibalization message with specific reporting requirements. This format must be utilized when requesting cannibalization.
- f. (Surface Force only) Initiate an active ship cannibalization request via naval message. Cannibalization message should be addressed to approving authority as outlined in paragraph 14.3.1a. of this chapter. Appendix A of this chapter contains a sample cannibalization message.
- g. (Submarines only) INFO the following Plain Language Address Directory (PLAD) for all components that have a Last Maintenance Action Date assigned in the Planned Maintenance Requirements Inventories and Schedule: SUBMEPP PORTSMOUTH NH//DDS/SS//.

14.5 SHIP'S RESPONSIBILITIES.

14.5.1 Requesting Ship. When directed, the ship requesting the cannibalized part will:

- a. Assist the cannibalized ship, as requested, with the removal of the parts from the equipment.
- b. Ensure the outstanding requisition for the cannibalized parts remains active unless otherwise directed by the TYCOM or the supply inventory control point. This requisition is the payback and will be diverted to the cannibalized ship.

14.5.2 Cannibalized Ship. When directed, the cannibalized ship will:

- a. Remove the requested parts, prepare shipping documents, package the parts for shipment and deliver the items to the shipping activity, or deliver directly to the requesting ship, as appropriate.
- b. Keep the chain of command advised of the supply status of the required parts. The cannibalized ship should follow-up the outstanding requisition(s) and acknowledge receipt of payback material.

14.6 SURFACE FORCE SHIPS' SPECIFIC INSTRUCTIONS.

14.6.1 Immediate Superior In Command. When assigned, the ISIC/TYCOM will perform the actions listed below.

- a. Ensure the criteria, specific reporting requirements and proper naval message format for active ship cannibalization has been met.
- b. Nominate possible sources of cannibalization from ships within the force.
- c. If acting as approval authority in accordance with paragraph 14.3.1a. of this chapter, confirm that cannibalization is necessary and that all prerequisites for active ship cannibalization, including attempts to supply the components from afloat storeroom spares and system cannibalization, have been met.
- d. Request authorization from the approving activity, as appropriate, to cannibalize from a ship within the force by endorsing the ship's request for cannibalization via routine message.
- e. Transmit approval/disapproval message if acting as approval authority in accordance with paragraph 14.3.1a. of this chapter.

14.6.2 Type Commander.

- a. Monitor and track all cannibalization actions being carried out by subordinate units.
- b. If cannibalization is not feasible from a ship within the force, request assistance from other TYCOMs.
- c. Submit quarterly cannibalization report to United States Fleet Forces Commander per Congressional requirements.
- d. Ensure the criteria, specific reporting requirements and proper naval message format for active ship cannibalization has been met.

14.7 PROCEDURES. The following procedures apply when cannibalization is authorized:

14.7.1 Type Commander.

- a. Monitor all cannibalization actions being carried out by subordinate units.
- b. Adjudicate and authorize/disapprove all requests for inter-ISIC cannibalizations from ships within the force and provide direction concerning the method of payback to the cannibalized ship.
- c. If cannibalization is not feasible from a ship within the force, request assistance from other TYCOMs.
- d. Meet the reporting requirements contained in reference (c) by producing a monthly cannibalization report (format/template to be provided by U.S. Fleet Forces Command N41). This monthly cannibalization report is due to the Deputy Chief of Staff, Fleet Ordnance and Supply (N41), U.S. Fleet Forces Command no later than the 10th of the following month.

14.7.2 Immediate Superior In Command. When assigned, the ISIC/TYCOM will perform the actions listed below..

- a. Authorize the cannibalization when the transfer and receiving ships have the same ISIC. Provide direction concerning the method of payback to the cannibalized ship. Normally this is done by having the outstanding parts ordered by the receiving ship diverted to the cannibalized ship.

- b. Monitor the delivery of cannibalized part(s) to the ship to ensure the parts are received as soon as possible.
- c. Request the appropriate Regional Maintenance Center to assist in performing the cannibalization, to include the removal of the cannibalized parts and providing rigging services, as appropriate.

APPENDIX A**SAMPLE CANNIBALIZATION REQUEST MESSAGE****(AIRCRAFT CARRIERS AND SURFACE FORCE SHIPS ONLY)**

FM USS (SHIP'S NAME)/(CANNIBALIZING SHIP)
 TO TYCOM/ISIC/(AS APPROPRIATE)
 INFO TYCOM/ISIC/(AS APPROPRIATE)
 NAVSUP WEAPON SYSTEMS SUPPORT MECHANICSBURG PA/
 (APPROPRIATE RMC AND/OR RMC DET)
 SUBMEPP PORTSMOUTH NH/ (PARA 14.4.1.G) (AS APPROPRIATE)
 SURFMEPP PORTSMOUTH VA/(AS APPROPRIATE)
 USS (SHIP'S NAME)/(CANNIBALIZED SHIP PLAD)
 BT
 UNCLAS/N04400/
 PASS TO OFFICE CODES: (AS APPROPRIATE)
 SECINFO/U/-/
 SUBJ/ACTIVE SHIP CANNIBALIZATION REQUEST//
 MSGID/GENADMIN/USS (ORIGINATING SHIP'S NAME AND HULL NO.)//
 REF/A/CASREP/USS (SHIP'S NAME)/(DTG)/
 REF/B/DOC/COMUSFLTFORCOMINST 4790.3/
 REF/C/DOC/OPNAVINST 4440.19F/
 NARR/REF A IS CANNIBALIZING SHIP'S CASREP. REF B IS JOINT FLEET MAINTENANCE MANUAL
 VOLUME VI, CHAPTER 14, PROVIDING TYCOM POLICY ON ACTIVE CANNIBALIZATION. REF C IS
 POLICIES AND PRIORITY RULES FOR CANNIBALIZATION OF OPERATIONAL EQUIPMENT AND
 DIVERSION OF MATERIAL AT CONTRACTOR PLANTS TO MEET URGENT OPERATIONAL
 REQUIREMENTS./
 GENTEXT/REMARKS/1. TO CORRECT CASREP PER REF A ON BOARD USS (CANNIBALIZING SHIP'S
 NAME) REQUEST ACTIVE SHIP CANNIBALIZATION PER REF B AND REPORT CANNIBALIZATION
 DATA PER REF C. THE FOLLOWING INFORMATION IS REQUIRED PER CANNIBALIZATION
 REQUEST/REQUISITION:
 A. REQUISITION NUMBER (UIC-JULIAN DATE-SERIAL NUMBER) AND CURRENT STATUS
 B. REQUISITION REQUIRED DELIVERY DATE (RDD):
 C. EQUIPMENT NOMENCLATURE/EQUIPMENT IDENTIFICATION CODE (EIC)
 D. CASREP SERIAL NUMBER
 E. COG SYMBOL/NSN/FSCM-PART NUMBER/NOMENCLATURE
 F. APL NUMBER.
 G. CIRCUIT SYMBOL (IF APPLICABLE OR N/A)
 H. JOB CONTROL NUMBER (JCN) USED IN THE CASREP PARTSID/DATA SET
 I. REQUIRED QTY/ALLOWANCE QTY/ON HAND QTY
 J. PART SUPPORTS INTERMEDIATE MAINTENANCE OR REPAIR, YES OR NO
 K. PART CARRIED ONBOARD THE OPERATIONAL UNIT, YES OR NO (SHOULD COINCIDE WITH
 THE ALLOWANCE QTY ABOVE)
 L. PART AVAILABLE IN SUPPLY SYSTEM WHOLESAL, YES OR NO
 YES=ASSETS ARE AVAILABLE IN THE SUPPLY SYSTEM BUT WILL NOT MEET RDD.
 NO=ASSETS ARE NOT AVAILABLE IN THE SUPPLY SYSTEM.
 M. IF ASSETS ARE AVAILABLE IN THE SUPPLY SYSTEM, PROVIDE THE ESTIMATED SHIPPING
 OR DELIVERY DATE.
 N. PROVIDE JUSTIFICATION FOR CANNIBALIZATION WHEN ASSETS ARE AVAILABLE IN THE
 SUPPLY SYSTEM.
 O. REASON PART NOT IN STOCK AT OPERATIONAL UNIT (E.G., CONSUMED, INSUFFICIENT
 QUANTITY, NOT CARRIED, ETC.)
 P. REASON FOR NOT REPLENISHING (E.G., INSUFFICIENT FUNDING, NOT CARRIED, ETC.)
 2. RECOMMENDED SOURCE IS (CANNIBALIZED SHIP'S NAME).

3. CANNIBALIZATION ACTION NECESSARY FOR (CANNIBALIZING SHIP'S NAME) TO MEET (E.G., UNDERWAY OPERATIONAL COMMITMENT, LIGHT OFF, ETC.)//

BT

NNNN

NOTE: PROVIDE HEADER DESCRIPTION IN ACTIVE CANNIBALIZATION REQUEST MESSAGE FOR LINE ITEMS 1.A THRU 1.P (E.G., D. CASREP SERIAL NUMBER).

NOTE: ENSURE MESSAGES ARE IN ACCORDANCE WITH CURRENT MESSAGE FORMAT AND CURRENT PLAIN LANGUAGE ADDRESS DIRECTORY (PLAD) IS UTILIZED.

VOLUME VI
CHAPTER 15
AMMUNITION OFF-LOAD

REFERENCES.

- (a) NAVSEA OP-4 - Ammunition Afloat
- (b) NAVSEA S9086-CH-STM-030 - NSTM Chapter 074 V3 (Gas Free Engineering)

15.1 **PURPOSE.** This chapter provides guidance and actions to be taken concerning the status of shipboard ammunition and explosives for ships and craft entering an availability whose duration will be in excess of 6 weeks.

15.1.1 **Policy.** Except for those instances where operational requirements dictate the exception, the policies of reference (a) **must** be adhered to. Operational requirements dictating non-compliance with reference (a) will be addressed in a Type Commander (TYCOM) request for waiver.

15.2 **ACTION.** Pyrotechnics (except those within life raft containers) and any ammunition which cannot be stowed in sprinkler-protected magazine spaces will be off loaded. Such magazine spaces need not be located below the main deck or waterline of the ship. All ammunition and pyrotechnics must be removed from ready service locations, launchers, and boats. Retention of other ammunition on board may be authorized on a case basis by the Naval Base Commander, Shipyard Commander or Supervisor of Shipbuilding (SUPSHIP), as applicable, provided the following mandatory requirements are met:

NOTE: TYCOM CONCURRENCE IS REQUIRED BEFORE AMMUNITION OFF-LOAD FOR AN AVAILABILITY.

- a. If an overriding operational requirement exists, precluding the off-load of all ammunition, the TYCOM will certify that requirement to the cognizant Shipyard Commander/SUPSHIP and/or Naval Base Commander, as applicable.
- b. Concurrence of the cognizant Shipyard Commander/SUPSHIP and/or Naval Base Commander must be obtained. This concurrence is based on an evaluation of the work to be done, the spaces involved, the security and damage control capabilities to be maintained on board during the availability, as well as other environmental factors.
- c. Within the ship, hot work of any type will not be performed in a space or compartment containing ammunition, or adjacent to a compartment or space containing ammunition. If either condition is expected to exist during the availability, the ammunition in the affected compartment must be off-loaded before starting the availability. For hot work required on external parts of the ship, the requirement for one intervening compartment may be waived by the Shipyard Commander/ SUPSHIP, as applicable, if satisfied with the safety precautions to be taken. For all hot work in the ship, observe the safety and fire precautions in reference (b).
- d. Notification shall be made to the base and/or industrial activities emergency services, including fire, security, safety and medical organizations, that ammunition remains on board.
- e. There shall be no handling, re-stowage, test sampling or on/off-loading of ammunition while the ship is within an industrial activity.
- f. The ship's fire prevention and damage control organizations must remain in effect at all times throughout the availability.
- g. Placards and warning signs shall be properly posted per reference (a) for specific spaces containing ammunition.

15.3 NOTIFICATION. When a ship or craft is scheduled to enter a commercial industrial activity, and approval has been granted to allow ammunition to remain on board, the United States Coast Guard Captain of the Port, within whose jurisdiction the industrial activity is located, shall be informed as to name and hull number of the ship, and the types and quantities of ammunition remaining on board. Should there be no cognizant Captain of the Port office, notify the cognizant Coast Guard District Commandant.

VOLUME VI
CHAPTER 16
HABITABILITY

REFERENCES.

- (a) OPNAVINST 9640.1 - Shipboard Habitability Program
- (b) NAVSEA S9600-AD-GTP-010 - U.S. Navy Shipboard Furniture Catalog
- (c) NAVSEA S6161-Q5-CAT-010 - Naval Shipboard Food Service Equipment Catalog
- (d) NAVSEA S6152-B1-CAT-010 - Laundry and Dry Cleaning Equipment Catalog
- (e) NAVSEAINST C9210.4 - Changes, Repairs and Maintenance to Nuclear Powered Ships
- (f) NAVSEAINST 9210.14 - Changes to Submarine Tenders and Destroyer Tenders with Nuclear Support Facilities, Requirements Concerning
- (g) NAVSEA SL720-AA-MAN-030 - Navy Modernization Process Management and Operations Manual
- (h) COMNAVAIRFORINST 9640.1 - Control of Habitability Improvements in Aircraft Carriers

LISTING OF APPENDICES.

- A Table of Habitability Project Technical Requirements and Actions
- B Sample Habitability OPTAR Augment Funding Request
- C Advance Planning Milestones

16.1 **PURPOSE.** To provide guidance in the requirements for implementing various habitability programs, and to identify the sources of assistance available for these programs.

16.1.1 **Policy.** The Chief of Naval Operation's shipboard habitability policy, as set forth in reference (a), sets specific minimum standards for new construction and commissioned naval ships, establishes procedures for attainment, and assigns responsibility for implementation.

- a. Expenditure of ship's Operating Target (OPTAR) on habitability improvements, tools, and shipboard furniture and fixtures is considered a part of this program. Funds allocated to habitability must be obligated wisely to ensure the maximum, positive impact on shipboard quality of life.
- b. Procurement of furnishings, food service equipment and laundry equipment shall conform to references (b), (c) and (d).
- c. Unauthorized alterations and rearrangements are prohibited.
- d. Changes to spaces or systems covered by references (e) and (f) shall be approved by Naval Sea Systems Command (NAVSEA) and conform to the requirements of Chapter 3 section 3.8 of this volume.
- e. (Surface Force Ships and Aircraft Carriers only) All changes to Ship Configuration as a result of habitability improvements, repair or replacement, regardless of the accomplishing activity, must meet the requirements of reference (g), Section 2 and Appendix A of this chapter.

16.1.2 **Discussion.** Shipboard habitability encompasses ship's systems and facilities which satisfy the basic human needs of the crew. Included are facilities and systems for eating, sleeping, personal hygiene, ventilation, climate control, and recuperative or leisure activity. Since funds are severely limited, a well managed habitability program is essential to ensure ships conform to the minimum standards of shipboard habitability.

16.2 **HABITABILITY IMPROVEMENT PROGRAMS.**

16.2.1 **Ship's Force Habitability Improvement Projects.** A short range program, initiated, planned and scheduled by the ship. This program uses ship's OPTAR funds, not to exceed \$25,000 per project, with the majority of the work being accomplished by Ship's Force.

- a. These projects are intended to be practical, workable, short-range projects representing the individual Commanding Officer's strategy for the enhancement of living quarters and personnel services areas on board ship.

- b. The emphasis of this program is to improve existing living conditions and the quality of life to meet the standards of reference (a) using Ship's Force labor and, when approved, special habitability fund augmentation. Allocation of these limited funds will be on a "fair share" basis in relation to Force requirements.
- c. Not all livability items fall within the purview of ship's habitability improvement projects or qualify for special habitability fund augmentation. Items of the following nature are not within the scope of this program.
 - (1) Replacement of consumable items such as mattresses, pillows, or utensils. These items should be programmed for regular OPTAR funding on an incremental basis.
 - (2) Improvements such as furnishings and lighting in working spaces and passageways which are more properly categorized as improvements in safety and/or operations.
 - (3) Unauthorized modifications or alterations. These modifications include alterations which affect compartment size or location, adding false bulkheads, overheads, or new equipment not previously installed.
 - (4) Normal ship maintenance and organizational repair responsibilities.
 - (5) The Deck coverings such as tile, terrazzo, etc. which are available via the Regional Maintenance Center (RMC)/Immediate Superior In Command (ISIC) Commercial Industrial Services contracts.
- d. Ship's OPTAR funds may be used to renew existing bulkhead sheathing and false overheads in food preparation, medical, dental, flag, Commanding Officer, Executive Officer, chapel, wardroom, and Chief Petty Officer (CPO) messing and lounge areas. Existing sheathing and false overheads in crew messing areas may be replaced when unserviceable. Sheathing and false overheads in all other areas will be removed when unserviceable and will not be replaced. There will be no new installations of bulkhead sheathing or false overheads.
- e. Due to the fiscal and physical limitations on this program, individual ships should develop a sensible, realistic and continuing plan for improving overall living conditions, with most of the work to be accomplished by Ship's Force.
- f. Commanding Officers may request funds to support an emergent Habitability Improvement Project through the chain of command at any time. The request should contain an itemized listing, in prioritized order, with location, nomenclature, National Stock Number (NSN), cost estimate, and other clarifying information.
- g. When requesting funds to replace food service equipment, comply with Type Commander (TYCOM) supply procedures. All requests must have clear and concise justification. Appendix B of this chapter provides a sample request letter.

16.2.2 Habitability Programs Under the Technical Sponsorship of Naval Sea Systems Command. These are programs under various titles that have evolved from the NAVSEA Habitability Program originally established in 1975. The common program element is approved NAVSEA title block drawings that define the scope and details for projects accomplished there under. These formalized programs are executed in accordance with long range plans with the established goal of achieving and maintaining the Habitability Standards promulgated by reference (a) over the life of each ship.

- a. The TYCOM shall authorize and fund individual habitability upgrade/refurbishment projects. For aircraft carriers, projects are in accordance with reference (h). Contractor services may be utilized for design and engineering support, procurement development and monitoring, and on board installation support. Installation support may be provided in the form of a Customer Contract Team (CCT) that accomplishes the full scope of the project or as professional technical advisor who assists untrained and inexperienced Ship's Force personnel with accomplishment of the work.

- b. The TYCOM is responsible for developing and maintaining the long range five-year NAVSEA Habitability Life Cycle Program plan. Ships are selected for initial induction into the Program based on years in-service. Specific ensuing projects are based on non-compliance with criteria specified by reference (a), the general scope of habitability deficiencies as noted by the Board of Inspection and Survey, planned life cycle furniture replacement schedules, and other available documentation. Ship's Force input is encouraged.
- c. Design surveys are normally accomplished during Chief of Naval Operation's maintenance availabilities. Follow-on installation projects will be scheduled during subsequent maintenance availabilities until all designated compartments in each ship have been upgraded or received new furniture. Once all the designated compartments in any ship have been upgraded or refurnished, the process will repeat itself. That is, each compartment, after the initial upgrade, will be, in accordance with the TYCOM life cycle plan, scheduled for second and subsequent upgrades at specified intervals until such time that ship is removed from the program pending decommissioning.
- d. While the routine replacement of habitability hardware usually does not generate the requirement for changes to arrangements for ventilation, power and lighting, steam, support foundations, etc., more extensive projects such as upgrades may well generate these requirements. Where these changes result in requirements to increase the capacity of the "hotel" systems providing support, a concurrent Ship Change Document (SCD) in accordance with reference (g) for upgrade of the "hotel" systems must be executed at TYCOM expense concurrent with the individual Program project. More detailed guidance in this area is provided by Appendix A of this chapter. Verification of whether or not SCDs are required to support individual projects may be made via the following TYCOM Codes:
 - (1) COMNAVAIRPAC Shipboard Habitability Manager, Code N434A8.
 - (2) COMNAVAIRLANT Shipboard Habitability Manager, Code N431HE.
 - (3) COMNAVSURFPAC Shipboard Habitability Manager, Code N43TH.
 - (4) COMNAVSURFLANT Shipboard Habitability Manager, Code N436E6.
- e. Program projects should be prioritized in the following order.
 - (1) Crew/CPO Berthing.
 - (2) Crew/CPO Sanitary Spaces.
 - (3) Troop Spaces.
 - (4) Food Preparation and Service Spaces.
 - (5) Laundry Spaces
- f. Per the authority of reference (a), the TYCOM may task and fund various agents including an RMC to accomplish the following:
 - (1) Design habitability improvements for accomplishment by Forces Afloat or a CCT.
 - (2) Procure installation materials.
 - (3) Perform other management and engineering services.
 - (4) Provide installation or installation support services.

16.2.2.1 Program Responsibilities.

16.2.2.1.1 Chief of Naval Operations.

- a. Authorize Program.
- b. Establish shipboard habitability standards based on recommendations of Habitability Working Groups.

16.2.2.1.2 Naval Sea Systems Command.

- a. Establish technical policy.

- b. Approve furnishings, fixtures, materials, food service equipment and laundry equipment.
- c. Develop installation procedures.

16.2.2.1.3 Type Commander.

- a. The Habitability Program Manager shall follow the Technical Requirements of Appendix A.
- b. Develop the Long Range Plan and establish priorities for attainment of standards. Provide these plans to the appropriate Expanded Planning Yard (EPY) updating plans as required.
- c. Plan, schedule, coordinate and monitor projects.
- d. Authorize, budget and fund the Program.

16.2.2.1.4 Regional Maintenance Center or Other Agent as Tasked and Funded by Type Commander.

- a. Solicit, award and administer contracts to support Program requirements for design, engineering and technical support and installation. Perform the duties of a Contracting Officer's Representative for the monitoring and oversight of Program contractors.
- b. Provide project coordination throughout the life of each project.
- c. Provide liaison with Fleet and TYCOMs, COMNAVSEASYSCOM, Naval Surface Warfare Center, Carderock Division (NSWCCD) In-Service Engineering Agents (ISEA)/Life Cycle Managers (LCM), Planning Yards, other RMCs and other naval activities.
- d. Upon induction of the first ship of each class into the Program, submit preliminary habitability space arrangement concepts or drawings to COMNAVSEA's NSWCCD 974 ISEA/LCM for verification of conformance to applicable ship habitability specifications and criteria (e.g., reference (a)). Submittal of concepts or drawings for follow-on ships of the class is not required, unless different space arrangements are proposed. Submit final habitability space arrangement drawings for NSWCCD 974 ISEA review (prior to Planning Yard signature).
- e. Prepare, approve or task approval by the EPY NAVSEA drawings for the Program as required by Appendix A of this chapter. Provide copies of locally approved drawings to the EPY. (For nuclear-powered ships, drawings are submitted to the Hull Planning Yard/Reactor Planning Yard for review and approval.)
- f. Maintain a chronological record of all projects accomplished on each ship from the induction of the ship into the Program through decommissioning. This record includes initial ship check data, copies of all installation drawings, red-line drawings (if any) and other pertinent data.
- g. Identify and oversee the procurement of all required installation material. Maintain a material commodity database identifying all material approved for use under the Program.
- h. Prepare and update procurement specifications for habitability material.
- i. Identify requirements for Indefinite Delivery Indefinite Quantity Contracts to provide material for frequently used material items. (Contracts are normally awarded and administered by the Fleet Logistics Centers.)
- j. Operate material staging centers for the receipt, staging and shipping of project material.
- k. Perform quality assurance checks at material staging centers and onboard ships of new material and hardware. Prepare Quality Deficiency Reports and Reports of Discrepancy on requisitioned material as needed.
- l. Provide administrative assistance to the TYCOM in the preparation of long range habitability improvement plans and related correspondence.
- m. Maintain a habitability website to facilitate the dissemination of Program information.
- n. Respond to fleet requests for habitability assistance or support.

- o. Use NSWCCD 974's web site to access Navy approved furniture, food service and laundry equipment of references (b), (c) and (d) at: <https://90machinery.navsses.navy.mil/habitability/>.
- p. When required, request NSWCCD 974 ISEA/LCM support for approval of alternative food service/laundry equipment and furniture not found in references (b), (c) and (d). When required, request NSWCCD 974 ISEA/LCM to conduct equipment selection/evaluation and testing. Also, request NSWCCD 974 support for equipment Integrated Logistics Support packages (parts support via Allowance Parts Lists, Tech Manuals and Maintenance Index Pages/Maintenance Requirement Cards) and Coordinated Shipboard Allowance List support.

16.2.2.1.5 Supply Activity.

- a. Prepare, contract, and procure materials.
- b. Administer other associated contracts.

16.2.2.1.6 Ship Commanding Officer. (When projects are accomplished by Ship's Force.)

- a. Assign project manager and petty officer supervision for projects.
- b. Assign an adequate labor force for removal, space preparation, installation and required fire watches working under technical advisor supervision.
- c. Conduct training programs.
- d. Account for, coordinate all movement of, and store all project material as it is received on board.
- e. Coordinate all required tag-out/in paperwork and Work Authorization Forms.
- f. Dispose of all retrograde material generated by the project.
- g. Report changes affecting repair parts support to Naval Inventory Control Point. Technical data will be provided to the ship by the Agent preparing installation drawings.
- h. Report completion to the TYCOM with summary of lessons learned.
- i. Ensure Ship's Selected Records are updated, as appropriate. Technical data will be provided to the ship by the Agent preparing installation drawings.

16.2.2.2 Project Milestones. Advanced Planning milestones for scheduled projects are listed in Appendix C of this chapter for aircraft carriers and submarine forces and Volume II, Part II, Chapter 2, Appendix D of this manual for surface force ships.

16.2.2.2.1 Advance Planning Notice (Surface Force Ships only). This TYCOM generated notice identifies Projects proposed for accomplishment, and provides work scope details including, if applicable, Ship's Force manpower requirements. This notice also requests Commanding Officer's comments, concurrence, and commitment of resources to the proposed projects.

16.2.2.2.2 Advance Planning Notice (Aircraft Carriers only). Habitability projects are entered into the Availability Work Package. Volume II, Part I, Chapter 3 of this manual provides guidance in the development and revision of the Availability Work Package.

16.2.2.2.3 Project Confirmation Notice. Following receipt of the Commanding Officer's concurrence with the proposed work scope and commitment of resources, the TYCOM confirms the projects. Thereafter, any modification or change to the scope of the projects will adversely affect scheduled milestones and could result in project deferral or cancellation.

16.2.2.2.4 Project Authorization. (Applicable to projects accomplished by Ship's Force.) Upon receipt of the Commanding Officer's project start request, normally about two weeks before the start of the maintenance availability, the TYCOM evaluates readiness to begin the project and authorizes the project to be started. Rip-out shall not proceed until receipt of this authorization.

16.2.2.3 Project Completion Report. (Applicable to projects accomplished by Ship's Force.) Following completion of the project, the Commanding Officer shall prepare a letter describing the project experience, which will be used by the TYCOM to update planning and installation practices. The letter should include the name and designation of the project, funds expended, certification that Integrated Logistics Support procedures have been followed, and any significant problems encountered, improvement recommendations, or lessons learned. Completion letters on all authorized projects should be forwarded via the chain of command to the TYCOM.

16.2.2.4 Integrated Logistics Support Reporting. For projects accomplished by Ship's Force, the ship is responsible for submitting any necessary OPNAV 4790/CK forms for Coordinated Shipboard Allowance List support. Technical data will be provided to the ship by the Agent preparing installation drawings. For projects accomplished by a CCT, the requirements of NAVSEA Standard Item 009-21 shall be invoked.

16.3 NEW CONSTRUCTION SHIPS. U.S. Navy ships are built to meet the habitability standards of reference (a). Prior to certifying the ship's readiness for In-Service, the ISIC will conduct a Habitability Inspection to determine that the ship is materially ready for the crew to move aboard. The results of the Habitability Inspection shall be reported to the TYCOM by message per Volume I, Chapter 3 of this manual.

16.4 NAVAL AIRPAC/LANT SPECIFIC HABITABILITY IMPROVEMENT PROGRAMS.

16.4.1 Aircraft Carrier Climate Control Improvement Team.

- a. The Aircraft Carrier Climate Control Improvement Team (ACCCIT) provides technical assistance to improve aircraft carrier habitability through specific improvements to air conditioning, heating, and ventilation systems serving manned spaces. The TYCOM schedules an ACCCIT visit every 12 to 15 months, but no greater than 24 months.
- b. 30 days prior to the visit, the ship will provide a list of 50 spaces the ship requests to be inspected to the Commander, Naval Air Force Program Manager. Criteria for the spaces to be nominated are as follows:
 - (1) Normally manned.
 - (2) Spaces are being utilized as designated. Voids/storerooms that have been converted to offices/workshops by Ship's Force without alteration authorization will not be investigated.
 - (3) Space has not been investigated during a previous ACCCIT unless all discrepancies were corrected and a problem still exists.
 - (4) Main Propulsion and Auxiliary machinery spaces.
 - (5) Food Device and Laundry Spaces.
- c. During the visit, the team will provide On the Job Training for Ship's Force, validate alteration requirements, validate Planned Maintenance System coverage and assist in the preparation of Current Ship's Maintenance Project (CSMP) deferrals to document discrepancies found. Additionally, with Ship's Force assistance, the team will correct deficiencies as they are discovered if within their capability. Upon completion of the visit, a formal report will be issued listing discrepancies discovered, status of each, correction responsibility and recommended alterations. All corrected and uncorrected discrepancies identified during each survey will be submitted in electronic format (M0001 file) for submission into the ship's CSMP. The TYCOM will utilize this report to conduct follow-up shipchecks to track completion of discrepancies.

16.4.2 Food Service and Laundry (Commander Naval Air Force Pacific)/Enhanced Quality Of Life Program (Commander, Naval Air Force Atlantic).

- a. The Food Service and Laundry (FS&L) and the Enhanced Quality Of Life (EQOL) Programs were developed to achieve and maintain high standards of material and operational readiness of food and hotel services equipment through intensified work definition, configuration analysis, corrective maintenance, and programmed and emergent equipment replacements.

- b. The FS&L/EQOL programs are a cooperative teaming effort involving the Aircraft Carrier TYCOM and Ship's Supply Department. The TYCOM will provide program management, labor funding and administer material procurement. The TYCOM will provide funding and oversight for material procurement. Ship's Force is instrumental in determining the requirements and opportunity for correction of material deficiencies. The FS&L/EQOL programs key objectives are:
- (1) Advance planning.
 - (2) Technical expertise and continuity.
 - (3) Standardization of approved shipboard food service/laundry equipment.
 - (4) Achievement of full Allowance Parts List supportability.
 - (5) Maintenance and grooming support planning.
 - (6) Maintenance training for Ship's Force personnel.
- c. The replacement of food service or laundry equipment usually does not generate the requirement for changes to arrangements of ventilation, electrical, piping systems, and support foundations, etc. However, where changes result in net compartment increase to the capacity of the "hotel" systems providing support, or change the physical configuration of the ship's structure, an SCD in accordance with reference (g) for upgrade of the "hotel" systems must be executed at TYCOM expense. The FS&L/EQOL programs are not intended to supplant the SHIPMAIN Entitled Process. All equipment replacements will consist of equipment that has been approved for shipboard use in accordance with references (b), (c) and (d) or by NSWCCD 974 ISEA/LCM, including the interchangeability of like equipment.
- d. Not all food service or laundry equipment falls within the purview of the FS&L/EQOL programs. Items of the following nature are not within the scope of this program.
- (1) Repair/replacement of non-approved equipment.
 - (2) Unauthorized modifications or alterations. These modifications include alterations which affect compartment size or location, adding false bulkheads, overheads, or new equipment not previously installed.
 - (3) Normal ship maintenance and organizational repair responsibilities.
 - (4) Deck coverings in spaces other than food service and laundry spaces.

(This Page Intentionally Left Blank)

APPENDIX A

TABLE OF HABITABILITY PROJECT TECHNICAL REQUIREMENTS AND ACTIONS

REQUIREMENT ATTRIBUTE	HABITABILITY IMPROVEMENT PROJECT TYPE			MODERNIZATION SCD REQUIRED	MINIMUM ACTION REQUIRED
	REPAIR	UPGRADE	REPLACEMENT		
Requires change in berthing capacity below CNO requirements		X	X	X	Process and execute SCD
Requires new berthing arrangement or design within existing compartment		X	X		For non-nuclear powered ships, provide drawings to Planning Yard. For nuclear powered ships, comply with NAVSEAINST C9210.4A.
Requires new Head arrangement or design within existing compartment		X	X		For non-nuclear powered ships, provide drawings to Planning Yard. For nuclear powered ships, comply with NAVSEAINST C9210.4A.
Requires new Lounge Area arrangement or design within existing compartment		X	X		For non-nuclear powered ships, provide drawings to Planning Yard. For nuclear powered ships, comply with NAVSEAINST C9210.4A.
Replace lockers, berths, furniture, fixtures, food service or laundry equipment of exact same design within same frames, power supply and footprint	X				Use existing drawings to generate Bill of Material
Requires increased ventilation capacity to compartment		X	X	X	Process SCD, install in conjunction with Habitability Improvement Project
Requires rerouting of ventilation within existing capacity		X	X		For non-nuclear powered ships, provide drawings to Planning Yard. For nuclear powered ships, comply with NAVSEAINST C9210.4A.
Requires increased electrical capacity to compartment		X	X	X	Process and execute SCD
Requires use of spare breaker		X	X		Task Expanded Planning Yard to review and approve drawings

VI-16A-1

COMUSELTFORCOMINST 4790.3 REV C

TABLE OF HABITABILITY PROJECT TECHNICAL REQUIREMENTS AND ACTIONS

REQUIREMENT ATTRIBUTE	HABITABILITY IMPROVEMENT PROJECT TYPE			MODERNIZATION SCD REQUIRED	MINIMUM ACTION REQUIRED
	REPAIR	UPGRADE	REPLACEMENT		
Requires rerouting of electrical cables within existing capacity		X	X		For non-nuclear powered ships, provide drawings to Planning Yard. For nuclear powered ships, comply with NAVSEAINST C9210.4A.
Requires increased steam capacity, chill water capacity, etc. to compartment		X	X	X	Process and execute SCD
Requires rerouting of steam piping, chill water piping, etc. within existing capacity		X	X		For non-nuclear powered ships, provide drawings to Planning Yard. For nuclear powered ships, comply with NAVSEAINST C9210.4A.
Requires modification of living space sprinkler system within existing capacity		X	X		For non-nuclear powered ships, provide drawings to Planning Yard. For nuclear powered ships, comply with NAVSEAINST C9210.4A.
Requires additional sprinkler heads(s) to maintain adequate coverage (Per PY review)		X		X	Process SCD, install in conjunction with Habitability Improvement Project

VI-16A-2

COMUSFLTFORCOMINST 4790.3 REV C

APPENDIX B

SAMPLE HABITABILITY OPTAR AUGMENT FUNDING REQUEST

From: Commanding Officer, USS (Ship's Name and Hull No.)
To: TYCOM (as appropriate)
Subj: HABITABILITY OPTAR AUGMENT FUNDING REQUEST
Ref: (a) (Cognizant Fleet and TYCOM Instructions)

1. Request approval of a special OPTAR augmentation per reference (a) in the amount of (dollar amount) for the quality of life improvement project(s) as follows:

PRIORITY	NOMENCLATURE/NSN	QTY	COST EST
1	(Item description, location, etc.)		
2			
3			

TOTAL COST EST:

2. JUSTIFICATION (Conditions necessitating accomplishment of projects)
3. POINT OF CONTACT (Name, DSN/Comm telephone number, email address, etc.)

COPY TO:
ISIC (as appropriate)

(This Page Intentionally Left Blank)

APPENDIX C
ADVANCE PLANNING MILESTONES

<u>MILESTONE (A-MO)</u>	<u>ACTION</u>	<u>EVENT</u>
A - 23	TYCOM	ESTABLISH PLANNING ESTIMATE. TASK RMC WITH DESIGN SHIPCHECK
A - 22	RMC or AGENT	SHIP VALIDATION AND COMMENCE DESIGN
A - 14	TYCOM	SEND HABITABILITY PROJECT ADVANCE PLANNING NOTICE (SURFACE SHIPS)
A - 13	SHIP	INDICATE CONCURRENCE/COMMITMENT TO PROJECT(S) TO TYCOM. ENTER PROJECTS(S) IN CSMP
A - 12	TYCOM	CONFIRM PROJECT
A - 9	TYCOM (AIRCRAFT CARRIERS)	ENTER PROJECTS IN AVAILABILITY WORK PACKAGE (AWP)
A - 8	PMS 312C (CVNs)/SHIP/TYCOM (AIRCRAFT CARRIERS)	PROJECT REVIEW CONFERENCE (PRC)
A - 8	RMC or AGENT	PREPARE SPECIFICATION DEVELOPMENT PACKAGE AND FORWARD TO APPROPRIATE PLANNING ACTIVITY
A - 8	RMC or AGENT	PREPARE MATERIAL REQUISITIONS
A - 7	RMC or AGENT	SEND REQUISITIONS TO FLEET LOGISTICS CENTER
A - 6	RMC or AGENT (SURFACE SHIPS)	ISSUE DRAWINGS TO EPY
A - 2	RMC or AGENT/SHIP	PROJECT KICK-OFF BRIEFING
A	SHIP or RMC AGENT	START AVAILABILITY/PROJECTS
COMP	SHIP (APPLICABLE TO PROJECTS ACCOMPLISHED BY SHIP'S FORCE)	SEND COMPLETION REPORT

(This Page Intentionally Left Blank)

VOLUME VI

CHAPTER 17

IMPRESSED CURRENT CATHODIC PROTECTION

REFERENCES.

- (a) NAVSEA S9086-VF-STM-010 - NSTM Chapter 633 (Cathodic Protection)

17.1 PURPOSE. To provide guidance for the submission of Cathodic Protection Logs, as required by reference (a) and post dry-docking system activation.

17.1.1 Applicability. The contents of this chapter are applicable to all classes of ships that are outfitted with Impressed Current Cathodic Protection (ICCP).

17.2 CATHODIC PROTECTION LOGS. Logs shall be maintained as part of the system operating procedures and be retained by the ship for a period of two years.

17.2.1 Surface Force Ships. All ships with installed ICCP systems shall submit logs monthly per reference (a), using Naval Sea Systems Command (NAVSEA) Form 9633/1 or equivalent, no later than 15 days after the last day of the reporting month to the Cathodic Protection In-Service Engineering Activity (Naval Surface Warfare Center, Carderock Division (NSWCCD), Philadelphia Code 614). NSWCCD will review the ICCP log data and provide an electronic mail response to each ship within 15 working days indicating log receipt and system operational status.

17.2.2 Naval Air Force Ships. All aircraft carriers with installed ICCP systems shall submit logs monthly per reference (a), using NAVSEA Form 9633/1 or equivalent, to the Cathodic Protection In-Service Engineering Activity (NSWCCD, Philadelphia Code 614) no later than 15 days after the last day of the reporting month. NSWCCD will review the ICCP log data and provide a naval message response to each ship within 15 working days indicating ICCP log receipt and system operational status.

17.2.3 Submarine Force Ships. All submarines with installed ICCP systems shall submit quarterly logs per reference (a), using NAVSEA form 9633/2 or equivalent to NSWCCD Philadelphia Code 614 via message no later than 10 days after the last day of the reporting quarter (info Type Commander and NAVSEA). NSWCCD will review the ICCP log data and provide a message to each ship within seven working days indicating ICCP log receipt and system operational status.

17.3 POST DRYDOCKING ACTIVATION. Guidance on the activation of the ICCP systems after undocking is as follows:

- a. The Cathodic Protection System should be activated as soon as electrical power is available. Early activation is encouraged to counteract stray electrical currents from waterborne welding or other industrial activity evolutions which may cause hull deterioration by electrolysis. If the ICCP system cannot be actuated within two hours following undocking; the Type Commander/Immediate Superior In Command must be notified.
- b. If the cathodic protection components have been removed or power to all components is not available within 24 hours after undocking, alternate provisions should be made for activating part of the system if possible. Hull potentials can be monitored using the ship's controller reference electrode (silver-silver chloride) in conjunction with a portable volt-ohm meter.

NOTE: ALL VOLTAGES REFERENCED ARE DIRECT CURRENT.

- c. If the system cannot be activated within three days of undocking, provisions should be made to ensure hull integrity by taking daily hull potential readings. Without cathodic protection the acceptable hull potential range is 0.60 to 0.80 volts with respect to a silver-silver chloride reference cell. If daily readings are more electropositive than 0.55 volt or if changes in hull potentials greater than 0.1 volt occur, welding practices should be checked and/or a temporary system capable of maintaining the hull at 0.85 plus or minus 0.05 volts should be provided.

- d. Where major underwater hull painting (not including touch up) has been performed less than seven days before undocking, caution should be exercised to avoid hull potentials greater than 1.00 volt to a silver-silver chloride reference cell until after the seven-day curing period. During the seven-day curing period, if the hull potential exceeds 1.00 volt, secure part or all of the system to avoid any effect on the hull coating. After a seven-day cure, proper navy hull coating systems are not affected by the higher hull voltages attainable with ICCP systems.

VOLUME VI
CHAPTER 18
INFLATABLE LIFE RAFTS

REFERENCES.

- (a) NAVSEA S9086-TX-STM-010 - NSTM Chapter 583 (Boats and Small Craft)
- (b) NAVSEA S9008-AA-PRO-010 - Lifeboat, Inflatable, MK6, MK7 and MK8 Inspection, Test and Repair Procedures
- (c) NAVAIR 13-1-6.1 - Aviation Crew Systems, Chapter 7 (LRU 13/A)
- (d) NAVSEA TW024-AA-ORD-010 - Unserviceable, Suspended, and Limited Use Ammunition
- (e) NAVSUP Publication 485 - Afloat Supply Procedures

18.1 **PURPOSE.** To provide guidance for the maintenance, repair, certification and procurement of life rafts used onboard naval ships and craft.

18.1.1 **Discussion.** An inflatable life raft is one constructed of a coated fabric and inflated to its design shape by air or other gas. The raft is stowed aboard ship for use only as a life raft, when and as directed by the Commanding Officer/Officer In Charge.

18.2 **FLEET LIFE RAFT PROGRAM.** The Fleet Life Raft Program Manager designated by the United States Fleet Forces Command Maintenance Officer is responsible for establishing policy guidelines for the program. Policy will be disseminated to the Fleet and Naval Sea Systems Command (NAVSEA) certified Regional Maintenance Centers (RMC) for scheduling, planning, conducting Planned Maintenance System (PMS) recertification of fleet assets and management of life raft contingency pools. Commander Naval Surface Force Atlantic (Code N434) and Commander Naval Surface Force Pacific (code N4344) are designated Fleet Life Raft Program Managers.

18.2.1 **Types of Inflatable Life Rafts.** There are 5 basic Navy type inflatable life rafts for use throughout the fleet (ships and aircraft):

- a. MK-6 Mod 3, 25 person, air inflated - currently carried by surface force ships/aircraft carriers, encapsulated in a fiberglass container.
- b. MK-7 Mod 0, 25 person, air inflated - currently carried by surface force ships/aircraft carriers, encapsulated in a fiberglass container.
- c. MK-8 Mod 0, 50 person, air inflated - currently carried by aircraft carriers, encapsulated in a fiberglass container.
- d. LRU 13/A (former MK-2), 7 person, CO₂ inflated - used on aircraft, certified to Naval Air Systems Command (NAVAIR) requirements.
- e. LRU 12/A (former MK-4), 4 person, CO₂ inflated - used on submarines only.

18.2.2 **Commercial Life Rafts.** Various commercial Coast Guard approved life rafts are installed on board certain boats and/or Navy ships for service and in-service evaluation testing. The cognizant command is responsible for PMS recertification requirements.

18.3 **RECERTIFICATION.** The periodicity of recertification will be as designated by PMS requirements.

- a. Recertification is based on PMS periodicity requirements starting from the recertification date stenciled on the outside of the life raft container.
- b. If the certification date is not stenciled or tagged on the outside of the life raft container or verified from the ship's life raft log inspection, recertification records, or unavailable by scanning and electronic remote identification, life raft certification will be considered expired.
- c. Submit an OPNAV 4790/2K to the Fleet RMC for recertification.

18.4 CONTINGENCY POOLS. Designated Fleet Maintenance Activities in the Atlantic and Pacific Fleets are responsible for coordinating the disposition of assets and maintaining contingency pools within authorized limits. Contingency pools will consist of the MK-6, MK-7, MK-8 and LRU 12/A life rafts (ships/boats/craft). The cognizant NAVAIR command will coordinate the disposition of LRU 13/A life rafts (aircraft) from a separate pool of assets. Contingency pools are authorized a limit not to exceed 100 rafts unless approved by the Fleet Life Raft Program Manager.

- a. If the contingency pool should fall below the authorized limit, restock the pool from decommissioning assets (as available). Purchase a new raft from the stock system, using Repair Other Vessel funds, only as a last option to facilitate scheduling.
- b. Commands are not authorized to maintain and operate a life raft contingency pool other than those designated as fleet approved contingency pools. Contact the life raft contingency pool manager for disposition and turn-in instructions for all rafts that are removed from decommissioning ships and/or aircraft.
- c. Contact the designated Fleet Life Raft Program Manager for disposition instructions if the inclusion of additional rafts into the pool will exceed authorized pool limits.
- d. Location of Fleet Life Raft Repair Facilities and Contingency Pools:
 - Mid-Atlantic Regional Maintenance Center (MARMC) Norfolk Naval Shipyard, Portsmouth, VA
 - Southwest Regional Maintenance Center (SWRMC) - San Diego, CA
 - Naval Ship Repair Facility Yokosuka, Japan

18.5 AUTOMATED TRACKING SYSTEM. A data base is maintained by Naval Surface Warfare Center, Carderock Division (NSWCCD) Detachment, Norfolk VA, for tracking the Navy MK-6, MK-7 and MK-8 life raft population (www.boats.dt.navy.mil). Inputs on each life raft are provided by all certified life raft repair facilities. Access is restricted; therefore, for reports or data retrieval, contact the respective Fleet Life Raft Repair Facility (e.g., Fleet Maintenance Activity, Fleet Life Raft Program Manager or Data Base Manager).

18.6 RESPONSIBILITIES.

18.6.1 Commanding Officer/Officer In Charge.

- a. Submitting an OPNAV 4790/2K to the RMC for any life raft requiring replacement or recertification. For recertification, the OPNAV 4790/2K should be submitted no sooner than 6-months prior to the expiration date stenciled on the outside of the life raft container (or date verified by the ship's life raft log). Arrange with the RMC/RRC/Fleet Maintenance Activity for transfer and shipping of rafts to facilitate schedules.
- b. Maintaining a log or data base of all life rafts on board, to include the following:
 - (1) The Inflatable Life Raft Recertification Record (ILRRR) for each raft. ILRRRs are issued with each life raft at recertification. Ships should not accept any life raft from a recertification/repair facility without the ILRRR provided. If the ship does not have the required ILRRR, contact NSWCCD Detachment Norfolk VA.
 - (2) Record the station location and serial number of each life raft. Annotate this information on the top of each ILRRR in the log.
- c. Send a report to NSWCCD Detachment Norfolk VA, the Type Commander (TYCOM) (N43) and the respective recertification/repair facility if any life raft is lost or transferred to another ship. Reports should include the life raft serial number, manufacturer's name, recertification facility and a description of the circumstances.
- d. Ensure life raft fiberglass containers are handled with care using appropriate slings. Life rafts are not to be rolled or stood on-end. Life rafts will be placed with the top up, in racks, with the container seal or canister joint in the horizontal position.

- e. Upon notification of decommissioning from the TYCOM, contact the designated Life Raft Contingency Pool for disposition instructions concerning the unit's life raft inventory whenever the unit is scheduled for decommissioning and not designated for foreign military sales.
- f. Requisition a replacement raft whenever a life raft is lost or determined to be unserviceable and beyond economical repair by the Life Raft Repair Facility, using the ship's Operating Target (OPTAR) funds only when contingency pool assets can not support the replacement.

18.6.2 Regional Maintenance Center/Regional Repair Center.

- a. RMC/RRC Designated Regional Maintenance Centers are responsible for establishing priority of work, scheduling, coordinating PMS recertification and any repair service to support fleet life rafts unless otherwise directed by the Fleet Life Raft Program Manager.
- b. RMC/RRC/Designated Regional Maintenance Centers will function as follows:
 - (1) Management and disposition of all life raft contingency pool assets.
 - (2) Upon receipt of an OPNAV 4790/2K, screen the request as follows:
 - (a) For replacement of lost life rafts or rafts considered to be beyond economical repair, replace with contingency pool asset. If contingency pool assets are unavailable, notify the ship to requisition replacement raft(s) using the ship's OPTAR funds.
 - (b) For repair and recertification, screen OPNAV 4790/2Ks to the respective Life Raft Regional Maintenance Center for action. Issue an immediate replacement from contingency pool assets, if available, and/or recertify within the defined schedule.
 - (c) If the Life Raft Regional Maintenance Center is temporarily overloaded and contingency assets cannot fulfill the requirements, screen the repair or recertification to a NAVSEA certified industrial activity.
 - (d) When contingency pool assets cannot support requirements, notify the Fleet Life Raft Program Manager. In cases where requirements cannot be supported due to the non-availability of materials, notify NSWCCD Detachment, Norfolk VA, for assistance. As a last option for non-deployers, notify the ship to submit a Departure From Specification per Volume V, Part I, Chapter 8 of this manual. Request the cognizant TYCOM grant a six-month extension of PMS periodicity. Subject Life raft must be recertified or replaced prior to expiration of the PMS periodicity extension.

NOTE: ASSETS MAY BE AVAILABLE AT ANOTHER FLEET CONTINGENCY POOL.

- c. Inform the Fleet Life Raft Program Manager and cognizant TYCOM (N43) of any problems encountered.

18.6.3 Regional Maintenance Center.

- a. Upon receipt of screened OPNAV 4790/2K, repair or recertify life rafts to a Level "C" Plan in accordance with references (a), (b), (c), PMS and/or Volume V of this manual, as applicable.
- b. Maintain an equipped life raft facility with qualified repair personnel to conduct repairs and/or recertification of life rafts as indicated below:

NOTE: FACILITY CAPABILITIES AND PERSONNEL QUALIFICATIONS WILL BE AUDITED BY NSWCCD AND TYCOM REPRESENTATIVES ON AN ANNUAL BASIS OR AS A SITUATION DICTATES.

- (1) A minimum of 75 percent of all personnel assigned to the life raft shop shall have received formal NSWCCD training and certification in Level "C" repair.
- (2) Conduct and document annual training and/or the level of On-the-Job Training in Level "C" repair of all shop personnel.
- (3) Appoint in writing, two life raft repair coordinators, E-6 or above, who have received formal NSWCCD training in Level "C" repair.

- (4) Appoint in writing, a signal flare coordinator, E-4 or above, who is trained in handling ordnance and is responsible for the coordination and installation of signal flares in all life rafts.
- (5) Maintain copies of all technical manuals, maintenance bulletins, correspondence and messages pertaining to life raft maintenance and repair.
- (6) Maintain accountability of signal flare kits in accordance with reference (d).

18.7 UNSERVICEABLE/REJECTED LIFE RAFTS. Fleet Maintenance Activities shall process unserviceable/rejected life rafts as follows:

- a. The Quality Assurance Officer shall verify the condition of the rejected life raft.
- b. Survey the rejected life raft in accordance with reference (a). Upon completion of the survey, turn in the carcass to the Defense Re-utilization Marketing Office in accordance with reference (e).
- c. Report survey results to NSWCCD, Detachment, Norfolk, VA.
- d. Issue a replacement life raft to the customer ship/boat/craft from the contingency pool. If none are available, the ship will requisition a new life raft using OPTAR funds.

18.8 RECORDS. Activities with the responsibilities defined in section 18.6 of this chapter shall maintain an auditable record for 5 years of all life raft transactions, including repairs, replacements, and recertification. These records must include:

- a. Copies of all ILRRRs issued for recertified life rafts.
- b. Job Sequence Numbers, serial numbers, and the manufacturer's name of each rejected life raft.
- c. The condition of the rejected life rafts.
- d. The disposition of the rejected life rafts and components salvaged.

VOLUME VI
CHAPTER 19
MAINTENANCE AND MATERIAL MANAGEMENT

REFERENCES.

- (a) NAVSEAINST 4790.8/OPNAVINST 4790.4 - Ship's Maintenance and Material Management (3-M) Manual
- (b) NAVEDTRA 43241 - Personnel Qualification Standard for Ship's Maintenance and Material Management (3-M) System

LISTING OF APPENDICES.

- A 3-M System Assessment/Evaluation Procedures
- B Format for Reporting 3-M Assessments
- C Listing of Standard Work Center Codes
- C_{1A} Standard Work Center Codes for Naval Air Force Ships (CVN-68 Class)
- C_{1B} Standard Work Center Codes for Naval Air Force Ships (CVN-78 Class)
- C₂ Standard Work Center Codes for Naval Expeditionary Combat Command
- C₃ Standard Work Center Codes for Naval Submarine Force Ships
- C₄ Standard Work Center Codes for Naval Surface Force Ships and Shore Commands
- D Listing of Standard Work Center Codes for Master Job Catalog Items Contained in Ship's CSMP (Surface and Submarine Forces only)
- E Job Originator Values
- F Sample Situational Requirement Reference Sheet

19.1 **PURPOSE.** To provide guidance for the implementation of policies for the Maintenance and Material Management (3-M) system set forth in reference (a).

19.1.1 **Policy.** To maintain high levels of Operational Readiness by ensuring that Material Readiness, which is a key component of Operational Readiness, is supported throughout the chain of command with clear and concise directives, maintenance requirements and maintenance procedures.

19.1.2 **Scope.** This chapter applies to all ships, service craft, small boats, Type Commander (TYCOM) cognizant shore activities, and non-aviation fleet test and support equipment, except as exempted in paragraph 19.1.2.b below. This includes, but is not limited to, Navy Meteorological Equipment, equipment of the Naval Air Traffic Control, Air Navigation and Landing Systems, Aviation Launch and Recovery Equipment, activities under the cognizance of Commander Naval Expeditionary Combat Command, Commander Naval Reserve Force, and Naval Personnel Development Command.

- a. Any departure from the policies, procedures or responsibilities delineated in reference (a) are not authorized without prior Naval Sea Systems Command (NAVSEA) approval and Chief of Naval Operations (CNO) concurrence.
- b. This chapter does not apply to Fleet Ballistic Missile systems under the cognizance of Strategic Systems Programs, nuclear power plants and associated test equipment under the cognizance of Naval Sea Systems Command Nuclear Propulsion Directorate (NAVSEA 08) or aeronautical equipment used in support of the aviation maintenance mission. Also excluded are civilian operated and maintained ships, small boats, and service craft, unless specifically included in a Base Operating Contract or other similar document.

19.2 SHIP MAINTENANCE AND MATERIAL MANAGEMENT.**19.2.1 Responsibilities.**

19.2.1.1 **Type Commander.** Exercises primary responsibility for the effective operation and support of the 3-M System. The areas of responsibility include but are not limited to the following as applicable:

- a. Afloat Maintenance Data System (MDS).
 - (1) Ship's Non-Tactical Automated Data Processing System (SNAP) I/II/III Organizational Maintenance Management System (OMMS).
 - (2) Optimized Ship's Non-Tactical Automated Data Processing System (Optimized SNAP) (R-Admin, R-Supply, Organizational Maintenance Management System – Next Generation (OMMS-NG)).
 - (3) Mission Readiness Assessment System.
- b. Ashore MDS.
 - (1) Maintenance Figure of Merit Family of Systems.
 - (2) Advanced Industrial Management for Regional Maintenance Centers.
 - (3) Regional Maintenance Information System (RMAIS).
 - (4) Maintenance Resource Management System.
 - (5) TRIDENT Logistical Data System.
- c. Planned Maintenance System Scheduling (SKED software).
- d. Alteration Management System.
 - (1) Navy Data Enterprise.
 - (2) Type Commander Alteration Management System.
- e. Current Ship's Maintenance Project (CSMP).
- f. Master Job Catalog (MJC).
- g. (Submarines only) Technical Feedback Report (TFBR) Screening.
- h. Maintain an Assessment Data File in accordance with Appendix A.
- i. Provide program enhancement requirements to the respective Fleet Commander via N43.

19.2.1.2 Type Commander 3-M Regional Representatives (Submarines only). TYCOM 3-M Regional Representatives have been established at all submarine homeports. These Regional Representatives provide TYCOM continuous monitoring of 3-M requirements for assigned submarines and provide assistance to Submarine Force Activities and Squadron Commanders in the operation and administration of the 3-M Program. Their areas of responsibility include but are not limited to the following:

- a. Act as team "lead" for all 3-M Assessments of activities under their cognizance and provide the results of the assessment to the ship or activity via the Immediate Superior In Command (ISIC) using the format of Appendix B.
- b. Originate all correspondence relating to 3-M Assessments, Periodic Monitoring, and reports of non-compliance with CNO WASHINGTON DC/YMS: 941107/4790.4C and COMUSFLTFORCOMINST 4790.3.
- c. Carry out the duties and responsibilities of the TYCOM during Planned Maintenance System (PMS) installations.
- d. Monitor MDS documents and report deficiencies to the ISIC for corrective action.
- e. Provide the following support to the ISIC:
 - (1) 3-M System monitoring.
 - (2) TYCOM 3-M Assist Visits as described by reference (a).
 - (3) PMS MDS technical assistance.
 - (4) On site training in PMS, MDS and PMS Scheduling (SKED software).

- (5) Assistance with the preparation and submission of TFBRs.
- (6) Assistance in obtaining prompt correction to faulty PMS documentation (liaison with In-Service Engineering Activity (ISEA)).
- (7) On a case basis, provide the authorization to use modified (red lined) PMS documentation.
- (8) (Submarines only) Review the ship's K-Maintenance Requirement Card (MRC) plan for all Continuous Maintenance Availabilities (CMAV) as discussed in Volume II, Part I, Chapter 4 of this manual. Ensure the plan is in accordance with requirements of Volume II, Part I, Chapter 4 of this manual.

19.2.1.3 Immediate Superior In Command. The ISIC shall designate a 3-M Officer in writing. The 3-M Officer is responsible for the satisfactory administration of 3-M programs, in accordance with reference (a) and this chapter, for subordinate Commands or activities. Submarine ISICs shall review the ship's K-MRC plan for all CMAVs as discussed in Volume II, Part I, Chapter 4 of this manual. Ensure the plan is in accordance with requirements of Volume II, Part I, Chapter 4 of this manual.

19.2.1.4 In-Service Engineering Activity. ISEAs are those activities designated by NAVSEA as the technical expert for specific systems and/or equipment. Naval Surface Warfare Center, Carderock Division (NSWCCD), for example, is the ISEA for the majority of Hull, Mechanical and Electrical equipment installed on most ships. ISEA responsibilities include but are not limited to the following:

- a. Development of PMS documentation to include validation of newly developed or changed procedures.
- b. Maintenance of PMS documentation.
- c. Timely responses to TFBRs.
- d. Providing copies of critical TFBR resolutions to all holders of the affected Maintenance Index Page (MIP)/MRC. All other resolutions will be integrated into the next available Force Revision.

19.2.1.5 Naval Sea Logistics Center Detachments. Responsibilities include but are not limited to the following:

- a. Maintain the Navy PMS Database.
- b. Receive, screen and process TFBRs.
- c. Resolve TFBRs within their technical capability.
- d. Develop and distribute Force Revisions as required.

19.2.1.6 Submarine Maintenance Engineering, Planning and Procurement Activity (Submarines only). Submarine Maintenance Engineering, Planning and Procurement Activity (SUBMEPP) is a NAVSEA engineering activity chartered to support NAVSEA and the submarine TYCOMs in their effort to maintain a high degree of Submarine Force Material and Operational Readiness. In support of 3-M, SUBMEPP is tasked by NAVSEA and the TYCOMs with the following:

- a. Act as the TYCOM screening activity for TFBRs submitted by Submarine Force activities.
- b. Maintain the Submarine Force Technical Feedback Report History/Tracking (TFBR H/T) Program.
- c. Establish, maintain, update and distribute all requirements as MJC Items in support of TYCOM Alteration Management System, Periodic Maintenance Requirements (PMR), Baseline Overhaul Work Packages/Selected Restricted Availability (SRA) Routines and Standard Availability Routines.
- d. Provide semi-annual analysis of Naval Sea Logistics Center (NAVSEALOGCEN) historical MJC originated data and distribute updated planning and estimating data to include changes in estimated MJC manhours.
- e. Provide semi-annual analysis of NAVSEALOGCEN historical PMR originated data and distribute updated manhour and material requirements to the PMR scheduling and Technical Repair Standards.
- f. Liaison with ISEAs and NAVSEALOGCEN detachments to ensure submarine TFBRs receive accurate and timely responses.

- g. Assist with PMS installation on all new construction submarines.

19.2.1.7 Afloat Training Group (Surface Force Ships only). Afloat Training Groups are under the technical administration of the Fleet Training Commands. They provide Surface Force platforms with the following:

- a. Conduct 3-M Assessments.
- b. Technical and personal support for 3-M training.
- c. 3-M training services as needed.

19.2.1.8 Ship's Maintenance and Material Management Coordinator/Officer. The duties and responsibilities of the Ship's Maintenance and Material Management Coordinator (3-MC)/3-M Officer are well defined in reference (a). Specifically the 3-M Coordinator/3-M Officer is the functional manager of the 3-M System and is responsible to the Executive Officer for the administrative requirements of the Ship's 3-M program. In addition to the requirements of reference (a) the following applies:

- a. Develop and administer the Ship's PMS Spot Check Program. Section II-A of Appendix A of this chapter may be used as a spot check evaluation sheet.
- b. Monitor the Ship's 3-M Personnel Qualification Standard (PQS) Program and maintain an auditable record of personnel qualified in 3-M PQS.
- c. Ensure that all Equipment Status Log/Ship's Force Work List items outstanding for more than 30 calendar days are converted to 3-M deferrals.
- d. Administer the Ship's configuration management program.
- e. (Submarines only) Review and track K-MRC completion for each division. Prior to any CMAV, the Maintenance and Material Management Coordinator (3MC) will develop a K-MRC execution plan as outlined in Volume II of this manual. The 3MC shall maintain all K-MRC history for a given monitoring period until Performance Monitoring Team (PMT) confirms receipt of all data in the monitoring period report.

19.2.1.8.1 Optimally Manned Ships. (Littoral Combat Ships (LCS) only). The Littoral Combat Ships Squadron (LCSRON) and Mission Package Support Facility (MPSF) shall have dedicated 3-MCs responsible for the effective implementation of the 3-M Program of all assigned ships. Responsibilities also include:

- a. Review, update, schedule, all PMS.
- b. Ensure Location Guide Lists are fully developed and all MRCs are assigned to the correct equipment.
- c. Maintain and update the master PMS SKED ensuring that ship and sustainment contractor data are current.
- d. Receive update files from the sustainment contractor, mission modules or sea-frames for maintenance status reporting TFBR submissions and equipment association changes.
- e. Review and analyze all exception or error reports providing corrective actions to the Regional Maintenance Center who provides the government oversight on sustainment contractor performed PMS.
- f. Initiate situational and state triggered maintenance by activating Global Events.
- g. Review and approve or reject submitted TFBRs.
- h. Perform the duties of paragraphs 19.2.1.8 and 19.2.1.9 of this chapter.

19.2.1.9 Command Maintenance Availability Coordinator/Ship's Material Maintenance Officer. The Command Maintenance Availability Coordinator/Ship's Material Maintenance Officer will be responsible for the coordination of all Fleet Maintenance Activity (FMA) repairs and coordinate closely with the 3-M Coordinator. The Command Maintenance Availability Coordinator/Ship's Material Maintenance Officer will also provide a single working level point of contact and coordinate the command's requirements with the requirements of the FMA. These duties include:

- a. Technical review of work requests submitted for FMA accomplishment.

- (1) Ensure readability and technical correctness.
 - (2) Prevent duplication of work requests for Ship Alterations/Unrestricted Operation and other MJC originated deferrals.
 - (3) (Submarine Force only) Ensure corrective maintenance described in Block 35 (Remarks) of the Ship's Maintenance Action Form OPNAV 4790/2K of reference (a) (2-Kilo) includes reference to the associated Maintenance Standard when applicable.
 - (4) Collect supplemental 2-LIMA requests for routine work (i.e., lagging, painting, label plates, tiling, etc.) from all Work Centers (WC) and prepare an integrated priority list for each type of routine work to maximize the FMA's effectiveness.
- b. Ensure Command's preparations for an FMA availability are conducted in accordance with Volume II, Part I, Chapter 4 of this manual.
 - c. Meet daily, during an availability, with the assigned Ship Superintendent to discuss the status of all active jobs.
 - d. Attend all FMA production, night work, and management meetings.
 - e. Provide a daily FMA job status to each Department Head, Division Officer, and Leading Petty Officer.
 - f. (LCS only) Provide oversight of the MDS and PMS program along with all availabilities.
 - g. (LCS only) Approve scheduled PMS and work candidates as the Department Head when LCSRON/MPSF N-4 is not available.
 - h. (Submarines only) Prior to Work Package Execution Review, meet with the PMT, TYCOM 3M representative and ISIC together (typically at A-40) to review current K-MRC status, ensure the ship's records match that of PMT and develop a K-MRC execution plan.

19.2.2 Qualifications. All personnel assigned to billets associated with the 3-M system must be 3-M PQS qualified for the assigned billet in accordance with reference (b).

19.2.3 Maintenance and Material Management Operation and Administration.

19.2.3.1 Standard Force Work Center Numbering System. The production of automated products in support of the 3-M system, as well as the various Maintenance Automated Information Systems, dictate that a standard force WC organization be maintained. Commanding Officers shall designate their Command organization and applicable WC codes as listed in Appendix C of this chapter. Additionally:

- a. Commands shall not allow the use of any WC codes not authorized by reference (a) or this manual.
- b. Requests to change WC designation codes will not be approved unless they are applicable to all ships of a class and supported by detailed justification. This does not affect the re-assignment of a MIP to another WC (shift of maintenance responsibility). Reference (a) provides guidance for the shift of maintenance responsibility.
- c. (Submarine Force only) Small boat, tug, receiver, and service craft managers will use the specific WCs identified in Appendix C3 of this chapter for MDS documentation, however, for PMS management they may assign a "***00" WC to consolidate PFRs, MIPs, scheduling, etc., (e.g., PY30 through PY84 may consolidate PMS under WC PY00, or PY01-Mechanical, PY02-Electrical, etc.). The Unit Identification Code will be that of the parent command.
- d. (Surface and Submarine Forces only) Standard MJC assigned WC codes are reflected in Appendix D of this chapter.

19.2.3.2 Job Control Number. The Job Control Number (JCN) is the key identifier for maintenance actions and related supply documents. The JCN is used to identify the maintenance action and to relate all of the parts used when a ship reports a maintenance action and it links all associated reporting of a maintenance action. The JCN is comprised of three blocks as defined by the Ship's 3-M manual. Block 1 is the Ship's Unit Identification Code (5 numeric characters), Block 2 is the WC (4 alphanumeric characters, left justified) and Block 3 is the Job Sequence Number (JSN) (usually 4 numeric characters).

19.2.3.3 Job Sequence Number. The first position of the JSN is used to identify the tool or organization that created the 2-Kilo. In the case of activities other than the ship creating jobs for the ship, this first character of the JSN will be an "ALPHA" character. The control over which organizations/tools "OWN" which "ALPHA" character(s) is provided by the Job Originator Values, Appendix E of this chapter, developed within the Maintenance and Modernization Business Unit and is available through the NAVSEALOGCEN website under Maintenance and Modernization Business Unit look up tables. The specific value contained within the first position of the JSN provides enhanced data mining capabilities and facilitates data aggregation and analysis.

19.2.3.4 Scheduling. PMS is a portion of the Command's 3-M program that provides, in one authoritative system, the scheduling information and technical procedures governing planned maintenance. PMS provides a simple method for scheduling, and documenting the execution of planned maintenance procedures. Fleet policy is as follows:

NOTE: WHERE THE GOAL OF 100% ACCOMPLISHMENT CANNOT BE REACHED, THE UNIT'S CHAIN OF COMMAND SHALL BE KEPT INFORMED OF THE CIRCUMSTANCES WHICH PREVENT ACCOMPLISHMENT OF SCHEDULED MAINTENANCE.

- a. (Submarine Force only) An asterisk (*) will be inserted in SKED against any Maintenance Requirement (MR) which is a "Safety of Ship" item. A "Safety of Ship Item" is defined as any maintenance action vital to the maintenance of a submarine's watertight integrity or its ability to return safely to the surface. "Safety of Ship" MRs, so designated by the cognizant technical authority, are annotated on the MIP with a single asterisk (*) in the periodicity code column. Commanding Officer notification is required for non-accomplishment of any "Safety of Ship" designated MR.
- b. Situational reference sheets will be maintained/posted in the WC PMS Manual. These sheets will contain a brief description of the situation and the maintenance action for all situational requirements listed in the right hand column of the weekly schedule. Appendix F of this chapter provides a typical situational reference sheet.
- c. Situational maintenance scheduling shall be managed utilizing the tools provided by the computer based PMS scheduling software employed by the activity. All event driven situational requirements shall be "triggered" when required and performed per reference (a).
- d. (LCS/DDG 1000 only) A plus sign (+) denotes PMS to be performed by the sustainment contractor or other Maintenance Personnel not assigned to Ship's Force.

19.2.3.5 Execution. MRC accomplishment is critical for maintaining equipment in a ready state and achieving expected service life. The maintenance tasks directed by MRCs are the minimum standards for organizational (shipboard) preventative maintenance and therefore equipment degradation can be assumed if maintenance is deferred. The following provisions are provided to maximize on time performance of PMS and provide increased Fleet latitude in maintaining equipment.

- a. MRC accomplishment shall be as directed by reference (a). MRCs are prepared as instructions to complete a maintenance task based upon the premise that the personnel assigned to perform the task has sufficient knowledge of the rate listed on the card, and is qualified to perform maintenance as directed by the MRC. The MRC shall be accomplished in sequential order, adhering to all warnings, cautions and notes. Routine sub-steps (e.g., fastener removal, steps to don and remove Personnel Protective Equipment (PPE), turning on a vacuum) may or may not be included in the MRC and their absence should not prevent the maintainer from completing the maintenance task. If a step is missing that is necessary to complete the task, and is not obvious to the maintenance person, a TFBR should be submitted.
- b. MRC completion status is dependent on the accomplishment of all procedural steps on all of the equipment listed on the MRC or its accompanying Equipment Guide List (EGL) or items listed on the Location Guide List section of the MRC.
- c. The performance of additional rational actions during the accomplishment of an MRC is authorized. Examples of such actions include turning on and off items utilized during the performance of the MRC (Vacuum cleaners, test equipment, etc.) and general housekeeping (cleaning up or containing spilled fluids or dirt) as experiences gained from prior accomplishments warrant and in no way detracts from the accomplishment status.

- d. The substitution of any tools, materials or test equipment not held by the activity should be considered prior to deciding to defer the maintenance until the exact tools, materials or test equipment listed on the MRC are procured. This is especially critical for frequently required maintenance where several performance cycles can be missed while waiting for supply to provide the correct items. Substitution requirements are provided by reference (a) and other technical documents.

19.2.3.6 Accountability. The credibility of the Navy PMS program relies heavily on the individual accomplishing the maintenance. The required dedication and integrity of that individual cannot be overstressed. To maintain accountability, personnel are required to sign for the completion of assigned maintenance in an Accountability Log. The Work Center Supervisor (WCS) is required to review and sign the Accountability Log weekly to verify the accuracy and completeness of entries. Accountability sheets will be maintained in the WC PMS Manual for a period of not less than 13 weeks.

19.2.4 Preventive Maintenance Feedback Reports. The PMS Feedback Report (FBR) is used to notify NAVSEALOGCEN Det Norfolk/San Diego of matters related to PMS, and the FBR may be screened by the TYCOM. Feedback forms are used to report problems and also to request PMS coverage for newly installed systems or equipment. While a request for PMS coverage will provide initial PMS coverage and changes, submission of an OPNAV 4790/CK form is required to initiate the rest of the logistic support change process in accordance with reference (a). All SKED users shall submit FBRs via SKED. Non-SKED users may submit FBRs via the Planned Maintenance System Management Information System (PMSMIS) website at <https://algol.seajax.navy.mil/pmsmis> by selecting the Feedback tab and Feedback Wizard. Non-SKED users accessing this website for the first time will need to request an account. Click on File Manager and select New User Account Request. This displays options to select a form and readme file, which can be downloaded, filled out and sent via e-mail as directed in the readme file. An e-mail will be sent to you confirming your account and providing access to the main screen.

19.2.4.1 Technical Feedback Report Reporting (Submarine Force only). Submarines transmit TFBRs to their parent 3M Representative on navy.smil.mil via SIPERNET (3M Coordinators should be aware of the default SEAJAX email address that is programmed into SKED. They should ensure that TFBRs are emailed via SIPERNET to the parent 3M Representative in their homeport). The TFBR H/T Program is a database that contains summary information taken from TFBRs initiated by COMSUBLANT/COMSUBPAC units and support activities.

19.2.4.2 Preventive Maintenance System Feedback Reports. The PMS FBR (OPNAV form 4790.7B) is used specifically to notify the NAVSEALOGCEN of matters related to PMS.

- a. While the FBR will provide initial PMS coverage and changes, submission of an OPNAV 4790/CK form is required to report configuration changes and changes in logistic support.
- b. Automated forms for FBR submission may be transmitted electronically using:
 - (1) SKED Feedback Report Wizard (preferred).
 - (2) PMS Management Information System website identified in paragraph 19.2.4 of this chapter.
 - (3) Anchor Desk website.

19.2.4.3 Feedback Report Types. There are three types of FBRs: Category A, Category B and Urgent.

- a. Category A - non-technical in nature and intended to meet PMS needs which do not require technical review, including changes in WCs. Category A FBRs are submitted to request classified or other PMS documentation, which cannot be obtained locally.
- b. Category B - technical in nature and are used to report technical discrepancies inhibiting PMS performance or shift of maintenance responsibilities.
- c. Urgent - reason for submission involves safety of personnel, ship or potential for damage to equipment and relates to the technical requirements of PMS. Urgent FBRs will be forwarded by naval message, containing a PMS Feedback Serial Number, to NAVSEALOGCEN with info to the cognizant System Command, Bureau of Medicine and Surgery, Naval Safety Center and TYCOM. The message shall describe the unsafe procedures or conditions and identify the specific MIP/MRC involved.

19.2.4.4 Feedback Report Screening. The ship's 3-MC is responsible to screen all FBRs and serialize and forward within four days of receipt.

- a. The 3-MC shall maintain accountability for all PMS FBRs submitted and actions taken until corrected PMS documentation is received.
- b. The 3-MC shall also ensure that the originator and all applicable WCs are kept apprised of action taken and ensure the originating and other applicable WC Supervisors implement the changes or corrections when received.
 - (1) NAVSEALOGCEN is responsible to provide expeditious resolution to all FBRs whenever possible.
 - (2) Where resolution by NAVSEALOGCEN is not possible, the FBR will be electronically forwarded to the cognizant Technical Review Activity for resolution.

19.2.4.5 Preventive Maintenance System Technical Feedback Reports. TFBRs are specifically used for reporting technical deficiencies or errors in PMS documents. Technical PMS discrepancies that could have a detrimental effect on personnel safety, safety of ship or could result in significant equipment damage are classified as “Urgent”. All other TFBRs are classified as “Routine”.

19.2.4.6 Preventive Maintenance System Coordinating Activities. The central control points for processing TFBRs are the Preventive Maintenance System Coordinating Activities (PMSCA). Depending on the type and level of technical authority necessary to answer the TFBR, PMSCAs will either respond to the originator with a resolution or forward the TFBR to the appropriate NAVSEA technical authority for action.

19.2.4.7 In-Service Engineering Activities. ISEAs are those activities designated by NAVSEA as the technical experts for specific systems and/or equipment. NSWCCD is the ISEA for the majority of Hull, Mechanical and Electrical equipment installed on most ships, outside of Nuclear cognizant areas.

19.2.4.8 Action Activities. Design Activities, ISEAs or other activities under the direction of NAVSEA or other System Commands holding technical authority for systems and equipment take all appropriate action on TFBRs under their cognizance and forward the response to the PMSCAs. The PMSCAs will record the TFBR result in the system and provide the final response to the originator.

19.2.4.9 Urgent Technical Feedback Reports.

- a. Urgent TFBRs are those feedbacks reporting technical discrepancies that can result in personnel injury, risk to the safety of the ship or significant equipment damage.
- b. PMSCAs shall provide a message response to all Urgent TFBRs within one (1) working day of receipt. If the TFBR is forwarded to a Design Activity or ISEA for resolution, then the Design Activity or ISEA shall provide a message response to all Urgent TFBRs informing the originator of specific actions and/or required changes that will result from the TFBR evaluation within one (1) working day of receipt. This message response shall be addressed to the originator and distributed to TYCOMs. TYCOMs will forward this message to all commands that could be affected by PMS change. The Urgent TFBR response message may recommend pen and ink changes to the affected PMS requirement.
- c. PMSCAs shall distribute revised PMS documentation to all affected users within 30 calendar days from receipt, via special issue or Advance Change Notice.

19.2.4.10 Routine Technical Feedback Reports.

- a. PMSCAs shall perform technical review, research and provide a response to routine TFBRs where resolution does not require technical authority action.
- b. TFBRs that PMSCAs cannot resolve will be sent to the cognizant Design Activity or ISEA. The cognizant Design Activity or ISEA will provide the response to the appropriate PMSCA describing the action taken. The PMSCAs will provide the response to the originator by electronic means.
- c. Distribution of the revised MRC to the originator and other affected users will be accomplished via Advanced Change Notices or the next Force Revision.
- d. NAVSEA has established a goal of providing answers to TFBRs in one day. While it is realized that some TFBRs will require more extensive research, the majority of TFBRs received can and should be answered in one day.

- e. If no revision to PMS documentation is required, pertinent comments will be provided in the response to the appropriate PMSCA. When not concurring with the feedback report, the rationale for the non-concurrence must be provided to the appropriate PMSCA.

19.2.4.11 Type Commander Screening of Technical Feedback Reports. SUBMEPP has been designated by Commander Submarine Force as the TYCOM screening activity for all Submarine Force Activities. TFBRs are accessible via the PMS Management Information System prior to delivery to the NAVSEALOGCEN. Naval Surface Forces TFBRs will be reviewed in accordance with Type Commander direction and SUBMEPP will review Submarine Force proposed TFBRs. The reviewer will:

- a. Return the TFBR to the originator under any one or all of the following circumstances:
 - (1) An answer currently recorded in the TFBR H/T Program satisfies the proposed TFBR. The TFBR will be returned with authorization to implement the previously received response or rationale for non-concurrence.
 - (2) A similar request has already been submitted and submission of another duplicative request will add no value to the process.
 - (3) The TFBR requests actions contrary to the direction of this manual or reference (a).
 - (4) The request does not adequately address or identify the problem. In cases of this nature, return of the TFBR to the originator. For Submarine Force only, this will be a last resort, as SUBMEPP will attempt to contact the originator to better define the issue.
- b. Forward the TFBR for further processing taking any one or a combination of the following actions:
 - (1) Provide amplifying information.
 - (2) Correct erroneous data.
 - (3) Provide TYCOM concurrence of the requested change.
 - (4) Provide a Do Not Concur recommendation to NAVSEALOGCEN/ISEA.

19.2.5 Submarine Safety/Scope of Certification/Survivability and Escape (Submarine Force only).

- a. MRCs which direct work/entry within the Submarine Safety (SUBSAFE) Certification Boundary, require Re-Entry Controls to be invoked. In order to ensure that these controls are initiated, Ship's Force personnel shall over stamp those MRCs requiring such work/entry with the word "SUBSAFE" in red ink. New PMS MRC editing programs are being developed where watermarking of MRCs will begin to show up on published PMS MRCs. If a "SUBSAFE" MRC has a "SUBSAFE" watermark, over stamping in red ink as described above is not required.
- b. MRCs which direct work/entry within the Scope of Certification (SOC) Certification Boundary, also require Re-Entry controls to be invoked. SOC documentation is applicable and governing to Dry Deck Shelter (DDS) host platforms and must be loaded to Work Center WK02 for those platforms. SOC MRCs are annotated on the MIP with either an "X" or an "R" in the "OTHER" column. Non-DDS platforms need not establish WK02 nor are they governed by SOC directives.
- c. Survivability and Escape Equipment and supporting maintenance has come under increased scrutiny since the loss of the Russian submarine KURSK. All MIPs and associated MRCs dealing with Survivability and Escape equipment are to be loaded to Work Centers (WC) in accordance with Table 19-1.

Table 19-1

MIP	SYSTEM	REQUIRED WC
5940/908	SEIE, Escape Trunk	EA01 (SSN 688 Class)
5940/906	SEIE, Escape Trunk	EA01 (SSBN/SSGN 726 Class)

Table 19-1

MIP	SYSTEM	REQUIRED WC
5940/905	SEIE, Escape Trunk SCV and HIS Valves	EA01 and WK02 (SSN 774 Class, SOF)
5940/904	SEIE, Escape Trunk	EA01 (SSN 774 Class, non-SOF)
5940/901	SEIE, Escape Trunk	EA01 (SSN 21 Class)
5940/007	Backup Oxygen Redistribution System	EA01 (SSBN/SSGN 726 Class)
5940/006	ExtendAir	EA01
5940/005	SEIE and Crash Bags	WK01 (WF01 for SSN 774 Class)
5940/004	Helicopter Transfer Kit	WK01 (WQ01 for SSN 774 Class)
5940/003	MROD	RL01 (SSBN/GN 726 Class and 21 Class only)
5940/002	Atmospheric Sampling SUB MKIIP (ANALOX)	NE01
5940/001	LiOH Curtain	EA01
4413/015	SEPIRB	OC01
5882/021	Helicopter Transfer Kit	WK01 (WQ01 for SSN 774 Class)

19.2.6 Evaluation.

19.2.6.1 Assessments.

- a. Goal/Intent. To ensure that the Command's 3-M program is functioning at maximum efficiency and per the requirements of reference (a) and this chapter. The CNO Maintenance Availability should be counted when determining when these inspections are to be done. Evaluations shall be conducted on a not to exceed normal Fleet Response Plan cycle or more frequently when deemed necessary by either the TYCOM, ISIC (Command exercising administrative control) or the unit's Commanding Officer. 3-M assessments for each unit can be scheduled without advanced notice and shall be conducted in accordance with the criteria and format established in Appendix A of this chapter. The TYCOM shall ensure that each activity shall evaluate all departments performing PMS at least once every Fleet Response Plan cycle.
- b. Method for Assignment of Numerical Evaluations. Planned maintenance is the foundation of a well executed, effective maintenance program. Therefore PMS must be vigorously prosecuted and thoroughly monitored. The standards of PMS performance must remain high. The minimum performance requirements are identified below. TYCOMs may authorize the utilization of specific check sheets to reflect current directives and system operation modernization provided that attributes provided by Appendix A of this chapter are properly evaluated when applicable.
 - (1) 3-M Assessment Command Total Score - (Percentage).

- (2) 3-M Assessment - Above Standards (90% or greater)/At Standards (80-89.99%)/Below Standards (less than 80%).

19.2.6.2 Assessment Reporting. Significant deficiencies and numerical assessments are reported to the assessed unit's Commanding Officer, ISIC and TYCOM using the format shown in Appendix B of this chapter. Reporting may be accomplished on the entire unit or on a departmental basis.

- a. Significant deficiencies require a report of corrective actions taken by the unit to be forwarded to the TYCOM via the ISIC within 30 days following the assessment.
- b. Any department receiving an overall evaluation of below standard in either PMS or MDS shall be re-evaluated within a reasonable period of time, not to exceed six months, to ensure below standard areas have been corrected.
- c. Each TYCOM shall report the findings of the previous year's assessments to COMPACFLT/USFF N43 at the end of the calendar year.
- d. Annually, the United States Fleet Forces Command (USFFC N43) will convene a conference with Commander, Pacific Fleet and all TYCOMs to review the previous year's 3-M Assessment trends, concerns and future direction.

(This Page Intentionally Left Blank)

APPENDIX A

3-M SYSTEM ASSESSMENT/EVALUATION PROCEDURES

1. The purpose of this Appendix is to provide a standard means for evaluating the 3-M programs aboard ship and shore commands. These procedures are used to conduct 3-M Assessments.
2. The ISIC shall conduct a complete assessment of each command under their cognizance, not to exceed 24 months. If a command is going to exceed the 24 month periodicity, the ISIC shall submit a message request for extension to the Type Commander. The Type Commander, when replying to the request for extension, shall include Commander, United States Fleet Forces Command (CUSFFC) N43 or Commander Pacific Fleet N43 (as applicable) as an information addressee. Only the Type Commander can authorize such an extension.
3. 3-M Assessments may be conducted without advanced notice. Time spent in major CNO Maintenance Availabilities should be counted in determining when these inspections are to be done. However, the availability of maintenance data subject to review shall be considered prior to scheduling the assessment. An assessment data file will be maintained for each unit in a Type Commander's tracking database. As each command is evaluated, the individual evaluation standard identified in paragraphs below and calculated values will be recorded in the data base and a copy of the assessment report will be provided to the command. Sections I through VI of this Appendix provide the specific criteria to be used in the assessment of each command.
4. The 3-M assessment procedures are divided into six major areas:
 - a. Section I - Assessment of Administration Effectiveness Review (AER).
 - b. Section II - Assessment of Accomplishment Confidence Factor (ACF) (Spot Checks).
 - c. Section III - Assessment of CSMP Validity Factor (CVF).
 - d. Section IV - Assessment of Recorded Accomplishment Rate (RAR) or PMS Accomplishment Rate (PAR).
 - e. Section V - Executive Effectiveness Review (EER).
 - f. Section VI - 3-M Assessment Command Total Score.
5. The following evaluation criteria will be used:
 - a. Commands/Departments will be evaluated as "Above Standards" overall in 3-M if the ship's total score is 90% or higher.
 - b. Commands/Departments will be evaluated as "At Standards" overall in 3-M if the ship's total score is between 80% and 89.99%.
 - c. Commands/Departments will be evaluated as "Below Standards" overall in 3-M if the ship's total score is less than 80%.
6. All calculations shall be rounded to two decimal places.
7. All calculations of the individual Work Center's contribution to a Department's and Command's total score is weighted based on the amount of PMS scheduled. This is to ensure the grades assigned are commensurate with the level of effort required between Work Centers. This weighting of scores is automatically calculated by inputting PMS actions derived from SKED into the individual Work Center's Performance Evaluation Database.

(This Page Intentionally Left Blank)

APPENDIX A

SECTION I

ASSESSMENT OF ADMINISTRATION EFFECTIVENESS REVIEW (AER)

1. Complete the administrative review checklist for each Work Center per Section I-A of this Appendix. Enter a numeric evaluation of each assessment attribute and provide amplifying information to describe the deficiencies driving point deductions on the "Remarks" page provided. Significant deficiencies shall be reported via the final assessment report.

(This Page Intentionally Left Blank)

APPENDIX A

SECTION I-A

ADMINISTRATION EFFECTIVENESS REVIEW (AER)

Ship	Department	Division	Work Center	Date
General				
Assessment Attribute			Value	Grade
1.	Does the Work Center PMS file contain:			
	a.	A correction sheet that indicates all changes? (e.g., FR, ACN, TFBR response)		1
	b.	Supplementary information (e.g., current and applicable 3-M messages and notices)?		1
	c.	Current List of Effective Pages (LOEP)? (Verify Force Revision number.)		1
	d.	All Maintenance Index Pages (MIPs) current? (Verify MIP control numbers against the LOEP and against SKED.)		1
	e.	Current Service Brief? (Electronic or printed.)		1
2.		Are all pen and ink changes on the LOEP and MIPs (except where allowed by management aids) annotated with the reference for the change (TFBR serial, Document Input Transmittal serial, etc.) and properly noted by the correct authority?		5
3.		Are any applicable MRCs incorrectly lined out or not lined out on MIPs? Do all related maintenance and safety of ship references match the MIPs? (Was all maintenance scheduled correctly?)		10
4.		Does the Work Center retain an auditable record of personnel PMS qualifications and designation letters?		3
5.		Does the Work Center retain an auditable record of personnel qualified to perform maintenance within controlled work boundaries (QA PQS 301 Craftsman)?		3
Maintenance Requirement Card (MRC) Deck				
6.		Is the work center deck of MRCs, including classified MRC locator cards, complete and current (verify syscom MRC control number against MIPs) per the 3-M Manual/TYCOM Guidance?		2
7.		Are classified MRCs complete and current?		5
8.		Are blanks requiring Ship's Force data filled in prior to use?		3
Equipment Guide Lists (EGL)				
9.		Are EGLs entered in SKED for all applicable equipment?		5
10.		Are EGLs current and a paper copy attached to the parent MRC, if printed? (verify MRC control number against MRC).		3
11.		Are EGLs properly filled out (e.g., equipment name, equipment location, equipment unique identifier)?		2
12.		Are separate EGLs prepared for items that require more than one days worth of work?		1
Situational Requirements				
13.		Do the situational requirements listing reflect the most current force revision? (List is available on PMS CD under R-Check header.)		2
14.		Do the situational requirements listing reflect the current status of the Work Center MIPs? (Line outs on MIP transferred to the situational requirements listing.) Are lineouts initialed by the WCS?		3

Assessment Attribute		Value	Grade
Situational Requirements (Cont'd)			
15	Does the R-Check event manager reflect situational maintenance properly entered?	3	
16	Are situational events being triggered in SKED when applicable?	5	
PMS Execution & Accountability			
17	Have completed log sheets been reviewed by the Work Center Supervisor and Division Officer?	3	
18	Was maintenance assigned only to qualified maintenance personnel for MRCs requiring unique qualifications/NECs?	5	
19	Is all applicable information entered (e.g., maintenance person assigned, maintenance person signature, date completed)?	2	
20	Are 13 week accountability logs retained for the current week and 13 previous weeks?	3	
21	Is the responsible maintenance person listed on the logs signing for completion of the maintenance action?	2	
22	If multiple maintenance persons are assigned, is the petty officer in charge or the most senior person signing for completion of the maintenance action?	2	
23	Was the maintenance (e.g., currently scheduled, previously completed, situational requirements and unscheduled maintenance added) on the accountability logs entered into SKED?	10	
24	Is a flip page entry made for items not completed during the week?	2	
25	Were deferred MRCs within periodicity placed into the Reschedule column and carried over into the next quarter?	5	
26	Is a unique SOMS identifier/tagout serial number or N/A entered in the tagout block?	2	
27	Is any means being used to identify mandatory related maintenance items with their parent PMs on the accountability logs to ensure that the maintenance person completes all related maintenance items at the same time?	5	
Feedback Report File (N/A for Commands utilizing SKED to manage)			
28	Does the Work Center retain one year of feedback accountability logs?	2	
29	Does the Work Center retain copies of outstanding (unresolved) Work Center FBRs?	3	
Inactive Equipment Maintenance (IEM)			
30	Is the start of IEM correctly annotated (including IEM status II having a valid reason entered)?	2	
31	Are all IEM requirements properly scheduled (e.g., LU, PM, SU, OT)?	5	
32	Is the completion of the inactive period correctly annotated?	2	
End of quarter reports (if applicable)			
33	Does the end of quarter reports (4 quarters) contain:		
	a. The PMS Performance Report.	2	
	b. The Flip Page Report.	2	
	c. The Quarterly (Submarine Force only).	2	

Assessment Attribute		Value	Grade
End of quarter reports (if applicable) (Cont'd)			
34	Are end of quarter reports reviewed, signed and dated by the COC (indicating awareness of incomplete or unaccomplished maintenance requirements)? Are previous periods archived in SKED following close-out by Dept Head and 3MC?	5	
Totals (Attributes evaluated as N/A are not calculated)		Total Points Available	Total Points Awarded
Administrative Effectiveness Review (AER) (Grade = Points Awarded/Points Available)			
<input type="checkbox"/> <u>Above Standards</u> <input type="checkbox"/> <u>At Standards</u> <input type="checkbox"/> <u>Below Standards</u>			

Above Standards (90% or greater)/At Standards (80-89.99%)/Below Standards (less than 80%)

(This Page Intentionally Left Blank)

APPENDIX A

SECTION II

ASSESSMENT OF ACCOMPLISHMENT CONFIDENCE FACTOR (ACF)

1. Using the basic definitions and guidelines described, determine the PMS Accomplishment Confidence Factor (ACF) for each Work Center. Enter the values determined on the Spot Check Monitor Form, Section II-A of this Appendix.
 - a. Using SKED, randomly select MRCs that have been recently recorded as accomplished (within the past 13 weeks) until at least 2% of the total number of MRCs scheduled have been selected.
 - b. Complete an MRC Evaluation/Spot Check Sheet, Section II-A of this Appendix, for each MRC selected. Based on the results, evaluate the overall effectiveness of the accomplishment of each MR selected. Enter a numeric evaluation of each assessment attribute and provide amplifying information to describe the deficiencies driving point deductions. Significant deficiencies shall be reported via the final assessment report.

2. The Accomplishment Confidence Factor (Spot Check) Check Sheet is a series of inspection attributes to determine the accomplishment status of an MRC that had previously been reported as accomplished. Although the sheet may be used as a reference for conducting a real time monitored MRC as described by reference (a), paragraph 2-8.b., for the purposes of conducting a 3M Inspection or Self Assessment to determine ACF, all spot checks will be conducted on accomplished (historic) MRCs.

NOTE: DUE TO THE NATURE OF MRC COMPLETION, SUPPORTING PROGRAMS SUCH AS TAG OUTS AND HAZARDOUS MATERIAL (HAZMAT) ARE ENCOUNTERED. CARE SHOULD BE TAKEN TO AVOID EXPANDING THE SPOT CHECK TO A REVIEW OF THE PROCESSES OF THOSE PROGRAMS THEREBY PREVENTING THE ASSESSOR FROM DETERMINING THE ACCOMPLISHMENT STATUS OF THE MRC.

3. The following is expanded guidance for completion of the assessment attributes of the Spot Check sheet. Best practices or other policies not supported by source documentation shall not be included in evaluating compliance:
 - a. (1.a) Determine if the maintenance person is qualified to perform the maintenance task. PQS 301 is required for all MRCs but attention should also be paid to other qualifications required such as Quality Maintenance (see Volume 5, Part I, Chapter 3, paragraph 3.4 of this manual) or graduation from a required school such as gage calibration technician.
 - b. (1.b) Determine if the correct Tools, Material, Parts and Test Equipment (TMPTE) were used during the performance of the MRC when accomplished. If the maintenance person did not have the required TMPTE, it is unlikely that he/she would have been able to complete all the procedural steps of the MRC as required. If an item of TMPTE was required to perform a conditional step and that step was not required to be accomplished, it is not considered deficient. If the required test equipment required calibration, ensure that the calibration is within date and of sufficient scale to accomplish the MRC.
 - c. (1.c) Determine if the maintenance person maintained the correct equipment.
 - d. (1.d) Examine the MRC to determine that any locally applied changes are authorized by procedural notes, external correspondence, or allowed by reference (a).
 - e. (1.e) Determine applicability of the MRC to the component that the maintenance person signed for completion.
 - f. (2.a) From a variety of potential techniques, determine if the maintenance person performed all the required steps of the MRC. This may be accomplished via re-enactment, a discussion regarding the steps or re-performance. The inspector should come away with a clear impression that all the steps of the MRC were fully accomplished or not.

NOTE: IF A PROCEDURAL STEP WAS NOT COMPLETED, THE MRC SHOULD NOT HAVE BEEN REPORTED AS COMPLETE AND THEREFORE THE ATTRIBUTE GRADE SHOULD BE ZERO AND ALL SUBSEQUENT ATTRIBUTES SHOULD ALSO BE ZERO, THEREBY EFFECTIVELY “FAILING” THE SPOT CHECK.

- g. (2.b) If required by the MRC, verify that a tag out was hung on the day the maintenance was performed. Ensure the isolation boundaries were appropriately identified and correctly positioned to ensure complete isolation of the maintained equipment. If no Tag Out was required, write NA on the sheet.

NOTE: IF A REQUIRED TAG OUT WAS NOT CONDUCTED IN SUPPORT OF ACCOMPLISHING THE MRC, THE MRC SHOULD NOT HAVE BEEN CONDUCTED AND REPRESENTS A SERIOUS SAFETY VIOLATION AND THEREFORE THE ATTRIBUTE GRADE SHOULD BE ZERO AND ALL SUBSEQUENT ATTRIBUTES SHOULD ALSO BE ZERO, THEREBY EFFECTIVELY “FAILING” THE SPOT CHECK.

- h. (2.c) Determine compliance with all specific safety precautions listed on the MRC. If no safety requirements were invoked, write NA on the sheet.

NOTE: FAILURE TO ADHERE TO A SAFETY PRECAUTION PROVIDED ON THE MRC CONSTITUTES A SERIOUS SAFETY VIOLATION AND THE FAILURE TO PERFORM THE MRC AS WRITTEN. THE ATTRIBUTE GRADE SHOULD BE ZERO AND ALL SUBSEQUENT ATTRIBUTES SHOULD ALSO BE ZERO, THEREBY EFFECTIVELY “FAILING” THE SPOT CHECK.

- i. (2.d) From the Equipment Guide List (EGL) or TYCOM approved list of equipment represented by the accomplished MRC, determine if the MRC was accomplished on each piece of equipment reported. If the MRC did not have an associated EGL or TYCOM approved listing, write NA on the sheet.

NOTE: A REPORT OF COMPLETION FOR A GROUP OF EQUIPMENT LISTED ON AN EGL OR TYCOM APPROVED LISTING REPRESENTS THAT ALL LISTED EQUIPMENT WAS MAINTAINED. IF THE ENTIRE LIST OF EQUIPMENT WAS NOT MAINTAINED, THE MRC SHOULD NOT HAVE BEEN MARKED AS COMPLETE AND THEREFORE THE ATTRIBUTE GRADE SHOULD BE ZERO AND ALL SUBSEQUENT ATTRIBUTES SHOULD ALSO BE ZERO, THEREBY EFFECTIVELY “FAILING” THE SPOT CHECK.

- j. (3.a) By physical examination of the maintained equipment, determine if maintenance of the nature required by the MRC had been performed. Take note of fasteners that would have had to be disturbed, dirt in filters, fresh oil, etc. to make a judgment as to whether or not the maintenance has been performed. If unable to make this determination with absolute certainty, write NA on the sheet.

- k. (3.b) Determine through questioning and record verification that HAZMAT was properly used and disposed of as a means of determining whether or not the MRC was accomplished. Once the inspector has determined that the HAZMAT was used and disposed of correctly, this attribute is considered fulfilled. If no HAZMAT was required to be utilized, write NA on the sheet.

NOTE DUE TO THE POTENTIAL LIABILITY INCURRED BY IMPROPER USE AND DISPOSAL OF HAZMAT, SOME WORK CENTERS HAVE ASSIGNED SPECIALLY TRAINED PERSONNEL THAT PROVIDE HAZMAT AND DISPOSE OF SURPLUS MATERIAL INSTEAD OF THE MAINTENANCE PERSON. THIS IS ACCEPTABLE PROVIDED THE INSPECTOR CAN DETERMINE FULL COMPLIANCE.

- l. (3.c) Determine if the maintenance person could have performed the MRC from a standpoint of being trained and proficient in the tasks called out for by the procedure.
- m. (4.a) Determine if the maintenance person filled out the 13 Week Accountability sheet correctly for the accomplished MRC. Ensure that if a tag out isolation was used, the tag serial number is recorded in the space allowed. Ensure that the printed name and legal signature of the maintenance person who actually performed the maintenance is recorded or, in case of group performed PMS, the Petty Officer in charge of the group.

- n. (4.b) From reviewing the discussions and findings during the course of the spot check, determine if a TFBR had been submitted if required. If no TFBR was required, write NA on the sheet.
 - o. (4.c) Determine if a material deficiency was noted during the PMS; if so, examine the CSMP to ensure the deficiency was documented. If no material deficiency was noted, write NA on the sheet.
4. Due to the potential issues that are raised when a spot check is determined to be below standards, care should be taken to clearly identify contributing deficiencies that led to the conclusion that the MRC was not conducted as written or not conducted at all so that the command undergoing inspection can properly conduct root cause analysis for formulating effective correction action.

APPENDIX A
SECTION II-A

ACCOMPLISHMENT CONFIDENCE FACTOR (SPOT CHECKS) CHECK SHEET - ACF

Ship	Department	Division/Equipment	Work Center	Date Performed	MRC Evaluated	MIP Evaluated
USS						
General						
*If attributes 1.a or 2 are evaluated as unsatisfactory, all subsequent attributes shall be graded as "0".						
Assessment Attribute				Value	Grade	Notes
1.	Contact the maintenance person assigned responsibility for the accomplishment of the MRC, have the individual deliver MRC (and EGL if applicable), and determine the following by questions and/or personal observation.					
*	a.	Is the maintenance person PQS qualified to perform the MR?	2			
	b.	Presented the correct tools, Personal Protective Equipment (PPE) parts (NSN), material (Military Specification (MILSPEC)) and test equipment (Calibrated).	3			
	c.	Properly identified the equipment (location, equipment validation).	4			
	d.	Are there any unauthorized changes or corrections to the MRC?	3			
	e.	Is this the correct MRC for the equipment maintained?	3			
2.* Demonstrated all steps of MR including all notes, warnings and cautions according to the MRC.						
*	a.	Followed all steps of the MRC.	5			
*	b.	Correctly performed equipment Tagout.	5			
*	c.	Followed all safety precautions.	5			
*	d.	If an EGL is used, was the MRC performed on all equipment?	5			
3. Does the equipment condition reflect accomplishment of the MRC?						
	a.	Is it apparent that maintenance was performed recently?	10			
	b.	Correctly demonstrated use and disposal of Hazardous Material.	3			
	c.	Was the MRC within the capability of the assigned individual to perform as written?	5			
4. PMS Reporting						
	a.	Maintenance person reports status of MR to the WCS if Completed or Not Fully Accomplished and makes appropriate updates.	2			
	b.	Work Center generates TFBR for any problem with MRC.	2			
	c.	Were material deficiencies detected by the PMS action and recorded in MDS?	2			

Totals (Attributes evaluated as N/A are not calculated.)	Total Points Available	Total Points Awarded
Spot Check (ACF) (Grade = Points Awarded/Points Available)		
<input type="checkbox"/> <u>Above Standards</u>	<input type="checkbox"/> <u>At Standards</u>	<input type="checkbox"/> <u>Below Standards</u>

Above Standards (90% or greater)/At Standards (80-89.99%)/Below Standards (less than 80%)
 Below Standard grade requires immediate accomplishment monitored by a Chief.

Additional Remarks:

Print and Sign Inspector Name/Command

Date

APPENDIX A

SECTION III

ASSESSMENT OF CURRENT SHIP'S MAINTENANCE PROJECT VALIDITY FACTOR (CVF)

1. Using the basic definitions and guidelines described, determine the CSMP Validity Factor (CVF) for each Work Center. Enter the values determined on the CSMP Monitor Form, Section III-A of this Appendix.
2. The CVF worksheet shall be utilized for evaluating each work candidate selected. The results of the CVF work sheet are transferred to the CVF Checklist for incorporation with other attributes evaluated.

NOTE: SEVERAL ATTRIBUTES CONTAINED ON THE CSMP VALIDITY CHECKLIST ARE NOT INCORPORATED INTO THE GRADE AND ARE DESIGNED TO CAPTURE CSMP DATA FOR FURTHER ANALYSIS.

(This Page Intentionally Left Blank)

**APPENDIX A
SECTION III-A**

CURRENT SHIP'S MAINTENANCE PROJECT VALIDITY FACTOR (CVF) CHECKLIST

Ship	Department	Division	Work Center	Date
General				
Assessment Attribute				Value
CSMP VALIDITY (Raw Data)				
1.	Number of TA-1 Work Candidates			
2.	Number of TA-2 Work Candidates			
3.	Number of TA-3 Work Candidates			
4.	Number of TA-4 Work Candidates			
5.	Total Work Candidates (WC) Sum of 1-4			
6.	Number of TA-2WC over 180 days old			
7.	Number of TA-4WC over 180 days old			
8.	Aged Work Candidates (WCO) Sum of 6-7			
9.	Material Correction Rate: WCO/3 (Aged TA-4) (#7/3)/#4			
10.	CSMP Validity review results from CVF Sheet Enter score from CVF Worksheet			
11.	Ship's Force WC over 7 days old that require parts and the parts are not ordered.			
12.	Open Ship's Force WC over 30 days old, not uplined to the Master CSMP.			
13.	Total Work Candidate Deficiencies (WDC) Sum (#11-#12)/#4			
14.	Work Candidate Multiple Average #9, #10, and #13			
15.	Material deficiencies noted by MRC spot checks that were not documented in the CSMP			
16.	Deductions#15/#5			
17.	CSMP Validity Average #14 and #16			
CSMP Validity				
<input type="checkbox"/> <u>Above Standards</u> <input type="checkbox"/> <u>At Standards</u> <input type="checkbox"/> <u>Below Standards</u>				

Above Standards (90% or greater)/At Standards (80-89.99%)/Below Standards (less than 80%)

(This Page Intentionally Left Blank)

APPENDIX A
SECTION III-A-1
CURRENT SHIP'S MAINTENANCE PROJECT VALIDITY FACTOR (CVF)
WORK CANDIDATE WORKSHEET

Ship		Department			Division			Work Center			Date		
General													
JCN	Equipment	1	2	3	4	5	6	7	8	9	10	CVF	
CVF	Average all Cells	Ave	Ave	Ave	Ave	Ave	Ave	Ave	Ave	Ave	Ave	Ave	
CSMP entry was reviewed with the following results:										Deduction			
1.	Problem Description inadequate.										10		
2.	Recommended Solution inadequate.										10		
3.	Write up does not reflect maintenance level assigned.										10		
4.	1 st and 2 nd Contact Man not assigned.										10		
5.	Incorrect CSMP Summary.										10		
6.	Correct Type of Availability (Maintenance Assignment) 1, 2, 3 Work Candidates.										10		
7.	Priority Code incorrect.										10		
8.	Write up does not match the Configuration Item or is not written on the correct configuration item.										10		
9.	Does the Work Candidate reflect the current and correct status of the material deficiency?										10		
10.	Was the correct special purpose and/or safety block selected with the correct values assigned? And if selected were the required Block 35 remarks present?										10		
For attributes not required due to Class/Type differences N/A and recalculate total value of each field.													

(This Page Intentionally Left Blank)

APPENDIX A

SECTION IV

ASSESSMENT OF RECORDED ACCOMPLISHMENT RATE (RAR) OR PMS ACCOMPLISHMENT RATE (PAR)

1. The RAR (SKED 3.1) or PAR (SKED 3.2 and higher) is a report automatically generated by SKED.

NOTE: SKED WILL NOT CALCULATE RAR DATA FOR A QUARTER THAT IS ARCHIVED UNLESS THAT QUARTER IS OPENED AND A PMS PERFORMANCE REPORT IS RUN ON THAT WORK CENTER.

2. (SKED 3.1) The RAR (Equipment Based) shall be utilized for entry in the Ship totals portion of the Performance Evaluation Database by utilizing a date range consisting of the previous 13 weeks of maintenance.
3. (SKED 3.2 or higher) The Periodic PAR grade shall be averaged with the Situational PAR grade and utilized for entry in the Ship totals portion of the Performance Evaluation Database by utilizing a date range consisting of the previous 13 weeks of maintenance.

(This Page Intentionally Left Blank)

APPENDIX A

SECTION V

EXECUTIVE EFFECTIVENESS REVIEW (EER)

1. Using the basic definitions and guidelines described, determine the Executive Effectiveness Review (EER) for the ship. Enter the values determined on the EER Check list Form, Section V-A of this Appendix. Provide amplifying information for deficiencies causing point reduction on the remarks page.
2. Select ten percent (Surface and Submarine Forces) or two percent (Air Forces) of the crew who have access to MDS functions using the Section V-A-1 worksheet of Appendix A.
3. Select ten percent (Surface and Submarine Forces) or two percent (Air Forces) of the crew who have access to SKED functions using the Section V-A-2 worksheet of Appendix A.

NOTE: FOR LARGE SHIPS THAT EMPLOY DEPARTMENTAL 3-M OFFICES, THE EER FORM IS REQUIRED TO BE COMPLETED AND AVERAGED TO DETERMINE THE SHIP'S EER.

(This Page Intentionally Left Blank)

APPENDIX A
SECTION V-A

EXECUTIVE EFFECTIVENESS REVIEW (EER) CHECKLIST

USS	Ship	Date	
General			
Assessment Attributes		Value	Grade
1.	Does the 3-M Coordinator maintain?		
	a. Record of MIP changes (ALID-1)?	1	
	b. MIP to WC File (PMS-4)?	1	
	c. Master LOEP (PMS-5)?	3	
	d. Change Accountability Log (including TFBR Accountability Log)?	2	
	e. Does the 3-MC maintain a log tracking the assignments of MRCs from a split MIP to ensure all applicable MRCs are assigned?	3	
	f. Ship generated FBR response status in SKED and follow up action tracked?	3	
	g. Master Confidential PMS card File?	2	
	h. Current PMS CD-ROM?	1	
	i. Current PMR Inventory and Schedules CD-ROM?	1	
2.	Does the 3-M Coordinator have an effective system for routing, explaining, and tracking of externally provided PMS documentation changes?	3	
3.	Is an effective system in use whereby supervisory personnel periodically and routinely monitor PMS performance in accordance with the requirements of reference (a) and this instruction?	5	
4.	Is the 3-M Functional Area Supervisor (FAS) ensuring all 3-M databases are being routinely maintained? (Use RAF computation sheet.)	10	
5.	Have all feedback reports entered in SKED been properly reviewed by the chain of command and submitted off hull within 7 days?	3	
6.	Have CSMP reconciliations been conducted per JFMM & TYCOM instructions?	3	
7.	Does the 3-MC conduct internal audits of all Work Center PMS Work Centers? (Retain latest copies of deficiencies noted and corrections for one year.)	5	
8.	Does the 3-MC provide weekly status reports to the 3-M Manager concerning the commands spot check/self evaluation program? (Retain for 1 year.)	3	
9.	Does the 3-MC have an approved master copy of PMS PQS specifically tailored for the command?	3	
10.	Does the 3MC maintain an auditable record of PMS and Quality Maintenance PQS? Are 3M qualifications commensurate to meet mission requirements?	5	
11.	Does the 3MC maintain an auditable record of PMS PQS for the command (e.g., copy of service record entries, signed copy of PQS cover letter, officer verified divisional training record)?	2	
12.	Does the 3MC track assessment MRCs (K for submarines/800 series for others) and verify completion with the local agency? Does the completion rate, when compared to the current monitoring period, reflect a successful shipboard program?	10	
13.	Does the 3MC ensure that a reliable system for backing up the ship's historical PMS data (SKED archives) is in place?	5	

Totals (Attributes evaluated as N/A are not calculated)	Total Points Available	Total Points Awarded
Executive Effectiveness Review (EER) (Points Available/Points Awarded)		
<input type="checkbox"/> <u>Above Standards</u> <input type="checkbox"/> <u>At Standards</u> <input type="checkbox"/> <u>Below Standards</u>		

Above Standards (90% or greater)/At Standards (80-89.99%)/Below Standards (less than 80%)

(This Page Intentionally Left Blank)

**APPENDIX A
SECTION V-A-1**

**EXECUTIVE EFFECTIVENESS REVIEW MAINTENANCE DATA SYSTEM PROFICIENCY FACTOR
(MPF) WORKSHEET**

Ship		Department			Division		Work Center	Date
Individual Evaluated						3-M Billet Assigned		
Proficiency Required					Proficiency Attribute			Yes/No
	MP	RPPO	WCS	DO	DH			
1	X	X	X	X	X	3-M PQS Qualification completed		
2	X	X	X	X	X	Able to Log-on. (OMMS-NG)		
CSMP ACTIONS:								
3	X	X	X	X		Add Maintenance Action (2-Kilo)		
4	X	X	X	X		Close Maintenance Action (2-Kilo)		
5	X	X	X	X		Change Maintenance Action (2-Kilo)		
6	X	X	X	X	X	Display Maintenance Action (2-Kilo)		
CONFIGURATION MAINTENANCE ACTION:								
7	X	X	X			Report installation of equipment: (CK)		
8	X	X	X			Report modification of equipment: (CK)		
9	X	X	X			Report removal of equipment: (CK)		
UPDATE SEF:								
10	X	X	X	X	X	Review on-line equipment records:		
11			X			Add equipment records:		
12			X			Modify equipment records:		
13			X			Delete equipment records:		
UPDATE LOGISTICS SUPPORT DATA (LSD) FILE:								
14	X	X	X	X	X	Review on-line LSD records:		
15			X			Add LSD data elements:		

Ship		Department			Division		Work Center		Date		
Individual Evaluated						3-M Billet Assigned					
Proficiency Required					Proficiency Attribute					Yes/No	
UPDATE LOGISTICS SUPPORT DATA (LSD) FILE: (Con't)											
16			X			Change LSD data elements:					
17			X			Delete LSD data elements:					
SUPPLY REQUISITIONING:											
18		X	X			Order maintenance parts:					
19		X	X			Order non-maintenance related items:					
PRINT REPORTS:											
20		X	X			SEF summary reports:					
21		X	X	X	X	CSMP reports:					
PRE-TRANSMITTAL REVIEW:											
22			X	X	X	Review CSMP transactions:					
23			X	X	X	Review SEF transactions:					
24			X	X	X	Review FCFBR transactions: (MicroSnap OMMS Installations only)					
Totals											
11	15	24	12	9	Divide Total Yes by Proficiency Required totals for the billet held by the individual					Total Yes	
					MPF: (%)						

**APPENDIX A
SECTION V-A-2**

**EXECUTIVE EFFECTIVENESS REVIEW SKED PROFICIENCY FACTOR (SPF) WORKSHEET
(SKED 3.1 Users)**

Ship		Department			Division		Work Center		Date		
Individual Evaluated							3-M Billet Assigned				
Proficiency Required					Proficiency Attribute					Yes/No	
WCS	DO	DH	3-MC								
Work Center Actions											
1	X	X	X	X	Able to log on						
2	X	X	X	X	Able to open a Work Center						
3	X	X	X	X	Able to view the Cycle, Quarter, Weekly and Schedule List View						
4	X			X	Able to annotate Disposition of Maintenance						
5	X			X	Able to save a Work Center						
6	X			X	Able to back-up and restore a Work Center						
7	X			X	Able to modify Work Center Options						
8	X	X	X	X	Able to view Archive Quarter						
9	X	X	X	X	Able to view Component Row Properties						
10	X	X	X	X	Able to view Check Properties						
11	X	X	X	X	Able to update Spot Check Results						
12	X	X	X	X	Able to enter/view Flip Page Remarks						
Schedule Actions											
13	X	X	X	X	Able to add, delete or modify MIPs/MRCs in Data Entry Mode						
14			X	X	Able to finalize the Cycle Schedule						
15	X	X		X	Able to adjust Quarter Start/End Dates						
16			X	X	Able to finalize the Quarter Schedule						

Schedule Actions					
17		X		X	Able to generate the next Quarter Schedule
18	X			X	Able to regenerate a Quarter
19	X			X	Able to assign Maintenance Responsibilities
20	X			X	Able to modify Equipment Associations (Server Installations only)
21	X			X	Able to restart the Cycle Schedule
22	X			X	Able to return the Quarter Schedule to Revise
23	X			X	Able to generate an Open Work Candidate for Parts (Server Installations only)
Event List Actions					
24	X			X	Able to create an Event List
25	X			X	Able to add checks to an Event List
26	X	X		X	Able to trigger a Local Event
27				X	Able to trigger a Global Event
Feed Back Report Actions					
28	X			X	Able to generate a Feed Back Report
29		X	X	X	Able to Review/Approve a Feed Back Report
Revision Actions					
30	X			X	Able to implement a Revision
31			X	X	Able to finalize a Revision
32	X			X	Able to perform Data Integrity and Periodicity Range checks
Reports					
33	X	X	X	X	Able to generate and/or View PMS Reports
Admin Actions					
34	X	X	X	X	Able to add Users
35	X	X	X	X	Able to edit Users

Admin Actions						
36	X			X	Able to inactivate Users	
37		X	X	X	Able to View/Modify the Chain of Command	
Totals						
30	17	17	37	Divide Total Yes by Proficiency Required totals for the billet held by the individual		Total Yes
				SPF: (%)		

(This Page Intentionally Left Blank)

APPENDIX A
SECTION V-A-3

**EXECUTIVE EFFECTIVENESS REVIEW REPORTING ASI PROCESSING CONFIDENCE FACTOR
(RAF) WORKSHEET**

ASSESSMENT ATTRIBUTES	Value	Grade
Equipment Validation Program		
Does the 3MC/MSC OBR maintain a master file or list to track Configuration Item Record Validations?	5	
SUSPENSE FILE SUMMARY STATISTICAL REPORT:		
Average age of all configuration transactions was 7 days or less. Points are awarded based on the number of days as follows:	10	
Average age of all configuration transactions awaiting review:		
7 days or less 10 points		
8-14 days 8 points		
15-20 days 4 points		
21-30 days 2 points		
over 30 days 0 points		
OMMS-NG SYSTEM MAINTENANCE REVIEW		
Is the import correction queue empty?	4	
Has Archive and Inactive been run in the last 15 days?	4	
Have Work Candidates been removed from past availabilities?	4	
Is the OMMS Server Reports Directory "h/OMMSBT/data/reports" being maintained?	4	
Is the OMMS Server Reports Directory "h/OMMSBT/data" being maintained?	4	
Does the Review and Approval queue have Work Candidates older than 7 days?	10	
Does the FAS have a tracking system for upline reporting?	4	
Does the FAS maintain a log tracking significant down time?	4	
Is there an effective process in place that deletes users as they transfer from the command?	4	
Is the availability used to track jobs rejected/questioned by the TYCOM MM empty?	4	
Are copies of the .uru and .pts file maintained on file until reporting activity acknowledges processing?	4	
CONFIGURATION MANAGEMENT		
Monthly follow-up action had been initiated with the CDM for CK's awaiting response in excess of 180 days	10	
ASI PROCESSING		
Latest ASI file received has been processed. Points are awarded based on the backlog of ASI as follows:	10	
Up-to-date in ASI processing 10 points		
1 ASI file behind 8 points		
2 ASI file behind 6 points		
3 ASI file behind 4 points		

4 ASI file behind	2 points		
5 or more ASI file behind	0 points		
Are ASI Input and Summary Reports kept until all processing of the ASI has been completed?		10	
After processing, are ASI error reports sent to the CDM and to other activities as directed by the TYCOM?		10	
Totals (Attributes evaluated as N/A are not calculated)	Total Points Available	Total Points Awarded	
		RAF: (%)	

APPENDIX A

SECTION VI

3-M ASSESSMENT COMMAND TOTAL SCORE

1. The Ship's total score data shall be auto completed based on entries from Sections I through V of this Appendix.
2. Scoring shall be as indicated on the sample spread sheet provided in section VI-A of this Appendix.

(This Page Intentionally Left Blank)

**APPENDIX A
SECTION VI-A**

SAMPLE 3-M ASSESSMENT TOTALS SPREAD SHEET

	Total Weight						Mean Score	Checks Scheduled	R-Checks Completed	Total Checks	Adjusted Value
		AER	ACF	CVF	PAR	Exec					
WORK CENTER	Divide the Total Checks for the Work Center by the Ship or Dept. by the Total Checks	Section I	Section II	Section III	Section IV	Section V	Ave Sect I-IV	All Scheduled Checks From SKED	All R MRCs Completed from previous 13 Weeks (count only one situational performance per week per MRC)	Add Scheduled Checks and R Checks	Multiply Total Weight and Mean Score
Engineering											
EA01						N/A					
EDC1						N/A					
EE01						N/A					
EM01						N/A					
RC01						N/A					
RL01						N/A					
		Ave AER	Ave ACF	Ave CVF	Ave PAR	If Applicable	Ave Dept	Total	Total	Total	
Executive	N/A	N/A	N/A	N/A	N/A		N/A	N/A	N/A	N/A	N/A
Ship Totals	N/A	Ave All W/C	Ave All W/C	Ave All W/C	Ave All W/C		N/A	Total All	Total All	Total All	N/A
Total Score	Average total AER, ACF, CVF, PAR, and Exec					>90% = Above Standards <90%->80% = At Standards <80% = Below Standards					

V-I-19A-39

COMUSFLTFORCOMINST 4790.3 REV C

(This Page Intentionally Left Blank)

**APPENDIX B
FORMAT FOR REPORTING 3-M ASSESSMENTS**

4790
Ser
Date

From: Accomplishing Activity
To: Commanding Officer (Commands Name and Hull Number (if applicable.))
Subj: REPORT OF 3-M ASSESSMENT OF
Ref: (a) NAVSEAINST 4790.8/OPNAVINST 4790.4; Ship's Maintenance and Material Management (3-M) Manual
(b) COMUSFLTFORCOMINST 4790.3; Joint Fleet Maintenance Manual, Volume VI, Chapter 19

Encl: (1) (as required)

1. In accordance with references (a) and (b), a 3-M Assessment of was conducted during the period (Date) to (Date).
2. During this assessment, the following significant deficiencies were discovered:
 - a. (List)

Specific department and WC deficiencies are provided in enclosure(s) (1) through ().

3. The following overall ship/department numerical assessments are assigned:
 - a. 3-M Total Score _____
 - b. 3-M Assessment _____
(Above/At/Below Standards)

Copy to:
Immediate Superior In Command (with enclosures)
Type Commander (with enclosures)

(This Page Intentionally Left Blank)

APPENDIX C

LISTING OF STANDARD WORK CENTER CODES

- Appendix C_{1A} Standard Work Center Codes for Naval Air Force Ships (CVN-68 Class)
- Appendix C_{1B} Standard Work Center Codes for Naval Air Force Ships (CVN-78 Class)
- Appendix C₂ Standard Work Center Codes for Naval Expeditionary Combat Command
- Appendix C₃ Standard Work Center Codes for Naval Submarine Force Ships
- Appendix C₄ Standard Work Center Codes for Naval Surface Force Ships and Shore Commands

(This Page Intentionally Left Blank)

APPENDIX C₁A

STANDARD WORK CENTER CODES FOR NAVAL AIR FORCE SHIPS (CVN-68 CLASS)

1. Afloat Departmental Codes.

	<u>WC CODE</u>
Safety	A
Command Religious Ministries	B
Combat Systems	C
Deck	D
Engineering	E
Graphics Media	G
Aviation Intermediate Maintenance Department (AIMD)	I
Legal	L
Dental	MD
Medical	MH
Navigation	N
Operations	O
Reactor	R
Supply	S
Training	T
Air	V
Weapons	W
Administration	X
Airwing (when assigned)	Z

2. Afloat Professional WC Codes.

a. <u>Safety Department.</u>	AS01
b. <u>Command Religious Ministries Department.</u>	BC01
c. <u>Combat Systems Department Administration.</u>	CS00
Telecommunications Division Administration	CS10
Message Processing	CS11
Tech Control/Antenna	CS12
Network Security Division Administration	CS20
Information Systems Security	CS21
Automated Data Processing Division Administration	CS30
Unclassified Appts/Hardware/LAN	CS31
Classified Appts/Hardware/LAN	CS32
NTCSS	CS33
PC Copier Repair	CS34
Distributed Data Communications Maintenance (includes ICAN, DDCN, and MCS)	CS35
Data Systems Division Administration	CS50
C2/Display Systems Maintenance/ISIS	CS51
Tactical USW Systems Maintenance	CS52
INTEL Systems Maintenance	CS53

	WC CODE
2-M Repair/Fiber Repair	CS54
Tactical Data Links	CS55
Radar Division Administration	CS60
Air Traffic Control	CS61
Surface Search/Air Search/IFF	CS62
Navigation/NAVAIDS/Gyro	CS63
Meteorology	CS64
Test Equipment	CS65
Combat Systems Department Tool Issue	CS66
Self Defense Weapons Division Administration	CS70
CIWS	CS71
RAM	CS72
NSSMS	CS73
SPS-48/SPQ-9B/TAS	CS74
IC Systems Division Administration	CS80
SITE-TV	CS81
Telephone	CS82
Announcing Systems	CS83
Alarm/Sensors	CS84
External Communications Repair Division Administration	CS90
HF/LOS/SATCOM Systems	CS91
Peripherals/NAVMACS/Crypto Equip	CS92
FDCS/BDCS/HYDRA	CS93
d. <u>Deck Department Administration.</u>	DX00
1st Division	DA01
2nd Division	DB02
3rd Division	DC03
e. <u>Engineering Department Administration.</u>	EX00
Auxiliaries Division Administration	EA00
Hydraulics	EA01
Steam Heat/Galley/Laundry	EA02
Air Conditioning & Refrigeration	EA03
Oxygen & Nitrogen	EA06
Boats	EA07
Outside Repair	EA08
Catapult Steam	EA10
Filter Shop	EA11
Waste Management	EA14
Damage Control Division Administration	ED00
Damage Control Training	ED01
Chemical/CBR-D	ED02
Damage Control Systems	ED03
SCBA/BARS/SAR-SCBA/EBACS/Gas Free	ED04

	WC CODE
Damage Control Repair Stations	ED05
Electrical Division Administration	EE00
Lighting/Battery Shop	EE01
Rewind	EE02
Power (Non-nuclear)/General	EE03
Hotel Services	EE04
Electrical Safety	EE20
Repair Division Administration	ER00
General Work Shop	ER01
Carpenter	ER02
Pipe Shop/Marine Sanitation Device (MSD)	ER03
Machine Shop/Locksmith	ER04
Maintenance Division Administration	PM00
3-M	PM01
MSC	PM02
Quality Assurance (QA)	PM03
f. <u>Graphics Media Department Administration.</u>	GM00
PAO	GM11
Photo Shop	GM12
Print Shop	GM13
g. <u>AIMD Department Administration.</u>	IM00
PC/QA division (NALCOMIS reported equipment)	IM01
Mechanical Repairs	IM02
Avionics	IM03
Ground Support	IM04
Field Calibration Activity	FCA1
h. <u>Legal Department.</u>	LN01
i. <u>Health Services.</u>	
Dental Department	MD01
Medical Department	MH01
j. <u>Navigation Department.</u>	NN01
k. <u>Operations Dept Administration.</u>	OX00
Meteorological	OA01
Air Ops/CATCC	OC01
Security Department Administration.	OF00
Ship's Security Force	OF01
Force Protection	OF02

	WC CODE
Brig	OF03
CDC	OI01
Undersea Warfare/Acoustics	OM01
Comm Intel/SESS	OS01
Electronic Warfare	OS02
Intelligence Department Administration (when assigned).	OZ00
Intelligence	OZ01
1. <u>Reactor Department Administration.</u>	RX00
Reactors Auxiliaries Division Administration	RA00
Emergency Diesels	RA01
Reactor Controls Division Administration	RC00
#1 Reactor Plant	RC11
#1 Reactor Plant (Non-Nuclear)	RC12
#2 Reactor Plant	RC21
#2 Reactor Plant (Non-Nuclear)	RC22
Reactor Instrumentation and Maintenance	RC30
Reactor Electrical Division Administration	RE00
#1 Reactor Plant	RE11
#1 Reactor Plant (Non-Nuclear)	RE12
#2 Reactor Plant	RE21
#2 Reactor Plant (Non-Nuclear)	RE22
Tool Issue and Technical Support	RE30
Reactor Laboratory Division Administration	RL00
#1 Reactor Plant	RL11
#1 Reactor Plant (Non-Nuclear)	RL12
#2 Reactor Plant	RL21
#2 Reactor Plant (Non-Nuclear)	RL22
Dosimetry	RL30
Reactor Mechanical Division Administration	RM00
#1 Reactor Room	RM11
#1 Reactor Room (Non-Nuclear)	RM12
#2 Reactor Room	RM21
#2 Reactor Room (Non-Nuclear)	RM22
Technical Support	RM30
Reactor Propulsion Division Administration	RP00
#1 Main Machinery Room	RP01
#2 Main Machinery Room	RP02
Shaft Alley/Reboiler/Oily Waste	RP05
Technical Support	RP30

	WC CODE
Reactor Training Division Administration	RT00
m. <u>Supply Department Administration.</u>	SS00
S-1 Stock Control	SS01
S-2 Food Services	SS02
S-3 Retail Operations	SS03
S-4 Disbursing	SS04
S-5 Hotel Services	SS05
S-6 Aviation Support	SS06
S-7 Morale, Welfare and Recreation	SS07
S-8 Material	SS08
S-8A Hazardous Material	SS09
S-10 Supply Quality Assurance	SS10
S-11 CPO Mess	SS11
S-1A Customer Service (Post Office)	SS12
S-13 Supply Department 3M/DC	SS13
n. <u>Training Department.</u>	TX01
o. <u>Air Department Administration.</u>	VV00
V1 Division Administration	VA00
Flight Deck	VA01
Crash and Salvage	VA02
V2 Division Administration	VB00
#1 Catapult	VB01
#2 Catapult	VB02
#3 Catapult	VB03
#4 Catapult	VB04
#1 Arresting Gear	VB05
#2 Arresting Gear	VB06
#3 Arresting Gear	VB07
#4 Arresting Gear (#3A CVN-76 Class)	VB08
Barricade	VB09
Improved Fresnel Lens Optical Landing System (IFLOLS)	VB10
Integrated Launch and Recovery Television System (ILARTS)	VB11
Flight Deck Lighting	VB12
Maintenance Control	VB20
QA	VB21
Maintenance Support	VB22
V3 Division Administration.	VC00
Hanger Deck	VC01
V4 Division Administration.	VF00
JP-5 Hanger Deck/Flight Maintenance	VF01
JP-5 Below Deck Equipment Maintenance	VF02
EM and IC Repair	VF03

	WC CODE
JP-5 QA/Testing Lab	VF04
V5 Division Administration. PRIFLY	VX00 VX01
p. <u>Weapons Department Administration.</u>	WG00
Weapons Handling G1 Division	WG01
Ship's Armory G2 Division	WG02
Weapons Magazine G3 Division	WG03
Weapons Elevator G4 Division	WG04
Weapons Control G5 Division	WG05
Weapons Electrical Tool Issue	WG20
q. <u>Administration Department.</u>	
CO's Admin	XX01
XO's Admin	XX02
Administration	XX03
Personnel	XX04
Special Assistants - ESO/CCC/CMC/DAPA/EOA	XX05
Flag/Embarked Staff	XF01
r. <u>Airwing</u> (when assigned).	
CAG	ZW00
Reserved for Assignment to Embarked Airwings	ZW01 thru ZW11
3. Afloat Damage Control WC Codes.	
a. <u>Safety Department DC.</u>	AS40
b. <u>Command Religious Ministries Department DC.</u>	BC40
c. <u>Combat Systems Department DC</u> (note 1).	CS40
Telecommunications Division DC	CS41
Network Information Security DC	CS42
ADP Division DC	CS43
Data Systems Division DC	CS45
Radar Division DC	CS46
Self Defense Weapons Division DC	CS47
IC Systems Division DC	CS48
External Communications Repair Division DC	CS49
d. <u>Deck Department DC</u> (note 1).	DX40
1st Division DC	DA40
2nd Division DC	DB40
3rd Division DC	DC40

	WC CODE
e. <u>Engineering Department DC</u> (note 1).	EX40
Auxiliaries Division DC	EA40
Damage Control Division DC	ED40
Electrical Division DC	EE40
Repair Division DC	ER40
Maintenance Department DC	PM40
f. <u>Graphics Media Department DC.</u>	GM40
g. <u>AIMD Department DC</u> (note 1).	IM40
IM1 Division DC	IM41
IM2 Division DC	IM42
IM3 Division DC	IM43
IM4 Division DC	IM44
h. <u>Legal Department DC.</u>	LN40
i. <u>Health Services.</u>	
Dental Department DC	MD40
Medical Department DC	MH40
j. <u>Navigation Department DC.</u>	NN40
k. <u>Operations Department DC</u> (note 1).	OX40
OA Division DC	OA40
OC Division DC	OC40
OF Division/Department DC	OF40
OI Division DC	OI40
OM Division DC	OM40
OS Division DC	OS40
OZ Division/Department DC (as assigned)	OZ40
l. <u>Reactor Department DC.</u>	RX40
m. <u>Supply Department DC</u> (note 1).	SS40
S-1 Stock Control	SS41
S-2 Food Services	SS42
S-3 Retail Operations	SS43
S-4 Disbursing	SS44
S-5 Hotel Services	SS45
S-6 Aviation Support	SS46
S-7 Morale, Welfare and Recreation	SS47
S-8 Material	SS48
S-8A Hazardous Material	SS49
S-10 Supply Quality Assurance	SS50
S-11 CPO Mess	SS51
S-1A Customer Service (Post Office)	SS52

	WC CODE
n. <u>Training Department DC.</u>	TX40
o. <u>Weapons Department DC</u> (note 1).	WG40
G1 Division DC	WG41
G2 Division DC	WG42
G3 Division DC	WG43
G4 Division DC	WG44
G5 Division DC	WG45
p. <u>Air Department DC</u> (note 1).	VV40
V1 Division DC	VA40
V2 Division DC	VB40
V3 Division DC	VC40
V4 Division DC	VF40
V5 Division DC	VX40
q. <u>Administration Department DC.</u>	XX40

Note 1: Damage Control (DC) work centers are assigned at the division level, therefore, the department work center is usually not applicable. When authorized by the Commanding Officer to combine division DC work centers at the departmental level, the division work center is not applicable.

4. Afloat Maintenance Availability WC Codes.

a. <u>Ship Alteration</u> (N/A for Ship's Force, used by TYCOM for planning purposes).	
Combat Systems SCD	CSSA
Deck Department SCD	DXSA
Engineering Department SCD	EXSA
AIMD SCD	IMSA
Health Services Department SCD	MXSA
Navigation Department SCD	NNSA
Operations Department SCD	OXSA
Nuclear Alteration Administration	RXFC
Reactor Department SCD	RXSA
Reactor Department TYCOM Alts	RXTY
Supply Department SCD	SSSA
Air Department SCD	VXSA
Weapons Department SCD	WGSA
Graphics Media Department SCD	GMSA
b. <u>Availability Maintenance Teams.</u>	
Work Control	PM10
Habitability	PM11
Paint	PM12
Deck	PM13
Valve Barge	PM14
Vent Cleaning	PM15
Tank and Void	PM16

WC CODE

Cable Way	PM17
Door Repair	PM18
GSE	PM19
Lagging	PM20
Joiner Door Repair	PM21
Ladder Repair	PM22
Electrical Repair	PM23
Fan Room Restoration	PM24
LIFAC	PM25
Plenum Repair	PM26
Matting	PM27
Interior Communications	PM28
Head Repair	PM29
Damage Control	PM30
Island Painting	PM31
JP-5	PM32

(This Page Intentionally Left Blank)

APPENDIX C₁B**STANDARD WORK CENTER CODES FOR NAVAL AIR FORCE SHIPS (CVN-78 CLASS)**

1. Afloat Departmental Codes.

	WC CODE
Safety	A
Command Religious Ministries	B
Combat Systems	C
Deck	D
Engineering	E
Security	F
Graphics Media	G
Aviation Intermediate Maintenance Department (AIMD)	I
Legal	L
Dental	MD
Medical	MH
Navigation	N
Operations	O
Reactor	R
Supply	S
Training	T
Air	V
Weapons	W
Administration	X
Airwing (when assigned)	Z

2. Afloat Professional WC Codes.

a.	<u>Safety Department.</u>	AS01
b.	<u>Command Religious Ministries Department.</u>	BC01
c.	<u>Combat Systems Department Administration.</u>	CS00
	Telecommunications Division Administration	CS10
	Message Processing	CS11
	Tech Control	CS12
	Information Sys Security/Assurance/EKMS	CS13
	Information Resources Divisional ADMIN	CS20
	Unclassified Appts/Hardware/LAN CANES	CS21
	Classified Appts/Hardware/LAN CANES	CS22
	SCI Networks(SESS)	CS23
	Data Systems Division Administration	CS50
	C2/Display Systems/SSDS/CEC/GCCS-M	CS51
	Equipment	
	Tactical USW Systems Maintenance (CV-TSC)	CS52
	INTEL Systems Maintenance	CS53
	2-M Repair/Fiber Repair	CS54
	Tactical Data Links	CS55
	Radar Division Administration	CS60
	Air Traffic Control	CS61

	WC CODE
Dual Band Radar/SPS-73 Surface Search Radar	CS62
IFF/TACAN/Electromagnetic Compatibility	CS63
Meteorology(NITES, MORIAH)	CS64
Test Equipment/Tool Issue	CS65
Self Defense Weapons Division Administration	CS70
CIWS	CS71
RAM	CS72
NSSMS	CS73
External Communications Repair Division Administration	CS90
HF/LOS/SATCOM Systems (NMT, Flight Deck Comms, CBSP, HF Antennas)	CS91
Peripherals/NAVMACS/Crypto Sys/	CS92
HYDRA/TVS/Announcing Systems	CS93
SITE-TV/CCTV(All 27 TV Systems)	CS94
d. <u>Deck Department Administration.</u>	DX00
1st Division	DA01
2nd Division	DB02
3rd Division	DC03
e. <u>Engineering Department Administration.</u>	EX00
Auxiliaries Division Administration	EA00
Hydraulics	EA01
Steam Heat/Galley/Laundry	EA02
Air Conditioning & Refrigeration	EA03
Oxygen & Nitrogen	EA06
Boats	EA07
Outside Repair	EA08
Waste Management	EA14
Damage Control Division Administration	ED00
Damage Control Training	ED01
Chemical/CBR-D	ED02
Damage Control Systems	ED03
SCBA/BARS/SAR-SCBA/EBACS/Gas Free	ED04
Damage Control Repair Stations	ED05
Electrical Division Administration	EE00
Lighting/Battery Shop	EE01
Rewind	EE02
Power (Non-nuclear)/General	EE03
Hotel Services	EE04
IC Repair	EE05
Electrical Safety	EE20
Repair Division Administration	ER00
General Work Shop	ER01
Pipe Shop/VCHT	ER03

	WC CODE
Machine Shop/Locksmith	ER04
Maintenance Division Administration	PM00
3-M	PM01
MSC	PM02
Quality Assurance (QA)	PM03
f. <u>Graphics Media Department Administration.</u>	GM00
PAO	GM11
Photo Shop	GM12
Print Shop	GM13
g. <u>Security Department Administration.</u>	FS00
Ship's Security Force	FS01
Force Protection	FS02
Brig	FS03
h. <u>AIMD Department Administration.</u>	IM00
PC/QA division (NALCOMIS reported equipment)	IM01
Mechanical Repairs	IM02
Avionics	IM03
Ground Support	IM04
Field Calibration Activity	FCA1
i. <u>Legal Department.</u>	LN01
j. <u>Dental Department.</u>	MD01
k. <u>Medical Department.</u>	MH01
l. <u>Navigation Department.</u>	NN01
m. <u>Operations Dept Administration.</u>	OX00
Meteorological	OA01
Air Ops/CATCC	OC01
CDC	OI01
Undersea Warfare/Acoustics	OM01
Comm Intel/SESS	OS01
Electronic Warfare	OS02
Intelligence Department Administration (when assigned).	OZ00
Intelligence	OZ01
n. <u>Reactor Department Administration.</u>	RX00
Reactors Auxiliaries Division Administration	RA00
FWD Emergency Diesels	RA01

	WC CODE
AFT Emergency Diesels	RA02
Shaft Alley & OWS(CVN-78)	RA05
Reactor Controls Division Administration	RC00
#1 Propulsion Plant	RC11
#2 Propulsion Plant	RC21
Reactor Instr. and Maint.	RC30
PPLAN/PPMC/TPL	RC31
Reactor Electrical Division Administration	RE00
#1 Propulsion Plant	RE11
#2 Propulsion Plant	RE21
Reactor Electrical Tool Issue	RE30
Reactor Laboratory Division Administration	RL00
#1 Propulsion Plant	RL11
#2 Propulsion Plant	RL21
Dosimetry	RL30
Reactor Mechanical Division Administration	RM00
#1 Propulsion Plant	RM11
#2 Propulsion Plant	RM21
Technical Support	RM30
Reactor Training Division Administration	RT00
Student Training	RT01
o. <u>Supply Department Administration.</u>	SS00
S-1 Stock Control	SS01
S-2 Food Services	SS02
S-3 Retail Operations	SS03
S-4 Disbursing	SS04
S-5 Hotel Services	SS05
S-6 Aviation Support	SS06
S-7 Morale, Welfare and Recreation	SS07
S-8 Material	SS08
S-8A Hazardous Material	SS09
S-10 Supply Quality Assurance	SS10
S-11 CPO Mess	SS11
S-1A Customer Service (Post Office)	SS12
S-13 Supply Department 3M/DC	SS13
p. <u>Training Department.</u>	TX01
q. <u>Air Department Administration.</u>	VV00
V1 Division Administration	VA00
Flight Deck	VA01
Crash and Salvage	VA02
V2 Division Administration	VB00
#1 Catapult	VB01

	WC CODE
#2 Catapult	VB02
#3 Catapult	VB03
#4 Catapult	VB04
#1 Arresting Gear	VB05
#2 Arresting Gear	VB06
#3 Arresting Gear	VB07
#4 Arresting Gear	VB08
Barricade	VB09
Improved Fresnel Lens Optical Landing System (IFLOLS)	VB10
Integrated Launch and Recovery Television System (ILARTS)	VB11
Flight Deck Lighting	VB12
Maintenance Control	VB20
QA	VB21
Maintenance Support	VB22
V3 Division Administration.	VC00
Hanger Deck	VC01
V4 Division Administration.	VF00
JP-5 Hanger Deck/Flight Maintenance	VF01
JP-5 Below Deck Equipment Maintenance	VF02
EM and IC Repair	VF03
JP-5 QA/Testing Lab	VF04
V5 Division Administration.	VX00
PRIFLY	VX01
r. <u>Weapons Department Administration.</u>	WG00
Division Flight Deck/Hanger Deck/AWSEP	WG01
Division Armory/Sprinklers	WG02
Division Weapons Assembly	WG03
Division Elevators/Forklifts	WG04
Division Admin/AWMCS/QA/Safety	WG05
Weapons Electrical Tool Issue	WG20
s. <u>Administration Department.</u>	
CO's Admin	XX01
XO's Admin	XX02
Administration	XX03
Personnel	XX04
Special Assistants -	XX05
ESO/CCC/CMC/DAPA/EOA	
Flag/Embarked Staff	XF01
t. <u>Airwing (when assigned).</u>	
CAG	ZW00

	WC CODE
Reserved for Assignment to Embarked Airwings	ZW01 thru ZW11
3. Afloat Damage Control WC Codes.	
a. <u>Safety Department DC.</u>	AS40
b. <u>Command Religious Ministries Department DC.</u>	BC40
c. <u>Combat Systems Department DC</u> (note 1).	CS40
Telecommunications Division DC	CS41
Network Information Security DC	CS42
Data Systems Division DC	CS45
Radar Division DC	CS46
Self Defense Weapons Division DC	CS47
External Communications Repair Division DC	CS49
d. <u>Deck Department DC</u> (note 1).	DX40
1st Division DC	DA40
2nd Division DC	DB40
3rd Division DC	DC40
e. <u>Engineering Department DC</u> (note 1).	EX40
Auxiliaries Division DC	EA40
Damage Control Division DC	ED40
Electrical Division DC	EE40
Repair Division DC	ER40
Maintenance Division DC	PM40
f. <u>Security Department DC.</u>	FS40
g. <u>Graphics Media Department DC.</u>	GM40
h. <u>AIMD Department DC</u> (note 1).	IM40
IM1 Division DC	IM41
IM2 Division DC	IM42
IM3 Division DC	IM43
IM4 Division DC	IM44
i. <u>Legal Department DC.</u>	LN40
j. <u>Dental Department DC</u>	MD40
k. <u>Medical Department DC.</u>	MH40
l. <u>Navigation Department DC</u>	NN40
m. <u>Operations Department DC</u> (note 1).	OX40

	WC CODE
OA Division DC	OA40
OC Division DC	OC40
OI Division DC	OI40
OM Division DC	OM40
OS Division DC	OS40
OZ Division/Department DC (as assigned)	OZ40
n. <u>Reactor Department DC.</u>	RX40
o. <u>Supply Department DC</u> (note 1).	SS40
S-1 Stock Control	SS41
S-2 Food Services	SS42
S-3 Retail Operations	SS43
S-4 Disbursing	SS44
S-5 Hotel Services	SS45
S-6 Aviation Support	SS46
S-7 Morale, Welfare and Recreation	SS47
S-8 Material	SS48
S-8A Hazardous Material	SS49
S-10 Supply Quality Assurance	SS50
S-11 CPO Mess	SS51
S-1A Customer Service (Post Office)	SS52
p. <u>Training Department DC.</u>	TX40
q. <u>Weapons Department DC</u> (note 1).	WG40
G1 Division DC	WG41
G2 Division DC	WG42
G3 Division DC	WG43
G4 Division DC	WG44
G5 Division DC	WG45
r. <u>Air Department DC</u> (note 1).	VV40
V1 Division DC	VA40
V2 Division DC	VB40
V3 Division DC	VC40
V4 Division DC	VF40
V5 Division DC	VX40
s. <u>Administration Department DC.</u>	XX40

Note 1: Damage Control (DC) work centers are assigned at the division level, therefore, the department work center is usually not applicable. When authorized by the Commanding Officer to combine division DC work centers at the departmental level, the division work center is not applicable.

4. Afloat Maintenance Availability WC Codes.

- a. Ship Alteration (N/A for Ship's Force, used by TYCOM for planning purposes).
- | | |
|--------------------|------|
| Combat Systems SCD | CSSA |
|--------------------|------|

WC CODE

Deck Department SCD	DXSA
Engineering Department SCD	EXSA
Security Department SCD	FSSA
AIMD SCD	IMSA
Health Services Department SCD	MXSA
Navigation Department SCD	NNSA
Operations Department SCD	OXSA
Nuclear Alteration Administration	RXFC
Reactor Department SCD	RXSA
Reactor Department TYCOM Alts	RXTY
Supply Department SCD	SSSA
Air Department SCD	VXSA
Weapons Department SCD	WGSA
Graphics Media Department SCD	GMSA

b. Availability Maintenance Teams.

Work Control	PM10
Habitability	PM11
Paint	PM12
Deck	PM13
Valve Barge	PM14
Vent Cleaning	PM15
Tank and Void	PM16
Cable Way	PM17
Door Repair	PM18
GSE	PM19
Lagging	PM20
Joiner Door Repair	PM21
Ladder Repair	PM22
Electrical Repair	PM23
Fan Room Restoration	PM24
LIFAC	PM25
Plenum Repair	PM26
Matting	PM27
Interior Communications	PM28
Head Repair	PM29
Damage Control	PM30
Island Painting	PM31
JP-5	PM32

APPENDIX C₂**STANDARD WORK CENTER CODES FOR NAVAL EXPEDITIONARY COMBAT COMMAND**

Appendix C ₂ A	Standard Work Center Codes for Explosive Ordinance Disposal Units
Appendix C ₂ B	Standard Work Center Codes for Mobile Diving and Salvage Units
Appendix C ₂ C	Standard Work Center Codes for EOD Training Evaluation Units
Appendix C ₂ D	Standard Work Center Codes for Mobile Security Squadrons/Navy Coastal Warfare Squadrons
Appendix C ₂ E	Standard Work Center Codes for RIVERINE Squadrons
Appendix C ₂ F	Standard Work Center Codes for Navy Mobile Construction Battalions
Appendix C ₂ G	Standard Work Center Codes for SEABEE Readiness Group
Appendix C ₂ H	Standard Work Center Codes for Construction Battalion Mobile Units
Appendix C ₂ I	Standard Work Center Codes for Underwater Construction Teams
Appendix C ₂ J	Standard Work Center Codes for Navy Mobile Construction Battalions Forward Headquarters
Appendix C ₂ K	Standard Work Center Codes for NCF FWD Detachments
Appendix C ₂ L	Standard Work Center Codes for Navy Expeditionary Logistics Support Group
Appendix C ₂ M	Standard Work Center Codes for Navy Cargo Handling Battalion ONE

NOTES:

1. It is recommended all units under COMNECC develop a tool room or shop for maintenance and distribution of tools used for maintenance.
2. Some units are not large enough to incorporate three different Communication Work Centers. In such cases, all aspects of Information Technology will be incorporated into one Work Center (CS02).
3. All detachments that serve a specific purpose as listed in this instruction shall use the first two letters as indicated in Appendices C2A through C2M and the first two numbers of the detachment provided it is not duplicated within the same Unit Identification Code.
4. Shore Detachments assigned outside the continental United States shall use the two letter country code in which they are located and the first two numbers of the detachment or unit number. Detachments within the United States shall use appropriate designator identified within this Appendix.
5. Multiple boat and service craft Work Centers shall use concurrent numbering to identify follow on Work Centers of the same type (e.g., CA01, CA02, etc.).

(This Page Intentionally Left Blank)

APPENDIX C₂A

STANDARD WORK CENTER CODES FOR EXPLOSIVE ORDINANCE DISPOSAL UNITS

<u>WORK CENTER NAME</u>	<u>DIVISION W/C</u>	<u>W/C CODES</u>	<u>UNIT(S)</u>
<u>Administration Department</u>		XX00	ALL
	Administration Division	XX01	ALL
	Administration	XX02	ALL
	Safety	XS01	ALL
<u>Medical Department</u>		MH00	ALL
	Medical Division	MH01	ALL
	Medical	MH02	ALL
<u>Supply Department</u>		SUPP	ALL
	Supply Division	SS01	ALL
	Central Tool Room	SC01	NOTE 1
	Central Store Room	ST01	ALL
	HAZMAT	HZ01	ALL
	DTO	SS01	
<u>Stock Department</u>		STCK	ALL
	Stock Division	STOK	ALL
	Stock	STK	ALL
<u>Weapons Department</u>		WG00	
	Weapons Division	WG01	ALL
	Weapons (Small Arms)	WG02	ALL
	Weapons (Crew Served)	WG03	
<u>Maintenance Department</u>		AA00	
	Maintenance Division	AA01	
	Builder Shop	MR01	ALL
	CESE/Vehicles	AL01	ALL
	Dispatch	AO01	ALL
	Boat Shop Division	DA01	ALL
	Utility Craft	CU01	NOTE 5
	Small Boats (Inflatable)	CR01	ALL
	Repair (Hull/Fabrication/ Welding)	ER01	ALL
	Electric Shop	EE01	ALL
	Engineering DC	ER02	ALL
	Equipment		
	Engine Shop	EA01	ALL
	<u>Readiness and Training</u>		TT00
Training Division		TT01	ALL
Dive Locker Division		DV01	ALL
Dive Work Center		DC01	ALL
Dive Chamber Systems Division		DS01	ALL

STANDARD WORK CENTER CODES FOR EXPLOSIVE ORDINANCE DISPOSAL UNITS

<u>WORK CENTER NAME</u>	<u>DIVISION W/C</u>	<u>W/C CODES</u>	<u>UNIT(S)</u>
	Dive Systems Work Center	DS02	Fly Away
	Recompression Chamber Air Operations	DC01 VA01	A/R A/R
<u>Communication Department</u>		CS00	ALL
	Communications Division	CS01	NOTE 2
	Radio Work Center	CS02	A/R
	ADP Center	CS03	A/R
	ET Shop	CS04	A/R
<u>Operations Department/ Detachments</u>			NOTE 3
	EOD DET	EX##	ALL
	EOD Equipment	EO##	A/R
	Dive Equipment	DV##	A/R
	FADL	DL01	ALL
	Magnetometer	DM01	ALL
	Shore DETS		NOTE 4
	Mine Counter Measures	MC##	A/R
	Combat Expeditionary Support	CE##	A/R
	Special Operation Force	SF##	A/R
	Underwater/IED	UD##	A/R
	Surface/IED	SD##	A/R
	Chemical NUC	CZ##	A/R
	Mobile Ashore Support Team	RS02	ALL

APPENDIX C₂B

STANDARD WORK CENTER CODES FOR MOBILE DIVING AND SALVAGE UNITS

<u>WORK CENTER NAME</u>	<u>DIVISION W/C</u>	<u>W/C CODES</u>	<u>UNIT(S)</u>	
<u>Administration Department</u>		XX00	ALL	
	Administration Division	XX01	ALL	
	Administration	XX02	ALL	
	Safety	XS01	ALL	
<u>Medical Department</u>		MH00	ALL	
	Medical Division	MH01	ALL	
	Medical	MH02	ALL	
<u>Supply Department</u>		SUPP	ALL	
	Supply Division	SS01	ALL	
	Central Tool Room	SC01	NOTE 1	
	Central Store Room	ST01	ALL	
	HAZMAT	HZ01	ALL	
	DTO	SS01	A/R	
<u>Stock Department</u>		STCK	ALL	
	Stock Division	STOK	ALL	
	Stock	STK	ALL	
<u>Weapons Department</u>		WG00	ALL	
	Weapons Division	WG01	ALL	
	Weapons (Small Arms)	WG02	ALL	
	Weapons (Crew Served)	WG03	A/R	
<u>Maintenance/Support Department</u>		AA00	ALL	
	Maintenance Division	AA01	ALL	
	CESE/Vehicles	AL01	ALL	
	Dispatch	AO01	ALL	
	Boat Shop (Deck)	DA01	ALL	
	Small Boats (Inflatable)	DB01	ALL	
	Repair (Hull/Fabrication/ Welding)	ER01	ALL	
	Engineering DC Equipment	ER02	ALL	
	Engine Shop	EA01	ALL	
	Salvage Gear (Yellow Gear)	SG01	ALL	
	<u>Readiness and Training</u>	Chamber Systems	DS01	ALL
	<u>Operations Department/ Detachments</u>	Detachment 2 (LANT)	SE02	
		Detachment 3 DV (PAC)	SE03	
Detachment 3 SL (PAC)		SE33		
Detachment 4 (LANT)		SE04		
Detachment 5 DV (PAC)		SE05		

STANDARD WORK CENTER CODES FOR MOBILE DIVING AND SALVAGE UNITS (Cont'd)

<u>WORK CENTER NAME</u>	<u>DIVISION W/C</u>	<u>W/C CODES</u>	<u>UNIT(S)</u>
	Detachment 5 SL (PAC)	SE55	
	Detachment 6 (LANT)	SE06	
	Detachment 7 DV (PAC)	SE07	
	Detachment 7 SL (PAC)	SE77	
	Detachment 8 (LANT)	SE08	
	Detachment 9 DV (PAC)	SE09	
	Detachment 9 SL (PAC)	SE99	
	Detachment 10 (LANT)	SE10	
	Detachment 11 DV (PAC)	SE01	
	Detachment 11 SL (PAC)	SE11	
	Detachment 12 (LANT)	SE12	
	Detachment 20 (LANT)	SE20	
	Detachment 13 DV (PAC)	SE13	
	Detachment 13 SL (PAC)	SE31	
	Detachment 30 (LANT)	SE30	
	Communications	CS01	

APPENDIX C₂C

STANDARD WORK CENTER CODES FOR EOD TRAINING EVALUATION UNITS

<u>WORK CENTER NAME</u>	<u>DIVISION W/C</u>	<u>W/C CODES</u>	<u>UNIT(S)</u>
<u>Administration Department</u>		XX00	ALL
	Administration Division	XX01	ALL
	Administration	XX02	ALL
	Safety	XS01	ALL
<u>Medical Department</u>		MH00	ALL
	Medical Division	MH01	ALL
	Medical	MH02	ALL
<u>Supply Department</u>		SUPP	ALL
	Supply Division	SS01	ALL
	Central Tool Room	SC01	NOTE 1
	Central Store Room	ST01	ALL
	HAZMAT	HZ01	ALL
	DTO	SS01	A/R
<u>Stock Department</u>		STCK	ALL
	Stock Division	STOK	ALL
	Stock	STK	ALL
<u>Weapons Department</u>		WG00	ALL
	Weapons Division	WG01	ALL
	Weapons (Small Arms)	WG02	ALL
	Weapons (Crew Served)	WG03	A/R
<u>Maintenance Department</u>		AA00	ALL
	Maintenance Division	AA01	ALL
	CESE/Vehicles	AL01	ALL
	Dispatch	AO01	ALL
	Boat Shop Division	DA01	ALL
<u>Readiness and Training</u>		RD00	A/R
	Training Division	TT01	ALL
	Dive Lockers	DV01	ALL
	Air Operations	VA01	ALL
<u>Communication Department</u>		CS00	NOTE 2
	Communications Division	CS01	ALL
	ADP Center	CS02	A/R
	ET Shop	CS03	
<u>Operations Department/ Detachments</u>		ED##	ALL
	Ordinance Clearing Diver	ED##	ALL
	Dive Chamber Systems	DS##	ALL
	Shore DETS		
	Underwater/IED	UD##	
	Surface/IED	SD##	
	Chemical NUC	CZ##	
Dive Locker	DV01		

(This Page Intentionally Left Blank)

APPENDIX C₂DSTANDARD WORK CENTER CODES FOR MOBILE SECURITY SQUADRON/NAVY COASTAL
WARFARE SQUADRON

<u>WORK CENTER NAME</u>	<u>DIVISION W/C</u>	<u>W/C CODES</u>	<u>UNIT(S)</u>
<u>Administration Department</u>		XX00	ALL
	Administration Division	XX01	ALL
	Administration	XX02	ALL
	Safety	XS01	ALL
<u>Medical Department</u>		MH00	ALL
	Medical Division	MH01	ALL
	Medical	MH02	ALL
<u>Supply Department</u>		SUPP	
	Supply Division	SS01	ALL
	Central Tool Room	SC01	NOTE 1
	Central Store Room	ST01	ALL
	HAZMAT	HZ01	ALL
	DTO	SS01	
<u>Stock Department</u>		STCK	ALL
	Stock Division	STOK	ALL
	Stock	STK	ALL
<u>Weapons Department</u>		WG00	
	Weapons Division	WG01	ALL
	Weapons (Small Arms)	WG02	ALL
	Weapons (Crew Served)	WG03	
<u>Maintenance Department</u>		AA00	
	Maintenance Division	AA01	
	CESE/Vehicles	AL01	ALL
	Dispatch	AO01	ALL
	Boat Shop	DA01	ALL
	Repair (Hull/Fabrication/ Welding)	ER01	ALL
<u>Training</u>		TT00	ALL
<u>Operations Department</u>		CS00	
	Operations Division		
	Mobile Ashore Support Team	RS02	ALL
	Radar Sonar Surveillance Center (RSSC)	RS01	ALL
	Maritime Operations Center	OC01	ALL
	Communications	CS01	NOTE 2
	ADP Center	CS02	
	ET Shop	CS03	

**STANDARD WORK CENTER CODES FOR MOBILE SECURITY SQUADRON/NAVY COASTAL
WARFARE SQUADRON (Cont'd)**

<u>WORK CENTER NAME</u>	<u>DIVISION W/C</u>	<u>W/C CODES</u>	<u>UNIT(S)</u>
<u>Boats and Service Craft</u>		DB00	NOTE 5
	Boat Division	DB01	
	Patrol Craft	CP01	ALL
	Utility Craft	CU01	ALL

APPENDIX C₂E

STANDARD WORK CENTER CODES FOR RIVERINE SQUADRONS

<u>WORK CENTER NAME</u>	<u>DIVISION W/C</u>	<u>W/C CODES</u>	<u>UNIT(S)</u>
<u>Administration Department</u>		XX00	ALL
	Administration Division	XX01	ALL
	Administration	XX02	ALL
	Safety	XS01	ALL
<u>Medical Department</u>		MH00	ALL
	Medical Division	MH01	ALL
	Medical	MH02	ALL
<u>Supply Department</u>		SUPP	
	Supply Division	SS01	ALL
	Central Tool Room	SC01	NOTE 1
	Central Store Room	ST01	ALL
	Stock Control	STK	ALL
	HAZMAT	HZ01	ALL
<u>Weapons Department</u>		WG00	
	Weapons Division	WG01	ALL
	Weapons (Small Arms)	WG02	ALL
	Weapons (Crew Served)	WG03	ALL
<u>Stock Department</u>		STCK	ALL
	Stock Division	STOK	ALL
	Stock	STK	ALL
<u>Boat Shop</u>		DA00	
	Boat Division	DA01	ALL
	Boat Work Center (Maint)	DA02	
	Boats (Individual)	CA01	A/R
<u>CESE Maintenance Department</u>		AA00	
	Maintenance Division	AA01	
	CESE Maintenance	AA02	ALL
	CESE/CEEI	AL01	ALL
	Dispatch	AO01	
<u>Communication Department</u>		CS00	ALL
	Communications Division	CS01	ALL
	Radar	CS02	ALL
	Radio	CS03	ALL

(This Page Intentionally Left Blank)

APPENDIX C₂F

STANDARD WORK CENTER CODES FOR NAVY MOBILE CONSTRUCTION BATTALIONS

<u>WORK CENTER NAME</u>	<u>DIVISION W/C</u>	<u>W/C CODES</u>	<u>UNIT(S)</u>
<u>Administration Department</u>		XX00	ALL
	Administration Division	XX01	ALL
	Administration	XX02	ALL
	Safety	XS01	ALL
<u>Medical Department</u>		MH00	ALL
	Medical Division	MH01	ALL
	Medical	MH02	ALL
	Dental	MH03	ALL
<u>Supply Department</u>		SUPP	
	Supply Division	SS01	ALL
	Central Tool Room	SC01	ALL
	Central Store Room	ST01	ALL
	HAZMAT	HZ01	ALL
	DTO	SS01	
<u>Stock Department</u>		STCK	ALL
	Stock Division	STOK	ALL
	Stock	STK	ALL
<u>Alfa Company</u>		AA00	
	Alfa Division	AA01	ALL
	Cranes	AC13/AC15	ALL
	Heavy Shop (CESE)	AH03/AH05	ALL
	Light Shop (CESE)	AL03/AL05	ALL
	Mineral Products	AM05	ALL
	Machine Shop	AS01	ALL
	5000 Shop	AT03/AT05	ALL
	Dispatch	AO01	ALL
	<u>Bravo Company</u>		BB00
Bravo Co. Division		BB01	ALL
BU/SW Shop		BU01	ALL
UT/CE Shop		BE01	ALL
CBR		BR01	ALL
<u>Training</u>		TT00	ALL
	Training Division	TT01	ALL
	Weapons (Small Arms)	WG01	ALL
	Weapons (Crew Served)	WG02	
<u>Communication Department</u>		CS00	ALL
	Communications Division	CS01	ALL
	Communications Work Center	CS02	ALL

(This Page Intentionally Left Blank)

APPENDIX C₂G

STANDARD WORK CENTER CODES FOR SEABEE READINESS GROUP

<u>WORK CENTER NAME</u>	<u>DIVISION W/C</u>	<u>W/C CODES</u>	<u>UNIT(S)</u>	
<u>Alfa Company</u>		AA00		
	Alfa Division	AA01	ALL	
	Cranes	AC03/AC13	ALL	
	Heavy Shop (CESE)	AH03/AH13	ALL	
	Light Shop (CESE)	AL03/AL13	ALL	
	Mineral Products	AM05	ALL	
	Machine Shop	AS01	ALL	
	5000 Shop	AT03/AT13	ALL	
	Dispatch	AO01/AO11	ALL	
<u>Bravo Company</u>		BB00		
	Bravo Division	BB01		
	Builder/SW Shop	BU01		
	CE/UT Shop	BE01		
	CEEI - TOA	BT01		
	CBR	BR01	ALL	
<u>Training Department</u>		TT00	ALL	
	Training Division	TT01		
	SRG Weapons (Small Arms)	WG01		
	SRG Weapons (Crew Served)	WG02		
	BATT Set #1 (Small Arms)	WG11		
	BATT Set #1 (Crew Served)	WG12		
	BATT Set #2 (Small Arms)	WG21		
	BATT Set #2 (Crew Served)	WG22		
	BATT Set #3 (Small Arms)	WG31		
	BATT Set #3 (Crew Served)	WG32		
		CS00	ALL	
	<u>Communication Department</u>	Communications Division	CS01	ALL
		SRG	CS02	ALL
BATT Set #1		CS03		
BATT Set #2		CS04		
BATT Set #3		CS05		

(This Page Intentionally Left Blank)

APPENDIX C₂H

STANDARD WORK CENTER CODES FOR CONSTRUCTION BATTALION MOBILE UNITS

<u>WORK CENTER NAME</u>	<u>DIVISION W/C</u>	<u>W/C CODES</u>	<u>UNIT(S)</u>
<u>Administration Department</u>		XX00	ALL
	Administration Division	XX01	ALL
	Administration	XX02	ALL
	Safety	XS01	ALL
	Medical	MH01	ALL
<u>Supply Department</u>		SUPP	
	Supply Division	SS01	ALL
	Central Tool Room	SC01	NOTE 1
	Central Store Room	ST01	ALL
	HAZMAT	HZ01	ALL
	Material Liaison Office	SM01	
	DTO	SS01	
<u>Stock Department</u>		STCK	ALL
	Stock Division	STOK	ALL
	Stock	STK	ALL
<u>Alfa Company</u>		AA00	ALL
	Alfa Division	AA01	ALL
	Heavy Shop (CESE)	AH03	ALL
	Light Shop (CESE)	AL03	ALL
	Dispatch	AO01	ALL
	Augment Equipment	AG05	
	5000 Shop	AT03	
<u>Bravo Company</u>		BB00	
	Bravo Division	BB01	
	Builder/SW Shop	BU01	
	CE/UT Shop	BE01	
	CEEI - TOA	BT01	
	CBR	BR01	ALL
<u>Communication</u>		CS00	
	Communications Division	CS01	ALL
	Tactical COMMS	CS02	ALL
<u>Training</u>		TT01	ALL
	Training Division	TT02	ALL
	Weapons Division (Small Arms)	WG01	ALL
	Weapons Division (Crew Served)	WG02	ALL
<u>Detachments DC</u>			
	Maintenance Division (CESE)	D103	
	Organic CESE	D104	
	Augment CESE	D105	
	Dispatch	D106	

**STANDARD WORK CENTER CODES FOR CONSTRUCTION BATTALION MOBILE UNITS
(Cont'd)**

<u>WORK CENTER NAME</u>	<u>DIVISION W/C</u>	<u>W/C CODES</u>	<u>UNIT(S)</u>
	Maintenance Division (Non-CESE)	D108	
	Builder/SW Shop	D109	
	CE/UT Shop	D110	
	CEEI/CBR	D111	
	Weapons Division-TOA	D112	
	Safety/HAZMAT	D113	
	Central Tool Room	D114	
 <u>202 DET PREFIX CODES</u>		<u>303 DET PREFIX CODES</u>	
DET DC - D1		DET Bangor - D1	
DET KB - D2		DET Fallen - D2	
DET JAX -D3		DET Lemoore - D3	
DET KW - D4		DET Pearl Harbor - D4	
DET CL - D5			

APPENDIX C₂I

STANDARD WORK CENTER CODES FOR UNDERWATER CONSTRUCTION TEAMS

<u>WORK CENTER NAME</u>	<u>DIVISION W/C</u>	<u>W/C CODES</u>	<u>UNIT(S)</u>	
<u>Administration Department</u>		XX00	ALL	
	Administration Division	XX01	ALL	
	Administration	XX02	ALL	
	Safety	XS01	ALL	
	Engineering Aid	XE01	ALL	
<u>Medical Department</u>		MH00	ALL	
	Medical Division	MH01	ALL	
	Medical	MH02	ALL	
<u>Supply Department</u>		SUPP		
	Supply Division	SS01	ALL	
	Central Store Room	ST01	ALL	
	HAZMAT	HZ01	ALL	
	DTO	SS01		
<u>Stock Department</u>		STCK	ALL	
	Stock Division	STOK	ALL	
	Stock	STK	ALL	
<u>Training</u>		TT00	ALL	
	Training Division	TT01	ALL	
	Weapons (Small Arms)	WG01	ALL	
	Weapons (Crew Served)	WG02		
<u>Communication</u>		CS00		
	Communications Division	CS01	ALL	
	Communications	CS02	ALL	
<u>Readiness Department</u>		RD00	ALL	
	Readiness Division	RD01	ALL	
	Boat Shop	DA01	ALL	
	Maintenance (CESE)	AL01	ALL	
	Dive Systems	DS00	ALL	
	Fly Away Dive System	DC00	ALL	
	SNDL Recompression Chamber	DC04	ALL	
	Dive Equipment	DL01	ALL	
	Central Tool Room	SC01	ALL	
	Facilities	NF02	ALL	
	<u>Operations Department</u>		OD00	ALL
		Operations Division	OD01	ALL
		Air DET ALFA	AD01	
BRAVO		AD02	ALL	
CHARLIE		AD03		
Lightweight Dive System		DS11/DS12/DS13	ALL	
Trans. Recompression Chamber		DC11/DC12/DC13	ALL	

STANDARD WORK CENTER CODES FOR UNDERWATER CONSTRUCTION TEAMS

<u>WORK CENTER NAME</u>	<u>DIVISION W/C</u>	<u>W/C CODES</u>	<u>UNIT(S)</u>
	TOA Equipment (Non-CESE)	TA11/TA12/TA13	ALL
	Weapons	WG11/WG12/WG13	ALL
	Communications	CS11/CS12/CS13	ALL
	Dive Boat	CU11/CU12/CU13	ALL

APPENDIX C₂JSTANDARD WORK CENTER CODES FOR NAVY MOBILE CONSTRUCTION BATTALIONS
FORWARD HEADQUARTERS

<u>WORK CENTER NAME</u>	<u>DIVISION W/C</u>	<u>W/C CODES</u>	<u>UNIT(S)</u>
<u>Administration Department</u>		XX01	ALL
	PS/YN Division	XX02	ALL
	Medical	MH01	ALL
	3MC	XO01	ALL
<u>Communication Department</u>		CS01	
	Communications	CS02	
<u>Supply Department</u>		SS01	
	Supply DIV	SS02	
	Central Tool Room	SS03	
	Material Liaison Office	SS04	
	Control Store Room	SS05	
	DTO	SS01	
<u>Stock Department</u>		STCK	
	Stock Div	STOK	
	Stock	STK	

(This Page Intentionally Left Blank)

APPENDIX C₂K

STANDARD WORK CENTER CODES FOR NCF FWD DETACHMENTS

<u>WORK CENTER NAME</u>	<u>DIVISION W/C</u>	<u>W/C CODES</u>	<u>UNIT(S)</u>
<u>Detachment 3MA</u>		XO11	
<u>CESE Maint Div</u>		AA11	
	CESE/CEEI Maintenance	AL11	
	Dispatch	AO11	
<u>Non-CESE Maint Div</u>		BC11	
	Weapons Division	WG11	
	Safety/HAZMAT	SZ11	
	Communication	CS11	
<u>DET Supply</u>		SS11	
	Central Tool Room	SC11	

Detachment Codes

11 - Camp Moreell	12 - Falluja
13 - Balad	14 - TQ
15 - Al Asad	16 - Ramadi
17 - Bagram	

(This Page Intentionally Left Blank)

APPENDIX C₂L

STANDARD WORK CENTER CODES FOR NAVY EXPEDITIONARY LOGISTICS SUPPORT GROUP

<u>WORK CENTER NAME</u>	<u>DIVISION W/C</u>	<u>W/C CODES</u>	<u>UNIT(S)</u>
<u>Administration Department</u>		XX00	
	Administration Division	XX01	
	Administration	XX02	
	Safety	XS01	
	Medical	MH01	
<u>Supply Department</u>		SUPP	
	Supply	SS01	
	Central Tool Room	SC01	NOTE 1
	Central Store Room	ST01	ALL
	HAZMAT	HZ01	ALL
	DTO	SS01	
<u>Stock Department</u>		STCK	ALL
	Stock Division	STOK	ALL
	Stock	STK	ALL
<u>Operations Department</u>		OD00	
	Operations	OD01	
<u>Planning Department</u>		PA00	
	Plans	PA01	
<u>Training</u>		TT00	ALL
	Training Support	TT01	ALL
<u>Communication Department</u>		CS00	NOTE 2
	Communications	CS01	
	ADP Center	CS03	
<u>Engineering Department</u>		AA00	
	CESE/Vehicles	AL01	ALL
	Dispatch	AO01	ALL
	Engineering (DC Equip/ Facilities)	ER02	ALL
	Non-CESE (Hatch Boxes)	EH01	
	Weapons Division	WG01	ALL
	Weapons (Small Arms)	WG02	ALL
	Weapons (Crew Served)	WG03	

(This Page Intentionally Left Blank)

APPENDIX C₂M

STANDARD WORK CENTER CODES FOR NAVY CARGO HANDLING BATTALION ONE

<u>WORK CENTER NAME</u>	<u>DIVISION W/C</u>	<u>W/C CODES</u>	<u>UNIT(S)</u>	
<u>Administration Department</u>		XX00		
	Administration Division	XX01		
	Administration	XX02		
	Safety	XS01		
	Medical	MH01		
<u>Supply Department</u>		SUPP		
	Supply Division	SS01		
	Central Tool Room (Hatch Boxes)	SC01	NOTE 1	
	Central Store Room	ST01	ALL	
	HAZMAT	HZ01	ALL	
	DTO	SS01		
<u>Stock Department</u>		STCK	ALL	
	Stock Division	STOK	ALL	
	Stock	STK	ALL	
<u>Operations Department</u>		OD00	NOTE 2	
	Operations Division	OD01		
	Plans	PA01		
	Communications	CS01		
	ADP Center	CS03		
<u>Training</u>		TT00	ALL	
	Training Support Division	TT01	ALL	
	CISO	TT02		
	Schedules/Quotas	TQ01		
	Graphics	TG01		
	School House	TS01		
	Curriculum	TS01		
<u>Platforms</u>		PA00		
	Platforms Division	PA01		
	Land Ship	PL01		
	Cape Ship	PS01		
	Crane Site	PC01		
<u>Engineering Department</u>		AA00		
	CESE/Vehicles Division	AL01	ALL	
	Dispatch	AO01	ALL	
	Engineering (DC Equip/Facilities)	ER02	ALL	
	Non-CESE (Hatch Boxes)	EH01		
	Weapons Division	WG01	ALL	
	Weapons (Small Arms)	WG02	ALL	
	Weapons (Crew Served)	WG03		

(This Page Intentionally Left Blank)

APPENDIX C₃

STANDARD WORK CENTER CODES FOR NAVAL SUBMARINE FORCE SHIPS

Appendix C ₃ A	Standard Work Center Codes for Submarines
Appendix C ₃ B	Standard Work Center Codes for Submarine Force Surface Ships
Appendix C ₃ C	Standard Work Center Codes for Small Boat and Service Craft Managers (Submarine Force Only)
Appendix C ₃ D	Standard Work Center Codes for Tugs and Retrievers (Submarine Force Only)

(This Page Intentionally Left Blank)

APPENDIX C₃A
STANDARD WORK CENTER CODES FOR SUBMARINES

Description	Used by Submarine Type	Code
<u>Executive</u>		
Executive/Administration (ADM - Functional Area Supervisor - SNAP)	All	XX00
Chief of the Boat	All	XX03
3-M Coordinator (SNAP OMMS Functional Area Supervisor)	All	XM01
Safety Petty Officer	All	SP01
<u>Engineering</u>		
Auxiliary	All	EA01
Damage Control Petty Officer (Note 1)	All	EDC1
Electrical (Main Power - SS)	All	EE01
Machinery	All	EM01
Engineering Administration	All	EX00
Engineering Log Room	All	EX02
Field Calibration	All	FCA1
Reactor Controls	All Nuclear	RC01
Engineering Laboratory	All	RL01
Nuclear Alteration Administration	All	RXFC
<u>Medical</u>		
Medical	All	MH01
<u>Navigation/Operations</u>		
Navigation/Electronics	All	NE01
Micro Miniature Repair (2M)	SSBN/SSGN	NE02
Radio/Communications	All	OC01
Afloat Information Systems/Automated Data Processing Coordinator (AIS/ADP)	All	OC02
Navigation/Operations Administration	All	OX00
<u>Research and Development</u>		
Mission Auxiliary	SSN-23 Only	MA01
Mission Electronics	SSN-23 Only	ME01
Mission Navigation	SSN-23 Only	MN01
Mission Auxiliary Support	SSN-23 Only	MV02

Description	Used by Submarine Type	Code
<u>Supply</u>		
General Stores	All	SS01
Food Services	All	SS02
Supply Administration (SNAP Functional Area Supervisor)	All	SX00
<u>Weapons</u>		
Divers	All	DV01
Central Computer (Tactical/Strategic)	SSN-688/SSN-21/SSBN/SSGN	WC01
Fire Control	All	WF01
Missile Fire Control	SSBN/SSGN	WF02
First Lieutenant	All	WK01
Dry Deck Shelter	774 Class	WK02
Special Operations Forces Support	SSGN	WK02
Sonar	All	WQ01
Torpedo	All	WI01
Missile Technicians	SSBN/SSGN	WM01
Missile Launcher	All	WS01
Weapons Administration	All	WX00

Note:

1. When Squadron must generate a CSMP deferral for the submarine, the Squadron will use the correct ship's work center and the Job Sequence Number (JSN) that is generated by Regional Maintenance Automated Information System (RMAIS). Example: EM01-Q123, Q denotes that the JSN was created by RMAIS.

APPENDIX C₃B

STANDARD WORK CENTER CODES FOR SUBMARINE FORCE SURFACE SHIPS

Description	Used by Ship Type	Code
<u>Deck</u>		
1 st Division	ARDM	DA01
Boat Division	AS/ARDM	DB01
<u>Engineering</u>		
Auxiliary Division	ARDM	EA01
Crane Maintenance	ARDM	EC01
Lighting and Power	ARDM	EE01
Pipe/Metal Shop	ARDM	ER01
Carpenter/Docking	ARDM	ER02
Damage Control Petty Officer	All	EDC1
Engineering Administration	All	EX00
Engineering Logroom	All	EX02
Calibration	ARDM	FCA1
<u>Medical</u>		
Medical	All	MH01
Dental	AS	MD01
<u>Navigation/Operations</u>		
Afloat Information Systems/Automated Data Processing Coordinator (AIS/ADP)	All	OC02
<u>Supply</u>		
Supply Administration	All	SX00
General Stores/Supply	All	SS01
Ship's Store	AS	SS03
Disbursing	AS	SS04
Inventory Control	AS	SS05
SUBSAT	AS	SS07
Post Office	AS	SS08
ROVSS	AS	SS09
<u>Weapons</u>		
Armory/Magazine	AS	WK02
Gunnery	AS/ARDM	WI05
Weapons Administration	All	WX00

STANDARD WORK CENTER CODES FOR SUBMARINE FORCE SURFACE SHIPS (Cont'd)

Description	Used by Ship Type	Code
Weapons Repair	AS	W10B
Fire Control Repair	AS	W67E
Weight Test	AS	W72D
Weapons Alarms systems	AS	W91D
Torpedo/Missiles repair	AS	W91E
Weapons QA	AS	W91Q
<u>Executive</u>		
Executive Administration	AS	XX00
3-M Coordinator	All	XM01
Safety Petty Officer	All	SP01
Personnel Office	All	XX02
<u>Repair</u>		
Tool Room	AS	R06B
Repair Administration	AS	R10A
Planning P&E	AS	R10C
Tech Library	AS	R10E
Shipfitter/welding	AS	R11A
Sheet metal/Wood working	AS	R17A
Shore Services	AS	R25D
Welding	AS	R26A
Inside Machine shop	AS	R31A
Engraving shop	AS	R31B
Diesel shop	AS	R31C
Valve shop	AS	R31D
Engine and Governor shop	AS	R31E
Hydraulics shop	AS	R31F
Optical shop	AS	R35A
Print shop	AS	R37A
Outside Machine shop	AS	R38A
Nuc Repair	AS	R38N
Photo/Repair Admin/Print	AS	R39A
Elect Repair/Motor Rewind	AS	R51A
Outside Electrical shop	AS	R51B
IC Shop	AS	R51G
Pipe shop/Powder Coat shop	AS	R56A

STANDARD WORK CENTER CODES FOR SUBMARINE FORCE SURFACE SHIPS (Cont'd)

Description	Used by Ship Type	Code
AC&R shop	AS	R56B
Flex Hose shop	AS	R56C
Insulation Lagging/Canvas shop	AS	R57A
Rubber and Plastics	AS	R57B
Woodworking shop	AS	R64A
Key and lock shop	AS	R64E
General Electronics/Computer Repair	AS	R67A
Calibration	AS	R67B
Mast & Antenna shop	AS	R67H
2M Repair	AS	R67M
Rigging services	AS	R72A
Dive Locker	AS	R72B
Dive Locker (fly away team)	AS	R72F
Sail and Canvas	AS	R74A
Sound & analysis	AS	R92A
NDT/QA	AS	R93A
QA	AS	R93B
Radiological Controls	AS	R94A
MIRCS Lab	AS	R96A

(This Page Intentionally Left Blank)

APPENDIX C₃C

**STANDARD WORK CENTER CODES FOR
SMALL BOAT AND SERVICE CRAFT MANAGERS
(Submarine Force Only)**

Name	Code	Name	Code
COMSUBRON ONE	PS	SUBASE PEARL HARBOR (IMF)	PK
COMSUBRON SIX	TQ	TRIDENT Refit Facility BANGOR	PM
COMSUBRON SEVEN	PW	TRIDENT Refit Facility KINGS BAY	TM
COMSUBRON EIGHT	TW		
COMSUBRON ELEVEN	PQ		
COMSUBRON SEVENTEEN	PV	USS EMORY S. LAND (AS-39)	TJ
COMSUBRON TWENTY	TX	USS FRANK CABLE (AS-40)	TA
COMSUBRON TWENTY-TWO	TS		
NAVSUBSUPPFAC NLON	TK		
SUBASE BANGOR	PY		
SUBASE KINGS BAY	TY		
SUBASE NLON	TC		

(This Page Intentionally Left Blank)

APPENDIX C₃D
STANDARD WORK CENTER CODES FOR
TUGS AND RETRIEVERS
(Submarine Force Only)

Description	Used by Ship Type	Code
Engineering	TWR/YTB/YTM	TE01
Other	TWR/YTB/YTM	TD01
Safety Petty Officer	TWR/YTB/YTM	SP01

(This Page Intentionally Left Blank)

APPENDIX C₄**STANDARD WORK CENTER CODES FOR NAVAL SURFACE FORCE SHIPS AND SHORE
COMMANDS**

Appendix C ₄ A	Standard Work Center Codes for LPD-4 Class Ships
Appendix C ₄ B	Standard Work Center Codes for PC Class Ships
Appendix C ₄ C	Standard Work Center Codes for MCM Class Ships
Appendix C ₄ D	Standard Work Center Codes for LSD Class Ships
Appendix C ₄ E	Standard Work Center Codes for LHA/LHD Class Ships
Appendix C ₄ F	Standard Work Center Codes for CG/DDG/FFG Class Ships
Appendix C ₄ G	Standard Work Center Codes for LCS Class Ships
Appendix C ₄ H	Standard Work Center Codes for LCC-19 Class Ships
Appendix C ₄ I	Standard Work Center Codes for LPD-17 Class Ships
Appendix C ₄ J	Standard Work Center Codes for DDG-1000 Class Ships
Appendix C ₄ K	Standard Work Center Codes for NBU-7 Command

(This Page Intentionally Left Blank)

APPENDIX C₄A
STANDARD WORK CENTER CODES FOR
LPD-4 CLASS SHIPS

<u>DEPARTMENT</u>	<u>DIVISION W/C</u>	<u>SHIP CODE</u>	<u>CLASS</u>
<u>EXECUTIVE DEPARTMENT</u>	EX		
	PERSONNEL	EX01	ALL
	ADMIN	EX02	Can Be Combined With EX01
	3MC	EX03	ALL MDS ONLY
	MAA	EX04	ALL
	OFF SHIP SERVICES	ES01	ALL Contains All X Service XRICS MDS ONLY
<u>MEDICAL DEPARTMENT</u>	MH		
	MEDICAL	MH01	ALL
<u>DENTAL DEPARTMENT</u>	MD		
	DENTAL	MD01	AS REQUIRED
<u>SUPPLY DEPARTMENT</u>	S1		
	STOCK CONTROL	SS01	ALL
	HAZMAT/ENVIRONMENTAL	HE01	ALL
	AVIATION STORES	SS06	AS REQUIRED
	S2		
	FOOD SERVICE	SS02	ALL
	WARD ROOM	SS05	AS REQUIRED
	S3		
	SHIP SERVICES	SS03	ALL
<u>DECK DEPARTMENT</u>	DA		
	DECK	DA01	ALL
	BOATS	DA02	AS REQUIRED
		DA03	AS REQUIRED
	DB		
	SECOND	DB01	ALL
		DB02	AS REQUIRED
		DB03	AS REQUIRED
<u>ENGINEERING DEPARTMENT</u>	EA		
	AUXILIARY EN	EA01	ALL
	ENGINE SHOP	EA02	AS REQUIRED
	HYDRAULICS	EA04	ALL

<u>DEPARTMENT</u>	<u>DIVISION W/C</u>	<u>SHIP CODE</u>	<u>CLASS</u>
	AC&R	EA05	ALL
	EE		
	ELEC TOOL ISSUE/SAFETY	EE01	ALL
	ELECTRICAL SHOP	EE02	ALL
	INTERIOR COMMS	EE03	ALL
	SITE TELEVISION	EE04	AS REQUIRED
	EM		
	MAIN MACHINERY RM 1	EM01	ALL
	MAIN MACHINERY RM 2	EM02	ALL
	AUX MACHINERY RM 1	EM03	ALL
	AUX MACHINERY RM 2	EM04	ALL
	OIL LAB	EB14	ALL
	GAGE CAL	FCA1	ALL
	ER		
	HULL REPAIR	ER01	ALL
	MACHINERY REPAIR	ER03	ALL
	DAMAGE CONTROL	ER04	ALL
	DCPO	ER09	ALL
	ENGINEERING ADMIN	EX00	AS REQUIRED
<u>AIR DEPARTMENT</u>			
	V		
	FLIGHT DECK	V101	ALL
	AVIATION FUELS	V401	ALL
	GROUND SUPPORT EQUIPMENT	VM04	ALL
<u>OPERATIONS DEPARTMENT</u>			
	OC		
	RADIO	OC01	ALL
	LAN/ADP	OC02	ALL
	OE		
	ELECTRONICS	OE01	ALL
	RADARS	OE05	ALL
	2-M REPAIR	OE03	ALL
	TEST EQUIPT ELEC CAL	OE04	ALL
	OI		
	CIC	OI01	ALL
	NAVIGATION	OI02	ALL
	ELECTRONIC WARFARE	OT01	ALL
	OW		
	GUNNERY/ARMORY	OW03	ALL
	FORCE PROTECTION		
	CIWS	OW04	ALL

APPENDIX C₄B
STANDARD WORK CENTER CODES FOR
PC CLASS SHIPS

<u>DEPARTMENT</u>	<u>DIVISION W/C</u>	<u>W/C CODE</u>	<u>CLASS</u>
<u>EXECUTIVE DEPARTMENT</u>	EX		
	OFF SHIP SERVICES	ES01	ALL
	MEDICAL	MH01	ALL
	3MC	XX03	
<u>ENGINEERING DEPARTMENT</u>	EN		
	ELECTRICAL SHOP	EE02	ALL
	MER FWD	EM01	ALL
	MER AFT	EM02	ALL
	DCPO	ER09	ALL
<u>OPERATIONS DEPARTMENT</u>	OP		
	RADIO	IS01	ALL
	ARMORY/FORCE PROTECTION	CG03	ALL
	NAVIGATION	OI02	ALL
	DECK	OD01	ALL
	CIC	OI01	ALL

(This Page Intentionally Left Blank)

APPENDIX C₄C
STANDARD WORK CENTER CODES FOR
MCM CLASS SHIPS

<u>DEPARTMENT</u>	<u>DIVISION W/C</u>	<u>SHIP CODE</u>	<u>CLASS</u>
<u>ENGINEERING</u> <u>DEPARTMENT</u>	EE		
	ELECTRICAL SHOP	EE02	ALL
	EM		
	AUXILIARY	EA01	ALL
	MER	EM01	ALL
	AMR	EM02	ALL
	OIL LAB	EB14	ALL
	FLEET CAL ACTIVITY	FCA1	ALL
	ER		
	HULL REPAIR	ER01	ALL
DAMAGE CONTROL	ER04	ALL	
DCPO	ER09	ALL	
<u>EXEC</u> <u>DEPARTMENT</u>	EX		
	MEDICAL	EH01	ALL
	ADMIN	EX01	ALL
	3MC	EX03	ALL MDS ONLY
	OFF SHIP SERVICES	ES01	ALL Contains All X-Services XRICS MDS ONLY
<u>OPERATIONS</u> <u>DEPARTMENT</u>	OE		
	INTERIOR COMMS	OE02	ALL
	RADIO	OC01	ALL
	ELECTRONICS	OE01	ALL
	OI		
	CIC/MINE COUNT	OI01	ALL
	MEAS		
	NAVIGATION	OI02	ALL
	OD		
	DECK	OD01	ALL
ARMORY/FORCE PROTECTION	OD02	ALL	
<u>SUPPLY</u> <u>DEPARTMENT</u>	S1		
	GENERAL STORES	SS01	ALL
	FOOD SERVICE	SS02	ALL
	HAZ/ENV	HE01	ALL

(This Page Intentionally Left Blank)

APPENDIX C₄D
STANDARD WORK CENTER CODES FOR
LSD CLASS SHIPS

<u>DEPARTMENT</u>	<u>DIVISION W/C</u>	<u>SHIP CODE</u>	<u>CLASS</u>
<u>DECK</u> <u>DEPARTMENT</u>	DA		
	DECK BOATS	DA01	ALL
		DA02	AS REQUIRED
		DA03	AS REQUIRED
	DB		
		DB01	ALL
	DB02	AS REQUIRED	
	DB03	AS REQUIRED	
<u>ENGINEERING</u> <u>DEPARTMENT</u>	EA		
	ENGINE/BOAT SHOP	EA02	ALL
	HYDRAULICS	EA04	ALL
	AC&R	EA05	ALL
	EE		
	ELEC TOOL ISSUE/SAF	EE01	ALL
	ELECTRIC SHOP	EE02	ALL
	EM		
	MAIN MACHINERY RM 1	EM01	ALL
	MAIN MACHINERY RM 2	EM02	ALL
	AMR FWD	EM03	AS REQUIRED
	AMR AFT	EM04	AS REQUIRED
	OIL LAB	EB14	ALL
	GAGE CAL	FCA1	ALL
	ER		
	HULL REPAIR	ER01	ALL
	MACHINE SHOP	ER03	ALL
	DAMAGE CONTROL	ER04	ALL
DCPO	ER09	ALL	
<u>EXECUTIVE</u> <u>DEPARTMENT</u>	EX		
	ADMIN	EX01	ALL
	3MC	EX03	ALL MDS ONLY
	OFF SHIP SERVICES	ES01	Contains All X-Services XRICS MDS ONLY
	MAA	EX04	AS REQUIRED
<u>MEDICAL</u> <u>DEPARTMENT</u>	MH		
	MEDICAL	MH01	ALL

<u>DEPARTMENT</u>	<u>DIVISION W/C</u>	<u>SHIP CODE</u>	<u>CLASS</u>
<u>DENTAL</u> <u>DEPARTMENT</u>	DA DENTAL	DH01	ALL
<u>OPERATIONS</u> <u>DEPARTMENT</u>	OC RADIO LAN/ADP	OC01 OC02	ALL ALL
	OE IC SHOP ELECTRONICS 2-M REPAIR TEST EQUIPT ELEC CAL RADARS	OE06 OE01 OE03 OE04 OE05	ALL ALL ALL ALL ALL
	OI CIC ELECTRONIC WARFARE	OI01 OT01	ALL AS REQUIRED
	OW GWS FIRE CONTROL ARMORY/FORCE PROTECTION CIWS	OW02 OW03 OW04	ALL ALL ALL
<u>NAVIGATION</u>	NN NAVIGATION	NN01	ALL
<u>SUPPLY</u> <u>DEPARTMENT</u>	S1 STOCK CONTROL HAZ/ENV	SS01 HE01	ALL ALL
	S2 FOOD SERVICE	SS02	ALL
	S3 SHIP SERVICES	SS03	ALL

APPENDIX C₄E
STANDARD WORK CENTER CODES FOR
LHA/LHD CLASS SHIPS

<u>DEPARTMENT</u>	<u>DIVISION W/C</u>	<u>SHIP CODE</u>	<u>CLASS</u>
<u>AIMD DEPARTMENT</u>			
	IM		
	PRODUCTION/ QA/SUPPLY/TRAINING	IM01	ALL
	PWR PLANTS/AIRFRAMES	IM02	ALL
	AVIATION LIFE SUPPORT		
	ARMAMENT SUPPORT EQUIP/ CALIBRATION LAB	IM03	ALL
	AVIATION SUPPORT EQUIPMENT	IM04	ALL
<u>AIR DEPARTMENT</u>			
	V1		
	FLIGHT DECK	V101	ALL
	CRASH AND SALVAGE	V102	ALL
	V3		
	HANGER DECK	V301	ALL
	V4		
	FLIGHT DECK FUELS	V401	ALL
	BELOW DECK FUEL	V402	ALL
<u>CHAPLAIN DEPARTMENT</u>			
	CH		
	CHAP	CH01	Req'd If Chaplain Assigned
<u>COMBAT CARGO DEPARTMENT</u>			
	CD		
		CCD1	MDS ONLY
<u>COMBAT SYSTEMS DEPARTMENT</u>			
	CE		
	RADAR REPAIR	CE01	ALL
	COMMUNICATION REPAIR	CE02	ALL
	2-M REPAIR	CE03	ALL
	TEST EQUIP ELEC CAL	CE04	ALL
	IC SHOP	CE05	ALL
	INTERIOR COMM	CE06	ALL
	CCTV	CE07	ALL
	CF		
	ACDS	CSF1	ALL
	RADARS	CSF2	ALL
	CIWS	CSF3	ALL
	MISSILES (RAM, TAS)	CSF4	ALL
	CC		

<u>DEPARTMENT</u>	<u>DIVISION W/C</u>	<u>SHIP CODE</u>	<u>CLASS</u>
	RADIO	CC01	ALL
	LAN/ADP	CC02	ALL
	COMPUTER REPAIR	CC03	ALL
<u>DECK DEPARTMENT</u>			
	DA		
	FOWARD GEAR	DA01	ALL
	DB		
	AFT GEAR	DB01	ALL
<u>DENTAL DEPARTMENT</u>			
	MD		
	DENTAL	MD01	Req'd If Dentist Assigned
<u>ENGINEERING DEPARTMENT</u>			
	EA		
	AUX MACHINERY ROOM	EA01	As Required
	ENGINE SHOP	EA02	ALL
	STEAM SHOP (HOTEL SRV)	EA03	ALL
	AC&R	EA05	ALL
	AS		
	HYDRAULICS	AS01	ALL
	ASSAULT SHOP	AS02	ALL
	EE		
	ELEC TOOL ISSUE/SAFETY	EE01	ALL
	ELECTRIC SHOP	EE02	ALL
	POWER AND REWIND	EE03	ALL
	DISTRIBUTION	EE04	ALL
	EM		
	MAIN MACHINERY ROOM 1	EM01	ALL
	MAIN MACHINERY ROOM 2	EM02	ALL
	BOILER/ELECT CONTROL	EM03	ALL
	OIL LAB	EB14	ALL
	ER		
	HULL REPAIR	ER01	ALL
	MACHINE SHOP	ER03	ALL
	DAMAGE CONTROL REPR	ER04	ALL
	DCPO	ER09	ALL
<u>EXECUTIVE DEPARTMENT</u>			
	EX		
	ADMIN	EX01	ALL
	3MC	EX03	ALL
	MAA	EX04	ALL
	TRAINING	ET01	MDS ONLY
	OFF SHIP SERVICES	ES01	X-SERVICE XRICS MDS ONLY

<u>DEPARTMENT</u>	<u>DIVISION W/C</u>	<u>SHIP CODE</u>	<u>CLASS</u>
	VI MASS COMMUNICATION SPECIALIST	VI01	ALL
<u>MEDICAL DEPARTMENT</u>	MH MEDICAL	MH01	ALL
<u>NAVIGATION DEPARTMENT</u>	NN NAVIGATION	NN01	ALL
<u>OPERATIONS DEPARTMENT</u>	OC AIR TRAFFIC CONTROL	OC01	ALL
	OI CIC	OI01	ALL
	OT ELECTRONIC WARFARE CRYPTOLOGIC WARFARE	OT01 OT02	ALL As Required
	OZ JOINT INFORMATION CENTER	OZ01	ALL
<u>SAFETY DEPARTMENT</u>	SA SAFETY	SA01	ALL
<u>SUPPLY DEPARTMENT</u>	S1 STOCK CONTROL	SS01	ALL
	S2 FOOD SERVICE	SS02	ALL
	S3 SHIP SERVICES	SS03	ALL
	S5 WARD ROOM	SS05	ALL
	S6 AVIATION STORES	SS06	ALL
	S8 GENERAL STORES HAZMAT/ENVIRONMENTAL	SS08 HE01	ALL ALL
<u>WEAPONS DEPARTMENT</u>	G1 AVIATION ARMS	WG01	ALL
	G2 ARMORY/FORCE PROTECTION	WG02	ALL

<u>DEPARTMENT</u>	<u>DIVISION W/C</u>	<u>SHIP CODE</u>	<u>CLASS</u>
	G3 CARGO HANDLING MAG	WG03	ALL
	G4 AMMO ADMIN	WG04	ALL

APPENDIX C₄F

STANDARD WORK CENTER CODES FOR CG/DDG/FFG CLASS SHIPS

<u>DEPARTMENT</u>	<u>DIVISION W/C</u>	<u>SHIP CODE</u>	<u>CLASS</u>	
<u>COMBAT SYSTEMS</u>	CC			
	RADIO	CC01	ALL	
	LAN/ADP	CC02	ALL	
	CF			
	SPY	CF01	CG, DDG	
	ACNT/DISPLAY	CF02	ALL	
	FCS/ORTS	CF03	ALL	
	CE			
	INTERIOR COMMS	CE01	ALL	
	RADAR/NAV	CE03	ALL	
	TEST EQUIPT ELEC CAL	CE04	ALL	
	ELECTRONICS	CSE1	ALL	
	2M REPAIR	CSE3	ALL	
	CA			
	SPS-53/V-10/MAIN SONAR	CA01	ALL	
	TOWED ARRAY	CA02	AS APPLICABLE	
	MINE COUNTERMEASURE	CA04	AS APPLICABLE	
	CG			
	GUNS	CG01	CG, DDG	
	GWS	CG02	CG, DDG	
	ARMORY/TORPEDO/FORCE PROTECTION	CG03	ALL	
	CIWS	CG04	AS APPLICABLE	
	CM			
	TOMAHAWK	CM01	CG, DDG	
	VLS	CM02	CG, DDG	
	SPARROW/HARPOON/MISSILE	CM03	AS APPLICABLE	
	<u>ENGINEERING DEPARTMENT</u>	EA		
		AUXILIARY	EA01	ALL
		DIESEL	EA02	FFG
		RAST	EA04	AS APPLICABLE
		EE		
		ELEC TOOL ISSUE/SAFETY	EE01	ALL
ELECTRICAL SHOP		EE02	ALL	
EM				
MER 1		EM01	ALL	
MER 2		EM02	CG, DDG	
PROPULSION ELECTRICAL		EM04	ALL	
OIL LAB		EB14	ALL	

<u>DEPARTMENT</u>	<u>DIVISION W/C</u>	<u>SHIP CODE</u>	<u>CLASS</u>
	FLEET CAL ACTIVITY	FCA1	ALL
	ER		
	HULL REPAIR	ER01	ALL
	MACHINERY REPAIR	ER03	CG, DDG
	DAMAGE CONTROL	ER04	ALL
	DCPO	ER09	ALL
<u>EXECUTIVE DEPARTMENT</u>			
	EX		
	ADMIN	EX01	ALL
	3MC	EX03	ALL MDS ONLY
	OFF SHIP SERVICES	ES01	ALL MDS ONLY
	MAA	EX04	ALL
<u>HEALTH SERVICES DEPARTMENT</u>			
	HM		
	MEDICAL	HM01	ALL
<u>OPERATIONS DEPARTMENT</u>			
	OD		
	DECK	OD01	ALL
	OT		
	ELECTRONIC WARFARE	OT01	ALL
	CRYPTOLOGIC WARFARE	OT02	REQUIRED FOR PCMS
	OI		
	CIC	OI01	ALL
<u>NAVIGATION DEPARTMENT</u>			
	NN		
	NAVIGATION	NN01	ALL
<u>SUPPLY DEPARTMENT</u>			
	S1		
	GENERAL STORES	SS01	ALL
	HAZMAT/ENVIRONMENT	HE01	ALL
	S2		
	FOOD SERVICE	SS02	ALL
	S3		
	SHIP SERVICES	SS03	ALL
		STK	

APPENDIX C4G

STANDARD WORK CENTER CODES FOR LCS CLASS SHIPS

<u>DEPARTMENT</u>	<u>DIVISION W/C</u>	<u>SHIP CODE</u>	<u>CLASS</u>
<u>COMBAT SYSTEMS DEPARTMENT</u>			
	CG		
	GUNNERY/ARMORY GRP	CG03	ALL
	FORCE PROTECTION	FP01	ALL
	CS		
	ELECT/COMMS/LAN GRP	CSE1	ALL
	ELECT/ELECT ISSUE	CE04	ALL
<u>ENGINEERING DEPARTMENT</u>			
	EA		
	MECHANICAL GROUP	EA01	ALL
	EE		
	ELECTRICAL GROUP	EE02	ALL
	ER		
	REPAIR/DC/DCPO GROUP	ER09	ALL
<u>EXECUTIVE DEPARTMENT</u>			
	EX		
	3MC	XX03	ALL (NO PMS)
	OFF SHIP SERVICES	ES01	ALL (NO PMS)
<u>OPERATIONS DEPARTMENT</u>			
	OI		
	CIC/NAVIGATION GROUP	OI01	ALL
	OD		
	DECK GROUP	OD01	ALL
<u>SUPPLY DEPARTMENT</u>			
	S1		
	SUPPLY GROUP	SS01	ALL
	MEDICAL	MH01	ALL

**LCS MISSION MODULES -
4 DEPARTMENTS**

The work center assignments will be as follows: (This will be based on the number and LCS hull number the module is assigned.)

SHORE DEPARTMENT SH01 to SH99

Note 1: The shore department receives all of the material and tracks the maintenance of the gear while at the MPSF. All initial assignments of equipment and equipage will be work center SH01. The SH01 will be the secondary work center on all configuration records to allow for the ordering of parts while the module is deployed.

ASW DEPARTMENT AS01 to AS99

Note 2: For all ASW based Mission Modules

SUW DEPARTMENT SU01 to SU99

Note 3: For all SUW based Mission Modules

MCM DEPARTMENT MC01 to MC99

Note 4: For all MCM based Mission Modules

Each of the departmental structures will be broken down into work centers, using the first 2 letters of the department. There is one work center for each Mission Module. There can be a maximum of 99 work centers under each department.

To place the gear in a different department or work center, just change the work center assignment for the record. Upline reporting informs CDMD-OA of the change, or communication with the CDM so they can do bulk changes.

Include the PMS team at NSLC when making the changes to keep PMS data updated.

The MPSF will receive and serialize the equipment then assign to the correct mission module.

APPENDIX C₄H

STANDARD WORK CENTER CODES FOR LCC 19 CLASS SHIPS

<u>DEPARTMENT</u>	<u>DIVISION W/C</u>	<u>SHIP CODE</u>	<u>CLASS</u>
<u>INFORMATION SYSTEM</u>			
<u>DEPARTMENT</u>			
	CE		
	SATELLITE COMM	CE01	
	LINE OF SIGHT COMMS	CE02	
	RADAR	CE03	
	2-M	CSE3	
	TEST EQUIPT ELEC CAL	CE04	
	CSI		
	INTERIOR COMM	CSI1	
	CR		
	RADIO	CR01	
	CI		
	LAN AND LAN HARDWARE	CI01	
<u>DECK DEPARTMENT</u>			
	DA		
	ANCHOR/MOORING STA	DA01	
	SPONSON/BOATS	DA02	
	DB		
	MAIN DECK	DB01	
<u>ENGINEERING</u>			
<u>DEPARTMENT</u>			
	EA		
	AUXILIARY	EA01	
	ENGINE/BOAT SHOP	EA02	
	AC&R	EA05	
	EE		
	ELECTRICAL SHOP	EE01	
	ELEC TOOL ISSUE/SAF	EE02	
	EM		
	ENGINE ROOM	EM01	
	FIRE ROOM	EM02	
	EABC LAB	EM03	
	OIL LAB	EM04	
	GAGE CAL	EM05	
	ER		
	HULL REPAIR	ER01	
	MACHINE SHOP	ER03	
	DAMAGE CONTROL REP	ER04	
	DCPO	ER09	
<u>EXECUTIVE</u>			
<u>DEPARTMENT</u>			
	EX		
	ADMIN	EX01	
	3MC	EX03	MDS ONLY
	OFF SHIP SERVICES	ES01	MDS ONLY
	MAA/LNS	EX04	

<u>DEPARTMENT</u>	<u>DIVISION W/C</u>	<u>SHIP CODE</u>	<u>CLASS</u>
	VI MCS	VI01	
<u>CHAPLAIN DEPARTMENT</u>	CH CHAP	CHA1	IF CHAPLAIN ASSIGNED
<u>MEDICAL DEPARTMENT</u>	MH MEDICAL	MH01	
<u>DENTAL DEPARTMENT</u>	MD DENTAL	MD01	IF DENTIST IS ASSIGNED
<u>OPERATION DEPARTMENT</u>	OI CIC	OI01	
	ELECTRONIC WARFARE	OI03	
	ON NAVIGATION	ON01	
	OW GUNNERY MAINTENANCE	OW01	
	SHIPS ARMORY	OW03	
	CIWS	OW04	
<u>SUPPLY DEPARTMENT</u>	S1 STOCK CONTROL/POSTAL	SS01	
	HAZ/ENV	HE01	
	S2 FOOD SERVICE	SS02	
	S3 SHIPS SERVICE	SS03	
	S5 WARD ROOM	SS05	
	FLAG MES	FS05	
	STOK STOCK	STK	

APPENDIX C4I

STANDARD WORK CENTER CODES FOR LPD 17 CLASS SHIPS

<u>DEPARTMENT</u>	<u>DIVISION W/C</u>	<u>SHIP CODE</u>	<u>CLASS</u>
<u>AIR DEPARTMENT</u>			
	V		
	FLIGHT DECK (ABH)	V101	ALL
	AVIATION FUELS	V401	ALL
	GROUND SUPPORT EQUIP	VM04	ALL
<u>CHAPLAIN DEPARTMENT</u>			
	CH		
	CHAP	CH01	ALL
<u>COMBAT CARGO DEPARTMENT</u>			
	CD		
	CCD	CCD1	MDS ONLY
<u>COMBAT SYSTEMS DEPARTMENT</u>			
	CC		
	RADIO	CC01	ALL
	LAN/ADP	CC02	ALL
	CE		
	TEST EQUIPT ELEC CAL	CE04	ALL
	RADAR REPAIR/NAV COMMUNICATION REPAIR	CSE1	ALL
		CSE2	ALL
	2-M REPAIR/STO	CSE3	ALL
	COMPUTER REPAIR	CSE4	ALL
	CM		
	ACDS/SSDS	CM01	ALL
	RADARS	CM02	ALL
	MISSILES (RAM, TAS)	CM04	ALL
	CG		
	GWS	CG02	ALL
	ARMORY/FORCE PROTECTION	CG03	ALL
	CARGO/AVIATION MAGZN	CG04	ALL
	IC SHOP	CSE5	ALL
	INTERIOR COMM	CSE6	AS REQUIRED
	CCTV	CSE7	ALL
<u>DECK DEPARTMENT</u>			
	DA		
	FIRST BOATS	DA01	ALL
		DA02	AS REQUIRED
		DA03	AS REQUIRED
	DB		
	SECOND	DB01	ALL
		DB02	AS REQUIRED

<u>DEPARTMENT</u>	<u>DIVISION W/C</u>	<u>SHIP CODE</u>	<u>CLASS</u>
<u>ENGINEERING DEPARTMENT</u>		DB03	AS REQUIRED
	EA		
	AUXILIARY	EA01	ALL
	ENGINE SHOP	EA02	AS REQUIRED
	HYDRAULICS	EA04	ALL
	AC&R	EA05	ALL
	EE		
	ELEC TOOL ISSUE/SAF	EE01	ALL
	ELECTRICAL SHOP	EE02	ALL
	POWER AND REWIND	EE03	AS REQUIRED
	INTERIOR COMM	EE05	AS REQUIRED
	ENGINEERING CONTROL SYSTEMS	EE07	AS MANNING RECEIVED CREATE WC
	EM		
	MAIN MACHINERY RM 1	EM01	ALL
	MAIN MACHINERY RM 2	EM02	ALL
	AUX MACHINERY RM 1	EM03	ALL
	AUX MACHINERY RM 2	EM04	ALL
	AUX MACHINERY RM 3	EM05	ALL
	OIL LAB	EB14	ALL
	GAGE CAL	FCA1	ALL
	ER		
	HULL REPAIR	ER01	ALL
	MACHINERY REPAIR	ER03	ALL
	DAMAGE CONTROL REP	ER04	ALL
	DCPO	ER09	ALL
<u>EXECUTIVE DEPARTMENT</u>			
	EX		
	ADMIN	EX01	ALL
	3MC	EX03	ALL MDS ONLY
	MAA	EX04	ALL
	TRAINING	ET01	ALL MDS ONLY
	OFF SHIP SERVICES	ES01	All Contains All X- Services XRICS
<u>HEALTH SERVICES DEPARTMENT</u>			
	HM		
	MEDICAL	HM01	ALL
	HD		
	DENTAL	HD01	ALL
<u>OPERATIONS DEPARTMENT</u>			
	OI		
	CIC	OI01	ALL
	ON		

<u>DEPARTMENT</u>	<u>DIVISION W/C</u>	<u>SHIP CODE</u>	<u>CLASS</u>
	NAVIGATION	ON01	ALL
	OT		
	ELECTRONIC WARFARE	OT01	ALL
	CRYPTO WARFR (PCMS)	OT02	ALL
<u>SUPPLY DEPARTMENT</u>			
	S1		
	STOCK CONTROL	SS01	ALL
	HAZ/ENV	HE01	
	AVIATION STORE	SS06	AS REQUIRED
	S2		
	FOOD SERVICE	SS02	ALL
	WARD ROOM	SS05	AS REQUIRED
	S3		
	SHIP SERVICES	SS03	ALL

(This Page Intentionally Left Blank)

APPENDIX C₄J

STANDARD WORK CENTER CODES FOR DDG-1000 CLASS SHIPS

<u>DEPARTMENT</u>	<u>DIVISION W/C</u>	<u>SHIP CODE</u>	<u>CLASS</u>
<u>COMBAT SYSTEMS</u>			
	CF (STO)		
	SPY/FCS/ORTS/DISPLAY	CF01	
	CE (EMO)		
	INTERIOR COMMS	CE01	NEED IC RATED
	RADAR/NAV	CE03	
	COM ELECTRONICS	CSE1	
	RADIO	CC01	
	LAN/ADP	CC02	
	CA (ASWO)		
	MAIN SONAR	CA01	
	CG (WEPS)		
	GUNS	CG01	
	GWS	CG02	
	ARMORY/TORPEDO/FORCE	CG03	
	PR		
	VLS	CM02	
<u>ENGINEERING DEPT</u>			
	EA (AUXO)		
	AUXILIARY	EA01	
	RAST	EA04	
	EM (MPA)		
	MECHANICAL (GSM)	EM01	
	MACHINERY CONTROL	EM04	
	SYS		
	OIL LAB	EB14	
	FLEET CAL ACTIVITY	FCA1	
	ELEC TOOL ISSUE/SAF	EE01	
	ELECTRICAL SHOP	EE02	
	ER (DCA)		
	HULL REPAIR	ER01	
	DAMAGE CONTROL	ER04	
	DCAO	ER09	
<u>EXECUTIVE DEPT</u>			
	EXEC (XO)		
	ADMIN	EX01	
	OFF SHIP SERVICES	ES01	ALL MDS ONLY
	MAA	EX04	
	MEDICAL	HM01	
<u>OPERATIONS DEPT</u>			
	OD (1ST LT)		
	DECK	OD01	
	NAVIGATION	ON01	
	OT (IOW)		
	ELECTRONIC WARFARE	OT01	
	CRYPTO LOGIC WARFARE	OT02	REQUIRED FOR PCMS

<u>DEPARTMENT</u>	<u>DIVISION W/C</u>	<u>SHIP CODE</u>	<u>CLASS</u>
	OI (CICO) CIC	OI01	
<u>SUPPLY DEPT</u>	S-1 (LSC) GENERAL STORES HAZ/ENV	SS01 HE01	
	S-2 (LSC) FOOD SERVICE	SS02	
	S-3 (LSC) SHIP SERVICES	SS03	

APPENDIX C₄K

STANDARD WORK CENTER CODES FOR NBU-7 COMMAND

<u>DEPARTMENT</u>	<u>DIVISION</u>	<u>WORK CENTER</u>	<u>NOTES</u>	
<u>EXECUTIVE (EX)</u>		EX03	3MC	
		EX04	SECURITY FORCE SPECIALIST	
	ADMIN (AX)	ES01	OFF UNIT SERVICES	
		AX01	UNIT OFFICE	
		AX02	OFFICER SUPPORT	
		AX03	CAREER COUNSELOR	
	HEALTH SERVICES (HS)	MH01	MEDICAL	
	INFORMATION SYSTEMS (IS)	IS01	RADIO	
		IS02	ADP	
	<u>QUALITY ASSURANCE/ MAINTENANCE MANAGEMENT (MA)</u>	QUALITY ASSURANCE (QA)	Q93B	QAO/UNIT MAINTENANCE MATERIAL OFFICER (UMMO)
		Q10S	SAFETY	
		Q10C	PLANNING & ESTIMATING	
		Q10E	TECH LIBRARY	
		Q06B	TOOL ROOM	
<u>MAINTENANCE (MD)</u>	POWER PLANT (PP)	P31T	TURBINE SHOP	
		P31F	HYDRAULIC SHOP	
		P38A	PROP & LIFTFAN SHOP	
		P31D	DIESEL SHOP	
	STRUCTURAL (SS)	S26A	WELD SHOP	
		S93A	NDT	
		S64A	AIRFRAMES	
		S31A	MACHINE SHOP	
		S56B	A/C & R SHOP	
		S71B	CORROSION CONTROL SHOP	
		S09D	DAMAGE CONTROL SHOP	
	ELECTRICAL/ ELECTRONICS (EE)	E67B	ELECTRONIC TOOL ISSUE/CAL	
		E51B	GSE SHOP	
		E67A	ELECTRONIC REPAIR SHOP	
		E67M	2M/MTR	
	ROLLING STOCK	RS01	LARC\LARC-V	
		RS02	VEHICLES	
	<u>SUPPLY (SU)</u>	S1	SS01	SUPPLY SUPPORT
		HAZMAT (HZ)	HZ01	HAZMAT ISSUE/RECEIPT
		S2	SS02	FOOD SERVICES
FUELS (FU)		FU01	FUEL SERVICES	

<u>DEPARTMENT</u>	<u>DIVISION</u>	<u>WORK CENTER</u>	<u>NOTES</u>
<u>QUALITY ASSURANCE/ MAINTENANCE MANAGEMENT (MA)</u>	QUALITY ASSURANCE (QA)	Q93B	QAO/UNIT MAINTENANCE MATERIAL OFFICER (UMMO)
		Q10S	SAFETY
		Q10C	PLANNING & ESTIMATING
<u>OPERATIONS</u>	WEAPONS (WE)	WG01	ARMORY
	CRAFT CONTROL (CC)	CC01	CRAFT CONTROL (OS RATING)
		LCU (CU)	CU33
		CU34	LCU 1634
		CU51	LCU 1651
		CU46	LCU 1646
		CU66	LCU 1666
	LCAC (LC)	LC08	LCAC 08
		LC09	LCAC 09
		LC10	LCAC 10
		LC21	LCAC 21
		LC 29	LCAC 29
		LC30	LCAC 30
	LC47	LCAC 47	
<u>STOCK REPLENISHMENT (SR)</u>	REGULAR STOCK		
	DLR STOCK REPLENISHMENT		

APPENDIX D

**LISTING OF STANDARD WORK CENTER CODES FOR
MASTER JOB CATALOG ITEMS CONTAINED IN SHIP'S CSMP
(Surface and Submarine Forces Only)**

Submarine Forces:

Description	Code
Overhaul, SRA, Baseline routines	EXSY
NAVSEA Issued Alterations	*XSA
NSWCCD Machinery Alteration	*XMA
TYCOM Issued Alterations	*XTY
DIRSSP Issued Strategic Systems Program Alterations (SSBN/SSGN)	**SP
Submarine Extended Operating Cycle PMRs	**JC
Test and Measurement System Repair Routines	**CR
MJC Service Routines	**MC

* = Department

** = Department/Division

Surface Forces:

Description	Code
Overhaul, SRA, Baseline routines	EXSY
NAVSEA/TYCOM Issued Alterations	EXSA
Engineering Cycle	**EC

First character identifies the requesting Department.

Second character identifies the Administrative Procedure ("X").

Third character indicates catalog routine ("C").

Last character denotes the maintenance source code as follows:

- A - Planned Maintenance Subsystem
- B - Unassigned
- C - Corrective
- D - Upkeep
- E - Miscellaneous

(This Page Intentionally Left Blank)

APPENDIX E
JOB ORIGINATOR VALUES

JOB ORIGINATOR			OBS	BRKR	JOB ORIGINATOR TEXT	SHORT TEXT
SEQ	SORT	CODE	FG	FG		
25	1	A	0	0	ACCCIT (AIR)/DC (SURF) TSRA HM&E (SUBS)	LOCAL TYCOM
26	7	B	0	0	C5RA (AIR) CSAT/MAPAI (SUBS); CBR INSPECTION (SURF)	LOCAL TYCOM
27	2	C	0	0	LCS/DDG 1000 (SURF) TSRA COMBAT SYSTEMS (SUBS)	LOCAL TYCOM
28	8	D	0	0	CABLEWAY (AIR) I-LVL DEPARTURE (SUBS)	LOCAL TYCOM
42	42	E	0	0	ELEVATOR SUPPORT UNIT (AIR)	LOCAL TYCOM
29	9	G	0	0	ERAT, IRAT, TMIT (SURF)	LOCAL TYCOM
30	10	H	0	0	EQOL/FSL (AIR); 2K-FTA (SURF)	LOCAL TYCOM
43	43	I	0	0	NSLC RESERVED	NSLC
37	17	J	0	0	POET'S (AIR); ICAS (SURF)	LOCAL TYCOM
31	11	K	0	0	TSRA/CSC C5RA (SURF)	LOCAL TYCOM
40	40	L	0	0	PORT ENGINEER WRITTEN JSNs	NATIONAL
39	39	M	0	0	MicroPMR (MPMR)/MSWP (SUB)	LOCAL TYCOM
41	41	N	0	0	CORROSION CONTROL (SURF)	LOCAL TYCOM
32	12	P	0	0	PEPSI (AIR)/SECAP (SURF); PMT OSAR (SUBS)	LOCAL TYCOM
15	15	Q	0	1	CREATED BY RMAIS (NATIONAL)	RMAIS-N
16	16	R	0	0	INSURV (NATIONAL)	INSURV-N
33	13	S	0	0	CEMAT (AIR) SHIP SEMAT (SURF); SAIL DEFICIENCIES (SUBS)	LOCAL TYCOM
45	45	T	0	0	TYCOM (AIR, SURF, SUBS)	LOCAL TYCOM
38	18	U	0	0	TOOLSET FOR INSPECTIONS (BOILERS, DIESELS, ETC.)	OPNAVINST 9220.3
44	6	V	0	0	ALRE ICAV (AIR)	LOCAL TYCOM
					UNSCHEDULED INSPECTION/ASSESSMENT TASKS (SURF)	
34	14	W	0	0	BAWP (AIR)/ICMP; IMF TSRA; ICAS; RMC TSRA (SURF)	LOCAL TYCOM
35	15	X	0	0	BAWP (AIR)	LOCAL TYCOM
36	16	Y	0	0	AIR/MST (SURF); BAWP (AIR)	LOCAL TYCOM
					MST/CLASS MAINTENANCE PLANS (SURF) CLASS MAINTENANCE PLANS	
23	5	Z	0	0	(NATIONAL) MST/M&SWP	LOCAL TYCOM
999,999	999,999	?	0	0	Invalid	Invalid

VI-19E-1

COMUSFLTFORCOMINST 4790.3 REV C CH-5

(This Page Intentionally Left Blank)

APPENDIX F
SAMPLE SITUATIONAL REQUIREMENT REFERENCE SHEET

PERIODICITY	SITUATION	MR DESCRIPTION
D-1R W-3R M-1R	(Prior to getting underway)	(Lubricate)
Q-6R A-5R	(Accomplish at sea prior to submergence)	(Test Operate)
R-1W		

(This Page Intentionally Left Blank)

VOLUME VI
CHAPTER 20
WEIGHT AND MOMENT CONTROL FOR SUBMARINES

REFERENCES.

- (a) NAVSEA S9086-C6-STM-010 - NSTM Chapter 096 (Weights and Stability)
- (b) NAVSEAINST C9096.2 - Weight and Stability Requirements for Active Submarines
- (c) NAVSEA S9SSN-W4-SSM-PA0/C688CLV7 - SSN688 Class Ship Systems Manual, Vol 7, Chapter 2, Section 2.3

LISTING OF APPENDICES.

- A Sample Ship Message to ISIC Concerning Removal or Reinstallation of DDS Lead
- B Sample Ship Message to ISIC Concerning Audit of DDS Lead Loading
- C Sample Ship Message to ISIC Concerning Audit of Cargo Lead Documentation

20.1 **PURPOSE.** This chapter provides basic information and guidance concerning submarine ballast changes, including mandatory authorization and reporting requirements.

20.1.1 **Discussion.**

- a. The use of solid ballast is important for submarine stability and the ability to maintain submerged equilibrium for all design conditions. Ballast lead typically, is installed in submarines for the following purposes:
 - (1) To maintain adequate stability.
 - (2) To correct for inherent transverse moments that would otherwise create list.
 - (3) To permit submarines to submerge with neutral buoyancy and zero trim for all design equilibrium conditions.
 - (4) To compensate for future installed alterations.
- b. An inclining experiment and all-stop trim dive are performed in accordance with the requirements of reference (a). These experiments provides the basic data concerning weight and center of gravity for use in all considerations of stability, reserve buoyancy, equilibrium and in determining compliance with the requirements of the weight control program. An inclining experiment is the only satisfactory method of accurately determining the location of the vertical center of gravity of the submarine. The trim dive is the only satisfactory method of determining the load to submerge and the final ballasting solution. Inclining experiments are conducted on each submarine in new construction, after the Post Shakedown Availability and when authorized by Naval Sea Systems Command (NAVSEA) for some overhaul availabilities. Trim dives are performed during delivery sea trials, prior to and after Post Shakedown Availability, prior to and after major availabilities and under specific circumstances to address ballasting issues reported by Ship's Force. Trim dives are also performed periodically prior to smaller availabilities to identify weight growth.
- c. Initial ship design provides for adequate stability and equilibrium for all expected loading conditions. Service life margin, in the form of permanent lead ballast in excess of that needed to maintain stability and equilibrium, allows for growth, but historically the margin is quickly consumed for several reasons:
 - (1) The on-going process of modernization over the life of the ship.
 - (2) Unknown weight growth due to the accumulation of personal gear and equipment, undocumented alterations, spare parts and stores.
 - (3) Weight removal or margin recovery measures being accorded a low priority.

20.2 BALLAST CHANGES. NAVSEA maintains a record of the solid ballast installed in each submarine. These records are required for evaluating and tracking the ship's stability and equilibrium. Any permanent alteration to a submarine that changes weight, moment or displacement may require compensation by the removal or installation of lead ballast.

20.2.1 Naval Sea Systems Command Notification. Any activity performing this alteration is required by reference (b) to submit a reballasting proposal to NAVSEA for approval. NAVSEA approval is required for all permanent ballast changes. Copies of the reballasting proposal shall be sent to the Type Commander (TYCOM), Immediate Superior In Command (ISIC) and the Commanding Officer.

20.2.2 Ballast Types. Submarines of the active fleet shall be maintained within stability and buoyancy limits for a state of war readiness. Deviations from this principle are generally unauthorized. Some ships are authorized to carry other types of lead ballast as follows:

- a. Dry-Deck Shelter (DDS) Capable SSN: Some of these SSN ships have special lead called DDS lead that can be removed when the shelter is installed and re-loaded after the shelter is removed.
 - (1) After each Depot Maintenance Period, a Weight and Stability Data Report is developed by the Shipyard performing the availability. This document provides the amount, location and moment calculations for the removable DDS lead. The document provides the amount of DDS lead to be removed for DDS on-load and operations based on a specific set of loading parameters. The latest copy of this data package is to be maintained by Ship's Force.
 - (2) The amount of DDS lead either removed or reinstalled will be reported using the message format shown in Appendix A following an on-load or off-load of the DDS shelter prior to at sea operations.
 - (3) Each ship is responsible to determine the amount of DDS lead to remove (if any) based on their expected mission loading to maintain conditions within the equilibrium polygon. It is the responsibility of the ISIC to ensure Ship's Force is trained on the handling of DDS lead. Details on the DDS lead, including handling procedures, can be found in reference (c).
 - (4) In the event the DDS is on-loaded in a port other than the homeport, the ISIC is responsible for ensuring the DDS lead is transported to the port where the DDS will be removed so that the lead is available for Ship's Force loading concurrent with the DDS off-load.
 - (5) When the DDS capable ship is operating without the DDS, all DDS lead is considered part of the ship's permanent lead ballast and shall be installed in the designated locations as specified in the Weight and Stability Data Report.
 - (6) Actual DDS lead loading shall be audited by Ship's Force prior to each Dry-Docking Selected Restricted Availability (DSRA), Depot Modernization Period (DMP), Engineered Overhaul, or Pre-Inactivation Restricted Availability (PIRA) to ensure the DDS lead is properly installed. The ISIC is responsible for ensuring that Ship's Force is using the latest shipyard Weight and Stability Data Report for validating the DDS lead loading. A report of the audit findings will be made using the message format shown in Appendix B. If a particular tank is scheduled for re-preservation and the work is listed in the Availability Work Package, the audit of the DDS lead in that specific tank may be delayed until the lead is reinstalled following preservation. Any audit conducted during the availability must be completed and reported prior to Dock Trials.
- b. Cargo Lead: Ships have cargo lead loaded at various times to compensate for loads or loading configurations. This cargo lead can become undocumented weight over time due to crew turnover and loss of corporate knowledge. To that end the following is required for loading and off-loading of cargo lead:
 - (1) Cargo ballast, unless part of the original design, is approved by NAVSEA on a ship by ship basis. Requests for cargo ballast, and requests for increased amount of cargo ballast, must be submitted by the ship, in writing, to NAVSEA for approval. All such requests shall have TYCOM endorsement.

- (2) Changes to cargo lead which includes adding, removing or relocating shall normally be accomplished only by a nuclear qualified shipyard. Approval by the ISIC and TYCOM is required in the event a situation requires an organization other than a nuclear qualified shipyard to add, remove or relocate cargo lead.
 - (a) All requests for cargo lead changes will include the specific weight amount, location, and method for securing the lead.
 - (b) Cargo lead documentation shall be audited by Ship's Force during each Maintenance and Modernization Program, DSRA, DMP, Engineered Overhaul, or PIRA to ensure the cargo lead is being properly tracked. The ISIC is responsible for ensuring that Ship's Force is using the latest shipyard documentation for the cargo lead. A report of the audit findings will be made using the format of Appendix C.
- (3) Any cargo lead load that results in a calculated mission equilibrium point outside the equilibrium polygon requires a NAVSEA approved Departure From Specifications (DFS). Additional guidance and procedures concerning the installation or removal of cargo ballast is available in reference (b).
- c. Permanent Ballast: Changes in permanent ballast, which includes adding, removing or relocating, shall not be accomplished by Ship's Force, Fleet Maintenance Activities or any industrial activity without prior TYCOM concurrence and NAVSEA written approval.
- d. Sea Trial Lead. Temporary ballast may be added as necessary to assure that the ship is capable of diving and trimming out when lightly loaded during sea trials following a Chief of Naval Operations availability (DMP, DSRA, PIRA, etc.). NAVSEA shall review and approve temporary ballast used for trials. The TYCOM shall approve the use of any temporary lead retained or added after sea trials for transit to homeport. All temporary lead ballast must be removed prior to load-out and deployment. A temporary DFS shall be opened upon installation of temporary sea trial ballast and closed upon removal of that ballast. The forwarding letter for the post-availability stability report shall reference the DFS and provide the current status of the temporary lead ballast.

20.3 UNUSUAL CONDITIONS. NAVSEA requires reports to be submitted of any unusual conditions which are considered dangerous or seriously affect the operation of the ship. Ship's Force will report the following situations to NAVSEA, via the ISIC and TYCOM, in accordance with the requirements of reference (a).

- a. Excessive rolling.
- b. Heeling due to rudder action.
- c. Excessive pounding.
- d. Inadequate propeller immersion.

(This Page Intentionally Left Blank)

APPENDIX A

SAMPLE SHIP MESSAGE TO ISIC CONCERNING REMOVAL OR REINSTALLATION OF DDS LEAD

FM USS <SHIP NAME>//
TO COMSUB<RON/GRU NO.>//
COMSUBRON <NO. HOME SQUADRON IF DEPLOYED>
INFO COMSUB<LANT/PAC> <NORFOLK VA/PEARL HARBOR HI>//
BT
UNCLAS //N9096//
MSGID/GENADMIN//USS <SHIP'S NAME>//
SUBJ/(SUBS) USS <SHIP NAME/HULL NO.>REMOVAL <REINSTALLATION> OF DDS LEAD//
REF/A/DOC/COMUSFLTFORCOM/<DATE>//
REF/ REF A IS COMUSFLTFORCOMINST 4790.3, JOINT FLEET MAINTENANCE MANUAL,
VOLUME VI, CHAPTER 20.//
RMKS/1. DDS SHELTER <NUMBER> IS BEING ON-LOADED <OFF-LOADED>
2. PER REF A THE SPECIFIC DDS LEAD THAT HAS BEEN REMOVED <REINSTALLED> IS PROVIDED:

<NUMBER> DDS PIGS - <NUMBER> APPROXIMATE WEIGHT - LOCATION <TANK AND LEAD BIN LOCATION>
<NUMBER> DDS PIGS - <NUMBER> APPROXIMATE WEIGHT - LOCATION <TANK AND LEAD BIN LOCATION>
<NUMBER> DDS PIGS - <NUMBER> APPROXIMATE WEIGHT - LOCATION <TANK AND LEAD BIN LOCATION>
<NUMBER> DDS PIGS - <NUMBER> APPROXIMATE WEIGHT - LOCATION <TANK AND LEAD BIN LOCATION>
<NUMBER> DDS PIGS - <NUMBER> APPROXIMATE WEIGHT - LOCATION <TANK AND LEAD BIN LOCATION>

BT

NOTE: ENSURE MESSAGES ARE IN ACCORDANCE WITH CURRENT MESSAGE FORMAT AND CURRENT PLAIN LANGUAGE ADDRESS DIRECTORY (PLAD) IS UTILIZED.

(This Page Intentionally Left Blank)

APPENDIX B

SAMPLE SHIP MESSAGE TO ISIC CONCERNING AUDIT OF DDS LEAD LOADING

FM USS <SHIP NAME>//
TO COMSUB<RON/GRU NO.>//
COMSUBRON <NO. HOME SQUADRON IF DEPLOYED>
INFO COMSUB<LANT/PAC> <NORFOLK VA/PEARL HARBOR HI>//
BT
UNCLAS //N9096//
MSGID/GENADMIN//USS <SHIP'S NAME>//
SUBJ/(SUBS) USS <SHIP NAME/HULL NO.>AUDIT OF DDS LEAD LOADING//
REF/A/DOC/COMUSFLTFORCOM/<DATE>//
REF/B/DOC/<SHIPYARD>/<DATE>
REF/ REF A IS COMUSFLTFORCOMINST 4790.3, JOINT FLEET MAINTENANCE MANUAL,
VOLUME VI, CHAPTER 20. REF B IS THE WEIGHT AND STABILITY DATA REPORT FROM <SHIPYARD>
DATED <DATE>.
RMKS/1. PER REF A THE CURRENT DDS LEAD LOADING AS REQUIRED BY REF B IS AS FOLLOWS:

<NUMBER> DDS PIGS - <NUMBER> APPROXIMATE WEIGHT - LOCATION <TANK AND LEAD BIN LOCATION>
<NUMBER> DDS PIGS - <NUMBER> APPROXIMATE WEIGHT - LOCATION <TANK AND LEAD BIN LOCATION>
<NUMBER> DDS PIGS - <NUMBER> APPROXIMATE WEIGHT - LOCATION <TANK AND LEAD BIN LOCATION>
<NUMBER> DDS PIGS - <NUMBER> APPROXIMATE WEIGHT - LOCATION <TANK AND LEAD BIN LOCATION>
<NUMBER> DDS PIGS - <NUMBER> APPROXIMATE WEIGHT - LOCATION <TANK AND LEAD BIN LOCATION>

BT

NOTE: ENSURE MESSAGES ARE IN ACCORDANCE WITH CURRENT MESSAGE FORMAT AND CURRENT PLAD IS UTILIZED.

(This Page Intentionally Left Blank)

APPENDIX C

SAMPLE SHIP MESSAGE TO ISIC CONCERNING AUDIT OF CARGO LEAD DOCUMENTATION

FM USS <SHIP NAME>//
TO COMSUB<RON/GRU NO.>//
INFO COMSUB<LANT/PAC> <NORFOLK VA/PEARL HARBOR HI>//
<SUPERVISING ACTIVITY/CODE NO>
COMNAVSEASYCOM WASHINGTON DC //
BT
UNCLAS //N9096//
MSGID/GENADMIN//USS <SHIP'S NAME>//
SUBJ/(SUBS) USS <SHIP NAME/HULL NO.> AUDIT OF INSTALLED CARGO LEAD
REF/A/DOC/COMUSFLTFORCOM/<DATE>//
REF/B/DOC/<ACTIVITY>/<DATE>//
REF/ REF A IS COMUSFLTFORCOMINST 4790.3, JOINT FLEET MAINTENANCE MANUAL,
VOLUME VI, CHAPTER 20. REF B IS THE DATA PACKAGE BY THE <NAME> NAVAL SHIPYARD FOR
THE INSTALLATION OF CARGO LEAD.//
RMKS/1. THE SHIP IS UNDERGOING <AVAILABILITY TYPE>. PER REF A AN AUDIT OF CARGO LEAD
DOCUMENTATION HAS BEEN CONDUCTED. SHIP'S FORCE HAS REF B THAT DOCUMENTS THE
CURRENT AMOUNT AND LOCATION OF CARGO LEAD.

BT

**NOTE: ENSURE MESSAGES ARE IN ACCORDANCE WITH CURRENT MESSAGE FORMAT AND
CURRENT PLAD IS UTILIZED.**

(This Page Intentionally Left Blank)

VOLUME VI
CHAPTER 21
SUBMARINE STORAGE BATTERIES

REFERENCES.

- (a) NAVSEA S9223-AF-MMO-010 - Submarine Main Storage Battery Technical Manual
- (b) NAVSEA S9086-G1-STM-010 - NSTM Chapter 223, VI (Submarine Storage Batteries - Lead Acid Batteries)

LISTING OF APPENDICES.

- A Temperature Versus TVG Table
- B Temperature Versus MCV Table
- C TCV Calculation Table
- D Capacity Test Discharge Data Sheet
- E Main Storage Battery Inspection Check-Off
- F Instructions for Completing Submarine Battery Quarterly Reports - NAVSEA 9320/3
- G Instructions for Maintaining the Submarine Battery Record Book - NAVSEA 9320/1 (3-92)

21.1 **PURPOSE.** To emphasize the necessity for proper operation and maintenance of flooded submarine main storage batteries and to provide instructions for:

- a. Operation of submarine main storage batteries.
- b. Completing Submarine Quarterly Battery Reports (QBR).
- c. Maintaining the Submarine Battery Record Book – Naval Sea Systems Command (NAVSEA) 9320/1 (3-92).

21.1.1 **Background.** Records of prior submarine batteries indicate that with proper operation and maintenance, the batteries will provide relatively trouble free service throughout their expected life. The primary factors in obtaining reliable performance are:

- a. Strict compliance with maintenance and charging instructions.
- b. Accomplishment of periodic meter checks ensuring the accurate indication of parameters monitored.
- c. Proper operation and maintenance of electrolyte agitation systems.
- d. Proper operation of battery ventilation systems.
- e. Strict adherence to the trickle discharge routine.

21.1.2 **Discussion.** This chapter does not apply to Valve Regulated Lead-Acid batteries. Although there are a wide variety of problems that can develop in batteries, previous experience has shown that there are specific causes of problems that can be eliminated.

- a. Improper electrolyte agitation is the most frequent cause of problems with flooded submarine batteries. Airlift pump failure can cause stratification, sulfation, internal shorts, low gravities and low Individual Cell Voltages (ICV). The end result is failed cells and decreased capacity. Improper maintenance of the agitation system can cause problems to exist for up to six months before becoming evident as capacity reductions below 90% during a test discharge.
- b. Improper maintenance of the battery will shorten its service life and result in an unscheduled battery replacement or inability of the ship to perform its mission until the battery is replaced. For example, inaccurate voltmeters and ammeters can cause the battery to be overcharged or undercharged. Allowing this condition to go uncorrected can result in permanent damage to the cell plates with a subsequent decrease in service life.

- c. Operating the main storage battery and support systems in accordance with established procedures is essential. The consequences of improper operation can range from a reduction in battery life with subsequent rescheduling of ship operations to a major ship's casualty.

21.2 ACTION.

- a. All submarines with flooded lead acid cells installed shall comply with the procedures in this chapter for the operation, maintenance and inspection of main storage batteries.
- b. Since the main storage battery can be operated safely and efficiently by using references (a) and (b) directly, individual ship main storage battery operating procedures, which may require changes because of changes to source documents, are not required except as specified in this chapter. Where conflicts exist, reference (a) takes precedence over reference (b).
- c. Naval Surface Warfare Center Crane, through the battery manufacturer and with Type Commander (TYCOM) approval, will conduct on-site battery inspections between 9 and 15 months since the last submarine inspection and in situations warranting closer scrutiny. An inspection report will be prepared by the manufacturer and forwarded to the parent Immediate Superior In Command (ISIC) by Naval Surface Warfare Center Crane, copy to the ship. The ISIC will endorse the report and forward to the ship for retention and completion of any recommended corrective actions. Ships will report to TYCOM N4 via ISIC the root causes for and the satisfactory completion of all corrective actions for deficiencies noted in the inspection report within 30 days of receipt of the report.
- d. ISIC shall ensure that attached units operate and maintain installed main storage batteries in accordance with established procedures. When deemed appropriate, promulgate lessons learned concerning battery operation and maintenance among units and provide feedback to the TYCOM.
- e. Submarine Commanding Officers shall implement the provisions of this instruction as follows:
 - (1) Maintain a hard copy of references (a) and (b) in the Maneuvering Area (or normal controlling station for battery charges).
 - (2) SSN 688, SSN 21, SSBN/SSGN 726, SSN 774 and later Class submarines shall operate the main storage battery and support system in accordance with the Ship's Systems Manual. These submarines may insert copies of Appendices A through C of this chapter in the Battery Technical Manual if desired.
 - (3) Require Battery Charging Electrician (BCE) and Battery Charging Electrician Forward (BCEF) qualifications to include familiarity with this chapter.
 - (4) Incorporate familiarity with reference (a), reference (b) and this chapter as part of the formal qualification procedures for Officer of the Deck/Duty Officer, Chief of the Watch/Inport Duty Chief, Engineering Officer of the Watch/Engineering Duty Officer and Engineering Watch Supervisor/Engineering Duty Petty Officer.
 - (5) Perform battery planned maintenance as specified by Planned Maintenance System (PMS) and reference (a). Where conflicts exist, PMS takes precedence over reference (a).
 - (6) Conduct battery charges at the frequency and in the manner specified in reference (a).
 - (7) Operate and maintain battery ventilation including minimum airflow requirements, as specified in reference (b).
 - (8) Maintain battery test discharge data using Appendix D of this chapter. A copy of Appendix D shall be included with the Submarine QBR when a test discharge is conducted during a reporting quarter.
 - (9) Maintain battery records in accordance with reference (a) and reference (b). The Battery Record Book (BRB) for SSBN/SSGNs is to be updated and certified by the Engineer Officer during each crew turnover.
 - (10) Submit a Submarine QBR as specified in reference (b).

- (11) Pursue a battery well maintenance and cleaning program. With proper care and maintenance, a battery resistance to ground with the battery isolated (i.e., battery circuit breakers open) can easily be maintained greater than 500,000 ohms. DC bus grounds must be above 100,000 ohms to conduct a battery charge except in an emergency (see reference (b)).
- (12) Ensure that electric plant logs show a minimum specification of 50,000 ohms for AC and DC bus grounds and battery charging logs show a minimum specification of 100,000 ohms for DC bus grounds.
- (13) Upon battery replacement, prior to Fast Cruise at completion of a Depot Modernization Period, Engineered Refueling Overhaul or Engineered Overhaul and annually, use Appendix E of this chapter to evaluate the material condition of the battery and determine accuracy and completeness of battery records. Material deficiencies will be recorded in the Equipment Status Log for correction and the Job Sequence Number recorded in the margin of the inspection checklist next to the appropriate article. Record the completion date of the most recent Appendix E inspection and correction of deficiencies in the remarks section of the QBR. Only the most recent complete copy of Appendix E of this chapter need be retained with battery records.
- (14) Request technical assistance from higher authority via ISIC or TYCOM for correction of abnormal conditions not within Ship's Force capability.

21.3 CASUALTY REPORTING.

21.3.1 Purpose. To provide guidance for Casualty Reporting (CASREP) requirements for the submarine main storage battery. CASREPs are in addition to, and do not replace the reporting requirements of other documents (e.g., Naval Reactors Technical Bulletins, Operational Orders, Mishap Reports, etc.).

21.3.2 Background. The significance of a submarine's emergency and backup power supplies cannot be overstated. CASREP requirements of Out of Commission power generating or storage equipment require additional clarification.

21.3.3 SSN/SSGN Class Submarine Main Storage Battery. Battery CASREPs shall be submitted as follows:

- a. C-2 when battery capacity falls below 80 percent of rated capacity for SSN 688, SSN 21 and SSGN 726 Class. For SSN 774 Class, C-2 when battery capacity falls below 92%.
- b. C-3 when battery capacity falls below 65 percent of rated capacity for SSN 688, SSN 21 and SSGN 726 Class. For SSN 774 Class, C-3 when battery capacity falls below 87%.
- c. C-4 when battery capacity falls below 50 percent of rated capacity for SSN 688, SSN 21 and SSGN 726 Class. For SSN 774 Class, C-4 when battery capacity falls below 70%.

21.3.4 SSBN Class Submarine Main Storage Battery. Report low battery capacity casualties by message as allowed by operational constraints.

(This Page Intentionally Left Blank)

APPENDIX A
TEMPERATURE VERSUS TVG TABLE

- N = Number of cells in battery circuit (not jumpered out).
 T_c = Average pilot cell temperature (°F) or average cell temperature (for batteries with an operating Automatic Battery Monitoring System) at the beginning of the charge operation.
 TVG = $(2.62 - (0.003 \times T_c))N$

T_c (°F)	N								
	126	125	124	123	122	121	120	119	118
50	311	309	306	304	301	299	296	294	291
51	311	308	306	303	301	299	296	294	291
52	310	308	306	303	301	298	296	293	291
53	310	308	305	303	300	298	295	293	290
54	310	307	305	302	300	297	295	293	290
55	309	307	304	302	300	297	295	292	290
56	309	307	304	302	299	297	294	292	289
57	309	306	304	301	299	296	294	291	289
58	308	306	303	301	298	296	294	291	289
59	308	305	303	300	298	296	293	291	288
60	307	305	303	300	298	295	293	290	288
61	307	305	302	300	297	295	292	290	288
62	307	304	302	299	297	295	292	290	287
63	306	304	301	299	297	294	292	289	287
64	306	304	301	299	296	294	291	289	287
65	306	303	301	298	296	293	291	289	286
66	305	303	300	298	295	293	291	288	286
67	305	302	300	298	295	293	290	288	285
68	304	302	300	297	295	292	290	288	285
69	304	302	299	297	294	292	290	287	285
70	304	301	299	296	294	292	289	287	284
71	303	301	298	296	294	291	289	286	284

T _c (°F)	N								
	126	125	124	123	122	121	120	119	118
72	303	301	298	296	293	291	288	286	284
73	303	300	298	295	293	291	288	286	283
74	302	300	297	295	293	290	288	285	283
75	302	299	297	295	292	290	287	285	283
76	301	299	297	294	292	289	287	285	282
77	301	299	296	294	291	289	287	284	282
78	301	298	296	293	291	289	286	284	282
79	300	298	295	293	291	288	286	284	281
80	300	298	295	293	290	288	286	283	281
81	300	297	295	292	290	288	285	283	280
82	299	297	294	292	290	287	285	283	280
83	299	296	294	292	289	287	285	282	280
84	298	296	294	291	289	287	284	282	279
85	298	296	293	291	289	286	284	281	279
86	298	295	293	291	288	286	283	281	279
87	297	295	293	290	288	285	283	281	278
88	297	295	292	290	287	285	283	280	278
89	296	294	292	289	287	285	282	280	278
90	296	294	291	289	287	284	282	280	277
91	296	293	291	289	286	284	282	279	277
92	295	293	291	288	286	284	281	279	277
93	295	293	290	288	286	283	281	279	276
94	295	292	290	288	285	283	281	278	276
95	294	292	290	287	285	283	280	278	276
96	294	292	289	287	285	282	280	278	275
97	293	291	289	286	284	282	279	277	275
98	293	291	288	286	284	281	279	277	274
99	293	290	288	286	283	281	279	276	274
100	292	290	288	285	283	281	278	276	274

APPENDIX B
TEMPERATURE VERSUS MCV TABLE

- N = Number of cells in battery circuit (not jumpered out).
 T_c = Average pilot cell temperature (°F) or average cell temperature (for batteries with an operating Automatic Battery Monitoring System) at the beginning of the charge operation.
 MCV = $(2.86 - (0.003 \times T_c))N$

T_c (°F)	N								
	126	125	124	123	122	121	120	119	118
50	341	339	336	333	331	328	325	322	320
51	341	338	336	333	330	328	325	322	319
52	341	338	335	333	330	327	324	322	319
53	340	338	335	332	330	327	324	321	319
54	340	337	335	332	329	326	324	321	318
55	340	337	334	331	329	326	323	321	318
56	339	337	334	331	328	326	323	320	318
57	339	336	333	331	328	325	323	320	317
58	338	336	333	330	328	325	322	320	317
59	338	335	333	330	327	325	322	319	317
60	338	335	332	330	327	324	322	319	316
61	337	335	332	329	327	324	321	319	316
62	337	334	332	329	326	324	321	318	316
63	337	334	331	329	326	323	321	318	315
64	336	334	331	328	325	323	320	317	315
65	336	333	330	328	325	322	320	317	314
66	335	333	330	327	325	322	319	317	314
67	335	332	330	327	324	322	319	316	314
68	335	332	329	327	324	321	319	316	313
69	334	332	329	326	324	321	318	316	313
70	334	331	329	326	323	321	318	315	313
71	334	331	328	326	323	320	318	315	312

T _c (°F)	N								
	126	125	124	123	122	121	120	119	118
72	333	331	328	325	323	320	317	315	312
73	333	330	327	325	322	320	317	314	312
74	332	330	327	324	322	319	317	314	311
75	332	329	327	324	321	319	316	314	311
76	332	329	326	324	321	318	316	313	311
77	331	329	326	323	321	318	315	313	310
78	331	328	326	323	320	318	315	312	310
79	330	328	325	323	320	317	315	312	310
80	330	328	325	322	320	317	314	312	309
81	330	327	325	322	319	317	314	311	309
82	329	327	324	322	319	316	314	311	308
83	329	326	324	321	319	316	313	311	308
84	329	326	323	321	318	316	313	310	308
85	328	326	323	320	318	315	313	310	307
86	328	325	323	320	317	315	312	310	307
87	327	325	322	320	317	314	312	309	307
88	327	325	322	319	317	314	312	309	306
89	327	324	322	319	316	314	311	309	306
90	326	324	321	319	316	313	311	308	306
91	326	323	321	318	316	313	310	308	305
92	326	323	320	318	315	313	310	307	305
93	325	323	320	317	315	312	310	307	305
94	325	322	320	317	315	312	309	307	304
95	324	322	319	317	314	312	309	306	304
96	324	322	319	316	314	311	309	306	303
97	324	321	319	316	313	311	308	306	303
98	323	321	318	316	313	310	308	305	303
99	323	320	318	315	313	310	308	305	302
100	323	320	317	315	312	310	307	305	302

APPENDIX C
TCV CALCULATION TABLE

- N = Number of cells in battery circuit (not jumpered out).
 T_c = Average pilot cell temperature (°F) or average cell temperature (for batteries with an operating Automatic Battery Monitoring System) at the end of the charge.
V = Switchboard voltage just prior to end of charge.
TCV = $(0.003(N)) \times (T_c - 80) + (V)$ (Add or subtract as indicated to switchboard voltage)

T_c (°F)	N								
	126	125	124	123	122	121	120	119	118
60	-7.6	-7.5	-7.4	-7.4	-7.3	-7.3	-7.2	-7.2	-7.1
61	-7.2	-7.1	-7.1	-7.0	-7.0	-6.9	-6.8	-6.8	-6.7
62	-6.8	-6.8	-6.7	-6.6	-6.6	-6.5	-6.5	-6.4	-6.4
63	-6.4	-6.4	-6.3	-6.3	-6.2	-6.2	-6.1	-6.1	-6.0
64	-6.0	-6.0	-6.0	-5.9	-5.9	-5.8	-5.8	-5.7	-5.7
65	-5.7	-5.6	-5.5	-5.5	-5.5	-5.4	-5.4	-5.4	-5.3
66	-5.3	-5.3	-5.2	-5.2	-5.1	-5.1	-5.0	-5.0	-5.0
67	-4.9	-4.9	-4.8	-4.8	-4.8	-4.7	-4.7	-4.6	-4.6
68	-4.5	-4.5	-4.5	-4.4	-4.4	-4.4	-4.3	-4.3	-4.2
69	-4.2	-4.1	-4.1	-4.1	-4.0	-4.0	-4.0	-3.9	-3.9
70	-3.8	-3.8	-3.7	-3.7	-3.7	-3.6	-3.6	-3.6	-3.5
71	-3.4	-3.4	-3.3	-3.3	-3.3	-3.3	-3.2	-3.2	-3.2
72	-3.0	-3.0	-3.0	-3.0	-2.9	-2.9	-2.9	-2.9	-2.8
73	-2.6	-2.6	-2.6	-2.6	-2.6	-2.5	-2.5	-2.5	-2.5
74	-2.3	-2.3	-2.2	-2.2	-2.2	-2.2	-2.2	-2.1	-2.1
75	-1.9	-1.9	-1.9	-1.8	-1.8	-1.8	-1.8	-1.8	-1.8
76	-1.5	-1.5	-1.5	-1.5	-1.5	-1.5	-1.4	-1.4	-1.4
77	-1.1	-1.1	-1.1	-1.1	-1.1	-1.1	-1.1	-1.1	-1.1
78	-0.8	-0.8	-0.7	-0.7	-0.7	-0.7	-0.7	-0.7	-0.7
79	-0.4	-0.4	-0.4	-0.4	-0.4	-0.4	-0.4	-0.4	-0.4
80	0.0	0.0	0.0	0.0	0.0	0.0	0.0	0.0	0.0
81	0.4	0.4	0.4	0.4	0.4	0.4	0.4	0.4	0.4
82	0.8	0.8	0.7	0.7	0.7	0.7	0.7	0.7	0.7
83	1.1	1.1	1.1	1.1	1.1	1.1	1.1	1.1	1.1

T _c (°F)	N								
	126	125	124	123	122	121	120	119	118
84	1.5	1.5	1.5	1.5	1.5	1.5	1.4	1.4	1.4
85	1.9	1.9	1.9	1.8	1.8	1.8	1.8	1.8	1.8
86	2.3	2.3	2.2	2.2	2.2	2.2	2.2	2.1	2.1
87	2.6	2.6	2.6	2.6	2.6	2.5	2.5	2.5	2.5
88	3.0	3.0	3.0	3.0	2.9	2.9	2.9	2.9	2.9
89	3.4	3.4	3.3	3.3	3.3	3.3	3.2	3.2	3.2
90	3.8	3.8	3.7	3.7	3.7	3.6	3.6	3.6	3.5
91	4.2	4.1	4.1	4.1	4.0	4.0	4.0	3.9	3.9
92	4.5	4.5	4.5	4.4	4.4	4.4	4.3	4.3	4.2
93	4.9	4.9	4.8	4.8	4.8	4.7	4.7	4.6	4.6
94	5.3	5.3	5.2	5.2	5.1	5.1	5.0	5.0	5.0
95	5.7	5.6	5.6	5.5	5.5	5.4	5.4	5.4	5.3
96	6.0	6.0	6.0	5.9	5.9	5.8	5.8	5.7	5.7
97	6.4	6.4	6.3	6.3	6.2	6.2	6.1	6.1	6.0
98	6.8	6.8	6.7	6.6	6.6	6.5	6.5	6.4	6.4
99	7.2	7.1	7.1	7.0	7.0	6.9	6.8	6.8	6.7
100	7.6	7.5	7.4	7.4	7.3	7.3	7.2	7.1	7.1
101	7.9	7.9	7.8	7.7	7.7	7.6	7.6	7.5	7.4
102	8.3	8.3	8.2	8.1	8.1	8.0	7.9	7.9	7.8
103	8.7	8.6	8.6	8.5	8.4	8.3	8.3	8.2	8.1

**APPENDIX D
CAPACITY TEST DISCHARGE DATA SHEET**

USS _____ DATE: _____

	TEMP BEFORE/AFTER	SPECIFIC GRAVITY BEFORE/AFTER/PT DROP
PILOT CELL # _____	____/____	____/____/____
PILOT CELL # _____	____/____	____/____/____
AVERAGE	____/____	AVG PT DROP _____

TIME (ACTUAL)	TIME DIFFERENCE (MINUTES)	BATTERY DISCHARGE RATE	CALCULATED AMP-HOURS DISCHARGED	TOTAL BATTERY VOLTAGE	AMPERE-HOUR METER READING
<hr/>					
START					
<hr/>					
FINISH					
<hr/>					

NOTE (1) $\frac{\text{TIME DIFFERENCE (MINUTES)}}{\text{REQUIRED TIME (MINUTES CORRECTED)}} \times 100 = \text{ } = \text{ } \% \text{ CAPACITY}$

$\frac{\text{ } \times \text{ NOTE (2)}}{\text{(AVG PT DROP)}} = \text{ } \text{ THEORETICAL AMP-HRS}$
(AMP-HRS/PT)

- (1) OBTAINED FROM DISCHARGE CHARACTERISTICS AND TEMPERATURE CORRECTION TABLE.
- (2) BASED ON ACTUAL LABORATORY TESTS USING 3 HOUR DISCHARGE RATE.

<u>BATTERY TYPE</u>	<u>DISCHARGE RATE</u>	<u>AMP-HR/PT</u>
MOD E (ASB-49)	2400	49
SEAWOLF (LLL-69)	2600	54
TRIDENT (PDX-57)	3450	91

NOTE: COMPARISON OF TOTAL AMP-HR VALUES (METER, CALCULATED AND THEORETICAL) WILL GIVE INDICATION OF CALCULATION ERRORS OR INACCURACIES/NEED FOR CALIBRATION OF BATTERY AMP-METER. (>10% BETWEEN METER AND CALCULATED OR >20% BETWEEN METER OR CALCULATED AND THEORETICAL INDICATES INACCURACIES OR ERRORS.) USE THE LOWEST VALUE (METER, CALCULATED OR THEORETICAL) TO DETERMINE THE 10% AND 20% VALUES.

NOTE: PILOT CELL AVG TEMPERATURES AND ACTUAL AND REQUIRED TIMES SHOULD BE ROUNDED TO THE NEAREST WHOLE NUMBER AND THE ROUNDED VALUES USED FOR ALL CALCULATIONS.

(This Page Intentionally Left Blank)

APPENDIX E

MAIN STORAGE BATTERY INSPECTION CHECK-OFF

Battery Inspection of USS _____ Date _____

NOTE: UPON BATTERY REPLACEMENT, PRIOR TO FAST CRUISE AT COMPLETION OF A DEPOT MODERNIZATION PERIOD, ENGINEERED REFUELING OVERHAUL OR ENGINEERED OVERHAUL AND ANNUALLY, USE THE MAIN STORAGE BATTERY INSPECTION CHECK-OFF TO EVALUATE THE MATERIAL CONDITION OF THE BATTERY AND DETERMINE ACCURACY AND COMPLETENESS OF BATTERY RECORDS. MATERIAL DEFICIENCIES WILL BE RECORDED IN THE EQUIPMENT STATUS LOG FOR CORRECTION AND THE JOB SEQUENCE NUMBER RECORDED IN THE MARGIN OF THE INSPECTION CHECKLIST NEXT TO THE APPROPRIATE ARTICLE. RECORD THE COMPLETION DATE OF THE MOST RECENT APPENDIX E INSPECTION AND CORRECTION OF DEFICIENCIES IN THE REMARKS SECTION OF THE QUARTERLY BATTERY REPORT. ONLY THE MOST RECENT COMPLETE COPY OF THE INSPECTION NEED BE RETAINED WITH BATTERY RECORDS.

NOTE: IF ANY CONFLICT EXISTS BETWEEN THIS CHECK-OFF AND THE REFERENCE DOCUMENTS, THE REFERENCE DOCUMENTS TAKE PRECEDENCE.

1. Battery Records and Documentation:

- a. Cycles _____
- b. Age in months _____
- c. Date battery installed _____
- d. Date of last capacity test discharge _____
- e. Capacity of battery at last test discharge _____
- f. List cell which reached minimum final cell voltage during test discharge _____
- g. Next four lowest cells at the end of test discharge Cell/Voltage **Cell Voltage**

- h. Battery ground reading, (battery circuit breakers open) _____
- i. Total battery voltage at the end of test discharge _____
- j. Pilot cells are numbers ____ and ____.
- k. List cells jumpered out ____, ____, ____, ____, ____, ____.

Yes No

2. Does the ship use standard submarine battery log (NAVSEA 9320/6 (4-90), National Stock Number 0116-LF-010-4100)? _____

3. Does a review of the completed battery logs indicate the following:

- a. Does the first set of battery charge log readings indicate that the initial charging rate (amps) did not exceed the total number of ampere-hours discharged prior to the charge? _____
- b. Subsequent log readings indicate:
 - (1) When maximum charging rate was obtained? _____
 - (2) When TVG was reached? _____

NOTE: BOTH (1) AND (2) ABOVE MAY BE WRITTEN AS ONE LOG READING IF TVG IS REACHED FIRST.

	Yes	No
c. Charge/discharge data completed correctly?	_____	_____
d. Specific Gravity (SG) data completed correctly?	_____	_____
e. Is data recorded in accordance with reference (b)?	_____	_____
f. Did the Engineering Officer of the Watch/Engineering Duty Officer review and initial the battery charging log approximately hourly during the battery charge?	_____	_____
g. Is there an effective system utilized to ensure that logs are reviewed and data entered in the BRB promptly?	_____	_____
4. Does the BCE comply with reference (a) and reference (b)? (e.g., take ground readings at fifteen minute intervals during charge)	_____	_____
5. Does a review of completed Individual Cell Record Sheets indicate the following:		
a. ICV/SG section completed correctly?	_____	_____
b. SG averages computed?	_____	_____
c. Log reviewed and signed?	_____	_____
6. At the completion of equalizing charges and prior to SG readings, does the ship check the hydrometers in use against reference hydrometers and record these readings to ensure accurate hydrometer readings? (N/A for digital thermometers)	_____	_____
7. Does the ship use and forward QBR NAVSEA 9320/3?	_____	_____
a. Is the QBR being maintained in accordance with Appendix F of this chapter?	_____	_____
b. Is Appendix D of this chapter being sent with QBR as appropriate?	_____	_____
c. Are the battery manufacturer's inspection recommendations reported as complete and status of non-completed recommendations addressed?	_____	_____
d. Is the date of completion for the last Appendix E inspection being reported on each QBR?	_____	_____
8. Does the ship have an effective system to ensure that different cells are checked for agitation before each battery charge?	_____	_____
9. Does the ship have a set of calibration curves for the venturi air-flow meter showing pressure (inches of water) versus airflow (Cubic Feet per Minute)?	_____	_____
10. Capacity Test Discharges:		
a. Was a two-ohm resistance check completed? (If applicable) (Applicable to SSGN 726, 727, 728 and SSBN 730 only until TZ-0253 Rev 0 Battery Digital Voltmeter EN DE44753 Rev D is complete.)	_____	_____
b. Are ICVs being plotted at 30-minute intervals?	_____	_____
c. When any cell drops to 1.75 volts are the ICVs being taken and plotted continuously?	_____	_____
11. Are the ship's charging instructions available in Maneuvering to the BCE?	_____	_____
a. Are they in accordance with reference (b)?	_____	_____
12. Are BRB entries in accordance with the instructions contained in Appendix G of this chapter?	_____	_____
a. Are BRB entries neat, legible and correct?	_____	_____

		Yes	No
b.	Does the Engineer Officer review and sign the BRB at monthly intervals and at each crew turnover for SSBN/SSGNs?	_____	_____
c.	Are there monthly and grand totals at the end of each month's charges?	_____	_____
d.	Are battery electrolyte sample results being recorded?	_____	_____
e.	Is discharge data being recorded properly?	_____	_____
13.	Has corrective action been taken in any case where the battery capacity has dropped 10% or below 90%?	_____	_____
14.	PMS:		
a.	Could a BCEF/BCE demonstrate the ability to properly check battery air agitation?	_____	_____
b.	Could a BCEF/BCE properly inspect the air agitation system?	_____	_____
c.	Does the ship complete the proper agitation filter Maintenance Requirement Cards?	_____	_____
d.	Is the two-ohm resistance check done within 24 hours prior to each equalizer? (If applicable) (Applicable to SSGN 726, 727, 728 and SSBN 730 only until TZ-0253 Rev 0 Battery Digital Voltmeter EN DE44753 Rev D is complete.)	_____	_____
e.	Are all cells with ICV readings of 0.10 volts below battery average checked for loose, dirty or corroded connections and completion recorded on ICV Sheet?	_____	_____
f.	Have the following been calibrated:		
	(1) Ammeters:		
	(a) Emergency propulsion motor ammeters?	_____	_____
	(b) Main storage battery ammeters?	_____	_____
	(c) Main storage battery ampere-hour meter?	_____	_____
	(d) Ship's Service Motor Generator DC ammeters?	_____	_____
	(2) Voltmeters:		
	(a) Emergency propulsion motor voltmeters?	_____	_____
	(b) Main storage battery voltmeters?	_____	_____
	(c) Main storage battery individual cell voltmeter?	_____	_____
g.	Have the following had calibration checks performed:		
	(1) Hydrometers?	_____	_____
	(2) Thermometers?	_____	_____
	(3) Battery Airflow Meter?	_____	_____
	(4) Hydrogen detector?	_____	_____
	(a) Is the proper equipment onboard for completion of this calibration?	_____	_____
	(b) Do both meters read within 1/2% H ₂ of each other?	_____	_____
NOTE:	METER ACCURACY IS +1/4%. IF INDIVIDUAL METERS INDICATE BELOW A READING OF -1/4%, H₂ CIRCUIT INACCURACY SHOULD BE SUSPECTED.		
h.	Are the flash arrestors cleaned and checked in accordance with PMS?	_____	_____

Yes No

- i. Were failed flash arrestors replaced or treated for water repellency by Ship's Force or Fleet Maintenance Activity? _____
- j. Is the battery cleaned and inspected at specified periodicity? _____
- k. When the isolated battery ground decreases to 50,000 ohms, does the ship pursue the cleaning/correction of battery grounds? _____
- l. Was inspection of individual cell voltmeter and intercell connection completed? _____
- m. Was torquing of intercell connectors completed? _____

15. Battery Well and Material Items:

- a. During the last two equalizing charges, did all of the cells have a SG within 0.010 points of the average SG? _____
 - (1) If no, list cells and gravities.

Date	Chg #	Cell	SG	Cell	SG	Date	Chg #	Cell	SG	Cell	SG

- (2) Were these cells inspected for proper agitation, SG verified and the results recorded on back of the individual cell record sheet in accordance with reference (a)? _____
- b. Does the location of the pilot cells meet the criteria defined in reference (b)? _____
- c. Does the ship have a "Charge in Progress" sign to install over the battery hatch during battery charges? _____
- d. During inspection of the battery well was it free of any loose or unauthorized gear? _____
 - (1) Is the battery well hatch free, latch works and gasket not deteriorated? _____
 - (2) Are the cell tops cleaned? _____
 - (3) Are the flash arrestors free of electrolyte? _____
 - (4) Are jumpered cells properly jumpered out? _____
 - (5) Is agitation being maintained for isolated cells? _____
 - (6) Is electrolyte level being maintained for isolated cells? (N/A for cells due to grounds) _____
 - (7) Are jumpered cell terminals painted red? _____
 - (8) Spot check several cells throughout the battery well. Is electrolyte height and air agitation proper? _____
 - (9) Are the battery deck flats properly secured? (Note missing or damaged fastener hardware) _____

		Yes	No
(10)	Is the battery well deck and area between cells clean, dry and free of foreign material?	_____	_____
(11)	Are meter leads on the shunt tight?	_____	_____
e.	Are the air hoses and fittings in the air agitation system free of deterioration and cracks?	_____	_____
f.	Is the lighting sufficient?	_____	_____
g.	Are the support bracket nuts either self locking or lockwired/lock cabled? (Trolley, disconnect links, etc.)	_____	_____
h.	Are the ICV leads properly bundled and securely fastened in standoffs to prevent sagging or rubbing?	_____	_____
i.	Do ICV conductors have the proper clearance from bussing?	_____	_____
j.	Are ICV fuses of the proper type and are ICV connections tight?	_____	_____
k.	Are the plastisol covers on connections and bussing free of cuts and in good condition?	_____	_____
l.	Are ventilation ducts and filters clean:		
(1)	Battery Inlet Filter?	_____	_____
(2)	Battery Inlet Plenum?	_____	_____
(3)	Battery Outlet Plenum?	_____	_____
m.	Does the ship have rubber matting available for working in the battery well?	_____	_____
n.	Are battery water hose ends and battery water guns capped or covered when not in use to prevent entry of foreign matter?	_____	_____
o.	Is the battery watering hose tagged for "Battery Watering Only"?	_____	_____
p.	How many hydrometers are onboard? (See reference (b) table 223-3 for allowance requirements)		
	Number		
	Range		
(1)	Low Range _____ (_____SG to _____SG)		
(2)	Mid Range _____ (_____SG to _____SG)		
(3)	High Range _____ (_____SG to _____SG)		
(4)	Digital _____		
q.	Are the reference hydrometers labeled as such and segregated from the remaining hydrometers?	_____	_____
r.	Are the in use hydrometers cleaned after use?	_____	_____
s.	Does the ship have a current copy of Allowance Equipage List - 1-911393001?	_____	_____
t.	Does the ship have the required operating space items in accordance with Allowance Parts List 090660045 (ASB-49), T090660036 (PDX-57), or 090660046 (LLL-69)?	_____	_____
u.	Does the ship have the required number of jumper cable assemblies available for use onboard?		
(1)	60 inch cables (four) [72 inch cables on SSBN/SSGN-726 Class]	_____	_____
(2)	30 inch cables (eight) [36 inch cables on SSBN/SSGN-726 Class]	_____	_____
(3)	36 inch cable assemblies (six) on SSN-21 Class	_____	_____

	Yes	No
(4) 72 inch cable assemblies (three) on SSN-21 Class	_____	_____
(5) Eighteen LLX terminal plates on SSN 21 Class ships	_____	_____
(6) LLX hardware jumper assemblies on SSN 21 Class ships	_____	_____
(7) Are these assemblies complete?	_____	_____
(8) Are these assemblies stowed in a dry place?	_____	_____
(9) Are these assemblies cleaned in accordance with applicable PMS?	_____	_____
v. Are the leads for cell and battery testing in the ICV panel tight?	_____	_____
w. Do they fit properly into the female connectors?	_____	_____
x. Are eye wash facilities, with a minimum 2-quart capacity, available near the battery well hatch?	_____	_____
y. Does the ship have the torque wrenches (two) required for intercell torquing?	_____	_____
(1) Are they calibrated?	_____	_____
(2) Are the sockets six point?	_____	_____
z. Are the battery well heaters:		
(1) Turned on when injection temperature is less than 55°F?	_____	_____
(2) Turned off whenever the battery well hatch is open?	_____	_____

Results and Recommendations:

Submitted: _____
 Inspector Officer

Title _____

Noted: _____
 Commanding Officer

Date _____

APPENDIX F

INSTRUCTIONS FOR COMPLETING SUBMARINE BATTERY
QUARTERLY REPORTS - NAVSEA 9320/3

1. General. Accurate battery reports are an absolute requirement. These reports enable reviewing activities to recognize a specific problem or to change the scheduled battery replacement date based on the history and performance of a particular battery installation. These reports provide vital information for assessing submarine readiness, predicting future funding requirements and scheduling battery renewals. The NAVSEA form 9320/3 is designed to facilitate the automatic data processing of specific information reported. Therefore, all blocks must be completed correctly.
2. Frequency. This section is applicable to all submarines with installed storage batteries, including those in pre-commissioning status.
 - a. Submarine QBRs shall be submitted each calendar quarter that a battery is installed in the ship. The report shall be submitted within five working days of the quarter just ending, operations permitting.
 - b. When a battery is being replaced, submit a “final” report on the date the battery is removed. Submit a “first” report on the date a new battery is installed. If no battery is installed on the end of a reporting quarter (such as during overhaul) no report is required. First reports shall contain the date of initial filling, the date of installation and data on the installing activity acceptance test discharge. Ampere-hours and cycles of charge from the initial charge and developing cycle shall not be included as part of the total ampere-hours and cycles.
 - c. A “special” report shall be submitted whenever the battery capacity falls below 90%, whenever battery capacity decreases more than 10 percentage points from the previous capacity test discharge or anytime unusual or unexplained changes occur.
3. Distribution.
 - a. Original to Naval Surface Warfare Center Crane (Code 6095).
 - b. One copy to the applicable TYCOM. (Commander Submarine Force Atlantic Code N43213/Commander Submarine Force Pacific Code 43213.)
 - c. One copy to the ISIC.
 - d. One copy to the GNB Industrial Power.
 - e. One copy for ship’s file.
4. Instructions. (See Sample Report.)
 - a. Submarine QBRs will be submitted on form NAVSEA 9320/3 (provided by TYCOM) as a word document.
 - b. Title Section. Insert ship’s name and hull number on FROM line. Fill in the date of submission (must be 1 January, 1 April, 1 July, or 1 October, except Special Reports), and the date of installation (the battery completely bussed and fully ready for service). Place an “X” in the appropriate box to indicate individual meters/detectors are currently in calibration.

Block #(s)	Required Format	Remarks
1-5	Five digits, no blanks.	Unit Identification Code (UIC).
6-11	Letters and numbers. Do not use hyphens. Block 11 may be blank.	Battery type (ASB-49, PDX-57, LLL-69).
12-13	Two digits, no blanks.	Battery age in months to the nearest whole month computed from the date of initial filling (02, 05, 32, 55, etc.).

Block #(s)	Required Format	Remarks
14	One digit.	Fiscal Quarter (either 1, 2, 3, or 4) (Note: Oct, Nov, Dec is Fiscal Quarter 1).
15-16	Two digits.	Fiscal Year (01, 02, etc.).
17	Either X or blank.	Mark with an X if this is the first report after a new battery installation. Otherwise leave blank.
18	Either X or blank.	Mark with an X if battery has been removed or inactivated. Otherwise leave blank.
19-20	Two digits, no blanks.	Months (to nearest whole month) on open circuit since initial filling. Months on open circuit is defined as any calendar month in which an onboard charge is not conducted and the battery is only used intermittently for supplemental power or not used at all.

- c. Battery Upkeep (Section A). Fill in data as indicated for battery charges, cycles and watering. Amount of water shall be to the nearest gallon. Ampere-hours shall be to the nearest ampere-hour. Under “Amp-Hours Charged (A-H Meter)” and “Amp-Hours Discharged (A-H Meter)” columns, “Last Report” and “Total” entries are not required (see Sample Report).

Block #(s)	Required Format	Remarks
21-24	Four digit, no blanks	Total cycles to the nearest tenth of a cycle since initial charge (127.8, 002.1, etc.). Freshening charges are included but ampere-hours charged during the initial charge and developing cycle are not to be included in computing cycles. Amp-Hrs Charged <u>(Calculated)</u> = # of cycles X (see note)

NOTE: FOR ASB-49 X=6500; LLL-69 X=7000; PDX-57 X=10,000.

25-27	Three digits, no blanks.	Total number of normal charges completed (000, 016, 238, etc.).
28-30	Three digits, no blanks.	Total number of equalizing charges completed (000, 083, 192, etc.).
31-33	Three digits, no blanks.	Total number of partial charges (000, 008, etc.).

- d. Data at End of Equalizing Charge (Section B). Enter data for equalizing charges only. Battery volts and ICVs are to be corrected to 80°F. To obtain corrected average SG, correct each cell for its temperature and compute the average of corrected specific gravities.

Block #(s)	Required Format	Remarks
34-37	Four digits or leave blank.	Total corrected battery voltage to the nearest tenth of a volt (339.0, 344.2, etc.). ICV readings are rounded off to two significant digits (2.72, 2.51 etc.).
42-45		
50-53		
58-61		

- e. Battery Capacity Tests (Section C). If no test discharge was conducted during the reporting quarter, enter data from previous test discharge. A completed copy of Appendix D of this chapter will be included with this report when a test discharge was conducted during the reporting quarter.

Block #(s)	Required Format	Remarks
66-71	Six digits or the letters "INYARD"	Month, day and year of the capacity test discharge (02/25/01, 11/03/02, etc.). For ships that are in CNO Maintenance Availabilities for more than six months, put the words "INYARD" in Blocks 66-71 and report the date and information of the last capacity test discharge on the line below Blocks 66-71.
72-75	Four digits, no blanks.	Percent capacity to the nearest tenth (088.5, 101.2, etc.).

- f. Other Data and Signature Lines (Section D). Use this section to include remarks such as (attach additional sheets if required to keep the information legible):

- (1) Date of the most recent Appendix E Main Storage Battery Inspection Check-Off.
- (2) Cells noted during PMS, inspection or battery charging lineups that had insufficient air agitation.
- (3) Cell or cells jumpered this quarter and reason.
- (4) Any other information that would affect the service life or performance of the battery.
- (5) Report completion of manufacturer's battery inspection recommendations and plan for completion of any recommendations not yet accomplished.
- (6) Meter calibration problems, battery open circuited and other pertinent information.
- (7) Results of electrolyte analysis performed as a result of battery manufacturer's recommendation.

SAMPLE REPORT

SUBMARINE BATTERY QUARTERLY REPORT														NAVSEA PRT 9320-1																									
NAVSEA 9320/3 (REV 1-78) 0116-LF-093-2016																																							
From:						DATE OF SUBMISSION				QUARTERLY CHECK (Check One)				YES		NO																							
Commanding Officer, USS (Ship's Name and Hull No.)						05 Oct 95				PROP. MTR. & GEN. AMMETERS				<input type="checkbox"/>		<input type="checkbox"/>																							
To: Commander, Code 6095 Bldg. 3287 NAVSURFWARCENDIV 300 Highway 361 Crane, IN 47522-5001						DATE OF INITIAL FILING				BATTERY AMMETERS				<input type="checkbox"/>		<input type="checkbox"/>																							
						09 Dec 93				BATTERY A-H METERS				<input type="checkbox"/>		<input type="checkbox"/>																							
Requiring Document: Naval Ships Technical Manual Chapter 223, Vol. 1						DATE OF INSTALLATION				PROP. MTR. & GEN. VOLTMETERS				<input type="checkbox"/>		<input type="checkbox"/>																							
						12 Feb 94				BATTERY VOLTMETERS				<input type="checkbox"/>		<input type="checkbox"/>																							
						DATE OF ELECTROLYTE ANALYSIS (SEMI-ANNUAL)				BATTERY AIRFLOW METERS				<input type="checkbox"/>		<input type="checkbox"/>																							
						15 Apr 95				HYDROMETERS				<input type="checkbox"/>		<input type="checkbox"/>																							
1 0		2 5		3 5		4 5		5 5		6 T		7 L		8 X		9 3		10 9		11 8		12 2		13 2		14 4		15 9		16 5		17		18		19 0		20 4	
UIC						BATTERY TYPE						AGE (MONTHS)		FY RPT QTR		FISCAL YEAR		FIRST RPT		FINAL RPT		MONTHS ON OPEN CIRCUIT																	
A- BATTERY UPKEEP																																							
		WATER USED (GALLONS)		AMP HOURS CHARGED (CALCULATED)		CYCLES (1)		NUMBER OF CHARGES						AMP HOURS CHARGED (A-H METER)		AMP HOURS DISCHARGED (A-H METER)																							
								NORMAL		EQUALIZING		PARTIAL																											
LAST REPORT		265		141989		028.4		080		018		005		NA		NA																							
FIRST MONTH		70		8773		001.8		005		001		000		8882		8067																							
SECOND MONTH		62		13959		002.8		007		001		001		14121		14690																							
THIRD MONTH		53		17808		003.6		010		001		000		16		17317																							
TOTAL		450		182529		0 3 6 6		1 0 2		0 2 1		0 0 6		NA		NA																							
						21 22 23 24		25 26 27		28 29 30		31 32 33																											
(2) B-DATA AT END OF EQUALIZING CHARGE																																							
DATE			BATTERY VOLTS CORRECTED TO 80°F (3)			CORRECTED SP. GR. (AVERAGE) (4)			CELLS 10 POINTS BELOW OR ABOVE AVERAGE SP. GR (CONTINUE IN REMARKS SECTION)						FOUR LOWEST CORRECTED INDIVIDUAL CELL VOLTAGE (5)																								
MO. DA. YR.									CELL		NONE		NONE		NONE		CELL		81		74		77		75														
			34 35 36 37			1.274			SP. GR.								VOLTS		2.72		2.72		2.72		2.73														
08 25 95			34 35 36 37			1.280			CELL		104		NONE		NONE		CELL		81		104		47		101														
			42 43 44 45						SP. GR.		1.270						VOLTS		2.69		2.71		2.72		2.72														
09 28 95			34 4 2 1			1.280			CELL		NONE		NONE		NONE		CELL		81		41		104		58														
			50 51 52 53						SP. GR.								VOLTS		2.69		2.70		2.71		2.71														
			58 59 60 61						CELL								CELL																						
									SP. GR.								VOLTS																						
DATE			BATTERY DISCHARGE RATE (6) (AMPERES)			ACTUAL TIME (MIN) (7)			AGE IN CYCLES (6)			AVG. PILOT CELL TEMP AT START AND END			RATED TIME (MIN) (9)			ACTUAL CAPACITY (PERCENT) (10)			NO. OF CELLS JUMPERED			FINAL VOLTS															
MO. DA. YR.												CELL NO.												TOTAL		THREE LOWEST CELLS													
06 12 95			8 6 7 7			1750			186			26.7			START			END			179			72 73 74 75			0			212		CELL		91		102		47	
8 6 8 6 7 7			8 7 8 9 0 1																										VOLTS		1.51		1.53		1.63				
																										CELL													
																										VOLTS													
D-OTHER DATA AND SIGNATURE LINES																																							
REMARKS: (11)																																							
COPY TO:															ENGINEERING OFFICER																								
FORCE COMMANDER (Self Explanatory)																																							
COMSUBRON (Self Explanatory)																																							
BATTERY MFR (As appropriate)															APPROVED BY																								
FILE															COMMANDING OFFICER																								
(Numerals in parentheses refer to instructions on reverse side)																																							

APPENDIX G

INSTRUCTIONS FOR MAINTAINING THE SUBMARINE BATTERY RECORD BOOK
NAVSEA 9320/1 (3-92)

1. GENERAL. Accurate battery records are an absolute requirement. These records enable reviewing activities to identify problem areas or to change the scheduled battery replacement based on the performance of a particular battery installation. These records provide the data necessary to complete NAVSEA form 9320/3, Submarine Battery Quarterly Report. Therefore, proper maintenance of the BRB is essential.

2. INSTRUCTIONS.

- a. Remarks Section: This section should include information of a general nature. Information such as the following should be included: Date and manner of installation; lifting of a cell for examination and results thereof, electrolyte "spiking" to include reason for action, quantities involved, authority granted, etc.; initial pilot cells selected, as well as any change of pilot cells; any change, transfer or removal of cells; pertinent data concerning the isolation of cells; completion of battery manufacturers recommendations from battery inspection reports; other abnormal or unusual information that is pertinent to the battery. The following should not be included in the remarks section: waterings; two ohm load checks; PMS checks; water purity test results performed by Ship's Force; battery well inspections or other information of a repetitive nature unless different or unusual conditions exist.
- b. Electrolyte Analysis Section:
- (1) Laboratory - enter the name of the laboratory where the analysis was performed.
 - (2) Serial or file number of report - enter the number assigned to the report by the laboratory.
 - (3) Date - the date on which the sample was taken from the cell (vice the date the analysis was performed by the laboratory).
 - (4) Cells analyzed - enter the battery cell number from which the sample was drawn.
 - (5) Remarks - enter either satisfactory or unsatisfactory based on the analysis record. If unsatisfactory, enter the reference covering the action taken.

NOTE: THE "DATE" AND "CELLS ANALYZED" INFORMATION SHOULD BE ENTERED IMMEDIATELY AFTER THE SAMPLE IS DRAWN. ALL OTHER INFORMATION SHOULD BE ENTERED UPON RECEIPT OF THE LABORATORY REPORT.

- c. Equalizing Charge Data Section:
- (1) Date - enter the date on which the equalizing charge was commenced. (This should match the date on the Submarine Battery Log (NAVSEA 9320/6)).
 - (2) Charge number - enter the charge number for the equalizing charge being logged.
 - (3) Average SG - for all nuclear submarines, the average SG of the battery (all battery cells in the circuit) following the equalizing charge is recorded in Block 1. (This should never be the pilot cell averages, but an average of the entire battery.) Block 2 will only be used on diesel submarines.
 - (4) Cells - list all cells with a SG greater than or equal to ten points (0.010 SG) above or below the battery average SG. List the following: cell number, corrected SG of the cell, corrected ICV. If no cells are beyond the ten-point parameter, write "None".
- d. Summary of Test Discharges and Trial Runs:
- (1) Date - enter the date in which the test discharge was performed.
 - (2) Battery rate including average auxiliary load - capacity test discharges are conducted at the three-hour rate for all submarine battery types. The discharge rates are as follows for each battery type:

Guppy 1, Mod E (ASB-49)	2400 amps (three hr rate)
TRIDENT (PDX-57)	3450 amps (three hr rate)
SEAWOLF (LLL-69)	2600 amps (three hr rate)

- (3) Limiting voltage allowed - enter the total battery voltage limit and the ICV limit allowed for the discharge rate maintained (as noted in the Battery Rate block). These values are noted in reference (a) for each battery type and discharge rates.
- (4) Temperature - enter the average pilot cell temperature at the start and at the finish of the test discharge cycle in the appropriate block. (Round to whole number).
- (5) Required length of discharge corrected for temperature - enter the rated length of time (in minutes) to attain 100% capacity. This value must be corrected for temperature. Temperature corrections are accomplished utilizing the applicable Curve and Data table contained in reference (a). The average temperature of the pilot cells is used in the temperature correction. For example: If pilot cell temperatures are 83°F and 86°F, average temperature equals 84.5°F. This number is rounded to 85°F. Required length of discharge for the 3-hour rate would be 182.5 minutes. This number is rounded to 183 minutes.
- (6) Discharge maintained - enter the actual time (in whole minutes). This will be the duration of the discharge to the limiting voltage (either total battery voltage, ICV or average ICV). Limiting voltages are listed on the appropriate Curve and Data table in reference (a).
- (7) Total volts at end of discharge - enter the actual switchboard voltage (recorded at the EPCP) immediately prior to securing the test discharge.
- (8) Actual capacity - enter the actual capacity in percent. Capacity is always logged to the nearest tenth (i.e., 100.5%). Capacity is computed as follows:

$$\text{Percent capacity} = \frac{\text{Actual time (min)}}{\text{Rated time (min)}} \times 100$$
- (9) Ten lowest voltage cells at end of discharge - list ten individual cells with the lowest end of discharge voltage. Cells should be listed in ascending (lowest to highest) voltage order for trending purposes.
- (10) Remarks - enter any pertinent data, event or condition with regards to the test discharge. If comments are too extensive to fit in the space provided, write "See Remarks Section" and enter the data in the "Remarks" section of the BRB.

e. Condensed Summary of all Charges and Waterings:

NOTE: LIST PILOT CELLS IN AN ASCENDING ORDER, WITH THE LOWEST NUMBERED PILOT CELL LISTED FIRST.

NOTE: DATA SHOULD BE ENTERED INTO THE BATTERY RECORD BOOK AS SOON AS POSSIBLE UPON COMPLETION OF THE CHARGE/DISCHARGE IN ORDER TO PREVENT THE LOSS OF DATA SHOULD THE BATTERY CHARGE/DISCHARGE LOG BE LOST DURING THE REVIEW PROCESS. THIS INITIAL DATA ENTRY MAY BE DONE IN PENCIL TO PREVENT UNNECESSARY LINE OUTS UNTIL THE CHARGE REVIEW PROCESS IS COMPLETE.

- (1) Pilot Cell Numbers - enter, in the space provided at the top of each page, the current pilot cell numbers. If the pilot cell(s) are changed, draw a single line through the old pilot cell number(s) and write in the new pilot cell number(s). The change need only be made on the page in which the pilot cell(s) are changed.
- (2) Date - enter the date entered on the Submarine Battery Log (NAVSEA 9320/6). This should reflect the date in which the charge was begun.
- (3) Type of charge - enter the code, as designated below, that reflects the type of charge conducted. The following codes apply:

N = Normal charge
 E = Equalizing charge
 P = Partial charge
 EE = Extended or non-tapering charge

- (4) Charge number - enter the charge numbers in sequential order. Charge numbering begins with the first on board charge.
- (5) SG and temperature-pilot cells - the data to be entered in this section should match the data entered in the "Specific Gravity Data" block in the lower right hand corner of the Submarine Battery Log (NAVSEA 9320/6). As noted at the top of each page of this section, all SG entries must be the temperature corrected values (height corrections are not used for the current batteries). Before change/after change number - enter the pilot cell number for the data to be entered in that column. As previously noted, enter the pilot cells in an ascending order, with the lowest numbered pilot cell listed first.
- (6) End of charge voltage - entries in this section are required to be temperature corrected. The data to be entered can be retrieved from the Submarine Battery Log (NAVSEA 9320/6).
- (a) Pilot cells - enter the end of charge corrected ICV for both pilot cells. To facilitate entering both pilot cells, evenly split the column using a black pen. Extend the line into the "Pilot cells" header. Enter the pilot cell numbers above each newly created column (enter the numbers in the header area, beneath the words "Pilot cells"). (Pilot cell numbers should be entered in ascending order.) Individual cell temperature corrections can be accomplished by using the TCV formula. Enter a value of "1" for the "N" (number of cells) value.
- (b) Total voltage corrected to 80°F - enter the TCV value. TCV is calculated using the formula in reference (a). (The last on charge battery voltage reading entered on the Submarine Battery Log (NAVSEA 9320/6) must be used in this calculation). This value need only be entered for equalizing and non-tapering equalizing charges. This value is contained in Block 4 of the Submarine Battery Log (NAVSEA 9320/6).
- (7) Minutes on charge after reaching TVG at finishing rate - enter the total time (in whole minutes) from the point at which the finishing rate is reached at TVG until the charge is completed. This value need only be entered for equalizing and non-tapering equalizing charges. This data is contained in Block 5 of the Submarine Battery Log (NAVSEA 9320/6).
- (8) Hours of charge to nearest tenth (this charge) - enter the total number of hours (to the nearest tenth) to complete the charge (time from the first on charge log readings, until the last on charge log reading). This data is contained in Block 6 of the Submarine Battery Log (NAVSEA 9320/6).
- (9) Amp-hours of charge per battery (this charge) - enter the calculated ampere hours of charge. (Calculate as indicated in reference (a)). This number should be rounded to the nearest whole number. This data is contained in Block 8 of the Submarine Battery Log (NAVSEA 9320/6).
- (10) Total cycles of charge to nearest 0.1 - enter the value for total cycles to the nearest tenth. This data is contained in Block 9 of the Submarine Battery Log (NAVSEA 9320/6). Use the following formula to derive these values:

$$\text{Cycles} = \frac{\text{Ampere-hours (calculated)}}{\text{Service cycle}}$$

A service cycle is defined as follows:

Guppy 1, Mod E (ASB-49)	6,500 ampere hours
TRIDENT (PDX-57)	10,000 ampere hours
SEAWOLF (LLL-69)	7,000 ampere hours

(11) Number of gallons of water used - enter the amount of water (in gallons) actually added to the cells. The amount used to flush out the watering hose and piping prior to sampling the filling water is not included in this figure. The value should be rounded to the nearest whole number. This data is contained in Block 13 of the Submarine Battery Log (NAVSEA 9320/6).

(12) Percent charge back - enter the percentage of ampere hours charged back. The data is contained in Block 12 of the Submarine Battery Log (NAVSEA 9320/6). This value is calculated using the following formula:

$$\text{Percent charge back} = \frac{\text{Ampere hour meter charged}}{\text{Ampere hour meter discharged}} \times 100$$

(13) Ampere hours by meter - enter the values as read directly from the ampere hour meter. Discharged values are the ampere hours as read immediately prior to the start of charge. Charged values are the ampere hours from the beginning (following resetting (zeroing) the ampere hour meter) of the charge to the charge completion. The mode selector switch must be placed in the appropriate position (depending on ampere hour meter type used). The values for discharge and charge ampere hours are contained in Blocks 10 and 11 respectively of the Submarine Battery Log (NAVSEA 9320/6).

(14) Totals - both monthly and grand totals must be calculated at the end of the calendar month. Quarterly totals need not be maintained, but may be calculated if desired. If quarterly totals are maintained, entries should coincide with the submission date of the QBR. The following values must be computed for monthly and grand totals (and quarterly, if maintained).

- (a) Hours of charge to nearest tenth (this charge) - computed by adding the hours of charge values for each individual charge.
- (b) Ampere hours of charge per battery (this charge) - computed by adding the ampere hours of charge values per battery for each individual charge.
- (c) Total cycles for charge to nearest 0.1 - computed by dividing the appropriate (monthly, grand totals or quarterly) ampere hours of charge by the appropriate service cycle as listed below.

$$\text{Cycles} = \frac{\text{Ampere-hours (calculated)}}{\text{Service cycle}}$$

A service cycle is defined as follows:

Guppy 1, Mod E (ASB-49)	6,500 ampere hours
TRIDENT (PDX-57)	10,000 ampere hours
SEAWOLF (LLL-69)	7,000 ampere hours

- (d) Number of gallons of water used - computed by adding the water addition values for each individual charge.
- (e) Ampere hours by meter - computed by adding the ampere hours of discharge/charge for each individual charge.

NOTE: ONLY MONTHLY TOTALS ARE REQUIRED FOR AMPERE HOURS BY METER. GRAND TOTALS NEED NOT BE MAINTAINED.

(15) BRB audits/records reviews - between 9 and 15 months since last inspection, through a NAVSEA contract, a battery manufacturer's representative will conduct an on-site battery inspection. The BRB will be signed and dated following the representative's review. Where possible, the dated signature will be placed after the last month of the inspection period in the "Condensed Summary of All Charges and Waterings" section. Battery records should be made available for overnight off-ship review by the battery manufacturer's representative.

f. Certification by Engineer Officer:

- (1) This section certifies that the Engineer Officer has reviewed the battery records (including the BRB) for accuracy and legibility. The Engineer should review and sign the BRB on a monthly basis and at each crew turnover for SSBN/SSGNs.
- (2) Period - from date/to date - enter the period/time frame of the records being reviewed.
- (3) Signature - signature of the reviewing officer (Engineer Officer).
- (4) Rank - rank of the reviewing officer (Engineer Officer).

(This Page Intentionally Left Blank)

VOLUME VI

CHAPTER 22

TRIDENT SYSTEM AND EQUIPMENT MAINTENANCE PLANS

REFERENCES.

- (a) OPNAVINST 4700.7 - Maintenance Policy for U.S. Naval Ships
- (b) SUBMEPP 9086-008-814 - TRIPER Information Notebook

LISTING OF APPENDICES.

A TRIPER Information Sheet

22.1 PURPOSE. To provide information and guidance concerning TRIDENT submarine system and equipment maintenance plans and associated programs.

22.2 TRIDENT SYSTEM AND EQUIPMENT MAINTENANCE PLANS. Maintenance plans have been prepared for all maintenance worthy configuration items onboard SSBN/SSGN 726 Class Submarines. These maintenance plans are written to the system, equipment and/or component and list all of the planned maintenance required by a configuration item during its life cycle. These Maintenance Requirements are derived through the conduct of a maintenance engineering and a logistics support analysis process. Maintenance plans list the job description, periodicity, maintenance level (organization, intermediate, or industrial) and the applicable maintenance procedures. Unrestricted Operation (URO), TRIDENT Planned Equipment Replacement (TRIPER), Major Shore Spares (MSS), Maintenance Standards (MS) and Performance Monitoring applications are included in maintenance plans as appropriate. Technical management of these plans is assigned to the Submarine Maintenance Engineering, Planning and Procurement Activity. An SSBN/SSGN 726 Class Submarine Maintenance Plan comprising all individual maintenance plans is issued periodically by NAVSEA. In accordance with reference (a), the Type Commander will identify and prioritize corrective maintenance actions for SSBN/SSGN Class Submarine emergent repairs. Programs and requirements supporting the SSBN/SSGN 726 Class operating cycle are discussed in the following paragraphs.

22.2.1 TRIDENT Planned Equipment Replacement. The purpose of the TRIPER program is to accomplish an incremental overhaul of a submarine over several refit periods in the case of SSBNs and during Major Maintenance Periods (MMP) in the case of SSGNs.

- a. Shipboard equipment which requires significant maintenance during the planned operating cycle between overhauls, which is beyond the capability of Ship's Force, and which cannot be accomplished during the refit period or MMP (without unacceptable impact on other refit or MMP requirements), will be supported by this program. TRIPER equipment will be removed from the ship for refurbishment ashore, replaced with pre-tested, ready for issue units and the affected system restored to full operational condition prior to completion of the refit period or MMP. Replacement will be accomplished on a planned basis at intervals designed to preclude the failure of the equipment or significant degradation of its associated system. Deviations of greater or less than one refit or MMP from established TRIPER change-out periodicities shall require Type Commander concurrence. A planned change to shelf stock TRIPER equipment will be accomplished only when sufficient change kits are available to effect the change in all units of a given model of the equipment held in shelf stock. Shelf stock TRIPER equipment is represented in configuration status accounting databases maintained by Submarine Maintenance Engineering, Planning and Procurement Activity Hull, Mechanical, Electrical, Ordnance and Electronic and Naval Underwater Warfare Center Division Newport and transitions to the configuration database of the receiving ship upon installation.
- b. The Type Commander shall manage emergent repairs requiring use of TRIPER assets. In accordance with reference (a), the Type Commander will identify and prioritize corrective maintenance actions for SSBN/SSGN Class Submarine emergent repairs. Support of the Strategic Platform (SSBN) generally has the highest priority.

22.2.2 Deployed SSGN Unplanned TRIPER Change Out. An unplanned change out is not to be used as a substitute for accomplishing repairs. An unplanned change out is only to be accomplished if the deficient condition cannot be repaired or if the repair time required is unacceptable.

22.2.2.1 TRIPER Asset Segregation. TRIPER assets are segregated from normal supply process instructions and additional controls are in effect to manage these assets. Additional actions beyond normal supply procedures are required to obtain a TRIPER asset for corrective maintenance. Stake holders in the maintenance process for SSGNs must understand the TRIPER process and how to quickly identify a TRIPER asset from normal stock numbered items to ensure timely release of material from the TRIPER Program. The supply system will cancel requisitions that have not been pre-alerted to the TRIPER Program Management.

22.2.2.2 TRIPER Information Notebook. Reference (b), available as a CD-ROM from SUBMEPP, provides identification, location, Comp ID, technical data, boundary drawings and configuration change records for all components in the TRIPER Program. All TRIPER assets have a TRIPER Tag with a unique TRIPER Serial Number (TSN) engraved on it. Location of the TRIPER Tag is shown on the component boundary drawing. TRIPER assets have a "4Y" COG national stock number. When requesting a "4Y" COG asset, Appendix A must be submitted by the Fleet Maintenance Activity (FMA) to the homeport SSGN Project Team. The homeport SSGN Project Team will interact with TRIPER Program Management to ship the requested asset to the needed location.

22.2.2.3 Responsibilities.

- a. SSGN: Identify the deficient component TSN via the Casualty Report message reporting system and submit work request to their Immediate Superior In Command.
- b. Immediate Superior In Command: Assign job to an FMA.
- c. FMA:
 - (1) Fill out Appendix A and forward to the homeport SSGN Project Team.
 - (2) Upon confirmation of receipt of delivery of Appendix A, the FMA will order the TRIPER asset via normal supply means.
 - (3) Receive shipped TRIPER asset, carefully uncrate and save the shipping container for use as a shipping container for the off-loaded asset carcass.
 - (4) Ship back the TRIPER carcass to an address provided by the SSGN Project Team in the same shipping container the received asset was shipped in.
- d. Naval Submarine Support Center: Induct a separate job from the actual maintenance action Job Sequence Number for the homeport SSGN Project Team to ship the TRIPER asset to and from job location. This will allow for closing of the maintenance action Job Control Number (JCN) for work certification and maintain a separate JCN for disposition of the shipped asset to and from the deployed maintenance site.
- e. SSGN Project Team:
 - (1) Use Appendix A, fill out the appropriate forms and deliver to the TRIPER Manager. Forms are: "REQUEST FOR UNSCHEDULED REPLACEMENT OF TRIPER ASSET" and/or "REQUEST FOR CANNIBALIZATION OF TRIPER PROGRAM ASSET". Appropriate forms can be found on the internet under Navy Forms on Line.
 - (2) Act as liaison between the FMA and the TRIPER Manager.
 - (3) Ship the TRIPER asset to desired location when released by the TRIPER Manager.
 - (4) Coordinate the return shipment of the TRIPER carcass to the TRIPER Manager.
 - (5) Close out Naval Submarine Support Center inducted job once the TRIPER Manager has received the carcass.
- f. TRIPER Manager:
 - (1) Evaluate request priorities of the requested asset from a total TRIPER Program support position. Approve the release of the requested asset.

- (2) Ensure appropriate Pre-Installation Testing and material condition assessments are conducted prior to the release of the asset to the SSGN Project Team.
- (3) Release asset to the SSGN Project Team for subsequent shipping to desired location.

22.2.3 Major Shore Spares. The purpose of the TRIDENT MSS Program is to maintain a supply of designated major equipment candidates in a certified, tested, ready-for-issue condition to effect replacement of equipment experiencing catastrophic failure, without jeopardizing refit completion. The employment of MSS assets shall require Type Commander authorization. Typically, MSS equipment includes ship's propeller, Ship's Service Turbine Generators, towed arrays, towed buoys, Integrated Radio Room cabinets, etc. Like TRIPER, MSS equipment is managed by NAVSEA (PMS 392). Configuration tracking is under the cognizance of the applicable Participating Manager and is identified in the TRIDENT MSS Catalog published by NAVSEA (PMS 392). Equipment under the cognizance of the Strategic System Project Office and Naval Sea Systems Command Nuclear Propulsion Directorate (NAVSEA 08) is not included in the TRIPER or MSS programs.

22.2.4 Fleet Logistics Agent. The function of the fleet logistics agent for SSBN/SSGN 726 Class Submarines has been assigned to the TRIDENT Refit Facility (TRIREFFAC) in the case of Kings Bay and Puget Sound Naval Shipyard and Intermediate Maintenance Facility (PSNS-IMF) for the Pacific Northwest. TRIREFFAC and PSNS-IMF provides refit/MMP and configuration management support. These functions involve:

- a. Staging and delivering updated Logistics Technical Data (LTD) applicable to the ship's current configuration.
- b. Providing available interim technical documentation and logistic support elements for emergent changes installed during refit/MMP.
- c. Assessing the logistic impact and reporting of, configuration changes effected by all sources in SSBN/SSGN 726 Class Submarines.

22.2.5 Updating of Submarine Logistics Technical Data. TRIREFFAC and PSNS-IMF will stage and deliver LTD Advance Change Notices and revisions to SSBN/SSGN 726 Class Submarines during refit/MMP and shall assist Ship's Force in the removal and disposal of LTD that is no longer applicable to the ship's current configuration. Upon request, TRIREFFAC and PSNS-IMF will also provide training to Ship's Force in the proper techniques for identification, procurement and maintenance of TRIDENT LTD.

22.2.6 Planned Refit Work Lists. Planned Refit Work Lists (PRWL) define all the planned work required for each SSBN/SSGN 726 Class ship for a one year period or four refits. The PRWL includes scheduled TRIPER replacements, URO and Performance Monitoring requirements. In addition, alterations approved for accomplishment will be incorporated into the PRWL. The PRWL will be issued periodically, each for a one year period. Subsequent PRWLs will include rescheduling of requirements identified on previous work lists which were not reported complete. Each PRWL will allocate specific work items to a proposed refit based on the Class Maintenance Plan scheduled requirements and projected manpower requirements

(This Page Intentionally Left Blank)

APPENDIX A
TRIPER INFORMATION SHEET

FMA will fill out this form and forward to SSGN Project Team

1. Requesting Activity: _____

2. Requesting Activity Point of Contact: _____

3. Phone number(s): _____

4. E-mail: _____

5. Date: _____

6. Ship: USS _____ SSGN (_____)

7. CASREP Serial Number and/or Date Time Group of message:

8. JCN: _____

9. NSN: _____

10. COG: 4Y

11. Nomenclature: _____

12. TRIPER Serial No. (TSN) of failed item TSN _____
(TSN is located on the assets TRIPER Tag)

13. FGC (S): _____

14. Requisition Number: _____

15. Description of failure: _____

16. Remarks: _____

Printed name of FMA Repair Officer/PMA

Signature: _____ Date: _____

(This Page Intentionally Left Blank)

VOLUME VI
CHAPTER 23
SUBMARINE NOISE REDUCTION

REFERENCES.

- (a) NAVSEA S9073-AW-SNC-010 - Ship Acoustical Surveys for Submarines
- (b) NAVSEA S9073-A4-SNC-010 - USS LOS ANGELES (SSN 688) Class Acoustic Stealth Manual
- (c) NSWCCD-71-TR-2001/020 - February 2001 USS SEAWOLF (SSN 21) Class Acoustic Stealth Manual
- (d) NAVSEAINST C9073.2 - Acoustical Survey of Submarines
- (e) COMSUBFORINST C9460.3 - Coordinated Submarine Radiated Noise Analysis
- (f) NAVSEA S9073-AF-SNC-010(C) - Ship Noise Control
- (g) NAVSEA S0600-AA-PRO-230 - Underwater Ship Husbandry Manual, Chapter 23: Submarine Predeployment Noise Inspections
- (h) NAVSEA S0600-AA-PRO-010 - Underwater Ship Husbandry Manual
- (i) NAVEDTRA 10500 - Catalog of Navy Training Courses
- (j) COMNAVSUBFORINST 5400.25 - Standard Submarine Supply Department Organization and Regulations Manual
- (k) COMNAVSUBFORINST 5400.29 - Standard Submarine Navigation/Operations Department Organization and Regulations Manual
- (l) COMNAVSUBFORINST 5400.40 - Standard Submarine Combat Systems Department Organization and Regulations Manual (SSN)
- (m) COMNAVSUBFORINST 5400.41 - Standard Submarine SSBN 726 Class Weapons Department Organization and Regulations Manual
- (n) COMNAVSUBFORINST 5400.47 - Standard Submarine Combat Systems Department Organization and Regulations Manual (SSGN)

LISTING OF APPENDICES.

- A Supplemental Noise Measurements
- B Beartrap Acoustic Radiated Trials (BART)
- C Shipboard Noise Reduction Instruction
- D Predeployment Noise Inspection
- E Submarine Silencing Publications
- F Sample Propeller Changeout Message

23.1 **PURPOSE.** This chapter provides the requirements for an effective onboard noise reduction program during the ship's operating cycle. It identifies the acoustic surveys required to assess the radiated noise signature of a ship and summarizes the responsibilities and requirements for the onboard surveys necessary to be performed on a regular basis to maintain the submarine in its most quiet configuration.

23.1.1 **Scope.** Reference (a) discusses the various acoustic surveys to be conducted on ships in order to establish their baseline noise signatures and to monitor those signatures throughout the operating cycle. Surveys discussed in reference (a) are briefly summarized, as well as several additional survey techniques available and essential to an effective noise reduction program. In addition, a discussion of the model shipboard noise reduction program and available training programs are presented. References (b) and (c) provide class specific and comprehensive documentation on submarine noise reductions, including discussion of acoustic surveys, shipboard noise reduction program, acquisition systems, and procedures, data analysis and trending, and detailed write-ups with photographs and audio clips of typical noise sources. In addition, the manual contains an extensive library of documents and training aids.

23.1.2 **Background.** Reduction of the radiated noise signature of a submarine platform is a key element to the tactical employment of the ship. As a ship begins its operating cycle, a series of acoustic surveys are conducted to characterize the baseline noise signature. Then, throughout the remainder of its operating cycle, the ship requires the tools and procedures necessary to monitor its signature against the baseline. As deficiencies are identified,

Ship's Force needs to have an understanding of the extent to which an identified deficiency can affect the ship's radiated noise signature and the procedures required to effect corrective action. It should be kept in mind that although the implications of a degraded noise signature are fundamentally tactical in nature, the primary method of preserving a ship's acoustic advantage is through an aggressive and effective planned and corrective noise reduction maintenance program. Because of an increased emphasis in recent years, a number of new initiatives are being pursued within the technical community to develop new and improved measurement procedures and equipment that will assist Ship's Force in more effectively assessing the effects of noise deficiencies on their radiated noise signature. These efforts should lead to improved survey procedures and will be incorporated into future changes to this chapter.

23.2 NOISE REDUCTION PROGRAM ELEMENTS.

23.2.1 Radiated Noise Surveys.

23.2.1.1 Naval Sea Systems Command Acoustic Trials. These trials are conducted at the beginning of and at various times throughout each ship's operating cycle in accordance with reference (d) and provide a broad range of baseline measurements for the ship. In particular, the radiated noise signature of the ship is measured under various operating conditions. A determination is made of the controlling radiated noise offenders including those which are speed and depth dependent. While the principal objective of these trials is to assess the radiated noise signature of the submarine, platform and machinery and hull vibration measurements are also made to provide baseline and supporting data in these areas for continued ship monitoring.

23.2.1.2 Coordinated Submarine Radiated Noise Analysis Exercise. This test shall be conducted in accordance with reference (e), for Commander Submarine Force Atlantic (COMSUBLANT) units and Commander Submarine Force Pacific (COMSUBPAC) units. The primary objective of these submarine-versus-submarine exercises is to collect and analyze data to assess current acoustic vulnerabilities. These tests can be used during Pre-Overseas Movement (POM)/Deployment Preparation Period (DPP) work-ups to indicate that the deploying unit's acoustic signature is free of any unusual or highly detectable noise characteristics.

23.2.1.3 Coordinated Submarine Exercises (KILOEX/JTFEX/INT-2/TRACKEX/GUNSLINGER). While acoustic trials and surveys are the principal means to evaluate a submarine's acoustic profile, coordinated exercises provide another opportunity for the submarine force to monitor itself for noise deficiencies. Although the primary purpose of these exercises is generally tactically oriented, the noise signature obtained can and should also serve to monitor submarine radiated noise. It is incumbent upon exercise participants to note and record any unusual or excessive radiated noise being emitted by submarine exercise participants. Discrepancies noted should be reported to the cognizant Immediate Superior In Command (ISIC) for evaluation and corrective action. Initial message reports should be followed by supporting documentation including tape recordings, annotated lofargrams, and annotated frequency spectrum plots. The message report should contain the following information:

- a. Description of noise signature problem.
- b. Date and time of detection.
- c. Range at detection.
- d. Sensor/processor used for detection.
- e. Own ship depth and speed.
- f. Acoustic sea state.
- g. Water depth.
- h. Water temperature.
- i. Layer depth.

23.2.1.4 Beartrap Acoustic Radiated Trials. The primary objective of these trials is to provide a cost effective means to detect and identify radiated noise sources that have caused signature degradations. Coordinated trial events are conducted with Marine Patrol Aircraft. Detected narrowband tones in the radiated noise signature are

provided by naval message. Parent ISICs are responsible for requesting these trials. Specific information, including message requests and scheduling requirements, as well as Ship's Force and Type Commander (TYCOM) responsibility is provided in Appendix B of this chapter.

23.2.2 Onboard Noise Surveys. The noise surveys discussed in this section do not provide conclusive information on the actual radiated noise signature of the ship. However, when these surveys are analyzed for developing trends, they can be effective tools for monitoring overall ship effectiveness in noise reduction.

23.2.2.1 Platform Noise Survey. This survey is conducted to define own ship's noise environment and is the best means available to Ship's Force to assess the radiated noise signature of the ship using only onboard equipment. Surveys are conducted by taking periodic measurements under various ship's operating conditions using the applicable Planned Maintenance System (PMS) Maintenance Requirement Cards (MRC). In addition, at-sea watch-to-watch aural monitoring is also conducted. Analysis of this data determines the platform noise signature and also identifies the noise offenders which affect this signature. When changes in the ship's signature occur, the diagnostic procedures of the class specific platform noise manual are used to isolate the noise source. Platform Noise Surveys should be conducted in accordance with enclosure (2a) of Appendix C of this chapter. Propeller cavitation surveys, a separate survey from the Platform Noise Survey but considered an important part of platform noise monitoring analysis, should be conducted in accordance with enclosure (2b) of Appendix C of this chapter.

23.2.2.2 Topside and Housekeeping Survey. The most common and preventable sources of submarine noise are rattles emanating from improperly secured topside equipment, discontinuities in the hull, and machinery noise sound shorted to the hull due to improper stowage.

23.2.2.2.1 Topside Survey. The topside survey consists of a thorough inspection to identify and eliminate potential noise sources external to the pressure hull. Particular attention should be given to ensure that rattles are not installed, built in, or created by repairs, alterations, or stowage. Topside Surveys should be conducted in accordance with enclosure (2c) of Appendix C of this chapter.

23.2.2.2.2 Housekeeping Survey. The housekeeping survey consists of a thorough visual inspection to identify and eliminate these potential noise sources internal to the pressure hull. Particular attention should be given to ensure that sound shorts are not installed, built in, or created by repairs, alterations, or stowage. Housekeeping Surveys should be conducted in accordance with enclosure (2d) of Appendix C of this chapter.

23.2.2.3 Machinery Vibration Survey. A vibration survey conducted quarterly for both machinery health assessment and noise reduction purposes. Performance of this survey alone does not provide reliable information on radiated noise. Machinery Vibration Surveys should be conducted in accordance with enclosure (2e) of Appendix C of this chapter.

23.2.2.4 Hull Vibration Survey. A shipboard hull vibration survey is conducted quarterly or as required for the purpose of noise diagnostics by Ship's Force. The purpose is to assess acoustic deficiencies related to noise sources and transmission paths, and to estimate certain slow-speed, low frequency radiated noise levels. Hull Vibration Surveys should be conducted in accordance with enclosure (2e) of Appendix C of this chapter.

23.2.2.5 Isolation System Survey. This survey consists of a visual inspection of sound isolation components throughout the ship per applicable road maps and reference (f). These components include resilient mounts, pipe hangers, ground straps, and flexible piping. This visual inspection ensures that these devices are properly installed, undamaged and not sound shorted. Improper installation or failure of any of these devices will contribute to increasing the radiated noise signature of the ship. Isolation System Surveys should be conducted in accordance with enclosure (2f) of Appendix C of this chapter.

23.2.2.6 Damping Material Survey. This is a visual inspection of sound damping material installed in the vicinity of sonar arrays, sail, free flood spaces, and on machinery foundations. Like the isolation system survey, this inspection is designed to detect deficiencies in materials installed to limit the radiated noise signature of the ship. Damping Material Surveys should be conducted in accordance with enclosure (2g) of Appendix C of this chapter.

23.2.2.7 Predeployment Noise Inspections. Requirements and forms are contained in references (g) and (h) and Appendix D of this chapter.

23.2.2.8 Technical Onboard Monitoring Assist. This survey consists of at sea analysis by acoustic technical experts to evaluate the acoustic signature of the ship. The survey consists of a towed array, platform noise hydrophones and machinery and hull vibration measurements taken simultaneously to identify and localize major acoustic degradation. Emphasis is placed on training the submarine's crew on own ship noise data acquisition and analysis using their available sensors. Technical Onboard Monitoring Assists should be conducted in accordance with Appendix A of this chapter.

23.2.2.9 Sound Absorption Material Survey. This is a thorough visual inspection of interior sound absorption material and sound transmission loss material conducted in all spaces. These materials are installed to assist in habitability of the ship by absorbing vibration. Sound Absorption Material Surveys should be conducted in accordance with enclosure (2h) of Appendix C of this chapter.

23.2.2.10 Airborne Noise Survey. The airborne noise survey exists to identify shipboard areas whose airborne noise levels have increased or are possibly high enough to cause hearing damage. Airborne Noise Surveys should be conducted in accordance with paragraph 5.c.(6) of Appendix C of this chapter.

23.2.3 Shipboard Noise Reduction Program. The key to a successful shipboard noise reduction program will be the ability of the ship to identify potential noise deficiencies and to initiate prompt corrective action. References listed in Appendix E of this chapter should be a part of the ship's onboard library of submarine silencing publications. Several elements of the noise reduction program are discussed in the following paragraphs.

23.2.3.1 Noise Reduction Officer. To ensure a coordinated and aggressive approach to noise reduction, each ship will assign one of its senior Department Heads, as designated by the Commanding Officer, to serve as Noise Reduction Officer. The Noise Reduction Officer will coordinate the activities of all personnel assigned to support the ship's Noise Reduction Program. This officer will ensure that all required surveys are conducted, that identified deficiencies are documented, and that corrective action is initiated. A Noise Reduction Board, chaired by the Noise Reduction Officer, will convene at regular intervals to review the status of the Noise Reduction Program. Following each meeting, formal written reports will be made to the Commanding Officer.

23.2.3.2 Noise Deficiency Log. The ship's Equipment Status Log (ESL) will be used to record and track all noise deficiencies. Deficiencies will be entered in the section for the Work Center (WC) responsible for the equipment concerned. The Critical Noise Deficiencies (NC)/Potential Noise Deficiencies (NP) code (per paragraph 23.2.3.3 below) in the deficiency description block will tag the entry as a noise deficiency. The Noise Reduction Officer will ensure the ESL is properly maintained and accurately reflects the latest status of all noise deficiencies. Items to be entered in the ESL include noise deficiencies reported during radiated noise acoustic trials as well as those discovered during onboard surveys. Ship's logs shall be maintained in a manner where all diagnostics, repairs or other evaluations performed are documented. The logs need to be maintained until noise issues are verified to be repaired by associated acoustic or vibration measurements.

23.2.3.3 Noise Related Maintenance Records. The OPNAV 4790/2K will be used to document all deferred and completed noise related maintenance actions. Block 46-G will be used to further classify noise deficiencies in one of two categories; NC and NP.

NOTE: INFORMATION CONTAINED IN WORK CANDIDATES MUST BE UNCLASSIFIED. IF CLASSIFIED DATA IS REQUIRED TO FULLY DESCRIBE THE NATURE OF THE PROBLEM BEING REPORTED, REFER TO TYCOM REPORTING REQUIREMENTS TO FULLY DESCRIBE THE NATURE OF THE PROBLEM.

- a. The NC code will be used to identify deficiencies of a critical nature identified during one of the following:
 - (1) Naval Sea Systems Command (NAVSEA) Acoustic Trials.
 - (2) Supplemental Radiated Noise Measurements.
 - (3) Technical Onboard Monitoring Assist.
 - (4) Platform Noise Monitoring Surveys.
- b. The NP code will be used to identify deficiencies that could potentially be radiated noise problems identified during one of the following:

- (1) Topside and Housekeeping Surveys.
- (2) Machinery and Hull Vibration Surveys.
- (3) Isolation System Surveys.
- (4) Damping Material Surveys.
- (5) Airborne Sound Absorption Material Surveys.
- (6) Routine Ship Operations.

23.2.4 Training. Formal training course prerequisites and descriptions are listed in reference (i). Specific training requirements are contained in references (j) through (n).

23.3 RESPONSIBILITIES.

23.3.1 Immediate Superior In Command.

- a. Assign a Staff Noise Reduction Officer as a specific point of contact for all matters relating to noise reduction within the Squadron.
- b. Oversee and supervise the Noise Reduction Program within the Squadron, ensuring that assigned units aggressively identify and correct noise deficiencies.
- c. Submit requests for Beartrap Acoustic Radiated Trials (BART) to COMSUBLANT/COMSUBPAC, N454, N42N, as appropriate.
- d. Schedule acoustic surveys during the operating cycle of submarines in accordance with reference (d).
- e. Recommend and/or authorize corrective actions based on the findings of the surveys conducted.
- f. Review Noise Reduction Program records, survey results, procedures and monitoring equipment during material readiness inspections, Tactical Readiness Evaluations and POM/DPP certification.
- g. Schedule divers to conduct underwater hull and propeller surveys for noise deficiencies prior to undocking, pre-deployment, post-deployment, and during upkeep.
- h. Report propeller replacements using the message format of Appendix F of this chapter.
- i. Ensure that personnel tasked to support assigned submarines are adequately trained in submarine noise reduction.

23.3.2 Industrial Activity.

- a. Ensure proper handling and repair of noise critical machinery.
- b. Conduct in-shop and in-place balancing of all rotating equipment, both motors and coupled units, repaired by the industrial activity.
- c. Conduct in-place balancing as authorized by work requests.
- d. Assist ships in identifying and correcting noise problems and in conducting noise surveys in accordance with approved work requests.
- e. Establish new baseline machinery and hull vibration measurement data for repaired units.
- f. Ensure that all applicable personnel are adequately trained in submarine noise reduction.
- g. Conduct underwater hull and propeller surveys for noise deficiencies in accordance with reference (g).

23.3.3 Submarine Commanding Officer.

- a. Establish and maintain a ship's Noise Reduction Program consistent with this chapter. Appendix C of this chapter provides the basis for a shipboard instruction to meet this requirement.
- b. Appoint a senior Department Head as Noise Reduction Officer and establish a Ship's Noise Reduction Board.

(This Page Intentionally Left Blank)

APPENDIX A
SUPPLEMENTAL NOISE MEASUREMENTS

This Appendix provides a brief discussion of the TYCOM sponsored, noise measurements that may periodically be conducted on submarines during their operating cycle.

TECHNICAL ONBOARD MONITORING ASSIST (TOMA)

1. Purpose. TOMAs are conducted on submarines to maintain their acoustic signatures between scheduled radiated noise trials. Major acoustic degradations and their corrective actions are identified, and training is provided to Ship's Force.
2. Procedure. TOMA schedules are coordinated by the TYCOMs and the Squadrons. TOMAs are conducted by Naval Surface Warfare Center (NSWC), with assistance from on-site Performance Monitoring Team (PMT) and Ship's Force personnel. TOMAs need 18 to 30 hours of data acquisition time. Normally, TOMAs are conducted on three to seven day underways and can be scheduled concurrently with other operations. Tests consist of a series of runs in various machinery line ups to collect data required to assess the acoustic signature of the submarine. Data is collected using onboard sensors and compared to baseline signatures from previous acoustic trials. A TOMA will serve as the quarterly hull, machinery, and platform noise surveys.
3. Frequency. TOMAs are to be conducted prior to, or early in the POM/DPP cycle when no radiated noise trial is scheduled to occur within one year of the deployment date.

NOTE: A TOMA IS NOT A SUBSTITUTE FOR THE NAVAL SEA SYSTEMS COMMAND ACOUSTIC TRIAL. A TOMA MAY ALSO BE REQUESTED BY THE SUBMARINE'S ISIC.

4. Reports. NSWC will issue a "quick look" message from the submarine at the completion of the TOMA. This message will detail significant findings and recommended corrective actions, as well as the status of previous corrective actions. A separate message will be sent by NSWC detailing hull and machinery vibration data.
5. Action. Ship's Force and the submarine's ISIC should use the results and recommendations of the TOMA "quick look" message to schedule and implement corrective action. Ship's Force should use the 3-M Maintenance Data System to document deficiencies and corrective actions. For deferred items, the Noise Reduction Officer should develop and implement appropriate corrective action.

(This Page Intentionally Left Blank)

APPENDIX B**BEARTRAP ACOUSTIC RADIATED TRIALS (BART)**

1. Purpose. BARTs provide submarines with the opportunity to measure and assess their narrowband radiated noise signatures, identify problems, and provide an opportunity to correct deficiencies and evaluate their acoustic health prior to certain deployments.
2. Procedure. BARTs are initially scheduled by TYCOM prior to major deployments or upon request by the submarine's ISIC. The ISIC is then responsible for updating the TYCOM on schedule changes. BARTs are a structured Beartrap in a designated quiet ocean area in accordance with the BART agenda. The objective is to collect sufficient data to determine the radiated noise signature and mission readiness of the ship. Data collection on station is accomplished by Commander Patrol Reconnaissance Forces Pacific (COMPATRECONFORPAC) or Commander Patrol Reconnaissance Forces Atlantic (COMPATRECONFORLANT) Anti Submarine Warfare patrol aircraft and is restricted to a single eight hour period during ship operations in a designated ocean area.
3. Frequency. For COMSUBPAC units, ISICs should coordinate BART scheduling for their submarines such that each ship will be tested prior, or early in the DPP. The schedule should allow sufficient time for corrective action on noise deficiencies detected during the BART to be planned and accomplished during a DPP upkeep period. For COMSUBLANT units, ISICs should coordinate BART scheduling for their submarines as required.
4. Reports. For Pacific Fleet submarines, COMPATRECONFORPAC will issue a message within 60 days of completion of a BART. For Atlantic Fleet submarines, "quick look" message will be issued in accordance with Local Operating Instructions.
5. Action. Ship's Force and the submarine's ISIC should use the results of the BART messages to schedule and implement corrective action for noise deficiencies detected during the trial. For deferred items the Noise Reduction Officer should develop and implement appropriate corrective action.

(This Page Intentionally Left Blank)

APPENDIX C
SHIPBOARD NOISE REDUCTION INSTRUCTION

USS (Ship's Name and Hull No.)
 Subj: SHIP'S NOISE REDUCTION PROGRAM
 Ref: (a) COMUSFLTFORCOMINST 4790.3; Joint Fleet Maintenance Manual, Volume VI, Chapter 23
 Encl: (1) Quarterly Noise Reduction Program Status Report
 (2) Noise Reduction Surveys
 (3) Control Surface Noise Questionnaire

1. Purpose. To establish a ship's Noise Reduction Program to include: a Noise Reduction Board to advise the Commanding Officer concerning appropriate noise reduction procedures; a set of noise surveys to characterize the ship's noise signature; and procedures to ensure proper coordination of efforts in the ship's noise reduction program.

2. Discussion. A great deal of emphasis has been placed on upgrading noise reduction awareness within the submarine force. As required by reference (a), (Ship's Name) must devote continued attention to the detection, correction and prevention of increases in its radiated noise signature. Significant mission degrading radiated noise problems could not be tolerated in wartime. (Ship's Name) must minimize noise to maximize our detection range of threats/targets and to reduce the possibility of hostile ships detecting (Ship's Name). Quietness is absolutely essential to our primary mission and a continuous, aggressive effort must be made in acoustic housekeeping and noise reduction to ensure a quiet ship. The acoustic surveys considered mandatory for effectively maintaining a quiet ship and improving the ship's acoustic signature during the operating cycle are discussed in this instruction. While these surveys serve as a formal means of noise reduction, each crew member's actions play an equally important role in the noise reduction consciousness of the entire ship. A quiet ship requires involvement of the whole crew. **THINK QUIET!**

3. Program Organization.

- a. A ship's Noise Reduction Board shall be established to assist the Commanding Officer in the development and execution of long and short range plans for maintaining and enhancing the acoustic posture of the ship. The board will recommend appropriate shipboard noise reduction procedures and monitor their execution. The board will consist of the following personnel:
- (1) Executive Officer.
 - (2) Combat Systems Officer.
 - (3) Engineer Officer.
 - (4) Sonar Officer.
 - (5) Electrical Officer.
 - (6) First Lieutenant.
 - (7) Sonar Division Leading Petty Officer.
 - (8) Electrical Division Noise Reduction Petty Officer (NRPO).
 - (9) Chief of the Boat.
 - (10) Sail Coordinator.
- b. To assist the board in carrying out their responsibilities, experienced Petty Officers and non-rated personnel who have completed qualification in submarines shall be assigned in the ship's collateral duties notice as NRPO. Each division will have at least one formally designated NRPO.

4. Program Management.

- a. The Noise Reduction Officer will coordinate all noise reduction activities within the ship. The Noise Reduction Board will meet quarterly and discuss actions completed and further action required to correct outstanding noise deficiencies. Special quarterly noise reduction boards should be held prior to the initial work definition conference for depot availabilities (initial planning meetings are typically scheduled; Selected Restricted Availability/Interim Drydocking A-43 weeks, Depot Modernization Period/Engineered Refueling Overhaul A-12 months) and prior to POM1 upkeep periods. The Noise Reduction Officer will chair these meetings. The Noise Reduction Officer will ensure that the noise reduction portion of the ESL contains updated entries on all outstanding noise deficiencies. Each of the significant noise deficiencies will be discussed at every meeting. The Commanding Officer will be apprised of the results of the meeting and any unresolved problems shortly after the meeting. Formal written reports summarizing the status of the Noise Reduction Program will be submitted following each meeting to the Commanding Officer using the format of enclosure (1).
- b. Onboard surveys will be conducted in accordance with this instruction. Noise deficiencies discovered during these surveys or detected during routine ship's operations will be reported to the Noise Reduction Officer. At sea, these reports will be made to the Officer Of the Deck (OOD) who will, in turn, inform both the Noise Reduction Officer and the Commanding Officer. The OOD will initiate corrective action for all significant noise deficiencies and ensure that these items are included in the watch turnover. All deficiencies that are not immediately correctable will be entered in the noise deficiency section of the ESL.
- c. The Noise Reduction Officer shall ask the following questions during each Noise Reduction Board meeting.
 - (1) Have we effected all corrective action recommendations from our latest acoustic trials? Have on board measurement surveys conclusively proven that outstanding noise deficiencies were corrected? Report all unresolved items to the Commanding Officer using the format of enclosure (1).
 - (2) Have any noise sources, especially rattles or control surface transients, been aurally detected during the conduct of the platform noise survey of enclosure (2a)? If rattles or transients are present, have tape recordings or data packages been accomplished in accordance with platform noise or maintenance manual guidance for submission?
 - (3) Have we conducted a propeller tip cavitation survey in accordance with enclosure (2b)? Are the measured tip cavitation points acceptable? If cavitation is not acceptable, has a tape package been prepared in accordance with reference (a)?
 - (4) Have any signature degradations been identified from the latest set of towed array, platform noise hydrophone or machinery and hull vibration measurements? If so, have the noise sources been identified? Report unresolved items to the Commanding Officer using the format of enclosure (1).

5. Action.

- a. The Executive Officer shall:
 - (1) Attend all Noise Reduction Board meetings.
 - (2) Implement a comprehensive, all hands training program to elevate the awareness of Ship's Force personnel to the importance of noise reduction.
- b. The Noise Reduction Officer shall:
 - (1) Coordinate and administer the ship's Noise Reduction Program.
 - (2) Schedule Noise Reduction Board meetings and chair their meetings.
 - (3) Report the status of noise deficiencies to the Commanding Officer following meetings of the Noise Reduction Board. Submit written summary reports to the Commanding Officer using the format of enclosure (1).

- (4) Ensure that cognizant divisions enter all noise reduction deficiencies in the ESL, that prompt corrective action is taken by responsible divisions and that work requests are submitted for deficiencies beyond the capability of Ship's Force.
 - (5) Ensure that acoustic trial deficiencies are entered in the ESL and that appropriate corrective action is initiated.
 - (6) Assess the tactical implications of noise deficiencies detected during underway operations and make recommendations to the Commanding Officer as to tactical limitations and required corrective action.
 - (7) Ensure that cognizant divisions have men properly trained in Ship's Force acoustic surveys, noise reduction equipment, proper bearing replacement, and in-place balancing of rotating equipment.
 - (8) Ensure that surveys are being conducted by cognizant divisions and that deficiencies are reported to the Commanding Officer.
 - (9) Conduct spot reviews of acoustic survey results.
 - (10) Be inventory manager of all publications required by reference (a), to support the Noise Reduction Program and ensure that divisions have applicable MRCs.
 - (11) Assist the Engineer Officer with the implementation and maintenance of the ship's quiet bills.
 - (12) Ensure action is taken, to the maximum extent possible, to complete enclosure (3) for all identified control surface noises.
- c. The Sonar Officer shall:
- (1) Ensure that the Platform Noise Survey is accomplished, recorded, and analyzed in accordance with enclosure (2a).
 - (2) Perform Propeller Cavitation Noise Surveys as required in accordance with enclosure (2b).
 - (3) Develop propeller cavitation curves in accordance with enclosure (2b) and forward results to the Commanding Officer via the Noise Reduction Officer.
 - (4) Direct the use of the installed sonar systems to assist in the identification and isolation of noise related material deficiencies detected in Topside, Housekeeping, Machinery and Hull Vibration, and Isolation System Surveys. (Enclosures 2c, 2d, 2e, and 2f respectively refer).
 - (5) Ensure that Damping Material Surveys are accomplished, recorded, and analyzed in accordance with enclosure (2g).
 - (6) Ensure the Airborne Noise Surveys are accomplished, recorded, and analyzed in accordance with the applicable Maintenance Index Page (MIP). The Sonar Officer shall ensure that airborne noise levels in all shipboard areas remain within permissible limits. An Airborne Noise survey shall be conducted when increased airborne noise levels are suspected of exceeding permissible limits. A written report in memorandum form shall be submitted for each watch station and shall include, as a minimum, the date of inspection, names of personnel conducting the survey, and the discrepancies noted in the ESL. Review the status of noise level measurements and any affected watch station and report this information to the Commanding Officer and the ship's corpsman.
 - (7) Report immediately any abnormal increase in own ship's noise to the OOD and the Noise Reduction Officer.
 - (8) Ensure that all survey deficiencies are entered in the noise reduction section of the ESL and reported to the Noise Reduction Officer. Ensure that prompt corrective action is taken and that work requests are submitted for deficiencies beyond the capability of Ship's Force.
 - (9) Ensure that personnel assigned to conduct noise reduction surveys under his cognizance are properly trained.

- d. The Electrical Officer shall:
 - (1) Ensure that the Machinery and Hull Vibration Surveys are accomplished, recorded, and analyzed in accordance with enclosure (2e).
 - (2) Ensure that in-place balancing is conducted on an assembled unit at any time that repairs are made by Forces Afloat that would affect the balance of the equipment.
 - (3) Determine the cause of out of specification machinery and hull vibration readings and initiate corrective action.
 - (4) Ensure that prompt corrective action is taken and that work requests are submitted for deficiencies beyond the capability of Ship's Force.
 - (5) Ensure that personnel under his cognizance assigned to conduct noise reduction surveys are properly trained.
- e. The First Lieutenant shall:
 - (1) Ensure that the Topside and Housekeeping Surveys are accomplished, recorded, and analyzed in accordance with enclosure (2c) and (2d).
 - (2) Ensure that the Sound Absorption Material Survey is accomplished, recorded, and analyzed in accordance with enclosure (2h).
 - (3) With the assistance of the Supply Officer, ensure that equipment, stores, personal effects, and consumables are stowed in a manner that will not produce noise or transmit noise to the ship's hull or structure.
 - (4) Ensure that all survey deficiencies are entered in the noise reduction section of the ESL and reported to the Noise Reduction Officer. Ensure that prompt corrective action is taken and that work requests are submitted for deficiencies beyond the capability of Ship's Force.
 - (5) Ensure that personnel under his cognizance assigned to conduct noise reduction surveys are properly trained.
- f. The NRPO shall:
 - (1) Promote the Noise Reduction Program in their respective divisions.
 - (2) Perform or assist in the performance of noise reduction surveys under their respective division's cognizance in accordance with enclosure (2).
 - (3) Enter all survey deficiencies in the noise reduction section of the ESL and report deficiencies to the cognizant Division Officer.
- g. The OOD shall:
 - (1) Remain aware of the status of critical noise deficiencies and operate the ship in a manner that will minimize its radiated noise signature.
 - (2) Report all new noise deficiencies and the correction of existing deficiencies to the Noise Reduction Officer and the Commanding Officer. Ensure new deficiencies are recorded in the noise reduction section of the ESL.
 - (3) Ensure sonar watchstanders conduct aural monitoring of own ship's noise signature upon initial dive and once per watch.

From: Noise Reduction Officer
To: Commanding Officer
Via: Executive Officer

Subj: QUARTERLY NOISE REDUCTION PROGRAM STATUS REPORT FOR PERIOD
ENDING (DATE)

Encl: (1) Noise Reduction Section of ESL

1. The following MRCs associated with the Noise Reduction Program were not accomplished, partially accomplished, or deferred:

MRC No./Deficiency reason/Corrective Action

2. The following noise deficiencies were identified during the current period:

Deficiency/Source/ESL No./Plan of action for identification and repair

3. The following previously identified noise deficiencies were corrected during the current period:

Deficiency/Corrective Action

4. The following noise deficiencies from the previous period are outstanding:

Deficiency/Source/ESL No./Diagnostics and repairs performed/Plan of action for identification and repair

5. Enclosure (1) summarizes all currently outstanding deficiencies associated with the Noise Reduction Program.

Submitted: _____

Noise Reduction Officer

Copy to:
Engineer Officer

Enclosure (1)

(This Page Intentionally Left Blank)

NOISE REDUCTION SURVEYS

1. This enclosure contains a description of the onboard surveys conducted in support of the Noise Reduction Program. For each survey, applicable references are cited and a summary of procedures and reporting requirements are presented. Surveys included are:

- Enclosure 2a Platform Noise Survey
- 2b Propeller Cavitation Noise Survey
- 2c Topside Survey
- 2d Housekeeping Survey
- 2e Machinery and Hull Vibration Survey
- 2f Isolation System Survey
- 2g Damping Material Survey
- 2h Sound Absorption Material Survey

Enclosure (2)

(This Page Intentionally Left Blank)

PLATFORM NOISE SURVEY

- Reference: (a) Class Applicable Technical Manual for Platform Noise Monitoring Analysis for Noise Reduction
 (b) Class Applicable SO-544 MIP/MRCs
 (c) OPNAVINST 5513.5A Department of the Navy (DON) Security Classification Guidance for Undersea Warfare Programs

1. Responsibility. Sonar Officer.

2. Procedure.

- a. Platform Noise Surveys shall be conducted as specified in references (a) and (b).
- b. Sonar supervisors shall monitor each hydrophone for objectionable noises at least once each watch while underway and report results to the OOD. Problems detected shall also be recorded in the Noise Reduction section of the ESL. Problem investigation and corrective action shall be initiated as soon as possible within the current operations schedule.
- c. As soon as feasible, after diving, following an inport period, accomplish the following:
 - (1) Monitor each platform hydrophone for objectionable noise while changing speed in five knot increments up to Flank speed (monitor all frequency bands/where applicable). At slow speed, monitor hydrophones nearest the rudder/stern planes and fairwater planes while each control surface is cycled. Monitor the hydrophone nearest the sail while each mast and antenna is cycled. If control surface deficiencies are found complete the applicable portions of the Control Surface Noise Questionnaire, enclosure (3), to report control surface noise. This questionnaire assists in troubleshooting.
 - (2) Check at least one point of the propeller cavitation curve. If results are significantly different from the previous data, establish a new cavitation curve at the earliest opportunity as discussed in enclosure (2b).
 - (3) If operations preclude complete accomplishment of (1) and (2) above, speeds/areas not monitored should be noted and carried forward in the sonar supervisor's log until they can be monitored.
 - (4) Results of this monitoring will be reported to the OOD and deficiencies recorded in the ESL.
- d. For any abnormal noises, magnetic tape recordings should be made in accordance with reference (a). These tape recordings together with complete supporting data shall be forwarded by priority registered mail second day delivery to:

For COMSUBLANT units:

Carderock Division
 Naval Surface Warfare Center
 9500 MacArthur Blvd.
 West Bethesda, MD 20817-5700
 Attn: Code 711 - Fleet Support Program Manager
 For: New London Units, data packages should be forwarded to:
 NSSC NEW LONDON CT, N42

Enclosure (2a)

For COMSUBPAC units:

Naval Surface Warfare Center
Carderock Division
Bremerton Detachment
530 Farragut Ave
Attn: Code 713
Bremerton, Washington 98314-5215

NOTE: SIPRNET FILES FROM SHIP SHOULD BE LIMITED TO 400KB. HUIITS AND SAILOR-MAIL CAN BE UTILIZED FOR LARGER FILES. MP3 OR OTHER COMPRESSED FORMATS SHOULD BE USED TO SAVE SPACE. 10-15 SECONDS OF AUDIO IS USUALLY ADEQUATE. IF URGENT REQUEST ON EVENINGS, HOLIDAYS, OR WEEKENDS, HAVE SWO CONTACT TYCOM STEALTH OFFICERS TO EXPEDITE. DURING TYCOM WORKING HOURS, NOISE REDUCTION SUPPORT CAN BE PROVIDED VIA CHAT. SUPPORT CAN BE ARRANGED ON EVENINGS OR WEEKENDS THROUGH SWO.

To receive immediate feedback, audio files can be sent via SIPRNET or other secure method to:

For COMSUBLANT units:

To: SUBLANT - Michael.N.Cowan@navy.smil.mil
CC: csl.swo@navy.smil.mil (if immediate response is required), ISIC, or operational commander as required.

For COMSUBPAC units:

To: SUBPAC - Jeffrey.George@navy.smil.mil
CC: swo.csp@navy.smil.mil (if immediate response is required), ISIC, or operational commander as required.

Units should request analysis and recommendations for corrective action from NSWC. The response will be provided by message within 72 hours of receipt of the data package. If the package needs to be expedited, contact TYCOM Noise Reduction Officer prior to submission.

- e. Platform noise hydrophone recordings are classified **CONFIDENTIAL** in accordance with reference (c), (Encl 55). If recordings include towed array signature data, then the classification is **SECRET**.
3. Frequency. Surveys will be conducted as specified within this instruction, reference (a) and applicable MRCs. Additional surveys will be conducted as required to support noise reduction efforts related to other shipboard surveys or whenever such monitoring is required for the identification of noise degradations or to verify the effectiveness of corrective actions.
4. Record. Survey results will consist of platform noise spectra, cavitation data, and entries to the ESL and Sonar Line Log. Records will be kept as specified within this instruction, in reference (a) or as required to meet the needs of noise reduction efforts aboard ship.
5. Review. The Sonar Officer will review results of all surveys weekly and the Noise Reduction Officer will review all records in conjunction with Noise Reduction Board meetings monthly.

Enclosure (2a)

PROPELLER CAVITATION NOISE SURVEY

- Reference: (a) Class Applicable Technical Manual for Platform Noise Monitoring Analysis for Noise Reduction
(b) NTTP 3-54.1 Submarine Tactical Security Manual

1. Responsibility. Sonar Officer.
2. Procedure. Propeller cavitation surveys and diagnostic procedures will be conducted as specified in reference (a). Propeller cavitation curves will be developed using the procedural guidance of reference (a), for the various tactical considerations specified in reference (b).
3. Frequency. Since the ship's operating schedule dictates the frequency at which propeller cavitation surveys can be made, no specific frequency can be assigned. However, a complete cavitation survey should be made after any CNO Maintenance Availability or upkeep period. One point of the current cavitation curve should be verified at the beginning of each underway period. If results are significantly different, a complete new curve should be developed.
4. Unacceptable Propeller Tip Cavitation Performance. Propeller replacement due to poor acoustic performance is often based on unacceptable tip cavitation. Naval Surface Warfare Center, Carderock Division (NSWCCD) personnel verify the ship recorded cavitation points and provide feedback to the TYCOM and the ship. Ships with emergent poor cavitation performance should immediately record and forward cavitation curve tapes in accordance with the Platform Noise Survey Section of this Appendix.
5. Reports. The original and the five most recent cavitation curves will be retained and compared for trend analysis until the propeller is changed.
6. Review. The Sonar Officer shall compare new cavitation curves to previous ones and forward the results to the Commanding Officer via the Noise Reduction Officer.

Enclosure (2b)

(This Page Intentionally Left Blank)

TOPSIDE SURVEY

Reference: (a) MIP SO-591/901 MRC BNJ6 (R-1)

1. Responsibility. Noise Reduction Officer.
2. Procedure. The First Lieutenant shall ensure that the following items are accomplished in accordance with reference (a):
 - a. Open and inspect all line lockers and free flood areas for loose gear and other sources of noise, such as loose zincs, rattling pipes, loose grates, etc.
 - b. Check all deck hatches to ensure they shut properly and will not rattle.
 - c. Check that all towed array fairing plates are properly secured (if applicable).
 - d. Check all cleats for proper operation and ensure that they do not rattle when stowed.
 - e. Check stowage of all portable equipment topside to ensure that proper gasket material is installed, all bolts and wing nuts are present, and equipment is securely held in place when mounted.
 - f. When required, inspect sail area for loose gear and sources of rattles. Particular attention should be given to the mast bearings and operating equipment to ensure that masts will not be damaged or fouled. Before reinstalling sail plates, the sail should be inspected by the Noise Reduction Officer.
3. Frequency. A complete Topside Survey, including the sail, shall be conducted after any major upkeep or inport period, or whenever major topside work is completed. A sail closeout inspection shall be conducted by an officer prior to the reinstallation of any sail plate removed. Surveys should be completed as far in advance of underway as possible. Other inspections shall be conducted as directed by the First Lieutenant.
4. Reports. A written report in memorandum form shall be submitted to the Commanding Officer at the completion of each inspection. This report shall include, as a minimum, the date the inspection was made, names of personnel conducting the inspection and uncorrected discrepancies noted in the ESL. Reports shall be routed via the Noise Reduction Officer, with copies to cognizant Department Heads.
5. Review. A written report in memorandum form will be submitted for each inspection and will include, as a minimum, the date of the inspection, names of personnel conducting the inspection and the discrepancies noted in the Equipment Status Log. This report shall be reviewed by the First Lieutenant and retained by the Noise Reduction Officer until all discrepancies are corrected.

Enclosure (2c)

(This Page Intentionally Left Blank)

HOUSEKEEPING SURVEY

Reference: (a) MIP SO-591/901 MRC BNJ7 (R-2)

1. Responsibility. Noise Reduction Officer.
2. Procedure. It is the responsibility of the NRPO to inspect their division's spaces in accordance with reference (a) for sound shorts or other silencing discrepancies which may result from improper stowage of loose gear.
3. Frequency. Improper stowage is a continuous problem and should be monitored as such. It is the responsibility of all hands to monitor the stowage of all gear and to ensure that sound shorts are not created by improper stowage. OODs, Engineering Officers Of the Watch and all watchstanders are required by other instructions to inspect various spaces. These inspections should include monitoring for proper stowage and possible sound shorts. Prior to getting underway, all divisions must inspect their spaces for proper stowage at sea. Division Officers should acknowledge by signature on respective pre-underway check sheets that their spaces are stowed for sea.
4. Reports. Potential sound short discrepancies will be reported to the OOD who will inform the Commanding Officer and responsible Department Heads, to ensure that problems are corrected. Discrepancies not immediately corrected shall be noted in the ESL.
5. Review. The Noise Reduction Officer shall review all pre-underway check sheets and maintain a record of all noise discrepancy items until corrected.

Enclosure (2d)

(This Page Intentionally Left Blank)

MACHINERY AND HULL VIBRATION SURVEY

- Reference: (a) Class Applicable Technical Manual for Machinery and Hull Vibration Testing and Monitoring of SSN/SSBN/SSGN Auxiliary Machinery
(b) MIP 4910/Series Vibration Noise Monitoring
1. **Responsibility.** Electrical Officer.
 2. **Procedure.** Machinery and hull vibration surveys shall be conducted as specified in reference (a) and in accordance with applicable PMS (reference (b)). Items found to be out-of-specification will be logged in the ESL as potential noise deficiencies. Machinery and hull vibration surveys are conducted on all submarines.
 3. **Frequency.** A comprehensive machinery and hull vibration survey should be conducted quarterly by Ship's Force. Results are submitted to PMT, who in turn forwards the packages to the applicable NSWC Detachment. Specific machinery and hull vibration monitoring surveys shall be conducted by Ship's Force bi-weekly on selected equipment identified in the NSWC, machinery Vibration Deficiency Message and as required to support onboard noise reduction efforts.
 4. **Reports.**
 - a. NSWC evaluates and maintains machinery and hull vibration data collected by Ship's Force. They report out-of-specification equipment or hull vibration levels via message.
 - b. During each machinery and hull vibration survey, a report is submitted to NSWC via the local PMT. This report shall include the sound cut data and a feedback package.
 - c. For the Hull Vibration Monitoring Program, a message should be sent from the submarine to NSWC within 45 days of receipt of the NSWC hull vibration deficiency message or when operationally feasible. This message should include the results of actions taken to identify and correct the sources of excessive hull vibration levels and to identify platform noise sources.
 5. **Noise Reduction Training.** Crew training in noise awareness and noise reduction is absolutely essential to maintaining a quiet ship. The Submarine Force Training Manual discusses formal training courses and requirements pertaining to noise reduction as well as materials available for onboard training.
 6. **Review.** The Electrical Officer shall review and forward the results of all machinery and hull vibration measurements to the Commanding Officer via the Noise Reduction Officer and Executive Officer. This report shall be submitted within five working days of the survey and shall include a listing of which noise measurements have been taken and any out-of-specification equipment.

Enclosure (2e)

(This Page Intentionally Left Blank)

ISOLATION SYSTEM SURVEY

- Reference: (a) NAVSEA S9073-AW-SNC-010/(U) Ship Acoustical Surveys
(b) NAVSEA S9073-AF-SNC-010/(C), Ship Noise Control
(c) Appropriate Noise Control Guidelines, Road Maps, and Equipment Guide Lists
(d) Appropriate System MIPs

1. Responsibility. Noise Reduction Officer.
2. Procedure. The Noise Reduction Officer shall require Ship's Force to conduct a visual inspection of silencing equipment and components such as resilient mounts, flexible pipe, pipe hangers, ground straps, electrical connections, etc., to ensure they are properly installed, within periodicity, undamaged and not sound shorted. References (a), (b), (c) and (d) apply. When funded, these inspections will be conducted by a NAVSEA designated activity, however, the ship is still responsible for conducting the survey regardless of NAVSEA funding.
3. Frequency. An Isolation System Survey shall be conducted as specified by reference (d) in accordance with reference (a). Additionally, a localized isolation system survey shall be conducted in the area of sound isolated equipment changeouts and in the area of work accomplished on sound isolated systems. When requested and funded, a NAVSEA designated activity shall provide training and assist in the performance of an isolation system survey.
4. Reports. The Noise Reduction Officer shall ensure that all defects found are logged in the ESL and shall report survey results to the Commanding Officer within five working days of completion of the inspection.
5. Review. The Noise Reduction Officer shall maintain a record of all discrepancies noted until corrected.

Enclosure (2f)

(This Page Intentionally Left Blank)

DAMPING MATERIAL SURVEY

Reference: (a) NAVSEA S9073-AW-SNC-010/(U), Ship Acoustical Surveys
(b) NAVSEA S9073-AF-SNC-010/(C), Ship Noise Control

1. Responsibility. Sonar Officer.
2. Procedure. The Sonar Officer shall ensure that a thorough inspection is conducted of all damping material installed in sonar array areas, fairwater, main ballast tanks, and free flood areas, to ensure that no deterioration has taken place in accordance with the guidance provided in reference (a). Reference (b) provides specific information relating to these materials.
3. Frequency. A Damping Material survey shall be conducted as specified at each dry-docking, in accordance with reference (a).
4. Reports. A written report in memorandum form shall be submitted for each inspection and shall include, as a minimum, the date of inspection, names of personnel conducting the inspection, and the discrepancies noted in the ESL.
5. Review. The Sonar Officer shall review the results of each inspection and forward them to the Commanding Officer via the Noise Reduction Officer within five working days of the completion of the inspection. This report shall be retained by the Noise Reduction Officer until all discrepancies have been corrected.

Enclosure (2g)

(This Page Intentionally Left Blank)

SOUND ABSORPTION MATERIAL SURVEY

Reference: (a) NAVSEA S9073-AW-SNC-010/(U), Ship Acoustical Surveys
(b) NAVSEA S9073-AF-SNC-010/(C), Ship Noise Control

1. Responsibility. First Lieutenant.
2. Procedure. The First Lieutenant will ensure that a thorough inspection of the interior sound absorption and sound transmission loss material is conducted in all spaces. This inspection ensures that no deterioration of these materials has taken place. This inspection is accomplished with guidance from reference (a), while reference (b) provides specific information relating to these materials.
3. Frequency. A Sound Absorption Material Survey shall be conducted prior to each major CNO Maintenance Availability. An inspection of any system affected by maintenance or other work shall be conducted following completion of the work.
4. Reports. A written report in memorandum form will be submitted to the Noise Reduction Officer for each inspection and will include, as a minimum, the date of the inspection, names of personnel conducting the inspection, and discrepancies noted in the ESL.
5. Review. The First Lieutenant will review the results of each inspection and forward them to the Commanding Officer via the Noise Reduction Officer within five working days of the completion of the inspection. This report will be retained by the Noise Reduction Officer until all discrepancies have been corrected.

Enclosure (2h)

(This Page Intentionally Left Blank)

CONTROL SURFACE NOISE QUESTIONNAIRE

1. The purpose of this questionnaire is to provide more accurate and definitive information than reports of "noise in the fairwater" or "noise in the mud tank". This information can reduce troubleshooting time, prevent unnecessary maintenance, and perhaps prevent an unnecessary and unscheduled dry-docking. It can also furnish vital data to assist in the resolution of a problem and prevent its recurrence. It is very important to monitor the audio during the greasing operations; the effects of greasing for worn bearings can be short.
2. Record audio of all platform noise evaluations in accordance with reference (a).
3. Perform all evaluations in all modes (Normal, Emergency and Automatic where applicable).
4. Note how long greasing effects the noise characteristics of the control surface (minutes, hours, days or months).

Hull Number: _____

Date: _____

Check the appropriate box or fill in the blanks in response to the questions below:

1. Give the date when the noise was first noticed:		
2. Which control surface is suspected of causing the noise?		
a. Fairwater/Bow Planes	Yes ~	No ~
b. Stern Planes	Yes ~	No ~
c. Rudder	Yes ~	No ~
3. Was the noise observed upon leaving port?	Yes ~	No ~
a. If not observed upon leaving port, after how many days at sea?	_____	
4. Was the noise first observed during the first high speed run?	Yes ~	No ~
5. Was any work performed on this system, associated systems, or in its vicinity during the last refit/upkeep period (including welding or sandblasting)?	Yes ~	No ~
a. If yes, describe work _____ _____ _____		
6. How was the noise first detected?		
a. Audible to crew	Yes ~	No ~
b. Self noise monitoring system	Yes ~	No ~
(1) If yes, which system?	_____	
c. Other? (Describe) _____ _____		
7. Is the noise detected on any hydrophones?	Yes ~	No ~
a. If so, which hydrophone displayed the highest levels?	_____	
b. How does this hydrophone level compare to the most recent acoustic trial report or more recent baseline?	_____ _____	

(CONFIDENTIAL when filled in)

Enclosure (3)

8. Is the noise:		
a. Barely audible?	Yes ~	No ~
b. Moderate?	Yes ~	No ~
c. Loud?	Yes ~	No ~
9. Since it was first detected, has the noise level:		
a. Increased?	Yes ~	No ~
b. Decreased?	Yes ~	No ~
c. Remained constant?	Yes ~	No ~
d. Fluctuated?	Yes ~	No ~
10. During cycling of the control surface, is the noise:		
a. Constant?	Yes ~	No ~
b. Intermittent?	Yes ~	No ~
11. If intermittent, has the frequency of the occurrence of the noise:		
a. Increased?	Yes ~	No ~
b. Decreased?	Yes ~	No ~
c. Remained constant?	Yes ~	No ~
12. Describe the type of noise heard.		
a. Clanking?	Yes ~	No ~
b. Thudding?	Yes ~	No ~
c. Groaning?	Yes ~	No ~
d. Rubbing?	Yes ~	No ~
e. Squealing?	Yes ~	No ~
f. Chattering?	Yes ~	No ~
g. Galloping?	Yes ~	No ~
h. Hydraulic flow?	Yes ~	No ~
i. Other? (Describe) _____		
13. When, during the motion of the cycle of the planes is the noise heard (check all that apply):		
a. At start of motion towards rise/right?	Yes ~	No ~
b. At start of motion towards dive/left?	Yes ~	No ~
c. At the end of motion towards rise/right?	Yes ~	No ~
d. At the end of motion towards dive/left?	Yes ~	No ~
e. Entering the rise/right hardstop?	Yes ~	No ~
f. Entering the dive/left hardstop?	Yes ~	No ~
g. Leaving the rise/right hardstop?	Yes ~	No ~
h. Leaving the dive/left hardstop?	Yes ~	No ~
i. The entire length of travel towards rise/right?	Yes ~	No ~
j. The entire length of travel towards dive/left?	Yes ~	No ~

(CONFIDENTIAL when filled in)

Enclosure (3)

k.	At some intermediate point(s) while moving towards rise/right? (Indicate degrees of rise/right when heard):	Yes ~ _____	No ~ _____
l.	At some intermediate point(s) while moving towards dive/left? (Indicate degrees of dive/left when heard):	Yes ~ _____	No ~ _____
14.	Is there any unusual hesitancy or motion during operation of the planes:		
a.	Leaving the rise/right hardstop?	Yes ~	No ~
b.	Leaving the dive/left hardstop?	Yes ~	No ~
c.	At any other point(s) in the motion cycle?	Yes ~	No ~
(1)	If yes, describe giving direction of movement and degrees of rise, dive, left, or right when noise occurs:	_____ _____	
15.	Does ship's speed or depth have any effect on whether or not the noise is generated?	Yes ~	No ~
a.	If yes, describe:		
16.	Does ship's speed or depth have any effect on when the noise is detected during the movement cycle as described in question 13?	Yes ~	No ~
a.	If yes, describe:		
17.	Is the noise audible:		
a.	Surfaced, underway?	Yes ~	No ~
b.	At periscope depth?	Yes ~	No ~
c.	Below periscope depth?	Yes ~	No ~
18.	Does sea state affect the degree of noise?	Yes ~	No ~
19.	Does simultaneous operation of the stern planes and rudder cause or increase the degree of noise?	Yes ~	No ~
20.	Are any of the following components very warm to the touch while operating the control surface suspected of causing the noise?		
a.	Hydraulic tail rod (if installed)?	Yes ~	No ~
b.	Hydraulic piston rod?	Yes ~	No ~
c.	Through hull connecting rod?	Yes ~	No ~
21.	On the control surface suspected of causing the noise, perform the appropriate quarterly greasing MRC for the components listed in question 22, below. Operate the control surface while greasing (except the guide cylinder). Listen to determine if greasing causes any change in the occurrence or loudness of the noise.	Greasing Performed?	
		Yes ~	No ~
22.	Did the noise diminish after greasing the following components?		
	Fairwater/Bow Planes:		
a.	Hull gland:	Yes ~	No ~
b.	Lower end of connecting rod: see Note 1	Yes ~	No ~

(CONFIDENTIAL when filled in)

Enclosure (3)

c.	Upper end of connecting rod: see Note 1	Yes ~	No ~
d.	Port stock bearing:	Yes ~	No ~
e.	Starboard stock bearing:	Yes ~	No ~
Stern Planes:			
f.	Hull gland:	Yes ~	No ~
g.	Forward end of connecting rod: see Note 1	Yes ~	No ~
h.	Aft end of connecting rod: see Note 1	Yes ~	No ~
i.	Port stock bearing: see Note 2	Yes ~	No ~
j.	Starboard stock bearing: see Note 2	Yes ~	No ~
k.	Port pintle bearing:	Yes ~	No ~
l.	Starboard pintle bearing:	Yes ~	No ~
Rudder:			
m.	Hull gland:	Yes ~	No ~
n.	Forward end of connecting rod: see Note 1	Yes ~	No ~
o.	Aft end of connecting rod: see Note 1	Yes ~	No ~
p.	Port stock bearing: see Note 2	Yes ~	No ~
q.	Starboard stock bearing: see Note 2	Yes ~	No ~
r.	Upper rudder stock bearing: see Note 2	Yes ~	No ~
s.	Lower rudder stock bearing: see Note 2	Yes ~	No ~
t.	Rudder carrier bearing (two fittings): see Note 2	Yes ~	No ~
23.	Pump one pound of grease into the guide cylinder grease fitting while the control surface is in the neutral position. Then operate the control surface about five cycles from full rise to full dive or left to right, as appropriate, while listening for the noise. Repeat this procedure for the guide cylinder until the specified amount of grease has been applied.	Yes ~	No ~
		Greasing Performed?	
		Yes ~	No ~

(CONFIDENTIAL when filled in)

Enclosure (3)

Note 1: Grease underway if the appropriate alteration is installed to permit remote greasing of the stern planes and rudder connecting rods. The fairwater/bow planes connecting rod may be greased locally while underway on the surface even if remote greasing alteration is not installed.

Note 2: If the stern planes are suspected of causing the noise and the noise did not diminish after greasing the stern plane components, grease the rudder components. If the greasing did not help a suspected noisy rudder, grease the stern planes.

Deliver this questionnaire to:

For COMSUBLANT units:

Carderock Division
Naval Surface Warfare Center
9500 MacArthur Blvd.
West Bethesda, MD 20817-5700
Attn: Code 711 - Fleet Support Program Manager
For: New London Units, data packages should be
forwarded to:
NSSC NEW LONDON CT, N42

For COMSUBPAC units:

Naval Surface Warfare Center
Carderock Division
Bremerton Detachment
530 Farragut Ave
Attn: Code 713
Bremerton, Washington 98314-5215

The NSWC will provide appropriate distribution to NAVSEA PMS 350, SEA 07T, PMS 392, TYCOM, and ISIC.

(CONFIDENTIAL when filled in)

Enclosure (3)

(This Page Intentionally Left Blank)

APPENDIX D
PREDEPLOYMENT NOISE INSPECTION

1. Purpose. To provide requirements for Predeployment Noise Inspections.
2. Policy. This Appendix establishes the requirements for the Under Hull Sound Silencing Survey of all submarines.
3. Under Hull Sound Silencing Surveys. Under Hull Sound Silencing Surveys of submarines (using reference (g)) will be done at the following times:
 - a. Prior to the ship leaving dry-dock.
 - b. Waterborne Under Hull Inspection during the first week of a scheduled upkeep, normally accomplished by the inspecting facilities divers.
 - c. Waterborne Under Hull Inspection prior to deployments of 30 days or greater, normally accomplished by the inspecting facilities divers.
4. Reports. The Senior Hull Inspector of the inspecting facility will conduct an inspection critique for the ship's Noise Reduction Officer and ISIC Material Officer. Copies of the final survey report (a format is provided on the following page) or reference (g) data sheets will be supplied by the inspecting facility to the submarine and cognizant ISIC Material Officer.

SOUND SILENCING SURVEY REPORT

1. Inspection performed by:

Senior Inspector: _____

Inspector #1 _____

Inspector #2 _____

Inspector #3 _____

Inspector #4 _____

2. The following deficiencies were noted:

3. Submitted by:

Senior Inspector

APPENDIX E
SUBMARINE SILENCING PUBLICATIONS

X-Applicability

PUBLICATION Note 1	688	726	21	774	AS
<u>PLATFORM NOISE</u>					
S9073-A4-SNC-010/(C) USS LOS ANGELES (SSN 688) Class Acoustic Stealth Manual	X				X
NSWCCD-71-TR-2001/020 February 2001 USS SEAWOLF (SSN 21) Class Acoustic Stealth Manual			X		
S9073-AS-PNM-010/(C) Platform Noise Monitoring Analysis for Noise Reduction					X
S9073-AT-PNM-010/(C) Platform Noise Monitoring Analysis for Noise Reduction		X			X
NAVSEA SE 394-NO-MMA-030/(C) AN/BSQ-7 Platform Noise Manual					X
(TBD) Platform Noise Monitoring Analysis for Noise Reduction			X(4)	X(4)	
<u>MACHINERY AND HULL VIBRATION</u>					
S9073-AL-SBV-010/(C) Structureborne Noise Criteria for Auxiliary Machinery (U) Operation and Maintenance Instructions		X	X(4)	X(4)	X
S9073-AM-SBV-010/(U) Structureborne Noise Acceptance Tests and Monitoring Program for Submarine Auxiliary Machinery (U) Volume I, Procedure (U)	X		X(4)	X(4)	X
S9073-AM-SBV-020/(C) Structureborne Noise Acceptance Tests and Monitoring Program for Submarine Auxiliary Machinery (U) Volume II, Criteria	X		X(4)	X(4)	X
<u>SUBMARINE SONAR DOMES</u>					
S9165-AC-HBK-010/(U) Submarine Sonar Dome Handbook; Description and Maintenance	X	X	X(4)	X(4)	X
SE300-AY-MMA-010/(U) TRIDENT Glass Reinforced Plastic Bow Sonar Dome		X			X
SE300-AZ-MMA-010 Description, Operation and Maintenance SSN21 Class Sonar Bow Dome			X		
SE300-MA-MMA-011 Glass Reinforced Plastic (GRP) Bow Sonar Dome	X				
<u>MISCELLANEOUS NAVSEA NOISE REDUCTION MANUALS</u>					
S6360-AD-HBK-010 Special Hull Treatment, Maintenance and Repair for Submarines	X	X	X(4)	X(4)	X
S9311-AM-MME-010/(U) Microbalancing of Ship Service Turbine Generator Sets on SSN/SSBN Submarines	X	X	X(4)	X(4)	X

X-Applicability

PUBLICATION Note 1	688	726	21	774	AS
S9561-AQ-MMA-010/(U) Low Noise Electrohydraulic Flow Control Servo Valve Model SV-438-10P; Service Instructions					X
S9073-AW-SNC-010/(U) Ship Acoustical Surveys for Submarines		X	X	X	X
S9073-AF-SNC-010/(C) Ship Noise Control	X	X	X(4)	X(4)	X
S9SSB-X9-SSM-09A/(U) SSBN 726 Class Ship System Manual, Volume II, Part IV, Monitoring Subsystem Note 2		X			X
0900-LP-060-2010(U) Electrical Machinery Repair Manual, Volume I, Electric Motor Repairs (Rev 2)					X
0900-LP-060-2020(U) Electrical Machinery Repair Manual, Volume II, Vibration Analysis and Rotor Balance					X
S0600-AA-PRO-230(U) Underwater Ship Husbandry Manual, Chapter 23, Submarine Pre-Deployment Noise Inspection	X	X	X(4)	X(4)	X
<u>MIPs FOR NOISE MONITORING</u>					
Platform Noise Monitoring MIP SO-544/902	X	SSGN Only	X	X	
TRIDENT Monitoring Subsystem 4190/911 (contains platform monitoring)		X			
Topside and Housekeeping Surveys, reference (g)	X	X	X(4)	X(4)	
Isolation System Survey, Appropriate System MIPs					
Topside and Housekeeping Surveys MIP SO-591/901-A0			X	X	
Airborne Noise Survey, MIP SO-594/001	X	X	X(4)	X(4)	
Vibration Noise Monitoring MIP 4910/Series, See Note 3 (Machinery and Hull)	X	X	X(4)	X(4)	
<u>NOISE CONTROL GUIDELINES</u>					
0900-LP-093-9010/(C) Noise Control Guide for SSBN 640 Class					X
Specifically Applicable Noise Road Maps (Selected Record Drawings)	X	X	X	X	X
<u>TRIAL REPORTS</u>					
NSWCCD or NSWCCD DET BREMERTON: Latest Detection & Detectability Report	X	X	X	X	
NSWCCD or NSWCCD DET BREMERTON: Latest Acoustical Trial Summary Report	X	X	X	X	

X-Applicability

PUBLICATION Note 1	688	726	21	774	AS
LETTERS AND INSTRUCTIONS					
NAVSEAINST C9073.2 (Series) Acoustical Surveys of Submarines (U)	X	X	X	X	X
COMUSFLTFORCOMINST 4790.3; Joint Fleet Maintenance Manual Volume VI, Chapter 23, Submarine Noise Reduction	X	X	X(4)	X(4)	X
NAVSEA SILENCING FILMS					
34547 DN Training Film - Submarine Sound Shorts					X
35350 DN Training Film - Noise Control Guidelines, Running Silent					X
35050 DN Training Film - Shipboard Noise Isolation Devices					X
SAVPIN 803414 DN Sound Silencing Show (Video Tape) - consists of the three films listed above.					X
SVT - ST - 9427 - Submarine Rattles	X	X	X	X	X
SVT - ST - 9429 - Submarine Sound Silencing (SSN 688)	X				X
SVT - ST - 9430 - Submarine Sound Silencing (SSBN 726)		X			X
SVT - ST - (TBD) - Submarine Sound Silencing (SSN 21)			X		X
SVT - ST - (TBD) - Submarine Sound Silencing (SSN 774)				X	X

Note 1: The stocking/ordering point for all publications can be found using Technical Data Information Management System (TDMIS)

Note 2: The ordering point for the item with this Note is Supervisor of Shipbuilding Groton

Note 3: Specific Maintenance Requirements for consideration in this listing are for:

- a. Inspect, clean & replace sound washers.
- b. Record machinery vibration levels.
- c. Record hull vibration levels.

Note 4: Applicable, but may not contain all applicable information until updated for specific class

(This Page Intentionally Left Blank)

APPENDIX F

SAMPLE PROPELLER CHANGEOUT MESSAGE

FM COMSUBRON (AS APPROPRIATE)//
TO COMNAVSEASYS COM WASHINGTON DC//
INFO COMSUBPAC PEARL HARBOR HI//
COMSUBLANT NORFOLK VA//
USS (SHIP'S NAME AND HULL NO.)//
BT
UNCLAS //N09245//
MSGID/GENADMIN/COMSUBRON (AS APPROPRIATE)//
SUBJ/(SUBS) PROPELLER CHANGEOUT//
REF/A/DOC/COMUSFLTFORCOMINST 4790.3//
NARR/REF A IS JOINT FLEET MAINTENANCE MANUAL/VOL VI, CH 23 PROVIDES GUIDANCE FOR
MONITORING PROPELLER VIBRATION DATA AND PROPELLER CHANGE OUT//
RMKS/1. IAW REF A, FOL PROPELLER DATA REPORTED
A. SERIAL NO. OF PROPELLER REMOVED
B. SERIAL NO. OF PROPELLER INSTALLED
C. REASON PROPELLER REPLACED
(POOR PERFORMANCE, EXCESSIVE CAVITATION, GOUGED/NICKED, SINGING SCREW,
ETC.)
2. REQUEST DISPOSITION INSTRUCTIONS FOR REMOVED PROPELLER//
BT
**NOTE: ENSURE MESSAGES ARE IN ACCORDANCE WITH CURRENT MESSAGE FORMAT AND
CURRENT PLAIN LANGUAGE ADDRESS DIRECTORY (PLAD) IS UTILIZED.**

(This Page Intentionally Left Blank)

VOLUME VI

CHAPTER 24

PERIODIC MAINTENANCE REQUIREMENT PROGRAM

REFERENCES.

- (a) NAVSEAINST 4790.8/OPNAVINST 4790.4 - Ships' Maintenance and Material Management (3-M) Manual
- (b) NAVSUP Publication 485 - Afloat Supply Procedures
- (c) OPNAVINST 3120.33 - Submarine Extended Operating Cycle (SEOC) Program

LISTING OF APPENDICES.

- A SUBMEPP Maintenance and Shipwork Planning (MSWP) Periodic Maintenance Schedule - I-Level
- B SUBMEPP Maintenance and Shipwork Planning (MSWP) Inventory of Periodic Maintenance Requirements - I-Level
- C SUBMEPP Maintenance and Shipwork Planning (MSWP) Inventory of Periodic Maintenance Requirements - I/D-Level
- D Submarine Periodic Maintenance Requirement (PMR) Management Process
- E Work Package Supplement - Shipyard Planning and Feedback Report
- F Work Package - Ship's System Work Description, Part 4.13

24.1 PURPOSE. This chapter defines the functions and responsibilities of the submarine Periodic Maintenance Requirements (PMR) Program, and applies to all submarines. Details of PMR documentation are described in Appendix C of reference (a). Unrestricted Operation (URO) PMR guidance is provided in Chapter 25 of this Volume. Hull Integrity Procedure PMR guidance is provided in Chapter 38 of this Volume. Accomplishment of all PMRs is **mandatory**.

- a. The submarine Class Maintenance Plans (CMP) form the basis of a PMR Program which takes the place of the Integrated Maintenance and Modernization Planning Program for these classes and defines the planned, corrective and inactive equipment Maintenance Requirements for all levels of accomplishment.
- b. PMR work requires detailed planning and long lead time material procurement; therefore, all PMR work has been assigned to the Fleet Maintenance Activity (FMA). Ship's Force is not expected to be called upon for PMR work other than the normal responsibilities for establishing plant conditions, authorizing shipboard work, monitoring work in process, interference removal, delivery of ship to shop items, retesting and accepting work. Ship's Force Work Center (WC) will not be assigned as Lead Work Center (LWC) for I-Level PMR work but may be assigned as an assist WC.

24.2 TYPE COMMANDER SCHEDULING SYSTEM. PMR program management has been assigned to Submarine Maintenance Engineering, Planning and Procurement Activity (SUBMEPP) who develops CMPs, Maintenance Requirement Cards (MRC), Maintenance Repair Standards (MRCs, Technical Repair Standards (TRS) and Maintenance Standards (MS)), URO MRCs, and provides PMR configuration and scheduling information to the Submarine Force. Appendices A and B of this chapter show examples of the SUBMEPP PMR Inventories and Schedules provided in support of the Type Commander (TYCOM) PMR Scheduling System. A description of the data elements utilized is provided in each issue of the PMR Inventories and Schedules, which is issued quarterly, or as requested by the Immediate Superior in Command (ISIC). These Inventories and Schedules aid in decisions concerning PMR scheduling and accomplishment during upkeep, provide visibility to problem areas and facilitate auditing and assessing the material condition of a ship.

- a. For Non-SSBN/SSGN 726 Class submarines. The quarterly inventories and schedules include a section of I-Level PMRs coming due within the next xxx months (number of months as requested by ISIC). Additionally, they provide a combined inventory of I and D-Level PMRs shown in Appendix C of this chapter. This inventory identifies the availability for which the D-Level PMRs are planned for accomplishment.
- b. For SSBN/SSGN 726 Class submarines. This inventory provides all I and D-Level requirements, with their due dates.

24.2.1 Periodic Maintenance Requirements Schedule. The PMR Inventories and Schedules are distributed automatically by SUBMEPP to the parent ISIC every three (3) months. Appendix D of this chapter provides a flow chart of the Submarine PMR Management System. In addition, scheduling/configuration files (M79E11) and Master Job Catalog (MJC) update files are distributed to those activities using Micro-PMR for PMR/URO calldown.

24.2.2 Scheduling Periodic Maintenance Requirements Work. The PMR scheduling system is based on calendar periods starting with the month following the completion month of a scheduled Chief of Naval Operations (CNO) Availability, or starting with the month following PMR completion for Fleet availabilities. It is designed to ensure reliable equipment operation during the unit's extended operating cycle. The ISIC, in conjunction with the FMA, will have to smooth the work load by spreading the work over several availabilities by re-planning the scheduled start and completion dates of individual Job Control Numbers (JCN) to ensure they are accomplished prior to the due dates. Once the actual completion dates are reported, subsequent scheduling for the future periods will retain the same relative time frames based on the periodicity of the requirement. The current PMR Inventories and Schedules provided by SUBMEPP shall be maintained by the parent ISIC.

24.2.3 Periodic Maintenance Requirements Calldown/Brokering. I-Level PMRs which are due for accomplishment are called down from Maintenance and Shipwork Planning (M&SWP)/local scheduling system, and brokered by the ISIC. PMRs should be screened to the FMA with a Priority Level of 2.

24.2.4 Calculating Adjusted Last Maintenance Action Date.

- a. Fleet Availabilities. When a PMR is accomplished during a Fleet availability (Fleet Maintenance Activity (FMA)/Refit, Continuous Maintenance Availability, Voyage Repair, Planning), the adjusted Last Maintenance Action (LMA) date will be the first of the month following actual completion.
- b. CNO Availabilities. When a PMR is accomplished during a CNO Availability (Selected Restricted Availability, Interim Drydocking, Extended Refit Period, Depot Modernization Period (DMP), Engineered Refueling Overhaul or a Major Maintenance Period (treated as a CNO availability for scheduling purposes only)), the adjusted LMA date will be the first of the month following the scheduled availability's actual completion date. ISICs operating with the on-site PMR Scheduling System must ensure that Availability Dates are accurately maintained so that completed Automated Work Request (AWR) reported data reflects the adjusted LMA and on-site PMR scheduling records calculate the proper next due date.

24.2.5 Calculating Due Dates. Next Due Dates are calculated based on an Adjusted LMA date. Due dates are calculated, for scheduling purposes, by taking the adjusted LMA date month/year (number) and adding the periodicity months (number) to show the month/year due (i.e., an item with an adjusted LMA date of February 2003 (2/03) with a six month periodicity would be due in August 2003 (8/03). The PMR will be accomplished prior to midnight of the last calendar day of the month due.

24.3 PERIODIC MAINTENANCE REQUIREMENTS ACCOMPLISHMENT. PMR requirements are to be accomplished on or before the scheduled due date listed in the SUBMEPP TYCOM PMR Scheduling System Inventories and Schedules. Accomplishment of all PMRs is **mandatory**. Only by accomplishing PMR maintenance on schedule and in accordance with specifications can safe and reliable operation be ensured and the period between CNO Availabilities be extended. When PMRs cannot be accomplished by their scheduled due date, they will appear overdue on the PMR Status web page. For overdue PMRs, the SUBMEPP representative assigned to each ISIC shall identify on the web page the reasons the PMR could not be accomplished. The purpose of the web page is to provide increased visibility of overdue PMRs to aid the ISIC in their PMR Management responsibilities.

24.4 MATERIAL SUPPORT FOR FLEET MAINTENANCE ACTIVITY ACCOMPLISHED PERIODIC MAINTENANCE REQUIREMENTS.

24.4.1 Mandatory Parts. Parent FMAs requisition mandatory parts as specified on TRS/MRC/MS documentation for PMRs that are scheduled to be accomplished by that FMA. Material requisitioning is accomplished by the FMA using standard supply procedures. Material is not normally stocked by the FMA and is requisitioned from the nearest stocking point.

24.4.2 Contingency Parts. Contingency parts will not be procured in advance for PMR requirements and will be ordered only upon determination that a contingency part is required based on observed equipment condition. Parent FMAs may have some high usage contingency material available in stock, as identified by the Tender Load List supplements, (**not applicable to SSBN/SSGN 726 Class submarines**) however, low usage contingency material is stocked only at designated stock points or not at all.

24.4.3 Requisitioning Procedures. Submarine Engineered Operating Cycle (SEOC) PMR material requisitions shall be submitted through normal channels and shall use a Project Code of "732". Appendix 6 of Reference (b) refers. Contingency material requisitions shall be forwarded by message or telephone, and shall include appropriate "work stoppage" indicator/codes. Forward Contingency Material requisitions directly to, Fleet Industrial Support Center San Diego, Pearl Harbor or Submarine Base New London by message or telephone as appropriate; use the phrase "SEOC Requisition" as the subject line on message requisitions.

24.4.4 Material Support Provided by the Advance Equipment Repair Program. Shore based spares are available for replacing some critical equipment, such as seawater system pumps and motors, during CNO Maintenance Availabilities. The Advanced Equipment Repair Program (AERP) is managed by SUBMEPP under the direction of Naval Sea Systems Command (NAVSEA) and both TYCOMs. AERP equipment scheduled for change-out will be specifically authorized in the ship's Availability Work Package (AWP). Although originally intended to support CNO Availabilities, AERP assets, when available, are used to support Casualty Reports (CASREP). In these instances, a CASREP requisition must be submitted to Naval Inventory Control Point and the shipment of equipment is monitored and tracked until the condition "F" off-load has been returned to the refurbishment activity/vendor identified by Naval Inventory Control Point. The expedited return of an AERP off-load is essential to ensure adequate restoration turnaround time is afforded and to minimize AERP impact.

24.4.5 Material Support Provided by the TRIDENT Planned Equipment Replacement Program.

- a. TRIDENT Planned Equipment Replacement (TRIPER) is a rotatable pool program for SSBN/SSGN 726 Class submarines. TRIPER equipment is removed from the ship via pre-planned access routes and six-foot diameter Logistics and Escape Trunks, using specifically designed handling attachments and procedures. Removed equipment is replaced with fully interchangeable, tested, ready for issue units which can be rapidly installed and made fully operational within a refit period. Equipment replacement periodicity is determined by maintenance and reliability analysis and engineering judgments intended to preclude equipment failure or significant degradation during operational periods. Removed equipment is refurbished by approved Designated Overhaul Points, tested and returned to ready for issue condition for use on another SSBN/SSGN 726 Class submarine.
- b. Safety spares are made available for CASREPs which are considered as unplanned change outs. The TRIPER Program rotatable pool is managed by NAVSEA (PMS 392) and supported by various agencies and activities. Hull, Mechanical, Electrical, Ordnance and Electronics and Command and Control System equipment comprise the TRIPER inventory pool. Items under the cognizance of the Director, Strategic Systems Project Office and the Deputy Commander, NAVSEA Nuclear Power Directorate are excluded.

24.5 CORRECTIVE MAINTENANCE OF EQUIPMENT USING PERIODIC MAINTENANCE REQUIREMENTS.

Scheduled restoration of equipment by the FMA or industrial activity is done in accordance with specified Maintenance Standards (MRC, MS, TRS, Technical Manual, etc.). Whenever corrective maintenance is required on Hull, Mechanical and Electrical equipment, the SUBMEPP combined I and D-Level PMR inventory shall be reviewed by the ISIC and FMA. The ISIC and FMA will determine whether to limit repairs to those described by the ship or to have the Maintenance Standard accomplished. If the corrective maintenance is to include the criteria of the MRC, MS or TRS, the work request shall be processed in accordance with paragraph 24.7.3 and 24.7.4 of this chapter.

NOTE: IN ORDER TO RECEIVE ACCOMPLISHMENT CREDIT, THE ISIC SHALL ENSURE PROMPT COMPLETION REPORTING OF THE PMR AS DESCRIBED ABOVE. THIS WILL ENSURE THE CORRECT SCHEDULING OF PMRs FOR FUTURE ACCOMPLISHMENT.

NOTE: EQUIPMENT IS CONSIDERED TO HAVE BEEN RESTORED IN ACCORDANCE WITH PMR CRITERIA WHEN THE FOLLOWING SOFTWARE (MRC, MS, TRS) REQUIREMENTS HAVE BEEN SATISFIED.

- (1) THE EQUIPMENT IS RESTORED TO PLAN SPECIFICATIONS.**
- (2) THE COMPONENTS SATISFACTORILY PASS THE TEST REQUIREMENTS WITHIN THE MRC/MS/TRS.**
- (3) ALL MATERIAL LISTED ON THE MRC/MS/TRS AS MANDATORY HAS BEEN REPLACED.**
- (4) COMPONENTS AND EQUIPMENT ARE REPLACED WITH SUPPLY SYSTEM, AERP, OR TRIPER ASSETS.**

24.6 PERIODIC MAINTENANCE REQUIREMENTS ACCOMPLISHMENT DURING CHIEF OF NAVAL OPERATIONS MAINTENANCE AVAILABILITIES. PMRs to be accomplished by the industrial activity will be included in the SUBMEPP PMR Inventories and Schedules.

a. For SSN 688, SSN 774 and SSN 21 Class submarines:

- (1) The AWP prepared by SUBMEPP will reflect all PMRs authorized for shipyard accomplishment during the CNO Availability period at the AWP Ship Work List Item Number (SWLIN) level. The Work Package Supplement (WPS) accompanying the AWP will identify a specific PMR to the applicable AWP SWLIN paragraph. Appendix E of this chapter provides an example of the WPS format. In addition, the DMP and overhaul AWP's will contain an I-Level PMR work package cross-index. This cross-index will enable maintenance planners to readily determine the I-Level PMRs accomplished incidental to accomplishing higher D-Level PMRs or other industrial activity authorized work. The cross-index will also identify I-Level PMRs which will become overdue by availability completion plus six months. These I-Level PMRs should only be listed in the cross index as a reference and not listed in the body of the AWP. Appendix F of this chapter provides an example of the cross-index format. This ISIC will report any I-Level PMRs from the cross-index that will not be completed prior to the arrival conference for adjudication.
- (2) Upon receipt of Issue Two of a 6 month or greater scheduled CNO availability AWP the ISIC will review the AWP against the schedules and inventories and add those PMRs not covered by the Work Package (WP) coming due within 6 months after availability completion that aren't assigned to shipyard to a fleet maintenance availability prior to the CNO period, to a concurrent availability, or to a future availability with TYCOM concurrence.
- (3) For I-Level PMRs assigned to the depot, or I-Level PMRs covered by higher level maintenance assigned to the depot, the ISIC will enter "Assigned to <depot name> by AWP <AWP number>" in the Remarks/Completion block of the PMR Schedule/Inventory, Part 2 Section III and in the local scheduling system.
- (4) Completions and MCA data for PMRs accomplished by the industrial activity during CNO Availabilities will be retrieved from the appropriate maintenance database. The WPS, or comparable report, annotated by SUBMEPP to show PMR completions and material condition feedback categories, will be retained by SUBMEPP upon completion of the availability. The PMR Schedule/Inventory and local scheduling system will be updated by SUBMEPP.

b. For SSBN/SSGN 726 Class submarines:

- (1) The Engineered Overhaul Work Package prepared by SUBMEPP will reflect all PMRs authorized for accomplishment during the CNO Maintenance Availability period at the SWLIN level. For each SWLIN, the specific PMRs will be identified to the applicable component level. The Engineered Overhaul Work Package preparation process ensures all PMRs due prior to the first availability following the subject availability period are included in the Engineered Overhaul Work Package. The preparation process also includes review and inclusion of appropriate items from the ship's Current Ship's Maintenance Project (CSMP), Ship's Force originated deficiencies, and alterations screened for industrial activity accomplishment.
- (2) Completions and Material Condition Assessment data for PMRs accomplished by the industrial activity during CNO Availabilities will be retrieved from the appropriate maintenance database. The WPS, or comparable report, annotated by SUBMEPP to show PMR completions and material condition feedback will be retained by SUBMEPP upon completion of the availability. The PMR inventories and schedules and local scheduling system will be updated by SUBMEPP.
- (3) Completions and MCA data for PMRs accomplished by TRIDENT Refit Facility Kings Bay/NAVIMFAC PACNORWEST during CNO availabilities will be called down and reported using their local scheduling system as identified in paragraph 24.2.3 of this chapter.

24.6.1 Operating Cycle/Interval Extension. An audit plan to assess the material condition of a ship prior to extending their operating cycles/intervals beyond PMR periodicity due to changing CNO Maintenance Availability dates is addressed in reference (c). Procedures and responsibilities are contained in Volume II, Part I, Chapter 3 of this manual.

24.7 RESPONSIBILITIES.

24.7.1 Type Commander.

- a. The TYCOM is responsible for providing an overall scheduling system for the accomplishment of PMRs for assigned ships.
- b. Perform periodic audits of ISICs and FMAs to verify full compliance with the provisions of this chapter.
- c. Provide guidance to the ISICs, obtaining NAVSEA concurrence in accordance with Volume V, Chapter 8, paragraph 8.2.4 of this manual.

24.7.2 Submarine Maintenance Engineering, Planning and Procurement Activity.

- a. Receive reports of the completion of PMRs from industrial activities and extract Maintenance and Material Management (3-M) data from NAVSEA Logistics Center, Mechanicsburg PA of all Forces Afloat accomplished PMRs containing "JC" WC.
- b. Review completion reports for any change in material condition status and analyze 3-M data for Material Condition Assessment to determine validity of requirements.
- c. Update schedules to reflect new LMA and next due dates.
- d. Provide updated quarterly PMR inventories and schedules to each ISIC and the SUBMEPP representative at TYCOM. Notify the SUBMEPP Representative at TYCOM and each ISIC when products will not be provided as scheduled.
- e. Provide quarterly or more frequent (if requested) scheduling/configuration files (M79E11) and MJC update files to each parent ISIC using a local scheduling system.
- f. Provide quarterly MJC update files to the ISIC brokering systems .
- g. Adjust the due dates for any PMRs that are accomplished within ten months of the major CNO availability start date that will come due again during the availability by the number of months of the availability duration.

- h. (SSBN/SSGN 726 Class submarines) Provide Refit Work Package electronic files which reflect PMR scheduling to the TRIDENT Refit Facility Kings Bay at the arrival minus 60 day milestone.
- i. Prepare and issue AWP in support of CNO availabilities. Ensure the I-Level PMR section of AWP (Part 4.13) is updated on each issue of the AWP.
- j. Manage AERP/Corporate Component Repair Program/TRIPER programs.
- k. Extract PMR completion verification and documentation for SEOC availabilities from the appropriate maintenance database.
- l. Update Overdue PMR Status web page (https://ebiz.submepp.navy.mil/fs/pmr_status/) with the reason for D-Level PMRs not meeting the due date.

24.7.3 Immediate Superior In Command.

- a. Although the responsibility for the accomplishment of PMRs must rest with the ship's Commanding Officer, the ISIC is responsible for scheduling and ensuring completion of all I-Level PMR work within the planned periodicity in the CMP. Normally, PMR work is accomplished by the FMA which maintains the unit's CSMP. However, when submarines are assigned availabilities to other than the parent FMA, and that FMA is authorized by the TYCOM to perform PMRs, an agreement between the parent ISIC and the accomplishing FMA will identify the PMRs to be accomplished and any associated logistics.
- b. Calldown all I-Level PMRs planned for accomplishment into the CSMP by availability dates. For SSBN/SSGN 726 Class submarines this shall be 45 days prior to refit start. For non-726 Class submarines, 60 days prior to fleet maintenance availability. This ISIC must be proficient in these procedures to preclude erroneous or duplicate data from entering the CSMP. If the inventories and schedules contain errors/omissions, report the discrepancies to SUBMEPP.
- c. Maintain auditable records of PMR accomplishment for each submarine. These records will include the current SUBMEPP Quarterly PMR Inventories and Schedules and the last completed AWR for PMRs completed by the parent FMA, whether or not reflected in the SUBMEPP Quarterly PMR Inventories and Schedules. At sites which have access to electronic certified Task Group Instructions, these Task Group Instructions can be used in place of completed AWRs as an auditable record of PMR accomplishment.
- d. At Naval Intermediate Maintenance Facility Pacific Northwest, PMR and non-controlled URO inspection scheduling, completion, LMA date establishment and next due date scheduling shall be maintained in the appropriate automated database for SSBN/SSGN 726 Class submarines. This database will contain the complete history for all occurrences (past), dates of completion, frequency of occurrence, next due dates and future scheduling data for each PMR/non-controlled URO inspection. Data will be entered from Objective Quality Evidence from refit close out processes and the selected job management report.
- e. Notify SUBMEPP Code 1814 of non-receipt of SUBMEPP Quarterly PMR Inventories and Schedules. The PMR Inventories and Schedules are also available at <https://ebusiness.submepp.navy.mil/ap/invsched/>.
- f. Keep the local scheduling system correct and accurate. This should be done by periodically doing a check of the data against the inventories and schedules, M&SWP and the ship's CSMP. Ensure the SUBMEPP representative assigned to each ISIC updates the Overdue PMR Status web page (https://ebiz.submepp.navy.mil/fs/pmr_status/) with the reason for I-Level PMRs not meeting the due date.
- g. The ISIC should make every attempt to accomplish PMRs on or before the next scheduled due date that appears in SUBMEPP Inventories and Schedules. Ensure PMRs which are not accomplished by the SUBMEPP scheduled due date are rescheduled.

- h. Ensure that all I-Level PMRs, which will become due during a scheduled CNO Availability (but not authorized for industrial activity accomplishment), are scheduled for accomplishment by the FMA prior to the end of the availability. The PMRs may be assigned to an FMA concurrent availability with an end date the same as the CNO availability. This will allow for a more appropriate Adjusted LMA Date.
- (1) Any I-Level PMR that is overdue by the availability start date minus 6 months and is identified in the AWP/WPS by SUBMEPP to be accomplished by the industrial activity does not have to be done prior to the availability start. This includes I-Level PMRs for which the higher tier D-Level PMR is authorized in the AWP/WPs.
 - (2) Notify the TYCOM representative at the Pre-Arrival Conference of any I-Level PMRs that will either not be accomplished prior to the availability start date or will become due during the availability.
 - (3) Any PMR accomplished within ten months prior to start of a major CNO Availability that becomes due again during the availability, will have their scheduled due date adjusted by SUBMEPP by the number of months of the availability duration.
- i. Review completed AWRs or electronic certified Task Group Instructions prior to close-out of PMRs to resolve any discrepancies.
- j. Transferring Periodic Maintenance Requirements to other Fleet Maintenance Activities for Accomplishment. When submarine availabilities are accomplished by other than the parent FMA (whether another FMA in the same geographic area or due to deployment), the parent ISIC will take the following action:
- (1) Coordinate with the parent FMA to select only those PMRs for accomplishment for which all plans and materials will be available and ready for shipment prior to the availability or deployment of the submarine.
 - (2) Dispatch a message to the submarine, the recipient squadron and FMA identifying by JCN the PMRs to be accomplished, confirming that plans and materials are being shipped or will be carried by the deploying submarine and that the submarine's total CSMP tape will be either retained by the parent ISIC or transferred to the recipient squadron/Regional Support Group/Regional Maintenance Center as mutually agreed prior to the availability or deployment.
 - (a) If the CSMP is retained by the parent ISIC, an AWP tape (MM6031) will be provided to the recipient FMA which will maintain it as I-Level (only AWR completions for the tended submarine accomplished by the FMA will be passed upline). The submarine will forward all 3-M transactions to the parent ISIC.
 - (b) If the total CSMP is transferred, the recipient FMA will maintain it as level II (the submarine will pass all 3-M transactions to the availability FMA). In addition, the PMR configuration and scheduling file will be transferred to the recipient FMA for URO/PMR/Calibration scheduling purposes.
 - (c) When the submarine departs from the tending FMA, the CSMP and PMR data files will be updated and returned to the parent ISIC with the letter of transfer. FMAs receiving only the work package tape will create a CSMP transfer out tape and transmittal letter for return to the parent ISIC. The parent ISIC Maintenance Document Control Officer (MDCO) will reconcile the master CSMP with the returning submarine's 3-M coordinator.
 - (3) Ensure that the FMA properly packages by JCN all materials, plans, drawings, etc., for dispatch to the receiving FMA or for custodial turnover to the submarine's Engineer Officer for delivery to the deployed FMA.
 - (4) Ensure MDCO/Analysis, Records and Reports Section (ARRS) takes coordinated action to provide a correct CSMP tape and letter of transmittal. The parent ISIC MDCO must retain copies of transfer-out and in letters for MJC Job Sequence Number control.

NOTE: ONCE A DEFERRAL HAS INITIALLY BEEN ENTERED IN THE COMPUTER AT THE ORIGINATING FMA, IT IS AUTOMATICALLY PASSED TO THE TYCOM MASTER CSMP. SUBSEQUENT TAPE TRANSFERS BETWEEN FMAs WILL NOT CAUSE THE DEFERRAL TO PASS AGAIN TO THE TYCOM PROVIDING THAT MDCO INPUTS THE TRANSFER TAPE (MM6031) TO MAINTENANCE RESOURCE MANAGEMENT SYSTEM (MRMS) PROGRAM 173 NOT 174.

- k. Non-Scheduled Repairs of PMR components. The ISIC must add to the ship's CSMP those PMRs to be accomplished in conjunction with a repair action, in lieu of a repair action, or to be credited subsequent to a repair or replacement action. One of the following actions must be taken by the ISIC and MDCO:
 - (1) When a ship's submitted deferral references a PMR for concurrent accomplishment with the repair action, or if ISIC or FMA planners recommend a PMR, the ISIC must make the decision whether or not to invoke the PMR in conjunction with or in lieu of the requested repair. This will result in two AWRs being created. The planner will have work accomplished under one JCN (EA01) and use the second JCN (EAJC) for administrative completion crediting of the PMR.
 - (2) If the repair job has resulted in replacement of the PMR component or if the maintenance standard requirements were completely accomplished prior to retrieving the PMR from the MJC, calldown the item from the local scheduling system. The ISIC should instruct FMA to report its completion including the added narrative to identify the originally assigned ship's JCN. Though the materials used cannot be re-identified to the PMR JCN, it is recommended that the total man hours expended also be reported on the PMR AWR or subsequent analysis of required PMR support.
- l. Training. The parent ISIC is responsible to provide assigned ship's training in the TYCOM PMR Scheduling System. Such training should include an overview of the SEOC Program, PMR scheduling products, MS Library and PMR program accomplishment and reporting systems. Emphasis should be placed on the ship's responsibilities to the PMR program as identified in paragraph 24.7.5 of this chapter.

24.7.4 Fleet Maintenance Activity.

- a. The FMA is responsible for accomplishing all PMR work as scheduled to the required repair standards.
- b. Commence the planning and material procurement function when the PMR is called down by the ISIC from the local scheduling system and brokered to the FMA.
- c. Progress the job, ensuring that the LWC coordinates with ship superintendent and all Assist WCs and that production time and current status is reflected in the local scheduling system.
- d. Complete the job, report its accomplishment and as found material condition feedback code on the AWR. Any significant findings should also be documented on the AWR. The LWC then completes the AWR by filling in action taken codes, signing for completion and then obtains acceptance signature from Ship's Force. The AWR is then returned to ARRS. The ARRS will verify that all participating WCs have documented completion of their assigned tasks and then pass the AWR to the ISIC for review and updating of SUBMEPP inventories and schedules prior to close-out of the AWR by ARRS. The material condition feedback codes are described in Appendix B of reference (a) as part of the action taken code, and are as follows:

NOTE: THE BELOW MATERIAL CONDITION FEEDBACK CODES SHALL DESCRIBE THE "AS FOUND" CONDITION OF THE COMPONENTS AND NOT THE AFTER REFURBISHED CONDITION OF THE COMPONENTS.

- (1) Code "A" means the material condition of the component being refurbished could have allowed the PMR to be deferred (extend the periodicity).
- (2) Code "B" means the material condition of the component being refurbished justified the scheduled PMR.

- (3) Code “C” means the material condition of the component being refurbished should have mandated an earlier completion of the PMR (shorten the periodicity).

NOTE: VARIATIONS TO THESE CODES MAY BE DESCRIBED IN INDIVIDUAL PMR MJC NARRATIVES.

- e. ARRS will verify that all participating WCs have documented completion of assigned tasks, Ship’s Force acceptance signature is on AWR and the final action taken code (2 characters) is entered. Prior to close-out of the AWR, ARRS will pass the AWR to the ISIC for review. For MRMS FMA sites, it is essential that ARRS verify that the MRMS Availability file has the proper scheduled completion date and code to identify that it is a scheduled availability. This is done by showing a “Y” in answer to “Is this a CNO Availability” on the appropriate screen.
- f. Adjustments of scheduled start and completion dates of the PMR and factual reporting of status codes.
- g. Review corrective action request submitted by Ship’s Force via an OPNAV 4790/2K to determine if the corrective action is to include the criteria of MRC, MS or TRS requirements.
- h. If the PMR maintenance procedure has a material condition feedback form, fill out the form and submit in accordance with the reporting requirements defined in the procedure.
- i. Report to the ISIC when PMRs are met in accordance with paragraph 24.5 of this chapter, due to the expansion of work boundaries.
- j. At the conclusion of an availability (not later than the Departure and Assessment Conference), in which I-Level PMRs were screened for FMA accomplishment, provide to the ISIC, verbally or by memo, the reason that any PMRs could not be accomplished (e.g., parts, manpower not available) as scheduled.

24.7.5 Submarine Commanding Officer.

- a. The ship’s Commanding Officer is responsible for the execution of PMR work on the ship.
- b. All discovered maintenance deficiencies which affect the equipment and systems covered by the PMR program should be documented to reflect the possible PMR with which the deficiency is associated. This will provide the ISIC with the alternative of simultaneously imposing repairs to the criteria of the specified Maintenance Standard and credit PMR accomplishment.
- c. All maintenance deficiencies will reflect in Block 46 (TYCOM SPECIAL PURPOSE), of the OPNAV 4790/2K whether or not quality control and Quality Assurance standards are required.
- d. Review Depot Availability Work Packages and provide comments to the TYCOM and SUBMEPP representatives during the work package review.
- e. Review the status of PMR maintenance in the SUBMEPP Quarterly PMR inventories and schedules and CSMP reports with parent ISICs prior to upkeep periods in order to assist in planning for accomplishment of required PMR maintenance.
- f. All maintenance deficiencies which affect the equipment and systems covered by the PMR program should be documented to reflect the possible PMR with which the deficiency is associated. Review ship's submitted deferrals of corrective maintenance for FMA accomplishment against the PMR inventory and record any applicable Maintenance Standard numbers on the OPNAV 4790/2K. If a component or piece of equipment is listed in the inventory but a Maintenance Standard number is not identified, annotate the OPNAV 4790/2K with “PMR applies”.
- g. Ensure that the current SUBMEPP Quarterly PMR Inventories and Schedules CD, MRCs, Maintenance Requirements and TRSs applicable to the ship class are carried on board.
- h. Ensure that MRCs, MSs and TRSs, which provide detailed information and repair guidance are referenced and used during equipment maintenance. Additionally, SUBMEPP PMR inventories provide useful guidance in preparing maintenance documents and planning work (i.e., component identification, Equipment Identification Codes, Allowance Parts Lists, Maintenance Standards, etc.).

- i. If Ship's Force accomplishes a repair of a PMR component to an MRC, MS or TRS, report same to the ISIC Material Officer so that the SUBMEPP Inventory and Schedules may be updated and follow-up reporting action may be initiated.
- j. Ensure all completed AWRs for PMRs are signed as accepted by Ship's Force.
- k. At the conclusion of an availability (not later than the Departure and Assessment Conference), in which I-Level PMRs were screened for FMA accomplishment, provide to the ISIC, verbally or by memo, the reason that any PMRs could not be accomplished (e.g., parts, manpower not available) as scheduled.

FOR OFFICIAL USE ONLY
 PERIODIC MAINTENANCE REQUIREMENTS
 SCHEDULED MPS REQUIREMENTS I-LEVEL

REPORT DATE: 30 Jan 2012
 CUTOFF DATE: 01 May 2013

VIRGINIA SSN 774
 SHIP'S UIC: 23013

RSG NEW LONDON
 NSSF NLON 68316

													REMARKS/COMPLETION INFO	
<u>COMPID</u>	<u>WC JSN</u>	<u>MJC NO</u>	<u>PROC TYPE</u>	<u>MAINTENANCE INSTRUCTION DOC</u>	<u>STAT</u>	<u>D D</u>	<u>LAST WRK CTR JSN</u>	<u>M C C</u>	<u>LMA DATE</u>	<u>DUE DATE</u>	<u>PER</u>	<u>ALT</u>	<u>JSN</u>	<u>DATE</u>
<u>HSC</u>	<u>RIC</u>	<u>EIC</u>												
SYSTEM: 23811 Secondary Propulsion														
SPM SPPT EQPT		N0002EMCC7145	MS	2380-081-032	IS				Apr 2007	Jun 2012	12M	62M		
23811CE3C	31A020262	FH01000												
SYSTEM: 24511 Propulsor														
PROPULSOR ASSY	EMJC0848	N0002EMCC7135	TM	S9086-CQ-STM-010	IS		EMJC0730		Sep 2009	Dec 2009	3M			
24511CL1	83A060033	FE03000	Chapter 081											
PROPULSOR ASSY	EMJC0849	N0002EMCC7141	MS	2450-081-024	IS				Jun 2012	Dec 2012	6M/R			
24511CL1	83A060033	FE03000	R = Accomplish: 1) Prior to and following occasion when the propulsor is operated dockside for periods longer than those associated with normal ship arrival and departure. 2) Whenever abnormal noise or vibration is observed. 3) When performance declines. 4) When damage is suspected. 5) Prior to performance trials.											
SYSTEM: 25511 Piping and Accessories, Main Feedwater														
SH-0019	EMJC0903	N0002EMCC6993	MS	2550-081-104	IS		EMJC0526		Jun 2009	Jun 2011	24M			
25511DE1	99A030134X	F30K000												
SYSTEM: 25541 Piping and Accessories, Main Condensate														
CF-070	EXJC0961	N0006EXCAC757	MS	2550-081-077	IS			Z	Apr 2007	Apr 2012	60M			
25541DH70	88A010318X	F30K000												
CF-076	EXJC0962	N0006EXCAC757	MS	2550-081-077	IS			Z	Apr 2007	Apr 2012	60M			
25541DH76	88A010318X	F30K000												
CF-082	EXJC0963	N0006EXCAC757	MS	2550-081-077	IS			Z	Apr 2007	Apr 2012	60M			
25541DH82	88A010318X	F30K000												
CF-114	EXJC0957	N0006EXCAC757	MS	2550-081-077	IS			Z	Apr 2007	Apr 2012	60M			
25541DH114	883116679X	F30K000												
CF-115	EXJC0958	N0006EXCAC757	MS	2550-081-077	IS			Z	Apr 2007	Apr 2012	60M			
25541DH115	883116679X	F30K000												

VI-24A-1

APPENDIX A
 SUBMEPP MAINTENANCE AND SHIPWORK PLANNING (MSWP)
 PERIODIC MAINTENANCE SCHEDULE - I-LEVEL

(This Page Intentionally Left Blank)

FOR OFFICIAL USE ONLY
 PERIODIC MAINTENANCE REQUIREMENTS
 I-LEVEL INVENTORY SORTED BY SYSTEM

REPORT DATE: 30 Jul 2012

VIRGINIA SSN 774													RSG NEW LONDON		
SHIP'S UIC: 23013													NSSF NLON 68316		
<u>COMPID</u>	<u>WC JSN</u>	<u>MJC NO</u>	<u>PROC TYPE</u>	<u>MAINTENANCE INSTRUCTION DOC</u>	<u>STAT</u>	<u>D</u>	<u>LAST WRK CTR JSN</u>	<u>M C</u>	<u>LMA DATE</u>	<u>DUE DATE</u>	<u>PER</u>	<u>ALT</u>	<u>JSN</u>	<u>REMARKS/COMPLETION INFO</u>	<u>DATE</u>
<u>HSC</u>	<u>RIC</u>	<u>EIC</u>													
<u>SYSTEM: 073 Acoustic Surveys and Tests</u>															
RADIATED NOISE		N0002WKCC6328	JFMM	4790.3	IS			Z	Apr 2007		R				
	NONE 1211													R = Accomplish when funded by NAVSEA and authorized by TYCOM during start of ship's operating cycle.	
<u>SYSTEM: 091 Ship Inspections</u>															
TSRA		N0002WKCC6373	PI		IS		WKJC0598		Jul 2009		R				
	XCONFIGITEM			COMSUBFORINST 9010.5										R = Accomplish prior to deployment.	
<u>SYSTEM: 11111 Shell Plating, Pressure Hull</u>															
SPHERE MHCVO		N0002WQCC4336	MS	1110-081-016	IS				Jun 2012	Jun 2015	36M				
	NONE 034														
<u>SYSTEM: 18511 Auxiliary Systems Foundations</u>															
AMR 50K MT		N0002EACC9759	MS	1850-081-001	IS				Apr 2007		R				
18511CL1	31A020267	A000000												R = Accomplish based upon results of inspection.	
<u>SYSTEM: 18611 Outfit and Furnishings Foundations</u>															
HAB 50K MT		N0002WQCC4403	MS	1860-081-001	IS				Apr 2007		R				
18611CL1	31A020267	1C03000												R = Accomplish based on results of inspection (MRN 301-028).	
<u>SYSTEM: 22311 Main Storage Battery</u>															
BAT TRLY ATH		N0002EECC6359	MS	2230-081-020	IS			Z	Apr 2007		R				
22311CL6	58A020009	FF03000												R = Accomplish following repairs, after cells have been removed from battery compartment.	
BAT TRLY ATH		N0002EECC6451	MS	2230-081-023	IS		EEJC0609	A	Nov 2009		R				
22311CL6	58A020009	FF03000												R = Accomplish each battery replacement prior to use.	
BAT TRLY F&A		N0002EECC6451	MS	2230-081-023	IS		EEJC0610	A	Nov 2009		R				
22311CL5	58A020010	FF03000												R = Accomplish each battery replacement prior to use.	

APPENDIX B
 SUBMEPP MAINTENANCE AND SHIPWORK PLANNING (MSWP)
 INVENTORY OF PERIODIC MAINTENANCE REQUIREMENTS - I LEVEL
 COMUSFLTFORCOMINST 4790.3 REV C CH-1

VI-24B-1

(This Page Intentionally Left Blank)

PERIODIC MAINTENANCE REQUIREMENTS
I/D-LEVEL INVENTORY SORTED BY SYSTEM

REPORT DATE: 31 Jul 2012

MARYLAND SSBN 738
SHIP'S UIC: 21460

SQUADRON 20

														REMARKS/COMPLETION INFO	
COMPID	WC JSN	MJC NO	PROC TYPE	STAT	MAINTENANCE INSTRUCTION DOC	R M L	D D	LAST WRK CTR JSN	M C	LMA DATE	DUE DATE	PER	ALT	JSN	DATE
HSC		RIC	EIC												
SYSTEM: 073A NOISE AND VIBRATION SURVEYS INTERNAL															
STRBORN NOIS SY		N0005WQCC0204	PAT	IS	0731-009		D		Z	Jul 1992	Oct 2075	R	999M	000-F74	
073A000000		T89GEN073A	1000												R = Accomplish prior to each depot availability.
STRBORN NOIS SY		N0018EECC0020	PAT	IS	0731-003		D			Jul 1992		R		000-A33	
073A000000		T89GEN073A	1000												R = Accomplish 6 months prior to ERP, RAV and ERO.
STRBORN NOIS SY		N0018EECC0019	PAT	IS	0731-001		D			Jul 1992		R		000-A32	
073A000000		T89GEN073A	1000												R = Accomplish 6 months prior to ERP, RAV and ERO.
STRBORN NOIS SY		N0005WQCC0203	TP	IS	8-277-512		D		Z	Jul 1992		R		000-F72	
073A000000		T89GEN073A	1000												R = Accomplish during/after each depot availability.
SYSTEM: 073B NOISE AND VIBRATION SURVEYS EXTERNAL															
EXT NOISE		N0018WQCC0004	PAT	IS	0731-006		D			Jul 1992		R		000-A34	
073B000000		T89GEN073B	1000												R = Accomplish prior to each availability.
EXT NOISE		N0018WQCC0005	PAT	IS	0731-002		D			Jul 1992		R		000-A35	
073B000000		T89GEN073B	1000												R = Accomplish 6 months prior to ERP, RAV and ERO.
UND NOISE SURV		N0005WQCC0225	PAT	IS	0731-008	I	D		Z	Jul 1992		R		000-G32	
073B010000		T89GEN073B													R = Accomplish each depot availability.
SYSTEM: 1110 Shell Plating, Penetration & Inserts, Submarine Pressure Hull															
400 HZ SHORE POWER		N0005EECC0223	MS	IS	1110-081-015		I	EEJC6173	B	May 2009	May 2013	48M		000-E15	
320B040100		T999971826	4306												
400 HZ SHORE POWER		N0005EECC0212	MS	IS	1110-081-003	I	D			Jul 1992		R		000-A28	
320B040100		T999971826	4306												R = Accomplish based on deficiencies identified by Ship's Force.
ACTIVE EMIS DET		N0005EECC0212	MS	IS	1110-081-003	I	D			Jul 1992		R		000-A28	
414B000000		T89GEN414B	R000												R = Accomplish based on deficiencies identified by Ship's Force.

VI-24C-2

COMUSFLTFORCOMINST 4790.3 REV C CH-1
APPENDIX C
SUBMEPP MAINTENANCE AND SHIPWORK PLANNING (MSWP)
INVENTORY OF PERIODIC MAINTENANCE REQUIREMENTS - I/D LEVEL

APPENDIX D

SUBMARINE PERIODIC MAINTENANCE REQUIREMENT (PMR) MANAGEMENT PROCESS

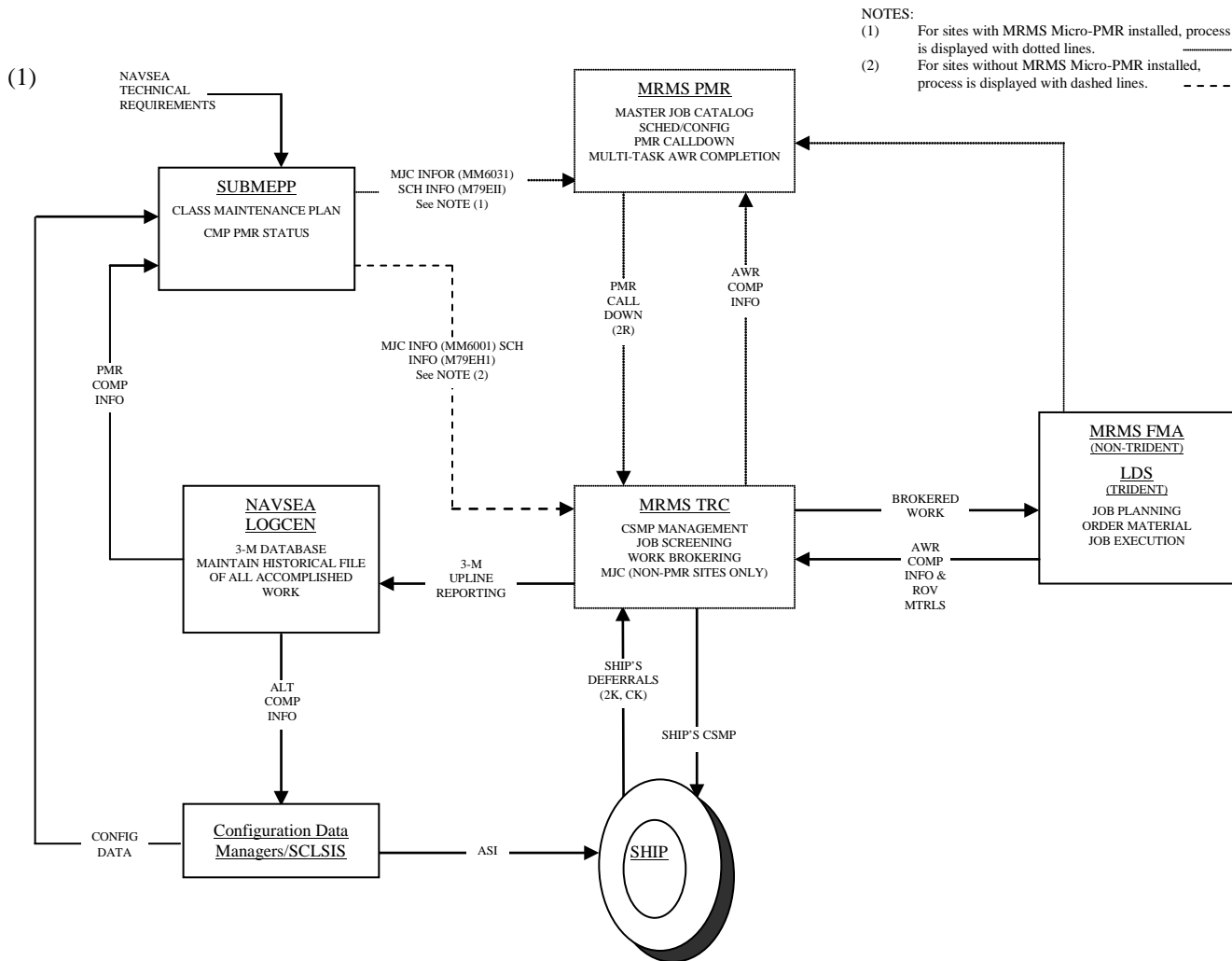

(This Page Intentionally Left Blank)

FOR OFFICIAL USE ONLY			USS SANTA FE (SSN 763) SRA 2*			PART 1			SYSTEM ID: 111A01		
WP ISSUE: ISSUE THREE			WORK PACKAGE SUPPLEMENT								
URO/HIP CHANGE NO: 145			SHIPYARD PLANNING & FEEDBACK REPORT						02NOV2011		
SYSTEM ID: 111A01 Superstructure and Fairwater											
COMP IDENT	APL/RIC	HSC	LOCATION COMPONENT DESCRIPTION	DD	MAINTENANCE STANDARD	STAT	CONDITION			REMARKS	
<u>27.0076.0666</u>				RML SY							
Clean and spot represerve (touchup) the fairwater (interior only). R = Accomplish every depot availability that URO MRC 003 is not authorized.											
INTR PSVTN	NONE	1111X1022A	SYS LVL REQ-INTERIOR PRESERVATI		MS 6310-081-015 H/CHG1	IS	A	B	C		
											Attachment 5
<u>27.0076.1302</u>				RML SY							
Perform structural inspection of the fairwater; repair as necessary (interior). R = Accomplish every depot availability that URO MRC 003 is not authorized.											
INTR PSVTN	NONE	1111X1022A	SYS LVL REQ-INTERIOR PRESERVATI		MS 7650-081-091 B/CHG8	IS	A	B	C		
<u>27.0125.1302</u>				RML SY							
Inspect; repair special hull treatment (SHT). R = Accomplish every depot availability that URO MRC 003 is not authorized.											
SHT	X90613RP459	1111X1000M	SOUND ISOLATION X DAMPING MATER	DD	OTHE S6360-AD-HBK-010	IS	A	B	C		
<u>27.0320.1302</u>				RML SY							
Inspect; repair nonwatertight access hatches, cover plates & access manhole covers. Note 1: Accomplish to the extent possible with removal, unless they are removed for other reasons. R = Accomplish whenever hatches, plates or covers are removed for other reasons.											
COVERS	X90613CM004	1111X1000Q	SYS LVL REQ-SUPER STRUCTURE (CO		MS 1510-081-004 E/CHG7	IS	A	B	C		
FAIRWATER DR	NONE	840 1111X1000R	FAIRWATER DOOR		MS 1510-081-004 E/CHG7	IS	A	B	C		
SYSTEM ID: 111A01			PART 1			PAGE - 1			FOR OFFICIAL USE ONLY		

VI-24E-1

APPENDIX E
 WORK PACKAGE SUPPLEMENT - SHIPYARD PLANNING
 AND FEEDBACK REPORT

<u>USS SANTA FE (SSN 763) SRA 2 CHGS 010-037 WP</u>						
<u>PART 4.13 FMA SCHEDULED PERIODIC MAINTENANCE REQUIREMENTS</u>						
CUT-OFF DATE: <u>1/23/2013</u>						<u>WORK PACKAGE STATUS</u> (AUTHORIZED BY)
SYSTEM ID CHG	GCMA/MRN	COMP ID MA DESCRIPTION	LMA	DUE DATE	MJC#	SWLIN SECT
1110	<u>27.0040.0900</u>	SAFE TRACKS TEST	Apr10	Apr12	N0002WKCC6363	
1110	<u>27.0060.0902</u>	DAVIT TEST; REPAIR	Jul10	Jan13	N0002WKCC6132	
2015	<u>44.2380.0090</u>	HS-607 TEST	May06	May11	N0006EXCAC832	
2015	<u>44.2380.0900</u>	HS-621 TEST	Dec04	Dec09	N0006EXCAC832	
2030	<u>44.2560.0900</u>	HSS-037 TEST	May03	May08	N0006EXCAC830	
2040	<u>29.0040.1300</u>	SNORKL MAST INSPECT	Jul10	Jul12	N0002EACCC8973	
2070	<u>70.0140.1627</u>	GMS8A01 CONDUCT VISUAL INSPECTION	Jan11	Jan12	N0002EMCC6141	
2080	<u>70.0380.1627</u>	GCF8A01 CONDUCT VISUAL INSPECTION	Jan11	Jan12	N0002EMCC6145	
2090	<u>37.0020.22A2</u>	PUMP-1 INT REPLACE INGERSOL RAND MSW PUMP PARTS (DESIGN B)	Apr09	Apr12	N0002EMCC6241	
2090	<u>44.2380.0900</u>	MSW-035 TEST	Mar08	Mar12	N0006EXCAC729	
2090	<u>44.2380.0900</u>	MSW-036 TEST	Mar08	Mar12	N0006EXCAC729	
2090		MSW-060	Mar08	Mar12	N0006EXCAC729	
PART 4.13 FMA SCHEDULED PERIODIC MAINTENANCE REQUIREMENTS						
FOR OFFICIAL USE ONLY						

APPENDIX F
WORK PACKAGE – SHIP’S SYSTEM WORK DESCRIPTION
PART 4.13

USS (SHIP'S NAME AND HULL NO.) SHIP SYSTEM WORK DESCRIPTION – ISSUE TWO PART 4.13 FMA SCHEDULE PERIODIC MAINTENANCE REQUIREMENTS								
CHG	WPS SWAB GCMA	MA DESCRIPTION WPS COMPID	PER	LMA VIT	DUE DATE	MJC#	WORK PACKAGE STATUS (AUTHORIZED BY)	
							SWLIN SECT	ASSN
059	5520 79.0280.2100	RESTORE ACC IND LEAD		JUL85 3		02EECC5309	552A01 79.0280.2100	SY
	<u>REMARKS:</u> Restoration of contents indicator is required because lead accumulator maintenance is being replaced by AERP in Section 38.0078.2222.							
059	5520 79.0300.2100	RESTORE ACC IND PORT		JUL85 3		02EECC5309	SEE REMARKS	
	<u>REMARKS:</u> No fixed periodicity. Accomplish only if accumulator maintenance is performed.							
059	5520 79.0300.2100	RESTORE ACC IND STBD		JUL85 3	JUL93	02EECC5309	SEE REMARKS	
	<u>REMARKS:</u> No fixed periodicity. Accomplish only if accumulator maintenance is performed.							
059	5610 37.0320.U006	URO REQUIREMENT ASW PUMP-1	096	JUL85 1	JUL93	08EMCKC741	561A01 37.0320.U006	SY
	<u>REMARKS:</u> -							
059	5610 37.0320.U006	URO REQUIREMENT ASW PUMP-2	096	JUL85 1	JUL93	08EMCKC741	561A01 37.0320.U006	SY
	<u>REMARKS:</u> -							
059	5610 37.0320.U006	URO REQUIREMENT ASW PUMP-3	096	JUL85 1	JUL93	08EMCKC741	561A01 37.0320.U006	SY
	<u>REMARKS:</u> -							
059	5610 44.0020.U009	URO REQUIREMENT ASW-030	036	JAN91 1	JAN94	08EMCKC918	561A01 44.0020.U009	SY
	<u>REMARKS:</u> -							
059	5610 44.4285.1300	INSPECT ASW-067	012	OCT90 1	OCT92	07EMCF0004	561A01 44.4285.1300	FMA
	<u>REMARKS:</u> FMA accomplish prior to ship entering the shipyard for DMP.							

PART 4.13 FMA SCHEDULED PERIODIC
 MAINTENANCE REQUIREMENTS
 PAGE 8 OF 13

(This Page Intentionally Left Blank)

VOLUME VI
CHAPTER 25
UNRESTRICTED OPERATIONS

REFERENCES.

- (a) NAVSEA 0924-062-0010 - Submarine Safety (SUBSAFE) Requirements Manual
- (b) OPNAVINST 3120.33 - Submarine Extended Operating Cycle (SEOC) Program
- (c) COMSUBLANT/COMSUBPAC NOTE C3120 - Submarine Operating Restrictions and Depth Authorization

LISTING OF APPENDICES.

- A URO MRC Automated Work Request for Ship's Force Accomplishment
- B URO MRC Automated Work Request for FMA Accomplishment
- C SUBMEPP URO MRC Inventory
- D SUBMEPP URO MRC Schedule
- E Request for URO MRC Periodicity Extension Format
- F Sample Work Package Supplement

25.1 PURPOSE. This chapter provides guidance and definition for the requirements, responsibilities and actions for continued submarine Unrestricted Operation (URO) to design test depth. The URO Maintenance Requirement Card (MRC) program is invoked on all Submarine Safety (SUBSAFE) certified submarines.

25.2 UNRESTRICTED OPERATION MAINTENANCE SCHEDULING, PLANNING AND REPORTING.

25.2.1 Maintenance Requirements for Continued Unrestricted Operation to Design Test Depth. Reference (a) establishes the Maintenance Requirements and identifies the responsibilities and actions required to support continued unrestricted submarine operations to design test depth. In conjunction with reference (a), Naval Sea Systems Command (NAVSEA) has issued individual manuals containing required, periodic SUBSAFE maintenance actions for each ship/class. The URO MRCs in these publications will identify degradation of the material condition of the hull integrity boundary and of those systems affecting ship's recoverability. The requirements set forth in these publications are, in addition, defect monitoring requirements, established on an individual ship basis, for submarines in which known uncorrected deficiencies exist. SUBSAFE certification indicates that a valid recommendation for URO to design test depth can be made. Maintenance of certification is dependent on both the positive control of all re-entries into the SUBSAFE boundaries per Volume V, Part I, Chapter 5 of this manual, the satisfactory and timely completion of applicable URO MRCs as required by reference (a) and any necessary repairs. Accomplishment of the URO MRCs specified with this program identify changes within the SUBSAFE boundary which result from inadvertent error and/or from degradation caused by the service environment.

25.2.2 Scheduling and Reporting. In order for the Type Commanders (TYCOM) to carry out their responsibilities in the material certification of submarines and to aid in decisions concerning operational restrictions, an auditable system of scheduling the performance and reporting of URO MRCs has been developed. This system provides visibility to problem areas, facilitates verification and provides a permanent record of URO MRC accomplishment in the ship's Maintenance and Material Management (3-M) machinery history maintained at the NAVSEA Logistics Center.

25.2.2.1 Non-SSBN/SSGN 726 Class Ships. Submarine Maintenance Engineering, Planning and Procurement Activity (SUBMEPP) provided Periodic Maintenance Requirement (PMR) inventories and schedules and the 3-M Master Job Catalog (MJC) Programs are used for scheduling and reporting. The scheduled URO MRC requirements added to the Current Ship's Maintenance Project (CSMP) from the local scheduling system and the Automated Work Requests (AWR) produced will contain unique Job Control Numbers (JCN) consisting of ship's Unit Identification Code (five characters) plus WC (Department/Division + JC) (four characters) plus Job Sequence Number (four characters). Appendices A and B of this chapter show a URO AWR for Ship's Force and Fleet Maintenance Activity (FMA) accomplishment respectively. Appendices C and D of this chapter show examples of the SUBMEPP URO MRC inventories and schedules respectively.

25.2.2.2 SSBN/SSGN 726 Class Ships. SUBMEPP provided URO MRC inventories, schedules, Master Job File, as well as the Refit Work Planning System, are used for scheduling and reporting. The scheduled URO MRC requirements added to the CSMP from the local scheduling system and the AWRs produced will contain unique JCNs consisting of ship's Unit Identification Code (five characters) plus WC (Department/Division + JC) (four characters) plus Job Sequence Number (four characters). Appendices A and B of this chapter show a URO MRC AWR for Ship's Force and FMA accomplishment respectively. Appendices C and D of this chapter show examples of the SUBMEPP URO inventories and schedules respectively.

25.2.2.3 Submarine Maintenance Engineering, Planning and Procurement Activity Inventories and Schedules. The SUBMEPP inventories and schedules are provided quarterly. The SUBMEPP schedules reflect all URO MRC requirements coming due within the next 12 months. A description of the data elements used in the inventories and schedules is provided with each issue.

25.2.3 Baseline and Due Dates. The baseline date for determining URO MRC due dates is the Last Maintenance Action (LMA) date. LMA dates for new requirements will be based on the Change Issue Date of the URO MRC invoking the new requirement unless otherwise directed from NAVSEA. Due dates are calculated based on LMA dates in accordance with paragraph 25.2.3.2 of this chapter. It is recognized that upkeep and docking schedules for ships which are well into the operating cycle may not permit full compliance with the scheduled due dates. In such cases, a Departure From Specification (DFS) for the URO MRC will be addressed on a case-by-case basis as specified in Volume V, Part I, Chapter 8 of this manual. LMA dates and URO MRC due dates are determined as follows:

25.2.3.1 Last Maintenance Action Date. For new construction ships, all URO MRCs have an initial LMA date established at delivery from new construction or from Post Shakedown Availability to start the operating cycle in accordance with the applicable URO MRC manual. During the operating period between commissioning and start of Post Shakedown Availability and during the operating cycle following Post Shakedown Availability, an adjusted LMA, as discussed below, is used for URO MRCs. Calculate the adjusted LMA date as follows:

- a. If the PMR is accomplished during a period other than a scheduled availability (e.g., voyage repair periods, at sea, port calls, Continuous Maintenance Availability (CMAV), upkeep, etc.) the adjusted LMA date will be the first of the month following the completion date listed on the PMR data form.
- b. If the PMR is accomplished during a scheduled availability (e.g., Selected Restricted Availability, Extended Refit Period, Depot Modernization Period, Engineered Refueling Overhaul, Interim Dry Docking, other Chief of Naval Operations (CNO) Availabilities, CMAV or upkeep), the adjusted LMA date will be the first of the month following the scheduled availability's actual completion date.

NOTE: IMMEDIATE SUPERIORS IN COMMAND (ISIC) OPERATING WITH THE ON-SITE PMR SCHEDULING SYSTEM MUST ENSURE THAT AVAILABILITY DATES ARE ACCURATELY MAINTAINED SO THAT COMPLETED AWR UPLINE REPORTED DATA REFLECTS THE ADJUSTED LMA DATE AND ON-SITE PMR SCHEDULING RECORDS CALCULATE THE PROPER NEXT DUE DATE.

25.2.3.2 Calculating Due Dates. Next due dates are calculated based on an adjusted LMA date. Due dates are calculated, for scheduling purposes, by taking the adjusted LMA date month (number) and adding the periodicity months (number) to show the month due (i.e., an item with an adjusted LMA date of February 2003 (2/03) with a six month periodicity would be due in August 2003 (8/03)). The PMR will be accomplished prior to midnight of the last calendar day of the month due.

25.2.4 Periodicity Extensions. When determining the due date for URO MRC inspections 001, 004, and 005 for an individual submarine, inactive time (defined as the number of days pierside plus the number of days in dry-dock) may be excluded from the time elapsed since the last inspection. When determining the due date for URO MRC 002, 003 (certain portions) and 035, only the time in dry-dock may be excluded from the elapsed time. The ship's deck log, engineering log or the ship's coolant discharge log will be used to determine the number of days pierside or the number of days in drydock. Ship's Force will perform this review and provide the applicable dry-dock and/or inactive time via official correspondence to the ISIC. Extensions of periodicity from the next due date identified in the SUBMEPP PMR inventory for these URO MRCs can be authorized by the TYCOM without further NAVSEA

approval. However, they are not automatic and such requests shall be submitted by letter, in the format of Appendix E of this chapter, to SUBMEPP via the TYCOM. Upon receipt of TYCOM authorization, SUBMEPP will reflect the periodicity extension and the revised due date in the next issue of the ship's PMR inventories and schedules.

25.2.5 Scheduling, Planning and Reporting Unrestricted Operation Accomplishment at Ship/Fleet Maintenance Activity Level.

25.2.5.1 Scheduling. The TYCOM PMR Scheduling System Inventories and Schedules is distributed by SUBMEPP to the appropriate ISIC every quarter. Except at NAVIMFAC PACNORWEST, along with this PMR CD, electronic update files are provided to keep the local scheduling systems up to date with the Class Maintenance Plan (CMP). As a minimum, ISICs will schedule applicable URO MRCs 40 days (SSBN/SSGN 726 Class submarines) or 40 days (non-SSBN/SSGN 726 Class submarines), as applicable prior to refit fleet maintenance availability. Those URO MRC AWRs requiring work packages or other planning are forwarded to the FMA Planning Section.

25.2.5.2 Planning. FMA Planners will requisition materials, obtain plans and drawings, prepare Formal Work Packages and/or Controlled Work Packages and coordinate the scheduling with the Ship Superintendent, Production Officer and ISIC Material Office. Then the job will be turned over to the production WC for accomplishment. For Ship's Force accomplishment of URO MRCs, the ISIC will provide an AWR to the ship. The Maintenance Document Control Office (MDCO) will adjust the scheduled start and completion date within the local scheduling system.

25.2.5.3 Reporting to the Maintenance and Material Management (3-M) System. Each URO MRC AWR contains specific instructions on reporting the completed action and on use of a special feedback code to identify the material condition or that a change in inspection frequency is required. In order to ensure URO MRCs are correctly accomplished and reported to SUBMEPP, the following actions are to be taken prior to closeout of the AWR by Analysis, Records and Reports Section (ARRS):

- a. Submarines completing URO MRC AWRs are to fill-in the AWR with action taken codes and suffix of A, B, or C for material condition assessment, if applicable. Ship will sign for completion, ISIC will sign for acceptance. Include a narrative statement, if required, and return the original AWR to the ISIC. The ISIC will review the AWR and forward to ARRS to close out the computer AWR and update SUBMEPP inventories and schedules. Note that because of the Auto-Close features, the completed AWR will automatically close the deferral in the CSMP.
- b. FMA Lead Work Centers (LWC) completing URO MRC AWRs must ensure that all assist WCs have completed their work. The LWC then completes the AWR by filling in action taken codes, signing for completion and obtains acceptance signature from Ship's Force. The AWR is then returned to ARRS. The ARRS will verify that all participating WCs have documented completion of their assigned tasks and then pass the AWR to the ISIC for review and updating of SUBMEPP inventories and schedules prior to close-out of the AWR by ARRS.

25.2.6 Unrestricted Operation Maintenance Requirement Card Accomplishment During Chief of Naval Operations Maintenance Availabilities.

- a. The Availability Work Package (AWP) prepared by SUBMEPP will reflect all URO MRCs authorized for accomplishment during the availability at the AWP Ship Work List Item Number (SWLIN) level. The Work Package Supplement (WPS), accompanying the AWP, will identify a specific URO MRC requirement to the applicable AWP SWLIN paragraph. Appendix F of this chapter provides an example of the WPS format.
- b. For URO MRCs assigned to the depot, the ISIC will enter "Assigned to <depot name> by AWP <AWP number>" in the Remarks/Completion block of the URO MRC Schedule/Inventory and in the local scheduling system.
- c. URO MRC completions by an industrial activity during CNO Availabilities will be, for non-SSBN/SSGN 726 Class submarines, retrieved from the shipyard information system by SUBMEPP. For SSBN/SSGN 726 Class submarines, completions will be retrieved from the appropriate maintenance database. The WPS, or comparable report, annotated by SUBMEPP to show URO PMR

completions and material condition feedback categories, will be retained by SUBMEPP upon completion of the availability. The ISIC will verify that all URO MRCs assigned to the shipyard were reported and subsequently updated by SUBMEPP.

25.2.7 Unrestricted Operation Maintenance Requirement Card Completion Reporting.

- a. Within 30 days after the completion of an availability the activity accomplishing the URO MRC is required to provide a report of accomplishment to SUBMEPP and the ship's ISIC as well as other technical codes as designated in the URO MRC. Specific information to be included in the report is identified in the applicable URO MRC. The accomplishing activity shall retain a legible copy of the most current inspection report until the ship is disposed of or stricken from the Naval Register.
- b. Prior to Fast Cruise for CNO Availabilities, the industrial activity is required to provide the ship and ISIC with a letter of certification (including final inspection categories A, B, or C when applicable) that certifies all required inspections have been satisfactorily completed. For items which must be accomplished in dry-dock, the industrial activity is required to provide such certification prior to undocking.
- c. Upon identifying a material condition that would result in a reduced inspection periodicity if not restored to Category A condition during the availability in which the condition was found, a special report is required to be submitted by the accomplishing activity in accordance with the applicable URO MRC and, if applicable, the AWP. This special report shall be provided immediately to NAVSEA (SEA 07), TYCOM, ISIC, and SUBMEPP indicating:
 - (1) Applicable MRC.
 - (2) Equipment component identification.
 - (3) Inspection category.
 - (4) The reduced or deferred periodicity of each equipment component that should be inspected at less than its normal periodicity. This reduced periodicity report requirement is in addition to the completion reporting requirements of paragraphs 25.2.7.a and b above.

25.2.8 Operating Cycle/Interval Extensions. An Audit Plan to assess the material condition of ships prior to extending their operating cycle/intervals beyond URO MRC periodicities due to changing CNO Availability dates or operational schedules, is addressed in reference (b). Additional guidance and responsibilities are contained in Volume II, Part I, Chapter 3 of this manual.

25.3 RESPONSIBILITIES.

25.3.1 Type Commander.

- a. Perform periodic audits of the ISICs and FMAs to verify full compliance with the provisions of reference (a), Volume V, Part I, Chapter 9 of this manual and this chapter.
- b. Provide guidance to the ISICs, obtaining NAVSEA concurrence as necessary, when deviations in the scheduling or accomplishment of maintenance or repairs are required by a DFS request and resolution per Volume V, Part I, Chapter 8 or this manual.

25.3.2 Submarine Maintenance Engineering, Planning and Procurement Activity.

- a. Receive reports of completion of URO MRCs from all completing activities.
- b. Review completion reports for compliance with the scheduled periodicity requirements and any change in the status category.
- c. Establish an LMA date per paragraph 25.2.3.1 of this chapter.
- d. Revise the periodicity and next due dates in ship URO MRC inventories and schedules to reflect any NAVSEA approved periodicity change, TYCOM approved periodicity extensions for URO MRCs 001 through 005, and 035 as allowed for in paragraph 25.2.4 of this chapter and NAVSEA approval of Major DFSs for extending URO MRC requirements.

- e. Notify the TYCOM via the on-site SUBMEPP Representative of any URO MRC beyond periodicity for TYCOM resolution.
- f. Provide updated:
 - (1) URO MRC inventories and schedules CD in accordance with the distribution.
 - (2) For SSBN/SSGN 726 Class ships, provide Refit Work Package electronic files which reflect URO MRC scheduling to the Trident Refit Facility at the arrival minus 60 day milestone.
 - (3) For those ISICs using Micro-PMR, provide scheduling and configuration files to process in the local scheduling system and FMA database quarterly.
 - (4) Provide MJC update files which reflect URO MRC changes to the ISIC/TYCOM at least quarterly or upon request.
- g. Provide, as enclosures to the quarterly inventories and schedules forwarding letter, a list of URO MRCs that appear overdue in the schedules and a list of URO MRCs that have been reported complete by the fleet but Objective Quality Evidence has not been received by SUBMEPP.
- h. Receive and review URO MRC Objective Quality Evidence for technical accuracy and maintain URO MRC completion history.

25.3.3 Immediate Superior In Command.

- a. Maintain auditable records of URO MRC accomplishment for each submarine. These records will include the current SUBMEPP Quarterly inventories and schedules, completed AWRs for URO MRCs completed, data report forms/reports submitted as a result of last accomplishment and all approved DFS.
- b. Conduct periodic audits of assigned FMAs and units to verify full compliance with the provisions of reference (a), Volume V, Part I, Chapter 9 of this manual and this chapter.
- c. In addition to the records of audits, maintain a file, by ship, of the current URO MRC inventories and schedules as provided by SUBMEPP. The schedules (Appendix D of this chapter) for each ship shall be annotated with the Job Sequence Number (JSN), the new adjusted LMA date and the next due dates for the completions and any periodicity extensions authorized.
 - (1) Although the responsibility for the accomplishment of URO MRCs must rest with the ship's Commanding Officer, the nature and scope of the URO MRCs dictate that the ISIC coordinate the accomplishment of URO MRCs in accordance with the SUBMEPP provided PMR inventories and schedules. Accordingly, the ISIC shall assist in the preparation of, and approve each submarine's URO MRC performance schedule. Monitor the URO MRC/Deep Submergence System/Hull Integrity Procedure Status Web Site periodically to identify potentially overdue URO MRC/Deep Submergence System/Hull Integrity Procedures. The SUBMEPP representative assigned to each ISIC shall add information, in the form of a comment to the Web Site, addressing any overdue or potentially overdue items. Upon completion of a Ship's Force accomplished URO (e.g., 016, 022, 025, 026, 029, 036), the ISIC URO Coordinator shall update the SUBMEPP URO status website by creating a comment, located at <https://eagle.submepp.navy.mil/eBusiness/index.cfm>, with the following information until the correct information is reflected on the webpage:
 - (a) Name of person entering data
 - (b) URO completion date
 - (c) New LMA Date
 - (d) New Due Date
 - (2) In addition, the ISIC shall:
 - (a) Unless previously notified by SUBMEPP of delays, notify the SUBMEPP Representative at TYCOM of the non-receipt of schedules and reports.

- (b) Upon receipt of the quarterly report from SUBMEPP, perform a line-by-line verification of each ship's new URO MRC Inventory and Schedule against the URO MRC Inventory and Schedule report held by the ISIC. At a minimum, this verification will include a review of each URO MRC LMA, Due Date, and Periodicity to ensure any recent completion data or rescheduling data that has been submitted to SUBMEPP has been accurately incorporated into the new Inventory and Schedule. PMRs accomplished during the month preceding the quarterly report may or may not be reflected in the issue received. Similarly, upon receipt of URO MRC changes, audit the individual URO MRC procedural and schedule information against each ship's PMR Inventory and Schedule held by the ISIC to verify that the component/equipment and periodicity has not changed and that provided changes do not impact current schedules. Resolve identified deficiencies through the SUBMEPP Representative at TYCOM.
- (c) Review the enclosures to the PMR procedural inventories and the schedule forwarding letter and advise SUBMEPP of the completion dates and JSNs for URO MRCs listed. Forward copies of completed Data Report Forms for these and any other URO MRC completions identified by SUBMEPP as having missing Data Report Forms.
- (d) Following receipt of the URO MRC Inventory and Schedule quarterly report from SUBMEPP the ISIC shall provide the following material to each applicable ship:
 - 1 A copy of each PMR Inventory and Schedule CD.
 - 2 A copy of each organizational level URO AWR assigned to Ship's Force and scheduled for accomplishment during the next refit/availability.
 - 3 A copy of the individual ship's URO MRC Inventory and Schedule that has been customized by the ISIC to include information more current than the quarterly report provided by SUBMEPP and JSN scheduling information entered by the ISIC URO MRC coordinator.
- d. Control input of the SUBMEPP scheduling file (M79EII) to the local scheduling system and resultant calldowns to the CSMP, which will produce the JCN and products for job completion.
- e. Ensure that all URO MRC requirements with the appropriate screening (Ship's Force, FMA) are in the CSMP for subsequent development by SUBMEPP of forthcoming CNO Availability AWP's.
- f. In the event that deviations from required periodicities or full requirements of the URO MRCs are required, request approval from the TYCOM by submitting a DFS request in accordance with Volume V, Part I, Chapter 8 of this manual. Such DFS requests will be a Major DFS for URO MRC program deviations. DFS requests are also to be submitted when repairs arising from the URO MRC inspections cannot be completely accomplished. Periodicity extension requests for URO MRC 001, 002, 003, 004, 005 and 035 shall be submitted in accordance with paragraph 25.2.4 of this chapter.
- g. Establish procedures to affect routing of completed AWRs from the FMA ARRS or from the submarine (LWC 991) through the ISIC for all URO MRC transactions. The ISIC should ensure proper documentation has been completed as described in the special reporting procedures of the AWR. This must include the material condition feedback code as part of the final action, if required. A rejection series code (6A-6I) should not be accepted unless the FMA Repair Officer cannot accomplish the URO MRC at that site. Delays in accomplishment are to be reported as status changes so that the job remains in the production system and is visible as a "to-be-done" requirement. If the URO MRC requirement cannot be accomplished at the site, the ISIC must ensure update (re-screening) of the CSMP concurrently with DFS notification, if necessary. Each processed AWR is to be validated with the PMR Special Report described in the Maintenance Resource Management System section of Volume II, Part I, Chapter 2 of this manual and, if satisfactory, passed to the Automated Data Processing Center for computer input. Upon receipt of the report of maintenance action accomplishment from an assigned unit or the FMA, review the report for completeness, consistency, acceptability of conditions and material trends. Where unsatisfactory conditions are found, direct repairs. Where repairs cannot be made, submit a DFS in accordance with Volume V, Part I, Chapter 8 of this manual. Ensure

SUBMEPP inventories and schedules are updated in accordance with paragraph 25.3.3(c) of this chapter. Clear URO MRC major DFS upon TYCOM or NAVSEA approval and upon receipt of the SUBMEPP Quarterly PMR inventories and schedules, and ensure they accurately reflect the new due date of the URO MRC as stated in the approved DFS.

- h. Upon identifying a material condition that would result in a reduced inspection periodicity, ensure the accomplishing activity immediately reports the condition found via faxed letter to NAVSEA (SEA 07), the TYCOM and SUBMEPP in accordance with paragraph 25.2.7.c of this chapter.
- i. Monitor the timely submission of URO MRC data report forms and the report of accomplishment for URO MRCs completed by the FMA and Ship's Force to ensure required documentation is submitted in accordance with paragraph 25.2.7 of this chapter. Ensure data report forms are submitted to report component replacement/repair/operation out of specification. Review all Ship's Force accomplished URO MRC data for compliance with the requirements of the URO MRC Program prior to submittal to SUBMEPP.
- j. Prior to a ship's underway period, review the ship's certification continuity report, if submitted, to ensure the ISIC and ship's records (including the CSMP) accurately reflect URO MRC status.
- k. The Parent ISIC of deploying ships will:
 - (1) Ensure that any URO MRC due for accomplishment by the ship during its deployment period is identified in the CSMP transfer file and that the ship possesses the AWRs and URO MRC data report forms (if applicable) for reporting job completion.
 - (2) Provide a message to the applicable deployed FMA/Squadron identifying any URO MRC expected to be accomplished by the deployed FMA and the status of required materials for each submarine deploying to cover the period of the deployment.
- l. Deployed Squadrons will review the URO MRC status of deployed submarines upon in-chop. Perform the function of the Parent ISIC in ensuring all URO MRCs are accomplished and reported within the required periodicity while the submarine is deployed.

NOTE: THIS IN NO WAY RELIEVES THE PARENT ISIC OF THE RESPONSIBILITY TO ENSURE THAT THE REQUIRED URO MRCs ARE ACCOMPLISHED WITHIN THE SPECIFIED PERIODICITIES.

- m. Prior to the start of a CNO availability, ISIC URO coordinators will:
 - (1) Assign JCNs to URO MRC items assigned to Forces Afloat in the AWP and screen them to an availability prior to the start of the CNO availability or to the concurrent availability in accordance with the directions in the AWP. Forces Afloat items are accomplished by Ship's Force or Performance Monitoring Team. Care must be taken to appropriately assign URO MRC items to the correct accomplishing activity.
 - (2) ISIC URO coordinators will not assign JCNs to URO MRC items assigned to the shipyard in the AWP. In the URO MRC inventories and schedules, in the remarks/completion information area, enter "assigned to (name of shipyard) by AWP (name and number of availability)". The shipyard is responsible for performing, auditing and reporting all URO MRC items assigned by the AWP.
 - (3) URO MRCs assigned to Forces Afloat by the AWP for accomplishment prior to the start of the depot period, but for some reason were not completed, will be reassigned to a concurrent availability or formally reassigned to the shipyard via a supplemental work request.
- n. During a CNO availability, URO MRCs assigned to the shipyard by the AWP which are not accomplished during the depot period will be placed on the guarantee list or reassigned to a fleet availability by the TYCOM following the depot period provided the URO MRC does not exceed its due date. The ISIC will be notified of this reassignment by formal correspondence which will include justification and reason why the scheduled and planned requirements were not met.

- o. Prior to CNO availability completion, ISICs will audit URO MRCs assigned to Forces Afloat by the AWP and ensure all have been satisfactorily completed and documented within the required periodicity. The ISIC audit will also verify that all URO MRC items coming due within six months of availability completion are complete or assigned to a follow-on fleet availability. Under no circumstances are URO MRC due dates to be exceeded. ISIC Quality Assurance Officers will not be responsible for auditing URO MRCs assigned to the depot in the AWP.
- p. Following CNO availability completion, the ISIC URO coordinator will ensure that all URO MRCs assigned to the shipyard were reported and subsequently updated by SUBMEPP. ISICs will only upline the closed JCNs for URO MRCs completed by Forces Afloat.

25.3.4 Submarine Commanding Officer.

- a. Ensure all URO MRCs are accomplished within the required periodicity as specified by reference (a), Volume V, Part I, Chapter 5 of this manual and this chapter.
- b. For visual inspections in between URO MRC 003 inspections, see Volume V, Part I, Chapter 5, paragraph 5.4.3.d. of this manual for a description of requirements to inspect submarine hull structure in between the periodic URO MRC 003 inspections.
- c. Maintain auditable records of the accomplishment of URO MRCs to permit verification of compliance with reference (a), Volume V, Part I, Chapter 10 of this manual and this chapter. These records shall consist of:
 - (1) A copy of the TYCOM and NAVSEA SUBSAFE Material Certification message from new construction, Depot Modernization Period or overhaul until the ship's current status is reflected in reference (c). When the ship's current status is reflected in reference (c) the messages may be destroyed and the current notice will be retained.
 - (2) Copies of letter of completion for all URO MRC work accomplishment by other activities, including most recent FMA URO Accomplishment Letter. These may be disposed of once accomplishment is captured electronically on ISIC provided SUBMEPP Schedules and Inventories.
 - (3) Copies of letters of completion and inspection reports for work accomplished by Ship's Force. The required report forms are located at the end of the individual URO MRCs. A copy of each completed report shall be submitted to the ISIC for review a minimum of 24 hours prior to underway.
 - (4) One copy each of the current Quarterly URO MRC inventories and schedules as printed from the CD provided by SUBMEPP via the ISIC. Annotate the URO MRC Inventory Report when accepting completed work requests from the FMA or Ship's Force (LWC 991). It is the ship's responsibility for ensuring that the reports reflect the actual configuration, especially with regards to the equipment identity and the Allowance Parts List.
 - (5) Copy of outstanding URO MRC AWRs to be accomplished by Ship's Force.
 - (6) One copy of each approved DFS from the requirements of reference (a), Volume V, Part I, Chapter 8 of this manual and this chapter. This authority is based on the following factors and considerations:
 - (a) The completion of all URO MRCs, or portions thereof, will be reported on AWRs provided by the ISIC in accordance with paragraph 25.2.5.3 of this chapter. Particular care must be exercised to ensure that existing conditions found at the time of inspection and/or need for repair or replacement of components is recorded in detail as prescribed by the URO MRC.
 - (b) Deviations from URO MRC requirements or periodicities may result in operational restrictions being placed on a unit. In order to determine whether such restrictions are necessary, the TYCOM must be fully apprised of the number and extent of deviations involved.

- (c) Allow no deviations in the scheduling or accomplishment of required URO MRC maintenance actions unless formal NAVSEA approval of such deviations has been granted by an approved DFS or as allowed in paragraph 25.2.4 of this chapter. All system disassembles, repairs, and reassemblies must be conducted in accordance with Volume V of this manual, including requests for a DFS, if necessary.
- (d) Except in an emergency, refrain from submerged operations if all required URO MRC maintenance actions have not been completed within the specified periodicities unless formal authorization to deviate from these requirements has been granted by NAVSEA. NAVSEA recommendation and TYCOM authority to conduct URO MRC to design test depth are contingent upon the satisfactory completion of these maintenance actions.

(This Page Intentionally Left Blank)

APPENDIX A

URO MRC AUTOMATED WORK REQUEST FOR SHIP'S FORCE ACCOMPLISHMENT

```

IER622                                     *** AUTOMATED WORK REQUEST ***                               03 DEC 92 (92338)
OPNAV 4790/2R/Q DEFERRAL                                                           AVAIL: P106 (01JAN93-31MAR93)
*****SECTION I. IDENTIFICATION*****
1. UIC: 05152           2. OWC: EAJC           3. JSN: 3171           4. APL: 520175132           AILSN: 5520
A. NAME: FINBACK       5. EQUIP: ACCUMULATOR-HYD       13. IDENT: ACCUM MNA FC
B. HULL: SSN 670       14. EIC: TV01           16. LOCATION:           15. SAFE: NO
6. WHEN DISC: 0       7. EQ STAT: 0           8. CAUSE: 0           9. DEF REA: 6           10.:           11.:           12.:
18. CAT SHIP ALT # RN   PC   F$           19. PI           20. INSURV #           21. SUF           22. MDG           23. SAF           24. P/F
18A. MJC: N0008EAEACKS026
*****SECTION II. DEFERRAL ACTION*****
26. DEF DATE: 23 NOV 92 27. OMA MHR REM: AUTO 28. DEALN DATE: 31 JAN 93 9. DEF REA: 6
*****SECTION III COMPLETED ACTION*****
29. A/T: _____           30. OMA MHR EXP: 0000           31. DATE COMP:
SELECT EQUIPMENT           32. AMT: _____           33. TI: 0           34. METER READING:
*****SECTION IV. REMARKS/DESCRIPTION*****
35. REMARKS:   CHECK HYD SYS FLOOD CONTROL ACCUMULATORS IAW URO MRC 026 XXX
                LAST COMPLETED 90001 NEXT DUE DATE 93001
                MDCO PASS TO SHIP'S FORCE. S/F COMPLY WITH URO 026, COMPLETE
                BLOCKS 102-104 AND RETURN THIS AWR TO MDCO FOR ADP PROCESS.
                CONSULT THE TYCOM PMR SCHEDULING SYSTEM FOR SHIP OR COMPONENT
                SPECIFIC INFO SUCH AS "DD", SPECIAL REQ-MTS, PERIODICITY
                OR LEVEL OF ACCOMPLISHMENT.
37. CSMP SUMMARY: ACCOMPLISH URO MRC 026
38. 1ST CON:           39. 2ND CON:
41. PRI: 2           42. T/A: 2           43. INT PRI: 44. IUC SCRIN: 2           45. TYC SCRIN:
46. SPECIAL PURPOSE: A- B- C- D- E- F- G- H- I- J- K- L-
E. CO _____           F. TYCOM
*****SECTION V. SUPPLEMENTARY INFORMATION*****
48. REP TM: MRC URO MRC 026           ON BRD: NO
49. PREARV:
50. PLNRMK: MRC URO MRC 026
                *** COMPLETE INSPECTION FINDINGS AND FORWARD IAW URO 026 ***
50A. IUCRMK:
50B. TYCRMK:
50C. IMARMK:
*****SECTION VI. PLANNING*****
51. PMR: URO MRC 026 52. PER: 000 53. ISS: 7512 54. SPEC DATA: HP JC008638
QLV: 55. QA S/S: YES   NUC LI:           1NUC WPR:           SP CLN:           SPECID:           RADCON:
                LI: NON DT:           SAE DIV:           SP TST:           NOISE:           OTHCON:
56. SR K E: 0091   SP INT: YES           D/D REQ:           PREOVH:           AFTOVH:           DEPART:
K.E.: UROS DUE           K.E. DATE:           NORMALLY DONE BY:
*****SECTION VII. REPAIR ACTIVITY PLANNING/SCHEDULING ACTION*****
57. L/A RWC 58. SKD STRT 59. SKD COMP 60. PMHR 61. K/O 62. TASK
                L 991 01 JAN 93 30 JAN 93 008 001
93. RAUC: 05851 L Y SPEAR 94. WK RTN #: _____ 99. JOB ORDER NO:
95. EST M/D: _____ 96. EST M/D $: _____ 97. EST MATL $:
98. EST TOT $: _____ 100. LEAD P&E: _____ 101. DATE OF ESTIMATE: 23 NOV 92
102. FAT: _____ 103. ACT MHRS EXP: _____ 104. DATE COMP: _____
G. COMPLETED: _____ H. ACCEPTED BY:
*****SECTION VIII. SUPPLY DATA*****
PRI           DOC NUM           NIIN/PART#           DESC           QTY STATUS
    
```

(This Page Intentionally Left Blank)

APPENDIX B

URO MRC AUTOMATED WORK REQUEST FOR FMA ACCOMPLISHMENT

```

IER622                                     *** AUTOMATED WORK REQUEST ***
OPNAV 4790/2R/Q DEFERRAL                 AVAIL: A015* (04JAN93-07FEB93)
*****SECTION I. IDENTIFICATION*****
1. UIC: 05152      2. OWC: EMJC      3. JSN: 3170      4. APL: 884305120      AILSN: 2090
A. NAME: FINBACK      5. EQUIP: VALVE B 3.00 IPS      13. IDENT: MSW-108
B. HULL: SSN 670      14. EIC: FB08      16. LOCATION:      15. SAFE: NO
6. WHEN DISC: 0      7. EQ STAT: 0      8. CAUSE: 0      9. DEF REA:      6      10. :      11. :      12. :
18. CAT SHIP ALT #RN      PC      F$      19. PI      20. INSURV #      21. SUF      22. MDG      23. SAF      24. P/F
18A. MJC: N0008EMCKC918
*****SECTION II. DEFERRAL ACTION*****
26. DEF DATE: 23 NOV 92      27. OMA MHR REM: AUTO28. DEADLN DATE:      9. DEF REA: 6
*****SECTION III COMPLETED ACTION*****
29. A/T: _____      30. OMA MHR EXP: 0000      31. DATE COMP: _____
SELECT EQUIPMENT      32. AMT: _____      33.      TI: 0      34. METER READING: _____
*****SECTION IV. REMARKS/DESCRIPTION*****
35. REMARKS:      INSPECT BALL VALVE STEM IAW URO MRC 009
LAST COMPLETED 90001      NEXT DUE DATE 93001
CONSULT THE TYCOM PMR SCHEDULING SYSTEM FOR SHIP OR
COMPONENT SPECIFIC INFO SUCH AS "DD", SPECIAL REQ-MTS,
PERIODICTY, OR LEVEL OF ACCOMPLISHMENT
37. CSMP SUMMARY: ACCOMPLISH URO MRC 009
38. 1ST CON:      LPO      39. 2ND CON:
41. PRI: 2      42. T/A: 2      43. INT PRI:      44. IUC SCR N: 2      45. TYC SCR N:
46. SPECIAL PURPOSE: A-      B-      C-      D-      E-      F-      G-      H-      I-      J-      K-      L-
E. CO _____      F. TYCOM
*****SECTION V. SUPPLEMENTARY INFORMATION*****
48. REP TM: MRC URO MRC 009      ON BRD: NO
49. PREARV: *** COMP INSP FINDINGS AND FORWARD IAW URO/LID MRC 009 ***
50. PLNRMK:
THIS DEPOT JOB IS ASSIGNED TO IMA BY TYCOM
*** REPORT INSPECTION FINDINGS AND FORWARD IAW URO 009 ***
50A. IUCRMK:
50B. TYCRMK:
50C. IMARMK:
*****SECTION VI. PLANNING*****
51. PMR: URO MRC 009      52. PER: 000      53. ISS: 7302      54. SPEC DATA: HPIJC006547
QLV:      55. QA S/S: YES      NUC LI:NUC WPR:      SP CLN:      SPECID:      RADCON:
LI:      NON DT:      SAE DIV:      SP TST:      NOISE:      OTHCON:
56. SR K E: 0091      SP INT: YES      D/D REQ:      PREOVH:      AFTOVH:      DEPART:
K.E.: UROS DUE      K.E. DATE:      NORMALLY DONE BY: 1 DEP
*****SECTION VII. REPAIR ACTIVITY PLANNING/SCHEDULING ACTION*****
57. L/A RWC      58. SKD STRT      59. SKD COMP      60. PMHR      61. K/O      62. TASK
L 10C      04 JAN 93      18 JAN 93      0002      001      PACKAGE
A 38A      04 JAN 93      18 JAN 93      0027      001      INSP
A 93A      04 JAN 93      18 JAN 93      0008      001      INSP
A 93B      04 JAN 93      18 JAN 93      0002      001      QA
93. RAUIC: 05851 L Y SPEAR      94. WK RTN #: _____      99. JOB ORDER NO: _____
95. EST M/D: _____      96. EST M/D $: _____      97. EST MATL $: _____
98. EST TOT $: _____      100. LEAD P&E: _____      101. DATE OF ESTIMATE: 23 NOV 92
102. FAT: _____      103. ACT MHR S EXP: _____      104. DATE COMP: _____
G. COMPLETED: _____      H. ACCEPTED BY: _____
*****SECTION VIII. SUPPLY DATA*****
PRI      DOC NUM      NIIN/PART#      DESC      QTY      STATUS
    
```

(This Page Intentionally Left Blank)

URO CHANGE NO: 119 Mar 2003

PERIODIC MAINTENANCE REQUIREMENTS
INVENTORY URO/HIP SORTED BY SYSTEM

REPORT DATE: 10 APRIL 2003

SSSU NLON
NSSF NLON 68316

COMPID	LINE ITEM	COMP SERIAL	R MJC NO	M PROC TYPE	MAINTENANCE INSTRUCTION DOC	STAT	M L	D D	LAST WRK CTR JSN	C C	LMA DATE	DUE DATE	PER	ALT	JSN	REMARKS/COMPLETION INFO	
																DATE	
SYSTEM: 0611 AUDITS AND CERTIFICATION																	
SOE DOCUMENT	005716	P10001	N0008EXCKSO36	URO	036	IS	O		EXJC1967A		Sep 2002	Sep 2006	48M/R				
0611X5000B	X90613CM140		UE0000														R=T34 Complete at the end of each depot availability but not to exceed 48 months.
VITAL EQUIP	001252	P10001	N0008EXCKSO29	URO	029	IS	O			X	Jan 2001	Jan 2005	48M/R				
0611X1000A	X90613V0001		IC03000														R=T34 Complete at the end of each depot availability but not to exceed 48 months.
SYSTEM: 1110 SUPERSTRUCTURE AND FAIRWATER																	
FAIRWATER	001257	P1005	N0007WKCKC920	URO	003	IS	D	D			Feb 1994	Feb 2004	120M				
1111X1000J	X90613V0001		A600000														
SYSTEM: 1310 PRESSURE HULL																	
ASW1/2	007333	P10035	N0007WKCKC920	URO	003	IS	D	D		X	Jan 2001	Jan 2007	72M				
1311XAB11C	X90613CM027		1108000														
ASW29/30 INS	007334	P10034	N0007WKCKC920	URO	003	IS	D	D		X	Jan 2001	Jan 2007	72M				
1311XAB12C	X90613CM027		1108000														
ASW80/81	007335	P10033	N0007WKCKC920	URO	003	IS	D	D		X	Jan 2001	Jan 2007	72M				
1311XAA73C	X90613CM027		1108000														
CD 35 INSR	007336	P10031	N0007WKCKC920	URO	003	IS	D	D		X	Jan 2001	Jan 2007	72M				
1311XA781C	X90613CM027		1108000														
CD 4 INSR	007337	P10032	N0007WKCKC920	URO	003	IS	D	D		X	Jan 2001	Jan 2007	72M				
1311XA711C	X90613CM027		1108000														
CD 1/2 INSR	007338	P10029	N0007WKCKC920	URO	003	IS	D	D		X	Jan 2001	Jan 2007	72M				
1311X8980C	X90613CM027		1108000														

VI-25C-1

SUBMEPP URO MRC INVENTORY

APPENDIX C

COMUSFLTFORCOMINST 4790.3 REV C

(This Page Intentionally Left Blank)

URO CHANGE NO: 119 Mar 2003

PERIODIC MAINTENANCE REQUIREMENTS
INVENTORY URO/HIP SORTED BY SYSTEM

REPORT DATE: 10 APRIL 2003
CUTOFF DATE: 01 OCT 2003

SSSU NLON
NSSF NLON 68316

COMPID HSC	LINE ITEM RIC	COMP SERIAL EIC	MJC NO	R	M	MAINTENANCE INSTRUCTION DOC	STAT	M L	D D	LAST WRK CTR JSN	C C	LMA DATE	DUE DATE	PER	ALT	JSN	REMARKS/COMPLETION INFO DATE	
SYSTEM: 5182 STEERING AND DIVING (STRUCTURAL, MECHANICAL, AND ELECTRICAL CONTROL)																		
LKG STDIV DR	003361	P12140	N0008EACKS016	URO	016		IS	O/		EAJC1962A		Sep 2002	Sep 2003	9M/R	12M			
5182X1811B	X90613CM100		TL06000															R=260 Complete at the end of each depot availability but not to exceed 9 months from the last accomplishment
SYSTEM: 5400 NORMAL AND EMERGENCY BALLAST TANK BLOW (TITLE FOR 688 CLASS IS EMBT BLOW)																		
RISE BLOW	003813	P12548	N0008EACKS022	URO	022		IS	O		EAJC1963	X	Jan 2002	Jan 2003	12M				
5401X0101A	X90613BL001		TF01000															
STATBLOW LOC	003814	P12546	N0008EACKS022	URO	022		IS	O		EAJC1963	X	Jan 2002	Jan 2003	12M				
5401X0105A	X90613BL001		TF01000															R=260 Complete at the end of each depot availability but not to exceed 12 months from the last accomplishment.
STATBLOW REM	003815	P12547	N0008EACKS022	URO	022		IS	O		EAJC1965	X	Jan 2001	Jan 2007	72M				
1311XAB11C	X90613CM027		1108000															R=260 Complete at the end of each depot availability but not to exceed 12 months from the last accomplishment.
SYSTEM: 5520 MAIN AND VITAL HYDRAULIC (TITLE FOR 688 CLASS IS SHIP'S SERVICE HYDRAULICS)																		
HULL CLOSURE	004440	P13205	N0008EACKS025	URO	025		IS	O		EAJC2188	X	Jan 2002	Jun 2003	72M				
1311XAB12C	X90613CM027		1108000															R=261 Complete at the end of each depot availability but not to exceed 7 months from the last accomplishment.

VI-25D-1

APPENDIX D
SUBMEPP URO MRC SCHEDULE

COMUSFLTFORCOMINST 4790.3 REV C

(This Page Intentionally Left Blank)

**APPENDIX E
REQUEST FOR URO MRC PERIODICITY EXTENSION FORMAT**

4790
Ser

From: Commander, Submarine Squadron
 To: Commanding Officer, Submarine Maintenance Engineering, Planning and Procurement (SUBMEPP) Activity
 Via: Commander Submarine Force, (Atlantic/Pacific Fleet)
 Subj: REQUEST FOR EXTENSION OF PERIODICITY FOR URO MRC(S) _____ ON
 USS (Ship's Name and Hull No.)
 Ref: (a) Applicable URO MRC
 (b) COMUSFLTFORCOMINST 4790.3; Joint Fleet Maintenance Manual, Volume VI, Chapter 25
 (c) COMSUB(LANT/PAC) ltr 4790 Ser ___ of (previous letter granting extension of periodicity)

1. In accordance with references (a) and (b), request extension of URO MRC periodicity for USS (Ship's Name and Hull No.) to coincide with Selected Restricted Availability/Overhaul/Depot Modernization Period/Interim Dry-Docking as follows:

URO MRC	Equipment Guide List Item Number or Component Ident	LMA Date	Current Due Date	Inactive Time		Extension Required	Required Next Due Date
				Pierside Days *	Drydock Days		
001	All	June 82	Apr 91	200 days	100 days	7 months	Nov 91
002	All	June 82	Aug 91	N/A	100 days	3 months	Nov 91
003	4.b	June 82	Aug 91	N/A	100 days	3 months	Nov 91
004	INT Welds	June 84	Apr 91	200 days	100 days	7 months	Nov 91
005	INT Welds	June 84	Apr 91	200 days	100 days	7 months	Nov 91
035	All	June 84	Aug 91	N/A	100 days	3 months	Nov 91

* Credit for pierside days is awarded for days the ship is tied to the pier, no credit is given if the ship is underway anytime during the day.

2. Inactive time identified for the URO MRCs listed in paragraph 1 above is the actual allowable time accrued to date since URO MRC was last accomplished/previous extension of periodicity was granted by reference (c).

Copy to:
 COMNAVSEASYS COM (SEA 07) (080)
 Commanding Officer, USS (Ship's Name and Hull No.)

(This Page Intentionally Left Blank)

(This Page Intentionally Left Blank)

VOLUME VI
CHAPTER 26
OPERATING DEPTH POLICY

REFERENCES.

- (a) NAVSEA S9086-DA-STM-000 - NSTM Chapter 100 (Hull Structures)
- (b) COMNAVSUBFOR OPORD 2000
- (c) NAVSEAINST C9094.2 - Submarine Valve Operation Requirements for Builders and Post Overhaul Sea Trial Test Dives

26.1 **PURPOSE.** To provide Type Commander (TYCOM) policy with respect to the maximum allowable operating depths during trials, evolutions to be performed at the various depths, and the prescribed maximum water depth applicable in each case.

26.1.1 **Background.** Some deep diving submarines are limited to depths less than designed test depth pending accomplishment of certain hull and system modifications prescribed by Naval Sea Systems Command (NAVSEA) as necessary to permit certification to design test depth. As these modifications are accomplished during the availability, the integrity of the ships will be certified and they will be permitted to operate down to their design test depth either periodically or without restriction.

- a. The sequence of events leading to authorization for operations at the maximum operating depth during post industrial availability or new construction trials for SUBSAFE ships is as follows:
 - (1) Upon completion of the authorized industrial facility work, NAVSEA reviews the scope, degree and manner of accomplishment and recommends to the TYCOM that the submarine be authorized to test hull strength and integrity at an appropriate maximum keel depth during trials. This depth may be the designed test depth or a lesser depth.
 - (2) Based on this recommendation the TYCOM will normally authorize operation to the NAVSEA recommended keel depth by message to the ship, information to the applicable Immediate Superior In Command (ISIC), Supervising Authority/Industrial Activity (as applicable), NAVSEA, Fleet Commander and Chief of Naval Operations.
- b. In every instance where the maximum authorized operating depth is exceeded, a report shall be made in accordance with reference (a). In addition to those addressees listed in reference (a), an information copy shall be provided to the applicable TYCOM and ISIC.

26.2 **INITIAL TIGHTNESS DIVE.** The initial tightness dive following an industrial availability or new construction will be conducted in accordance with carefully planned procedures.

- a. The initial tightness dive will be an especially deliberate, planned, step-by-step evolution using conservative angles and moderate speed, or slower, in accordance with the approved Sea Trial Agenda. Caution is required not only because the material condition of the ship is untested at any depth following major industrial facility work, but also because of the crew's lack of recent submerged operational experience. Reference (b) applies.
- b. The maximum water depth allowable during the initial tightness dive will be as specified by reference (b). The approved Sea Trial Agenda and reference (c) describe those events to be conducted during the initial tightness dive and provide the requirements of the initial tightness dive. The approved Sea Trial Agenda also describes those events immediately following the initial tightness dive. The maximum operating keel depth will be 200 feet.

26.3 **DEEP DIVE/CONTROLLED DIVE.** After demonstrating satisfactory hull strength and integrity during the initial tightness dive, the requirement exists to test the hull at submerged depths down to the maximum operating depth. The first approach to these depths subsequent to the repair of major hull or sea connected systems work will be made in accordance with the following paragraphs.

26.3.1 Depth Limitations. The Deep Dive/Controlled Dive shall be made to the maximum operating depth in water specifically designated for such trials and under specific water depth restrictions in accordance with reference (b), and as promulgated in the appropriate TYCOM/ISIC Operation Order.

26.3.2 Conduct of Deep Dives/Controlled Dives. Deep Dive/Controlled Dive depth changes should be conducted in no greater than 200 foot increments when above one-half the maximum operating depth and in no greater than 100 foot increments when below one-half the maximum operating keel depth. Moderate speeds (within the limits of the submerged operating envelope) and angles must be used. Trim must be continually adjusted to provide neutral buoyancy.

26.3.3 Deep Submergence Bill. The Deep Submergence Bill shall be in effect with systems in the maximum secure condition and all unnecessary sea connected systems isolated. The main ballast tank blow system shall be lined up with all banks within 200 psi of full pressure. Cycling of the rudder and planes through full travel should be limited to the maximum authorized operating depth minus 100 feet at a moderate speed.

26.3.4 Valve Operation. Seawater system valve operations during post industrial availability and new construction Sea Trials will be in accordance with reference (c).

VOLUME VI
CHAPTER 27
SCHEDULED PRESERVATION UPKEEP
COORDINATED EFFORT

REFERENCES.

- (a) NAVSEA S9510-AB-ATM-010 - Nuclear Powered Submarine Atmosphere Control Manual, Volume 1
- (b) NAVSEA S9510-AB-ATM-020 - Nuclear Powered Submarine Atmosphere Control Manual, Volume 2
- (c) NAVSEA S9086-VD-STM-010 - NSTM Chapter 631 (Preservation of Ships In-Service - General)
- (d) NAVSEA MS 6310-081-015 - Submarine Preservation
- (e) OPNAVINST 5100.19 - Navy Occupational Safety and Health (NAVOSH) Program Manual for Forces Afloat
- (f) SOBT Video SVT-GT-9336 - Submarine Preservation

LISTING OF APPENDICES.

- A SPRUCE Key Event Schedule
- B SPRUCE Report Form
- C SPRUCE Check List

27.1 **PURPOSE.** The Scheduled Preservation Upkeep Coordinated Effort (SPRUCE) program has been established to ensure internal preservation is maintained at the highest possible level throughout the life of the ship. As a result of increased intervals between submarine Chief of Naval Operations Maintenance Availabilities, effective SPRUCE upkeeps are of prime importance. SSBN/SSGN 726 Class submarines are exempt from SPRUCE upkeeps. Under special circumstances, requests for SPRUCE upkeeps on SSBN/SSGN 726 Class submarines will be considered and shall be conducted in accordance with this chapter.

27.2 **SCHEDULING.**

- a. Immediate Superiors In Command (ISIC) shall schedule a three week SPRUCE below decks every 48 months. The SPRUCE shall contain a 14 day production period which will not be scheduled to commence sooner than two days following an underway period. Per references (a) and (b), underway periods shall not be scheduled within five days of completion of the production period. In summary:

Ship returns to port	0 days
Preparation period	2 days
Production period	14 days
Gas off period	5 days
TOTAL	21 days

- b. ISICs shall utilize every effort to accomplish a full three week SPRUCE consisting of 14 days of production. ISICs may approve a shorter SPRUCE below decks of 5 to 14 days of production time on a case-by-case basis due to operational requirements. Total allotted time for SPRUCE will at no time be less than 12 days to encompass preparation and gas off periods. A shorter production period will equate to a corresponding reduction in the overall amount of square footage accomplished during the scheduled period. When a shorter period is executed for below decks SPRUCES, meticulous attention should be given toward the accomplishment of additional below deck SPRUCE periods to ensure sufficient preservation is achieved to facilitate 33+ years hull life. SPRUCES not meeting three weeks in duration shall be properly documented by ISICs to ensure a complete history of ship's preservation is available.

Ship returns to port 0 days
Preparation period 2 days
Production period XX days
Gas off period 5 days
TOTAL 7+XX days

- c. ISICs shall schedule a one week SPRUCE for the sail interior every 24 months. Sail SPRUCEs can be coincidental with routine availabilities.
- d. A SPRUCE shall not be scheduled during other Ship's Force or Fleet Maintenance Activity (FMA) upkeeps with the exception of the five day gas off period which may be scheduled during a follow-on upkeep. A SPRUCE should not be scheduled within the six month period prior to a Chief of Naval Operations Maintenance Availability. A SPRUCE should not be scheduled within six months after a Depot Modernization Period (DMP), Engineered Refueling Overhaul, or Engineered Overhaul because of the industrial activity's preservation programs.
- e. The initial base date for scheduling is the official completion date of the ship's last DMP, Engineered Refueling Overhaul, or Engineered Overhaul.

27.3 RESPONSIBILITIES.

27.3.1 Type Commander.

- a. Administer the SPRUCE program.
- b. Maintain a file of SPRUCE lessons learned and distribute to ensure that all commands concerned have the latest information available.

27.3.2 Immediate Superior In Command.

- a. Schedule and coordinate SPRUCE upkeeps per the Key Event Schedule of Appendix A of this chapter.
- b. Coordinate submarine crew training.
- c. Monitor the effectiveness of the SPRUCE program.
- d. Chair a SPRUCE debrief with Ship's Force and FMA to review the effectiveness of the SPRUCE and generate lessons learned. The results of this meeting will be included in the Ship's SPRUCE completion letter.

27.3.3 Fleet Maintenance Activity.

- a. Provide training, tools, consumables, services, and required support personnel.
- b. Provide technical guidance consisting of around the clock coverage by a coatings inspector trained to the requirements of reference (c) and reference (d), as applicable. The coatings inspector will perform all inspections necessary to ensure proper preservation is accomplished and will complete Appendix B of this chapter for each area preserved. All completed forms from Appendix B of this chapter will be submitted to the ship for inclusion into their SPRUCE completion letter.

27.3.4 Submarine Commanding Officer.

- a. Ensure preservation is performed by Ship's Force using the procedures contained in references (c) and (d), as applicable, through (f).
- b. Ensure Ship's Force personnel are relieved of all requirements other than those necessary to maintain the safety and security of the ship during the SPRUCE.
- c. Designate an officer or Chief Petty Officer (CPO) to serve as the SPRUCE Manager.

- d. Ensure the ship is divided into preservation zones. Each zone will have an officer or CPO in charge during the SPRUCE. Conduct a thorough preservation inspection of each zone, assisted by an FMA coatings inspector (if possible) at least 90 days prior to the start of the SPRUCE to determine and prioritize the preservation to be accomplished. Appendix C of this chapter shall be reviewed as part of this inspection.
- e. Submit completion letter to the Type Commander (TYCOM) via the chain of command. This letter shall report results of the SPRUCE, problems encountered, lessons learned, and shall contain completed forms from Appendix C of this chapter.

(This Page Intentionally Left Blank)

APPENDIX A
SPRUCE KEY EVENT SCHEDULE

1. The ISIC is responsible for ensuring adherence to the following schedule to assure the effective planning of a SPRUCE upkeep. The ISIC will act for the ship to complete items should an underway period preclude timely accomplishment. The ISIC will alert the ship's Commanding Officer and the TYCOM in the event that any of the following time frames will be exceeded.

<u>DAY</u>	<u>ACTION</u>
-90	ISIC ensure SPRUCE is on the ship's operating schedule. Schedule the SPRUCE with the FMA. Notify TYCOM (N3/N4) of planned SPRUCE dates.
-90	Commanding Officer assign SPRUCE manager and zone supervisors. Ship/FMA conduct preservation inspection.
-90	Commanding Officer submit OPNAV 4790 2K/2L requests for powder coating services. Ships shall make effective use of these services to enhance the effectiveness of preservation for components located in hostile environments.
-90	ISIC/Commanding Officer arrange for respiratory protection physicals, initial respiratory training for the ship's Hospital Corpsman, and respirator fit-checks for crew by FMA Occupational Safety and Health personnel. The crew shall be trained in respirator use by the ship's Hospital Corpsman.
-90	ISIC/Commanding Officer make plans for crew technical training.
-30	Commanding Officer establish painting "Tiger Team" and ensure adequate number of personnel are assigned to accomplish the upkeep commensurate with ship checks. The Tiger Team should include personnel not necessary to maintain the safety and security of the ship. Promulgate a SPRUCE watchbill.
-30	Commanding Officer review and conduct training with assigned personnel and Work Center Supervisors. Establish a General Military Training program incorporating requirements of references (c) and (d), as applicable, (e), and (f) and the ship's paint schedule. Provide the SPRUCE Plan of Action and Milestone to the ISIC for review.

2. Conduct a 21 Day SPRUCE as follows:

<u>DAY</u>	<u>ACTION</u>
-2	Tiger team make preparations for SPRUCE.
1-2	Ship's Force preparations for SPRUCE.
3-16	Ship's Force execute SPRUCE preservation work.
<u>DAY</u>	<u>ACTION</u>
16	ISIC, Commanding Officer, FMA conduct SPRUCE debrief. Commanding Officer submit SPRUCE completion letter.
21	Ship's first available underway date.

(This Page Intentionally Left Blank)

APPENDIX B

SPRUCE REPORT FORM

SPRUCE REPORT FORM 4790.3

INSPECTOR

Ambient Conditions		Location Fr#	Date	Time	Date	Time	Date	Time
Air Temperature								
Wet Bulb Temperature								
Relative Humidity								
Surface Temperature								
Dew Point								
Hours Left Uncoated (Bare Metal)								
Coat #	Paint Manufacturer's Name and Description	Batch Number	Application Method	Time Allowed to Cure	DFT Before this coat	WFT Measurements	M i n	M a x
Coat #	Mixing	Holidays		Defects/Comments				

Surface Preparation

Pre-Inspection Comments

Defects Corrected

Pre-Cleaning Method

Comments

(This Page Intentionally Left Blank)

APPENDIX C
SPRUCE CHECK LIST

1. Has a Navy Occupational Safety and Health/Environmental Protection Agency representative been onboard to ensure compliance with occupational health and environmental regulations?
2. Is the ship aware of all required training (Hazardous Material, Respirator, Technical)?
3. Assess level of effort required to accomplish SPRUCE. Assess type/quantity of tools and paint required. FMA informed for planning purposes.
4. FMA coatings inspector review SPRUCE report form (Appendix A of this chapter) of this chapter requirements with the ship. Discuss why, how, and when these inspections are required.
5. Does the ship have a copy of Submarine On Board Training Video SVT-GT-9336 (Submarine Preservation)?
6. Does the ship hold the most recent revisions to NSTM Chapter 631 (Preservation of Ships In-Service - General) and reference (d)?
7. Is the ship aware of the appropriate uses of powder coatings?
8. Does the ship hold the most recent "lessons learned" distribution from the TYCOM?

(This Page Intentionally Left Blank)

VOLUME VI
CHAPTER 28
CABLEWAY ASSESSMENT

REFERENCES.

- (a) NAVSEAINST 9304.1 - Shipboard Electrical Cable and Cableway Inspection and Reporting Procedures
- (b) DOD-STD-2003 - Military, Standard, Electric Plant Installation Standard Methods for Surface Ships and Submarines

LISTING OF APPENDICES.

A Sample Cableway Assessment Message

28.1 PURPOSE. The Cableway Assessment Program is a comprehensive inspection of shipboard electrical cables, conducted by Fleet Maintenance Activity (FMA) cableway assessment teams. The requirements for cableway assessments are contained in reference (a), which defines the training requirements, assessment criteria, and reporting procedures relevant to the assessments.

28.2 HAZARD CATEGORIES. The surface force ships/aircraft carriers electrical cable and cableway assessment program is designed to identify and correct cable/cableway safety hazards in a prioritized, orderly manner, consistent with ship and personnel safety. The three categories of deficiencies are defined as follows:

- a. Category 1 - IMMEDIATE HAZARD: Deficiencies which are, or have the immediate potential to be, personnel safety hazards, electrical fire hazards, or which negate firebreak integrity.
- b. Category 2 - POTENTIAL HAZARD: Deficiencies which require corrective action to ensure continued reliable safe performance or to maintain watertight integrity, but are not an immediate danger to personnel or equipment.
- c. Category 3 - NON-HAZARDOUS: Deficiencies which are not hazardous to personnel or equipment but are not in compliance with approved standard installation practices.

28.3 DEFICIENCY CORRECTION. The intent of this program is to ensure that deficiencies classified as Category 1 are corrected immediately. Deficiencies classified as Category 2 should be scheduled for repair during the ship's next regularly scheduled industrial availability as work priority permits. Category 3 deficiencies should be corrected whenever such repairs can be accomplished in conjunction with other scheduled repairs or alterations involving the cables or cableway in which the deficiencies exist.

28.4 ASSESSMENT SCHEDULING.

28.4.1 Initial Assessment. Initial cable/cableway assessments are conducted on each ship to establish a baseline configuration to ensure compliance with reference (b).

28.4.2 Follow-up Assessments. Follow-up assessments shall be conducted within 12 months prior to a major or minor Chief of Naval Operations availability. The purpose of this assessment is to validate the integrity of ship's cableways, identify discrepancies that require depot or commercial level work effort, and to train responsible Ship's Force personnel to meet requirements of paragraph 28.6.5 of this chapter. Both the initial and follow-up assessments will be comprehensive, complete ship assessments.

28.4.3 Partial Assessments. Following availabilities which modify shipboard cableways, ships may request partial assessments to validate the quality of the modified or newly installed cableways.

28.5 CABLEWAY ASSESSMENT/ASSIST TEAM COMPOSITION AND PROCEDURES.

- a. FMA Electrical Cableway Assessment shops ideally consist of 12 FMA personnel. The recommended shop manning is six certified personnel and six personnel in training. Certified personnel must have satisfactorily completed a cableway assessment/repair training course and satisfactorily demonstrated their practical knowledge based on enclosure (1) of reference (a). Personnel in training may assist in cableway assessments after satisfactorily completing classroom training modules per reference (a) and satisfactorily demonstrating their practical knowledge to an FMA appointed certifying assessor. Assessors should be E5 or above, with shipboard experience, and from the following source ratings: AE, EM, ET, EW, FC, FT, GM, GSE, IC, IT, STG, and STS.
- b. For assessment/assist visit purposes, the FMAs should establish sub-teams of one certified assessor, one trainee, and one Ship's Force member. Assign as many sub-teams as necessary to assess the entire ship. The assessed ship will assign a minimum of one Ship's Force person per FMA sub-team from the above source ratings, for the purpose of training, and to assist in shipboard assessment and repairs. Each FMA will assign one HT (qualified welder) to assist during shipboard cableway repairs.
- c. In addition to technical training, all team members shall be trained to administer Cardio-Pulmonary Resuscitation.
- d. Upon completing the assessment of the entire ship, assessment teams will assist in the correction of cableway deficiencies as time and schedules permit. Repair efforts will concentrate on removal of dead-ended cables, correction of watertight integrity items, and Category 1 discrepancies.

28.6 RESPONSIBILITIES.

28.6.1 Immediate Superior In Command. Ensure assigned ships are scheduled to receive required cableway assessments and training.

28.6.2 Regional Maintenance Center. Schedule assigned ships for cableway assessments/assist visits and coordinate the training effort of Ship's Force personnel by the FMA.

28.6.3 Fleet Maintenance Activity.

- a. Establish the following to support the Electrical Cableway program:
 - (1) Electrical Cableway Assessment and Repair Teams for the accomplishment of scheduled cableway assessments.
 - (2) Training program to support FMA training needs as specified in Part II of enclosure (1) of reference (a).
 - (3) Training program for ship's personnel. Training of Ship's Force personnel will include classroom training before the assessment and shipboard practical training during the assessment.
- b. Give daily progress reports (briefing, if possible) to ship's Commanding Officer, identifying Category 1 findings and any other areas of concern.
- c. Upon completion of the assessment, submit a final report per Appendix A of this chapter to the applicable Type Commander (TYCOM) (N434), info the Immediate Superior In Command (ISIC) and the Regional Maintenance Center. The final report should contain a list of Ship's Force personnel trained as cableway assessors/repairmen, including names and rate/rank.

28.6.4 Cableway Assessment Team.

- a. Locate, identify, and categorize electrical cableway discrepancies on ships.
- b. Train Ship's Force to assess, repair, and maintain shipboard cableways.
- c. Correct identified discrepancies which are beyond Ship's Force capability, and/or document discrepancies for future correction.

- d. Provide guidance for the repair of deferred discrepancies.

28.6.5 Ship Commanding Officer.

- a. Assign Ship's Force personnel (E4 or above) from source ratings listed in paragraph 28.5.a of this chapter for FMA cableway assessment repair training. After completing training, they will serve as quality assurance personnel to minimize future discrepancies by contractors and electrical installation teams. They should identify, track, and repair cableway discrepancies within their departments.
- b. Correct outstanding discrepancies listed in the final cableway assessment report.
- c. Within 30 days of completion of the assessment, enter all unrepaired Category 1 discrepancies in the Current Ship's Maintenance Project. Schedule these items for corrective action at the earliest opportunity.

28.7 REPORTS. Upon completion of the cableway assessment, the assessing agency must submit a final report using the format of Appendix A of this chapter.

(This Page Intentionally Left Blank)

APPENDIX A
SAMPLE CABLEWAY ASSESSMENT MESSAGE

FM (FMA)//
 TO USS (SHIP'S NAME AND HULL NO.)//
 INFO ISIC//(AS APPROPRIATE)
 RSG/RMC//(AS APPROPRIATE)
 BT
 UNCLAS //N04790//
 MSGID/GENADMIN/(ORIGINATING FMA)//
 SUBJ/ ELECTRICAL CABLEWAY ASSESSMENT REPORT FOR USS (SHIP'S NAME AND HULL NO.)//
 REF/A/DOC/COMUSFLTFORCOMINST 4790.3//
 AMPN/REF A IS JOINT FLEET MAINT MAN/VOL VI CH 28 PROVIDES GUIDANCE IN CABLEWAY
 INSPECTIONS//
 RMKS/1. CABLEWAY ASSESSMENT OF USS (SHIP'S NAME AND HULL NO.) WAS CONDUCTED IN
 ACCORDANCE WITH REF A FROM (START DATE) TO (COMPLETION DATE) BY (INSPECTING UNIT).
 RESULTS ARE AS FOLLOWS:

	CAT 1	CAT 2	CAT 3	TOTAL
ITEMS IDENTIFIED	_____	_____	_____	_____
ITEMS CORRECTED	_____	_____	_____	_____
ITEMS REMAINING	_____	_____	_____	_____
ITEMS DOWNGRADED	_____	_____	_____	_____

2. CABLE/CABLEWAY DISCREPANCIES.

	QUANTITY	PERCENTAGE
DEAD-ENDED CABLES	_____	_____
IMPROPER EQUIPMENT/BULKHEAD PENETRATIONS	_____	_____
COLLARS/CHAFING RINGS WITHOUT FIRE STOP	_____	_____
MISSING CABLE HANGERS	_____	_____
TUBES NOT PACKED	_____	_____
TUBES NOT BLANKED	_____	_____
CHAFED CABLES	_____	_____
EQUIPMENT IMPROPERLY MOUNTED	_____	_____
CONNECTERS MISSING TEMPSEAL	_____	_____
IMPROPER SPLICES	_____	_____
EXCESSIVE SLACK IN CABLES	_____	_____
INCORRECT BEND RADIUS	_____	_____
MISSING COVERS	_____	_____
IMPROPER BANDING	_____	_____

IMPROPER CABLE RUNS	_____	_____
FIRE BOUNDARIES MISSING FIRE PROTECTIVE COATING	_____	_____

3. THE FOLLOWING ITEMS WERE CORRECTED:

	QUANTITIES
DEAD ENDED CABLES	_____
DEAD ENDED CABLES PROPERLY END SEALED	_____
NEW CABLES INSTALLED	_____
IMPROPER EQUIPMENT PENETRATIONS DOWNGRADED WITH APPROVED METHODS	_____
FIRE BOUNDARIES TREATED WITH FIRE PROTECTIVE COATING	_____

(LIST ANY OTHER TYPES OF DISCREPANCIES AND QUANTITIES CORRECTED)

4. FIRE PROTECTIVE COATING (TYPE) HAS BEEN APPLIED TO ALL ELECTRICAL PENETRATIONS THROUGH DESIGNATED FIRE ZONE BOUNDARIES (IF ALL DESIGNATED BOUNDARIES WERE NOT COATED, IDENTIFY REMAINING BOUNDARIES TO BE COATED).

5. ELECTRICAL CABLE/CABLEWAY INSPECTION IS COMPLETED (OR) ELECTRICAL CABLE/CABLEWAY INSPECTION IS COMPLETE WITH THE FOLLOWING EXCEPTIONS (LIST COMPARTMENTS OR IDENTIFY BOUNDARIES).

6. THE FOLLOWING SHIP'S FORCE PERSONNEL WERE TRAINED AND HAVE SATISFACTORILY DEMONSTRATED THEIR PRACTICAL KNOWLEDGE IN CABLEWAY INSPECTION AND REPAIR TECHNIQUE. PERSONNEL HAVE BEEN INFORMED OF THEIR RESPONSIBILITY FOR QUALITY ASSURANCE OF CABLEWAYS INCLUDING INSPECTION AND MAINTENANCE OF CABLEWAYS:

NAME	RATE/RANK	SSN (last four digits only)
_____	_____	_____
_____	_____	_____
_____	_____	_____
_____	_____	_____

BT

NOTE: ENSURE MESSAGES ARE IN ACCORDANCE WITH CURRENT MESSAGE FORMAT AND CURRENT PLAIN LANGUAGE ADDRESS DIRECTORY (PLAD) IS UTILIZED.

VOLUME VI
CHAPTER 29
HEAT STRESS CONTROL AND REPAIR OF
THERMAL INSULATION

REFERENCES.

- (a) NAVSEA S9086-VH-STM-010 - NSTM Chapter 635 (Thermal, Fire and Acoustic Insulation)
- (b) OPNAVINST 5100.20 - Shipboard Heat Stress Control and Personnel Protection
- (c) OPNAVINST 5100.19 - Navy Occupational Safety and Health (NAVOSH) Program Manual for Forces Afloat
- (d) NAVSEA S9086-RQ-STM-010 - NSTM Chapter 510 (Heating, Ventilation, and Air Conditioning Systems for Surface Ships)

LISTING OF APPENDICES.

A Inspection Guide for Excessive Heat

29.1 PURPOSE. To provide guidance for reducing excessive heat generation and the control of asbestos lagging and insulation material.

29.2 HEAT STRESS.

- a. Excessive temperatures not only cause discomfort to personnel and the risk of burns from hot surfaces, but also lead to inattentive or inefficient watch standing, and the inability to perform maintenance. They also lead to jury-rigging of ventilation systems, often making the situation more severe. While the principal problems are centered in the engineering spaces, these conditions also exist in other heat producing spaces (i.e., laundries, sculleries, and auxiliary machinery spaces).
- b. The causes of excessive temperatures in ship machinery spaces are:
 - (1) Radiant heat from steam piping valves and machinery which has missing, water soaked, or deteriorated insulation.
 - (2) Steam and water leaks.
 - (3) Boiler air casing leaks.
 - (4) Ventilation system deficiencies, such as, inadequate cleaning, improper maintenance/grooming, and design inadequacies.
- c. Several steps have been taken toward correcting the problem of heat stress.
 - (1) Fleet Maintenance Activities (FMA) have increased their capability to accomplish lagging of piping and machinery.
 - (2) Special teams have been set up in some FMAs to aid ships in inspecting for insulation deficiencies.
 - (3) FMAs are outfitted with hand held pyrometers.
 - (4) Fire room lagging repairs are priority items during Chief of Naval Operations Maintenance Availability.

29.2.1 Measurement of Insulation Surface Temperatures.

- a. Check and calibrate the pyrometer per the instrument directions. Checking for the proper emissivity setting is particularly important. The following emissivities apply to this procedure:
 - (1) Navy white paint (clean) - 0.9
 - (2) Navy aluminum paint (clean) - 0.4

- b. Sight the pyrometer on the object to be inspected. Record pyrometer readings for each location tested. Measure and record ambient dry bulb readings in proximity to the surface being inspected for each location being inspected. When inspecting piping systems, scan the pipe run with the pyrometer. When a location with deteriorated insulation, producing a hot spot, is passed the readings will increase significantly. Record this location as requiring insulation replacement.
 - (1) Items or systems being inspected shall be at normal operating conditions and temperatures.
 - (2) If the pyrometer acts erratically (i.e., zero not adjustable), place the instrument in a cool air stream until the instrument stabilizes and then proceed with the readings.
 - (3) When not in use, store the pyrometer in an area having an ambient temperature of less than 100 degrees F.
- c. Determine the maximum allowable surface temperature, as shown in reference (a). If the recorded temperature exceeds the maximum allowed per reference (a), corrective action must be taken.
- d. Appendix A of this chapter is a checklist guide to be used in locating areas of excessive heat generations.

29.2.2 Heat Stress Area Stay Times. Heat stress is measured with a Wet Bulb Globe Thermometer in accordance with the instructions contained in reference (b). Using the Wet Bulb Thermometer readings, calculate stay times from the Stay Time Tables of reference (b).

29.3 INDUSTRIAL AVAILABILITY LAGGING PLAN. For any industrial availability period where major lagging work is expected, prepare an overall lagging plan, and schedule repairs that permit coordination with other planned work. The plan must show which areas to be repaired contain asbestos. Visual inspection and use of a pyrometer, when underway, is normally sufficient to reveal areas needing repair or replacement. For each piping system inspected, mark up a copy of the system piping diagram to show specific repairs needed, and attach the marked up diagram to an OPNAV 4790/2K work request.

29.4 ASBESTOS LAGGING/INSULATION.

29.4.1 Asbestos Control and Safety. All personnel shall understand and adhere to the policies and procedures provided in references (a) and (c) regarding the handling of asbestos. Those persons that meet the criteria in reference (c) shall be enrolled in the Asbestos Medical Surveillance Program.

29.4.2 Repairs to Asbestos Lagging/Insulation. Exposed asbestos thermal insulation poses a danger to personnel who may breathe in the airborne fibers. Damaged asbestos insulation shall not be left unattended. Corrective measures include:

- a. Application of ARABOL (MIL-A-3316) for minor insulation damage.
- b. Use of aluminized fibrous glass to protect insulation in high traffic area.
- c. Use of chafing gear and other protection to reduce damage.
- d. Training work center or work party personnel who may be contributing to excessive insulation damage.
- e. Alerting all shipboard personnel to report any insulation damage.

29.4.3 Removal of Asbestos Lagging/Insulation.

- a. If removal of asbestos lagging is required to carry out equipment repairs, request that the Type Commander arrange for a special asbestos handling team. The team will be assigned from either an FMA or contractor, depending on the size of the job.
- b. If the ship is away from its home port and damage occurs, remove minor areas of defective asbestos insulation using the methods specified in reference (a). Ship's Force must be made aware of the health hazards involved in removing asbestos, and know the measures required for personnel safety.
- c. To simplify cleanup and reduce health hazards from dust, collect any debris from removed asbestos lagging in containers, in accordance with the requirements of reference (a).

APPENDIX A
INSPECTION GUIDE FOR EXCESSIVE HEAT

1. Insulation.
 - a. Visually check piping, lagging pads, and bulkhead insulation for:
 - (1) Deteriorated (crushed or frayed) lagging or pads.
 - (2) Wet or oil soaked lagging or pads.
 - (3) Missing pads. This is also a burn hazard!
 - (4) Surface temperature.
2. Valves.
 - a. Visually check valves for:
 - (1) Leaking bonnet or spiral wound metal gaskets.
 - (2) Proper packing adjustment.
 - (3) Damaged or worn valve stems.
 - (4) Proper lagging.
3. Boiler Casing Joints.
 - a. Visually check casing for leaks.
4. Drains.
 - a. Visually check steam drains for leakage and system misalignment.
 - b. Check funnel drains for overflow conditions or missing contamination covers.
 - c. Periodically check orifice plates for oversize conditions.
 - d. Inspect for leaking or bypassed steam traps.
5. Bilge Levels.
 - a. Dry bilges. Visual, no water present.
 - b. Wet bilge. Visual, minimize bilge levels to control humidity levels.
6. Deck Plates.
 - a. Ensure proper deck plate types (solid or open grate) are in place. Ensure proper airflow pattern.
7. Ventilation.
 - a. Visually inspect for system cleanliness in accordance with reference (d). Particular attention shall be paid to clogged exhaust screens, dirty ventilation ducting, missing or mutilated ductwork and misdirected terminals.
 - b. Check system for breaks or openings due to corrosion. The system must be intact to deliver the proper velocity (minimum 250 Cubic Feet per Minute at each station). Check for closed or partially closed "Circle William" dampers and inoperative fan motors and controllers.
 - c. Main spaces should have a negative air pressure differential of 1/4" to 1/2" (water) with supply and exhaust systems running at normal settings.

(This Page Intentionally Left Blank)

VOLUME VI
CHAPTER 30
PORTABLE TOOL ASSISTANCE PROGRAM

30.1 PURPOSE. To provide guidance in the acquisition of portable tools, not normally carried onboard ship, and the priorities for loaning these tools to a ship in an availability.

30.2 PORTABLE TOOL INVENTORY POLICY. Shipboard preservation conducted during a Chief of Naval Operations Maintenance Availability requires an inventory of power tools beyond a ship's daily needs or normal allowance. Ships in Naval industrial activities can borrow the necessary tools directly from the activity's tool inventory under the Fleet Support Program. Such service is not routinely available to ships undergoing availabilities in a private industrial activity, because the private activity cannot legally be funded to perform this function. For ships undergoing availabilities in private facilities, tools are available in varying degrees from most Fleet Maintenance Activities (FMA).

30.2.1 Distribution Priorities. The FMAs should maintain an adequate inventory to meet anticipated needs of assigned ships. When the demand exceeds the availability, the distribution of portable tools will be based on the following priority:

- a. Priority I - Ships in availabilities in private industrial activities.
- b. Priority II - Ships in Fleet Maintenance Activity Availabilities.
- c. Priority III - Ships in availabilities in Naval industrial activities.
- d. Priority IV - All other ships.

30.2.2 Borrowing Procedures.

- a. The borrowing unit advises the lending FMA of the type, quantity, and date tools are required and the scheduled availability completion date.
- b. FMA personnel assemble a tool package in the variety and quantity requested.
- c. When the tools are picked up, an inventory receipt must be signed by an authorized representative from the borrowing command. The borrowing unit is financially responsible for the tools.

30.2.3 Borrowing Ship's Responsibilities.

- a. The borrowing unit is financially responsible for the tools.
- b. Routine maintenance (electrical safety check, fitting replacement, etc.) must be accomplished by the borrowing command.
- c. Tools and equipment must be returned promptly upon job completion or no later than the due date.
- d. Upon return and inspection of the tools, charges will be levied to the borrowing ship as follows:
 - (1) Lost Tools (to include tools not returned when due). Ships that fail to return tools when due will be reminded by letter or message that they have overdue tools. If no response is received within 30 days, the ship will be charged for the missing tools.
 - (2) Damaged tools (to include missing parts).

(This Page Intentionally Left Blank)

VOLUME VI

CHAPTER 31

SURFACE FORCE SHIP MAINTENANCE PLACEMENT
AND OVERSIGHT BUSINESS RULESREFERENCE.

- (a) NWP 1-03.1 - Naval Warfare Publication Operational Report

LISTING OF APPENDICES.

A RMC Spotlight Reports

31.1 PURPOSE. The purpose of this chapter is to provide procedures and guidance regarding ship maintenance placement and oversight business rules. These procedures and guidance affect Regional Maintenance Centers (RMC), Type Commanders (TYCOM) and Ship Maintenance Teams.

31.2 BACKGROUND. Current directives demand a culture of readiness. The process described here addresses the need for a flexible maintenance support system that increases efficiency without compromising effectiveness, and defines a common planning process for ship maintenance and modernization. These processes need to be disciplined with objective measurements and institutionalized with a continuous improvement methodology.

31.3 SHIP MAINTENANCE FUNDING MANAGEMENT BUSINESS RULES.

31.3.1 Scope. The goals of the entitled funding process are to reduce premiums paid for maintenance while simultaneously improving the ability to respond to maintenance and operational requirements. The funding business rules establish the central role of the Ashore Ship's Maintenance Manager working with the ship's Commanding Officer to manage the funds required to support all maintenance for a given ship. Starting with the submission of an overall Maintenance and Modernization Business Plan (MMBP), the Ashore Ship's Maintenance Manager will establish the quarterly distribution of controls from the established annual maintenance target needed to accomplish the ship's maintenance in the most efficient manner. The process provides the ship with a level of funding stability that will provide for the execution of an effective maintenance plan.

31.3.2 Ship and Maintenance Team Business Responsibilities.

- a. Each ship's Maintenance Team is led by the Ashore Ship's Maintenance Manager. The Ashore Ship's Maintenance Manager coordinates with the RMC to execute maintenance in accordance with Fleet and TYCOM maintenance policies and directives. The TYCOM shall ensure that each ship's Business Plan is tailored to fit unique geographic and business climate situations.
- b. The Maintenance Team (primarily the ship's Commanding Officer working with the Ashore Ship's Maintenance Manager) supports the Fleet Maintenance Officer and TYCOM in identifying budget needs based on well documented requirements in the Current Ship's Maintenance Project (CSMP), the Class Maintenance Plan, the Baseline Availability Work Package, the class Technical Foundation Paper and historical data. The Ship's MMBP identifies the total funding budgeted to support the ship during the execution year, along with advance planning funding for availabilities to be executed in future years. The TYCOM determines how much of the Ship's MMBP they can fund (controls) of the total requested, and how much money per quarter (phasing plan) they can provide for executing the Ship's MMBP. The following guidelines are not all inclusive but should be considered when structuring the phasing plan:
 - (1) The Maintenance Team will receive their actual spending levels or controls from the TYCOM. The RMC, with the TYCOM's approval, may adjust controls between maintenance teams as required during the course of the execution year. The goal is to establish controls before the execution year starts and then maintain these controls fixed throughout the execution year.
 - (2) The Maintenance Team provides the RMC and TYCOM with a quarterly spending or phasing plan based on their Ship's controls. The plan should be consistent with the ship's operational cycle and predefined maintenance periods. For example, deployments and underway periods in a given quarter should cause the displacement of Continuous Maintenance (CM) controls to other quarters where the maintenance is likely to occur.

- (3) Funds will be provided to Maintenance Teams early enough to avoid premiums associated with late contract award, definitization or assignment of work.
- c. Significant deviations from the final negotiated MMBP or controls will be documented in a Summary of Events. It is recognized that the drivers for MMBP changes are often outside the direct control of the Maintenance Team and will be documented as such. The fundamental guidelines for executing at MMBP financial control levels are:
 - (1) Follow the guidance in Volume II, Part II, Chapter 1 of this manual regarding screening and brokering of work candidates.
 - (2) During the execution of an availability, growth and new work should be authorized only if the Business Case Analysis indicates that this is the best course of action, taking into consideration all applicable business and operational risks and factors.
- d. The Maintenance Team, with the TYCOM's approval, may shift controls between the Chief of Naval Operations (CNO) availability and CM budget lines in order to most efficiently accomplish required maintenance and modernization. No more than 25% of the CM controls for an individual ship shall be moved to the CNO availability without TYCOM approval.
- e. The Maintenance Team shall schedule continuous maintenance availabilities per Volume II, Part II, Chapter 2 of this manual. Adjustment of Continuous Maintenance Availability dates shall be coordinated with the RMC and requested from the Immediate Superior In Command via naval message. Date changes shall be minimized in order to realize the maximum benefit from advance planning work. The Maintenance Team may not change CNO availability dates. The Maintenance Team shall resolve CNO availability scheduling issues with the TYCOM via the RMC. The TYCOM shall include Program Executive Office (PEO) Ships in any discussions resulting in availability date changes when Program Alterations are scheduled for the availability.
- f. The Maintenance Team shall review proposals for fair and reasonable costs, work scope and applicable technical aspects prior to the Technical Analysis Report (TAR) process.
- g. The Maintenance Team has the authority to adjust the MMBP in response to changes in ship operations, planned maintenance periods, and other business case reasons provided the intended distributions do not exceed the total remaining annual budget requirement allocated for that ship. This redistribution will be documented via a revised quarterly phasing plan, a Summary of Events prompting the change, and a formal recovery plan, which will be submitted to the TYCOM via the RMC for approval and adjustment of the Maintenance Team controls. Over the course of the fiscal year, some minor adjustments to the phased funding requirement can be expected. The cognizant RMC, with approval from the TYCOM, will establish funding redistribution limits below which a formal recovery plan would not be required, however, the revised quarterly phasing plan and Summary of Events would still be needed for approval. Ship's Commanding Officers shall ensure that their Immediate Superior In Command is advised of any proposed changes to their MMBP which may affect operational schedules or planned modernization.
- h. The Maintenance Team may not unilaterally adjust the MMBP when the adjustments would exceed the total remaining funding controls allocated for the ship. Any requirement in excess of the total MMBP currently approved will require the submission of a revised quarterly phasing plan, a Summary of Events related to the change, and a formal recovery plan. The RMC will evaluate the increased requirement and will make their recommendation for approval to the TYCOM based on total controls available. The RMC may not exceed an individual ship's total funding controls.
- i. Depot level maintenance will normally be screened to the Private Sector Industrial Activity (PSIA) contractor. The Maintenance Team may go to other contracting vehicles when:
 - (1) The PSIA contractor and government cannot agree on cost and scope.
 - (2) The PSIA contractor does not have the capability or capacity.
 - (3) Indefinite Delivery, Indefinite Quantity/Commercial Industrial Services (or Simplified Acquisition Purchases and a qualified vendors list) is available.

- (4) Other organic RMC assets are available and have the capability for the work.
- (5) Work is to be accomplished outside of homeport area.
- (6) Work is to be accomplished by an Alteration Installation Team (AIT).
- j. During the execution of a maintenance availability, it is anticipated that deficiencies will be identified that could be accomplished as either growth or new work on the existing contract. The Maintenance Team shall perform a Business Case Analysis to decide whether or not to add the work to the current availability or schedule it during another maintenance opportunity.
- k. When work deferral reduces the total cost of the job or maintenance completes with a cost under-run and funds can be recaptured, the funding controls will normally remain under the control of the respective Maintenance Team. If the funds are needed for critical work on another ship or to cover a funding shortfall at the TYCOM/Fleet level, the TYCOM will redistribute as necessary. The change will be documented in a revised quarterly phasing plan and the Maintenance Team(s) should provide to the RMC an impact statement and recommended plan to mitigate the effects of the plan change.
- l. The RMC coordinates with the Maintenance Teams to comply with their approved ship's MMBPs. The RMCs shall make a monthly MMBP execution report to the TYCOM.
- m. Maintenance Teams will issue funds to the appropriate executing activity by submitting a planning estimate to the TYCOM (via the RMC) and the TYCOM will issue the actual funding document.
- n. PSIA contractors normally submit cost reports to Maintenance Teams on a bi-weekly basis. The Maintenance Team will utilize these reports to assess the cost performance of the PSIA contractor and address items of concern to the RMC and/or TYCOM.

31.3.3 Regional Maintenance Center Business Responsibilities.

- a. The RMC Commander has the authority to execute Surface Force Ship maintenance and shall do so in accordance with Fleet and TYCOM policies and directives.
- b. The RMC Commander develops an execution year spending plan for the TYCOM's approval based on the TYCOM approved MMBPs.
- c. The Fleet Commander spending controls are issued to the TYCOM who then assigns spending controls to each Maintenance Team, informing the RMC. The RMC issues quarterly spending controls to all of the Maintenance Teams in accordance with the TYCOM's final TYCOM approved MMBP for each ship.
- d. The RMC Commander will evaluate MMBP adjustment requests based on the Summary of Events, recovery plan, and quarterly adjustment provided by the Maintenance Teams. If the RMC supports the request, the RMC will forward the issue to the TYCOM for approval.
- e. The RMC Commander shall request approval from the TYCOM whenever redistribution of annual ship funding is required. The RMC shall provide the TYCOM a record of all control changes for tracking purposes. Redistribution of funds between Active Fleet and Reserve Fleet funding lines or between different TYCOMs requires approval by the Fleet Commander.
- f. In the event of significant program wide control changes the RMCs shall:
 - (1) Provide an impact statement to the TYCOM regarding the effect on the execution of maintenance.
 - (2) Provide a recommendation to minimize the impact on Force readiness.
- g. The RMC shall evaluate the financial status of each of the Maintenance Teams on a monthly basis.
- h. The RMC shall submit monthly financial summary reports to the respective surface TYCOM. This report provides a comparison of actual versus planned funding execution. The last report for the execution year will include an annual summary showing how the funds were utilized, sorted by Naval Operations resource sponsor.

- i. C3/C4 Casualty Reports (CASREP), or a C2 CASREP with reasonable potential to become a C3/C4 CASREP, are identified as emergent maintenance and will be funded with emergent dollars. Emergent work will be scheduled to minimize premiums in as much as the operational schedule will permit. C2 CASREPs will normally be corrected using the CM Process. Consideration will be given to schedule all maintenance, including emergent, at an opportune time to reduce premiums. The RMC Commander may, with the respective TYCOM's prior approval, convert Emergency Maintenance funds to execute CNO availability or CM maintenance.
- j. Except as stated in paragraph 31.3.3i. of this chapter, C2 CASREPs will be corrected during CM periods (both scheduled Continuous Maintenance Availabilities and maintenance Windows of Opportunity) using CM funds. C2 CASREPs discovered during a CNO availability or Continuous Maintenance Availability will be addressed as new work. C2 CASREPs may be allowed to "age" until the appropriate repair opportunity. The RMC Commander has the responsibility to request TYCOM authorization when Emergency Maintenance funds should be used for the correction of C2 CASREPs or other non-CASREP related, but nonetheless urgent maintenance. The RMC is required to approve any planned delay of action on a CASREP. In the event that the delay effectively constitutes a CASREP deferral in accordance with reference (a), the RMC will forward the deferral recommendation to the TYCOM for approval.
- k. The RMC Commander will generate monthly maintenance availability metrics for all assigned ships planning for a CNO availability and ships in a CNO availability. These metrics will be briefed at least monthly to the TYCOM at Surface Team 1 Maintenance and Modernization Continuous Improvement Team meetings. The business rules for preparation of these forms are included in Appendix A.

31.3.4 Type Commander Responsibilities.

- a. The TYCOM establishes Force maintenance policies and directives, consistent with Fleet Commander guidance, and authorizes the Maintenance Team and RMC to act as the principal agent to execute those policies and directives.
- b. The TYCOM will provide a list of Fleet Alteration requirements for the execution year as input to the ship's business plan no later than 15 February in the year prior to execution. To assist with business plan development, the TYCOM will identify which alterations are scheduled for accomplishment and will provide the Maintenance Team and RMC with the cost estimates for accomplishment.
- c. When the Fleet issues the spending controls to the TYCOM, the TYCOM will in turn issue spending controls to the RMC and update those spending controls on a quarterly basis.
- d. The TYCOM has the authority to recapture spending controls previously issued to the Maintenance Teams and RMCs in response to unforeseen Force budget requirements. This will be used as a last resort, as the goal is to maintain stable funding plans in support of ships' MMBPs.
- e. If it is determined that the best course of action is not to fund a CNO availability, the TYCOM must (with concurrence from United States Fleet Forces or Commander, Pacific Fleet, whichever is appropriate) approve the removal of funds before the RMC initiates this action. The TYCOM shall ensure PEO Ships is included in the decision process to not fund any availability where Program Alterations are scheduled for accomplishment during that availability.
- f. The TYCOM will evaluate MMBP adjustment requests forwarded by the RMC based on the Summary of Events, recovery plan, and quarterly adjustment provided by the Maintenance Team. If the TYCOM supports the request but lacks spending "controls" required, the TYCOM will forward the issue to the Fleet for approval and additional controls.
- g. The TYCOM will evaluate the RMC's end of month financial status reports to assess the degree of conformance to the approved RMC consolidated spending plan.

31.4 MAINTENANCE PROPOSAL REVIEW. The maintenance process must be flexible enough to be able to respond to changing operational requirements. The key to this flexibility is to reduce the cycle time involved prior to the actual execution of the maintenance. The Continuous Estimating, Incremental Planning Review Process

guidelines will be utilized by the Maintenance Team to approve all proposed maintenance actions within time and budget constraints. The guidelines apply equally to Advance Planning, Long-Lead-Time Material, CNO, CM and Emergent Maintenance work.

31.4.1 Concept. The entitled process concept enables the Maintenance Team to review planned work items and estimates on a continuous basis as they are received. The Ashore Ship's Maintenance Manager is empowered to shift work items from CNO to CM or vice versa to optimize work scheduling and reduce premium exposure and overall cost.

31.4.2 Business Rules.

- a. The Ashore Ship's Maintenance Manager with support from the Maintenance Team shall analyze the work package against the availability schedule. In general, Maintenance Teams should consider scheduled availability lengths fixed and attempt to adjust the work package to ensure it can be completed within the scheduled dates. When justification exists, the Maintenance Team should recommend availability length adjustments to the TYCOM to minimize premiums.
- b. The Ashore Ship's Maintenance Manager with support from the Maintenance Team shall analyze the work package against potential CM windows of opportunity to maintain the scheduled dates of the availability, to best level load the contractor, and to minimize premiums.
- c. The Maintenance Team may not change CNO availability dates and shall resolve scheduling issues with the TYCOM via the RMC. The TYCOM shall include PEO Ships in any discussions resulting in availability date changes when Program Alterations are scheduled for the availability.
- d. Work packages shall be developed on a continuous basis in order to realize cost savings and avoid premiums associated with late identification of work in accordance with the business rules contained in Volume II, Part II, Chapter 2 of this manual.
- e. When capability and capacity allow, work shall be brokered to the Fleet Maintenance Activity, otherwise, Depot level maintenance will normally be screened to the PSIA contractor. The Maintenance Team may go to other contracting vehicles when:
 - (1) The PSIA contractor and government cannot agree on cost and scope.
 - (2) The PSIA contractor does not have the capability or capacity.
 - (3) Other organic RMC assets are available and have the capability for the work.
 - (4) Work is to be accomplished outside of homeport area.
 - (5) AIT/Indefinite Delivery, Indefinite Quantity has been identified by the Naval Supervisory Authority (NSA) as the preferred provider.
- f. The Maintenance Team shall review proposals for fair and reasonable costs, work scope and applicable technical aspects prior to the TAR process.

31.4.3 Continuous Estimating Incremental Planning Review Process. The Continuous Estimating Incremental Planning Review Process (CEIPRP) is the process by which the Maintenance Team continuously compares PSIA contractor work item estimates to independently developed government work item estimates throughout the development of the work package. Completion of package development and submission of the 100% Work Package Proposal is followed by the Technical Cost and Scope analysis, proposal revisions, TAR, establishment of the Prorate, Pre- and Post Business Clearance, and signing of the bi-lateral contract modification (definitization).

31.4.3.1 Concept. Use of the CEIPRP is intended to achieve flow of work items into the work package up to 100% lock while continuously comparing government to contractor estimates to avoid last minute surprises due to estimate differences. This process also allows for flexibility up to the 100% lock in order to develop a package that best addresses the material condition of the ship as it begins the availability. Following the planning activity specification development, the PSIA contractor continuously submits a Class C Planning Estimate. Simultaneously, the government Maintenance Team continuously develops the Independent Government Estimate (IGE). These two estimates are then compared and any differences in scope and price (generally those in excess of 10% difference) are resolved. Resolving these differences during work package development also reduces the

amount of time required for the TAR process. Following the 100% package lock, the planning activity completes planning, the PSIA contractor assembles and submits the 100% package proposal. Based on the 100% package proposal, an estimate of prorates is communicated to resource sponsors along with a final funding notification (as early as possible but no later than 14 days prior to the need date) in order to ensure on-time funding. This is followed by accomplishment of the TAR and business clearance processes.

31.4.3.2 Business Rules.

- a. The contractor shall continuously submit Class C estimates for each work item as a bottom line work item cost. The Planning Estimate provides a budget level tracking and establishes a basis for determining cost reasonableness. Paragraph cost estimates will be provided by the PSIA contractor when requested by the government to resolve differences between the contractor's Planning Estimate and the IGE.
- b. The IGE is the government's detailed estimate to the trade and paragraph level. The IGE provides budget level tracking and establishes a basis for determining cost reasonableness allowing the government to validate the Planning Activity Estimate and resolve any differences in scope or cost estimates.
- c. The package will be assessed at the 50% and 80% budget to ensure that work has been brokered to planning activities continuously. These milestones also reinforce timely identification of work by Ship's Force. Following the 50% and 80% milestones, the planning activity will complete planning and estimating for all work brokered to date.
- d. Upon completion of the Planning Activity Estimate, that estimate will be compared to the IGE to gage whether the government and the Planning Activity are estimating a similar scope of work. If the individual work item Class C estimates vary by more than 10% or \$10,000 (whichever is higher), the government Program Manager will establish a scoping conference to discuss/resolve the scope of work.
- e. The 100% package lock is the official milestone to mark identification of 100% of the work requirements for an availability based on the MMBP budget. All work added to or deleted from the package after the 100% lock will be via an errata, addendum or inducted as new work via the Request for Contractual Change Process.
- f. The Final Funding Notification with Estimates of Prorates will be a formal communication with resource sponsor (Email or Naval Message) with funding requirements. Estimate prorates based on Basic Work Package Proposal man-hour estimates, historical prorate data and sponsor requirements. The Maintenance Team should ensure that estimates provided to various sponsors throughout the planning process include anticipated prorate amounts.
- g. The TAR will include all necessary information to develop a negotiation strategy, pricing recommendation and rationale to support a scope conference, if necessary, and subsequent work package cost definition. It shall include background information, essential contractor proposal information, method of evaluation, scope of work, analysis of work items with rationale to support questionable costs and summary of pricing recommendations.
- h. A scoping conference, if necessary, shall include the appropriate members of the Project Team, Technical Analyst, Administering Contracting Officer (ACO) or Contract Negotiator and contractor. All work items with unsubstantiated differences identified in the TAR are discussed to reach agreement on the scope of work and contractor's proposal. When all differences have been resolved, the conference shall end with an agreement on labor hours, subcontracts and materials between the contractor and ACO or Contract Negotiator.
- i. The ACO or Contract Negotiator will take the work scope conference results and ensure correct application of indirect rates, fees and prepare appropriate documentation for signature and cost definition.
- j. The ACO representative will negotiate target costs for new work.

- k. The Project Team will minimize growth and overtime. Prior to definitization, growth items that cannot be settled by the Project Team shall be forwarded to the Technical Analyst to be settled in the TAR process. For Surface Force ships only, the NSA Chief Engineer will review requested growth and new work items for technical compliance.

31.4.3.3 Schedule Modification. Operational commitments, port loading or other reasons may require modification to availability schedules and milestones may need to be adjusted accordingly as discussed in further detail in Volume II, Part II, Chapter 2, paragraph 2.5 of this manual.

31.5 GUIDANCE FOR FIRM FIXED PRICE CONTRACTS.

31.5.1 Overall Process. Unless specifically noted otherwise, the following are common practices in both the PSIA and Firm Fixed Price (FFP) contracting environments:

- a. Validation, screening, and brokering process.
- b. Maintenance Teams.
- c. Planning Board for Maintenance.
- d. MMBPs.
- e. Movement of work between CNO and CM.
- f. Maintenance Team metrics.

31.5.2 Firm Fixed Price Planning. Government activities shall accomplish FFP planning with the goal of compiling a complete, clear, concise and well-defined work package. The Ashore Ship's Maintenance Manager shall work with the Maintenance Team to define the work scope and solicitation in a FFP environment. The following points shall be considered in the planning process for FFP contracts:

- a. Assessments are an important part of the planning phase of any availability. The Ashore Ship's Maintenance Manager shall ensure assessment results are considered for inclusion into the work package. The Ashore Ship's Maintenance Manager shall also determine if additional assessments should be accomplished so that the material condition of critical systems and equipment can be determined prior to the work package lock date.
- b. Proper work screening between CNO and CM availabilities is critical in order to reduce costs and premiums.
- c. Work placed in a CNO FFP Availability should be limited to work requiring a facilitated shipyard, work that can not be accomplished in short CM availabilities, or work that must be accomplished in the availability to support operational readiness.
- d. When work, following the guidelines identified in paragraph 31.4.2b. of this chapter, cannot be accomplished in the designated time period without excessive premiums or with a low probability of success, the RMC Commander shall be informed. Conversely, the RMC Commander shall also be informed when there is insufficient work to justify a CNO availability.
- e. The use of proven, re-useable FFP work specifications by Maintenance Teams and planning activities should be the norm, not the exception.
- f. Ashore Ship's Maintenance Manager with assistance from the Maintenance Team shall review all contract work specifications prior to issue, and specification review changes shall be recorded and tracked by the planning activity.

31.5.3 Firm Fixed Price Placement. When building the availability package in preparation for contract placement, consideration shall be given to risk mitigation to avoid premiums during execution due to late work identification. The use of Reservations and Option Items builds in flexibility to FFP contracts when it is impossible or impractical to adequately define all requirements.

- a. Option Item guidelines:

- (1) Option Items are to be utilized in a contract solicitation when there is a strong expectation the work will be accomplished if the prerequisite conditions requiring the work are met as a result of an event, inspection, or milestone.
 - (2) Prior to solicitation, the availability schedule shall be evaluated to ensure each Option Item can be accomplished during the contract performance period.
 - (3) Material status shall be confirmed to ensure Option Item material will be available to support the production schedule.
 - (4) Funding for Option Items will be managed by the Project Manager within the ship's designated annual funding allowance under their MMBP, by either designating Reservations in the availability budget or by using CM funds.
 - (5) Option Items shall be invoked as early as possible, preferably during the period between contract award and the start of the availability. The later an option is exercised, the greater the probability that premiums will be paid for its execution.
 - (6) A listing of all Option Items, including their respective "Not Later Than" invocation dates, shall be provided to the RMC by the planning activity in the turnover letter. The Project Manager must be made aware of all Option Items and invocation dates well in advance of the availability start date. (The Maintenance Team provides the Option Items and invocation dates. This is discussed in the contract solicitation review board.)
 - (7) Option Items are not to be used as a "shopping list", and are reserved for work with a high expectation of being required. Lack of funds for a specific work item shall not be used as justification for including that work as an Option Item.
- b. During FFP solicitation, bidder's questions may be submitted to the Procurement Contracting Officer. The following processes related to bidder's questions should be followed:
- (1) The Maintenance Team shall not respond directly to bidder's questions. There must be a single point of contact for bidder's questions and answers. If queried directly, the Maintenance Team shall refer the bidder to the Advance Planning Manager.
 - (2) The RMC Procurement Contracting Officer shall ensure the Maintenance Team is provided with e-mail notification of all bidder's questions.
 - (3) The Maintenance Team shall provide inputs to bidder's questions to the Procurement Contracting Officer within 24 hours (unless the response is required immediately, or another time period is agreed upon).
 - (4) The Maintenance Team input shall be considered when formulating the Government's response.
 - (5) The final answer to bidder's questions shall be made available to the Maintenance Team via e-mail or other electronic means.
- c. FFP Oversight. During FFP availability execution, oversight of contract changes is critical to managing costs and reducing premiums. Processes that assist in the management of funds and reduction of premiums include:
- (1) Conduct a business case for all growth and new work to determine the most efficient and cost effective time to execute the work.
 - (2) Recognize that late work premiums exist, and account for these premiums when it is necessary to add growth or new work to the availability.
 - (3) The RMC Project Manager shall identify and record all validated Delay and Disruption charges paid by the Government using growth codes as a result of Navy actions. Discuss each Delay and Disruption event during Planning Board for Maintenance to prevent repeat occurrences.

- (4) Project Manager, with the Maintenance Team, shall document “lessons learned” during availabilities and provide these to the RMC for proper distribution and training of other Maintenance Teams.
- (5) Departure Reports shall be provided to the Maintenance Team, ensuring all applicable safeguards are in place to handle Business Sensitive Information.

(This Page Intentionally Left Blank)

APPENDIX A
RMC SPOTLIGHT REPORTS

1. **PURPOSE.** Establish guidelines for preparing an RMC Spotlight Presentation. This presentation is applicable to all ships undergoing planned (CNO/CMAV) availabilities.
2. **SCOPE.**
 - a. This business rule describes the format and processes required to compile an RMC Spotlight Presentation.
 - b. Applies to all Regional Maintenance Centers (RMC).
 - c. Implements the standardized process to be used by all RMCs.
3. **GENERAL REQUIREMENTS/BACKGROUND.**
 - a. The RMC Spotlight Presentation consists of six sections: Project Spotlight Chart, Premium Performance Chart, Package Build Chart, Hot Wash Status Report, and Global Hot Wash Data.
 - b. The Project Spotlight Chart is a snapshot of the planning milestone status and execution performance for the RMC's CNO availabilities. Examples of FFP and PSIA Spotlight Charts are given in this appendix.
 - c. The Premium Performance Chart is a snapshot of the performance with regard to premiums and churn for a specific ship in the execution phase of a CNO availability. An example Premium Performance Chart is given in this appendix.
 - d. The Package Build Chart is a snapshot of the relationship between the value of the work package, as it is being developed, to the planned and budgeted limits for a specific ship in the planning phase of a CNO availability. It is extracted from the budget tab in Navy Maintenance Database (NMD). An example Package Build Chart is given in this appendix.
 - e. The Hot Wash Status Report is a snapshot of an RMC's local and global Hot Wash issues from past CNO availabilities. An example Hot Wash Status Report is given in this appendix.
 - f. The Global Hot Wash Data Report provides amplifying information regarding current global Hot Wash issues. An example Global Hot Wash Data Report is given in this appendix.
4. **PROCESS.**
 - a. This appendix defines the RMC Spotlight Presentation, but additional slides may be included for amplification on a conservative basis. The RMCs shall comply with standard formats.
 - b. Project Spotlight Chart.
 - (1) The left column of the chart shall list all upcoming CNO availabilities for the port within the A-360 window and the next availability to reach A-360 at a minimum.
 - (2) The columns for the milestone will be populated and colored in accordance with the following guidelines:
 - (a) The top row contains the scheduled milestone date.
 - (b) The bottom row is populated with the actual date the milestone was accomplished.
 - (c) The top row is colored red/yellow/green (R/Y/G) after the milestone has been accomplished.
 - 1 Green – milestone met on schedule.
 - 2 Yellow – milestone 1-7 days late.
 - 3 Red – milestone >7 days late.

- (d) The bottom row is colored with a R/Y/G hash pattern depending upon impact to the next milestone. The bottom row is only colored for accomplished milestones and the follow-on milestone. It may be acceptable to color a future milestone if there exists substantial evidence that it will not be accomplished on time and will have a significant impact on the follow-on milestone.
 - 1 Green hash – next milestone will be met.
 - 2 Yellow hash – moderate risk for next milestone.
 - 3 Red hash – high risk for next milestone.
- (3) Comment blocks/balloons may be used to provide amplifying information as necessary.
- c. Premium Performance Chart.
 - (1) The Premium Performance Chart is developed by exported data from NMD to an Access database. Commander, Navy Regional Maintenance Center metrics division is the point of contact for the procedure.
 - (2) Premium Performance Charts are ordered in the sequence listed on the Project Spotlight Chart.
 - (3) Comment blocks/balloons may be used to provide amplifying information as necessary.
- d. Package Build Chart.
 - (1) The Package Build Chart is developed with the package build data from NMD. The information is available in the planning side of NMD under planning budget.
 - (2) Package Build Charts are ordered in the sequence listed on the Project Spotlight Chart.
 - (3) Comment blocks/balloons may be used to provide amplifying information as necessary.
- e. The Hot Wash Status Report is maintained by the RMC Hotwash Coordinator.
- f. The Global Hot Wash Data Report is to include the following, at a minimum, for the reporting period in which input is received:
 - (1) Discussion of best practices.
 - (2) Discussion of global issues including resolutions.
 - (3) Premium goal vs. actual (and if exceeded, an explanation as to why).
 - (4) Identification of premium drivers.

PROJECT SPOTLIGHT CHART													
SHIP/HULL	Scheduled CNO Avail Dates (Start/ Compl)	Controls \$M (TYCOM/ Program)	Issue HMP/ LOA incl AITs (Sched / Actual)	Task/Fund SID Developmt (Sched/ Actual)	Issue/ Deliver SIDs to NSA for Contractors and AITs (Sched/ Actual)	Provide Avail Funding for Modern. to RMC (Sched/ Actual)	PSIA 100% D-Lvl maint work pkg 2K's locked (Sched /Actual)	PSIA Contractor Publish pkg in NMD (Sched/ Actual)	PSIA Definitize Work Package (Sched/ Actual)	Actual CNO Avail Dates (Start/ Compl)	Churn Percent (TYCOM / Program)	Growth & New Work \$K (TYCOM/ Program)	Premium Percent (TYCOM/ Program)
			SPM/ NAVSEA/ TYCOM	SPM/NSA/ AIT/TYCOM RMC Mgr	Planning Yard	SYSCOM/ PEO/ TYCOM	MT	PSIA Contractor	RMC				
			A-360	A-330	A-180	A-75	A-75	A-60	A-45				
LEGEND													
	MILESTONE MET ON SCHEDULE												
	MILESTONE 1-7 DAYS LATE												
	MILESTONE >7 DAYS LATE												
	NEXT MILESTONE WILL BE MET												
	MODERATE RISK FOR NEXT MILESTONE												
	HIGH RISK FOR NEXT MILESTONE												

VI-31A-4

Premium Performance Chart

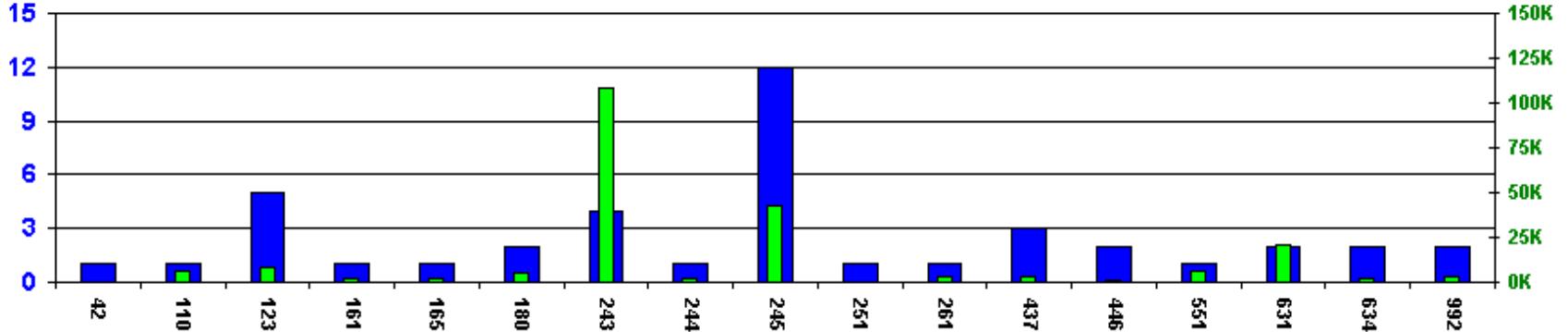
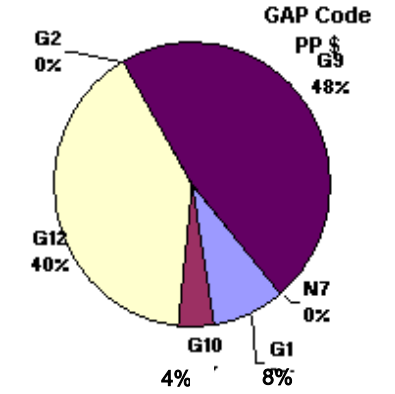
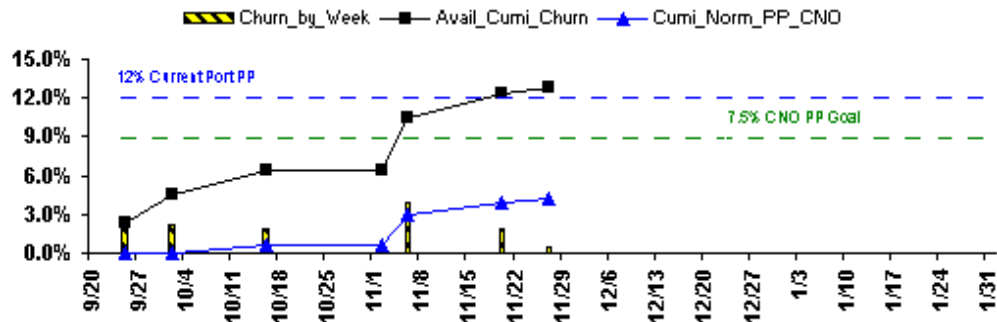
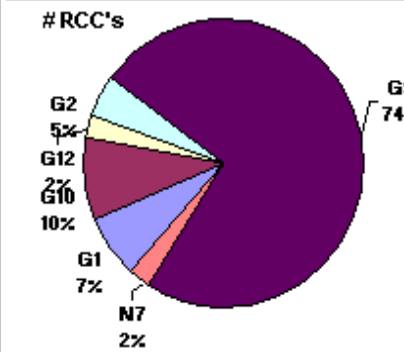
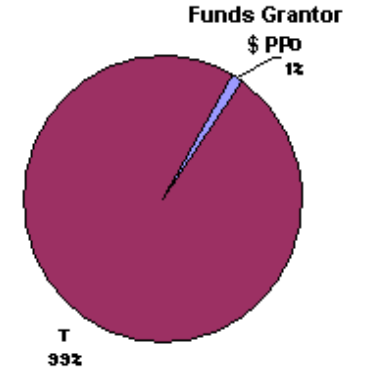
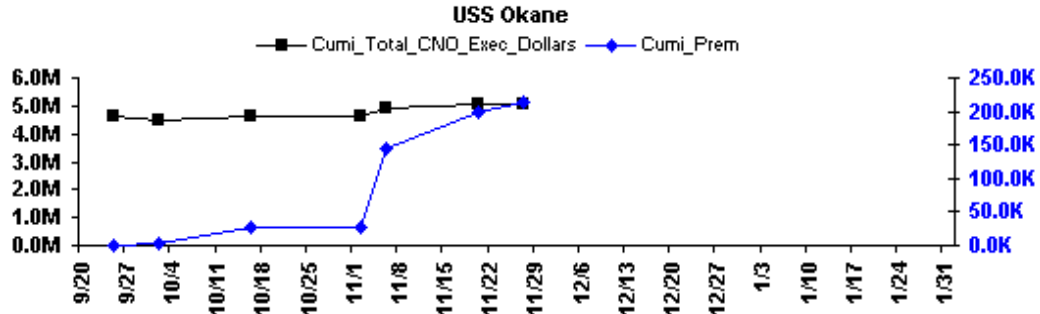
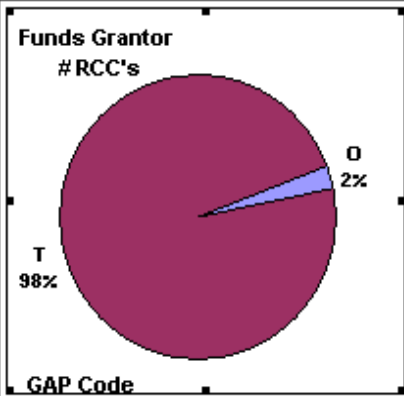

VI-31A-5

USS CRUISER Package Build Chart

9/05-1/06

VI-31A-6

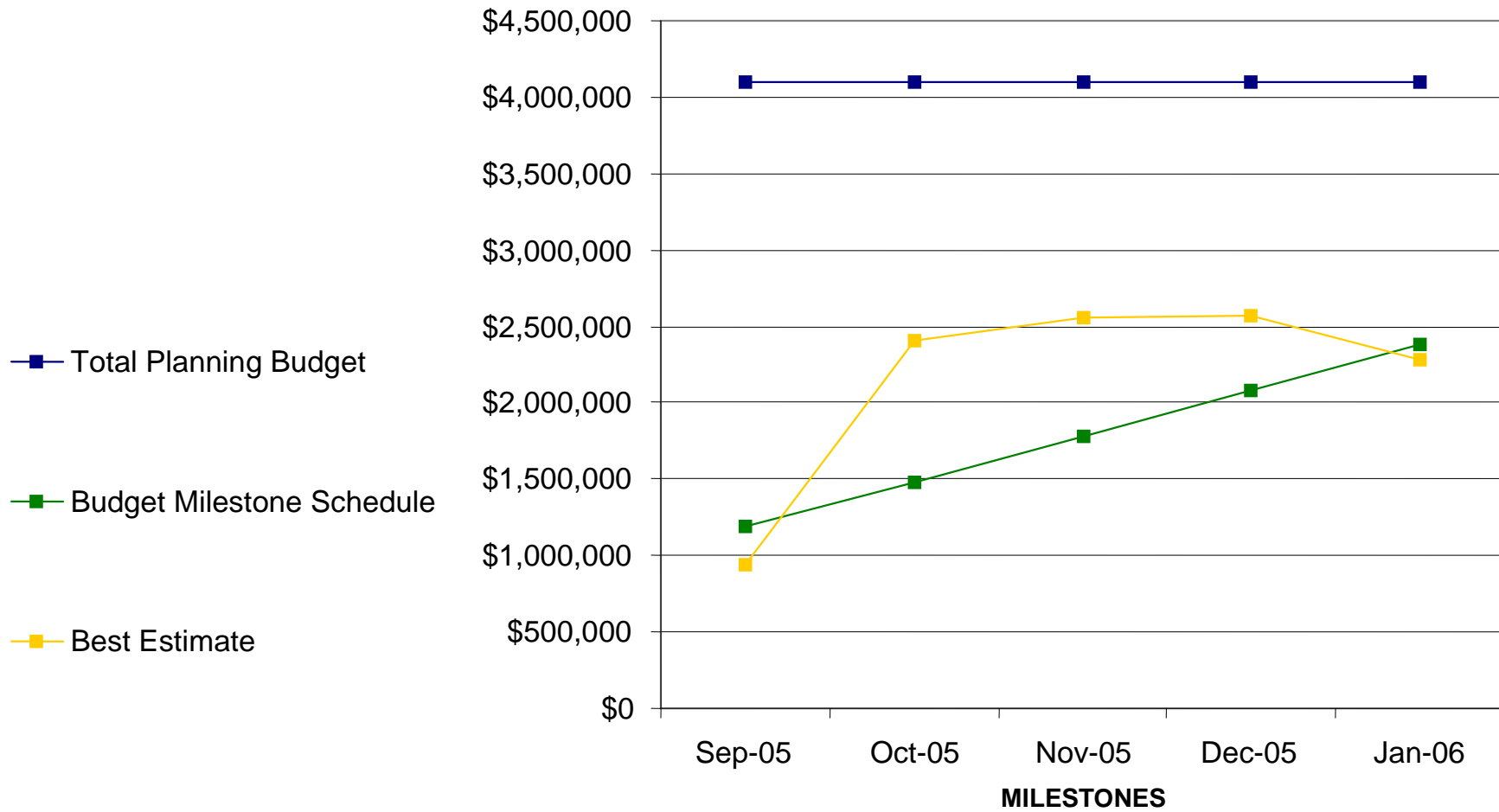

Hot Wash Status Report

HRMC FEEDBACK ISSUE METRICS									
Ship / Hull		USS PORT ROYAL (CG 73)	USS R JAMES (FFG 57)	USS RUSSELL (DDG 59)	USS CROMMELIN (FFG37)	USS SALVOR (ARS 52)	USS HOPPER (DDG 70)	Totals	Total Resolved
EOA		9/8/04	12/1/04	12/15/04	3/23/05	6/15/05	9/7/05		
HW Mtg Date		10/7/04	1/25/05	1/26/05	3/31/05	7/11/05	9/28/05		
Global Shipmain Issues	Req'ts (CFT1)	0	1	2	0	0	0	3	3
	PP/P&O CFT23	0	1	1	3	4	2	11	11
	Alts & Mods (CFT4)	1	1	3	0	0	5	10	10
	Total	1	3	6	3	4	7	24	24
Global Non-Shipmain Issues	Technical	0	0	0	0	0	0	0	0
	Modernization	0	0	1	0	0	0	1	1
	Project Team	0	0	0	0	0	2	2	2
	Total	0	0	1	0	0	2	3	3
Local Issues	Alts & Mods	2	0	0	1	2	5	10	5
	Modernization	0	0	0	0	0	0	0	0
	P&O	3	2	1	3	2	3	14	7
	Technical	0	0	0	0	3	0	3	2
	Req'ts	5	5	1	2	4	0	17	12
	Project Team	16	10	8	8	13	22	77	41
	Package Prep	5	4	2	2	5	1	19	12
Total	31	21	12	16	29	31	140	79	

VI-31A-7

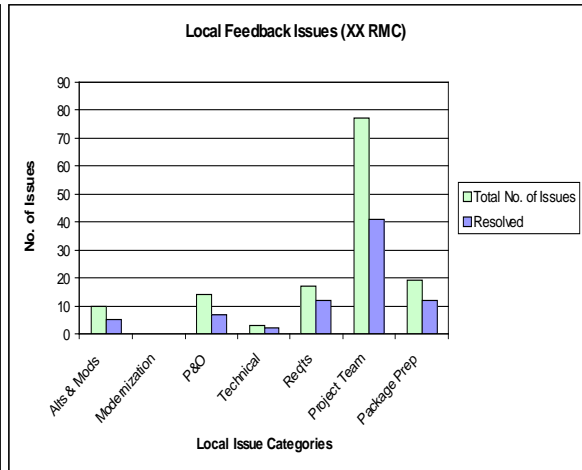
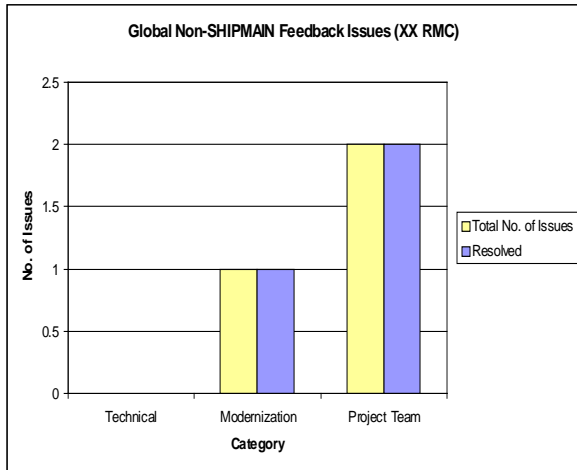
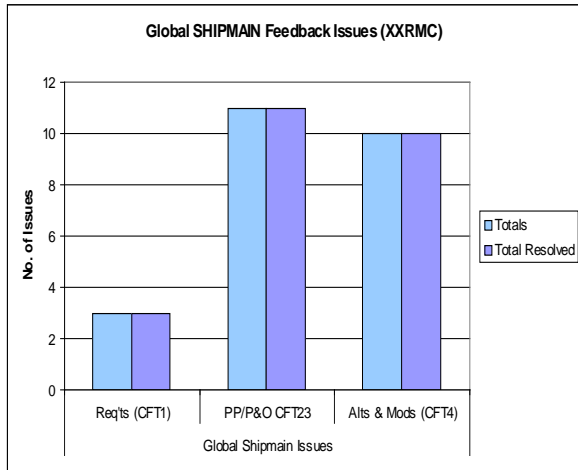

Global Hot Wash Data

Bullets include as a minimum:

- Discussion of best practices.
- Discussion of global issues.
- Premium goal vs. actual
(and if exceeded, an explanation as to why).
- Identify premium drivers.

VOLUME VI
CHAPTER 32
TOP MANAGEMENT ATTENTION
TOP MANAGEMENT ISSUES

REFERENCES.

- (a) OPNAVINST 4700.7 - Maintenance Policy for U.S. Naval Ships
- (b) OPNAVINST 3000.12 - Operational Availability of Equipments and Weapons Systems

LISTING OF APPENDICES.

A Top Management Attention and Top Management Issues Flowchart

32.1 PURPOSE. Reference (a) provides Chief of Naval Operations (CNO) Maintenance Policy for U.S. Navy Ships, which includes the Top Management Attention/Top Management Issues (TMA/TMI) program for addressing chronic maintenance problems. Commander, United States Fleet Forces Command (CUSFFC) is tasked with developing and forwarding Hull, Mechanical and Electrical (HM&E) and Combat System (CS) Technical Ticklers to identify common maintenance issues between Fleets. This chapter provides CUSFFC policy, procedures and standardized metrics for selecting systems/equipment for inclusion in the TMA/TMI process.

32.2 BACKGROUND. The TMA/TMI process is the Navy's priority corrective action process for United States Fleet Forces Command, Fleet Commanders, Type Commanders (TYCOM), Systems Commands (SYSCOM) and Office of the CNO (OPNAV) Resource Sponsors. This process is the means to identify top material readiness and cost problems and develop solutions that effectively and efficiently achieve approved levels of performance while realizing near-term returns on investment.

32.3 APPLICABILITY AND SCOPE.

- a. The TMA/TMI process encompasses all surface force, aircraft carrier and submarine installed equipment and systems, including aviation-oriented items that are integral parts of the ship. This process supports Navy goals and initiatives that improve fleet material readiness and increase the operational availability of those items that are identified by the fleet as needing primary attention and action. The TMA/TMI process excludes equipment under the responsibility of Director, Strategic Systems Programs and Director of Naval Nuclear Propulsion Program.
- b. The TMA/TMI process uses data from diverse sources to:
 - (1) Objectively identify critical fleet problems that impact material readiness, maintenance cost and manpower/skill requirements, and warrant top-level attention.
 - (2) Focus management attention and resources needed to correct these problems.
 - (3) Enhance communication among CNO Resource Sponsors, Fleet Commanders, TYCOMs and Systems Command Program Offices.
 - (4) Execute the TMA/TMI process in accordance with the TMA/TMI Process Flowchart in Appendix A.
- c. The TMA/TMI process is the Navy's priority corrective action process for Fleet Commanders, SYSCOMs and OPNAV Resource Sponsors. This process is the means for the Fleet, OPNAV, and SYSCOMs to identify top material readiness and cost problems and develop solutions that effectively and efficiently achieve approved levels of performance while realizing near-term Returns on Investment (ROI).
- d. The TMA candidate selection process uses a variety of sources including Maintenance and Material Management (3-M) data prepared by the TMA/TMI Analysis Center to objectively identify critical fleet HM&E and CS problems that impact material readiness, maintenance cost and manpower/skill

requirements and warrant top-level attention. Fleet and TYCOMs use this data to aid in the selection of their TMA/TMI candidate systems/equipment. Fleet and TYCOMs may also solicit topic input from subordinate Commanders for problems having significant negative impact on readiness.

- e. Candidate systems/equipment metrics are forwarded from the TYCOMs to Naval Sea Systems Command (NAVSEA) for inclusion in the TMA process. The candidate selection process is a semi-annual process commencing immediately after TMA Fleet Week and culminating at Mid-Cycle with the nomination of new systems/equipment.
- f. TMI topics are selected by the TMA panel from the topics presented at TMA which require flag level attention.

32.4 RESPONSIBILITIES.

32.4.1 Commander, United States Fleet Forces Command. CUSFFC Maintenance Officer (N43) is the Staff Officer responsible for implementation of this chapter and may direct HM&E and CS/equipment be included in the TMA/TMI process.

32.4.1.1 Duties. TYCOM Maintenance Officers shall:

- a. Develop TYCOM HM&E and CS Technical Ticklers and identify common issues between ships every six months. Establish a priority ranking of systems based on selected attributes (e.g., man-hours, cost, readiness). Forward TYCOM HM&E and CS Technical Ticklers to Commander, Naval Sea Systems Command (COMNAVSEASYSCOM) 05 for surface force ships. For submarines, provide TMA issues to COMNAVSEASYSCOM 07, with copy to OPNAV Resource Sponsors and other cognizant SYSCOMs as appropriate, via a coordinated/joint cover letter.
- b. Coordinate TMI Panel agendas and dates with TMA/TMI Working Group Chair(s).
- c. Participate on TMA panels and chair TMI Panels.
- d. Chairs the TMI panel at least annually either through established Enterprise Board of Directors meetings or as a separate TMI panel.
- e. Coordinate Fleet participation in the TMA and TMI process (TYCOMs and Regional Maintenance Center Supports).

32.4.2 Naval Sea Systems Command. NAVSEASYSCOM coordinates overall SYSCOM participation in the TMA. Specifically, SEA 07 coordinates the efforts for submarine platforms. SEA 05 coordinates efforts for surface and carrier platforms.

32.4.2.1 Duties.

32.4.2.1.1 Commander, Naval Sea Systems Command (05). COMNAVSEASYSCOM (05) for surface force ships and aircraft carriers shall:

- a. Form the TMA/TMI Working Groups and Panels and staff with appropriate representatives.
- b. Receive and disseminate the TYCOM HM&E and CS/C4I Surface Force Ship Technical Ticklers to the appropriate TMA/TMI Working Groups.
- c. Review and forward Plan of Action and Milestones and ROIs, or other technical presentations from TMA/TMI Working Groups to Fleet and TYCOMs.
- d. Chair the surface force ships and aircraft carrier TMI Panel and establish the NAVSEA response to Fleet identified TMI issues.

32.4.2.1.2 Naval Sea Systems Command 07/Program Executive Officer Submarines. SEA 07/Program Executive Officers (PEO) Sub shall:

- a. Form the TMA/TMI Working Groups and Panels and staff with appropriate representatives.
- b. Receive and disseminate the TYCOM HM&E and Nuclear Planning and Execution System TMA issue letter to the appropriate program offices for action.

- c. Review and forward Plan of Action and Milestones, Business Case Analyses or other appropriate technical presentations to Fleet and TYCOMs.

32.4.2.1.3 Commander, Naval Sea Systems Command Program Offices. COMNAVSEASYSCOM Program Offices (and Commander Space and Naval Warfare System Command for subparagraphs b. through f. of this paragraph) shall:

- a. Chair TMA Panels in accordance with paragraph 32.4.2.1.5 of this chapter.
- b. Participate on TMA and TMI Panels as requested.
- c. Develop Plan of Action and Milestones and Business Case Analyses to address TYCOM HM&E and CS Technical Tickler issues.
- d. Coordinate other activities as required to determine root causes and develop corrective actions.
- e. Review minutes from TMA and TMI Panels and take action as appropriate.
- f. Work with TYCOMs for resolution of HM&E and Nuclear Planning and Execution System Technical Issues and Action Items.

32.4.2.1.4 Program Executive Officers and Direct Reporting Program Managers. PEO and Direct Reporting Program Managers shall:

- a. Assign representatives to the appropriate TMA/TMI Working Groups.
- b. Chair the applicable submarine TMI Panels as described in paragraph 32.4.2.1.5 of this chapter.
- c. Review minutes from TMA/TMI Panels and take action as appropriate.

32.4.2.1.5 Top Management Attention/Top Management Issues Panels. The TMA/TMI Panels shall:

- a. Review, discuss, and agree on the course of action to resolve each technical issue presented.
- b. Publicize minutes of the Panel Meetings.

32.4.2.1.5.1 Top Management Attention Panels. TMA Panels meet every six months, to assess the applicability of Plan of Action and Milestones and ROIs, and monitor the progress of issues. TMA panels are meetings chaired at the O-6 level. In general, TMA Panels discuss those issues that can be handled within the SYSCOM organizations. The TMA Panel will identify top issues based on specific attributes (e.g., man-hours, cost, readiness) for presentation at TMI.

- a. TMA Panels: TMA Panel composition and agendas are coordinated between applicable TYCOM staffs, Fleet staffs and SYSCOM Program Offices. Attendees to the appropriate TMA Panels include, but are not limited to, the following:
 - (1) COMNAVSEASYSCOM (05) representative as chairman for the Surface Force, Aircraft Carrier and CS panels and COMNAVSEASYSCOM (SEA 07) representative as chairman for the Submarine Force panel.
 - (2) CNO (N43) and applicable Resource Sponsor (N8, N6) representative(s).
 - (3) Maintenance and Supply representatives from Fleet, TYCOMs, and Regional Maintenance Centers (RMC).
 - (4) COMNAVSEASYSCOM Program Offices, engineering codes and logistics codes representative(s).
 - (5) Commander, Space and Naval Warfare Systems Command (COMSPAWARSYSCOM) Program Office representative(s) as requested.
 - (6) Commander, Naval Air Systems Command (COMNAVAIRESYSCOM) Engineering representative(s) as requested.
 - (7) In-Service Engineering Agent representatives.
 - (8) Naval Inventory Control Point (NAVICP) representative.

- (9) Training Command representative.
 - (10) Naval Research Laboratory representative.
 - (11) Board of Inspection and Survey representative.
- b. Submarine Force TMI Panel: The Submarine Force TMI Panel is chaired by COMSUBFOR. The TMI is normally conducted as a part of the Undersea Enterprise Board of Directors meeting. COMSUBFOR and COMSUBPAC Directors for Maintenance and Material Readiness coordinate the agenda with the COMSUBFOR Enterprise office. Panel Members may include, but are not limited to, the following:
- (1) COMSUBFOR, SEA 07, PEO SUBS.
 - (2) CNO (N43) and applicable Resource Sponsor (N8, N6) representative(s).
 - (3) COMSUBFOR and COMSUBPAC Maintenance and Supply Officers.
 - (4) COMNAVSEASYSYSCOM program offices, engineering code and logistics code representatives.
 - (5) COMSPAWARSYSYSCOM representative.
 - (6) COMNAVAIRSYSYSCOM representative.
 - (7) In-Service Engineering Agent representative(s).
 - (8) Commander, Navy Regional Maintenance Center and RMC representatives.
 - (9) NAVICP representative.
 - (10) Chief of Naval Education and Training representative.
- c. Surface Force Ship/Aircraft Carrier TMI Panel: The Surface Force Ship/Aircraft Carrier TMI Panel is chaired by NAVSEA 05. NAVSEA 05, PEO Theater Surface Combatants, PEO Expeditionary Warfare, PEO Mine and Undersea Warfare, PEO CARRIERS and PEO Surface Strike jointly coordinate the agenda. Attendees of the appropriate TMI Panels include, but are not limited to, the following:
- (1) PEO Expeditionary Warfare, PEO Theater Surface Combatants, PEO CARRIERS (Surface/Carrier), PEO Mine and Undersea Warfare, PEO Surface Strike, SEA 07 (Submarine).
 - (2) CNO (N43), and applicable Resource Sponsor (N8, N6) representative(s).
 - (3) COMLANTFLT, COMPACFLT, COMNAVSURFLANT, COMNAVSURFPAC, COMNAVAIRLANT, COMNAVAIRPAC, COMSUBLANT, and COMSUBPAC Maintenance and Supply Officers.
 - (4) COMNAVSEASYSYSCOM program offices, engineering code and logistics code representatives.
 - (5) COMSPAWARSYSYSCOM representative.
 - (6) COMNAVAIRSYSYSCOM representative.
 - (7) In-Service Engineering Agent representative(s).
 - (8) RMC and RMC representatives.
 - (9) NAVICP representative.
 - (10) Chief of Naval Education and Training representative.
 - (11) Naval Research Laboratory representative.
 - (12) Board of Inspection and Survey representative.
- d. Combat Systems: The CS Troubled Systems Process supports the TMA/TMI process with selected inputs for the COMLANTFLT/COMPACFLT CS Technical Tickler.

32.4.2.1.6 Top Management Attention/Top Management Issues Working Groups. The TMA/TMI Working Groups shall:

- a. Receive TYCOM HM&E and CS Technical Ticklers or Issues White Papers as appropriate from NAVSEA 05 for surface force ships/aircraft carriers or from NAVSEA 07 for submarines and identify common and platform specific issues as appropriate.
- b. Review TYCOM HM&E and Nuclear Planning and Execution System Technical Ticklers, White Papers or Action Items. Verify applicability of Fleet-recommended actions and achieve agreement with appropriate Fleet and TYCOM staff(s) as appropriate.
- c. Notify appropriate COMNAVSEASYSKOM Program Offices and other SYSCOMs when equipment or systems under their care are identified as fleet material readiness issues.

32.4.2.1.7 Review. TMA/TMI Working Groups, comprised of SYSCOM representatives designated by NAVSEA 05 and 07, PEO SUBS, PEO Ships, PEO Integrated Warfare Systems, and PEO CARRIERS, review Fleet inputs to determine common and platform specific issues and assign issues to the appropriate SYSCOM Program Offices.

32.4.3 Top Management Attention/Top Management Issues Analysis Center.

32.4.3.1 Candidate Identification. The TMA/TMI Analysis Center will provide a combined Ranking Matrix to help determine the relative ranking of systems/equipment on a Navy wide basis. The TMA/TMI Analysis Center, using the TYCOM input plus RMC and TYCOM technical experts, will prepare a preliminary set of Fleet generated system problems and potential solutions, the Technical Tickler, for the systems/equipment chosen for inclusion in the TMA/TMI process. The TMA/TMI Analysis Center, using 3-M data, also provides the TYCOMs with a Ranking Matrix, Figures 32-1 and 32-2, and Impact Chart, Figure 32-3, by Allowance Parts List (APL) and Equipment Identification Code (EIC) for their review. The Ranking Matrix will be TYCOM specific, using the Ranking Matrix as a guide, the TYCOMs select systems/equipment for further evaluation and possible induction into the TMA/TMI process.

32.4.3.2 Candidate Expanded Metrics. The TMA/TMI Analysis Center provides the TYCOMs with a tailored TMA Report for their identified systems/equipment. This report contains a Balanced Score Card (BSC), Problem Free Time, Failure Rate, Parts Ranking and modified Ship's Logistics Indicator Computerized Report (SLICR) for the specific candidate system/equipment defined by APL or EIC nominated by the TYCOM. These are 3-M based reports that require no special data collection or analysis efforts.

32.4.4 Type Commanders. The TYCOMs, using the data provided in the TMA Report and other (RMC, SYSCOMs, etc.) Casualty Report (CASREP), maintenance, logistics or training inputs will determine which systems/equipment to nominate for inclusion into the TMA/TMI process. The nomination should include the TMA Metrics plus additional justification including the TYCOM's initial Root Symptom Analysis as to the causes of poor performance. Systems/equipment will be nominated at the lowest component level that can be identified as the reliability or cost driver. When multiple APLs or EICs from the same "System" appear at or near the top of the Ranking Matrix, the entire "System" can be nominated.

32.5 METRICS. Metrics used are generated directly from the 3-M database via Open Architecture Retrieval System (OARS) and require no subsequent data collection or analysis efforts. All Navy systems/equipment that generate maintenance data are included and considered as part of this methodology. This is a three month process, starting after Fleet Week and culminating at the Mid-Cycle review that gets new systems nominated by the Fleet to TMA. Systems not selected for TMA can be re-nominated by a TYCOM Representative at least 4.5 months prior to any future Fleet Week.

32.5.1 Top Management Attention/Top Management Issues Candidate Selection. There are two methods used to select topic candidates for TMA/TMI. TYCOMs may use any combination of the two methods to select topic candidates.

- a. The first method entails soliciting fleet commanders, maintenance officers and TYCOM staff members for candidate topics. Candidate topics are then reviewed by both TYCOM maintenance officers and selected or rejected as TMA topics.
- b. The second method is by a ranking matrix where costs, man-hours, CASREP volume and other attributes are measured and a "top ten" selection process is then employed.

32.5.1.1 Top Management Attention/Top Management Issues Ranking Matrix Method. Six attributes are used to rank systems/equipment as TMA/TMI Program candidates. Data for five of the attributes are downloaded directly from the 3-M database via OARS. The CASREP Volume data is extracted and sanitized from the NAVICP CASREP Database. The attributes are:

- a. 2-Kilo Volume - Total number of Maintenance Actions (2-Kilos) generated by the system/equipment.
- b. Man-hours - Total Ship's Force and Intermediate Maintenance Activity (IMA) man-hours expended on system/equipment maintenance.
- c. Parts Cost - Total net cost of repair parts used to support the system/equipment.
- d. Hi-Priority Failures - Total number of 2-Kilos that are Status 2 or 3 and Priority 1, 2 or 3 2-Kilos generated for a system/equipment.
- e. Hi-Priority Down Time - Total days of down time for the system/equipment based on hi-priority failures.
- f. CASREP Volume - Number of CASREPs generated by the system/equipment.

Data on each attribute is collected over a two-year period. The Ranking Matrix is a multivariable pareto ranking technique that avoids the distortion inherent in ordinary ranking schemes where variables representing different aspects of a system/equipment may have different units of measurement with widely differing scales. The technique gives full visibility to systems where even only one of the descriptive attributes has a high impact level. As a result the "top ten pareto" of each of the attributes winds up on or near page one of the overall ranking. The process is easily automated in MS Excel or MS Access. This method is applied to approximately 43,000 APL and 4,200 EIC systems/equipment. The resultant Ranking Matrix provides Fleet decision makers a list of potential TMA/TMI candidates.

32.5.1.1.1 Ranking Matrix Calculation. Data for each attribute are scaled/normalized/standardized (depending on the language in your field of study) in a way that creates unit vectors (0 to 1, with a few high outliers > 1) in statistical units (Standard Deviation multiples sometime referred to as "Z" scores). The scaling used results in the 3-sigma value of the data being scaled to equal one. The 99.86th percentile of the data is used to locate that value in the ranked raw data, which is a percentile commonly used for "normal" distributions with a single tail as being equivalent to the 3-sigma value. Although our five attribute distributions are not "normal", they are close to being "log normal" so the percentile technique works. The percentile technique works well regardless since the data is a 100% sample and the statistical distribution (which should be known if samples are used for estimating) is not a critical issue. After scaling the attributes, the vector equivalents are then combined using vector addition to create a balanced rank value that can be used for final ordering of the ranking. The vector addition technique is straightforward (Pythagorean). For over three years this has produced a tight pattern of the top ten for each attribute falling within the top 50 fleet-wide. The method is objective, repeatable, and robust and uses the "actual data", not a representation of the data.

Figure 32-1 Sample TMA APL Ranking Matrix

FUNCTIONAL AREA (L1)	EIC	EIC NOMENCLATURE (L2)	APL	APL NOMENCLATURE (L3)	apl_population	cn	count	cn	rank	total_mantnb	rank	total_reptrc	rank	hi	priority	hpf	rank	hi	priority	hpf	ran	casrep	vc	casrep	ra	BAL_VEC	BAL_RANK	MDT	MTBF	A(j)	R(m)	P(m)	Failure
GUN SYSTEMS	6V	WEAPON SYSTEM, CLOSE-IN, MK 15 (PHALANX)	006090237	MK7MOD0,RADAR ASSEMBLY,MODULE	237	6721	1	17235	3	18715213	1	1463	1	1463	1	64677.77	2	471	1	17.18	1	17.18	1	17.18	1	17.18	1	44	79	64.0%	10.2%	89.8%	\$17,504
GENERATION SYSTEMS, ELECTRIC POWER	37	GENERATOR SYSTEM, 100KW, STEWART AND STEVE	066778010E	ENGINE DSL 16 1140001 1600 1800RPM	106	3016	2	258700	1	3501167	20	809	2	5992.98	3	122	3	9.71	2	70	64	47.5%	6.0%	94.0%	117,119								
PROPULSION SYSTEM, MAIN GAS TURBINE, MD1		GAS TURBINE MODULE, PROPULSION	052050008	GAS GENERATOR ASSY>URB MN PROSN 7LM2500PBK	137	1794	9	156811	4	15281673	2	456	6	34540.58	9	115	4	8.85	3	76	146	65.9%	29.2%	70.8%	\$47,268								
GENERATION SYSTEMS, ELECTRIC POWER	35	GENERATOR SET, GAS TURBINE	052090005	ENG ASSY GAS TURB MDL 601K34	117	1249	27	59905	14	11631984	4	189	32	10109.13	136	76	17	5.69	4	53	301	84.9%	55.0%	45.0%	\$74,223								
NAVIGATION SYSTEMS (ELECTRONIC AND NON LB		GYROCOMPASS (CIRCUIT LC AND VLC)	282000010	ANW5N2 SET,GYROCOMPASS,STABILIZED	62	242	446	5592	699	12655477	3	72	238	4921.532	508	36	68	5.48	5	67	419	86.2%	65.1%	34.9%	\$179,016								
GUN SYSTEMS	6V	WEAPON SYSTEM, CLOSE-IN, MK 15 (PHALANX)	006090238	MK20MOD0,ELECTRONIC ASSEMBLY,ENCLOSURE	237	2019	8	52239	21	4025599	17	482	5	18453.1	38	143	2	5.02	6	38	239	86.2%	47.2%	52.8%	\$12,667								
MISSILE SYSTEMS, SURFACE	56	WEAPON SYSTEM, AEGIS, MK7 MODS	782922335A	0J-194(V)MUYA-4(V) LESS IP-1091	192	595	103	178318	2	1459130	73	144	63	6989.946	277	14	268	4.95	7	49	649	93.0%	75.8%	24.2%	\$59,735								
MISSILE SYSTEMS, SURFACE	51	FIRE CONTROL SYSTEM, GUNMISSILE, MK 92 MOD 2	006080059	MK92MOD2,FIRE CONTROL SYSTEM (BASELINE)	18	1360	18	34045	47	4320047	14	579	3	35400.09	8	97	7	4.88	8	61	15	19.8%	0.0%	100.0%	\$9,813								
HULL STRUCTURE	AD	DOORS, HATCHES, MANHOLES, SCUTTLES AND CLOS	319990011	WATERTIGHT DOORS, HATCHES, SCUTTLES NO OTHER AP	3364	2057	6	36801	38	202509	537	243	20	75146.83	1	1	3073	4.77	9	309	6741	95.6%	97.4%	2.6%	\$6,891								
GUN SYSTEMS	6V	WEAPON SYSTEMS, GUN	006040508	MK46MOD0,OPTICAL SIGHT	34	246	434	15632	180	10838999	5	79	195	6291.344	335	58	27	4.76	10	80	210	72.5%	92.4%	57.6%	\$143,154								
AUXILIARY SYSTEMS	TF	AIR SYSTEMS, COMPRESSED	061430285E	COMPRESSOR AIR HIGH PRESSURE 20CFH 3000PSI	57	1299	23	61519	19	1947981	47	520	4	28820.28	13	88	9	4.35	11	55	53	49.1%	3.4%	96.6%	\$9,478								
GENERATION SYSTEMS, ELECTRIC POWER	31	PLANTS, GENERATING, SHIPS SERVICE	052090012	ENGINE GAS TURBINE SHIPS SER GEN	78	1297	24	81095	5	4969783	11	317	13	12899.61	83	85	10	4.16	12	41	120	74.6%	22.3%	77.7%	\$29,910								
PROPULSION SYSTEM, MAIN GAS TURBINE, MD1		GAS TURBINE MODULE, PROPULSION	052050018	GAS GENERATOR ASSEMBLY, MDL L2520G12	66	664	88	41219	39	8613557	6	180	50	11454.33	107	42	56	4.12	13	72	201	73.7%	40.8%	59.2%	\$64,139								
COMMUNICATION AND DATA SYSTEMS	0F	CRYPTOGRAPHIC EQUIPMENT	88633661	TA-970(V), TELEPHONE SET	4786	2832	3	17859	141	482109	220	427	7	2180.75	29	0	5983	3.77	14	51	5457	99.1%	96.8%	3.2%	\$2,802								
DISTRIBUTION SYSTEMS, ELECTRICAL POWER 45		DISTRIBUTION SYSTEM, AC LIGHTING	249990001	FIXTURE LGTG FLRSNT MS17179-77.4	10940	2549	4	44648	29	927524	105	369	10	25459.73	21	0	5979	3.61	15	71	147890	100.0%	99.9%	0.1%	\$7,558								
MISSILE SYSTEMS, SURFACE	56	WEAPON SYSTEM, AEGIS, MK7 MODS	ME015664	AM-800(SPI)-1A C64758, AMPLIFIER,RADIO FREQ	48	1151	32	72676	9	4080218	15	326	12	13133.13	79	19	169	3.45	16	40	72	64.0%	8.1%	91.9%	\$21,433								
GENERATION SYSTEMS, ELECTRIC POWER 31		PLANTS, GENERATING, SHIPS SERVICE	66888004L	ENGINE DIESEL GEN 36SS8V-AM MDL 2894F01-GEN6CY	36	1490	14	36978	37	3982757	19	237	21	14655.93	62	92	8	3.42	17	62	74	54.5%	8.8%	91.2%	\$23,046								
DISTRIBUTION SYSTEMS, ELECTRICAL POWER 45		DISTRIBUTION SYSTEM, AC LIGHTING	249990138	LANTERN ELEC 115VAC SYM 101.2	71182	2221	5	31077	57	325997	343	395	9	23916.33	25	2	1982	3.39	18	61	87745	99.9%	99.8%	0.2%	\$3,972								
PROPULSION SYSTEM, MAIN DIESEL, MECHANB1		ENGINE AND CONTROLS, DIESEL	668880032L	ENGINE DIESEL 36SS8V-AM MDL 2894F01 6CYL	48	1538	13	36021	41	4013172	18	179	36	15643	55	80	14	3.20	19	87	131	59.9%	25.2%	74.8%	\$30,469								
MISSILE SYSTEMS, SURFACE	56	WEAPON SYSTEM, AEGIS, MK7 MODS	ME403291	AM-7158(SPI)-1B D0651T90, AMPLIFIER RADIO FREQ	120	833	62	16563	162	8525684	8	156	52	3220.242	910	46	41	3.19	20	21	375	94.8%	61.8%	38.2%	\$46,079								
ADMINISTRATION HABITABILITY, OUTFIT/FURNIS1A		EQUIPMENT AND FURNISHINGS, UTILITY SPACE	439990247	PLASTIC PROCESSOR MELT UNIT 593-6961200	390	1064	40	46175	26	1051398	91	259	17	2659.29	14	71	19	3.04	21	110	733	86.9%	78.2%	21.8%	\$11,168								
RADAR AND IFF SYSTEMS	P3	RADAR, AIR SEARCH	59228806	AS-3263(SPI)-M(V), ANTENNA	77	240	450	8509	431	6942312	7	47	435	3554.825	796	24	127	3.03	22	76	798	91.3%	79.8%	20.2%	\$154,970								
RADAR AND IFF SYSTEMS	P1	RADAR, SURFACE SEARCH	57041000	ANSPS-55, RADAR SET	81	813	64	17709	145	2218016	38	219	25	13163.55	78	112	5	2.98	23	60	180	75.0%	36.8%	63.2%	\$13,353								
AUXILIARY SYSTEMS	TF	AIR SYSTEMS, COMPRESSED	061430287	COMPRESSOR UNIT 20.0CFH 3000PSI	36	736	75	51315	24	1446433	74	253	19	30990.66	11	55	29	2.96	24	122	69	36.1%	7.4%	92.6%	\$13,830								
MISSILE SYSTEMS, SURFACE	56	WEAPON SYSTEM, AEGIS, MK7 MODS	ME015669	AM-6889(SPI)-1A C64758, AMPLIFIER,RADIO FREQ	72	719	79	77050	8	3488322	21	201	29	6048.992	356	24	125	2.92	25	30	174	85.3%	35.6%	64.4%	\$32,738								
MISSILE SYSTEMS, SURFACE	56	WEAPON SYSTEM, AEGIS, MK7 MODS	ME403311	T-1346(SPG D0651T90, TRANSMITTER,RADAR	120	940	52	24141	84	5475373	9	132	78	4160.215	624	55	31	2.91	26	32	443	93.4%	66.6%	33.4%	\$48,796								
GUN SYSTEMS	6V	WEAPON SYSTEM, CLOSE-IN, MK 15 (PHALANX)	006090242	M61A1 20MM GUN	237	1409	16	61981	12	2826318	29	222	24	8212.5	210	43	50	2.90	27	37	520	93.4%	70.7%	29.3%	\$23,889								
MISSILE SYSTEMS, SURFACE	56	WEAPON SYSTEM, AEGIS, MK7 MODS	ME403292	AM-7158(SPI)-1B D0651T90, AMPLIFIER RADIO FREQ	80	1088	35	18087	137	5223554	10	176	39	3551.882	797	43	54	2.83	28	20	221	91.6%	44.3%	55.7%	\$33,790								
PROPULSION SYSTEM, MAIN DIESEL, MECHANB1		ENGINE AND CONTROLS, DIESEL	668880067M	ENGINE DSL D36SS8V-AM MDL-2849F01 8 CYL	24	1167	31	35619	44	1834152	52	167	43	11568.15	106	98	6	2.82	29	69	70	50.3%	7.6%	92.4%	\$19,514								
GENERATION SYSTEMS, ELECTRIC POWER 31		PLANTS, GENERATING, SHIPS SERVICE	L665360269	DIESEL ENG. MDL 38N08 1-8 12 CYL	32	962	50	79314	7	800932	121	162	47	18018.27	35	39	60	2.82	30	117	96	45.0%	15.4%	84.6%	\$24,528								
COMMUNICATION AND DATA SYSTEMS	0E	TRANSMITTERS (COMMUNICATION)	00008485	AM-3824D(P)URT, AMPLIFIER,RADIO FREQUENCY	434	1329	20	17252	149	1645025	64	354	11	16015.85	53	48	37	2.80	31	45	597	93.0%	74.0%	25.0%	\$6,596								
AUXILIARY SYSTEMS	TF	AIR SYSTEMS, COMPRESSED	863050754	H.P. AIR SYSTEM CARTRIDGE VALVE REPAIR PARTS	119	1280	25	18287	135	62050	1741	405	8	17610.27	45	2	1984	2.72	32	43	143	76.7%	28.4%	71.6%	\$1,959								
MISSILE SYSTEMS, SURFACE	53	FIRE CONTROL SYSTEMS, GUNMISSILE	006080067	MK92MOD2,FIRE CONTROL SYSTEM (BASELINE)	12	679	85	19143	125	4987678	13	161	49	18915.98	36	51	33	2.72	33	116	36	23.9%	0.7%	99.3%	\$33,251								
MISSILE SYSTEMS, SURFACE	56	WEAPON SYSTEM, AEGIS, MK7 MODS	00034338	0J-451(V)MUYO-21(V) ROLL-UP	465	1677	12	31517	54	1920930	48	288	16	9851.075	145	16	223	2.54	34	37	845	95.8%	80.8%	19.2%	\$11,872								
PROPULSION SYSTEM, MAIN GAS TURBINE, MD1		GAS TURBINE MODULE, PROPULSION	059970003	BASSE ENCL & GTRB ASSEMBLY FFG 7 L25040G01	60	890	58	27363	69	681950	151	292	14	25721.71	19	26	106	2.48	35	88	100	53.2%	16.5%	83.5%	\$6,082								
AUXILIARY SYSTEMS	17	PLUMBING INSTALLATIONS	017000043	PUMP CTFLG 100GPM 30PSI 1750RPM MCC VLT	231	466	167	28432	64	209336	527	134	77	3902.58	5	25	116	2.48	36	296	839	73.9%	80.7%	19.3%	\$10,049								
MISSILE SYSTEMS, SURFACE	54	LAUNCHING SYSTEM, GUIDED MISSILE, MK 13 MOD 4	004020386	MK13MOD4,LAUNCHING SYSTEM,GUIDED MISSILE	30	1011	44	36101	40	938992	104	187	34	25403.8	22	44	46	2.39	37	136	78	61.0%	10.0%	90.0%	\$12,733								
AUXILIARY SYSTEMS	TC	SCUPPERS AND DECK DRAINS	679990055	DRAIN DK SZ 2.000 IN	7370	792	67	9984	358	11368																							

Figure 32-2 Sample TMA EIC Ranking Matrix

EIC	EIC NOMENCLATURE	FUNCTIONAL AREA	jcn_count	jcn_rank	van_hours	tmh_rank	total_repair	trcc_rank	hi_priority	hpf_rank	hi_priority	hpdt_rank	casrep_vc	casrep_ra	BAL_VEC	BAL_RANK
U000	SUPPORT SERVICES, MAINTENANCE	SUPPORT SERVICES, MAINTENANCE	183,743	1	6,132,518	1	\$25,751,114	4	17905	1	4,046,753	1	421	7	41.99	1
1000	ADMINISTRATION HABITABILITY, OUTFIT/FURNISHINGS	ADMINISTRATION HABITABILITY, OUTFIT/FUR	40,913	3	1,333,477	4	\$5,812,668	37	6085	2	1,374,829	2	24	282	11.50	2
A905	COMPARTMENTS	HULL STRUCTURE	56,132	2	1,575,477	3	\$2,220,421	100	4103	6	1,086,529	3	15	421	11.44	3
Z000	SPECIAL/MISCELLANEOUS/UNCODED ITEMS	SPECIAL/MISCELLANEOUS/UNCODED ITEMS	27,685	5	1,633,924	2	\$37,860,095	3	2988	10	410,674	10	73	95	9.45	4
AD01	DOORS	HULL STRUCTURE	40,661	4	712,568	7	\$7,877,630	21	4198	5	870,775	4	95	69	8.23	5
T801	FIREMAINS	AUXILIARY SYSTEMS	19,247	12	591,128	8	\$10,819,978	16	4390	4	815,003	5	637	1	7.72	6
1805	LOCKERS, DAMAGE CONTROL	ADMINISTRATION HABITABILITY, OUTFIT/FUR	24,547	6	728,980	6	\$13,264,377	11	4912	3	612,214	6	20	332	6.59	7
D111	GENERATOR ASSEMBLY, GAS	PROPULSION SYSTEM, MAIN GAS TURBINE	7,361	38	474,096	11	\$38,386,681	2	1679	25	117,104	46	308	10	6.38	8
5612	TRANSMITTER GROUPS (AN/SPY-1)	MISSILE SYSTEMS, SURFACE	9,923	21	320,727	23	\$38,454,563	1	1700	23	64,308	84	276	13	6.23	9
3108	GENERATOR SET, 60HZ, GAS TURBINE DRIVEN	GENERATION SYSTEMS, ELECTRIC POWER	11,571	15	883,518	5	\$16,253,348	6	2847	11	189,980	28	563	3	5.92	10
TF01	AIR SYSTEMS, HIGH PRESSURE	AUXILIARY SYSTEMS	20,573	9	461,414	13	\$12,792,343	13	3851	7	371,861	12	501	4	5.78	11
TF03	AIR SYSTEMS, LOW AND MEDIUM PRESSURE	AUXILIARY SYSTEMS	18,272	13	522,940	10	\$13,197,387	12	3340	9	295,402	17	563	2	5.69	12
1B01	GALLEY EQUIPMENT (COMMISSARY SPACES)	ADMINISTRATION HABITABILITY, OUTFIT/FUR	23,144	7	354,346	21	\$4,808,712	44	3544	8	423,713	9	92	72	4.71	13
T30B	FAN UNIT (TYPE A, VANEAXIAL)	AUXILIARY SYSTEMS	8,689	24	234,068	34	\$2,091,720	104	2330	14	470,081	8	353	9	4.09	14
B101	ENGINE, DIESEL	PROPULSION SYSTEM, MAIN DIESEL, MECH	9,587	22	273,377	28	\$12,351,988	14	1554	29	134,713	37	458	6	3.91	15
T40S	CONDITIONING SYS, AIR (R-114 CHILLED WATER PLANT)	AUXILIARY SYSTEMS	12,995	14	365,132	19	\$5,967,372	36	2415	13	366,808	13	204	21	3.73	16
4505	FIXTURES, LIGHTING, PERMANENT MOUNTED	DISTRIBUTION SYSTEMS, ELECTRICAL POW	20,131	10	362,859	20	\$4,937,186	42	2703	12	246,527	20	8	625	3.70	17
T706	PIPING AND VALVE GROUP	AUXILIARY SYSTEMS	10,537	18	262,186	30	\$3,130,625	68	1995	17	496,523	7	64	105	3.64	18
7C1C	AIRCRAFT RECOVERY EQUIPMENT GENERAL ARRANGEMENT, MK 7	AVIATION SHIP INSTALLATION	21,233	8	461,127	14	\$10,376,460	17	185	228	69,588	76	21	318	3.51	19
7A11	CATAPULT GENERAL ARRANGEMENT C13/C13-1/C13-2	AVIATION SHIP INSTALLATION	19,771	11	582,583	9	\$6,842,689	29	410	112	67,447	78	18	357	3.45	20
T806	AUXILIARY SEA WATER SERVICE SYSTEM	AUXILIARY SYSTEMS	11,020	17	403,072	17	\$6,673,045	31	2106	16	269,111	19	231	17	3.39	21
3701	GENERATOR SET, 60HZ, DIESEL ENGINE DRIVEN	GENERATION SYSTEMS, ELECTRIC POWER	8,594	26	448,990	15	\$6,189,991	35	2212	15	161,341	31	286	12	3.29	22
3101	GENERATOR SET, 60HZ, DIESEL ENGINE DRIVEN	GENERATION SYSTEMS, ELECTRIC POWER	8,673	25	267,790	29	\$9,680,634	19	1249	32	99,833	52	373	8	3.23	23
GV23	RADAR-WEAPON ASSEMBLY 5543003	GUN SYSTEMS	7,264	40	186,791	41	\$18,210,968	5	1363	31	67,058	80	172	26	3.23	24
GV00	WEAPON SYSTEM, CLOSE-IN, MK 15 (PHALANX)	GUN SYSTEMS	1,846	140	55,909	134	\$3,197,582	67	442	104	33,195	175	484	5	3.06	25
T300	VENTILATION SYSTEMS	AUXILIARY SYSTEMS	8,557	27	170,682	43	\$2,095,440	103	1742	22	393,807	11	162	29	3.05	26
T404	AIR CONDITIONING PLANT, CHILLED WATER (R-12) 80 TON	AUXILIARY SYSTEMS	7,601	34	212,030	36	\$3,455,803	61	1974	18	312,106	16	220	19	2.94	27
A500	PLATFORMS, FLATS AND DECKS	HULL STRUCTURE	10,495	19	315,058	24	\$722,116	251	1631	26	335,634	14	15	422	2.85	28
F101	BOILERS, D-EXPRESS-HEADER TYPE, PRPLN SYS, MAIN STEAM	PROPULSION SYSTEM, MAIN-STEAM, MECH	7,402	37	437,143	16	\$5,179,471	38	1682	24	226,238	21	162	30	2.83	29
T805	FUELING SERV, XFR AND BLENDING SYSTEM, AVI JP-5	AUXILIARY SYSTEMS	9,470	23	273,973	27	\$5,055,032	39	1808	20	315,318	15	74	93	2.83	30
T803	WATER SYSTEM, POTABLE	AUXILIARY SYSTEMS	10,434	20	277,612	26	\$6,619,149	32	1825	19	209,837	25	158	32	2.74	31
TK03	DISTILLING PLANT, LOW PRESSURE FLASH TYPE	AUXILIARY SYSTEMS	7,702	33	258,056	31	\$6,879,203	27	1746	21	195,523	26	222	18	2.70	32
D701	SERVICE SYSTEM, FUEL OIL	PROPULSION SYSTEM, MAIN GAS TURBINE	7,520	35	399,221	18	\$7,374,117	23	1596	27	132,404	40	192	24	2.70	33
5646	AN/SPG-62(SERIES), RADAR SET	MISSILE SYSTEMS, SURFACE	5,414	49	111,779	69	\$14,534,374	8	751	57	38,609	147	217	20	2.69	34
GV20	WEAPON SYSTEMS, CLOSE-IN, MK 15 MODS 11-14 (PHALANX)	GUN SYSTEMS	8,108	29	180,214	42	\$10,197,047	18	1166	38	56,343	99	272	14	2.68	35
5622	DISPLAY GROUP, COMMAND AND DECISION	MISSILE SYSTEMS, SURFACE	6,938	43	462,580	12	\$6,948,534	25	1224	33	64,784	83	108	58	2.44	36
1A01	LAUNDRY-TAILOR SHOP EQUIPMENT	ADMINISTRATION HABITABILITY, OUTFIT/FUR	11,420	16	204,488	38	\$2,314,806	94	1577	28	209,992	24	68	99	2.33	37
LB3E	AN/WSN-2, GYROCOMPASS SET, STABILIZED	NAVIGATION SYSTEMS (ELECTRONIC AND N	436	475	8,766	560	\$15,594,245	7	123	352	9,553	456	44	165	2.30	38
4101	SWITCHBOARD, SHIPS SERVICE, 60HZ	DISTRIBUTION SYSTEMS, ELECTRICAL POW	5,106	51	152,708	47	\$4,080,244	49	1097	41	102,675	51	295	11	2.29	39
G611	WEAPON SYSTEM, GUN, MK 34 MOD 0	GUN SYSTEMS	2,675	104	68,606	116	\$13,525,878	10	355	132	25,221	218	148	36	2.23	40

32.5.1.2 **Impact Chart.** The Impact Chart provides a means of plotting the Ranking Matrix and showing, using a two-axis display, the TMA/TMI systems/equipment and potential candidate systems/equipment. Annual Cost of Parts and Labor are combined to form the X-axis and Days Down Time the Y-axis, providing a visual "high cost", "high down time" display of TMA/TMI current and candidate systems/equipment.

Figure 32-3 Sample Impact Diagram

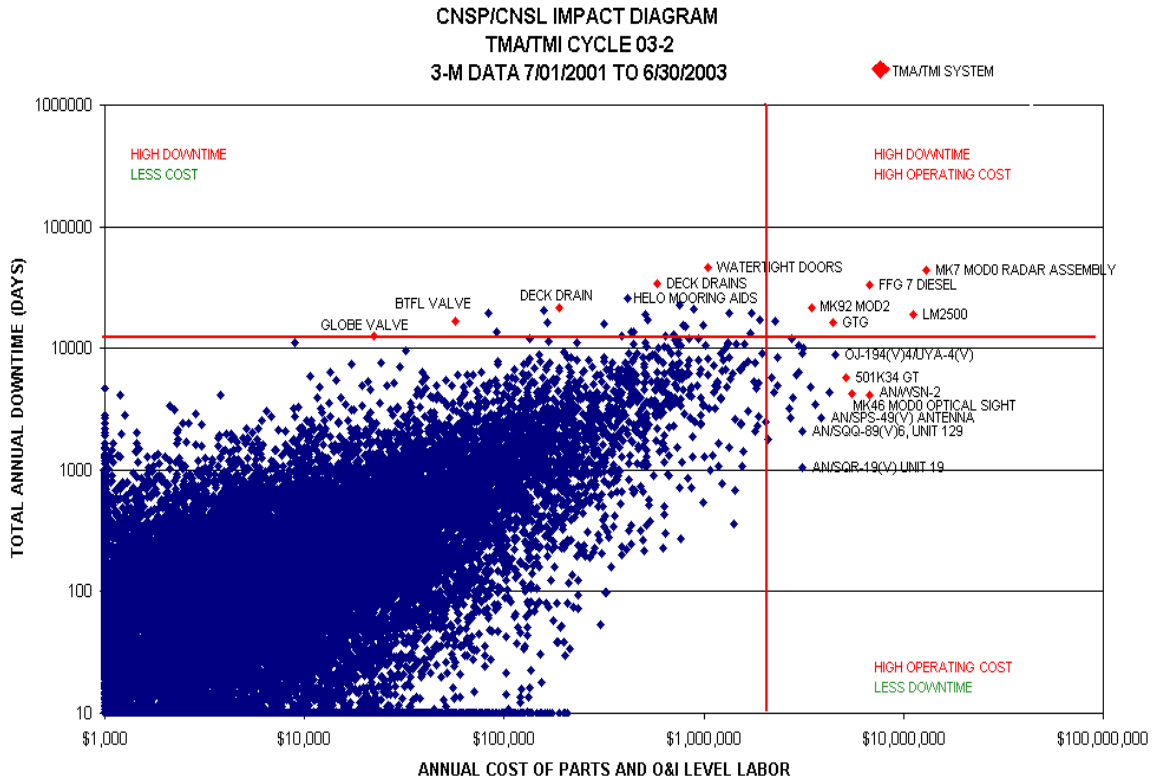

32.5.1.3 **Balanced Score Card.**

- a. Ratio analysis is a valuable tool for interpreting financial and operating data (from balance sheets, profit-and-loss statements, production data, etc.) to detect favorable or unfavorable conditions in business performance.
- b. Ratios are used to show the proportional relationship of data from a variety of sources. Business owners should compare their ratios for a specific period with previous periods to ascertain possible reasons for change. They may also choose to compare the ratios for their operation with the industry standard.
- c. After an operation has been in existence for a reasonable time, the ratios tend to stabilize and in many industries desirable ratios are well established. Therefore, there is a minimum percentage that an operation can cost (manpower/capital) and still provide proper service, and a maximum that it can cost before the operation is shut down or re-engineered.
- d. This business approach can be applied to the management of systems in the fleet. The BSC developed by the TMA/TMI Analysis Center allows the user to:
 - (1) Observe the shape, or system behavior/maintenance strategy (relative proportions or ratios, variable to variable).
 - (2) Compare a single variable with the entire fleet (since the data is scaled using the upper control limit of all fleet data for each variable as the 100% mark).

- (3) Observe the enclosed area which is proportional to the TMA/TMI balanced ranking value.
- (4) Identify problem areas for follow-on analysis.

Notice that ratios of variables that have the same value on the grid (1:1) are at the fleet average or norm. For example, if Hi-Priority Failures and Hi-Priority Downtime are equal, the connecting line is parallel to the grid and that system has an Average Logistics Response Time equal to the fleet average. Other ratios behave in the same way. A typical BSC has six sides representing the six TMA/TMI attributes. Additional variables from other data sources may be added and, if scaled to the upper control limit of that data source, will achieve similar results.

Figure 32-4 Sample BSC

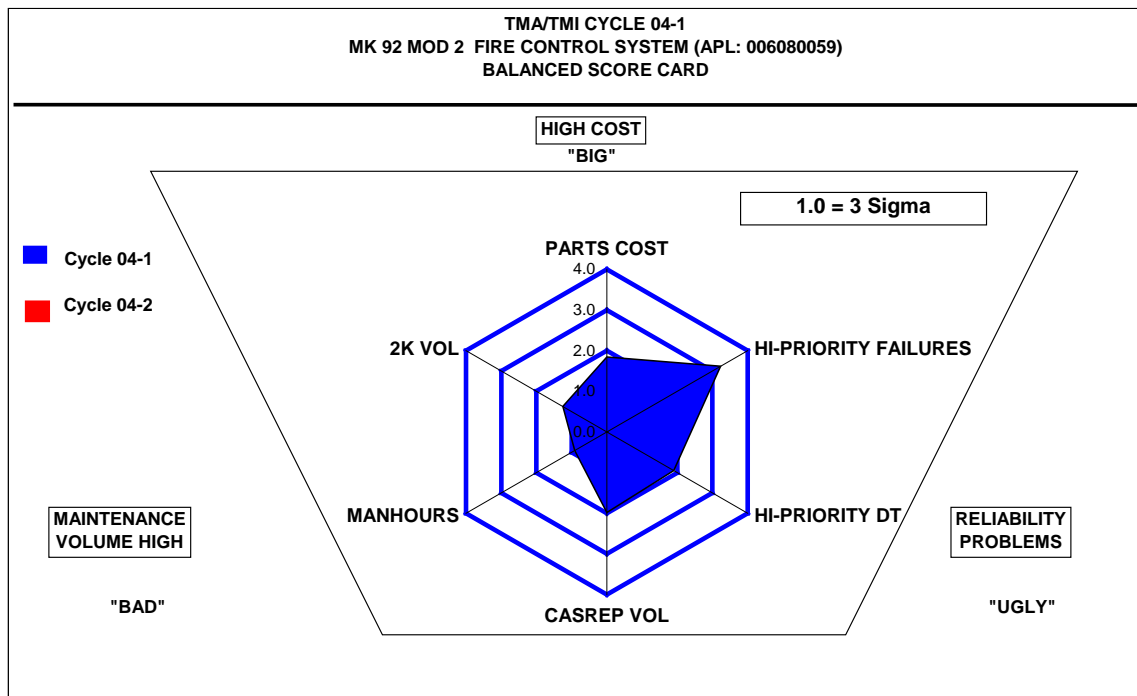

32.5.1.4 Time (problem free). Reference (b), establishes Operational Availability (Ao) as the primary measure of material readiness for navy mission-essential systems, subsystems and equipment installed in platforms. Ao represents the expected percentage of time that system or individual equipment will be ready to perform satisfactorily in an operating environment when called for at any random point in time. To provide the primary measure of material readiness for the TMA/TMI systems/equipment, the TMA/TMI Analysis Center has developed a measure of Ao for selecting, tracking and trending TMA/TMI systems/equipment called Time Problem Free (T (pf)).

- a. T (pf) uses the mathematical description of Ao provided by reference (b). Generally, Ao is interpreted as the percentage of time that the system will be ready to perform satisfactorily in an operating environment. T (pf) is interpreted as the percentage of time that the system or equipment is free of hi-priority failures during that same period. Quantitatively, this is expressed in the formula:

$$Ao = \text{Uptime} / (\text{Uptime} + \text{Downtime})$$

For the purposes of describing TMA/TMI systems/equipment, Uptime is equal to Mean Time Between Failure (MTBF) and Downtime is equal to Mean Down Time (MDT). The TMA/TMI formula for T (pf) becomes:

$$T (pf) = \text{MTBF} / (\text{MTBF} + \text{MDT})$$

Data to calculate T (pf) is extracted from the Navy's 3-M Database via the OARS. OARS provides a ten-year maintenance history of system/equipment performance.

MTBF (in days) is calculated using the formula:

$$\text{MTBF} = 1/(\text{No. Failures}/(30.44*0.667*\text{Population})) \text{ where}$$

- b. No. Failures = the number of Status 2 and 3 2-Kilos written per month. Status 2 is defined by 3-M as inoperative and Status 3 is degraded performance. Limiting 2-Kilo data to Status 2 and 3 eliminates approximately 75% of all 2-Kilos written and provides the basis for measuring mission degrading performance. Together the TMA/TMI process identifies these as "Deck Plate" CASREPs or maintenance actions that reduce a system or equipment's ability to satisfactorily perform in an operating environment. $30.44*0.667 = 30.44$ days in an average month times 0.667, which is defined by reference (b) as "the percentage of time that the system will be ready to perform satisfactorily in an operating environment". For sea-going systems this operating tempo is approximated as 2/3-calendar time.
- c. Population = the actual population of the system/equipment under evaluation or the number of platforms the system/equipment is installed in. Actual numbers of equipment is generally used for CS and larger HM&E items such as Main Engines or Ships Service Generators. Number of platforms is used for multiple installations of smaller HM&E items such as pumps or valves.
- d. MDT is computed by month directly from OARS and is the mean number of days from the opening of Status 2 or 3 2-Kilos until the Deck Plate CASREPs are corrected and the 2-Kilos closed. MDT is all-inclusive. It contains such items as Mean Logistics Delay Time, Administrative Time, Mean Total Time to Repair, etc. Breaking MDT down into the contributing elements requires expensive data collection and analysis and is not necessary for TMA/TMI purposes.

32.5.1.4.1 Time (problem free) Assessment. The resultant T (pf) meets the requirements of reference (b) and provides a means of assessing:

- a. Operational Availability of TMA/TMI systems/equipment.
- b. Effectiveness of the TMA/TMI program in resolving chronic problems in those systems/equipment.
- c. Systems/equipment trends in T (pf), MTBF and MDT over time.

Figure 32-5 Sample T(pf)

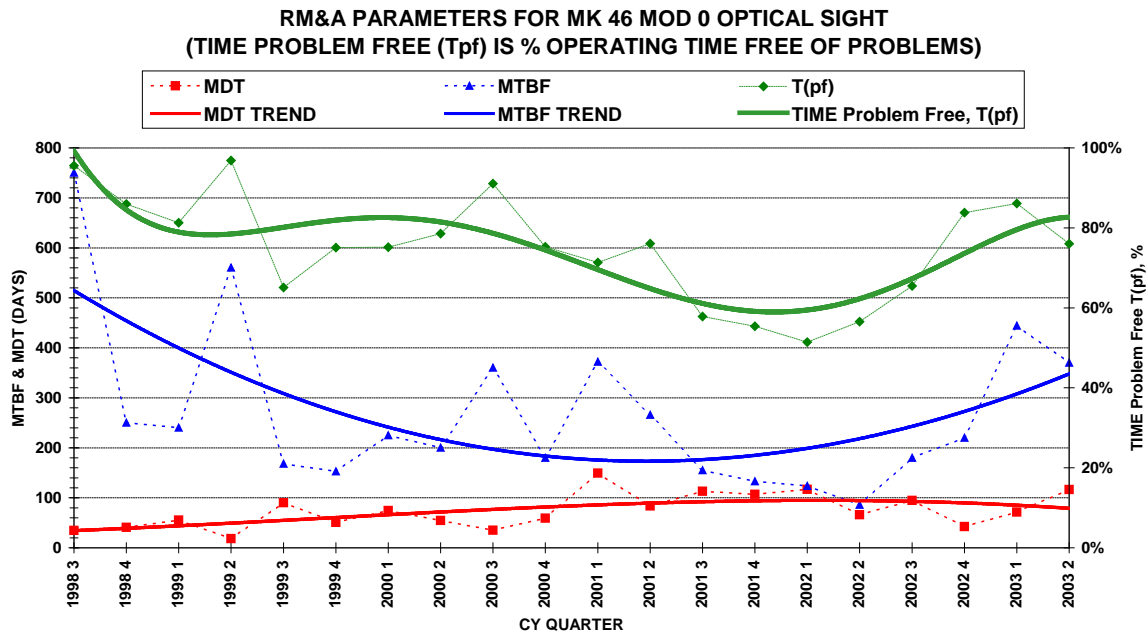

32.5.1.5 Failure Trend. The failure trend provides a failure history for the candidate TMA/TMI system/equipment. Hi-Priority Failures are plotted quarterly for the past five years and a polynomial trend line provides the direction of movement.

Figure 32-6 Sample Hi-Priority Failure Trend

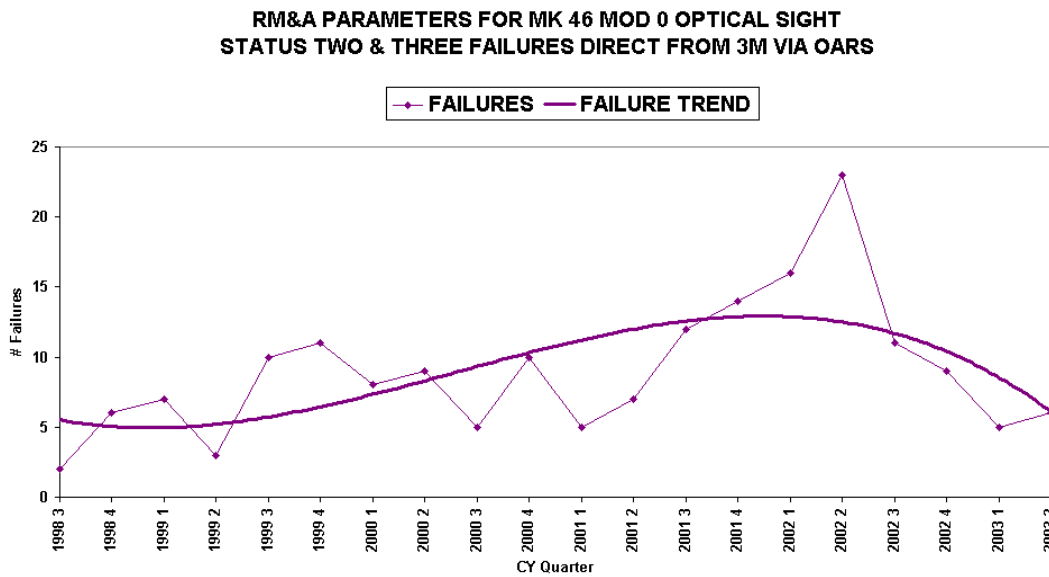

32.5.1.6 Parts Ranking. The Supply Parts Ranking Report, L0201, is a Ships 3-M Standard Report extracted from OARS. This report provides a quick method for determining fleet material problems based on total parts issued and total cost. Parts Ranking is the ten highest "TOTAL_PRICE" parts extracted from OARS. This represents total cost to the Navy, not necessarily to the individual unit. Cost to the unit will be increased for failure to turn in a Depot Level Repairable carcass. The Parts Ranking provides the National Item Identification Number (NIIN), abbreviated NIIN nomenclature, quantity and total cost per NIIN for the ten most expensive repair parts for the candidate system/equipment.

Figure 32-7 Sample Parts Ranking

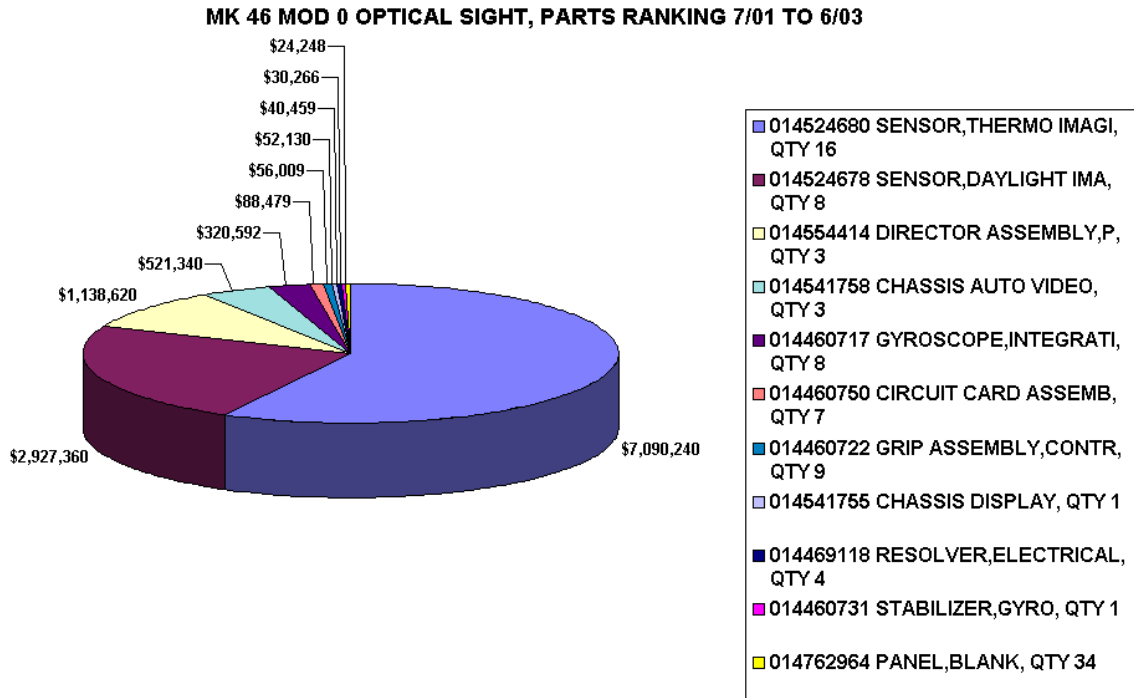

32.5.1.7 Ship's Logistics Indicator Computerized Report. The SLICR, L0106, is a Ships 3-M Standard Report extracted from OARS. The SLICR is intended to identify problem equipments within the fleet. The SLICR provides the following metrics:

- a. APL/EIC.
- b. APL_NOMENCLATURE/EIC_NOMENCLATURE.
- c. FAILURES: Count of maintenance actions with Status_Code 2 or 3.
- d. SF_MNHRS: Total number of Ship's Force man-hours expended by Ship's Force personnel or other installing personnel in completing and documenting the maintenance action.
- e. PART_ISSUES: Total number of 1250 and 1348 Supply Order Forms processed in support of maintenance.
- f. REPLCMNT_COST: The cost to replace parts used in maintenance with new (not refurbished) parts.
- g. IMA_MNHRS: Total number of IMA man-hours expended in completing and documenting the maintenance action.
- h. VISITS: The count of maintenance actions with TYCOM screening code = 1, 2 or 3.
- i. ACTIONS: A count of deferral, non-deferral and IMA maintenance actions.

- j. **OWNSHP_COST:** The sum of the cost of the labor of Ship's Force personnel, the cost of labor of the IMA personnel, the cost to replace non-repairable items and the cost to fix repairable items for a group of Job Control Numbers for a given APL or EIC.
- k. **COSAL:** COSAL Effectiveness is the probability a requested item is stocked onboard whether or not it is available when requested.
- l. **NET_COSAL:** NET Effectiveness is the probability that a stocked item is onboard when requested.
- m. **GROSS_COSAL:** GROSS Effectiveness is the probability that any requested item is onboard when needed and is the product of COSAL*NET effectiveness.
- n. **LOG_TIME:** The sum of (issue date – open date) divided by the total number of issues; average waiting time for a part issue in days.
- o. **MAINT_EFFECT:** The probability of all required repair parts for a given maintenance action being onboard.

Figure 32-8 Sample SLICR Report

APL	APL_NOMENCLATURE	FAILURES	SF_MNHRS	PART_ISSUES	REPLCMNT_COST	IMA_MNHRS	VISITS	ACTIONS	OWNSHP_COST	COSAL	NET_COSAL	GROSS_COSAL	LOG_TIME	MAINT_EFFECT
006040508	IMK46MOD0,OPTICAL SIGHT	79	6952	185	\$10,375,646	48	12	139	\$10,255,325	45.7	69.4	31.7	77	23.3

32.5.1.8 **Ranking Matrix.** The Ranking Matrix is similar to the TMA Ranking Matrix except that it provides data for all six TYCOMs and contains data on over 60,000 APLs. This fleet wide Ranking Matrix allows the Fleet to prioritize TMA/TMI selections on a Navy wide basis.

Figure 32-9 Sample Ranking Matrix

FUNCTIONAL AREA (L1)	EIC	EIC NOMENCLATURE (L2)	APL	APL NOMENCLATURE (L3)	apl_populatio	cn	count	cn_rank	total_mantn	rank	total_repair	trc	rank	hi_priority	hpf	rank	hi_priority	hpf	rank	casrep_vc	casrep_ra	BAL_VEC	BAL_RANK	MDT	MTBF	A(a)	R(m)	P(m)	\$Failure
GUN SYSTEMS	GV	WEAPON SYSTEM, CLOSE-IN, MK 15 (PHALANX)	006090237	MK7MOOD RADAR ASSEMBLY MODULE	270	7592	1	203171	2	\$21,890,449	1	1639	1	71419	1	501	1	19.94	1	19.94	1	44	80	64.8%	10.6%	89.4%	\$18,314		
GENERATION SYSTEMS, ELECTRIC POWER	37	GENERATOR SYSTEM, 100KW, STEWART AND STEVENSON MOI66780010E	006090238	ENGINE DSI, 16 1140001 1600 1800RPM	106	3016	3	298700	1	\$3,501,167	20	809	2	59993	2	122	3	10.16	2	70	64	47.5%	6.0%	94.0%	\$17,119				
HULL STRUCTURE	AD	DOORS, HATCHES, MANHOLES, SCUTTLES AND CLOSURES	319990011	WATERTIGHT DOORS, HATCHES, SCUTTLES NO OTHER APL	9229	2978	4	52793	25	\$366,450	465	378	12	112546	12	1	3170	9.75	3	298	11888	97.6%	96.5%	1.5%	\$6,291				
PROPULSION SYSTEM, MAIN GAS TURBINE, MECHANICAL DRIVE	D1	GAS TURBINE MODULE, PROPULSION	052630008	GAS GENERATOR ASSY>URB MN PRSN 7LM2500PB101	137	1794	12	156811	4	\$15,261,673	2	456	9	34541	9	115	4	9.34	4	76	146	65.9%	29.2%	70.8%	\$47,268				
ADMINISTRATION HABITABILITY, OUTFIT/FURNISHINGS	1A	EQUIPMENT AND FURNISHINGS, UTILITY SPACE	439990247	PLASTIC PROCESSOR MELT UNIT 593-6961200	530	1831	11	63246	16	\$2,197,163	43	471	8	62184	8	77	17	6.37	5	132	548	80.6%	72.0%	26.0%	\$10,036				
GENERATION SYSTEMS, ELECTRIC POWER	36	GENERATOR SET, GAS TURBINE	052090005	ENG ASSY, GAS TURB MDL 501K34	117	1249	34	59905	19	\$11,631,984	4	189	38	10109	38	76	19	5.97	6	53	301	84.9%	56.0%	45.0%	\$74,223				
NAVIGATION SYSTEMS (ELECTRONIC AND NON-ELECTRONIC)	LB	GYROCOMPASS (CIRCUIT LC AND XLC)	282000010	ANWNS2 SET, GYROCOMPASS STABILIZED	62	242	560	5592	626	\$12,666,477	3	72	289	4822	289	36	74	5.80	7	67	419	86.2%	65.1%	34.9%	\$179,016				
GUN SYSTEMS	GV	WEAPON SYSTEM, CLOSE-IN, MK 15 (PHALANX)	006090238	MK20MOOD ELECTRONIC ASSEMBLY ENCLOSURE	270	2267	7	61719	17	\$4,504,972	14	545	4	21046	4	156	2	5.79	8	39	241	86.2%	47.4%	52.6%	\$12,796				
MISSILE SYSTEMS, SURFACE	51	FIRE CONTROL SYSTEM, GUNMISSILE, MK 92 MOD 2	006080059	MK92MOD2 FIRE CONTROL SYSTEM (BASELINE)	18	1360	24	34045	53	\$4,320,047	15	579	3	35400	3	97	7	5.31	9	61	15	19.8%	0.0%	100.0%	\$9,813				
DISTRIBUTION SYSTEMS, ELECTRICAL POWER	45	DISTRIBUTION SYSTEM, AC LIGHTING	249990138	LANTERN ELEC 18VAC SYM 101 2	89256	2829	6	38046	41	\$414,519	296	535	5	40673	5	2	3169	5.08	10	76	81233	99.9%	99.8%	0.2%	\$3,619				
GUN SYSTEMS	66	WEAPON SYSTEMS, GUN	006049008	MK46MOOD OPTICAL SIGHT	34	246	552	19532	216	\$10,683,899	5	79	226	6291	226	58	27	5.05	11	80	210	72.5%	42.4%	57.6%	\$143,154				
MISSILE SYSTEMS, SURFACE	56	WEAPON SYSTEM, AEGIS, MK 7 MOODS	78292335A	QJ-9H4(V)UYA-4(V) LESS P-1091	192	595	135	179318	3	\$1,469,130	80	144	79	6980	79	14	270	4.91	12	49	649	93.0%	75.8%	24.2%	\$59,735				
AUXILIARY SYSTEMS	TF	AIR SYSTEMS, COMPRESSED	061430265E	COMPRESSOR AIR HIGH PRESSURE 20CFH 3000PSI	57	1299	28	61519	18	\$1,947,981	51	520	6	28620	6	88	9	4.63	13	55	53	64.9	49.3	3.4%	96.6%	\$8,478			
DISTRIBUTION SYSTEMS, ELECTRICAL POWER	45	DISTRIBUTION SYSTEM, AC LIGHTING	249990001	FUTURE LGTG FLRSNT MS17179-77.4	128672	2938	5	50774	31	\$1,142,422	95	397	11	30912	11	0	4948	4.38	14	78	15713	100.0%	99.9%	0.1%	\$7,993				
PROPULSION SYSTEM, MAIN GAS TURBINE, MECHANICAL DRIVE	D1	GAS TURBINE MODULE, PROPULSION	052630018	GAS GENERATOR ASSEMBLY MDL L26250G12	66	664	114	41219	39	\$9,613,557	6	180	60	11454	60	42	58	3.46	15	72	201	73.7%	40.8%	59.2%	\$64,139				
COMMUNICATION AND DATA SYSTEMS	QF	CRYPTOGRAPHIC EQUIPMENT	88633661	TA870U, TELEPHONE SET	5523	3157	2	20592	128	\$626,720	230	490	7	24727	7	0	4947	4.30	16	50	5488	99.1%	96.8%	3.2%	\$2,755				
GENERATION SYSTEMS, ELECTRIC POWER	31	PLANTS, GENERATING, SHIPS SERVICE	052090002	ENGINE GAS TURBINE SHIPS SER GEN	78	1297	29	81095	6	\$4,969,763	11	317	15	12600	15	86	11	4.27	17	41	120	74.6%	22.3%	77.7%	\$25,910				
AUXILIARY SYSTEMS	T8	FIREMAINS, FLS, SP4LR, WASHDOWN AND SALT WATER SER.	088261261	VALVE GLB 2.50IPS 250PSI FLGE X MHSTH BRZ	10551	892	74	23865	106	\$196,813	639	186	43	49673	43	0	4957	4.25	18	267	27620	99.0%	99.4%	0.6%	\$6,190				
PROPULSION SYSTEM, MAIN-STEAM, MECHANICAL DRIVE	F7	PIPING, VALVES AND ACCESSORIES, MAIN STEAM	88705403R	VALVE GLB STP 50IPS 900PSI SWLDG STL	5706	1034	51	23170	108	\$71,477	1790	43	567	42783	567	0	5129	3.62	19	995	64612	99.6%	99.7%	0.3%	\$23,216				
GENERATION SYSTEMS, ELECTRIC POWER	31	PLANTS, GENERATING, SHIPS SERVICE	66988004L	ENGINE DIESEL GEN 363SSV-AM MDL 2894F01-GEN 6CY	36	1490	19	369976	44	\$9,982,757	19	237	23	14656	23	92	8	3.58	20	62	74	54.5%	40.8%	91.2%	\$2,046				
MISSILE SYSTEMS, SURFACE	56	WEAPON SYSTEM, AEGIS, MK 7 MOODS	ME015664	AM4800SPY-1A C64778B, AMPLIFIER,RADIO FREQ	48	1151	43	72676	10	\$4,000,218	16	336	14	13133	14	19	177	3.52	21	40	72	64.0%	8.1%	91.9%	\$21,433				
AUXILIARY SYSTEMS	TF	AIR SYSTEMS, COMPRESSED	061430267	COMPRESSOR UNIT 20.0CFH 3000PSI	36	736	97	51315	30	\$1,446,433	81	253	20	30891	20	55	26	3.49	22	122	69	36.1%	7.4%	92.6%	\$19,830				
AUXILIARY SYSTEMS	T8	FIREMAINS, FLS, SP4LR, WASHDOWN AND SALT WATER SER.	099090613	NOZZLE-TYPE SB, WASHDOWN COUNTERMEASURES SYSTEM	10225	349	327	15134	223	\$1,115,318	1152	136	89	41816	89	3	2037	3.49	23	307	36608	99.2%	99.5%	0.5%	\$6,299				
RADAR AND IFF SYSTEMS	P3	RADAR, AIR SEARCH	95228006	AS-3233SPS-49(V), ANTENNA	90	274	480	13203	285	\$2,486,394	7	51	448	3977	448	25	121	3.47	24	78	669	91.7%	81.1%	18.9%	\$157,147				
AUXILIARY SYSTEMS	TD	FILLING, VENT AND TRANSFER SYSTEM (FUEL AND DIESEL OIL)	882049342A	VALVE GATE 6.00IPS FLGE STL	248	46	3463	1660	290	\$2,167	14581	36	732	42675	732	0	5193	3.44	25	1183	3354	73.9%	94.8%	5.2%	\$1,905				
AUXILIARY SYSTEMS	T7	PLUMBING INSTALLATIONS	017000043	PUMP CTRFL 100GPM 30PSI 175RPM MCC VLT	235	466	212	28432	75	\$309,336	602	134	93	39703	93	25	130	3.44	26	296	654	74.2%	81.0%	19.0%	\$10,049				
PROPULSION SYSTEM, MAIN DIESEL, MECHANICAL DRIVE	B1	ENGINE AND CONTROLS, DIESEL	668880032L	ENGINE DIESEL 363SSV-AM MDL 2894F01 6CYL	48	1538	16	36021	47	\$4,013,172	18	179	46	15643	46	80	15	3.39	27	87	131	59.9%	25.2%	74.8%	\$30,469				
MISSILE SYSTEMS, SURFACE	56	WEAPON SYSTEM, AEGIS, MK 7 MOODS	ME403291	AM7159SPY-1B D0661T90, AMPLIFIER RADIO FREQ	120	833	84	16563	194	\$6,525,854	8	156	66	3220	66	44	3.34	28	21	375	94.8%	61.8%	38.2%	\$46,079					
HULL STRUCTURE	AD	DOORS, HATCHES, MANHOLES, SCUTTLES AND CLOSURES	319990907	MISC STEEL W/AT CLOSURE COMMON REPAIR PARTS	731	1175	40	86538	5	\$640,699	183	138	87	24884	87	0	4967	3.31	29	190	2579	93.5%	93.3%	6.7%	\$29,726				
COMMUNICATION AND DATA SYSTEMS	QD	TRANSCIVERS (COMMUNICATION)	00014937	ANPRC-114(V), RADIO SET	1004	927	69	8932	483	\$240,689	508	190	36	37351	36	0	4953	3.29	30	197	2573	92.9%	93.2%	6.8%	\$3,147				
AUXILIARY SYSTEMS	TC	SCUPPERS AND DECK DRAINS	679900055	DRAIN DK, SZ 2.000 IN	10075	840	81	10693	388	\$117,398	1131	180	37	37488	37	0	4954	3.28	31	197	25819	99.2%	99.3%	0.7%	\$2,869				
GUN SYSTEMS	GV	WEAPON SYSTEM, CLOSE-IN, MK 15 (PHALANX)	006090242	M61A1 20MM GUN	270	1555	16	67966	12	\$3,136,393	25	246	21	8752	21	44	66	3.19	32	36	534	93.8%	71.4%	28.6%	\$23,799				
RADAR AND IFF SYSTEMS	P1	RADAR, SURFACE SEARCH	57041000	ANVSPS-65, RADAR SET	81	813	87	17709	174	\$2,216,016	42	219	28	13164	28	112	5	3.18	33	60	180	75.0%	36.8%	63.2%	\$13,353				
MISSILE SYSTEMS, SURFACE	56	WEAPON SYSTEM, AEGIS, MK 7 MOODS	ME403311	T-1349/SPG D0661T90, TRANSMITTER,BASELINE	120	940	64	24141	101	\$5,475,373	9	132	95	4160	95	55	29	3.03	34	32	443	93.4%	66.6%	33.4%	\$48,796				
MISSILE SYSTEMS, SURFACE	53	LAUNCHER SYSTEMS	006090067	MK30MOD6 FIRE CONTROL SYSTEM (BASELINE)	12	679	112	19143	148	\$4,587,678	13	161	58	18616	58	51	39	3.02	35	116	36	23.9%	0.7%	99.3%	\$33,251				
GENERATION SYSTEMS, ELECTRIC POWER	31	PLANTS, GENERATING, SHIPS SERVICE	166538269	DIESEL ENG, MDL 38ND8 1-8 12 CYL	32	962	62	79314	8	\$800,932	141	162	57	19018	57	39	66	3.01	36	117	96	45.0%	15.4%	84.6%	\$24,528				
GUN SYSTEMS	6W	HANDLING EQUIPMENT, AMMUNITION	596030047	HOIST CHN AIR OPER CAP 4000LBS	193	47	3410	1513	3020	\$99,586	1324	33	801	36876	801	0	5220	2.98	37	1117	2648	71.8%	93.9%	6.1%	\$4,852				
PROPULSION SYSTEM, MAIN DIESEL, MECHANICAL DRIVE	B1	ENGINE AND CONTROLS, DIESEL	669880067M	ENGINE DSI,0363SPV-AM MDL 2949F01 8 CYL	24	1167	42	39519	50	\$1,834,152	56	167	54	11568	54	98	6	2.96	38	69	70	50.3%	7.6%	92.4%	\$19,514				
MISSILE SYSTEMS, SURFACE	56	WEAPON SYSTEM, AEGIS, MK 7 MOODS	ME015659	AM4889SPY-1A C64778B, AMPLIFIER,RADIO FREQ	72	719	99	77650	9	\$3,498,322	21	201	39	6049	39	24	129	2.95	39	30	174	85.3%	36.6%	64.4%	\$32,738				
COMMUNICATION AND DATA SYSTEMS	Q7	AMPLIFIERS, AUDIO	00023028	AM-3729SR, AMPLIFIER,AUDIO FREQ	9129	1895	10	11203	369	\$372,466	338	189	38	27052	38	0	4955	2.92	40	143	23519	99.4%	99.2%	0.6%	\$4,342				
AUXILIARY SYSTEMS	T7	PLUMBING INSTALLATIONS	882304005	VALVE B 4.00IPS 100PSI FLGE BRZ	755	309	395	3994	1178	\$60,175	2096	57	389	36828	389	1	5057	2.92	41	629	6449	91.1%	97.2%	2.8%	\$3,889				
MISSILE SYSTEMS, SURFACE	56	WEAPON SYSTEM, AEGIS, MK 7 MOODS	ME403292	AM7159SPY-1B D0661T90, AMPLIFIER RADIO FREQ	80	1089	47	18168	164	\$5,223,554	10	176	50	3652	50	43	57	2.92	42	20	221	91.6%	44.3%	55.7%	\$33,808				
COMMUNICATION AND DATA SYSTEMS	Q6	TRANSCIVERS (COMMUNICATION)	00008096	AM-3924D(P)URT, AMPLIFIER,RADIO FREQUENCY	434	1332	26	17286	180	\$1,657,833	70	354	13	16016	13	48	43	2.90	43	45	597	93.0%							

(This Page Intentionally Left Blank)

APPENDIX A

TOP MANAGEMENT ATTENTION AND
TOP MANAGEMENT ISSUES
FLOWCHART

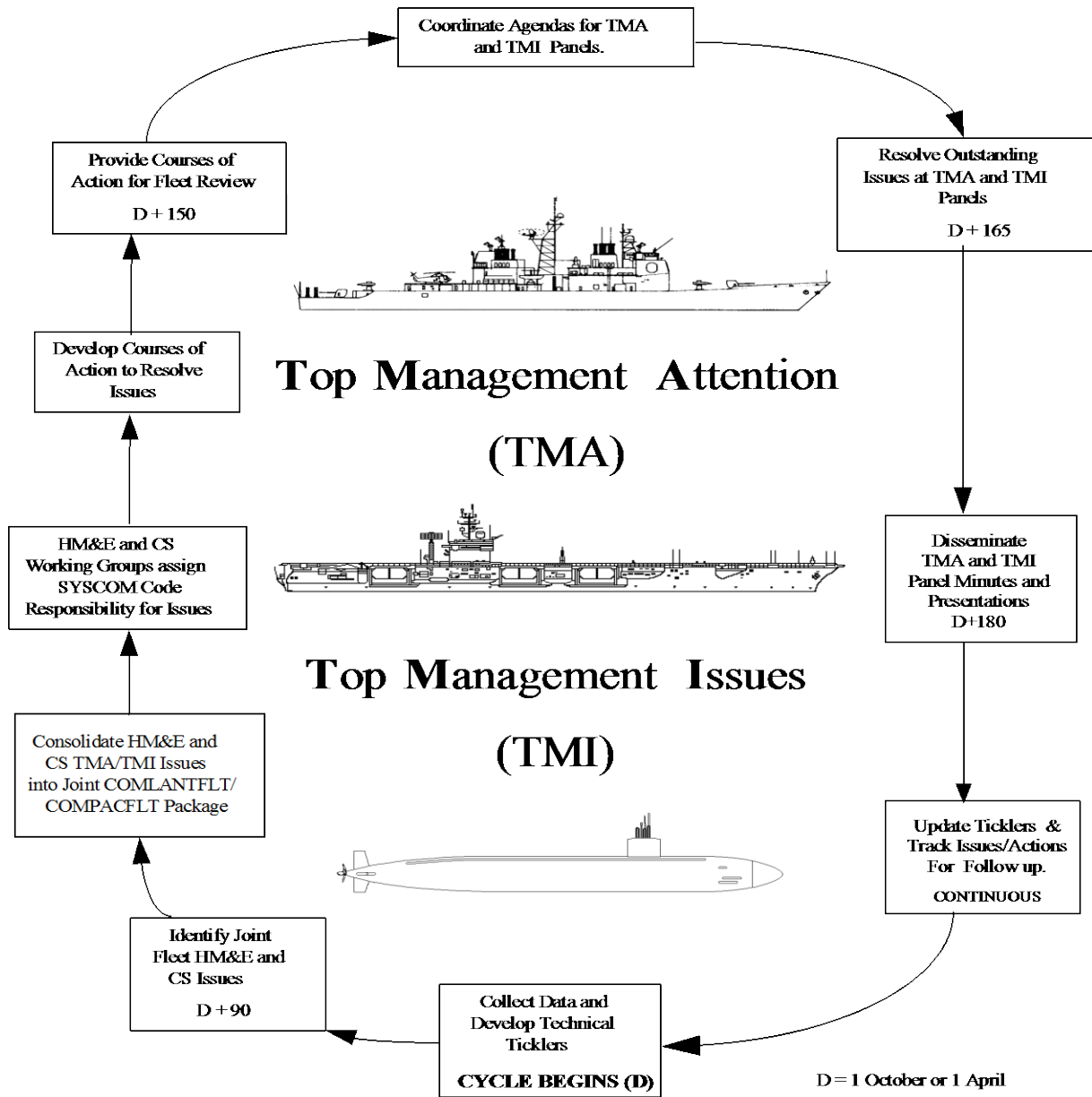

(This Page Intentionally Left Blank)

VOLUME VI
CHAPTER 33

MAINTENANCE AND MODERNIZATION BUSINESS PLAN

REFERENCES.

- (a) OPNAVENOTE 4700 - Representative Intervals, Durations, Maintenance Cycles, and Repair Mandays for Depot Level Maintenance Availabilities of U.S. Navy Ships

LISTING OF APPENDICES.

A. Executive Summary Sheet

33.1 MAINTENANCE AND MODERNIZATION BUSINESS PLAN.

- a. The Maintenance and Modernization Business Plan (MMBP) identifies the total private sector maintenance funding budget available to support the ship during the execution year and advance planning and funding needs for availabilities to be executed in future years. The MMBP also includes funding for modernization. This includes funding for all Fleet Alterations and those Program Alterations managed by the Type Commander (TYCOM) or Naval Supervisory Authority (NSA) (Regional Maintenance Center (RMC)/Naval Shipyard/Supervisor of Shipbuilding). The MMBP does not include funding for modernization that is managed by the Ship's Program Manager (SPM) or Participating Acquisition Resource Manager and accomplished by Alteration Installation Teams through separately administered contracts.
- b. MMBPs will be developed for all ships that will be in commission at the start of the upcoming Fiscal Year (FY). A second MMBP will be developed for any ship scheduled to start a Chief of Naval Operations (CNO) Availability in the first quarter of the following FY. This second business plan will address only the CNO Availability controls, a Risk Assessment and will not include Continuous Maintenance (CM) controls. The TYCOM will normally use the same TYCOM Target Controls for these out-year CNO Availabilities as used for the upcoming FY CNO Availability controls. These out-year MMBPs will require additional refinement in the next MMBP cycle.

33.2 MMBP RESPONSIBILITIES.

33.2.1 Maintenance Team Responsibilities. The Maintenance Team identifies budget needs to the NSA and the TYCOM based on well-documented work in the Current Ship's Maintenance Project (CSMP) and Class Maintenance Plan. The Maintenance Team MMBP identifies the total maintenance funding.

- a. The Maintenance Team establishes the funding phasing plan that will roll up to the Fleet Commander's overall phasing plan. It should be noted that the accuracy of the phasing plan is critical to the Fleet and TYCOM's ability to provide timely and stable funding. A Maintenance Team over executing or under executing its budget will cause unnecessary funding churn. For this reason, Maintenance Teams and NSAs should develop phasing plans that are accurate and reasonably achievable. For example, if a CNO Availability is scheduled to start in the first month of a quarter, the funding for that availability will be required in the previous quarter and should be phased in the earlier quarter. CM phasing will depend largely on ships' schedules and should not simply be divided into four equal quarters in the phasing plan.
- b. Each Maintenance Team will include an assessment of known material readiness risks associated with the MMBP funding levels in their initial MMBP submittal. In a case where there is unacceptable risk associated with the assigned funding controls, the TYCOM may agree to adjust assigned controls.
- c. Maintenance Teams shall use the format provided in Appendix A for MMBP submission.

33.2.2 NSA Responsibilities. For submarines and aircraft carriers, actions assigned below to the NSA may be performed directly by the TYCOM or a designated agent (i.e., Immediate Superiors In Command (ISIC), Trident Refit Facility, or Naval Submarine Support Center).

- a. The NSA has the authority to execute ship maintenance and shall do so in accordance with Fleet and TYCOM policies and directives.
- b. When conditions warrant, the NSA will develop a Business Adjustment Factor (BAF) percentage for CNO Availabilities to account for local business conditions. BAFs are established as a percentage of the availability budget, similar to the growth or award fee percentages. The BAF is an adjustment or hedge against impacts to the manday rate or premium levels for specific CNO Availabilities due to factors such as high or low port loading. Examples of other situations that may require an allowance in the BAF are seasonal adverse weather patterns, anticipated labor union issues, anticipated labor rate adjustments or the general business conditions in the port.
- c. The NSA will make any additional adjustments to TYCOM target controls based on prioritization of the work package, risk analysis and Business Case Analysis (BCA) included in the Maintenance Team's MMBP submissions. The overall, total NSA CNO Availability funding controls and total CM funding controls provided to the NSA by the TYCOM may not be exceeded in these adjustments.
- d. (Surface Ships only) During the year of MMBP execution, changes to individual ship controls exceeding 10% require TYCOM notification; changes in excess of 20% require TYCOM approval. In the event adjustments are required that exceed available funds, the NSA will provide a written justification supporting the change and a formal recovery plan to the TYCOM for approval.
- e. Appendix A may be modified as required, with TYCOM concurrence, for unique NSA processes or circumstances.

33.2.3 TYCOM Responsibilities (Surface Force Ships only).

- a. Establish Force maintenance policies, directives and authorize the NSA to execute those policies and directives.
- b. Provide Target Controls to the NSA in March of each year and review those controls as required by the budget approval process. These controls are between the TYCOM and the Port Engineer.
- c. Ensure the established modernization plan is accurate and issue Fleet Alteration Letters of Authorization.
- d. Validate MMBPs and promulgate approved CNO availability and Continuous Maintenance funding controls in naval message format at the beginning of each fiscal year.
- e. Align Surface Warfare Enterprise processes with established waterfront support organizations and establish the readiness and cost control processes required to provide greater overall enterprise effectiveness.
- f. Support the ISIC with warships ready for tasking by aligning manning, training, equipping and maintaining processes of ships by class.
- g. Assess current readiness, analyze metrics, examine trends, determine root causes, establish lessons learned and provide recommendations and solutions, while emphasizing readiness and cost control.
- h. The TYCOM will provide the RMCs with TYCOM Target Controls in March of each year and will revise these controls as required by the budget approval process.

33.2.4 TYCOM Responsibilities (Aircraft Carriers and Submarines only). The TYCOM establishes Force maintenance policies and directives and authorizes the NSA to execute those policies and directives.

- a. The TYCOM ensures that the established modernization plan is accurate and issues Fleet Alteration Letters of Authorization.
- b. The TYCOM has final approval of all MMBPs and will promulgate approved CNO Availability and CM funding controls in naval message format.

33.2.5 Ship Program Manager Responsibilities. The SPM ensures that the Letter of Authorization for Program Alterations is accurate and includes Program Alterations funding estimates.

33.3 THE MMBP SUBMISSION.

33.3.1 MMBP Spreadsheet. The required format for submission of MMBPs is provided in Appendix A of this chapter. As noted in paragraph 33.2.2.e. of this chapter, changes may be made to Appendix A to reflect NSA unique circumstances.

33.3.1.1 General Description. The MMBP provides the maintenance team's description of the planned maintenance and funding phasing.

33.3.1.2 Executive Summary Sheet.

- a. Section I: The Schedule Overview is intended to illustrate major milestones in the current and upcoming year: assessments, deployments, availabilities, decommissioning, etc.
- b. Section II: This section begins with initial controls (CNO and CM) and applies adjustments to those controls by TYCOM and RMC. The final numbers in each of these categories are funds available for assignment to CM and CNO work as appropriate. Particular care must be taken to ensure that the sign (where subtraction has a "-" or a number is preceded and followed with parentheses, e.g., "(10)" indicating a negative number) of these numbers are correct, as they are linked to the CONTROLS AND PHASING sheet.
- c. Section III: Ensure that program alterations (K-Alterations) are included here and not included in other locations. D-Alterations, Machinery Alterations, and Ship Change Documents should be located in Section II.
- d. Section IV: This section provides an area for the maintenance teams to indicate areas of risk associated with the particular FY's maintenance plan. This section does not include topics that are not applicable to the execution FY risk. Areas to be discussed here:
 - (1) Work items identified in the UNFUNDED REQUIREMENTS sheet, and their impact to current or future operations.
 - (2) Upcoming assessments that may identify serious discrepancies.
- e. Section V: This section provides a general rollup of the work planned for the execution FY. Items in this section need not be identified by Job Control Number/Job Sequence Number, but rather a general layout of work to be brokered to individual availabilities and their notional values; this should include historical repairs from assessments. The bottom of this sheet sums items from other portions of the workbook for comparison purposes. Items of note in this section:
 - (1) The items identified in the "green" section of Section V are planned for completion in the execution FY and therefore are not elements of risk.
 - (2) The "shortfall" cell should be equal to or less than the UNFUNDED cell.
 - (3) The Risk section on the bottom of the spreadsheet feeds directly from the UNFUNDED REQUIREMENTS SHEET. This section sums the unfunded items by funding type and then by associated risk (see paragraph 33.3.1.4 of this chapter).

33.3.1.3 Controls and Phasing Sheet. This sheet applies changes (growth pools, overhead, award fees, and the business adjustment factors) to the adjusted controls. This sheet provides a further adjustment to the controls, as well as a phasing of the controls that should be completed by the Maintenance Teams so as to reflect the maintenance schedule. Particular care should be taken to ensure that sums are correct, since TYCOMs use this sheet to plan quarterly cash flows.

33.3.1.4 Unfunded Requirements Sheet.

- a. This sheet identifies those items in the Class Maintenance Plan or validated maintenance items in the ship's CSMP that cannot be completed in the execution FY due to funding constraints. To be included in the UNFUNDED REQUIREMENTS list, the following conditions must be satisfied:
 - (1) The work can be accomplished in the time available if additional funding is applied, and/or
 - (2) The work can be accomplished in the execution year if additional Continuous Maintenance Availability (CMAV)/CNO time were allotted.

- b. The column marked "Funding Type" has permissible entries: CM, CNO and AP. They are meant to indicate the most likely funding areas to which the work would be brokered if funding were available.
- c. The "Risk" column has permissible entries of "High," "Medium" and "Low" as determined by a BCA guided by Volume II, Part I, Chapter 4, Appendix D of this manual. These columns must be populated in order to properly assess the risk associated with the MMBP, as well as to feed properly to the Executive Summary Sheet.

33.3.2 Prioritization. Maintenance Teams should use any and all resources at their disposal to prioritize the work for which funds are available. The prioritized work should support the ship's current readiness requirements as well as work designed to ensure the ship can operate effectively its full service life.

33.3.3 Maintenance Summary and Risk Assessment. The Maintenance Team and TYCOMs will address any known maintenance risks based on Funding Controls or ship's maintenance schedule for the upcoming FY. This risk assessment must provide sufficient detail to enable NSA/TYCOM to make critical decisions with respect to funding adjustments. Photographs, inspection reports, docking reports, operating logs, vibration analysis, Maintenance Figure of Merit (MFOM) data and other objective evidence of important maintenance which is not able to be accomplished within the Maintenance Teams funding controls should be included.

33.4 BUDGET PROCESS AND MMBP DEVELOPMENT TIMELINE.

33.4.1 Guidance. In order to develop MMBPs prior to the start of the FY in which they will be executed, it is necessary to begin the process well before the final budget is approved and financial controls are passed to the Fleet Commanders, TYCOMs, and eventually to the Maintenance Teams. Maintenance Teams shall develop MMBPs using the following guidance and timeline. For submarines and aircraft carriers, actions assigned below to the NSA may be performed directly by the TYCOM or a designated agent (i.e., ISICs, TRIDENT Refit Facility, or Naval Submarine Support Center).

33.4.2 Initial Budget Guidance (March).

- a. The TYCOM, in coordination with the Fleet Maintenance Officer, will establish an initial estimate of the expected funding controls for the next FY. Based on this information, TYCOMs will develop a common maintenance funding strategy, establish initial TYCOM Target Controls for each ship's CNO Availability and each ship's CM budget. The CM budget provides funds for both the yearlong continuous availability and scheduled CMAVs. TYCOM Target Controls are passed from the TYCOM to the Maintenance Team as the initial input to the MMBP process.
- b. The TYCOM and the SPM will ensure Letters of Authorization accurately reflect the modernization plan. SPMs and Participating Acquisition Resource Managers will provide installation estimates for Program Alteration installations or installation support services for which funding will be provided to the Maintenance Team. The TYCOM Target Controls discussed above will be separated into Fleet maintenance and Fleet funded alteration controls by the TYCOM before the controls are passed to the NSA.

33.4.3 Provide Controls to Maintenance Team (April).

- a. The Maintenance Teams will use the Class Maintenance Plan to develop assessment schedules with NSA for inclusion in individual MMBPs.
- b. ISIC shall provide ship operational schedule information to the Maintenance Team. This information is used to schedule CMAVs and Assessments for the upcoming year.
- c. The NSA will establish BAF if required for each CNO Availability, anticipated CNO Availability and CM growth percentages, support service percentages and Award Fee percentages as applicable for entry into the MMBP Budget Planning Sheet, Appendix A. For surface ships, Maintenance Teams may modify target controls for ships within a class based on their relative material condition.
- d. Maintenance Teams will develop MMBPs based on these initial controls. This iterative process will involve risk assessment and BCA of any differences between the Maintenance Teams identified funding needs and the funding controls established for them.

33.4.4 Execution Strategy Adjustments (May). The TYCOM in coordination with Fleet Commanders will determine if adjustments to the TYCOM Target controls are required. For surface force ships, the TYCOM will provide the NSA with direction for the adjustment of controls.

33.4.5 (Surface Ships only) Maintenance Team Submit MMBPs for Approval via NSA (June). The NSA approves, consolidates and submits copies of each assigned ship's MMBP to the TYCOM for review and approval.

33.4.6 TYCOM Approves MMBPs (July).

- a. The TYCOM approves MMBPs and promulgates final approved CNO availability and CM controls.
- b. The TYCOM/RMC provides final CNO budget controls and CM controls to the Maintenance Teams.

33.4.7 Submit Phasing Plans (August).

- a. The NSA funds administrators will review and adjust each Maintenance Team's phasing plan to correspond with the total controls. Each NSA will provide the Maintenance Team phasing plans to TYCOM.
- b. The TYCOM will submit phasing plans to the Fleet Commander.

33.5 BUSINESS PLAN RESOURCES.

33.5.1 Resources. The following resources and information shall be reviewed and considered in the development of MMBPs. This list is not intended to be all-inclusive and is provided as a starting point.

- a. The notional CNO man-day requirements used by the TYCOM to establish initial TYCOM Target Controls.
- b. The ship's CSMP.
- c. The ship's Baseline Availability Work Package.
- d. The Class Maintenance Plan.
- e. Areas of specific concern that will be assessed or inspected prior to the availability.
- f. Modernization Plan - Program and Fleet Alterations.
 - (1) Program Ship Change (SC) Authorization letters provided by Program Executive Officer Ships include NAVSEA, Space and Naval Warfare Systems Command (SPAWAR), Naval Supply Systems Command and Naval Air Systems Command (NAVAIR) planned installations.
 - (2) Fleet SC Authorization letters provided by the TYCOM include Fleet Alterations, Alterations Equivalent to Repair, and Machinery Alterations.
 - (3) Information contained in Program Executive Officer/Systems Command and TYCOM SC authorization letters will be consolidated into Hull Modernization Plans. Hull Modernization Plans will list all SCs (Program and Fleet Alterations) programmed for installation on each ship for the entire FY.
- g. Deployment and operational schedules.
- h. Assessment and inspection schedules (Hull, Mechanical, Electrical Readiness Assessment (HMER), Command, Control, Communications, Computers and Combat Systems Readiness Assessment (C5RA), Board of Inspection and Survey (INSURV), etc.).
- i. Ship's event schedules (Change of Command, etc.).
- j. Long-term ship's CNO Availability and decommissioning schedule.
- k. CNO Availability and CMAV Planning Milestones.
- l. Departures from Specifications.

- m. Habitability Project Plan/Schedule (TYCOM provide).
- n. Other Availability Programs (TYCOM provide).
 - (1) Underwater Hull Cleaning.
 - (2) Calibration.
 - (3) Other miscellaneous.

**APPENDIX A
EXECUTIVE SUMMARY SHEET**

USS XXX (XX-XX)
MAINTENANCE AND MODERNIZATION BUSINESS PLAN
FY 2010

PORT ENGINEER: PE
PROJECT MANAGER: PM

I. SCHEDULE OVERVIEW

	EVENT	DATES	
A.	CNO Availability (Start/End)		
B.	Continuous Maintenance Avails (CMA)		
	CMA 0A1 (Start/End)		
	CMA 0A2 (Start/End)		
	CMA 0A3 (Start/End)		
	CMA XA4 (Start/End)		
C.	Surge Ready Asset		
	(Start/End)		
	(Start/End)		
D.	Assessments - Major		
	PSART (Start)		
	C5RA (Start)		
	Main Propulsion Plant Assessment DEI 1, 3 SSDG (Start)		
	Main Propulsion Plant Assessment Gas Turbine Inspections (Start)		
	Total Ship Readiness Assessment (TSRA) (1, 2, 3, 4) (Start)		
E.	Training Cycle		
	Ultra E + C (Engineering and Combat Readiness Training Assessment, 12M Cert) (Start)		
	Ultra S+ (Sustainment, 12M Cert) (Start)		
	Group Exercise (Start)		
	Group Certification (Start)		
F.	Deployment		
		Deploys	Returns

**APPENDIX A
EXECUTIVE SUMMARY SHEET (Cont'd)**

	EVENT	DATES	
G.	INSURV (Last/Next)		
		Deploys	Returns
H.	Outyear CNO Availabilities		
	(Start/End)		
	(Start/End)		
	(Start/End)		
I.	Docking CNO Avail - Next (Start/End)		
J	Planned DECOMM Date (End)		

II. TYCOM FUNDING CONTROLS

A.	MFOM Data		
	a.	Class Average Weighted MROM (MFOMw)	\$0
	b.	MFOMw	\$0
B.	Continuous Maintenance & I - Level Expenditures		
	a.	Initial TYCOM CM Target Control (total)	\$0
	b.	CM Control Designated for Fleet Alterations	\$0
	c.	RMC Net Target Control for Maint (c+d)	\$0
	d.	Prior Year Funds Available	\$0
	e.	RMC Adjustments (Indicate + or -)	\$0
	f.	FY-10 TYCOM Funding CM CONTROL (Maint) e+f+g	\$0
	g.	FY-10 TYCOM Funding DIL CONTROL (Maint)	\$0
	h.	Total TYCOM CM & DIL Control (h+b+i)	\$0
C.	FY-10 CNO Avail		
	a.	Initial TYCOM Target Control (total)	\$0
	b.	CNO Avail Control Designated for Flt Alts	\$0
	c.	CNO Maint Control before Adjustment(a-b)	\$0
	d.	RMC Net Target Control for Maint	\$0
	e.	Prior Year Funds Available	\$0
	f.	RMC Adjustments (Indicate + or -)	\$0
	g.	TYCOM Funding CNO CONTROL (Maint) (e+f+g)	\$0
	h.	Total TYCOM CNO Control (h+b)	\$0
D.	Advance Funding Previously Obligated on FY-10 CNO Avail		
	a.	FY-08 Advance Funding	\$0
	b.	FY-09 Advance Funding	\$0
	c.	TOTAL	\$0

**APPENDIX A
EXECUTIVE SUMMARY SHEET (Cont'd)**

E.	Advance Funding for FY-11 CNO Avail		
	a.	FY-09 Advance Funding	\$0
	b.	FY-10 Advance Funding	\$0
F.	Habitability (TYCOM N43 Managed & Funded)		
G.	ORATA (TYCOM N43 Managed & Funded)		
	a.	Underwater Hull Cleaning	\$0
	b.	Calibration, other Misc ORATA Programs	\$0
	c.	Total	\$0
H.	Assessments (Mission Funded - estimates for RMC budgeting only)		
	a.	HMERA	\$0
	b.	C5RA	\$0
	c.	TSRA	\$0
	d.	Total	\$0

III. PROGRAM ALTERATION FUNDING CONTROLS (Funding Managed by RMC)			
A.	NAVSEA (PEO-SPM)		
	a.	CNO Avail Program Alteration Controls	\$0
	b.	CM Program Alteration Controls	\$0
B.	SPAWAR		
	a.	CNO Avail Program Alteration Controls	\$0
	b.	CM Program Alteration Controls	\$0
C.	NAVAIR		
	a.	CNO Avail Program Alteration Controls	\$0
	b.	CM Program Alteration Controls	\$0

IV. NARRATIVE RISK ASSESSMENT			
A. Schedule Summary			
	a. CNO avail:		
	b. Deployment cycle (Training sched):		
	c. INSURV		
	d. CMAV		

APPENDIX A
EXECUTIVE SUMMARY SHEET (Cont'd)

	e. Outyears (Future major events, AP CNO, Home port shift, etc.)	
B. Assessment/Repair Summary		
	a. Main Propulsion	
	b. Auxiliary Equipment	
	c. Distributive Systems	
	d. Combat Systems	
C. Corrosion Control Summary		
	a. Tanks b. Decks/ Bilges c. Structural (fan rooms, stacks)	
D. CLASS Specific Major Anticipated Repairs.		
	a.	
	b.	
	c.	
E. TYCOM Unscheduled Modernization		
	a. Fleet Alts	
F. Summary Risk Assessment.		
	a. Risk Assessment Narrative:	

V. PLANNED WORK ROLLUP

Target	Item	Notional Cost

**APPENDIX A
EXECUTIVE SUMMARY SHEET (Cont'd)**

CONTROLS AND PHASING						
FYxx xxRMC BUDGET FOR USS XXX (XX-XX)						
	Total/Phasing	Q1	Q2	Q3	Q4	
FY xx TYCOM Budget	\$0	\$0	\$0	\$0	\$0	\$0
FY xx DIL Budget	\$0	\$0	\$0	\$0	\$0	\$0
FY xx PROGRAM Alt Budget	\$0	\$0	\$0	\$0	\$0	\$0
FY xx TOTAL MMBP Budget	\$0	\$0	\$0	\$0	\$0	\$0
FYxx xxRMC TYCOM CNO BUDGET						
FYxx CNO BUDGET	TOTAL	Phase check sum	Q1	Q2	Q3	Q4
	\$0	\$0	\$0	\$0	\$0	\$0
		Budget	Comments			
	1.	Maintenance	\$0	Estimate		
	2.	Fleet SHIPALTS		Based on Modernization Plan, LOAs		
Sum of 1,2,c,d	a.	Package Subtotal	\$0			
	b.	Growth %	12.00%	\$0	% of (a) based on RMC policy, cannot exceed 12%	
	c.	Service / Support %	17.00%	\$0	Historical percentage of (a) for 800/900's, adjusted for program Alt prorated costs	
	d.	LLTM	\$0	As required		
Change if 10% is not correct	e.	Award Fee % of (a+b+d)	11.23%	\$0	For Cost contracts only Max % possible based on contract terms	
	f.	Other costs	\$0	Work accomplished outside of Avail contract		
	g.	Pierside Refurb	\$0	As applicable at each RMC		
Business Adj Factor	h.	BAF % of (a+b+e)	0.00%	\$0	Enter positive percent value if Gov Estimate expected to be LOWER than winning Bid / negotiated Target Cost	
CNO AVAIL BUDGET			\$0			
FY xx FUNDING REQ			\$0	IF AN AVAIL CROSSES FISCAL YEARS, PREDICT GROWTH AND ASSOCIATED AWARD FEE FOR THE FOLLOW ON FY		
FY xx FUNDING REQ			\$0			
TOTAL CNO Execution Control			\$0	As established by RMC / TYCOM		
Prior FY Funds			\$0	AP or PSIA contractor funds still available in execution		
TOTAL CNO CONTROL			\$0	Total SERMC CNO Avail Funding Available		
FYxx xxRMC TYCOM CM BUDGET						
FYxx CM BUDGET	TOTAL	Phase check sum	Q1	Q2	Q3	Q4
	\$0	\$0	\$0	\$0	\$0	\$0

**APPENDIX A
EXECUTIVE SUMMARY SHEET (Cont'd)**

CONTROLS AND PHASING (Cont'd)							
				Budget	Comments		
	1.	Maintenance		\$0	Estimate. Before growth		
	2.	Fleet SHIPALTS		\$0	Estimate		
Sum of 1,2	a.	CM Package Subtl		\$0	Base Budget. No Growth or Fees.		
	b.	Growth %	12.00%	\$0	% of (a) based on RMC policy, cannot exceed 12%		
Change if 10% is not correct	c.	Award Fee % of (a+b)	0.00%	\$0	For Cost Contracts only Max % possible based on contract terms		
	d.	Other costs		\$0			
CM Budget				\$0			
FYxx CM Control				\$0	As established by RMC/TYCOM		
Prior FY Funds				\$0	AP or PSIA contractor funds still available in execution		
TOTAL CM CONTROL				\$0	Total SERMC CM Funding available		
Advance Planning Budget							
				Q1	Q2	Q3	Q4
FY xx CNO Avail Advance Planning				\$0	\$0	\$0	\$0
FY xx CNO Avail Advance Planning				\$0	\$0	\$0	\$0
FY10 SERMC TYCOM DIL Budget							
FY xx DIL Budget	TOTAL		Phase check sum	Q1	Q2	Q3	Q4
	\$0		\$0	\$0	\$0	\$0	\$0
				Budget	Comments		
	1.	Maintenance		\$0	Estimate. Before growth		
	2.						
Sum of 1,2	a.	DIL Package Subtl		\$0	Base Budget. No Growth or Fees.		
	b.	Growth %	12.00%	\$0	% of (a) based on RMC policy, cannot exceed 12%		
Change if 10% is not correct	c.	Award Fee % of (a+b)	0.00%	\$0	For Cost Contracts only Max % possible based on contract terms		
	d.	Other costs		\$0			
DIL Budget				\$0			
FYxx DIL Control				\$0	As established by RMC/TYCOM		
Prior FY Funds				\$0	AP or PSIA contractor funds still available in execution		
TOTAL DIL CONTROL				\$0	Total SERMC DIL Funding available		

**APPENDIX A
EXECUTIVE SUMMARY SHEET (Cont'd)**

CONTROLS AND PHASING (Cont'd)							
FYxx CNO AVAIL Program ALT Modernization Budget							
NAVSEA Program Alts	TOTAL		Phase check sum	Q1	Q2	Q3	Q4
	\$0		\$0	\$0	\$0	\$0	\$0
			Budget	Comments			
	1.	Labor & Matl	\$0	From Mod Plan, LOAs			
	2.	Services	\$0	Negotiated with RMC for 800/900's			
Sum of 1,2	a.	Package Subtotal	\$0	Base Budget. No Growth or Fees.			
	b.	Growth %	10.00%	\$0	% of (a) based on RMC / PARM policy		
	c.	Award Fee % of (a+b)	11.23%	\$0	For Cost contracts only Max % possible based on the contract		
	d.	BAF % of (a+c)	0.00%	\$0	Enter positive percent value if Gov Estimate expected to be LOWER than winning Bid / negotiated Target Cost		
	e.	Other costs	\$0	Explain in comments			
NAVSEA Budget			\$0	Budget cannot exceed control			
FYxx NAVSEA Control			\$0	From Mod Plan, LOAs			
SPAWAR							
Program Alts	TOTAL		Phase check sum	Q1	Q2	Q3	Q4
	\$0		\$0	\$0	\$0	\$0	\$0
			Budget	Comments			
	1.	Labor & Matl	\$0	From Mod Plan, LOAs			
	2.	Services	\$0	Negotiated with RMC for 800/900's			
Sum of 1,2	a.	Package Subtotal	\$0	Base Budget. No Growth or Fees.			
	b.	Growth %	10.00%	\$0	% of (a) based on RMC / PARM policy		
	c.	Award Fee % of (a+b)	11.23%	\$0	For Cost contracts only Max % possible based on the contract		
	d.	BAF % of (a+c)	0.00%	\$0	Enter positive percent value if Gov Estimate expected to be LOWER than winning Bid / negotiated Target Cost		
	e.	Other costs	\$0	Explain in comments			
SPAWAR Budget			\$0	Budget cannot exceed control			
FYxx SPAWAR Control			\$0	From Mod Plan, LOAs			
NAVAIR/ OTHER ALTS							
Program Alts	TOTAL		Phase check sum	Q1	Q2	Q3	Q4
	\$0		\$0	\$0	\$0	\$0	\$0
			Budget	Comments			
	1.	Labor & Matl	\$0	From Mod Plan, LOAs			
	2.	Services	\$0	Negotiated with RMC for 800/900's			

**APPENDIX A
EXECUTIVE SUMMARY SHEET (Cont'd)**

CONTROLS AND PHASING (Cont'd)						
Sum of 1,2	a.	Package Subtotal		\$0	Base Budget. No Growth or Fees.	
	b.	Growth %	10.00%	\$0	% of (a) based on RMC / PARM policy	
	c.	Award Fee % of (a+b)	11.23%	\$0	For Cost contracts only Max % possible based on the contract	
	d.	BAF % of (a+c)	0.00%	\$0	Enter positive percent value if Gov Estimate expected to be LOWER than winning Bid / negotiated Target Cost	
	e.	Other costs		\$0	Explain in comments	
NAVAIR/OTHER ALTS Budget				\$0	Budget cannot exceed control	
FYxx NAVAIR/OTHER Control				\$0	From Mod Plan, LOAs	
NAVSEA						
Program Alts		TOTAL	Phase check sum	Q1	Q2	Q3
		\$0	\$0	\$0	\$0	\$0
			Budget	Comments		
	1.	Labor & Matl	\$0	From Mod Plan, LOAs		
	2.	Services	\$0	Negotiated with RMC for 800/900's		
Sum of 1,2	a.	Package Subtotal		\$0	Base Budget. No Growth or Fees.	
	b.	Growth %	10.00%	\$0	% of (a) based on RMC / PARM policy	
	c.	Award Fee % of (a+b)	11.23%	\$0	For Cost contracts only Max % possible based on the contract	
	d.	BAF % of (a+c)	0.00%	\$0	Enter positive percent value if Gov Estimate expected to be LOWER than winning Bid / negotiated Target Cost	
	e.	Other costs		\$0	Explain in comments	
NAVSEA ALTS Budget				\$0	Budget can not exceed control	
FYxx NAVSEA Control				\$0	From Mod Plan, LOAs	
SPAWAR						
Program Alts		TOTAL	Phase check sum	Q1	Q2	Q3
		\$0	\$0	\$0	\$0	\$0
			Budget	Comments		
	1.	Labor & Matl	\$0	From Mod Plan, LOAs		
	2.	Services	\$0	Negotiated with RMC for 800/900's		

**APPENDIX A
EXECUTIVE SUMMARY SHEET (Cont'd)**

CONTROLS AND PHASING (Cont'd)							
Sum of 1,2	a.	Package Subtotal		\$0	Base Budget. No Growth or Fees.		
	b.	Growth %	10.00%	\$0	% of (a) based on RMC / PARM policy		
	c.	Award Fee % of (a+b)	11.23%	\$0	For Cost contracts only Max % possible based on the contract		
	d.	BAF % of (a+c)	0.00%	\$0	Enter positive percent value if Gov Estimate expected to be LOWER than winning Bid / negotiated Target Cost		
	e.	Other costs		\$0	Explain in comments		
SPAWAR ALTS Budget				\$0	Budget cannot exceed control		
FYxx SPAWAR Control				\$0	From Mod Plan, LOAs		
NAVAIR/ OTHER ALTS	TOTAL		Phase check sum	Q1	Q2	Q3	Q4
	\$0		\$0	\$0	\$0	\$0	\$0
			Budget	Comments			
	1.	Labor & Matl		\$0	From Mod Plan, LOAs		
	2.	Services		\$0	Negotiated with RMC for 800/900's		
Sum of 1,2	a.	Package Subtotal		\$0	Base Budget. No Growth or Fees.		
	b.	Growth %	10.00%	\$0	% of (a) based on RMC / PARM policy		
	c.	Award Fee % of (a+b)	11.23%	\$0	For Cost contracts only Max % possible based on the contract		
	d.	BAF % of (a+c)	0.00%	\$0	Enter positive percent value if Gov Estimate expected to be LOWER than winning Bid / negotiated Target Cost		
	e.	Other costs		\$0	Explain in comments		
NAVAIR/OTHER ALTS Budget				\$0	Budget cannot exceed control		
FYxx NAVAIR/OTHER Control				\$0	From Mod Plan, LOAs		

(This Page Intentionally Left Blank)

VOLUME VI

CHAPTER 34

**SUBMARINE FLY-BY-WIRE SHIP CONTROL SYSTEM
MAINTENANCE AND CERTIFICATION**

CHAPTER DELETED - SAVE FOR FUTURE USE

(This Page Intentionally Left Blank)

VOLUME VI
CHAPTER 35

REGIONAL MAINTENANCE CENTER I-LEVEL MAINTENANCE CAPABILITIES

LISTING OF APPENDICES.

A Regional Maintenance Center I-Level Maintenance Capability Matrix

35.1 PURPOSE. This chapter provides a listing of Regional Maintenance Centers (RMC) I-Level maintenance capabilities for Surface Force ships and defines related reporting requirements.

35.2 BACKGROUND. The primary mission of an RMC is to promote surface ship readiness via assessment, troubleshooting, and repair of systems and equipment which are beyond the technical capability or capacity of Fleet units. A secondary mission of an RMC is to provide enough production work experience and on-the-job training to sailors for them to improve their technical knowledge and, where appropriate, earn a Navy Enlisted Classification (NEC) code used to fill Navy Afloat Maintenance Training Strategy (NAMTS) billets when returning to sea duty. An RMC accomplishes both of these missions, in part, with the sustainment and utilization of their I-Level maintenance capability.

35.2.1 Onboard Support. In addition to ship-to-shop and standard shipboard repair and maintenance work, the RMC I-Level capability is utilized to provide onboard Maintenance Assist Team (MAT) I-Level support to ships in port. The MAT concept was designed to bring RMC repair and maintenance training capability to bear on shipboard systems to improve Ship's Force repair, self-assessment, maintenance and equipment operations capability.

35.2.2 Applicable Regional Maintenance Centers. There are five RMCs with existing surface ship I-Level workforce: three of which are stand alone Activities and two that are incorporated within Naval Shipyards. Southwest Regional Maintenance Center (SWRMC) is located in San Diego, CA. Hawaii Regional Maintenance Center (HRMC) is a function incorporated within Pearl Harbor Naval Shipyard and Intermediate Maintenance Facility (PHNSY&IMF). Northwest Regional Maintenance Center (NWRMC) is a function incorporated within Puget Sound Naval Shipyard and IMF (PSNS&IMF). NWRMC also includes Everett, WA maintenance operations. Mid Atlantic Regional Maintenance Center (MARMC) is located in Norfolk, VA. Southeast Regional Maintenance Center (SERMC) is located in Mayport, FL.

35.3 RESPONSIBILITIES.

35.3.1 Fleet Commanders. (individually or jointly, as appropriate).

- a. Approve changes, additions and deletions to the I-Level Capabilities Matrix (Appendix A) as recommended by the Type Commanders (TYCOM).
- b. Approve recommended changes to the NAMTS NEC At-Sea Requirements Matrix as provided by the TYCOMs.
- c. Approve and forward, with endorsement, NAMTS NEC modifications as developed and recommended by Commander, Navy Regional Maintenance Center (CNRMC) with TYCOM concurrence, to the Navy Enlisted Occupational Classification System Board.
- d. Review, approve and submit Billet Change Requests (BCR) developed by CNRMC, to support the sea/shore rotation requirements.
- e. Request additions and deletions to the I-Level capabilities listed in Appendix A and/or corresponding capacities at each RMC based on utilization metrics and written Business Case Analysis to the cognizant Fleet Commander.
- f. Ensure full utilization of the full range of organic RMC I-Level capability identified in Appendix A.
- g. Establish and communicate work priorities to CNRMC and cognizant RMCs. Resolve work priority conflicts as necessary.
- h. Regularly assess NAMTS maintenance skills required on respective afloat units.

- i. Approve CNRMC recommended, or recommend additional changes to specific NAMTS maintenance skills and required training for billets on respective afloat units.
- j. In collaboration with CNRMC, review and recommend NAMTS NEC At-Sea Requirements Matrix revisions to the cognizant Fleet Commander(s).
- k. Review and approve establishment and disestablishment of MATs, as recommended by CNRMC. Optimize utilization of MATs capacity within existing total I-Level workload in each cognizant RMC.

35.3.2 Commander, Navy Regional Maintenance Center. CNRMC will:

- a. Provide the capabilities identified in Appendix A in accordance with all applicable policy, regulations and technical requirements. Ensure detailed capability manuals are issued by each RMC to expound on and clarify the exact capabilities identified in Appendix A.
- b. Coordinate with the TYCOMs to ensure full utilization of the funded capacity, adjusting capacity as necessary. Include utilization analysis and NAMTS Program inspections in Fleet Maintenance Activity Assessments of RMCs.
- c. Provide cost estimates and implementation plans to the Fleet Commanders for proposed additions and deletions to capabilities in Appendix A, as well as increases or decreases to capacity at any/all RMCs.
- d. Establish policy, requirements and direction for NAMTS program management and execution at RMCs.
 - (1) Provide oversight of NAMTS program execution and qualifications to ensure:
 - (a) Compliance with NAMTS roles, responsibilities and program execution in accordance with the NAMTS desk guide, CNRMC M-4700.12.
 - (b) NAMTS enrollment and qualification is maximized.
 - (c) “Hands-on” journeyman-level skills training is an integral part of Job Qualification Requirement (JQR) qualification.
 - (d) The number of experienced JQR journeyman qualified personnel produced, is adequate to fill NAMTS NEC-coded afloat billet requirements established by the cognizant Fleet Commander(s).
 - (2) Provide NAMTS JQR Life Cycle Management including the following:
 - (a) Coordinate with TYCOMs, Surface Warfare Officer’s School - Fleet Enlisted Engineering Training and RMCs to ensure JQRs meet NAMTS NEC requirements. Changes to NAMTS NEC requirements may result from ship system modifications, upgrades or new acquisitions.
 - (b) Develop, review, coordinate feedback or revise JQRs as required. At a minimum, coordinate JQR reviews every three years.
 - (c) Approve new/changes to JQRs. Determine/approve which JQRs are executed at RMCs.
 - (d) For new JQRs, coordinate the development and submission of Course Identification Number packages to support NEC management and training accomplishment.
 - (e) Maintain Master JQR Library.
 - (3) Maintain and monitor a master test question data bank to support pre- and post-JQR examinations and JQR qualification oral boards.
 - (4) Promote NAMTS program awareness among Fleet activities and sailors, to include:
 - (a) Host and maintain an information website that supports NAMTS program management and awareness, training materials, and metrics.
 - (b) Publish newsletters and other media to enhance program awareness.

- (c) Establish and maintain a system of metrics to reflect NAMTS program performance including eligibility, enrollment and qualification trends.
- (5) Establish a manpower and NAMTS NEC At-Sea Requirements Matrix and coordinate periodic reviews with TYCOMs.
 - (a) Develop quarterly review schedules to ensure Ship Manning Documents for all afloat units are reviewed annually at a minimum.
 - (b) In conjunction with manpower reviews, the NAMTS NEC At-Sea Requirements Matrix shall be reviewed annually.
 - (c) Review sea/shore rotation impacts resulting from recommended NEC changes.
 - (d) Submit review results and recommendations to United States Fleet Forces/Commander, Pacific Fleet via TYCOMs prior to BCR submissions.
 - 1 NAMTS NEC At-Sea Requirements Matrix changes.
 - 2 NAMTS NEC modifications through the Navy Enlisted Occupational Classification System Board process.
 - 3 Navy Manpower Analysis Center NEC changes.
- (6) Conduct Quarterly NAMTS Program Reviews with RMC representatives. Reviews shall include at a minimum:
 - (a) Eligibility, enrollment, qualification and NECs award trends.
 - (b) Status of manpower/NAMTS NEC At-Sea Requirements Matrix reviews, BCRs, NEC modifications, feedback reports or other pending actions.
- (7) Develop a series of metrics to measure and monitor the performance and overall health of the NAMTS program. In particular, eligibility, enrollment, qualification and NEC award trends, accounting for all Sailors in NAMTS NEC source ratings, shall be measured and analyzed. Metrics shall be developed to support both program monitoring within the NAMTS organization and up line reporting as required.
- e. As MAT Program Manager, establish requirements and guidance for the execution of MATs at the RMCs, including reporting requirements.
- f. Coordinate with the cognizant TYCOM on the establishment, disestablishment and utilization of MATs.

35.3.3 Regional Maintenance Center.

- a. RMC areas of responsibility are the same as those identified in Volume II, Part I, Chapter 2, paragraph 2.1.1, Table 2.1 of this manual. The RMC shall exercise all I-Level functions and responsibilities when services are required or requested by fleet activities within these areas unless assigned to another RMC by the Fleet Maintenance Officer. This includes utilization of the I-Level capability as appropriate.
- b. Include details of I-Level capabilities in RMC capability manuals.
- c. Identify and communicate shop loading to applicable Forces Afloat and TYCOMs to ensure full utilization of the funded capacity. This includes the use of this capacity to establish MATs.
- d. These requirements apply to Naval Shipyards when they are assigned RMC functions.

35.4 REGIONAL MAINTENANCE CENTER PERFORMANCE MEASURES.

35.4.1 Reporting. RMC I-Level capability performance will be reported monthly to CNRMC in accordance with guidelines in Volume II, Part I, Chapter 4, paragraph 4.6.5.1 of this manual for continuous evaluation.

- a. MAT utilization and performance measures shall be included in the RMC monthly I-Level Reports.
- b. CNRMC will provide quarterly summary reports of I-Level performance, including MATs, to the cognizant TYCOM and Fleet Maintenance Officer.

(This Page Intentionally Left Blank)

APPENDIX A

REGIONAL MAINTENANCE CENTER I-LEVEL MAINTENANCE CAPABILITY MATRIX

CATEGORY	CAPABILITY	MARMC	SERMC	SWRMC	MWRMC	HRMC
I	EXECUTION OF ASSIGNED SHIP REPAIR AND MAINTENANCE	X	X	X	X	X
I-A	Perform structural repairs (Shipfitter)	X	X	X	X	X
I-B	Perform pipe repairs (Pipefitter)	X	X	X	X	X
I-C	Perform insulation and lagging services	X	X	X	X	X
I-D	Perform repair and maintenance of ship's RHIBs	X	X	X	X	X
I-E	Perform (Inside Machinist) machining services	X	X	X	X	X
I-F	Perform diesel engine governor and injector repairs and maintenance	X	X	X	X	X
I-G	Perform valve repair and maintenance	X	X	X	X	X
I-H	Perform diesel engine repair and maintenance	X	X	X	X	X
I-I	Perform hydraulics system repair and maintenance	X	X	X	X	X
I-J	Perform pump repairs and maintenance	X	X	X	X	X
I-K	Perform gas turbine repairs and maintenance	X	X	X	X	X
I-L	Perform (Outside Machinist) machinery repairs and maintenance	X	X	X	X	X
I-M	Perform air conditioning and refrigeration repair and maintenance	X	X	X	X	X
I-N	Perform flex hose fabrication and testing	X	X	X	X	X
I-O	Provide mechanical and/or photo engraving services	X	X	X	X	X
I-P	Provide key and lock repair services	X	X	X	X	X
I-Q	Perform repairs and maintenance to heat exchangers	X	X	X	X	X
I-R	Perform inside electrical repair and maintenance, including motor troubleshooting	X	X	X	X	X
I-S	Provide sound vibration analysis of rotating equipment (both in place and in shop)	X	X	X	X	X
I-T	Perform outside electrical repair and maintenance	X	X	X	X	X
I-U	Perform cableway inspections	X	X	X	X	X
I-V	Perform repair and maintenance of interior communication systems	X	X	X	X	X
I-W	Perform test, repair and maintenance of electronic modules (2M)	X	X	X	X	X
I-X	Perform repair and maintenance of electronics systems	X	X	X	X	X
I-Y	Perform repair and maintenance of sonar systems	X	X	X	X	X
I-Z	Perform repair and maintenance of fire control and weapons systems	X	X	X	X	X
I-AA	Perform repair and maintenance of antennas	X	X	X	X	X
I-AB	Provide corrosion control services (also as part of all NAMTS NECs)	X	X	X	X	X

CATEGORY	CAPABILITY	MARMC	SERMC	SWRMC	MWRMC	HRMC
I-AC	Perform repair and maintenance of HLS/RAST systems	X	X	X	X	X
I-AD	Perform repair and maintenance of life rafts	X	X	X	X	X
I-AE	Repair and overhaul CIWS and 25mm chain guns	X	X	X	X	X
I-AF	Perform repair and maintenance of mine warfare specific systems		X	X		
I-AG	Provide diving services, including hyperbaric chamber	X	X	X	X	X
I-AH	Perform rigging, weight testing and manufacture of weight handling devices	X	X	X	X	X
I-AI	Provide oil analysis, spectral analysis, fluid contamination and particle contamination services	X	X	X	X	X
I-AJ	Perform non-destructive testing	X	X	X	X	X
I-AK	Provide weld qualification services	X	X	X	X	X
I-AL	Provide the services of a certified Marine Gas Turbine Inspector	X	X	X	X	X
I-AM	Provide various calibration services not provided by regional calibration centers	X	X	X	X	X
I-AN	Provide SISCAL Level II services	X	X	X	X	X
I-AO	Provide shipboard welding and brazing services	X	X	X	X	X
I-AP	Provide SCBA Cylinder testing and mask flow testing	X	X	X	X	
I-AQ	Provide Maintenance Assist Teams (MAT)	X	X	X	X	
I-AR	Provide test, repair and maintenance of fiber optics	X	X	X	X	X

VOLUME VI

CHAPTER 36

SURFACE FORCE SHIP/AIRCRAFT CARRIER MODERNIZATION PROGRAM

REFERENCES.

- (a) NAVSEA SL720-AA-MAN-030 - Navy Modernization Process Management and Operations Manual (NMP-MOM)
- (b) COMUSFLTFORCOMINST/COMPACFLTINST 4720.3 - Commander United States Fleet Forces Command (COMUSFLTFORCOM)/Commander Pacific Fleet (COMPACFLT) C5ISR Modernization Policy
- (c) DODINST 5000.2 - Operation of the Defense Acquisition System

LISTING OF APPENDICES.

- A Modernization Plan Flowchart
- B Ship Change Document Template
- C Technical Assessment Flowchart
- D Cost Benefit Analysis Flowchart
- E Alteration Figure of Merit Flowchart
- F Voting Database Flowchart

36.1 SCOPE. This chapter is applicable to all Surface Force/Aircraft Carrier ships and shore activities involved in ship modernization. The provisions of this chapter have been developed in collaboration with Naval Operations (OPNAV). Where there are conflicts with reference (a), this chapter shall take precedence until such time as OPNAV implementing directives can be modified/issued. References (b) and (c) govern the management of afloat Combat Systems and Command, Control, Communications, Computers, Collaboration and Intelligence installations and improvements, and Initial Adversary Vulnerability Assessment policies and remain in effect as written. Type Commander (TYCOM) Maintenance Directorates shall be the lead for ensuring implementation. Ships will continue the current practice of forwarding change requests to the Immediate Superior In Command (ISIC), who will forward the change request to the respective TYCOM for entry into the Navy Data Environment (NDE). Only alterations entered in NDE will be considered for inclusion in Modernization Programs. This chapter is not applicable to submarines. Submarines will continue to utilize existing instructions.

36.2 PURPOSE. The purpose of this chapter is to document the Surface Force Ship/Aircraft Carrier Modernization Program, which emphasizes early decisions under the control of United States Fleet Forces Command (USFFC), Pacific Fleet, and Navy Cyber Forces (CYBERFOR), and expands on the decision process for deciding which alterations and modifications will be developed, procured, certified and installed on all surface force ships and aircraft carriers. The objective is to assure that fleet modernization investments address the fleet's greatest concerns and are integrated and prioritized across Strike Groups, ships, systems and warfare areas. The process directly involves Navy leadership at all levels (Fleet, OPNAV, Force TYCOMs, Systems Commands (SYSCOM) and Program Executive Offices (PEO)) in the programming, planning and installation of modernization in a consistent and disciplined manner.

36.3 BACKGROUND. The End to End Ship Maintenance and Modernization (previously Ship Maintenance (SHIPMAIN)) was developed to concentrate on the early decision process regarding which alterations are to be accomplished. This process provides timely Fleet involvement and the assurance that changes are driven by current fleet requirements. The Modernization Program itself was implemented to modify the Entitled Process (formerly the Fleet Modernization Program (FMP)) due to Fleet concerns which included alterations developed and hardware procured but never installed. It was to also alleviate concerns over significant changes to availability work packages after authorization letter issuance, and alteration installation problems caused by failure to satisfy planning milestones. While these issues are often times driven by overall funding instability in Navy budgets and changing priorities, the associated costs consume modernization funding minimizing the ability to modernize. The Navy Modernization Process (NMP) has replaced the FMP, and is documented in reference (a). The NMP provides a structure for the orderly identification, approval, design, planning, programming, budgeting, installation, life cycle

support and configuration control of technical and survivability improvements to all ships of the active and reserve fleets. This chapter also provides overall prioritization in the alterations to be accomplished and discipline and accountability in the adherence to NMP processes.

36.4 **PROCESS.** Appendix A provides a flowchart of the entitled modernization process decision and prioritization.

36.4.1 **Key Elements.** Key elements of the Surface Force Ship/Aircraft Carrier Modernization Program are:

- a. A single process to identify, evaluate and approve all hardware and computer software modifications to all ships and ship's systems. The Entitled Modernization Process is owned by the Fleet and executed through SYSCOM/TYCOMs. The Commander, Naval Sea Systems Command (COMNAVSEASYSYSCOM) acts as the executive agent for the Chief of Naval Operations (CNO) in the execution of Navy Modernization. In accordance with "Virtual SYSCOM Engineering and Technical Authority Policy", the SYSCOMs execute technical authority within their areas of responsibility, technical integrity and expertise. The process operates in concert with Acquisition Program processes of reference (b).
- b. Consolidation of all alterations into two types:
 - (1) Fleet alterations funded by the Fleet.
 - (2) Program alterations funded by the SYSCOMs/PEOs.
- c. The Entitled Process is comprised of five distinct phases and three Decision Points to take a proposed change from conception to completion. This process is executed using the Ship Change Document (SCD). Senior Fleet/OPNAV personnel comprise the Decision Boards identified in paragraph 36.6 of this chapter. Provisions exist to combine Phases II and III for less complex changes as delineated in paragraph 36.4.8 of this chapter. Any major changes encountered during Ship Integration will require reporting back to Decision Point 3 for approval to continue the Ship Change.
- d. A single database, maintained by Naval Sea Systems Command (NAVSEA) 04 (currently NDE for Surface Force and Aircraft Carrier Modernization).
- e. The Fleet/TYCOMs collaborate with OPNAV, SYSCOMS and PEOs in the decision making process, utilizing three boards of stakeholders at the O-6, one and two star Admiral, and three star Admiral level. Voting members of the boards represent appropriate Fleet and OPNAV organizations. SYSCOM and PEO representation is included to validate the readiness of the alteration to proceed to the next step. Paragraph 36.5.2 of this chapter addresses the business rules associated with the voting process. Depending on cost and impact thresholds, decisions are made by one of the three boards. An electronic voting capability (eVote), embedded in NDE, will be used on a continuing basis to facilitate timely action by the boards, and minimize the need for boards to formally convene. NAVSEA 04 will ensure data is available to voting members 10 to 14 days prior to required voting. As noted on the Modernization Plan Flowchart, Appendix A of this chapter, Technical Assessments are conducted at three points in the process, and in conjunction with the Alteration Figure of Merit (AFOM) and Cost Benefit Analysis (CBA) blocks, are assembled in a Recommended Change Package (RCP) which provide the basis for decisions made by the O-6, 1/2 Star and 3 Star Boards.
 - (1) The O-6 level board approves Fleet alterations except in cases where the scope and complexity dictate referral to a higher level board, makes the majority of decisions involving the lower cost and lesser impact Program alterations, and provides recommendations for the higher level boards.
 - (2) The one and two star board validates the O-6 board decisions and provides Fleet/OPNAV/claimant recommendations to Acquisition Category (ACAT) III and ACAT IV and below program milestone decision authorities.

- (3) The three star board sets overall priorities, makes the decisions involving the higher cost and higher impact alterations, validates one and two star board decisions, provides Fleet/OPNAV/claimant recommendations to ACAT I and ACAT II program milestone decision authorities, and approves the Surface Force Ship/Aircraft Carrier Modernization Pre-Overseas Movement (POM) Submission (Capability Plan).
- f. The Modernization process is designed to accommodate initial submission of an SCD early in the life of requirements definition for a ship or system capability/program. This is accomplished by submitting an SCD for the system/program across the Five Year Defense Program (this includes all software support programs). As changes are more definitively identified, separate SCDs will be developed as supportive to the capability/program SCD (examples of supportive SCDs can include hardware updates, software upgrades, Hull, Mechanical and Electrical (HM&E) changes, etc.).

36.4.2 Decision Points. There are three main decision points exercised by the review boards (Steps 60, 140 and 220 of Appendix A); and all three are supported by technical assessments, cost benefit analyses and figure of merit assessment reviews.

- a. Decision Point 1: The purpose of Decision Point 1 is to approve the entry of the concept design and to include the proposed change in the Modernization Plan. Approval at this point constitutes Resource Sponsor commitment to fully fund the change in the POM. It is recognized that follow-on budget decisions beyond the control of the Resource Sponsor may require relief from that commitment, however, the Resource Sponsor will then advise the Voting Boards for consideration of the change in future budgets. Some programs/capabilities may not be defined to the alteration level based on the need for further technical definition. In those cases, the program/capability will be submitted as a single SCD for consideration at Decision Point 1. In Phases II and III, the program/capability will be defined in multiple alterations as required.
- b. Decision Point 2: The purpose of Decision Point 2 is to validate/update the Modernization Plan and to proceed with design development, with Resource Sponsor confirmation that funds exist in the budget to fully execute the Ship Change.
- c. Decision Point 3: The purpose of Decision Point 3 is to validate/update the Modernization Plan and to proceed with material procurement and scheduling installations with Resource Sponsor confirmation that funds exist in the budget to fully execute the Ship Change.

36.4.3 Ship Change Document. The principal document used in the Technical Assessments is the SCD, illustrated in Appendix B, which remains with an alteration throughout its development. The SCD replaces the Justification Cost Form, In-service Engineering Change Proposal, the Ship Alteration Record and all other alteration documents (e.g., Field Change, Ordnance Alteration) which were used in the former FMP. The SCD is prepared by any activity and must meet specific minimum requirements addressed in paragraph 36.5 of this chapter, in order to proceed beyond Block 10. After the SCD is prepared it is forwarded to an authorized submitting activity for entry into NDE. For SCDs submitted as described in paragraph 36.4.1 of this chapter, all cost information shall be complete and cover the entire program. A submitted supportive SCD's costs will be decremented from the capability/program SCD. Authorized submitting activities are:

- a. TYCOMs.
- b. OPNAV.
- c. PEOs.
- d. Participating Acquisition Resource Managers (PARM).
- e. Life Cycle Managers.
- f. Fleet Commanders.

36.4.3.1 Phase I. The Phase I steps consist of:

- a. The initiator shall provide data for all SCD Phase I fields at a minimum prior to submission to the submitter.
- b. A preliminary tracking number shall be automatically assigned by the system (NDE).

- c. The initiator and the submitter shall have the ability to review the draft SCD at any time in the preparation process.
- d. This form shall be able to be viewed at any point in the process once submitted.
- e. Minimum header data required uniquely defining the Configuration Change (functional definition, class affectivity, functional areas).
- f. Fleet requirement, description of change, and impact to the Fleet if not accomplished.
- g. The submitter will either approve the change and put into NDE officially or kill the change. Entering an SCD at this point establishes that the SCD has officially entered the Entitled Process.
- h. The submitter will ensure there are no duplicate SCDs.
- i. The submitter shall be able to expedite Alterations that are considered to be critical by Fleet by setting an "Expedite" flag in SCD. Expedited SCDs are considered first in any process work queue.
- j. The submitter shall be able to identify previously shelved alterations and resubmit to the process using previously assigned SCD identification via TYCOM or OPNAV Sponsor.
- k. The expedite alert box should be checked "yes" when operational readiness (i.e., correction of a C4 Casualty Report) or safety to personnel is effected.
- l. All authorized SCDs shall be assigned a sequential Ship Change Number by the system (NDE).

NOTE: THE PROCESS ENABLES LESS COMPLEX CHANGES TO COMBINE PHASES II AND III, AS DETERMINED IN THE INITIAL TECHNICAL ASSESSMENT.

36.4.3.2 Phase II. The Phase II steps consist of:

- a. The Submitter receives approval of SCD Phase I and notification to complete SCD Phase II or IIa, if approved by Voting Board, form.
- b. The submitter will utilize internal processes to complete preliminary engineering and provide a draft SCD Phase II to the Change Manager in the respective Ship Program Manager Office.

36.4.3.3 Phase III. The Phase III steps consist of:

- a. Submitter receives approved SCD Phase II.
- b. The submitter will utilize internal processes to complete engineering and design development and provide a draft SCD Phase II (a) or III.

36.4.4 Technical Assessment Teams. Technical Assessment Teams (TAT) are assigned at NAVSEA and will be made up of subject matter technical experts related to the scope of the SCD.

36.4.4.1 Technical Assessments. Technical Assessments are performed at three separate stages in the process to support decisions to complete preliminary engineering, design development and detail specifications.

36.4.4.2 Technical Assessment Business Rules. Appendix C reflects the Technical Assessment flowchart.

36.4.4.3 Phase I Technical Assessment Rules. The following Phase I Technical Assessment Business Rules apply:

- a. Ship's Program Manager (SPM) cannot send a change idea to history.
- b. TAT review process will take no longer than 5 days.
- c. Any negative recommendation must include a justification.
- d. Due to limited engineering requirements and limited impacts to existing equipment and the ships, some changes may be permitted to have Phase II and Phase III combined. In order to determine if there is sufficient reason to combine these two phases for a particular change, the TAT must consider the Scope (SCD Phase I, Item 3.a) of the change.

36.4.4.4 Technical Assessment Teams. TATs will be allowed to change fields to correct data. If any information is changed a record of the change will be kept and the submitting Point of Contact notified for concurrence.

36.4.4.5 Changes. Identify changes that may supersede or be redundant with an existing change. Should the SPM require additional clarification, endorsement will not be forwarded prior to attempting issue resolution via TAT Lead. Unresolved issues will be noted in the Technical review comments and forwarded.

36.4.4.6 Phase II Technical Assessment Rules. Should the SPM require additional clarification, endorsement will not be forwarded prior to attempting issue resolution via TAT Lead. Unresolved issues will be noted in the Technical Assessment comments and forwarded. TAT will take no longer than 45 days to complete.

36.4.4.7 Phase II(a) Update Technical Assessment. In this phase, complete technical data will be available for review in the draft Phase II(a) SCD. Phase II(a) will combine Phases II and III in order to streamline the process. The same basic tenets of the process described for Phases II and III will apply. The TAT will complete their review within 60 days.

36.4.4.8 Phase III Technical Assessment Rules. In this phase, complete technical data will be available for review in the draft Phase III SCD, but the basic tenets of the process described for Phases I and II will apply. TAT will complete their review in this phase in no more than 60 days.

36.4.5 Cost Benefit Analysis. A CBA is conducted at step 40 of the process, and then updated at steps 120 and 200, to support Modernization Plan decisions by the three established review boards. Appendix D reflects the Cost Benefit Analysis Flowchart. It is imperative that sound cost estimates be developed to make these analyses valid. The CBAs, the Technical Assessments and AFOM assignments together form the RCP which are provided to the respective review boards to support board decisions on proposed shipboard changes. These analyses are accomplished by Independent Cost Review (ICR) Teams under the direction of NAVSEA 017. All cost data to support the CBA process is derived from the SCD, initially submitted by the activity proposing the change, and then updated throughout the process.

36.4.5.1 Phase I Preliminary Analysis Business Rules. In this phase, the purpose of the ICR Team is to review cost data entered in the SCD for completeness and reasonableness to support Decision Point I. The input to the CBA process is an affirmative designation by the Technical Analysis Team. In this phase, the ICR Team is expecting high-level cost information (e.g. Concept Development Cost, Preliminary Engineering Cost, Design Development Cost, Procurement Cost and Installation Cost). This cost data will be provided by responsible PARMs and SPMs as direct inputs into the SCD resident in NDE. NDE maps this data into a Cost Reduction and Effectiveness Improvement (CREI) document designated as the CREI Template which automatically calculates cost metrics such as Return on Investment, Net Present Value (NPV) and Payback Period. When the calculations have been made by the CREI Template, a notification is electronically forwarded to Subject Matter Expert (SME) members of the ICR Team. The cost data fields in NDE will be locked precluding uncontrolled changes and can only be unlocked by a member of the ICR Team. If the ICR Team has questions about the data, they will be provided back to the data source through a "feedback" loop managed by NAVSEA 017. The feedback process will only be exercised one time (if necessary), and will then be forwarded to the Decision Board for their review and decision. The ICR Team will not alter cost data; but will use the feedback loop as the conduit for questioning submitted cost data. Should the source of the cost data determine a change to submitted cost information is warranted based on ICR Team questions, he/she will enter the corrected data in NDE after consultation with the NAVSEA 017 Area Coordinator. The Area Coordinator will obtain concurrence from respective ICR Team members and unlock applicable cost data fields. The source of the cost data will have two (2) working days to make the change to appropriate fields, at which time the fields will again lock and the data passed to the RCP and review by the appropriate board. In those instances where the source of the cost data does not agree with changes proposed by the ICR Team, the unaltered data will be forwarded for inclusion in the RCP as well as the ICR Team comments.

36.4.5.2 Phase II Concept Design Cost Benefit Analysis Update. In this phase, the ICR Team is looking for more fidelity in the cost data provided to support Decision Point 2. The basic CBA Process in this phase mirrors Phase I, with the following exceptions/additions:

- a. If the Program Manager (PM) experiences cost growth of greater than 10% in the total program budget, the PM shall notify the appropriate Sponsor (Fleet or OPNAV). The Sponsor may decide to address this issue with the Decision Board.
- b. The Sponsor shall be notified if, in the year of execution, a cost shortfall identified that is within the Program Managers ability to cover, or adjustments are made to the Modernization Plan.

- c. If the total cost estimate of an alteration exceeds the appropriate threshold for the respective phase (i.e. 40% Phase I, 25% Phase II, 15% Phase III), the PM shall notify the appropriate Sponsor (Fleet or OPNAV). At that point, the Sponsor may decide to address the issue with the Decision Board.

36.4.5.3 Phase III Design Development Cost Benefit Analysis Update. In this phase, the ICR Team is expecting detailed cost data to be available to support Decision Point 3, however, the basic CBA Process mirrors that conducted in Phases I and II.

36.4.6 Alteration Figure of Merit. The AFOM is used in concert with the Technical Assessment and the CBA to form the RCP, which is provided to and forms the basis for the Board Decisions. The AFOM is initially calculated prior to Decision Point 1, and then updated to support Decision Points 2 and 3. The AFOM is defined as the quantitative "War Fighting or Readiness Benefit" assigned to each proposed alteration. Appendix E reflects the AFOM Flowchart. Fleet and OPNAV members of the 3-Star Board weight this structure annually, on or about October of the fiscal year, using United States Fleet Forces Command guidance which is based on numbered Fleet and TYCOM Integrated War Fighting and Readiness priorities and additional inputs from the CNO Campaign Analysis and Sea Trials processes. There are two components to the process of assigning AFOMs to each SCD:

- a. The annual establishing of weights based on Fleet priorities.
- b. The continuous action by respective TYCOMs to assign index values to standardized rating scales that address:
 - (1) Suitability (Reliability, Maintainability, Operational Availability, Supportability, Safety).
 - (2) Quality of Service/Quality of Life (QOS/QOL).
 - (3) Capability.

Separate from this annual event, TYCOMs continue to review and assign index values to the previously noted standard rating scales for each change as part of the throughput of SCDs. Commander, Naval Surface Forces/Commander, Naval Air Forces (COMNAVSURFOR/COMNAVAIRFOR) will rate each proposed alteration using established rating scales and Fleet Staff SME recommendations to calculate the AFOM through a Flag-weighted algorithm that resides in NDE. The TYCOM Rating Scale Index Value assignments are entered in NDE and calculated to provide an overall AFOM and nested AFOMs that articulate the change benefits of Capability, Suitability and QOS/QOL to the Entitled Process Decision Board members.

36.4.7 Annual Assignment of Weights. The annual assignment of weights is a key component of the AFOM assignment and ensures the AFOM process remains current with Fleet/Navy priorities. The weights are the foundation of the algorithm in NDE which calculates the AFOM assignment for each alteration.

- a. The Entitled Process 3 Star Board shall annually determine the numerical weights of the Naval Power 21-based AFOM Benefit Structure using the Merit Assessment Questionnaire. The determination of AFOM Benefit weights will be executed using a pair-wise mathematical analysis tool. Each Entitled Process Fleet 3 Star Board member indicates his/her preferences using the formatted pair-wise questionnaire provided in the Merit Assessment Questionnaire.
- b. Respective TYCOMs will continue to review and assign initial AFOMs as dictated by the throughput of SCDs, using SMEs from activities in the area associated with each SCD. Each SCD that successfully completes the Technical Assessment block in each phase is mapped by the submitter in NDE by Naval Capability and routed to cognizant TYCOMs. The TYCOMs will canvass appropriate SMEs for input, providing relevant TYCOM-generated questions to the SME to assist in their review. Using these questions, the TYCOM SME representative will review the information listed in the SCD and will provide inputs back to the TYCOM by recommending the Index values associated with the AFOM Benefit Structure Rating Scales discussed earlier. The TYCOM will review inputs and enter the final Index value in NDE. NDE will aggregate TYCOM inputs and automatically calculate or recalculate the AFOM based on the algorithm which reflects the weights described above. This process is replicated in each of the first three phases (Preliminary Analysis, Concept Design, Design Development) to support the three decision points. An overall AFOM score and a breakout of AFOM by Capability, Suitability, QOS/QOL and each of the four Naval Power 21 Capabilities (Sea Base, Sea Strike, Sea Shield, ForceNet) will be included on the RCP.

36.4.8 Combining of Phases. Guidelines for combining of Phases II and III:

- a. If the Scope is Internal Equipment Modification, all of the following criteria must be met:
 - (1) The change can be accomplished without changing an interface external to the equipment or system.
 - (2) The change is made within the equipment or system.
 - (3) The change does not negatively impact Strike Force Interoperability.
 - (4) The change does not impact shipboard distributive systems (i.e., water, ventilation, electrical, power, etc.), Ship Selected Records or interfacing equipment or systems, compartmental arrangement records or Damage Control records.
- b. If the scope is Ship Modification all of the following criteria must be met:
 - (1) The change does not negatively impact Strike Force Interoperability.
 - (2) The change does not impact ship's stability records (weight & moment).
 - (3) The change does not impact or alter the 3-dimensional footprint of the equipment being replaced.
 - (4) The change does not impact shipboard distributive systems (i.e., water, ventilation, electrical, power, etc.), Ship Selected Records or interfacing equipment or systems, compartmental arrangement records, or Damage Control records.
 - (5) The change does not impact manning levels.
- c. If all of the guidelines listed above are met, the technical assessment team may recommend Phases II and III be combined.
- d. If the Phase I O-6 Board determines Phases II and III can be combined, then both Phases II and III of the SCD must be completed before going to the Decision Point 3 O-6 Board.
- e. Duration of Alteration is designated as a Non Permanent Installation (Previously termed Temporary Alteration). **These changes will include prototypes, proof-ins and current TEMPALTS.** This type of change will adhere to the following guidance:
 - (1) A non-permanent install will start in Phase I and must be approved at Decision Point 1. After Decision Point 1, the change will proceed to SCD Phase II for concept design.
 - (2) During concept design a Ship Change Data Package, including Plan of Action and Milestones, will be prepared and the proposal sent through the review process to Decision Point 2 for approval to install.
 - (3) Approval at Decision Point 2 constitutes approval to install the non-permanent installation. At the completion of the authorized install period the change will either be:
 - (a) Removed and all documentation forwarded to the review teams and Decision Point 3 to inform all parties of the results.
 - (b) Make install permanent by forwarding results and Phase III SCD reflecting the need to make the change permanent and to install on other platforms.
 - (4) Installation will be onboard for **pre-specified amount of time not to exceed** one deployment cycle or one (1) year.
 - (5) Sponsoring Activity may utilize internal process to complete preliminary engineering and provide a draft Phase III SCD to the SPM Change Manager, or the SPM may task the Planning Yard to develop a Phase III SCD.
 - (6) Sponsoring Activity shall provide required documentation (e.g., ICDs) to support completion of the Phase III SCD.

- (7) Plan of Action and Milestones required for equipment development.
- f. If all of the guidelines listed above are met, the technical assessment team may recommend Phases II and III be combined.
- g. If the Phase I O-6 Board determines Phases II and III can be combined, Phases II and IIa of the SCD must be completed before going to the Decision Point 3 O-6 Board.

36.5 VOTING RULES.

36.5.1 Voting Database Rules. The principal document in the voting process is the RCP. The RCP is prepared electronically in NDE, and presents information from the Technical Assessment, AFOM, and CBA. While the RCP provides summary information, the capability exists to drill down to view more detail from the Technical Assessment/AFOM/CBA. The three Decision Boards mentioned in paragraph 36.6 of this chapter will be in place to approve RCPs and authorize SCDs to proceed to the next phase of the process. NDE will be the single authoritative database for Ship Modernization and will support the entire process, from alteration inception through installation of the alteration. NDE will include an electronic voting capability (eVote) to enable Decision Boards to convene virtually and on a continuous basis.

36.5.2 Initiate Ship Change Document Business Rules. The SCD will initially capture the basic idea and associated cost and mission capability information, but will be updated with more detailed information as the change matures through the process. The initiator of the change will prepare the SCD and forward to the organization, in their chain of command, authorized to submit the SCD into NDE (e.g., TYCOMs, OPNAV, PEO, PARM/Life Cycle Managers). The appropriate technical authority will be assigned at NAVSEA and will be responsible for providing updated data in the SCD to support the process through final disposition of the change.

36.6 DECISION BOARDS. The three decision points in the process (i.e., Authorize and Fund Preliminary Engineering, Design Development and Procurement/Installation) are accomplished through the three Decision Boards (O-6, 1/2 Star, 3 Star). These decisions feed the POM/Budget process to create and sustain a fully funded ship Modernization Plan (MP). A positive decision at Decision Point 1 constitutes Resource Sponsor commitment to fund the alteration through development and final installation. Appendix F reflects the Decision Point Flowchart. For each alteration the Technical Assessment, AFOM Assignment and Cost Benefit Analysis are completed prior to each decision, and aggregated in a RCP to be considered by the voting boards. The RCP will be available on a read only basis in NDE for review by SPM/PM/PARM personnel prior to consideration by the boards. NDE will provide for electronic workflow such that SCD processing up to and including voting by board members can be done virtually. While the boards will operate in a hierarchical mode where decisions made at a lower level board will be validated by the senior board, the following thresholds are established for approval authority:

- a. O-6 Board- < \$50M Total Cost
- b. 1/2 Star Board \$50-200M Total Cost
- c. 3 Star Board > \$200M Total Cost

36.6.1 Board Specific Rules. The following specific rules apply to each Board:

- a. O-6 Review Board
 - (1) Shall meet continuously on a virtual basis and consider all RCPs. For items that are outside their fiscal threshold (\$50M total program value) they make recommendations to higher boards.
 - (2) All members have the opportunity to vote on all RCPs.
 - (3) Concur or non-concur with recommendation to expedite.
 - (4) Concur or non-concur with recommendation to go to Phase IIA.
 - (5) Voting process will be achieved within the following timelines:
 - (a) 5 working days to vote.

- (b) 5 working days to adjudicate funding issues (associated with Funding Concurrence-resource identification). If resource sponsor fails to provide acceptable trade-off, the board has the authority to approve in accordance with SCD.
- b. 1-2 Star Review Board
 - (1) Will meet monthly to review Modernization Plan and to consider forwarded RCPs that fall within their monetary threshold (>\$50M and <\$200M total program cost).
 - (2) Concur or non-concur with recommendation to expedite.
 - (3) Concur or non-concur with recommendation to go to Phase IIA.
 - (4) Voting process will be achieved within the following timelines:
 - (a) 20 working days to vote.
 - (b) 5 working days to adjudicate funding issues (associated with Funding Concurrence-resource identification). If resource sponsor fails to provide acceptable trade-offs, the board has the authority to approve in accordance with SCD.
- c. 3 Star Review Board
 - (1) Will meet quarterly to review Modernization Plan and to consider forwarded RCPs that fall within their monetary threshold (above \$200M total program costs).
 - (a) Approve/disapprove 1-2 Star Board recommendations.
 - (b) Voting process will be achieved within following timelines:
 - 1 60 days to vote.
 - 2 5 days to adjudicate funding issues (associated with Funding Concurrence-resource identification). If resource sponsor fails to provide acceptable trade-offs, the Board has the authority to approve in accordance with SCD.
 - (2) Submits annual Modernization Plan to OPNAV N7.

36.7 APPROVAL FOR FLEET ALTERATIONS. Approval for Fleet Alterations shall be via official TYCOM Letter of Authorization in accordance with the milestone listed in Volume II, Part II, Chapter 2, Appendix D of this manual and entered into NDE. Alterations shall not be authorized for installation unless included in NDE. The TYCOM shall establish Fleet Alteration funding policies for each fiscal year by defining a “fleet modernization control” (i.e., a specified percent of the maintenance budget set aside for Fleet Alteration modernization). Resource sponsor (OPNAV N43) approval to fund alterations that result in exceeding the fleet modernization control will require offsets to be identified to keep the fleet modernization control at the specified level/percentage. If offsets cannot be identified, it will be the responsibility of the TYCOM to increase the fleet modernization control within the constraints of the maintenance budget (i.e., increases to the fleet modernization control will be offset by decreasing the amount of the maintenance budget allotted for maintenance).

36.8 EXECUTION YEAR CHANGES TO MODERNIZATION PLANS. It is expected this process will minimize changes during the execution year. Operational priorities may require some changes after the approved Modernization Plan has been submitted with the annual President's budget submission to Congress. Execution year changes to the approved Modernization Plan will be limited and only as approved by the Voting Boards in accordance with fiscal statutes and regulations.

36.9 METRICS. A goal of the Ship Modernization Program is to instill discipline in the process, ensuring stability from alteration inception through final installation, minimizing deficiencies. To support this stability a number of business rules have been established within this chapter. The metrics established are used by all levels of the chain of command to measure the process, determine what barriers exist in the entitled process and to predict downstream milestone attainment. Metrics are not to be used to measure performance of individuals. Any methods employed to circumvent collection of valid metrics are counterproductive, mask real process improvement, and often create more work for Maintenance Team members. From a process improvement standpoint, it is far preferable to miss a metric milestone based on good business decisions rather than to work around the process measures to avoid the “hit”.

Examples of undesirable actions:

- a. Cancellation of an aged, unscreened job with subsequent production of a new identical job for the sole purpose of avoiding a high cycle time.
- b. Having the ship re-upline a Maintenance and Material Management Maintenance Action Form (2-Kilo) with desired changes, knowing it will over write the shore file, rather than taking the First Pass Yield (FPY) hit and changing the original 2-Kilo.
- c. Not making needed changes to a 2-Kilo before screening it to a planning activity just to avoid an FPY hit.
- d. Utilizing the date the 2-Kilo is written and uplined as the “when discovered date” vice the date the deficiency was actually discovered in order to avoid a high ship to shore cycle time.

36.9.1 Evaluation. The five selected metrics below will be used to evaluate the Ship Modernization Program processes. Regional Maintenance Center (RMC) Commanders will report metric measurements to Commander, Navy Regional Maintenance Center monthly. This reporting requirement allows process efficiency and effectiveness collaboration between SEA04 and Commander, Navy Regional Maintenance Center where required, impacting process replanning and execution during Maintenance and Modernization overlap.

36.9.1.1 Process Effectiveness. For all alteration installation completions, determine if it was accomplished in the same fiscal year as called for in the Modernization Plan developed during the most recent POM cycle. (Example: The Modernization Plan used as the baseline for this metric will be set by POM06 for Fiscal Year (FY)06 and FY07 and set by POM08 for FY08 and FY09.) Metric data will be collected and analyzed monthly with Fleet and Program alterations plotted separately. This same data will be tallied by SYSCOM on an annual basis.

CALCULATION:

- 1.
$$\frac{\text{Total \# of Fleet Alterations completed as per the Modernization Plan schedule}}{\text{Total \# of Fleet Alterations completed}}$$
- 2.
$$\frac{\text{Total \# of Program Alterations completed as per the Modernization Plan schedule}}{\text{Total \# of Program Alterations completed}}$$
 - a. Source Data and Reporting Frequency for Measurement. All data used for this metric shall come from Navy Data Environment-Navy Modernization (NDE-NM). A separate monthly tally of Fleet and Program alterations installed in accordance with the Modernization Plan will be plotted to provide a trend on the “effectiveness” of the process.
 - b. Basis for Baseline: Since this metric is based solely on the entitled process, the baseline will be established after 12 months of data collection.
 - c. Required NDE Fields:
 - (1) Alteration Identifier.
 - (2) Alteration Type (Fleet or Program).
 - (3) Installation FY from most recent POM cycle.
 - (4) Actual completion FY.

36.9.1.2 Process Efficiency. The process efficiency is the percentage of planned installation dollars that were actually expensed. Comparison of the planned installation dollars to the actual cost of installations performed. For all alteration installation completions, determine if it was accomplished for the estimated cost as provided in the Modernization Plan developed during the most recent POM cycle. (Example: The Modernization Plan used as the baseline for this metric will be set by POM06 for FY06 and FY07 and set by POM08 for FY08 and FY09.) Metric data will be collected and analyzed monthly with Fleet and Program alterations plotted separately.

CALCULATION:

- 1.
$$\frac{\text{Total estimated cost of Fleet Alterations completed as per the Modernization Plan schedule}}{\text{Total actual cost of completed Fleet Alterations}}$$
- 2.
$$\frac{\text{Total estimated cost of Program Alterations completed per the Modernization Plan schedule}}{\text{Total actual cost of completed Program Alterations}}$$

- a. Source Data and Reporting Frequency for Measurement. All data used for this metric shall come from NDE-NM. A separate monthly tally of Fleet and Program alterations installed in accordance with the Modernization Plan will be plotted to provide a trend.

Source Data: NDE-NM

- b. Basis for Baseline. Since this metric is based solely on the entitled process, the baseline will be established after 12 months of data collection.
- c. Required NDE Fields:
 - (1) Alteration Identifier.
 - (2) Alteration Type (Fleet or Program).
 - (3) Installation cost estimate from most recent POM cycle.
 - (4) Actual installation completion cost.

36.9.1.3 First Pass Yield. For all SCDs, keep a count of how many are being reviewed for the first time at each major decision point and of these how many are “approved”. “Approved” are those that are not “killed” or sent back for rework. Metric data will be collected and analyzed monthly and tallied by SYSCOM on an annual basis.

CALCULATION:

- a. FPY 1 (Decision Point 1 - “Authorize Fund Preliminary Engineering”)
 - Total # of SCDs being reviewed for the first time and approved at Decision Point 1
 - Total # of SCDs being reviewed for the first time at Decision Point 1
- b. FPY 2 (Decision Point 2 - “Authorize Fund Design Development”)
 - Total # of SCDs being reviewed for the first time and approved at Decision Point 2
 - Total # of SCDs being reviewed for the first time at Decision Point 2
- c. FPY 3 (Decision Point 3 - “Fund Procurement & Installation”)
 - Total # of SCDs being reviewed for the first time and approved at Decision Point 3
 - Total # of SCDs being reviewed for the first time at Decision Point 3
- d. FPY 4 (“Ship Change (SC) Ready to Install”)
 - Total # of SCDs being reviewed for the first time and Ready to Install (Block 270)
 - Total # of SCDs being reviewed for the first time at “SC ready to install”

36.9.1.4 Productivity. For all SCDs, keep a count of how many are approved at each major decision point. Metric data will be collected and analyzed monthly, and tallied by SYSCOM on an annual basis.

CALCULATION:

- 1. Total number of alterations approved at Decision Point 1 “Authorize Fund Preliminary Engineering”
- 2. Total number of alterations approved at Decision Point 2 “Authorize Fund Design Development”
- 3. Total number of alterations approved at Decision Point 3 “Fund Procurement & Installation”
- 4. Total number of alterations approved at “SC ready to install” point
- a. Source Data and Reporting Frequency for Measurement. All data used for this metric shall come from NDE-NM. Each SCD is assigned a unique identification number in NDE on submission. A separate monthly tally of alterations approved at each point will be plotted to provide a trend on the “productivity” of the process.
- b. Basis for Baseline. Since this metric is based solely on the entitled process, the baseline will be established after 12 months of data collection.
- c. Required NDE Fields:

- (1) SCD identification number.
- (2) Approval status of SCD at each of the decision points Status will be blank for a specific decision point if SCD has not yet reached that block in the process.
- (3) Date that decision at each point was reached. Date will be blank for a specific decision point if the SCDs approval status at that point is blank.

36.9.1.5 Sunk Cost. For all SCDs that are entered into NDE under the entitled process, identify and measure the total resources (dollars) invested in SCDs that are subsequently voted to be “Inactive and Killed” at various process decision points. Metric data will be collected and analyzed monthly, and tallied by type of appropriation on an annual basis.

CALCULATION: For all SCDs that are entered into NDE

- a. Total of actual dollars expended in all FY for an SCD “killed” at Decision Point 1 (Authorize Preliminary Engineering).
 - (1) Capture actual expenditures as recorded in NDE as part of the CBA prepared for Decision Point 1.
 - (2) Metric may be further refined for phase of development and type appropriation per the cost categories recorded in the CBA as follows:
 - (a) Infrastructure investment – Appropriation/Preliminary Engineering (APPN/PE)
 - (b) Preliminary Engineering – APPN/PE
- b. Total of actual dollars expended in all FY for an SCD “killed” at Decision Point 2 (Authorize Design Development).
 - (1) Capture actual expenditures as recorded in NDE as part of the CBA prepared for Decision Point 2.
 - (2) Metric may be further refined for phase of development and type appropriation per the cost categories recorded in the CBA as follows:
 - (a) Infrastructure investment – APPN/PE
 - (b) Preliminary Engineering – APPN/PE
- c. Total of actual dollars expended in all FY for an SCD “killed” at Decision Point 3 (Authorize Procurement and Installation).
 - (1) Capture actual expenditures as recorded in NDE as part of the CBA prepared for Decision Point 3.
 - (2) Metric may be further refined for phase of development and type appropriation per the cost categories recorded in the CBA as follows:
 - (a) Infrastructure investment – APPN/PE
 - (b) Preliminary Engineering – APPN/PE
 - (c) Design Development – APPN/PE

36.10 MILESTONES. Surface Force Ship Planning Process Milestones are documented in Volume II, Part II, Chapter 2, Appendix D of this manual. Aircraft Carrier Navy Modernization Process Milestones are documented in Volume II, Part II, Chapter 2, Appendix E of this manual.

**APPENDIX A
MODERNIZATION PLAN FLOWCHART**

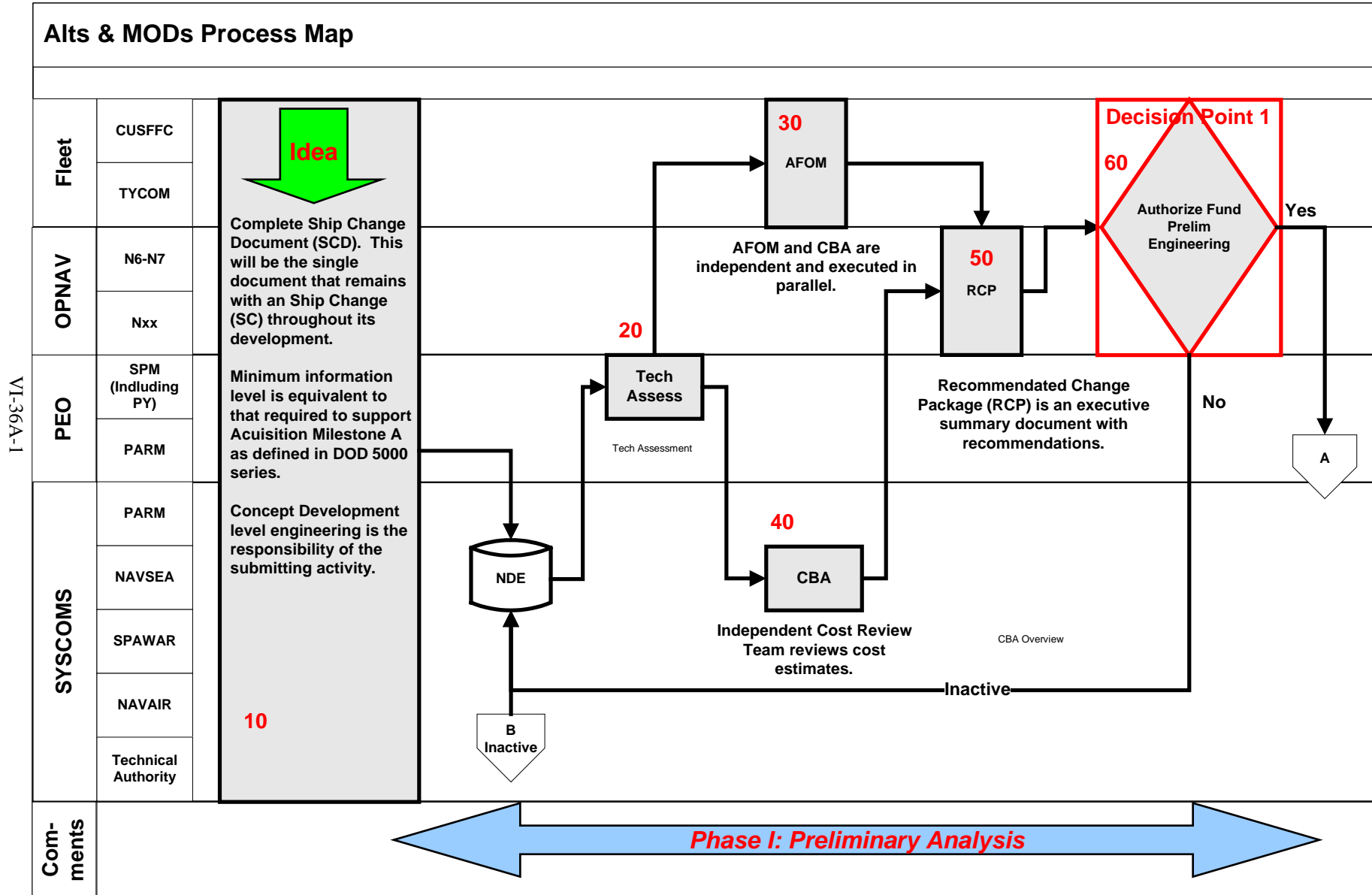

VI-36A-1

APPENDIX A
MODERNIZATION PLAN FLOWCHART

VI-36A-2

COMUSFLTFORCOMINST 4790.3 REV C

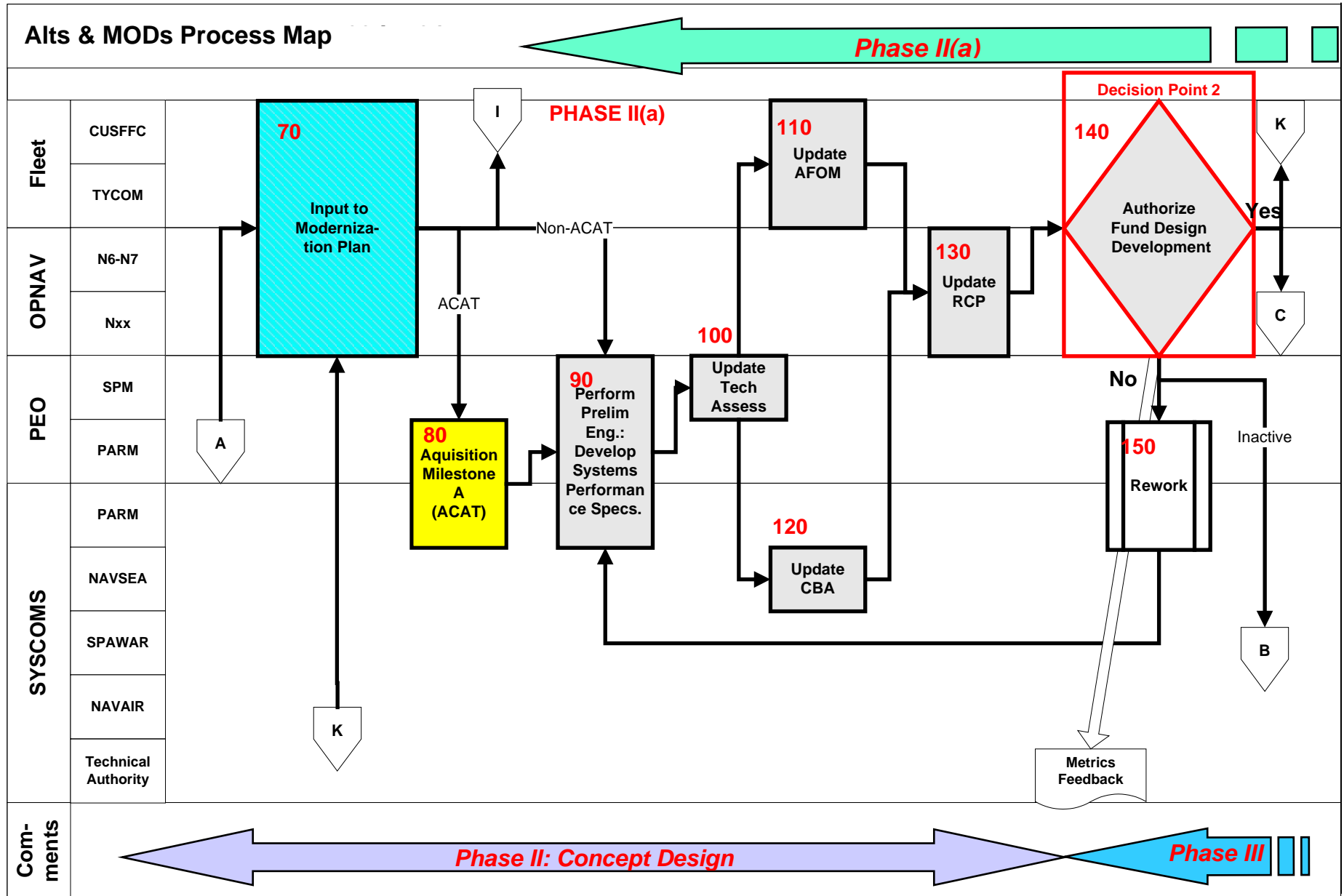

APPENDIX A
MODERNIZATION PLAN FLOWCHART

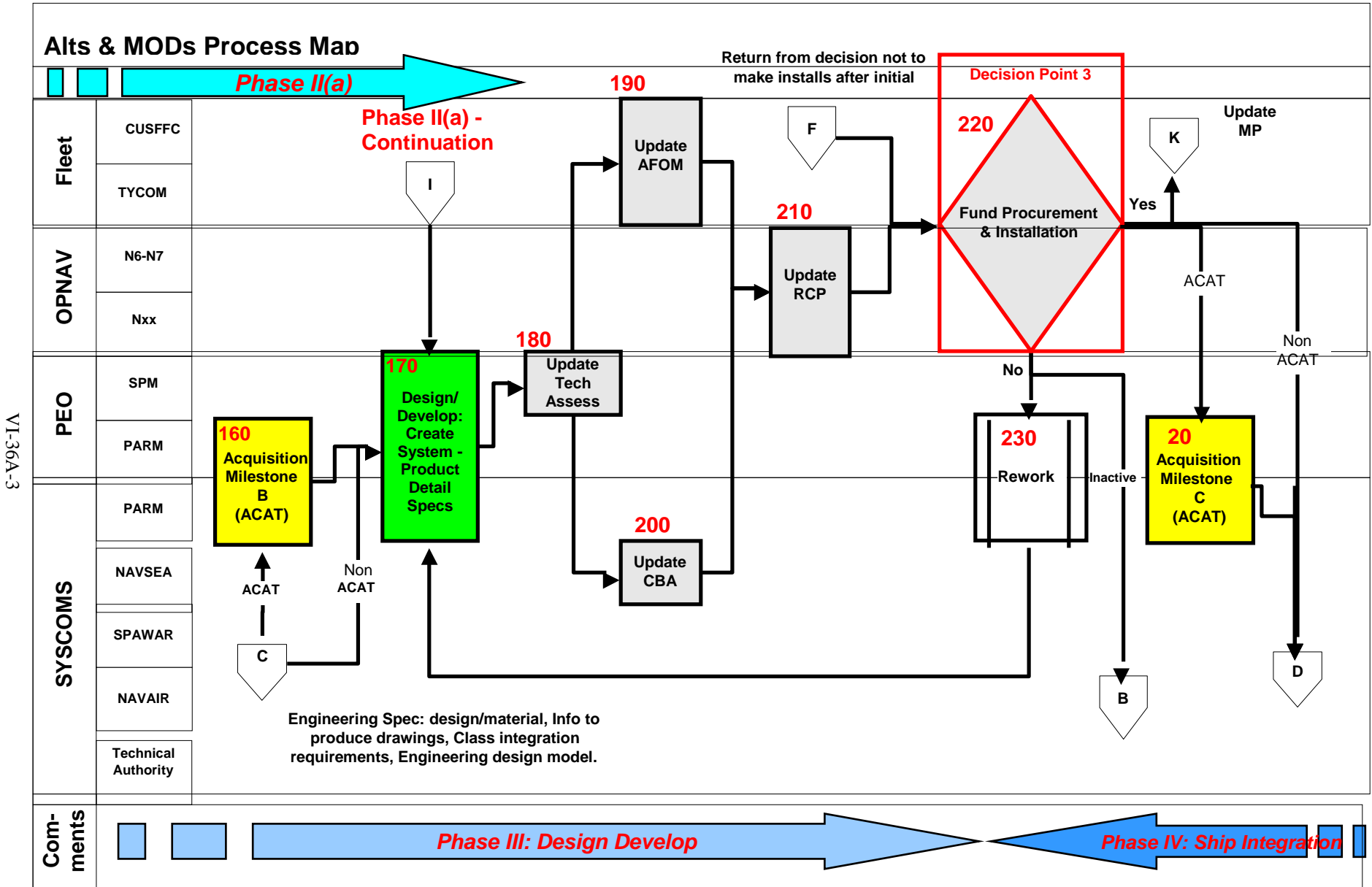

APPENDIX B
SHIP CHANGE DOCUMENT TEMPLATE
PHASE I

CHANGE TRACKING NUMBER _____ **Recommend Expedite**

DATE: _____ **CLASSIFIED/NOFORN:** YES ___ NO ___

1. SHIP CHANGE TITLE: _____

2. APPLICABLE SHIP/SHIP CLASS/SITES (INCLUDES SHORE FACILITIES): _____

3. RECOMMENDED SCD:

a. Scope: (Check all that apply)

- Internal Equipment Modification
- Ship Modification
- Site Modification

b. Category (Check all that apply)

- HM&E
- C4I
- CS
- Computer Program/Software

c. Duration

- Permanent
- Temporary

d. Funding

- Program
 - Joint
- Fleet
 - Joint

4. INITIATING POINT OF CONTACT: NAME___ ACTIVITY ___ CODE___ PHONE___ EMAIL___
 DATE___N/A___

5. SUBMITTING POINT OF CONTACT: NAME___ ACTIVITY/CODE ___ PHONE___ EMAIL___DATE___

6. PARM POINT OF CONTACT: NAME___ ACTIVITY/CODE ___ PHONE___ EMAIL___TBD___

7. TYCOM POINT OF CONTACT: NAME___ ACTIVITY/CODE ___ PHONE___ EMAIL___

8. TECHNICAL POINT OF CONTACT: NAME___ ACTIVITY/CODE ___ PHONE___ EMAIL___

9. DESCRIPTION OF CHANGE: _____

10. IMPACT IF NOT ACCOMPLISHED: _____

11. REQUIREMENTS AND JUSTIFICATION OF CHANGE (CITE DOCUMENT/REQUIREMENT IN NARRATIVE BOX)

- Statutory Requirement
- Legislated Regulatory Requirement
- Environmental Requirement
- Proposed Military Improvement
- Proposed Survivability Improvement
- Reduction of Total Owner Ship Costs (R-TOC)
- Strike Force Interoperability (BFI)

- Safety
- Mandatory Safety
- QOL/QOS
- Restoring Margins
- Contract Defect
- Unavailable, Obsolete or Unreliable Equipment
- Testing and Trial Deficiency
- Top Management Attention/Top Management Initiative (TMA/TMI)
- Aviation Capability and Air Wing Compatibility
- Anti-Terrorism/Force Protection
- Other

Need/Purpose Narrative:

12. DISTRIBUTIVE SYSTEMS/OTHER IMPACTS (Check at least one box)

	Yes	No
AC Plants/Chilled Water		
Electric Generation and Power Distribution Systems		
Topside Design/Mast Structure		
Fiber Optic Cable Plant		
Firemain		
Weight & Moment Change		
IC Switchboard & Database Multiplex System		
Electrical (400 Hz)		
Potable Water		
Fuel System		
Air Systems		
Networks		
IC Circuits		
HVAC		
Ships Characteristics Document change required		
Ship/Aviation Integration		
Storage Requirements		
Dry Docking Required		
Certification Required		
SUBSAFE		
Space Configuration		
Damage Control		
Software		
Weapons Systems		
Human Systems Integration (HSI)		
Hangar Bay/Flight Deck Encroachment		
Integrated Logistics Support (ILS)		
Prior/Concurrent/Conjunctive Alts		
Ordnance Handling/Storage		
Other (Systems/Equipment/Sites):		

13. AFOM**SEA SHIELD**

Force Protection

- Protect against SOF & Terrorist Threats
- Mitigate effects of CBRNE

Surface Warfare

- Provide Self Defense against Surface Threats
- Conduct Offensive Operations against Surface Threats

Under Sea Warfare

- Provide Self Defense against Subsurface Threats
- Neutralize Submarine threats in the Littorals
- Neutralize open oceans Submarine Treats
- Counter Minefields from deep to shallow water
- Breach Minefields, Obstacles, and Barriers from very shallow water to the beach exit zone
- Conduct Mining Operations

Theater Air and Missile Defense

- Provide Self Defense against Air and Missile Threats
- Provide Maritime Air and Missile Defense
- Provide Overland Air and Missile Defense
- Conduct Sea-Based Missile Defense

SEA STRIKE

Strike

- Conduct Strike OPS
 - Engage Fixed Land Targets
 - Engage Moving Land Targets
- Conduct Special OPS
 - Provide Precision Targeting
 - Conduct Direct Action
- Conduct Offensive Information Operations
 - Jam Potential Threats
 - Conduct Network Attacks
- Provide Aircraft Survivability

Naval Fire Support

- Provide Precision Fires
- Provide High Volume Fires
- Provide Extended Range Fires

Maneuver

- Project/Reposition Forces
- Assault Centers of Gravity and Critical Vulnerabilities
- Conduct Concurrent/Follow-on Missions

Strategic Deterrence

- Conduct Nuclear Strike
- Provide Assured Survivability

SEA BASING

Close, Assemble, Employ & Reconstitute

- Close the Force & Maintain Mobility
- Provide at Sea Arrival & Assembly
- Allow Selective Offload

- Reconstitute & Regenerate at Sea

Provide Integrated Joint Logistics

- Provide Sustainment for Operations at Sea
- Provide Sustainment for Operations Ashore
- Provide Focused Logistics
- Provide Shipboard and Mobile Maintenance
- Provide Force Medical Services
- Provide Advance Base Support

Preposition Joint Assets Afloat

- Integrate and Support Joint Personnel and Equipment
- Provide Afloat C2 Physical Infrastructure
- Provide AFSB Capability for Joint Operations

FORCENET

Communications and Data Networks

- Provide Communication Infrastructure
- Provide Network Protection
- Provide Network Synchronization
- Provide Information Transfer

Intel, Surveillance and Recon

- Conduct Sensor management and Information Processing
- Detect and ID Targets
 - Fixed Land Targets
 - Moving Land Targets
 - Air and Missile Targets
 - Surface Targets
 - Submarine Targets
 - Mines
- Provide Cueing and Targeting Information
- Assess Engagement Results

Common Operational and Tactical Pictures

- Provide Mission Planning
- Provide Battle Management Synchronization
- Provide Common PNT and Environmental Info
- Integrate and Distribute Sensor Info
- Track and Facilitate Engagement of Time Sensitive Targets
- Track and Facilitate Engagement of Non-Time Sensitive Targets

Phase I -- CBA input on SCD													
Investment Costs	Then Year Dollars (TY\$) in Thousands											To Complete (Constant Year \$)	
	FY05	FY06	FY07	FY08	FY09	FY10	FY11	FY12	FY13	FY14	To Complete		Total
System/Equipment Design/Development Cost													
Concept Development													
Preliminary Engineering													
Design Development													
<i>Subtotal System/Equipment Design/Development Cost</i>													
System/Equipment Procurement Cost													
<i>Subtotal System/Equipment Procurement Cost</i>													
Installation/Checkout Cost													
<i>Subtotal Installation/Checkout Cost</i>													
Subtotal (Sum of Major Cost Element Categories By FY)													
Appropriation/Program Element Funding Plan													
Appropriation/Program Element	Then Year Dollars (TY\$) in Thousands											To Complete (Constant Year \$)	
	FY05	FY06	FY07	FY08	FY09	FY10	FY11	FY12	FY13	FY14	To Complete		Total
Phase I - Preliminary Engineering													
Appri/PE (Include all as required)													
Phase II - Design Development													
Appri/PE (Include all as required)													
Phase III - Procurement													
Appri/PE (Include all as required)													
Phase III - Installation													
Appri/PE (Include all as required)													
Subtotal (By FY)													
Projected Savings and Cost Avoidance													
Phase	Then Year Dollars (TY\$) in Thousands											To Complete (Constant Year \$)	
	FY05	FY06	FY07	FY08	FY09	FY10	FY11	FY12	FY13	FY14	To Complete		Total
Development Phase													
- Direct													
- Additional TOC Elements													
Total Development Phase	0	0	0	0	0	0	0	0	0	0	0	0	0
Production Phase													
- Recurring													
- Non-recurring													
- Additional TOC Elements													
Total Production Phase													
Operating & Support													
- O Level / Mission Personnel													
- Unit Level Consumption													
- Intermediate Maintenance													
- Depot Maintenance													
- Contractor Support													
- Sustainment Support													
- Indirect Support													
- Other													
Total Operating and Support													
Labor rates used to calculate O&S savings/cost avoidance: O Level (\$K/man-year) = _____ I Level (\$K/man-year) = _____													
MILPERS Workload Reduction (Man-years)													
Organization Level Personnel													0.0
Intermediate Maintenance													0.0
Installation Fielding Plan Data													
Ship Class Total Installations (Ship Quantity)	Then Year Dollars (TY\$) in Thousands											To Complete (Constant Year \$)	
	FY05	FY06	FY07	FY08	FY09	FY10	FY11	FY12	FY13	FY14	To Complete		Total
Total Production Units	0	0	0	0	0	0	0	0	0	0	0	0	0
Hull XX													
Hull YY													
Hull ZZ													
Hull YY													

14. CONCEPT DEVELOPMENT COST INFORMATION:

15. APPROVAL RECOMMENDATION:

Recommended Not Recommended Recommend Re-Work

NUCLEAR POWER DIRECTORATE (As Required)

Signature _____ DATE _____

SHIP PROGRAM MANAGER

Signature _____ DATE _____

CHANGE TRACKING NUMBER _____ Recommend Expedite

SHIP CHANGE TITLE: _____

TECHNICAL REVIEW COMMENTS:

PHASE II

CHANGE TRACKING NUMBER _____

Expedite Approved

SHIP CHANGE TITLE: _____

DESCRIPTION OF CHANGE: _____

IMPACT IF NOT ACCOMPLISHED: _____

APPLICABLE SHIP/SHIP CLASS/SITES: _____

DATE: _____

1. LIST APPLICABLE SHIP(s) WITHIN 5-YEAR DECOMMISSIONING WINDOW: _____

2. DISTRIBUTIVE SYSTEMS IMPACT: (check box that applies)

	Net Increase	Net Decrease	No Net Impact	Unknown
AC Plants/Chilled Water				
Electric Generation and Power Distribution Systems				
Topside Design/Mast Structure				
Fiber Optic Cable Plant				
Firemain				
Weight & Moment Change				
IC Switchboard & Database Multiplex System				

3. OTHER CONSIDERATIONS (IF YES, PROVIDE EXPLANATION):

(i) Topside: **Yes No**

Explanation:

a. Ship Characteristics Document change required: **Yes No**

Explanation:

b. Ship/Aviation Integration Impact: **Yes No**

Explanation:

i. Storage Requirements: **Yes No**

Explanation:

ii. Dry Docking Required: **Yes No**

Explanation:

iii. Certification Required: **Yes No**

Explanation (include responsible activity):

(1) SUBSAFE Impact: **Yes No N/A**

(i) Network Impact: **Yes No**

Explanation:

(ii) Fuel System Impact: **Yes No**

Explanation:

(iii) IC Circuits Impact: **Yes No**

Explanation:

(iv) MCS/DCS Impact: **Yes No**

Explanation:

(v) Software Impact: **Yes No**

Explanation:

(vi) Weapons Systems Impact: **Yes No**

Explanation:

Space Configuration: **Yes No**

Explanation:

(vii) Hangar Bay/Flight Deck Impact: **Yes No**

Explanation:

Air Systems: **Yes No**

Explanation:

Ordnance Handling/Storage: **Yes No**

Explanation:

iv. Other: _____

Explanation:

4. SHOCK, VIBRATION AND EMI REQUIREMENTS:

Shock Grade (check one in accordance with the GSO section 072):

A B C N/A

Compliant with MIL-STD-167-1 Type 1 Vibration Requirements (check one):

Yes No N/A

Compliant with MIL-STD-461 EMI Requirements (check one):

Yes No N/A

Compliant with MIL-STD-464 EMI Requirements (check one):

Yes No Tailored (specifics appended) N/A

Compliant with OPNAVINST-2400.20 RF Spectrum Management Requirements

Yes No N/A

Compliant with HERO/HERP/HERF (NAVSEA OP 3565) Requirements (check one):

Yes No N/A

1. Remarks: _____

5. INTEGRATED LOGISTICS SUPPORT (ILS) IMPACT (check all that apply)

- Technical Manuals
- Provisioning
- Planned Maintenance System (PMS)
- Ship's Selected Records (Drawings & Manuals)
- Operating Sequencing Systems (OSS)
- Steam Plant Manual (SPM)

- Test Equipment
- Software management
Specify software support activity: _____
- Spares Affected
Specify responsible activity: _____
- COTS/NDI
- Facilities
- Other (Specify): _____

6. HUMAN SYSTEMS INTEGRATION (HSI) IMPACTS:

Manpower /Workload Impact: Yes / No

Brief Description:

Personnel Impact: Yes / No

Brief Description:

Training Impact: Yes / No

Brief Description:

Human Factors Engineering (HFE): Yes / No

Brief Description:

Habitability: Yes / No

Brief Description:

Environment, Safety and Occupational Health (ESOH): Yes / No

Brief Description:

Personnel Survivability: Yes / No

Brief Description:

7. CRITICAL MATERIAL: _____

8. PRIOR, CONJUNCTIVE OR CONCURRENT CHANGE ACCOMPLISHMENT (LIST ANY CHANGE THAT APPLIES): _____

9. ESWBS _____

10. DETAIL DESIGN CRITERIA: (Check all that apply)

- Ship Specification
- Deep Diving General Overhaul Specification
- General Specifications for Overhaul (GSO)
- Other (Specify)_____

11. PROTOTYPE REQUIRED:

Yes_____ No_____

Approx Time Required Onboard _____

12. AFOM

13. CBA INFORMATION

Phase II -- CBA input on SCD

Investment Costs	Then Year Dollars (TY\$) in Thousands												To Complete	Total	To Complete (Constant Year \$)	
	FY05	FY06	FY07	FY08	FY09	FY10	FY11	FY12	FY13	FY14						
System/Equipment Design/Development Cost																
Concept Development																
Preliminary Engineering																
Design Development																
Software Development																
Hardware Development																
EDM/Pre-Production Prototype																
Testing																
Program Management																
<i>Subtotal System/Equipment Design/Development Cost</i>																

To Complete Dollars would be entered as a total of Then Year \$. Sponsor of SCD would convert Then Year \$ for To Complete based on anticipated phasing to a To Complete (Constant Year \$) entry.

System/Equipment Procurement Cost																
Hardware Cost																
Installation Material																
Testing (Production/Post Production)																
H.S.I																
Logistics																
Topside Analysis																
Location Evaluation																
Special Evaluation																
EMX Evaluation																
RCS Certification																
Shock Certification																
Hull Evaluation																
Documentation (PTD)																
Certifications																
Distributed Systems Impact																
Interoperability Costs																
Program Management																
<i>Subtotal System/Equipment Procurement Cost</i>																

Installation/Checkout Cost	Then Year Dollars (TY\$) in Thousands												To Complete	Total	To Complete (Constant Year \$)	
	FY05	FY06	FY07	FY08	FY09	FY10	FY11	FY12	FY13	FY14						
Planning																
Design Services Allocation (DSA)																
SAR Development																
Shipcheck																
SID																
SSR/SRD																
ILS																
Configuration Overhaul Planning (COP)																
COSAL																
TM UPDATE																
CDM/SNAP VALIDATE																
Other ILS																
PROJECT MGMT																
Design Services Allocation (DSA) Non-Ping Yd																
Installation																
Shipyard (NSA)																
Mandays Required for Installation																
AIT																
Incidental Material																
Certification Cost																
TMA/TM																
<i>Subtotal Installation/Checkout Cost</i>																
<i>Subtotal (Sum of Major Cost Element Categories By FY)</i>																

Estimate for Shipyard Installation would be entered in estimated mandays per ship. NDE would calculate cost based on fielding plan, anticipated location of installation, and published Government Manday rate for year of installation.

Appropriation/Program Element Funding Plan	Then Year Dollars (TY\$) in Thousands												To Complete	Total	To Complete (Constant Year \$)	
	FY05	FY06	FY07	FY08	FY09	FY10	FY11	FY12	FY13	FY14						
Phase I - Preliminary Engineering																
Appn/PE (include all as required)																
Phase II - Design Development																
Appn/PE (include all as required)																
Phase III - Procurement																
Appn/PE (include all as required)																
Phase III - Installation																
Appn/PE (include all as required)																
<i>Subtotal (By FY)</i>																

Totals must equal

Projected Savings and Cost Avoidance	Then Year Dollars (TY\$) in Thousands												To Complete	Total	To Complete (Constant Year \$)	
	FY05	FY06	FY07	FY08	FY09	FY10	FY11	FY12	FY13	FY14						
Development Phase																
Direct																
Additional TOC Elements																
Total Development Phase	0	0	0	0	0	0	0	0	0	0	0	0	0	0	0	0
Production Phase																
Recurring																
Non-recurring																
Additional TOC Elements																
Total Production Phase																
Operating & Support																
O-Level / Mission Personnel																
Unit Level Consumption																
Intermediate Maintenance																
Depot Maintenance																
Contractor Support																
Sustaining Support																
Indirect Support																
Other																
Total Operating and Support																
Labor rates used to calculate O&S savings/cost avoidance																
O Level (\$/man-year) =																
I Level (\$/man-year) =																
MILPERS Workload Reduction (Man-years)																
Organization Level Personnel																0.0
Intermediate Maintenance																0.0

Installation Fielding Plan Data	Then Year Dollars (TY\$) in Thousands												To Complete	Total		
	FY05	FY06	FY07	FY08	FY09	FY10	FY11	FY12	FY13	FY14						
Total Production Units																
Ship Class Total Installations (Ship Quantity)																
Hull XX																
Hull YY																
Hull ZZ																
Hull YY																

Data should be entered at the lowest level possible. If hull specific information is not known, enter either Baseline/fit quantities or ship class quantities.

14. APPROVAL RECOMMENDATION:

	Recommended	Not Recommended	Recommend Re-Work
NUCLEAR POWER DIRECTORATE (As Required)			
Signature _____	DATE _____	_____	_____
SHIP PROGRAM MANAGER			
Signature _____	DATE _____	_____	_____
TECHNICAL REVIEW COMMENTS:			

PHASE III

CHANGE TRACKING NUMBER _____

Recommend Expedite

SHIP CHANGE TITLE: _____

DESCRIPTION OF CHANGE: _____

IMPACT IF NOT ACCOMPLISHED: _____

APPLICABLE SHIP/SHIP CLASS/SITES: _____

DATE: _____

1. SYSTEM/EQUIPMENT DESIGNATION: _____

2. MODEL NO. _____

3. CAGE CODE _____

4. DETAILED DESCRIPTION OF CHANGE: _____

5. DISTRIBUTIVE SYSTEMS IMPACT:

	Added	Removed
A/C Plants / Chilled Water Dist (Tons A/C)		
(CHW GPM)		
Electrical Generation and Power Dist Sys (kW)		
Topside Design / Mast Structure (Weight in Tons)		
Fiber Optic Cable Plant (Yes / No)		
Firemain (GPM)		
Ship's Stability (Weight in Tons)		
IC SWBD and Database Multiplex Sys (Loads)		

6. ARE THERE REFERENCES/SUPPORTING DOCUMENTATION IN ADDITION TO STANDARD REQUIREMENTS? Yes ___ No ___

7. ESTIMATED WEIGHT AND MOMENT:

WEIGHT	VCG	LCG	TCG
Stability Statement			

8. CHANGE MATERIAL/SOFTWARE LIST:

ITEM NO.	DESCRIPTION	UNIT OF ISSUE	QUANTITY	PROCURING ACTIVITY

9. ARE THERE QUALITY ASSURANCE REQUIREMENTS IN ADDITION TO STANDARD REQUIREMENTS? Yes ___ No ___

If Yes, List Requirements: _____

10. SPECIAL DISPOSITION REQUIREMENTS FOR REMOVED MATERIAL:

MATERIAL	DISPOSITION

11. INSTALLATION SUPPORT AND TEST EQUIPMENT: _____

12. SHIPBOARD STOWAGE DETAILS: _____

13. NAVSEA SHIP INSTALLATION DRAWING (SID) REVIEW REQUIRED: YES ___ NO ___

14. SPECIAL INDUSTRIAL STOWAGE REQUIREMENTS: _____

15. REQUIRED PRIOR, CONJUNCTIVE OR CONCURRENT CHANGES: _____

16. OTHER SYSTEMS IMPACTS: _____

17. INSTALLATION DURATION: _____

18. HUMAN SYSTEMS INTEGRATION (HSI):

Manpower/Workload: _____

Personnel: _____

Training: _____

Human Factors Engineering (HFE): _____

Habitability: _____

Environment, Safety and Occupational Health (ESOH): _____

Personnel Survivability: _____

19. CERTIFICATIONS/QUALIFICATIONS REQUIRED (CHECK ALL THAT APPLY):

ILS Cert _____ Estimated Completion Date _____

HSI Cert _____ Estimated Completion Date _____

EMI Cert _____ Estimated Completion Date _____

WSESRB _____ Estimated Completion Date _____

Software Cert _____ Estimated Completion Date _____

Shock Qualification _____ Estimated Completion Date _____

SPAWAR PPL/SSIL (IT-21) Cert _____ Estimated Completion Date _____

SEA 62 Interoperability Cert _____ Estimated Completion Date _____

Other Cert (Specify) _____ Estimated Completion Date _____

Other Cert (Specify) _____ Estimated Completion Date _____

20. DETAILED COST STRUCTURE:

Phase III -- CBA input on SCD

Investment Costs	Then Year Dollars (TY) in Thousands											To Complete (Constant Year \$)		
	FY06	FY06	FY07	FY08	FY09	FY10	FY11	FY12	FY13	FY14	To Complete		Total	
System/Equipment Design/Development Cost														
Concept Development														
Preliminary Engineering														
Design Development														
Software Development														
Hardware Development														
EDM/Pre-Production Prototype														
Testing														
Program Management														
<i>Subtotal System/Equipment Design/Development Cost</i>														
System/Equipment Procurement Cost														
Activation Cost														
Hardware Cost														
Production Engineering														
Installation Material														
INCO														
RINCO														
SPARES														
Testing (Production/Post Production)														
Developmental Testing														
Operational Testing														
HSI														
Training/Training Support														
Schoolhouse modification														
Installation Training														
NTSP Development/Update														
Training Development Costs														
Manpower and Personnel														
Top Down Requirements Analysis (TDRA)														
Other Manpower Workload Analysis														
Logistics														
Special Tools/Test Equipment/MAMS														
Facilities														
Manpower & Personnel														
PHS&I (Special Handling)														
Support Equipment														
Topside Analysis														
Topside Design														
Location Evaluation														
Special Evaluation														
EMX Evaluation														
RCS Certification														
Shock Certification														
Hull Evaluation														
Documentation (PTD)														
Certifications														
Distributed Systems Impact														
Battle Force Interoperability Studies														
Stability Analysis and Studies														
Program Management														
Stability Analysis and Studies														
<i>Subtotal System/Equipment Procurement Cost</i>														
Installation/Checkout Cost														
Planning														
Certification Cost														
ILS Certification														
HSI Certification														
Shipcheck														
SD														
SSR/SRD														
ILS														
Configuration Overhaul Planning (COP)														
COAL														
TM UPDATE														
CDM/SNAP VALIDATE														
Other ILS														
PROJECT MGMT														
Design Services Allocation (DSA)														
Mandays Required for Installation														
Shipyard (NSA)														
AIT														
OSR (On Site Representatives)														
Special Services														
Total Ship Testing														
HSI Certification														
TMA/TMA														
<i>Subtotal Installation/Checkout Cost</i>														
Subtotal (Sum of Major Cost Element Categories By FY)														
Appropriation/Program Element Funding Plan														
Phase I - Preliminary Engineering														
ApprnPE (include all as required)														
Phase II - Design Development														
ApprnPE (include all as required)														
Phase III - Procurement														
ApprnPE (include all as required)														
Phase III - Installation														
ApprnPE (include all as required)														
<i>Subtotal (By FY)</i>														
Projected Savings and Cost Avoidance														
Development Phase														
Direct														
- Additional TOC Elements														
Total Development Phase	0	0	0	0	0	0	0	0	0	0	0	0	0	0
Production Phase														
- Recurring														
- Non recurring														
- Additional TOC Elements														
Total Production Phase														
Operating & Support														
- O Level Mission Personnel														
- One Level Consumption														
- Immediate Maintenance														
- Depot Maintenance														
- Contractor Support														
- Sustaining Support														
- Indirect Support														
- Other														
Total Operating and Support														
Laborers used to calculate O&S savings/cost avoidance														
MILPERS Workload Reduction (Man years)														
Organization Level Personnel														0.0
Intermediate Maintenance														0.0
Installation Fielding Plan Data														
Total Production Units														
Ship Class Total Installations (Ship Quantity)														
Hull XX														
Hull YY														
Hull ZZ														
Hull YV														

21. APPROVAL RECOMMENDATION:

		Recommended	Not Recommended	Recommend Re-Work
NUCLEAR POWER DIRECTORATE (As Required)				
Signature _____	DATE _____	_____	_____	_____
SHIP PROGRAM MANAGER				
Signature _____	DATE _____	_____	_____	_____
TECHNICAL EVALUATION COMMENTS:				

CHANGE TRACKING NUMBER _____

Recommend Expedite

SHIP CHANGE TITLE: _____

DESCRIPTION OF CHANGE: _____

IMPACT IF NOT ACCOMPLISHED: _____

APPLICABLE SHIP/SHIP CLASS/SITES: _____

DATE: _____

1. LIST APPLICABLE SHIP(s) WITHIN 5-YEAR DECOMMISSIONING WINDOW: _____

2. SYSTEM/EQUIPMENT DESIGNATION: _____

3. MODEL NO. _____

4. CAGE CODE _____

5. DETAILED DESCRIPTION OF CHANGE: _____

6. ESWBS _____

7. PROTOTYPE REQUIRED:

Yes _____ No _____

Approx Time Required Onboard _____

8. DISTRIBUTIVE SYSTEMS IMPACT: (check box that applies)

	Added	Removed
A/C Plants / Chilled Water Dist (Tons A/C)		
(CHW GPM)		
Electrical Generation and Power Dist Sys (kW)		
Topside Design / Mast Structure (Weight in Tons)		
Fiber Optic Cable Plant (Yes / No)		
Firemain (GPM)		
Ship's Stability (Weight in Tons)		
IC SWBD and Database Multiplex Sys (Loads)		

9. OTHER CONSIDERATIONS (IF YES, PROVIDE EXPLANATION):

(i) Topside: **Yes No**

Explanation:

a. Ship Characteristics Document change required: **Yes No**

Explanation:

b. Ship/Aviation Integration Impact: **Yes No**

Explanation:

i. Storage Requirements: **Yes No**

Explanation:

ii. Dry Docking Required: **Yes No**

Explanation:

iii. Certification Required: **Yes No**

Explanation (include responsible activity):

(1) SUBSAFE Impact: **Yes No N/A**

(i) Network Impact: **Yes No**

Explanation:

(ii) Fuel System Impact: **Yes No**

Explanation:

(iii) IC Circuits Impact: **Yes No**

Explanation:

(iv) MCS/DCS Impact: **Yes No**

Explanation:

(v) Software Impact: **Yes No**

Explanation:

(vi) Weapons Systems Impact: **Yes No**

Explanation:

Space Configuration: **Yes No**

Explanation:

(vii) Hangar Bay/Flight Deck Impact: **Yes No**

Explanation:

Air Systems: **Yes No**

Explanation:

Ordnance Handling/Storage: **Yes No**

Explanation:

iv. Other: _____

Explanation:

10. SHOCK, VIBRATION AND EMI REQUIREMENTS:

Shock Grade (check one in accordance with the GSO section 072):

A B C N/A

Compliant with MIL-STD-167-1 Type 1 Vibration Requirements (check one):

Yes No N/A

Compliant with MIL-STD-461 EMI Requirements (check one):

Yes No N/A

Compliant with MIL-STD-464 EMI Requirements (check one):

Yes No Tailored (specifics appended) N/A

Compliant with OPNAVINST-2400.20 RF Spectrum Management Requirements

Yes No N/A

Compliant with HERO/HERP/HERF (NAVSEA OP 3565) Requirements (check one):

Yes No N/A

1. Remarks: _____

11. INTEGRATED LOGISTICS SUPPORT (ILS) IMPACT (check all that apply)

- Technical Manuals
- Provisioning
- Planned Maintenance System (PMS)
- Ship's Selected Records (Drawings & Manuals)
- Operating Sequencing Systems (OSS)
- Steam Plant Manual (SPM)
- Test Equipment
- Software management
Specify software support activity: _____
- Spares Affected
Specify responsible activity: _____
- COTS/NDI
- Facilities

Other (Specify): _____

12. DETAIL DESIGN CRITERIA: (Check all that apply)

- Ship Specification
- Deep Diving General Overhaul Specification
- General Specifications for Overhaul (GSO)
- Other (Specify)_____

13. ARE THERE QUALITY ASSURANCE REQUIREMENTS IN ADDITION TO STANDARD REQUIREMENTS? Yes___ No_____

If Yes, List Requirements:_____

14. REFERENCES/SUPPORTING DOCUMENTATION:

15. ESTIMATED WEIGHT AND MOMENT:

WEIGHT	VCG	LCG	TCG
Stability Statement			

16. CHANGE MATERIAL/SOFTWARE LIST:

ITEM NO.	DESCRIPTION	UNIT OF ISSUE	QUANTITY	PROCURING ACTIVITY

17. SPECIAL DISPOSITION REQUIREMENTS FOR REMOVED MATERIAL:

MATERIAL	DISPOSITION

18. INSTALLATION SUPPORT AND TEST EQUIPMENT: _____

19. SHIPBOARD STOWAGE DETAILS: _____

20. NAVSEA SHIP INFORMATION DRAWING (SID) REVIEW REQUIRED: YES___ NO___

21. SPECIAL INDUSTRIAL STOWAGE REQUIREMENTS: _____

22. REQUIRED PRIOR, CONJUNCTIVE OR CONCURRENT CHANGES: _____

23. INSTALLATION DURATION: _____

24. HUMAN SYSTEMS INTEGRATION (HSI):

Manpower/Workload: _____

Personnel: _____

Training: _____

Human Factors Engineering (HFE): _____

Habitability: _____

Environment, Safety and Occupational Health (ESOH): _____

Personnel Survivability: _____

25. CERTIFICATIONS/QUALIFICATIONS AS REQUIRED:

ILS Cert _____ Target Completion Date _____
HSI Cert _____ Target Completion Date _____
EMI Cert _____ Target Completion Date _____
WSESRB _____ Target Completion Date _____
Software Cert _____ Target Completion Date _____
Shock Qualification _____ Target Completion Date _____
SPAWAR PPL/SSIL (IT-21) Cert _____ Estimated Completion Date _____
SEA 62 Interoperability Cert _____ Estimated Completion Date _____
Other Cert (Specify) _____ Target Completion Date _____
Other Cert (Specify) _____ Target Completion Date _____

26. DETAILED COST STRUCTURE:

	FYXX	FYXX	FYXX	FYXX	FYXX	FYXX	FYXX	FYXX	FYXX	FYXX	Total
System/Equipment Design/Development Cost											
- Concept Development											
- Preliminary Engineering											
- Design Development											
- Software Development											
- Hardware Development											
- EDM/Pre-Production Prototype											
- Testing											
- Program Management											
<i>Subtotal System/Equipment Design/Development Cost</i>											
System/Equipment Procurement Cost											
- Activation Cost											
- Hardware Cost											
- Installation Material											
- Testing (Production/Post Production)											
- Developmental Testing											
- Operational Testing											
- H.S.I											
- Training/Training Support											
- Schoolhouse modification											
- Installation Training											
- NTSP Development/Update											
- Training Development Costs											
- Manpower and Personnel											
- Top Down Requirements Analysis (TDRA)											
- Other Manpower Workload Analysis											
- Logistics											
- Special Tools/Test Equipment											
- Facilities											
- Manpower & Personnel											
- Spares (testing)											
- Repair parts											
- PHS&T											
- Documentation (PTD)											
- Certification Cost											
- ILS Certification											
- H.S.I Certification											
- Interoperability Costs											
- Program Management											
<i>Subtotal System/Equipment Procurement Cost</i>											
	FYXX	FYXX	FYXX	FYXX	FYXX	FYXX	FYXX	FYXX	FYXX	FYXX	Total
Installation/Checkout Cost											
- Planning											
- Design Services Allocation (DSA)											
- SAR Development											
- Shipcheck											
- SID											
- SSR/SRD											
- ILS											
- Configuration Overhaul Planning (COP)											
- COSAL											
- TM UPDATE											
- CDM/SNAP VALIDATE											
- Other ILS											
- PROJECT MGMT											
- Design Services Allocation (DSA) Non-Ping Yd											
- Installation											
- Shipyard (NSA)											
- AIT											
- Incidental Material											
- Certifications											
- TMA/TMI											
- Topside Analysis											
<i>Subtotal Installation/Checkout Cost</i>											
Subtotal (Sum of Major Cost Element Categories By FY)											
	FYXX	FYXX	FYXX	FYXX	FYXX	FYXX	FYXX	FYXX	FYXX	FYXX	Total
Funding Phasing Plan											
Preliminary Engineering											
- Apprn/PE (Include all as required)											
Design Development											
- Apprn/PE (Include all as required)											
Procurement											
- Apprn/PE (Include all as required)											
Installation											
- Apprn/PE (Include all as required)											
<i>Subtotal (By FY)</i>											
	FYXX	FYXX	FYXX	FYXX	FYXX	FYXX	FYXX	FYXX	FYXX	FYXX	Total
Projected Savings and Cost Avoidance											
Development Phase											
- Direct											
- Additional TOC Elements											
Total Development Phase											
Production Phase											
- Recurring											
- Non-recurring											
- Additional TOC Elements											
Total Production Phase											
Operating & Support											
- O-Level / Mission Personnel											
- Unit Level Consumption											
- Intermediate Maintenance											
- Depot Maintenance											
- Contractor Support											
- Sustaining Support											
- Indirect Support											
- Other											
Total Operating and Support											

27. APPROVAL RECOMMENDATION:

Recommended Not Recommended Recommend Re-Work

NUCLEAR POWER DIRECTORATE (As Required)

Signature _____

DATE

SHIP PROGRAM MANAGER

Signature _____

DATE

TECHNICAL REVIEW COMMENTS:

(This Page Intentionally Left Blank)

APPENDIX C
TECHNICAL ASSESSMENT FLOWCHART

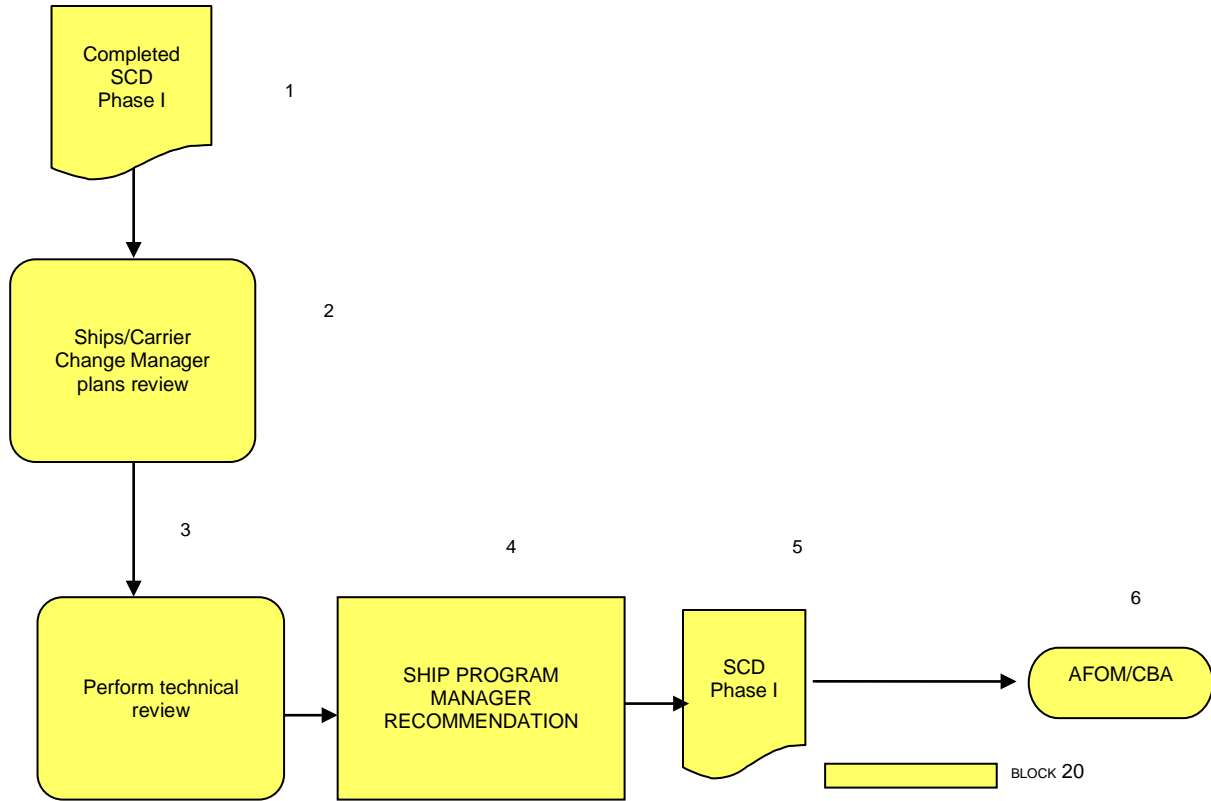

Technical Assessment Phase I

TECHNICAL ASSESSMENT FLOWCHART

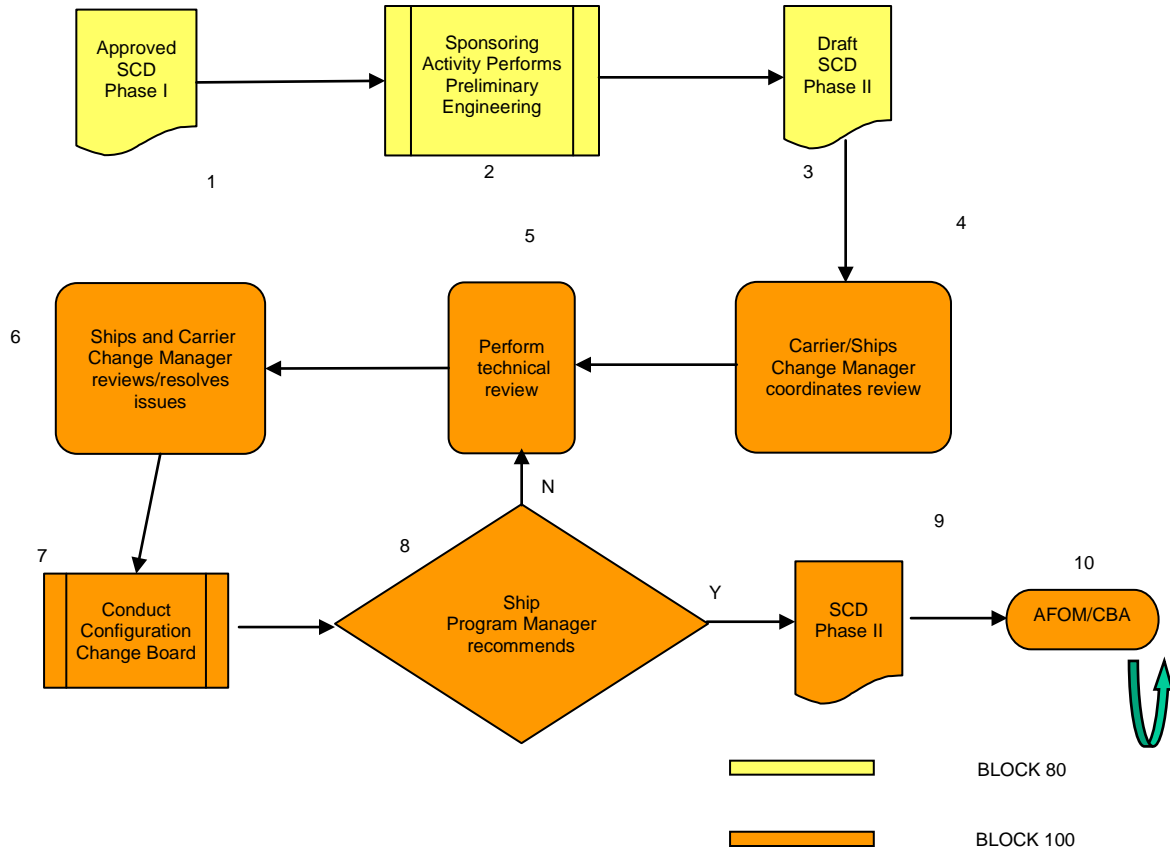

Technical Assessment Phase II

TECHNICAL ASSESSMENT FLOWCHART

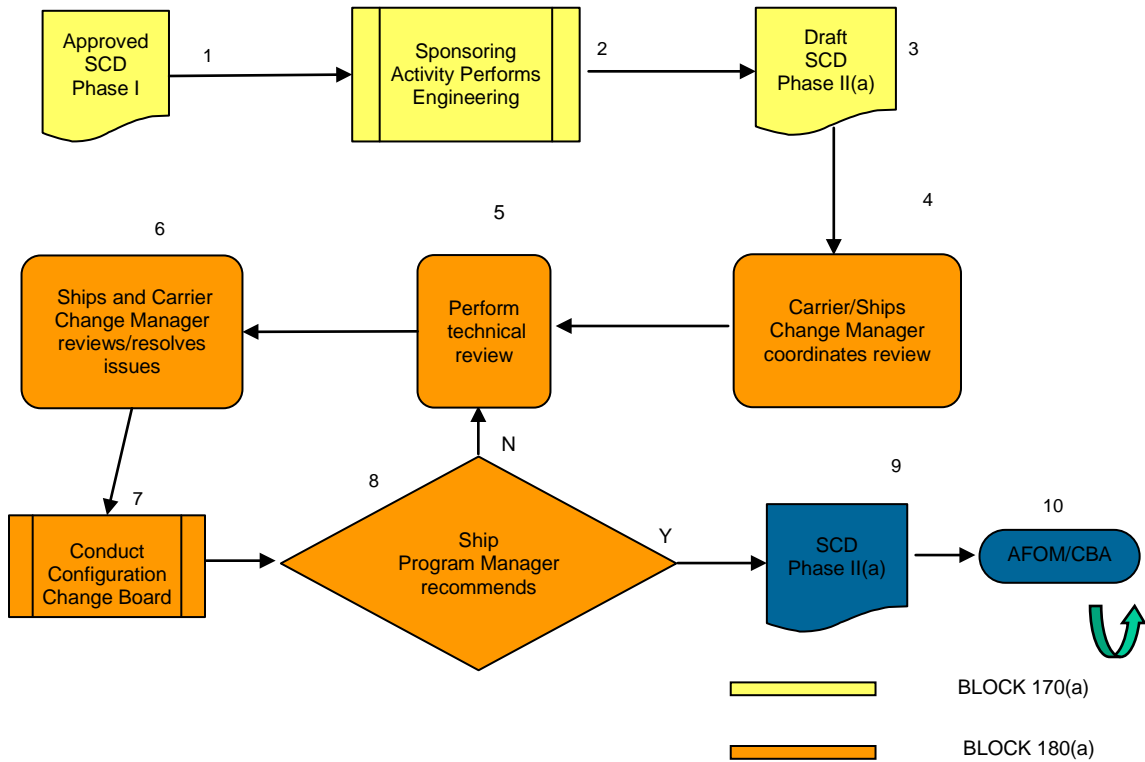

Technical Assessment Phase II(a)

TECHNICAL ASSESSMENT FLOWCHART

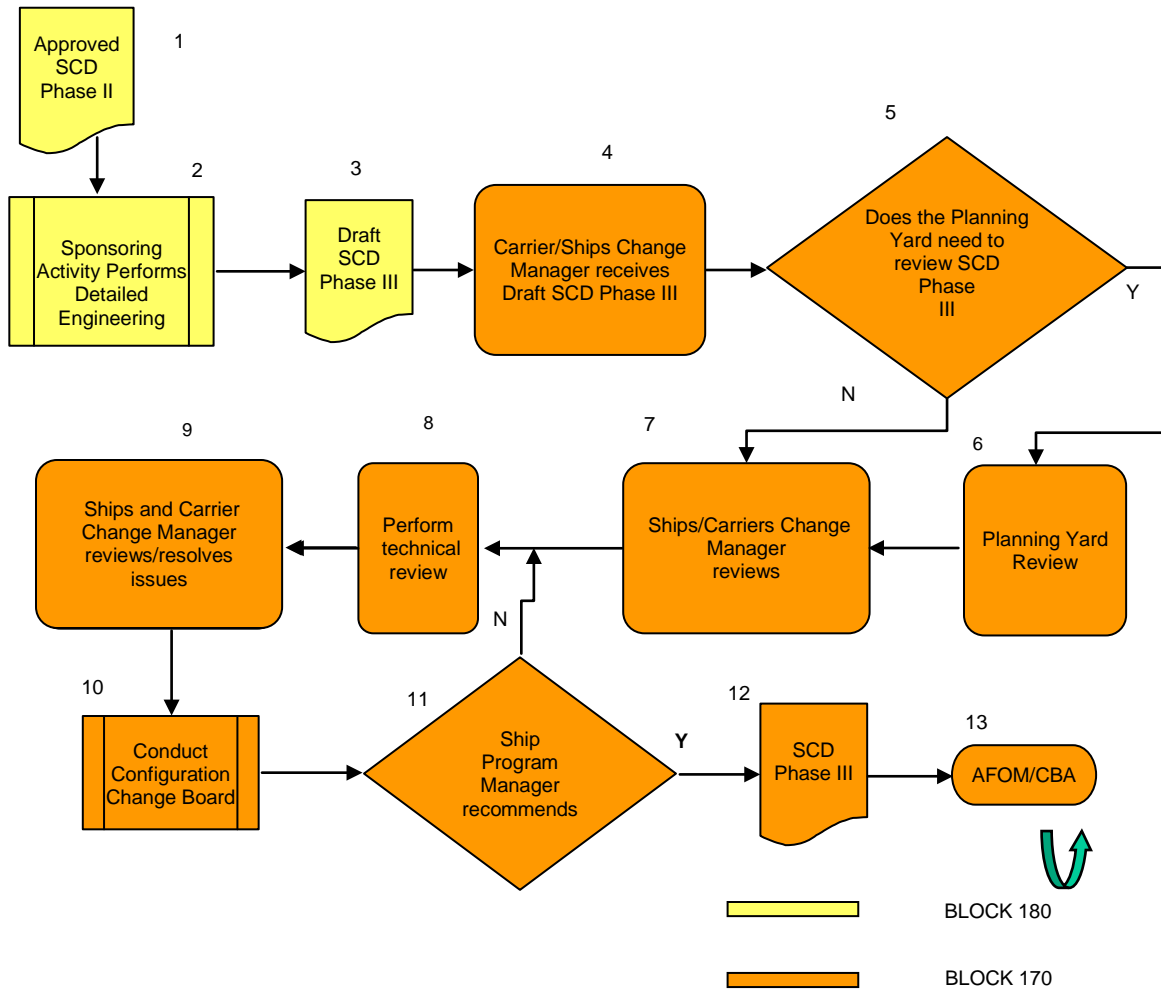

Technical Assessment Phase III

TECHNICAL ASSESSMENT FLOWCHART

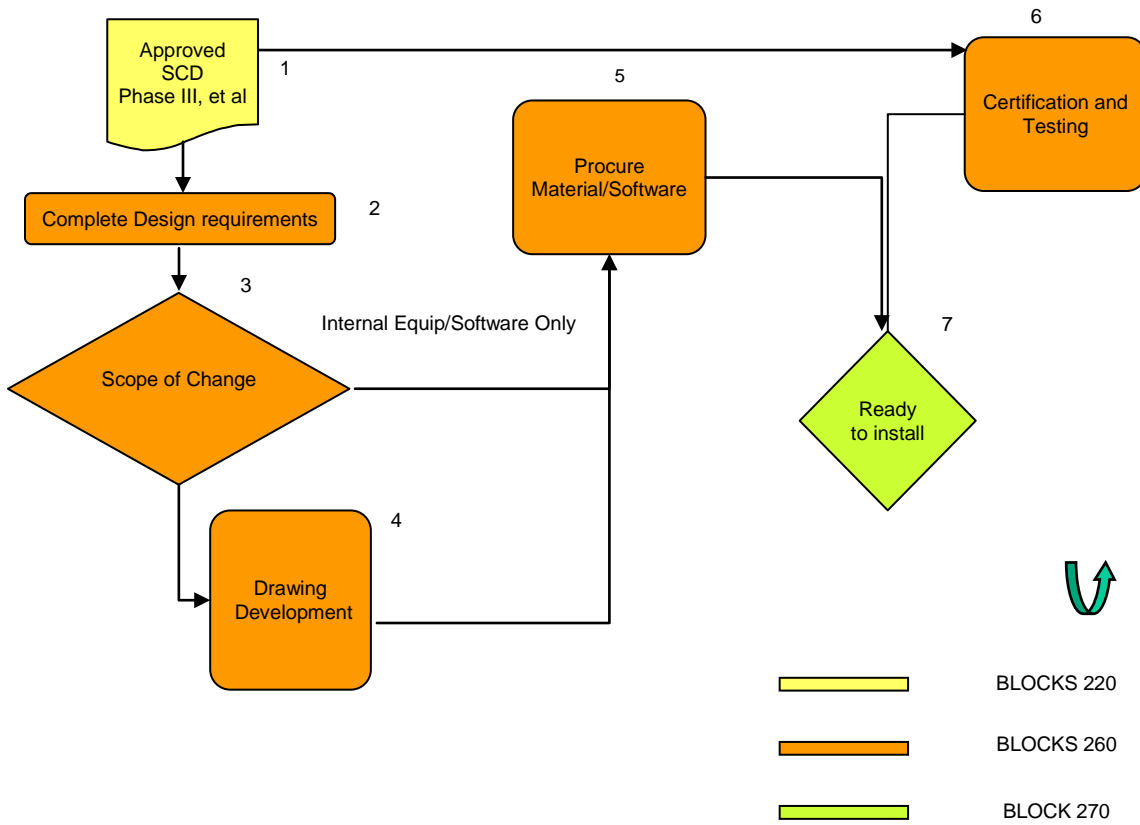

Technical Implementation Phase IV

(This Page Intentionally Left Blank)

APPENDIX D
 COST BENEFIT ANALYSIS FLOWCHART

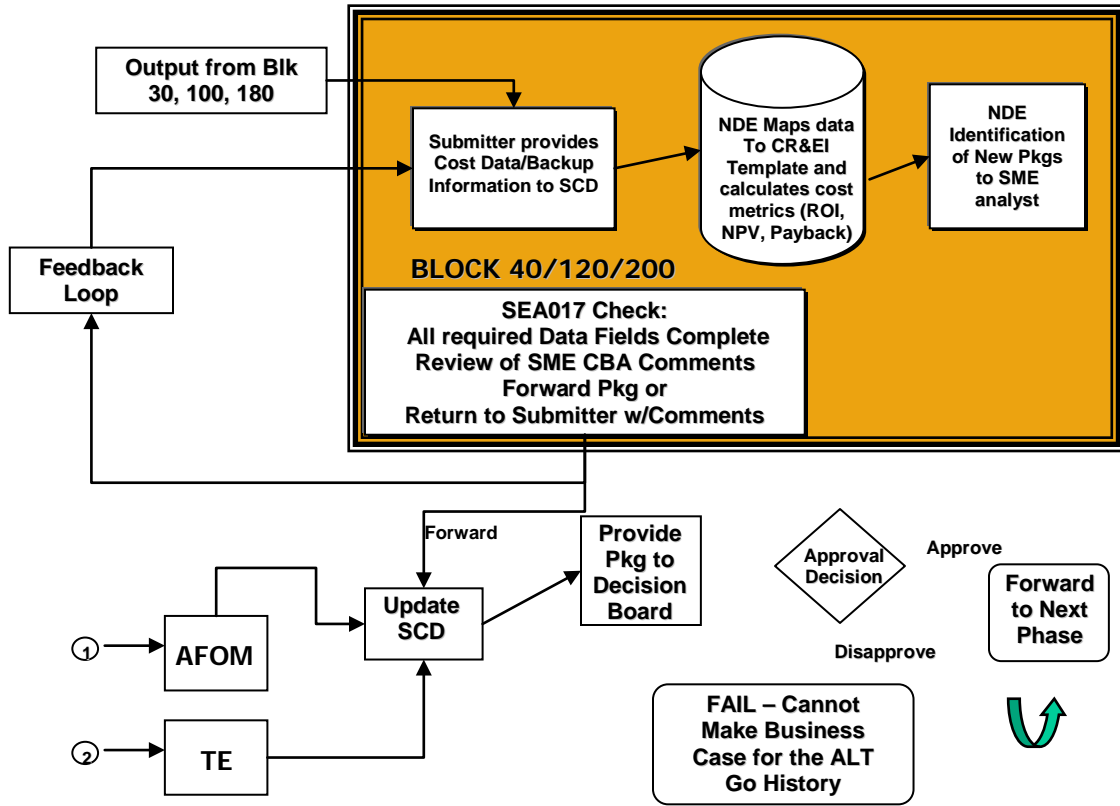

CBA PROCESS FLOW, BLKS 40/120/200

COST BENEFIT ANALYSIS FLOWCHART

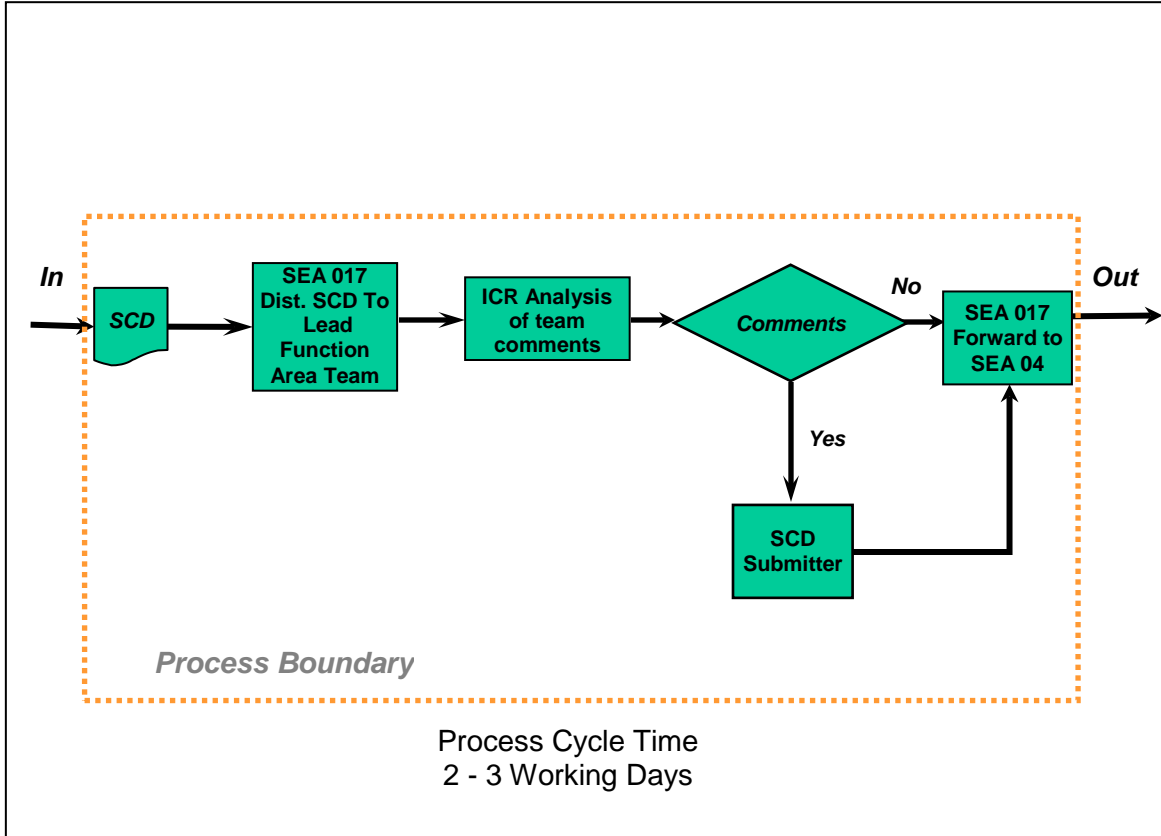

COST BENEFIT ANALYSIS (CBA) BOX #40 - LEVEL 3

COST BENEFIT ANALYSIS FLOWCHART

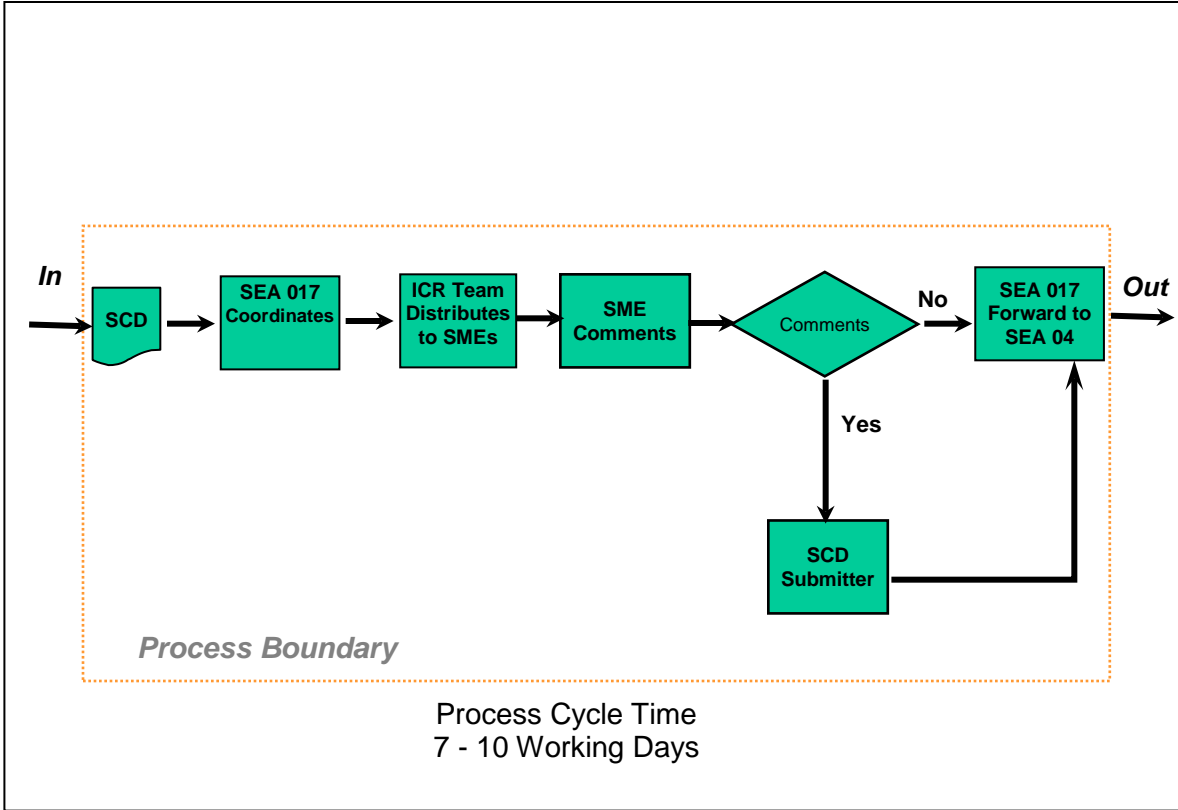

**UPDATE COST BENEFIT ANALYSIS (CBA)
BOX #120 - LEVEL 3**

COST BENEFIT ANALYSIS FLOWCHART

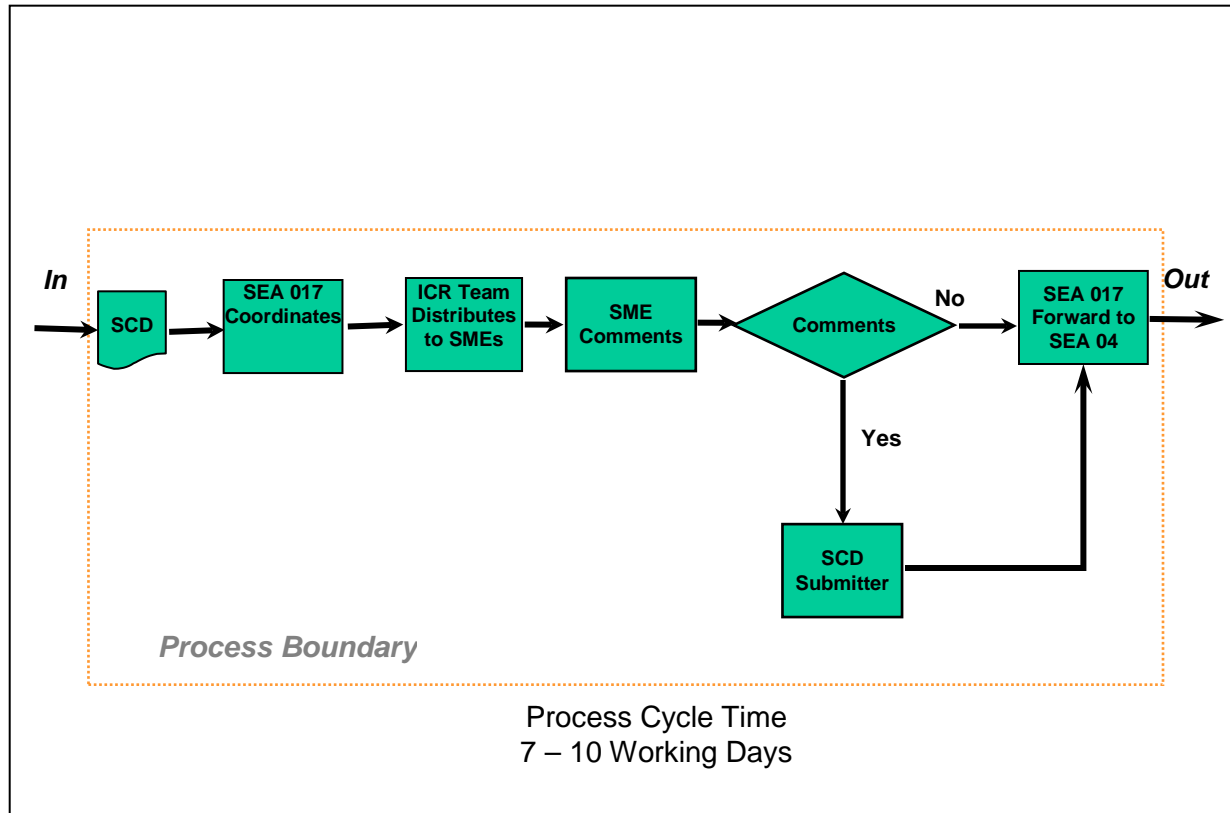

**UPDATE COST BENEFIT ANALYSIS (CBA)
BOX #200 - LEVEL 3**

APPENDIX E
ALTERATION FIGURE OF MERIT FLOWCHART

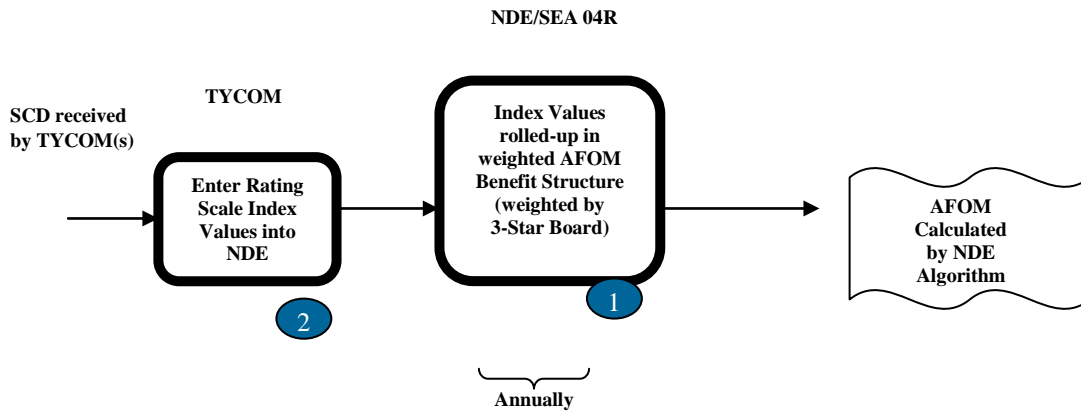

CONTINUOUS SCDs X TYCOM RATINGS X NAVY PRIORITIES (WEIGHTS)=AFOM VALUE

AFOM PROCESS (INITIAL AND UPDATE)

ALTERATION FIGURE OF MERIT FLOWCHART

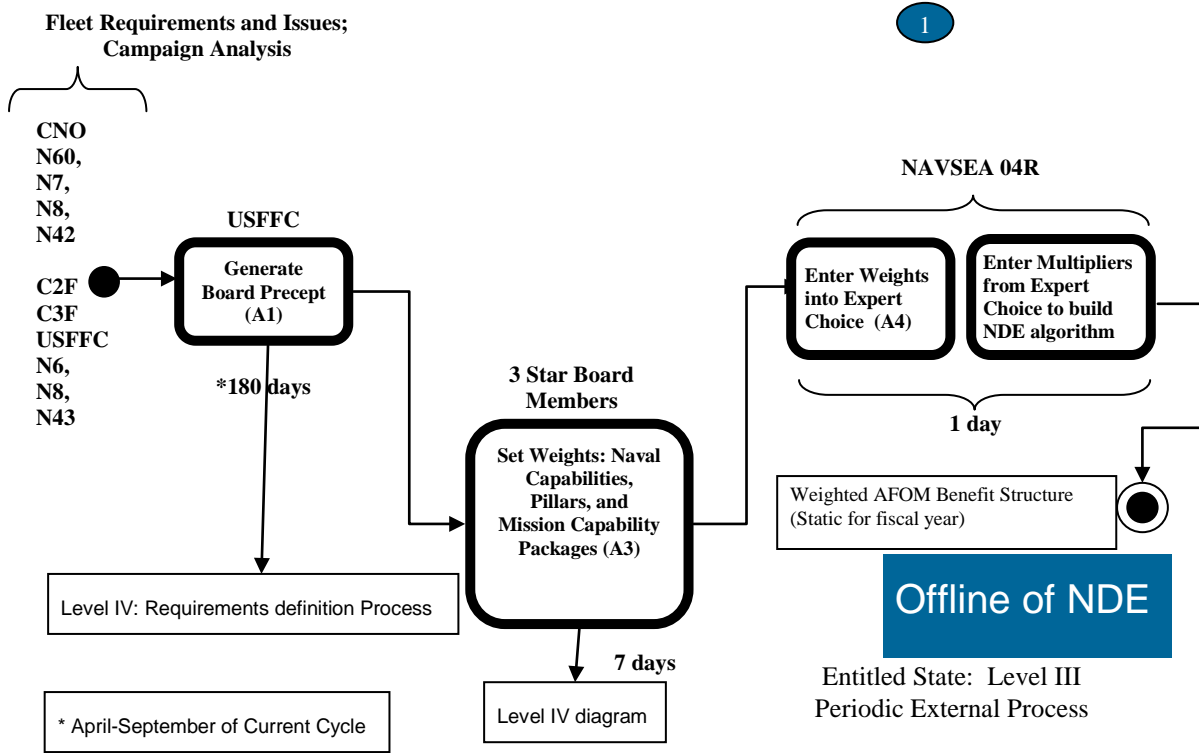

ALTERATION FIGURE OF MERIT FLOWCHART

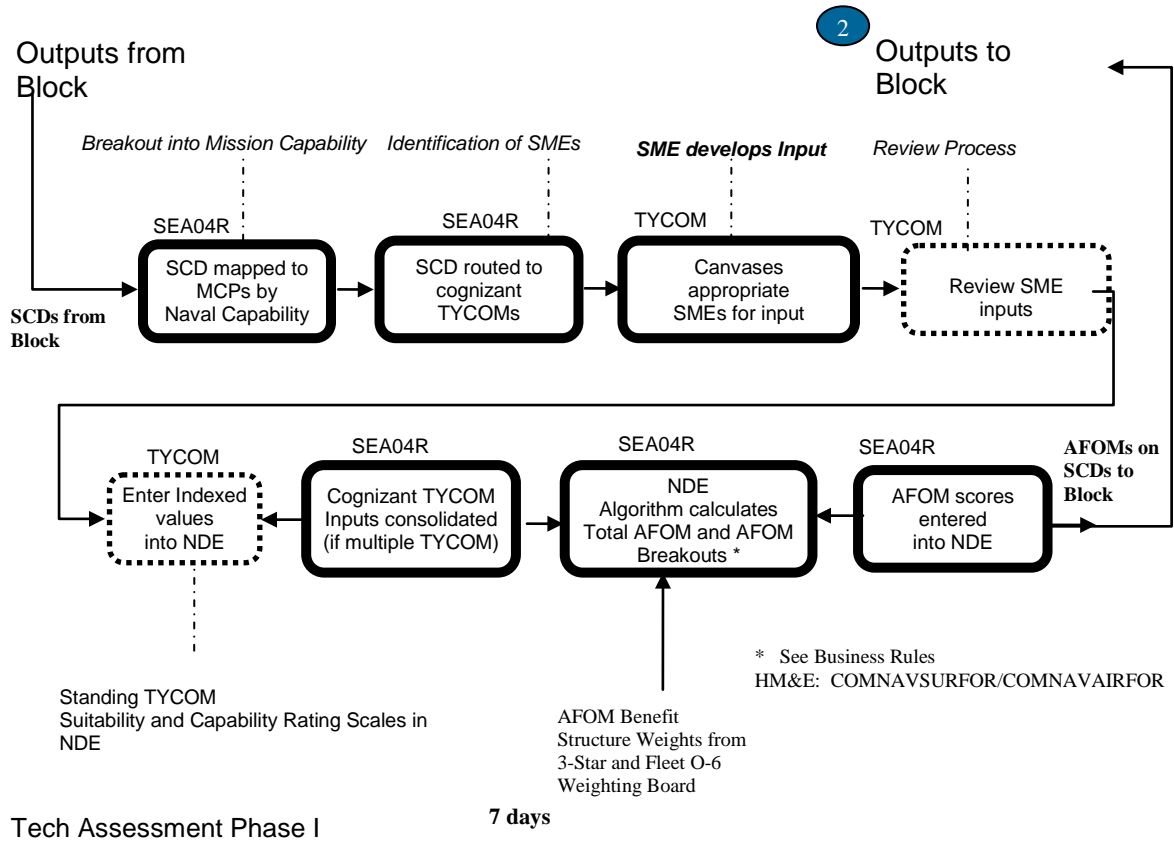

**PROCESS FLOW (LEVEL III)
- CALCULATE INITIAL AFOM**

ALTERATION FIGURE OF MERIT FLOWCHART

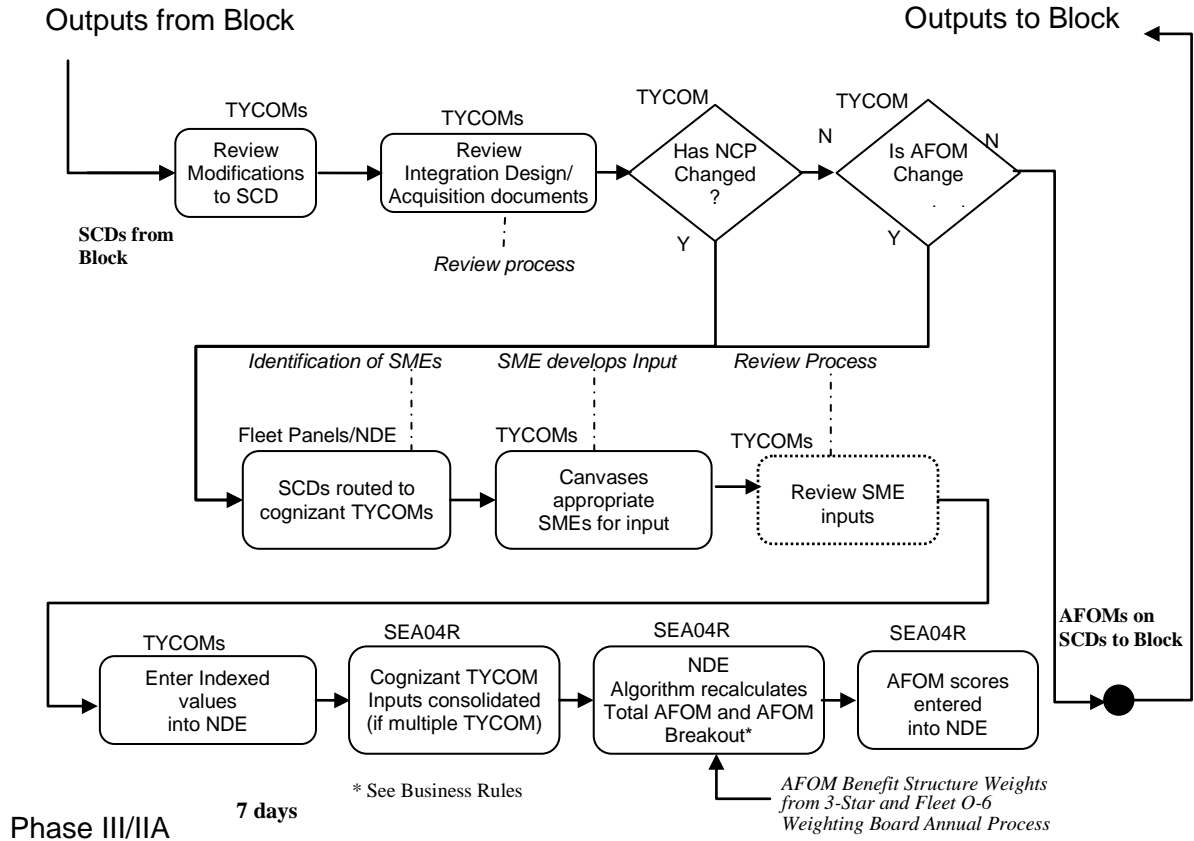

APPENDIX F
VOTING DATABASE FLOWCHART

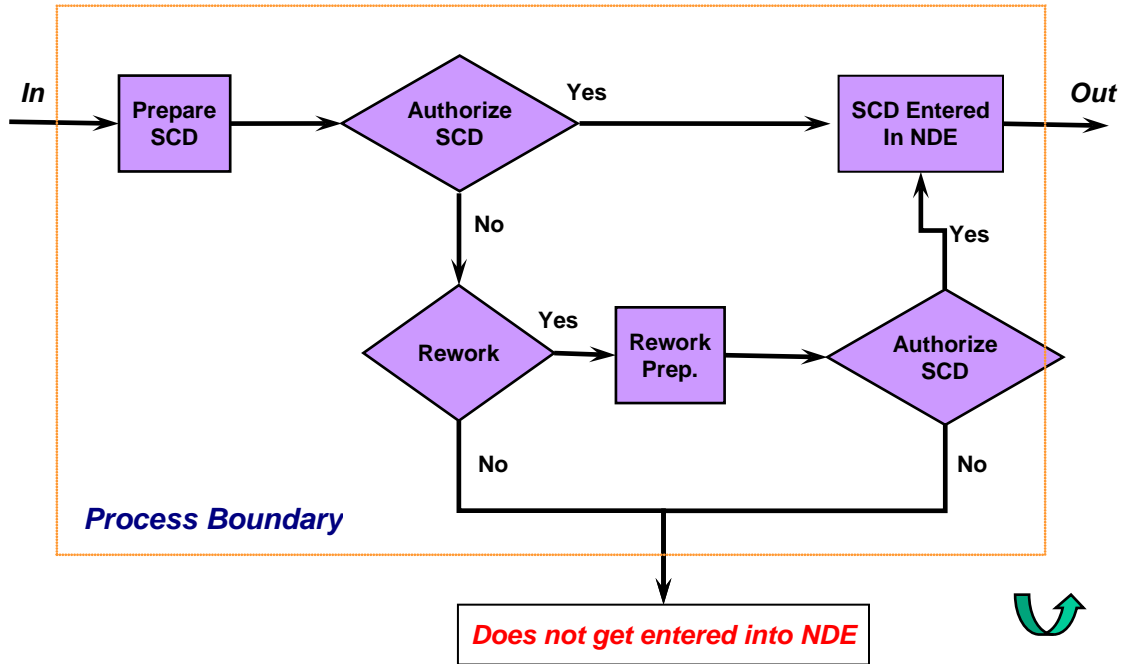

CREATE SHIP CHANGE DOCUMENT (SCD)
BOX #10 - LEVEL 3

PROCESS FLOW (LEVEL III)
BLOCK - 2ND UPDATE AFOM

VOTING DATABASE FLOWCHART

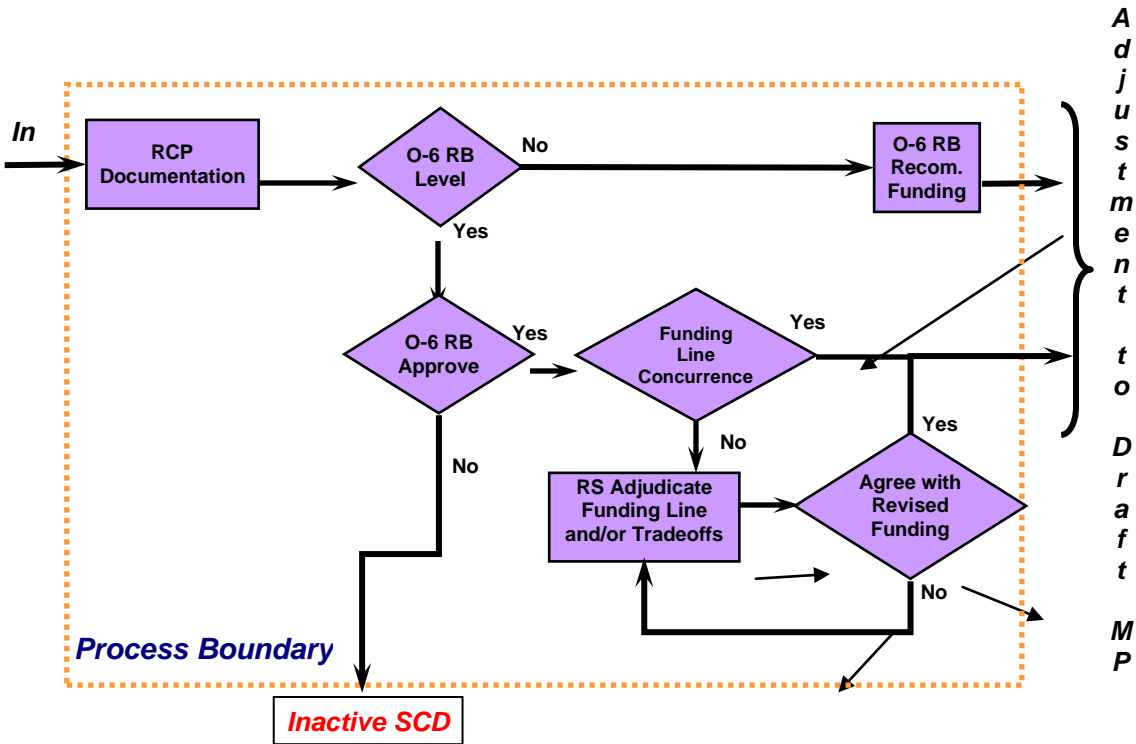

DECISION POINT 1 - O6 REVIEW BOARD
AUTHORIZE FUNDING FOR PREL. ENGINEERING
(BOX #60 - LEVEL 3)

VOTING DATABASE FLOWCHART

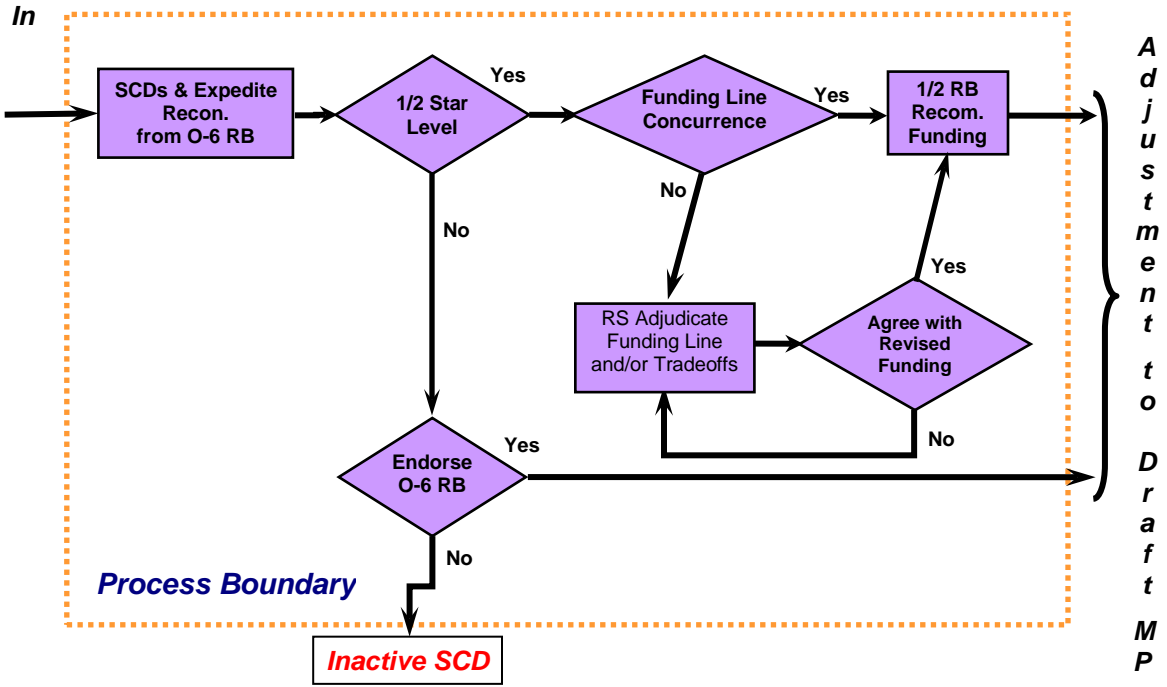

DECISION POINT 1 - 1/2 STAR REVIEW BOARD
AUTHORIZE FUNDING FOR PREL. ENGINEERING
(BOX #60 - LEVEL 3)

VOTING DATABASE FLOWCHART

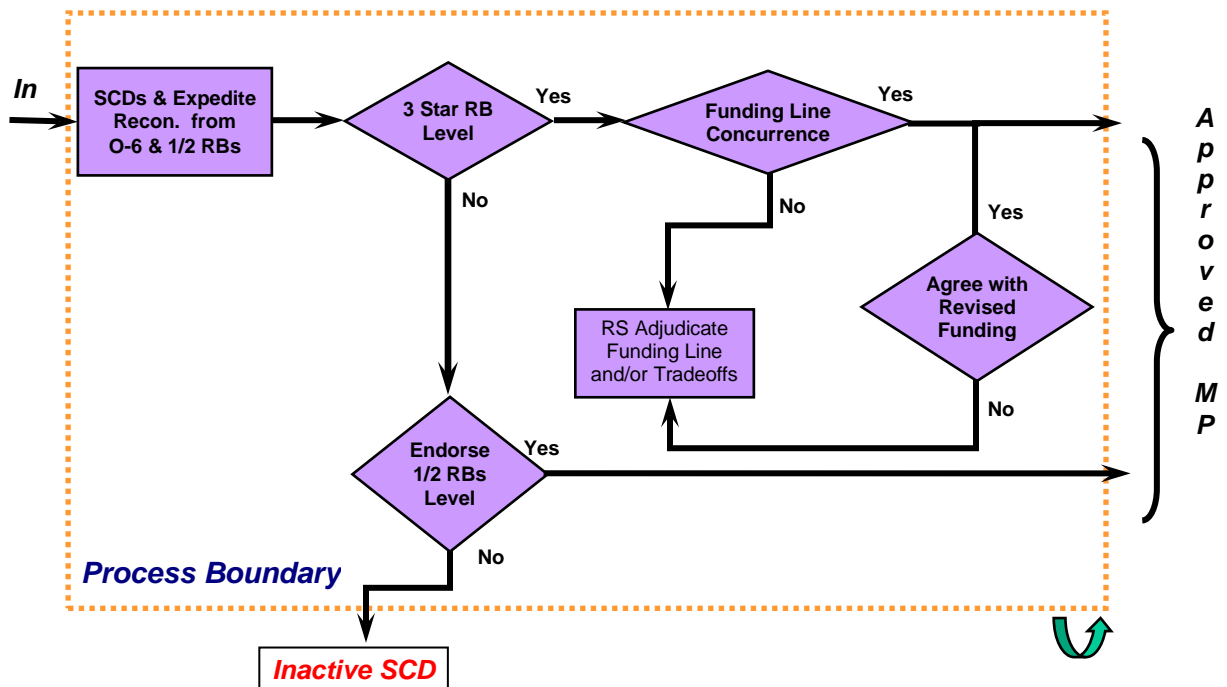

**DECISION POINT 1 - 3 STAR REVIEW BOARD
AUTHORIZE FUNDING FOR PREL. ENGINEERING
(BOX #60 - LEVEL 3)**

VOLUME VI
CHAPTER 37

**REGIONAL MAINTENANCE CENTER PASSIVE COUNTERMEASURE SYSTEM SUPPORT
REQUIREMENTS**

REFERENCES.

- (a) OPNAVINST 9070.2 - Signature Control Policy for Ships and Craft of the U.S. Navy
- (b) NAVSEA CERT 05P1 - Passive Countermeasure System (PCMS) Regional Maintenance Center Certification Plan
- (c) NAVSEA SE400-DA-MMO-010 - Passive Countermeasure System (PCMS) Technical Manual
- (d) Maintenance Index Page 4721/081 - Passive Countermeasure System (PCMS)
- (e) NAVSEA RIM 05T1-99 - PCMS Repair and Installation Methods
- (f) NAVSEA ACD 05T1-05 - PCMS Access, Material Control and Disposal Manual
- (g) NAVSEA ACD/J 05T1-05 - PCMS Access, Material Control and Disposal Manual (Japan)

37.1 PURPOSE. In accordance with reference (a), to provide guidance in the execution of a shore based Passive Countermeasure System (PCMS) maintenance program in the U.S. Surface and Submarine Fleets.

37.1.1 Background. Waterfront support for the PCMS is focused through the homeport Regional Maintenance Center (RMC). To support the Fleet PCMS program each RMC shall be capable of conducting the following core PCMS activities:

- a. PCMS Readiness Improvement Program (RIP). Stand alone on board technical training (PCMS Supervisor or Maintainer) may be provided to ships if delivering that training via the RIP process is not possible.
- b. Installation and removal of Motion Measurement System.
- c. Conduct of the AP-1 Intrusion Countermeasure Procedure system assessments.
- d. Technical assists.
- e. Prioritization and quality assurance of all topside work, executed under the authority of the former SUPSHIP organization, related to or impacting PCMS.

Resources and procedures required for these tasks are identified in reference (b). A general system description is provided in reference (c).

37.2 PASSIVE COUNTERMEASURE SYSTEM EVENT DESCRIPTION.

- a. PCMS RIP. RIPs are scheduled by the Type Commander (TYCOM) via the Immediate Superiors In Command. Immediate Superiors In Command obtain primary and secondary dates, submit via message action to TYCOM with information to the local RMC. This two-week long event is designed to provide on board training to the entire ship PCMS team, focused on maintenance and inspection training. Curricula are available for both the maintenance person and supervisor courses. The latter includes an effectiveness module, which is classified SECRET. Week one focuses on one day of training, followed by corrosion control of selected areas and trim/caulk of other areas. Week two continues the trim/caulk effort plus installs new tile in areas where corrosion control has been completed. This is the primary method of delivering training and PCMS certification for Ship's Force personnel. It also serves the purpose of providing a focused period for resourcing and accomplishment of a prioritized selection of Ship's Force capable maintenance.
- b. Motion Measurement System. In accordance with references (d) and (e), ships without installed telemetry equipment require installation and removal of Motion Measurement System for radar cross-section testing. This is accomplished by the RMC following ship submission of a 2K request.

- c. AP-1 and AP-2 Intrusion Countermeasure Procedure assessment. These comprise the annual Subject Matter Expert (SME) assessment of the ship system. It utilizes a visual assessment process in order to provide a prioritized maintenance plan for the ship. This complements the ship's 18M-1R. A structured discipline is used for this assessment. SMEs are trained in this discipline in accordance with reference (b).
- d. Technical assistance. RMC SMEs are responsible for responding to Forces Afloat requests for PCMS technical assistance.
- e. PCMS Supervisor and Maintenance On Board Training. When the RIP schedule does not permit timely accomplishment of on board maintenance training required to support Ship's Force actions required by reference (d). Such events shall be undertaken on a not to interfere basis with the other priorities detailed in paragraph 37.1.1 of this chapter. Every effort shall be made to accommodate all ship on board maintenance training through the RIP process.
- f. Prioritization and Quality Assurance of I and D Level Work. RMC SMEs shall be utilized by the RMCs to provide technical advice, including work prioritization, and quality assurance of all I and D Level PCMS related or PCMS impacting work executed under the purview of the RMC.

37.3 PASSIVE COUNTERMEASURE SYSTEM PERSONNEL CERTIFICATION.

37.3.1 Passive Countermeasure System In-Service Engineering Activity. The Naval Sea Systems Command (NAVSEA) Topside Signatures Warrant Holder has assigned the PCMS In-Service Engineering Agent (ISEA). The Topside Signatures Warrant Holder retains final authority for all PCMS personnel certification.

37.3.2 Training Requirements. In accordance with reference (c), NAVSEA 05P1 has established the requirement that all personnel involved in PCMS installation and maintenance, including inspection/assessment, surface preparation, material application, final painting or quality assurance, shall be U.S. citizens trained in the specifics of PCMS installation procedures prior to any actual tile installation work. As waterfront experience has underscored the absolute importance of limiting PCMS work to properly trained personnel, the certification process is the single most important element of quality assurance for the fleet customer. All personnel assigned PCMS duties shall be trained in the requirements of reference (f).

37.3.3 Support Personnel. In accordance with reference (d), PCMS personnel certification is required every three years. Qualifications for PCMS certification are successful completion of NAVSEA sponsored PCMS installation course conducted under the authority of Port Hueneme Detachment (PHD) Naval Surface Warfare Center (NSWC) (S22) and on-the-job-training witnessed by a certified PCMS instructor within the past three years. RMC SME personnel are also required to retain proficiency through annual accomplishment of at least one AP-1 and one RIP. This certification enables RMCs and shipyards to maintain a cadre of qualified PCMS personnel and with the assistance of the PCMS ISEA, to coordinate further certification or recertification training as required. Specific certification levels are addressed in the relevant PCMS Program NAVSEA manual.

37.3.4 Japan Regional Maintenance Center and Pearl Harbor Naval Shipyard. Due to the special circumstances of the Forward Deployed Naval Forces, Japan Regional Maintenance Center and Pearl Harbor Naval Shipyard are authorized to execute training of personnel organic to their production codes for all PCMS maintenance and installation work using the PCMS ISEA provided training guide. Training materials used to train Fleet sailors and U.S. contractors cannot be used to instruct Japan Regional Maintenance Center or Pearl Harbor Naval Shipyard organic personnel. Reference (g) provide guidance particular to Japan based support.

37.3.5 Ship's Force Personnel. In accordance with the requirements of reference (c) MRC S-1, fleet personnel conducting PCMS assessments must be graduates of a PCMS ISEA approved ship supervisor course which includes an assessment/inspection training module. Ship's Force personnel assigned maintenance duties to include all reference (c) MRCs **except** the S-1 must be graduates of the PCMS ISEA approved PCMS maintainer course.

37.4 PASSIVE COUNTERMEASURE SYSTEM TECHNICAL ASSISTANCE.

37.4.1 Technical Assistance. PCMS technical assistance is available through distance support at the local RMC.

37.5 RESPONSIBILITIES.

- a. Commander, Naval Sea Systems Command:

- (1) Certify personnel, facilities, and activities in PCMS handling, Quality Assurance, application, and destruction, maintaining records for each certification.
 - (2) Provide Equipment Guide List (EGL) packages for AP-1, AP-2 and S-1 assessments.
 - (3) Incorporate and distribute ship configuration revisions submitted following AP-1 and AP-2 assessments.
 - (4) Conduct analysis of all 18M-1R measurements and provide Forces Afloat reports of results and recommendations.
 - (5) Adjudicate all PCMS related requests for Departures from Specifications.
 - (6) Designate a PCMS ISEA to function as the first line technical resource for Forces Afloat.
 - (7) Coordinate PCMS in service activities with the broader Surface Maintenance Engineering Planning Program (SURFMEPP) organization and other activities, such as corrosion control programs.
- b. Navy Regional Maintenance Command:
- (1) Ensure that RMCs have adequate PCMS SMEs/technicians to support PCMS core activities. Provide stewardship of RMC SMEs to ensure a seamless transition when personnel are scheduled for transfer or retirement. If qualified PCMS Technicians are not available at local RMC, the RMC should contact the following (in order of contact) for assistance:
 - (a) Other RMCs.
 - (b) PCMS ISEA (NSWC PHD). This request shall include funding for the performance of the activity.
 - (2) Ensure integration of PCMS SME support to all former SUPSHIP planning and execution of shipboard repairs and other upkeep performed under the auspices of the RMC organization.
 - (3) Establish I-Level PCMS tiling support shops at RMCs with PCMS responsibilities.
 - (4) Ensure the integration of PCMS restoration on all RMC conducted repairs and corrosion control projects where PCMS coverage is required. This is to be focused on ship-shop level projects which are most efficiently accomplished inside of a production shop prior to return aboard ship.
- c. Type Commanders shall:
- (1) Coordinate with the System Commands in identifying, solving and correcting PCMS deficiencies.
 - (2) Refer all PCMS related Departures from Specifications to NAVSEA for adjudication..
 - (3) Prior to promulgation, review and authorize all documents prepared by technical agencies that contain procedures relative to PCMS and the fleet PCMS program.
 - (4) Evaluate comments and recommendations regarding the fleet PCMS program. If necessary, promulgate changes to existing policy and procedures.
 - (5) Fund PCMS RIPs to provide for the additional RMC labor and material required to conduct these events at least bi-annually.
 - (6) Ensure that proper corrosion control procedures are employed in the planning and execution of I and D Level maintenance affecting PCMS areas. Reference (e) provides detailed guidance.
- d. Immediate Superiors in the Chain of Command (ISIC) shall:
- (1) Submit requests to schedule PCMS core activities for each unit to maintain unit currency in trained personnel and 18M-1R assessments. PCMS RIPs shall be conducted at an interval not to exceed 24 months.

- (2) Review and take the appropriate action to correct PCMS discrepancies for subordinate units.
- e. RMCs shall:
 - (1) Maintain qualified PCMS personnel and ensure assets are available to perform PCMS core activities in accordance with reference (b).
 - (2) Provide Technical Assistance via distance support/on site visit as appropriate.
 - (3) Conduct PCMS core activities. Provide the following to the PCMS ISEA within four weeks following AP-1 events:
 - (a) Redlined updates to key plans and detailed drawings.
 - (b) Completed EGL inspection checklist, including revised items.
 - (c) Completed digital photo survey.
 - (4) Ensure all personnel assigned to PCMS responsibilities meet the requirements of reference (b).
 - (5) Ensure that RMC PCMS SMEs are involved in planning of all PCMS equipped ship topside maintenance where PCMS is affected.
 - (6) Ensure that RMC Quality Assurance personnel, certified by the PCMS ISEA, are actively involved in the Quality Assurance of all I and D level PCMS related repairs and installations.
 - (7) Ensure that contracted or I-Level jobs activities, facilities and personnel selected to conduct PCMS work are certified for the work being conducted.
 - (8) Include in contracted I and D-Level jobs the provision of PCMS tiles for planned PCMS repairs and interference areas. Ships shall not be tasked to provide tiles or other PCMS Allowance Parts List/Allowance Equipage List items to support work undertaken by other than Ship's Force, except with the specific concurrence of the TYCOM.
- f. Surface Force Ship Commanding Officers shall ensure:
 - (1) Scheduling of PCMS activities within periodicity.
 - (2) Obtaining RMC SME assistance in reviewing work packages to ensure identification of all topside signature related issues.
 - (3) Establishment and maintaining of the following shipboard organization:
 - (a) PCMS Department Head: in accordance with reference (a), the Commanding Officer shall appoint a Department Head responsible for coordinating operation and maintenance of PCMS. Their responsibilities include:
 - 1 Providing the Commanding Officer monthly PCMS effectiveness summaries including major PCMS deficiencies, the compliance of the ship with personnel certification requirements, an abbreviated Plan of Action and Milestones for correction of Category 1/2/3 deficiencies and corrosion items, and the due date for the next 18M-1R.
 - 2 Coordinating shipboard PCMS indoctrination for newly reported personnel.
 - 3 Coordinating ship-wide PCMS preventive and corrective maintenance schedule.
 - 4 Coordinating distribution and update of Planned Maintenance System (PMS) materials including ship specific PCMS keyplan drawings and EGLs required for PMS inspections.
 - 5 Serving as single point of contact for Quality Assurance of PCMS related Current Ship's Maintenance Project entries, review of all topside configuration changes (including program alterations, fleet alterations, field changes, etc.) to ensure Radar Cross Section reduction has been considered.

- 6 Ensuring PCMS is included in the command PMS spotcheck program.
 - 7 Assigning a command PCMS coordinator responsible to the PCMS Department Head for the detailed implementation of PCMS maintenance and operation.
 - 8 Designate in writing the maintenance assignments by all work centers assigned PCMS responsibility.
- (b) Supply Officer: Maintain Allowance Parts List stocks of PCMS materials and sufficient Allowance Equipage List items to support maintenance requirements. All shipboard stocks must be within shelf life.

(This Page Intentionally Left Blank)

VOLUME VI

CHAPTER 38

DEEP SUBMERGENCE SYSTEMS
HULL INTEGRITY PROCEDURESREFERENCES.

- (a) NAVSEA SS800-AG-MAN-010/P-9290 - System Certification Procedures and Criteria Manual for Deep Submergence Systems

LISTING OF APPENDICES.

- A SUBMEPP DSS HIP Inventory
B SUBMEPP DSS HIP Schedule
C Request for DSS HIP Periodicity Extension Format

38.1 PURPOSE. This chapter provides guidance and definition for the requirements, responsibilities and actions for Deep Submergence Systems (DSS) Hull Integrity Procedures (HIP) to continue certification for manned operations. The DSS HIP program is invoked on Dry Deck Shelter (DDS) certified under reference (a).

38.2 HULL INTEGRITY PROCEDURES MAINTENANCE SCHEDULING, PLANNING AND REPORTING.

38.2.1 Maintenance Requirements for Continued Certification. Reference (a) establishes the Maintenance Requirements and identifies the responsibilities and actions required to support continued unrestricted Submarine/DSS manned operations. In conjunction with reference (a), Naval Sea Systems Command (NAVSEA) has issued individual manuals containing required, periodic Scope of Certification (SOC) maintenance actions for each DSS. The DSS HIP procedures identify degradation of the material condition of the hull integrity boundary and of those systems affecting occupant safety. SOC certification indicates that a valid recommendation for continued manned operations can be made. Maintenance of certification is dependent on the positive control of all re-entries into the SOC boundaries per Volume V, Part III, Chapter 5 of this manual, the satisfactory and timely completion of applicable DSS HIP procedures as required by reference (a) and any necessary repairs. Accomplishment of the DSS HIPs specified with this program identify changes within the SOC boundary which result from inadvertent error and/or from degradation caused by the service environment.

38.2.2 Scheduling and Reporting. To enable the Type Commanders (TYCOM) to carry out their responsibilities in the maintenance of certification of DSSs and to aid in decisions concerning operational restrictions, an auditable system of scheduling the performance and reporting of DSS HIPs has been developed. This system provides visibility to problem areas, facilitates verification and provides a permanent record of DSS HIP accomplishment in the DSS's Maintenance and Material Management (3-M) machinery history maintained at the NAVSEA Logistics Center.

38.2.2.1 Dry Deck Shelter. Submarine Maintenance Engineering, Planning and Procurement (SUBMEPP) Activity provided Periodic Maintenance Requirement (PMR) inventories and schedules are used for scheduling and reporting. The scheduled DSS HIP requirements are added to the Current Ship's Maintenance Project (CSMP) from the local scheduling system and the Automated Work Requests (AWR) produced. Appendices A and B of this chapter show examples of the SUBMEPP DSS HIP inventories and schedules respectively.

38.2.2.2 Submarine Maintenance Engineering, Planning and Procurement Activity Inventories and Schedules. The SUBMEPP inventories and schedules are provided quarterly. The SUBMEPP schedules reflect all DSS HIP requirements coming due within the next 9 months. A description of the data elements used in the inventories and schedules is provided with each issue.

38.2.3 Baseline and Due Dates. The baseline date for determining DSS HIP due dates is the Last Maintenance Action (LMA) date. LMA dates for new requirements will be based on the Change Issue Date of the DSS HIP invoking the new requirement unless otherwise directed from NAVSEA. Due dates are calculated based on LMA dates in accordance with paragraph 38.2.3.2 of this chapter. It is recognized that upkeep schedules for vehicles

which are well into the operating cycle may not permit full compliance with the scheduled due dates. In such cases, a Departure From Specification (DFS) for the DSS HIP will be addressed on a case-by-case basis as specified in Volume V, Part I, Chapter 8 or Volume V, Part III, Chapter 8 of this manual. LMA dates and DSS HIP due dates are determined as follows:

38.2.3.1 Last Maintenance Action Date. All DSS HIPs have an initial LMA date established at installation to start the operating cycle in accordance with the applicable DSS HIP manual. During the operating cycle, an adjusted LMA, as discussed below, is used for DSS HIP. Calculate the adjusted LMA date as follows:

- a. If the PMR is accomplished during a period other than a scheduled Availability (e.g., voyage repair periods, at sea, port calls, Fleet Maintenance Activity (FMA) Availability, refit, upkeep, etc.) the adjusted LMA date will be the first of the month following the PMRs completion date.
- b. If the PMR is accomplished during a scheduled availability (e.g., Overhaul or Restricted Availability), the adjusted LMA date will be the first of the month following the scheduled availability's actual completion date.

38.2.3.2 Calculating Due Dates. Next due dates are calculated based on an adjusted LMA date. Due dates are calculated, for scheduling purposes, by taking the adjusted LMA date month (number) and adding the periodicity months (number) to show the month due (i.e., an item with an adjusted LMA date of February 2005 (2/05) with a six month periodicity would be due in August 2005 (8/05)). The PMR will be accomplished prior to midnight of the last calendar day of the month due.

38.2.4 Periodicity Extensions. When determining the due date for certain DSS HIPs inspections, inactive time may be excluded from the time elapsed since the last inspection. Extensions of periodicity from the next due date identified in the SUBMEPP PMR inventory for these DSS HIPs can be requested by the TYCOM and require NAVSEA approval. However, they are not automatic and such requests shall be submitted by letter, in the format of Appendix C of this chapter, to SUBMEPP via the TYCOM. Upon receipt of TYCOM authorization, SUBMEPP will reflect the periodicity extension and the revised due date in the next issue of the DSS's PMR inventories and schedules.

38.2.5 Scheduling, Planning and Reporting Hull Integrity Procedure Accomplishment at Sustaining Activity/Fleet Maintenance Activity Level.

38.2.5.1 Scheduling. The TYCOM PMR Scheduling System Inventories and Schedules are distributed by SUBMEPP to the appropriate Immediate Superior In Command (ISIC) every quarter. A copy of each Compact Disk (CD) is to be provided to each applicable vehicle by the ISIC. As a minimum, ISICs will schedule applicable DSS HIPs 60 days prior to scheduled availabilities. Those DSS HIP AWRs requiring work packages or other planning are forwarded to the FMA Planning Section. In the case of operational type DSS HIPs the AWRs are sent to Ship's Force Lead Work Center (LWC) 991.

38.2.5.2 Planning. FMA Planners will requisition materials, obtain plans and drawings, prepare Formal Work Packages and/or Controlled Work Packages and coordinate the scheduling with the Ship Superintendent, Production Officer and ISIC Material Office. Then the job will be turned over to the production Work Center for accomplishment. For Ship's Force accomplishment of DSS HIP, the ISIC will provide an AWR to the vehicle.

38.2.5.3 Reporting to the Maintenance and Material Management (3-M) System. Each DSS HIP AWR contains specific instructions on reporting the completed action and on use of a special feedback code to identify the material condition or that a change in inspection frequency is required. In order to ensure DSS HIPs are correctly accomplished and reported to SUBMEPP, the following actions are to be taken prior to closeout of the AWR by Analysis, Records and Reports Section (ARRS):

- a. Sustaining Activities completing DSS HIP AWRs are to fill in the AWR with action taken codes and suffix of A, B or C for material condition assessment, if applicable. Sustaining Activity will sign for completion, ISIC will sign for acceptance. Include a narrative statement, if required, and return the original AWR to the ISIC. The ISIC will review the AWR and forward to ARRS to close out the computer AWR and update SUBMEPP inventories and schedules.

- b. FMA LWCs completing DSS HIP AWRs must ensure that all assist Work Centers have completed their work. The LWC then completes the AWR by filling in action taken codes, signing for completion and obtains acceptance signature from Ship's Force. The AWR is then returned to ARRS. The ARRS will verify that all participating Work Centers have documented completion of their assigned tasks and then pass the AWR to the ISIC for review and updating of SUBMEPP inventories and schedules prior to close-out of the AWR by ARRS. Until there is a fleet scheduling system in use, PMR Schedules and Inventories should be annotated to indicate completion and forwarded to SUBMEPP.

38.2.6 Deep Submergence System Hull Integrity Procedures Accomplishment During Maintenance Availabilities.

- a. The Availability Work Package (AWP) prepared by SUBMEPP will reflect all DSS HIPs authorized for accomplishment during the availability at the AWP Ship Work List Item Number level.
- b. For DSS HIPs assigned to the depot, the ISIC will enter "Assigned to <depot name> by AWP <AWP number>" in the Remarks/Completion block of the DSS HIP Schedule/Inventory and in the local scheduling system.
- c. The ISIC will verify that all DSS HIPs assigned to the depot were reported and subsequently updated by SUBMEPP.

38.2.7 Deep Submergence System Hull Integrity Procedures Completion Reporting.

- a. Within 30 days after the completion of an availability the activity accomplishing the DSS HIP is required to provide a report of accomplishment to SUBMEPP and the DSS ISIC as well as other technical codes as designated in the DSS HIP. Specific information to be included in the report is identified in the applicable DSS HIP. The accomplishing activity shall retain a legible copy of the most current inspection report until disposal of the DSS.
- b. Prior to Manned Operations, the industrial activity accomplishing the DSS HIP is required to provide the DSS Sustaining Activity and ISIC with a letter of certification (including final inspection categories A, B or C when applicable) that certifies all required inspections have been satisfactorily completed.
- c. Upon identifying a material condition that would result in a reduced inspection periodicity if not restored to Category A condition during the availability in which the condition was found, a special report is required to be submitted by the accomplishing activity in accordance with the applicable DSS HIP and, if applicable, the AWP. This special report shall be provided immediately to NAVSEA (PMS 399)(SEA 07), TYCOM, ISIC and SUBMEPP indicating:
 - (1) Applicable DSS HIP.
 - (2) Equipment component identification.
 - (3) Inspection category.
 - (4) The reduced or deferred periodicity of each equipment component that should be inspected at less than its normal periodicity. This reduced periodicity report requirement is in addition to the completion reporting requirements.

38.2.8 Operating Cycle/Interval Extensions. An Audit Plan to assess the material condition of vehicles prior to extending their operating cycle/intervals beyond DSS HIP periodicities due to changing availability dates or operational schedules, is required.

38.3 RESPONSIBILITIES.

38.3.1 Type Commander.

- a. Perform periodic audits of the ISICs and FMAs to verify full compliance with the provisions of reference (a), Volume V, Part I, Chapter 9 of this manual and this chapter.
- b. Provide guidance to the ISICs, obtaining NAVSEA concurrence as necessary, when deviations in the scheduling or accomplishment of maintenance or repairs are required by a DFS request and resolution per Volume V, Part I, Chapter 8 and Part III, Chapter 8 of this manual.

38.3.2 Submarine Maintenance Engineering, Planning and Procurement Activity.

- a. Receive reports of completion of DSS HIPs from all completing activities.
- b. Review completion reports for compliance with the scheduled periodicity requirements and any change in the status category.
- c. Establish an LMA date per paragraph 38.2.3.1 of this chapter.
- d. Revise the periodicity and next due dates in DSS HIP inventories and schedules to reflect any NAVSEA approved periodicity change, or TYCOM approved periodicity extensions as allowed for in the individual DSS HIP.
- e. Notify the TYCOM via the on-site SUBMEPP Representative of any DSS HIP beyond periodicity for TYCOM resolution.
- f. Provide updated DSS HIP inventories and schedules CD in accordance with the distribution.
- g. Provide, as enclosures to the quarterly inventories and schedules forwarding letter, a list of DSS HIPs that appear overdue in the schedules and a list of DSS HIPs that have been reported complete by the fleet but Objective Quality Evidence has not been received by SUBMEPP.
- h. Receive and review DSS HIP Objective Quality Evidence for technical accuracy and maintain DSS HIP completion history.

38.3.3 Immediate Superior In Command.

- a. Maintain auditable records of DSS HIP accomplishment for each DSS. These records will include the current SUBMEPP Quarterly inventories and schedules, completed AWRs for DSS HIPs completed, data report forms/reports submitted as a result of last accomplishment and all approved DFSs.
- b. Conduct periodic audits of assigned FMAs and Sustaining Activities to verify full compliance with the provisions of reference (a), Volume V, Part I, Chapter 9 and Part III, Chapter 9 of this manual and this chapter.
- c. In addition to the records of audits, maintain a file, by DSS, of the current DSS HIP inventories and schedules as provided by SUBMEPP. The schedules (Appendix B of this chapter) for each DSS shall be annotated with the Job Sequence Number (JSN), the new adjusted LMA date and the next due dates for the completions and any periodicity extensions authorized.
- d. Although the responsibility for the accomplishment of DSS HIPs must rest with the DSS Commanding Officer, the nature and scope of the DSS HIPs dictate that the ISIC coordinate the accomplishment of DSS HIPs in accordance with the SUBMEPP provided PMR inventories and schedules. Accordingly, the ISIC shall assist in the preparation of, and approve each DSS HIP performance schedule. In addition, the ISIC shall:
 - (1) Unless previously notified by SUBMEPP of delays, notify the SUBMEPP Representative at TYCOM of the non-receipt of schedules and reports.
 - (2) Upon receipt from SUBMEPP, review each vehicle's quarterly DSS HIP inventory and schedule against the schedule information on the individual DSS HIP to verify DSS HIP scheduling/periodicity is accurate and that any rescheduling data which has been submitted to SUBMEPP has been accurately incorporated. PMRs accomplished during the month preceding the quarterly report may or may not be reflected in the issue received. Similarly, upon receipt of DSS HIP changes, audit the individual DSS HIP procedural and schedule information against each DSS's PMR inventory and schedule to verify that the component/equipment and periodicity has not changed and that provided changes do not impact current schedules. Resolve identified deficiencies through the SUBMEPP Representative at TYCOM.

- (3) Review the enclosures to the PMR procedural inventories and the schedule forwarding letter and advise SUBMEPP of the completion dates and JSNs for DSS HIPs listed. Forward copies of completed Data Report Forms for these and any other DSS HIP completions identified by SUBMEPP as having missing Data Report Forms.
- e. Ensure that all DSS HIP requirements with the appropriate screening (Ship's Force, FMA) are in the CSMP for subsequent development by SUBMEPP of forthcoming availability AWP's.
- f. In the event that deviations from required periodicities or full requirements of the DSS HIPs are required, request approval from the TYCOM by submitting a DFS request in accordance with Volume V, Part I, Chapter 8 of this manual. Such DFS requests will be a Major DFS for DSS HIP program deviations. DFS requests are also to be submitted when repairs arising from the DSS HIP inspections cannot be completely accomplished. Periodicity extension requests for all DSS HIPs shall be submitted in accordance with paragraph 38.2.4 of this chapter.
- g. Establish procedures to affect routing of completed AWRs from the FMA ARRS or from the Sustaining Activity (LWC 991) through the ISIC for all DSS HIP transactions. The ISIC should ensure proper documentation has been completed as described in the special reporting procedures of the AWR. This must include the material condition feedback code as part of the final action, if required. A rejection series code (6A-6I) should not be accepted unless the FMA Repair Officer cannot accomplish the DSS HIP at that site. Delays in accomplishment are to be reported as status changes so that the job remains in the production system and is visible as a "to-be-done" requirement. If the DSS HIP requirement cannot be accomplished at the site, the ISIC must ensure update (re-screening) of the CSMP concurrently with DFS notification, if necessary. Each processed AWR is to be validated with the PMR Special Report described in the Maintenance Resource Management System section of Volume II, Part I, Chapter 2 of this manual and, if satisfactory, passed to the Automated Data Processing Center for computer input. Upon receipt of the report of maintenance action accomplishment from an assigned unit or the FMA, review the report for completeness, consistency, acceptability of conditions and material trends. Where unsatisfactory conditions are found, direct repairs. Where repairs cannot be made, submit a DFS in accordance with Volume V, Part I, Chapter 8 and Part III, Chapter 8 of this manual. Ensure SUBMEPP inventories and schedules are updated in accordance with paragraph 38.3.3.c of this chapter. Clear DSS HIP major DFS upon TYCOM or NAVSEA approval and upon receipt of the SUBMEPP Quarterly PMR inventories and schedules, and ensure they accurately reflect the new due date of the DSS HIP as stated in the approved DFS.
- h. Upon identifying a material condition that would result in a reduced inspection periodicity, ensure the accomplishing activity immediately reports the condition found via official correspondence to NAVSEA (PMS 399), the TYCOM and SUBMEPP in accordance with paragraph 38.2.7.c of this chapter.
- i. Monitor the timely submission of DSS HIP data report forms and the report of accomplishment for DSS HIPs completed by the FMA and Ship's Force to ensure required documentation is submitted in accordance with paragraph 38.2.7 of this chapter. Ensure data report forms are submitted to report component replacement/repair/operation out of specification. Review all Sustaining Activity accomplished DSS HIP data for compliance with the requirements of the DSS HIP Program prior to submittal to SUBMEPP.
- j. Prior to a DSS's underway period, review the vehicle's certification continuity report, if submitted, to ensure the ISIC and DSS's records (including the CSMP) accurately reflect DSS HIP status.
- k. The Parent ISIC of deploying ships will:
- (1) Ensure that any DSS HIP due for accomplishment by the ship/DSS during its deployment period is identified in the CSMP transfer file and that the ship possesses the AWRs and DSS HIP data report forms (if applicable) for reporting job completion.

NOTE: THIS IN NO WAY RELIEVES THE PARENT ISIC OF THE RESPONSIBILITY TO ENSURE THAT THE REQUIRED DSS HIPs ARE ACCOMPLISHED WITHIN THE SPECIFIED PERIODICITIES.

- (2) Provide a message to the applicable deployed FMA/Squadron identifying any DSS HIP expected to be accomplished by the deployed FMA and the status of required materials for each DSS deploying to cover the period of the deployment.
- l. Deployed Squadrons will review the DSS HIP status of deployed DSSs upon in-chop. Perform the function of the Parent ISIC in ensuring all DSS HIPs are accomplished and reported within the required periodicity while the DSS is deployed.
- m. Prior to the start of an availability, ISIC DSS HIP coordinators will:
 - (1) Assign Job Control Numbers to DSS HIP items assigned to Forces Afloat in the AWP and screen them prior to the start of the availability in accordance with the directions in the AWP. Care must be taken to appropriately assign DSS HIP items to the correct accomplishing activity.
 - (2) ISIC DSS HIP coordinators will not assign Job Control Numbers to DSS HIP items assigned to the industrial activity in the AWP. In the DSS HIP inventories and schedules, in the remarks/completion information area, enter "assigned to (name of industrial activity) by AWP (name and number of availability)". The industrial activity is responsible for performing, auditing and reporting all DSS HIP items assigned by the AWP.
 - (3) DSS HIPs assigned to Forces Afloat by the AWP for accomplishment prior to the start of the depot period, but for some reason were not completed, will be reassigned to a concurrent availability or formally reassigned to the industrial activity via a supplemental work request.
- n. DSS HIPs assigned to the industrial activity by the AWP which are not accomplished during the depot period will be reassigned to another availability by the TYCOM following the depot period provided the DSS HIP does not exceed its due date. The ISIC will be notified of this reassignment by formal correspondence which will include justification and reason why the scheduled and planned requirements were not met.
- o. Prior to availability completion, ISICs will audit DSS HIPs assigned to Forces Afloat by the AWP and ensure all have been satisfactorily completed and documented within the required periodicity. The ISIC audit will also verify that all DSS HIP items coming due within six months of availability completion are complete or assigned to a follow-on fleet availability. Under no circumstances are DSS HIP due dates to be exceeded. ISIC Quality Assurance Officers will not be responsible for auditing DSS HIPs assigned to the depot in the AWP.
- p. Following availability completion, the ISIC DSS HIP coordinator will ensure that all DSS HIPs assigned to the industrial activity were reported and subsequently updated by SUBMEPP. ISICs will only upline the closed Job Control Numbers for DSS HIPs completed by Forces Afloat.

38.3.4 Deep Submergence System Commanding Officer.

- a. Ensure all DSS HIPs are accomplished within the required periodicity as specified by SUBMEPP.
- b. Maintain auditable records of the accomplishment of DSS HIPs to permit verification of compliance with reference (a), Volume V, Part I, Chapter 10 and Part III, Chapter 10 of this manual and this chapter. These records shall consist of:
 - (1) Copies of letter of completion for all DSS HIP work accomplishment by other activities.
 - (2) Copies of letters of completion and inspection reports for work accomplished by Ship's Force. The required report forms are located at the end of the individual DSS HIPs. A copy of each completed report shall be submitted to the ISIC for review a minimum of 24 hours prior to manned operations.
 - (3) One copy each of the current Quarterly DSS HIP inventories and schedules as printed from the CD provided by SUBMEPP. Annotate the DSS HIP Inventory Report when accepting completed work requests from the FMA or Ship's Force (LWC 991). It is the DSS responsibility for ensuring that the reports reflect the actual configuration, especially with regards to the equipment identity and the Allowance Parts List.

- (4) Copy of outstanding DSS HIP AWRs to be accomplished by Ship's Force.
- (5) One copy of each approved DFS from the requirements of reference (a), Volume V, Part I, Chapter 8 and Part III, Chapter 8 of this manual and this chapter. This authority is based on the following factors and considerations:
 - (a) The completion of all DSS HIPs, or portions thereof, will be reported on AWRs provided by the ISIC in accordance with paragraph 38.2.5.3 of this chapter. Particular care must be exercised to ensure that existing conditions found at the time of inspection and/or need for repair or replacement of components is recorded in detail as prescribed by the DSS HIP.
 - (b) Deviations from DSS HIP requirements or periodicities may result in operational restrictions being placed on a unit. In order to determine whether such restrictions are necessary, the TYCOM must be fully apprised of the number and extent of deviations involved.
 - (c) Allow no deviations in the scheduling or accomplishment of required DSS HIP maintenance actions unless formal NAVSEA approval of such deviations has been granted by an approved DFS or as allowed in paragraph 38.2.4 of this chapter. All system disassembles, repairs, and reassemblies must be conducted in accordance with Volume V of this manual, including requests for a DFS, if necessary.
 - (d) Except in an emergency, refrain from manned operations if all required DSS HIP maintenance actions have not been completed within the specified periodicities unless formal authorization to deviate from these requirements has been granted by NAVSEA. NAVSEA recommendation and TYCOM authority to conduct manned operations are contingent upon the satisfactory completion of these maintenance actions.

(This Page Intentionally Left Blank)

APPENDIX A
SUBMEPP DSS HIP INVENTORY

FOR OFFICIAL USE ONLY

PERIODIC MAINTENANCE REQUIREMENTS
 INVENTORY URO/HIP SORTED BY URO/HIP

REPORT DATE: 01 Nov 2005

HIP CHANGE: 39 Sep 2005

DRY DECK SHELTER 03P DDS 03P

SDVT-2

SHIP'S UIC: 59603

COMPID	LINE ITEM	COMP SERIAL	MJC NO MJFCN	PROC TYPE	MID NO	MRN	R		LAST WRK CTR JSN URO ITEM	M		DUE DATE	PER	ALT	REMARKS/COMPLETION INFO	
							M	D		C	LMA DATE				DATE	DATE
<u>SYSTEM: 1310 PRESSURE HULL</u>																
ITEM-01 596003AP01			PENDING	HIP	001					X	Dec 2002	Dec 2009	84M			1310 270137 L901
	XCONFIGITEM							D								
ITEM-02 596003AP02			PENDING	HIP	001					X	Dec 2002	Dec 2009	84M			1310 270137 L901
	XCONFIGITEM							D								
ITEM-03 596003AP03			PENDING	HIP	001					X	Dec 2002	Dec 2009	84M			1310 270137 L901
	XCONFIGITEM							D								
ITEM-04 596003AP04			PENDING	HIP	001					X	Dec 2002	Dec 2009	84M			1310 270137 L901
	XCONFIGITEM							D								
ITEM-05 596003AP05			PENDING	HIP	001					X	Dec 2002	Dec 2009	84M			1310 270137 L901
	XCONFIGITEM							D								
ITEM-06 596003AP06			PENDING	HIP	001					X	Dec 2002	Dec 2009	84M			1310 270137 L901
	XCONFIGITEM							D								
ITEM-07 596003AP07			PENDING	HIP	001					X	Dec 2002	Dec 2009	84M			1310 270137 L901
	XCONFIGITEM							D								
ITEM-08 596003AP08			PENDING	HIP	001					X	Dec 2002	Dec 2009	84M			1310 270137 L901
	XCONFIGITEM							D								
ITEM-09 596003AP09			PENDING	HIP	001					X	Dec 2002	Dec 2009	84M			1310 270137 L901
	XCONFIGITEM							D								
ITEM-10 596003AP10			PENDING	HIP	001					X	Dec 2002	Dec 2009	84M			1310 270137 L901
	XCONFIGITEM							D								
ITEM-11 596003AP11			PENDING	HIP	001					X	Dec 2002	Dec 2009	84M			1310 270137 L901
	XCONFIGITEM							D								

VI-38A-1

COMUSFLTFORCOMINST 4790.3 REV C

FOR OFFICIAL USE ONLY

URO/HIP INVENTORY BY URO/HIP PAGE: 1 DDS 03P

FOR OFFICIAL USE ONLY

PERIODIC MAINTENANCE REQUIREMENTS
INVENTORY URO/HIP SORTED BY URO/HIP

REPORT DATE 01 Nov 2005

HIP CHANGE: 39 Sep 2005

DRY DECK SHELTER 03P DDS 03P

SDVT-2

SHIP'S UIC: 59603

<u>COMPID</u>	<u>LINE</u> <u>ITEM</u>	<u>COMP</u> <u>SERIAL</u>	<u>MJC NO</u> <u>MJFCN</u>	<u>PROC</u> <u>TYPE</u>	<u>MID</u> <u>NO</u>	<u>MRN</u>	<u>R</u> <u>M D</u> <u>L D</u>	<u>LAST WRK</u> <u>CTR JSN</u> <u>URO ITEM</u>	<u>M</u> <u>C</u>	<u>LMA</u> <u>DATE</u>	<u>DUE</u> <u>DATE</u>	<u>PER</u>	<u>ALT</u>	<u>JSN</u>	<u>REMARKS/COMPLETION INFO</u> <u>DATE</u>
<u>SYSTEM: 1310 PRESSURE HULL (Cont'd)</u>															
ITEM-12			PENDING	HIP	001		D		X	Dec 2002	Dec 2009	84M			1310 270137 L901
596003AP12	XCONFIGITEM														
ITEM-13			PENDING	HIP	001		D		X	Dec 2002	Dec 2009	84M			1310 270137 L901
596003AP13	XCONFIGITEM														
ITEM-14			PENDING	HIP	001		D		X	Dec 2002	Dec 2009	84M			1310 270137 L901
596003AP14	XCONFIGITEM														
ITEM-15			PENDING	HIP	001		D		X	Dec 2002	Dec 2009	84M			1310 270137 L901
596003AP15	XCONFIGITEM														
ITEM-16			PENDING	HIP	001		D		X	Dec 2002	Dec 2009	84M			1310 270137 L901
596003AP16	XCONFIGITEM														
ITEM-17			PENDING	HIP	001		D		X	Dec 2002	Dec 2009	84M			1310 270137 L901
596003AP17	XCONFIGITEM														
ITEM-18			PENDING	HIP	001		D		X	Dec 2002	Dec 2009	84M			1310 270137 L901
596003AP18	XCONFIGITEM														
ITEM-19			PENDING	HIP	001		D		X	Dec 2002	Dec 2009	84M			1310 270137 L901
596003AP19	XCONFIGITEM														
ITEM-20			PENDING	HIP	001		D		X	Dec 2002	Dec 2009	84M			1310 270137 L901
596003AP20	XCONFIGITEM														
ITEM-21			PENDING	HIP	001		D		X	Dec 2002	Dec 2009	84M			1310 270137 L901
596003AP21	XCONFIGITEM														

FOR OFFICIAL USE ONLY

PERIODIC MAINTENANCE REQUIREMENTS
INVENTORY URO/HIP SORTED BY URO/HIP

REPORT DATE 01 Nov 2005

HIP CHANGE: 39 Sep 2005

DRY DECK SHELTER 03P DDS 03P

SDVT-2

SHIP'S UIC: 59603

COMPID	LINE ITEM	COMP SERIAL	MJC NO MJFCN	PROC TYPE	MID NO	MRN	R M D L D	LAST WRK CTR JSN URO ITEM	M C LMA C DATE	DUE DATE	PER	ALT	REMARKS/COMPLETION INFO JSN DATE
<u>SYSTEM: 1110 SUPERSTRUCTURE AND FAIRWATER</u>													
AFTSUPSTRUCT			PENDING	HIP	002		D		X Jan 2003	Jan 2007	48M		1110 270900 L902
596003AM02	XCONFIGITEM												
FWD MOUNT RG			PENDING	HIP	002		D		X Jan 2003	Jan 2007	48M		1110 270900 L902
596003AM04	XCONFIGITEM												
ATTSTUDS&WLD			PENDING	HIP	002		D		X Jan 2003	Jan 2007	48M		1110 270900 L902
596003AM06	XCONFIGITEM												
FRG MEM&WLD			PENDING	HIP	002		D		X Jan 2003	Jan 2007	48M		1110 270900 L902
596003AM10	XCONFIGITEM												
EXT FOUND			PENDING	HIP	002		D		X Jan 2003	Jan 2007	48M		1110 270900 L902
596003AM12	XCONFIGITEM												
<u>SYSTEM: 1310 PRESSURE HULL</u>													
HANGAR CYL			PENDING	HIP	002		D		X Jan 2003	Jan 2007	48M		1310 270163 L902
596003AG02	XCONFIGITEM												
ACC SPHERE			PENDING	HIP	002		D		X Jan 2003	Jan 2007	48M		1310 270163 L902
596003AG04	XCONFIGITEM												
ACC SPH SKRT			PENDING	HIP	002		D		X Jan 2003	Jan 2007	48M		1310 270163 L902
596003AG06	XCONFIGITEM												
HYPHER CHAMBR			PENDING	HIP	002		D		X Jan 2003	Jan 2007	48M		1310 270163 L902
596003AG08	XCONFIGITEM												
FR FLANGES			PENDING	HIP	002		D		X Jan 2003	Jan 2007	48M		1310 270163 L902
596003AJ02	XCONFIGITEM												

VI-38A-3

FOR OFFICIAL USE ONLY

URO/HIP INVENTORY BY URO/HIP PAGE: 3 DDS 03P

COMUSFLTFORCOMINST 4790.3 REV C

FOR OFFICIAL USE ONLY

PERIODIC MAINTENANCE REQUIREMENTS
INVENTORY URO/HIP SORTED BY URO/HIP

REPORT DATE: 01 Nov 2005

HIP CHANGE: 39 Sep 2005

DRY DECK SHELTER 03P DDS 03P

SDVT-2

SHIP'S UIC. 59603

COMPID	LINE ITEM	COMP SERIAL	MJC NO	PROC TYPE	MID NO	MRN	R M D L D	LAST WRK CTR JSN	M C LMA C DATE	DUE DATE	PER	ALT JSN	REMARKS/COMPLETION INFO DATE
HSC	RIC		MJFCN					URO ITEM					
<u>SYSTEM: 1310 PRESSURE HULL (Cont'd)</u>													
FR WEBS			PENDING	HIP	002		D		X Jan 2003	Jan 2007	48M		1310 270163 L902
596003AJ04	XCONFIGITEM												
ATT RNGS&WLD			PENDING	HIP	002		D		X Jan 2003	Jan 2007	48M		1310 270163 L902
596003AM08	XCONFIGITEM												
INS&PEN EXT			PENDING	HIP	002		D		X Jan 2003	Jan 2007	48M		1310 270163 L902
596003AM16	XCONFIGITEM												
INS&PEN INT			PENDING	HIP	002		D		X Jan 2003	Jan 2007	48M		1310 270163 L902
596003AS04	XCONFIGITEM												
<u>SYSTEM: 1700 WATERTIGHT HATCHES (PRESSURE HULL), TRUNKS AND ENCLOSURES</u>													
EXT HNG DOOR			PENDING	HIP	002		D		X Jan 2003	Jan 2007	48M		1700 270480 L902
596003BG08	312110266Y												
<u>SYSTEM: 1770 INTERNAL STRUCTURAL BULKHEADS</u>													
HYP CHMBR DR			PENDING	HIP	002		D		X Jan 2003	Jan 2007	48M		1770 270540 L902
596003BG04	312110258Y												
INR HNG DOOR			PENDING	HIP	002		D		X Jan 2003	Jan 2007	48M		1770 270540 L902
596003BG06	312110258Y												

VI-38A-4

FOR OFFICIAL USE ONLY

PERIODIC MAINTENANCE REQUIREMENTS
INVENTORY URO/HIP SORTED BY URO/HIP

REPORT DATE: 01 Nov 2005

HIP CHANGE: 39 Sep 2005

DRY DECK SHELTER 03P DDS 03P

SDVT-2

SHIP'S UIC: 59603

<u>COMPID</u>	<u>LINE ITEM</u>	<u>COMP SERIAL</u>	<u>MJC NO</u>	<u>PROC TYPE</u>	<u>MID NO</u>	<u>MRN</u>	<u>R M D</u> <u>L D</u>	<u>LAST WRK</u> <u>CTR JSN</u>	<u>M C</u> <u>C</u>	<u>LMA DATE</u>	<u>DUE DATE</u>	<u>PER</u>	<u>ALI</u>	<u>JSN</u>	<u>REMARKS/COMPLETION INFO</u> <u>DATE</u>
<u>HSC</u>	<u>RIC</u>		<u>MJFCN</u>					<u>URO ITEM</u>							
SYSTEM: 5081 FLOOD, VENT & DRAIN															
SHD-001			PENDING	HIP	003		I		X	Dec 2002	Dec 2009	84M/R		5081 444340 L903	
5960D3MU10	887306276Y														R=F16Accomplish whenever the valve is removed for other reasons.
SHF-001			PENDING	HIP	003		I		X	Dec 2002	Dec 2009	84M/R		5081 440015 L903	
596003MV10	887305590Y														R=F16Accomplish whenever the valve is removed for other reasons.
SHF-002			PENDING	HIP	003		I		X	Dec 2002	Dec 2009	84M/R		5081 440015 L903	
596003MV20	887306272Y														R=F16Accomplish whenever the valve is removed for other reasons.
SHA-029			PENDING	HIP	003		I			Dec 2002	Dec 2009	84M/R		5081 440015 L903	
596003PU29	887306275Y														R=F16Accomplish whenever the valve is removed for other reasons.

VI-38A-5

FOR OFFICIAL USE ONLY

URO/HIP INVENTORY BY URO/HIP PAGE: 5 DDS 03P

COMUSFLTFORCOMINST 4790.3 REV C

FOR OFFICIAL USE ONLY

PERIODIC MAINTENANCE REQUIREMENTS REPORT DATE: 01 Nov 2005
 INVENTORY URO/HIP SORTED BY URO/HIP

HIP CHANGE: 39 Sep 2005

DRY DECK SHELTER 03P DDS 03P

SDVT-2

SHIP'S UIC: 59603

<u>COMPID</u>	<u>LINE ITEM</u>	<u>COMP SERIAL</u>	<u>MJC NO MJFCN</u>	<u>PROC TYPE</u>	<u>MID NO</u>	<u>MRN</u>	<u>R M D L D</u>	<u>LAST WRK CTR JSN URO ITEM</u>	<u>M C C</u>	<u>LMA DATE</u>	<u>DUE DATE</u>	<u>PER</u>	<u>ALI</u>	<u>JSN</u>	<u>REMARKS/COMPLETION INFO DATE</u>
<u>SYSTEM: 0611 AUDITS AND CERTIFICATION</u>															
VITAL EQUIP			PENDING	HIP	004		0			May 2002	May 2006	48M/R			<u>.0611 603040 L904</u>
596003AD02	XCONFIGITEM														R=N97 Accomplish after each ROH, or after installation or other configuration change which adds equipment or significantly changes existing design.

FOR OFFICIAL USE ONLY

PERIODIC MAINTENANCE REQUIREMENTS
INVENTORY URO/HIP SORTED BY URO/HIP

01 Nov 2005

HIP CHANGE: 39 Sep 2005

DRY DECK SHELTER 03P DDS 03P

SDVT-2

SHIP'S UIC: 59603

<u>COMPID</u>	<u>LINE</u> <u>ITEM</u>	<u>COMP</u> <u>SERIAL</u>	<u>MJC NO</u> <u>MJFCN</u>	<u>PROC</u> <u>TYPE</u>	<u>MID</u> <u>NO</u>	<u>MRN</u>	<u>R</u> <u>M D</u> <u>L D</u>	<u>LAST WRK</u> <u>CTR JSN</u> <u>URO ITEM</u>	<u>M</u> <u>C</u>	<u>LMA</u> <u>DATE</u>	<u>DUE</u> <u>DATE</u>	<u>PER</u>	<u>ALI</u>	<u>JSN</u>	<u>REMARKS/COMPLETION INFO</u> <u>DATE</u>
<u>SYSTEM: 5081 FLOOD, VENT & DRAIN</u>															
SHF-001			PENDING	HIP	005		D		A	Dec 2002	Dec 2009	84M			5081 440015 L905
596003MV10	887305590Y														
SHF-002			PENDING	HIP	005		D		A	Dec 2002	Dec 2009	84M			5081 440015 L905
596003MV20	887306272Y														

VI-38A-7

FOR OFFICIAL USE ONLY

URO/HIP INVENTORY BY URO/HIP PAGE: 7 DDS 03P

COMUSFLTFORCOMINST 4790.3 REV C

(This Page Intentionally Left Blank)

**APPENDIX B
SUBMEPP DSS HIP SCHEDULE**

FOR OFFICIAL USE ONLY

PERIODIC MAINTENANCE REQUIREMENTS
SCHEDULED URO/HIP

REPORT DATE: 01 Nov 2005
CUTOFF DATE: 01 Aug 2006

HIP CHANGE: 39 Sep 2005

DRY DECK SHELTER 03P DDS 03P

SDVT-2

SHIP'S UIC: 59603

<u>COMPID</u>	<u>LINE ITEM</u>	<u>COMP SERIAL</u>	<u>MJC NO</u>	<u>PROC TYPE</u>	<u>MID NO</u>	<u>MRN</u>	<u>R M D L D</u>	<u>LAST WRK CTR JSN</u>	<u>M C LMA C DATE</u>	<u>DUE DATE</u>	<u>PER</u>	<u>ALT</u>	<u>JSN</u>	<u>REMARKS/COMPLETION INFO DATE</u>
<u>SYSTEM: 0611 AUDITS AND CERTIFICATION</u>														
VITAL EQUIP			PENDING	HIP	004		0		May 2002	May 2006	48M/R		0611 803040 L904	
596003AD02	XCONFIGITEM													R=N97 Accomplish after each ROH, or after installation or other configuration change which adds equipment or significantly changes existing design.

FOR OFFICIAL USE ONLY

URO/HIP SCHEDULE PAGE: 1 DDS 03P

VI-38B-1

COMUSFLTFORCOMINST 4790.3 REV C

(This Page Intentionally Left Blank)

APPENDIX C

REQUEST FOR DSS HIP PERIODICITY EXTENSION FORMAT

4790

Ser

From: Commander, DSS Squadron ____
 To: Commanding Officer, Submarine Maintenance Engineering, Planning and Procurement (SUBMEPP)
 Activity
 Via: COMNAVSPECWARCOM
 Subj: REQUEST FOR EXTENSION OF PERIODICITY FOR DSS HIP (S)_____ON
 DSS Vehicle/Shelter and Hull No.)

Ref: (a) Applicable DSS HIP
 (b) COMUSFLTFORCOMINST 4790.3; Joint Fleet Maintenance Manual, Volume VI, Chapter 38
 (c) COMNAVSPECWARCOM ltr 4790 Ser ___of (previous letter granting extension of periodicity)

1. In accordance with references (a) and (b), request extension of DSS HIP periodicity for Deep Submergence System (Vehicle/Shelter and Hull No.) as follows:

DSS HIP	Equipment Guide List Item Number or Component Ident	LMA Date	Current Due Date	Inactive Time		Extension Required	Required Next Due Date
					Inactive Days		
001	All	June 82	Apr 91		100 days	7 months	Nov 91
002	All	June 82	Aug 91		100 days	3 months	Nov 91
003	All	June 82	Aug 91		100 days	3 months	Nov 91
004	All	June 84	Apr 91		100 days	7 months	Nov 91
005	VB-10	June 84	Apr 91		100 days	7 months	Nov 91

2. Inactive time identified for the DSS HIPs listed in paragraph 1 above is the actual allowable time accrued to date since DSS HIP was last accomplished/previous extension of periodicity was granted by reference (c).

Copy to:
 COMNAVSEASYS COM (PMS 399)
 Commanding Officer, _____

(This Page Intentionally Left Blank)

VOLUME VI
CHAPTER 39
MAINTENANCE AND MODERNIZATION PERFORMANCE REVIEW
AND LESSONS LEARNED CONFERENCE
FOR SURFACE FORCE SHIPS

LISTING OF APPENDICES.

A Access to Lessons Learned Conference and MMPR Sites on the ST1 Portal

39.1 PURPOSE.

- a. The Maintenance and Modernization Performance Review (MMPR) is a semi-annual forum for maintenance and modernization professionals to share, identify issues and focus on continuous process improvement opportunities within the Surface Maintenance and Modernization Community. The MMPR provides a path for communication between the individual Project/Ship Lessons Learned Conferences (LLC) and the top-level maintenance and modernization leadership.
- b. The primary purpose of the LLC is to facilitate communication between Project Teams of all Surface Force ship classes across all Regional Maintenance Centers (RMC) and supporting activities at various stages in their availability to assist in improving cost, schedule and performance. The LLCs provide a singled-up approach to evaluate and capture critical lessons learned and barriers brought forward by Project Teams to facilitate process improvements in the Surface Navy.
- c. The LLC process encompasses the established milestones and/or meetings within the planning and execution of availabilities in accordance with Volume II, Part II, Chapter 2 of this manual. Appendix D of Volume II, Part II, Chapter 2 of this manual includes a detailed table of milestones. Meetings that already exist to reinforce process improvements may include the Advance Planning Meeting, Work Package Integration Conference, Work Package Execution Review, Arrival Conference, 50% Conference and Completion Conference. While these events occur at various times, the feedback process exists to continually collect information to improve processes.

39.2 MAINTENANCE AND MODERNIZATION PERFORMANCE REVIEW OVERVIEW.

39.2.1 MMPR Objective. The MMPR topics will be relevant to process improvements for future availabilities and may include ship class or port specific process issues, best practices, success stories, industry feedback, technical issues, Surface Team One (ST1) initiatives and new developments and Fiscal Year Availabilities.

39.2.2 MMPR Key Membership.

- a. Commander, Naval Surface Forces Atlantic N43 is the Process Master and responsible for managing and coordinating the MMPR.
- b. Nearly all commands linked to the Surface Ship Maintenance and Modernization Community participate in the MMPR. These commands include Commander, Navy Regional Maintenance Center, RMCs, Naval Sea Systems Command (NAVSEA) 21, Type Commanders (TYCOM), Surface Maintenance Engineering Planning Program (SURFMEPP), Planning Yards, Private Sector Industrial Activity Contracting Partners, Ship's Force (Commanding Officers through Department Heads), Fleet, SEA04, SEA05, Space and Naval Warfare Systems Command, Program Executive Officer Integrated Work Schedule and Office of the Chief of Naval Operations N43. At a minimum, the following organizations will be invited to attend all MMPRs:
 - (1) Commander, Navy Regional Maintenance Center.
 - (2) RMCs Southeast Regional Maintenance Center (SERMC), Southwest Regional Maintenance Center (SWRMC), Puget Sound Naval Shipyard and Intermediate Maintenance Facility (PSNS & IMF), Northwest Regional Maintenance Center (NWRMC), Pearl Harbor Naval Shipyard

and Intermediate Maintenance Facility (PHNSY & IMF), Hawaii Regional Maintenance Center (HRMC), Mid-Atlantic Regional Maintenance Center (MARMC), Forward Deployed Regional Maintenance Center (FDRMC), Ship Repair Facility (SRF)-Japan).

- (3) Commander, Naval Surface Forces Atlantic.
 - (4) Commander, Naval Surface Forces Pacific.
 - (5) NAVSEA21.
 - (6) SURFMEPP.
 - (7) Ship's Force.
 - (8) United States Fleet Forces Command.
 - (9) Commander, U.S. Pacific Fleet.
 - (10) Industry Partners.
 - (11) Space and Naval Warfare Systems Command.
 - (12) Naval Surface Warfare Center (Philadelphia, Port Hueneme, Corona).
 - (13) NAVSEA04.
 - (14) NAVSEA05.
 - (15) Program Executive Officer Integrated Work Schedule.
- c. MMPR Planning Team. The MMPR Planning Team will be chaired by the ST1 Executive Steering Committee (ESC). MMPR planning meetings will be conducted on a monthly basis preceding a scheduled MMPR. The objective of these meetings is to develop the agenda and ensure any information from ST1 priority topics is included.

39.2.3 MMPR Action Items. All action items resulting from an MMPR meeting will be tracked by ST1 and documented and tracked on the ST1 Portal with Lessons Learned Conference Action Items and/or barriers. Documents from the MMPR will be posted to the MMPR site under the ST1 Portal. Instructions on gaining access to the ST1 Portal are located in Appendix A.

39.2.4 Further Guidance. Further guidance regarding the MMPR process is outlined in the MMPR Business Rules.

39.3 LESSONS LEARNED CONFERENCE OVERVIEW.

39.3.1 Lessons Learned Conference Concept. The LLC is not a program review, an evaluation of the Maintenance Team (government or contractor) or a forum to acknowledge heroism or place blame. It is a process review, an evaluation of the execution of the availability from the advance planning to the completion of the availability. It is also a place to identify process issues that can further improve overall end to end maintenance and modernization process.

39.3.2 Lessons Learned Conference Objective. The objective of the LLC is to increase in-depth cross-Project Team discussions of common issues and to include risk mitigation strategies and best practices. Feedback will be shared locally and globally in the surface force ship community and will ultimately be embedded into the maintenance and modernization processes.

39.3.3 Lessons Learned Conference Key Membership.

- a. Process Owner. Commander, Naval Surface Forces Atlantic N43 and Commander, Naval Surface Forces Pacific N43 are the overall LLC process owners. As such, Commander, Naval Surface Forces Atlantic N43 and Commander, Naval Surface Forces Pacific N43 are responsible for the general management of implementing the LLC process to ensure process effectiveness. While the TYCOMs are the LLC Process Owners, the LLCs are part of the ST1 structure as a "Knowledge Sharing Network". Each Knowledge Sharing Network under ST1 is assigned a Process Master; the LLC Process Master will be identified by the Process Owners.

- b. RMC LLC Analysis Team. Each RMC must have a designated LLC Analysis Team Coordinator and a designated LLC Analysis Team Waterfront Operations Representative on the Analysis Team. Some RMCs may choose to have the Coordinator and Waterfront Operations Representative to be one and the same due to the time requirements demanded of an Analysis Team Member.
- (1) The LLC Analysis Team Coordinator is responsible for the coordination and facilitation of their local RMC's scheduled LLCs. This person serves as the liaison between the Project Teams and the global LLC Community. Further guidance regarding the RMC LLC Coordinator's responsibilities are outlined in the LLC Analysis Team Business Rules.
 - (2) The LLC Analysis Team RMC Waterfront Operations Representative is responsible for providing the Waterfront expertise and knowledge for their local RMC to the Analysis Team. This person serves as the liaison between his or her RMC's waterfront and the global LLC Community. Further guidance for the roles and responsibilities of the local RMC LLC Analysis Team Member in completing the LLC Waterfront Perspectives Questionnaire is contained in the LLC Analysis Team Business Rules.

NOTE: WHILE THE LLC ANALYSIS TEAM MEMBER POSSESSES MANY RESPONSIBILITIES AS THE LLC MEETING FACILITATOR, HE OR SHE SHOULD EXPECT TO RECEIVE ASSISTANCE FROM ALL STAKEHOLDERS.

- c. RMC Availability Project Manager (PM). The RMC PM is responsible for preparing and briefing their ship's Chief of Naval Operations Availability based on the Waterfront Perspectives Questionnaire they provided answers/comments on. The RMC PM will capture all lessons learned, action items and barriers deemed necessary to be communicated to the Surface Maintenance and Modernization Community.
- d. Maintenance Community. Other maintenance activities involved with ship availabilities (in addition to those highlighted in preceding paragraphs) will participate in the LLC. These representatives are active members of the LLC Community and are responsible for maintaining awareness of availability issues and participating in the topic specific LLCs. The following participants are mandatory:
- (1) TYCOM N43 Type Desk Office.
 - (2) TYCOM Project Engineer.
 - (3) Immediate Superior In Command.
 - (4) Ship's Force Representative.
 - (5) Private Sector Industrial Activity/Firm Fixed Price Contractor.
 - (6) SURFMEPP Detachment Representative.
- e. Modernization Community. Representatives of any Alteration Installation Team or other non-repair activity involved with availabilities will participate in the availability LLC meetings as appropriate:
- (1) NAVSEA 21.
 - (2) Field Activities.
 - (3) Space and Naval Warfare Systems Command.
 - (4) Program Manager Representative.
 - (5) Planning Yard Representative.

39.4 PREPARING FOR THE LESSONS LEARNED CONFERENCE.

39.4.1 Preparation. To adequately prepare for an LLC, Project Teams should review any lessons learned and barriers that they feel will be beneficial to other Project Teams throughout their Planning and Execution phases regarding the topic of the LLC. All Project Teams will be first introduced to the LLC Process during their first scheduled Integrated Project Team Development Event in accordance with the milestones listed in Volume II, Part II, Chapter 2, Appendix D of this manual by their local RMC LLC Analysis Team Coordinator/Waterfront Operations Representative.

39.4.2 Lessons Learned Conference Presentation Overview. The LLC Availability Overview Presentation serves as the format for the Project Teams to articulate key lessons learned and barriers encountered during their Availability Cycle. The LLC Waterfront Perspective Questionnaire template is available through the RMC Analysis Team Member, however it will be tailored to each LLC Topic. Throughout the planning stages and execution of the availability, Maintenance Team members, including the RMC, Ship's Force, contractor, Alteration Installation Teams and other key availability stakeholders shall assist the RMC PM in submission of the LLC presentation. Input should also be gathered from:

- a. Ship's Commanding Officer's Weekly Situation Reports.
- b. Standard metrics identifying top cost drivers.
- c. Late add alteration risk assessment messages (including comparison of expected versus actual impact to the availability).
- d. Late add alteration risk acceptance.
- e. Waivers for work added after the late add impact assessment as dictated by the milestones listed in Volume II, Part II, Chapter 2, Appendix D of this manual (including impact to availability).
- f. Cost variance forms provided by contractor.
- g. A review of contract changes to the base work package.

39.5 CONDUCTING A LESSONS LEARNED CONFERENCE.

39.5.1 Lessons Learned Conference Schedule. LLCs are scheduled as topics are identified for inclusion in the LLC process. Required LLC Project Teams are determined based on their applicability to the selected topic.

39.5.2 Agenda. The primary focus of the meeting is to discuss lessons learned, best practices and barriers pertaining to the specific topic. An agenda for all scheduled LLCs will be forwarded to all participants by the ST1 LLC Process Master, RMC LLC Analysis Team Coordinator. The agenda will also be available on the LLC site on the ST1 Portal: <https://usff.portal.navy.mil/sites/surflant/st1/default.aspx>.

39.5.3 Lessons Learned Conference Focus Areas. Surface Force Ships are required to participate in LLCs to promote synergy toward the identification and resolution of common availability issues. Topics of a LLC can be identified by any member of the Surface Ship Maintenance and Modernization Team. The topic specific LLC will bring together people from around the enterprise to share lessons learned on issues that are affecting the ability of project teams to complete availabilities on time or are constant drivers of growth and new work.

39.5.4 Invitees. Key membership and project team personnel involved with the availability, including the TYCOM, will be notified of the LLC meeting by the ST1 LLC Process Master, the RMC LLC Analysis Team Coordinator or the Class Team Leader. Key stakeholders involved with future availabilities will also be invited to attend the meeting.

39.5.5 Invites and Announcement. The RMC LLC Analysis Team Coordinator will review the scheduled LLCs on no less than a monthly basis. The schedule will include an agenda of upcoming LLCs based on topic relevance. The RMC Analysis Team Coordinators will recommend and designate the specific ship Project Teams to present at upcoming LLCs.

39.5.6 Lessons Learned Conference Documents. All LLC documentation will be in accordance with the LLC Analysis Team Communications Plan. Requirements for documents will also be discussed during the weekly LLC Telecoms.

39.5.7 Lessons Learned Conference Minutes. All participants, action items and barriers will be documented in minutes (Kmails), following each LLC. The Kmails will be forwarded no later than five business days to all invitees, ST1 ESC and RMC Commanders. The minutes will also be posted on the LLC site on the ST1 Portal.

39.5.8 Lessons Learned Conference Website. LLC process meeting documents and information shall be posted on the LLC site on the ST1 Portal. This site tracks all scheduled LLCs throughout the calendar year, all meeting preparation materials to include necessary read-ahead material for participants, Project Team Point of Contact Lists and approved Kmails. The site should be used to aid in planning work packages and preparing for availabilities to ensure that any barriers and lessons learned identified by previous LLC Project Teams are applied to future availabilities. The site is located at <https://usff.portal.navy.mil/sites/surflant/st1/default/asp>. See Appendix A for instructions on obtaining access.

39.6 INTERACTION AMONG FEEDBACK PROCESSES.

39.6.1 Relationships. The LLC meeting is sensitive to the contractor-government relationship and the legal procedures that accompany it. The Department of the Navy Acquisition Reform strategy includes a goal to “build a continuous dialogue with industry to identify mutually beneficial opportunities and practices”. While the Department of the Navy encourages open communication between the contractor and the government, many legal issues arise from such information sharing. It is critical that the LLC meetings and general processes maintain awareness of the following legal procedures: Federal Advisory Committee Act, Procurement Integrity Act, Trade Secrets Act and Organizational Conflicts of Interest. Additionally, the LLC process is mindful of other feedback/review processes, such as the Award Fee Board and Contractor Performance Assessment Report.

39.6.2 Consistency. These business rules recognize the need for consistency between other feedback processes and the need for all to exist. As the LLCs will most likely occur prior to the Award Fee Board and the Contractor Performance Assessment Reports issuance, sensitive issues may arise. The LLCs intend to remain focused on process improvement, lessons learned and barrier identification. The LLC will allow for sensitive issues to remain in closed sessions or within the scope of their existing feedback and review processes.

39.7 LESSONS LEARNED CONFERENCE APPLICATION AND KNOWLEDGE SHARING.

39.7.1 Communication of Lessons Learned, Barriers and Action Items. Lessons Learned, Barriers and Action Items and their associated resolutions are only useful when they are communicated between maintenance and modernization professionals. The following are the required methods for sharing information in a timely manner, but are not the only means to share this information:

- a. Maintenance and Modernization Performance Review. Status of LLC Action Items and Barriers will be provided during each Maintenance and Modernization Performance Review.
- b. Surface Team One Executive Steering Committee Meetings. When requested, the LLC Process Master will brief the ST1 ESC. As a minimum, each ESC meeting will include a status brief of all open action items and barriers. When barriers are briefed to the ESC, the barrier will be assigned to the correct point of contact for action and closure.
- c. Surface Team One Monthly Process Master Meetings. Monthly meetings will be conducted with each Knowledge Sharing Network Process Master and designated support personal. These meetings will serve as a venue to provide a critical review of assigned action items from each LLC.

(This Page Intentionally Left Blank)

APPENDIX A

ACCESS TO LESSONS LEARNED CONFERENCE AND MMPR SITES ON THE ST1 PORTAL

In order for users to be granted access, they must have a .mil or .gov address and have a CAC.

1. Go to: <https://inavy.accessrequest.portal.navy.mil> **Error! Hyperlink reference not valid.**
2. Fill in the information requested and submit.
3. Your command approvers will create the account, usually within 48 hours.
4. If you already have an account for a different site within iNavy, you will see the User Registration Dashboard that will indicate your status.

iNAVY strength of collaboration

USER REGISTRATION | DASHBOARD

WELCOME
iNAVY is the Navy-wide portal for all Commands to collaborate and manage their information and data.

Your Name

There is no record of registration for you in our system. Continued access to iNavy requires user registration. To start, provide your work information then click the next button.

Association: CTR - Contractor Business Phone: United States of America 443

UIC: N Activity/Command:

NEXT

Search:

(This Page Intentionally Left Blank)

VOLUME VI
CHAPTER 40
SUBMARINE MESSAGE REPORTING

REFERENCES.

- (a) SECNAVINST 5510.36 - Department of the Navy Information Security Program Regulation, Chapter 6
- (b) NAVSEAINST 4720.14 - Temporary Alterations to Active Fleet Submarines, Control of
- (c) NAVSEA SL720-AA-MAN-030 - Navy Modernization Process Management and Operations Manual (NMP-MOM)

LISTING OF APPENDICES.

- A Sample (SUBS) Initial Message
- B Sample (SUBS) Update Message
- C Sample (SUBS) Final/Closeout Message
- D Sample (SUBS) Shipalt/Tempalt Installation Message
- E Sample (SUBS) Shipalt/Tempalt Removal Message

40.1 PURPOSE. This chapter provides policy and guidance regarding the utilization of (SUBS) messages. Reactor Plant and Strategic Weapons Systems material issues are not governed by this document and shall not to be reported via (SUBS) message format. (SUBS) message requirements for New Construction, Chief of Naval Operations, (CNO) and Type Commander (TYCOM) depot availabilities are addressed in Volume II, Part I, Chapters 3 and 4 of this manual and will not be addressed in this chapter. This chapter supercedes all other policy, procedures or guidance previously promulgated regarding (SUBS) messages.

40.2 BACKGROUND. Submarine material and equipment problems or requests for technical assistance reported via message have experienced delays receiving the required resolutions for identified problems. Delays were associated with insufficient data and or improper message addressing.

40.3 SCOPE. To establish protocol for the reporting of submarine equipment, systems and material issues that affect ship's mission or ship/personnel safety. To establish a reporting procedure that will ensure all necessary commands and technical authorities are contacted without delay. To ensure the correct action is identified and provided to the ship using the most rapid means.

40.4 POLICY.

- a. The parenthetical code word (SUBS) shall appear as the first word in the subject line before the subject description.
- b. (SUBS) messages shall identify its status by using the words INITIAL, UPDATE or FINAL at the end of the subject line.
- c. The (SUBS) message shall not be used as a substitute for any Casualty Report, Situation Report or Incident Report that may be required by higher authority. A (SUBS) message shall be sent to provide further supplemental information needed to explain the problem, provide troubleshooting support and identify its effect on the ship.
- d. (SUBS) messages are intended for material and technical assistance request issues pertaining to ship's mission or personnel safety and should not be used to report routine administrative items such as visit requests, post tech assist visit reports or any other event not requiring the urgency of a (SUBS) message.
- e. (SUBS) messages originated by submarines will be updated by the submarine at a periodicity not greater than once every 30 days. UPDATES should include equipment status, repair efforts in progress and if known anticipated repair date.
- f. To identify (SUBS) message priority use the following precedence:
 - (1) ROUTINE - REQUEST ANSWER WITHIN 5 WORKING DAYS.

- (2) PRIORITY - REQUEST ANSWER WITHIN 3 WORKING DAYS.
- (3) IMMEDIATE - REQUEST ANSWER WITHIN 24 HOURS.
- g. (SUBS) messages shall be used to identify the installation and removal of Temporary Alterations (TEMPALT) and Ship Alterations (SHIPALT). However the 30-day UPDATE requirement and precedence identification is waived for these instances.
- h. (SUBS) messages identifying the installation or removal of a TEMPALT or SHIPALT will identify such message by placing the words (TEMPALT) or (SHIPALT) at the end of the subject line.
- i. (SUBS) messages are to be classified appropriately in accordance with reference (a).
- j. (SUBS) messages shall be addressed to the controlling Immediate Superior In Command (ISIC) for action and INFO Naval Sea Systems Command (NAVSEA), NAVSEA 08, TYCOMs and Technical Authority as appropriate ensuring parent commands are included as addressees. INFO NAVSURFWARCENDIV PHILADELPHIA PA for all submarine diesel problems. **SSBNs and SSGNs will INFO Director, Strategic Systems Programs (DIRSSP).**
- k. A FINAL close out (SUBS) message shall be sent upon correction of the reported material problem or if in the Commanding Officer's judgement a technical resolution has been reached or no additional response is required from Technical Authorities, NAVSEA, TYCOM or ISIC.
- l. NAVSEA shall review all (SUBS) messages and provide responses to the ISIC within the precedence time line as identified in paragraph 40.4 f. of this chapter.
- m. (SUBS) messages initiated by NAVSEA requesting information from one or more Commands shall be tracked by NAVSEA.
- n. (SUBS) messages being initiated for the purpose of gathering technical information from submarines shall be provided to the TYCOM for action.
- o. Technical Authorities shall provide all (SUBS) message responses to NAVSEA, TYCOM and ISIC for review and action. **For messages addressed to SSBNs or SSGNs, INFO DIRSSP.**
- p. (SUBS) messages shall not be initiated by a Technical Authority unless authorized by NAVSEA, TYCOM or ISIC.

40.5 RESPONSIBILITIES.

40.5.1 Type Commanders.

- a. Review (SUBS) message traffic and when necessary readdress or forward to ensure the proper Technical Authority was identified and aware of the message.
- b. Assist and support the ISIC as required to generate (SUBS) messages.
- c. (SUBS) messages initiated by the TYCOM, requesting information from one or more Commands are to be tracked by the TYCOM department generating the message.
- d. Track all (SUBS) messages generated by submarines under its cognizance.

40.5.2 Immediate Superior In Command.

- a. Review and take for action all (SUBS) messages coordinating with NAVSEA, TYCOM and the Technical Authority to generate and provide message responses as required and within the precedence time line as identified in paragraph 40.4 f. of this chapter.
- b. (SUBS) messages sent to or initiated by a submarine under its cognizance shall be tracked by the ISIC.
- c. (SUBS) messages initiated by the ISIC requesting information from one or more commands shall be tracked by the ISIC.

40.5.3 Ship's Commanding Officer.

- a. (SUBS) messages initiated by the ship shall be tracked by the ship until closeout.

- b. Responses to technical assistance (SUBS) messages shall be answered as soon as the troubleshooting efforts have results. If requested troubleshooting efforts are not accomplished due to ship's operations or lack of test equipment, generate a (SUBS) message containing efforts taken, results, effect on ship and any further assistance needed.
- c. When requesting onboard technical assistance, Chapter 2 of this volume, Fleet Technical Assistance, shall be used as guidance.
- d. Issue a (SUBS) message to identify the installation and removal of TEMPALTs and SHIPALTs.

40.6 MESSAGE REQUIREMENTS.

- a. All (SUBS) messages requesting technical assistance will contain, as a minimum, the following requirements:
 - (1) EXECUTIVE SUMMARY - faulted equipment, when the fault occurred, functions lost and equipment effected.
 - (2) BACKGROUND (if any) - previous related equipment problems, when experienced, corrective action taken, last completed system certification.
 - (3) DESCRIPTION OF THE PROBLEM - affected equipment, type of fault, fault indications, system indications.
 - (4) TROUBLESHOOTING EFFORTS - procedures used, documentation held onboard, Ship's Force training and experience with the equipment, troubleshooting limitations, special equipment held, any possible fault identified during Ship's Force troubleshooting.
 - (5) ASSISTANCE DESIRED - repair parts needed, distance support or onboard technical assistance needed, if known identify the technical authority and the next available ship operation where a technician could board the ship. Identify the problem as corrected, no further assistance required and justify it as a FINAL REPORT with no additional action required. When answering an information request (SUBS) message a closeout message is not required and should be identified as such in Paragraph 5 of the message. (i.e., no additional action required by this message)
 - (6) COMMANDING OFFICER'S ASSESSMENT - level of impact assessment of ship's capabilities to complete operational commitments, any additional backup or redundant systems and its operational status.
 - (7) REQUIRED RESPONSE DATE - Specify the calendar date response is due by to support ship operations.
- b. All (SUBS) messages reporting TEMPALT and SHIPALT completion will contain, in accordance with references (b) and (c), the following requirements:
 - (1) ACTIVITIES: Unit and installing activity identified.
 - (2) BACKGROUND: TEMPALT number, TEMPALT name, installation period dates, installation completion date, Ship's Force operational testing completion acceptance date.
 - (3) PROVIDED INFORMATION:
 - (a) Type of installation: New equipment, Upgrade, Design change, etc.
 - (b) TEMPALT number: XXXX K/D.
 - (c) Certifying Statement: "all work was accomplished in full compliance with applicable contractual standards, specifications and installation drawings as outlined in reference ()". System Operation Verification Testing (SOVT) was completed on XX NOV XXXX, results were provided to Ship's Force.

- (d) TEMPALT installation issues resolved: Ship's Installation Drawings require revision. All Liaison Action Requests submitted to the planning yard were resolved. Ship's Force has been provided copies of all Liaison Action Requests and red line drawings. Red line drawing forwarded to planning yard.
 - (e) TEMPALT Completion Report completed and forwarded XX Dec XXXX, results provided to Ship's Force.
 - (f) Equipment installed: example AN-BLQ-10 ES SYSTEM.
 - (g) Integrated Logistics Support provided: Tech manuals, Maintenance Requirement Cards library data, On Board Repair Parts.
 - (h) Training Provided: identify by name all personnel trained.
 - (i) Summary: installation schedule issues, delays, support required, etc.
 - (j) Anticipated TEMPALT removal date.
- (4) POC: Point of Contact (POC) at installing activity.
- (5) COMMANDING OFFICER COMMENTS: Describe any issues of concern, provide positive and negative comments and identify any other pertinent information.
- c. All (SUBS) messages reporting TEMPALT removal will contain, in accordance with reference (b), the following requirements:
- (1) ACTIVITIES: Ship's name and Hull number.
 - (2) BACKGROUND: TEMPALT Number and Title.
 - (3) PROVIDED INFORMATION:
 - (a) Date of removal.
 - (b) Certifying statement the ship was restored to original configuration.
 - (c) Removal Issues; any outstanding item preventing restoration.
 - (4) POC: Removal Activity POC.
- d. To ensure the appropriate Technical Agencies are informed of the material problems or request for technical assistance the addressee guidance provided for Casualty Reporting located at <https://mfom.nola.navy.smil.mil/mfom> (SIPR access required) should be used for (SUBS) messages.
- e. Appendices A through E provide samples of the message format to be used for (SUBS) messages.

APPENDIX A

SAMPLE (SUBS) INITIAL MESSAGE

OATUZYUW RUCORGP0054 2282105-UUUU--RUCBKMC.

ZNR UUUUU ZUI RUCOMCB4998 2290310

O 1730XXZ AUG XX

FM USS XXXXXXXXXXX

TO COMSUBRON XXXXX//

INFO COMSUBLANT NORFOLK VA//

COMNAVSEASYS COM WASHINGTON DC//

COMSUBGRU XXX//

NAVSHIPYD NORFOLK VA//

XXXXX RMC XXXXX XX

SUBMEPP PORTSMOUTH NH

DIRSSP WASHINGTON DC// (FOR SSBN/SSGN)

BT

UNCLAS

MSGID/GENADMIN/XXXXXXXXXX/0054/AUG//

SUBJ/(SUBS) EPM CIRCUIT BREAKER OVERCURRENT TRIPS **INITIAL**//

REF/A/DOC/NAVSEA/14MAR1995//

AMPN/REF A IS NAVSEA 0942-LP-005-2020/(C) MAIN PROPULSION GEARS WITH CH-1//

POC/XXXXX./ENGINEER/USS XXXXXXXXXXX/LOC:AT SEA

/EMAIL:ENG(AT) XXXXXXXXXXX.NAVY.SMIL.MIL//

RMKS/1. EXECUTIVE SUMMARY: EMERGENCY PROPULSION MOTOR (EPM) CIRCUIT BREAKER AT EPM CONTROL PANEL (EPMCP) TRIPS ON OVERCURRENT WHEN TAKING THE EPM ABOVE 18 SHAFT RPM IN THE AHEAD DIRECTION. CONTROL OF EPM MOTOR ARMATURE CURRENT BETWEEN SPEEDS OF 13 AND 18 SRPM IS SENSITIVE, WITH MOTOR ARMATURE CURRENT SPIKING AS MOTOR SPEED IS INCREMENTALLY RAISED. THE EPM REMAINS OPERATIONAL AT SPEEDS LESS THAN 15 SRPM AHEAD. OPERATION ASTERN IS NORMAL.

2. BACKGROUND: SHIP IS CURRENTLY CONDUCTING POST-SRA SEA TRIALS. SHIPALT 3461K (EPM HIGH TORQUE CLUTCH) WAS INSTALLED DURING SRA. EPM OPERATION WAS TESTED SATISFACTORILY PIERSIDE ON XXAUGXX TO A MAXIMUM SPEED OF 15 SRPM AHEAD AND ASTERN WITH NO ABNORMALITIES NOTED.

3. DESCRIPTION OF PROBLEM:

A. WHILE SLOWLY BRINGING THE EPM FROM 13 TO 18 SRPM AHEAD BY INCREMENTALLY TURNING THE HANDWHEEL (LESS THAN 1/64TH TURN) CLOCKWISE THE MOTOR ARMATURE CURRENT SPIKES TO APPROXIMATELY 800 TO 1100 AMPS DC THEN RETURNS TO NORMAL STEADY RUNNING CURRENT (APPROX 250 AMPS DC). THE MAGNITUDE OF THE SPIKE IS DIRECTLY PROPORTIONAL TO THE MOTOR SPEED/HANDWHEEL POSITION. MOTOR FIELD CURRENT BEHAVES NORMALLY, RUNNING FROM 7-9 AMPS DC.

B. AS SPEED IS RAISED ABOVE 18 SRPM, AN ARMATURE CURRENT SPIKE OF 1800 AMPS DC IS INDICATED AS THE EPM BREAKER TRIPS. THE MOST LIKELY CAUSE OF THE BREAKER TRIP IS OVERCURRENT (RATED INSTANTANEOUS TRIP POINT IS 2800 AMPS DC), BUT THE AMMETER RESPONSE IS TOO SLOW TO REGISTER FULL DEFLECTION.

4. TROUBLESHOOTING EFFORTS:

A. PERFORMED CLEAN AND INSPECT OF EPM CONTROL PANEL AND CONTROLLER PER EL-26 A-5 AND A-2 SATISFACTORILY.

B. TESTED OPERATION OF EPMCP PER EL-26 R-2M SATISFACTORILY.

C. INSPECTED EPM CIRCUIT BREAKER SATISFACTORILY.

5. ASSISTANCE DESIRED: REQUEST FURTHER TROUBLESHOOTING GUIDANCE VIA MESSAGE BY XXAUGXX.

6. CO ASSESSMENT AND REPAIR DESIRES: ORIG IS CONTINUING WITH POST-SRA SEA TRIALS, LIMITING EPM TO 15 SRPM AHEAD. ADDITIONAL TROUBLESHOOTING WILL BE PERFORMED UPON SURFACING.//

BT

#0054

NNNN

NOTE: ENSURE MESSAGES ARE IN ACCORDANCE WITH CURRENT MESSAGE FORMAT AND CURRENT PLAIN LANGUAGE ADDRESS DIRECTORY (PLAD) IS UTILIZED.

APPENDIX B

SAMPLE (SUBS) UPDATE MESSAGE

OATUZYUW RUCORGP0054 2282105-UUUU--RUCBKMC.

ZNR UUUUU ZUI RUCOMCB4998 2290310

O 1730XXZ AUG XX

FM USS XXXXXXXXXXX

TO COMSUBRON XXXXX//

INFO COMSUBLANT NORFOLK VA//

COMNAVSEASYS COM WASHINGTON DC//

COMSUBGRU XXX//

NAVSHIPYD NORFOLK VA//

XXXXX RMC XXXXX XX

SUBMEPP PORTSMOUTH NH

DIRSSP WASHINGTON DC// (FOR SSBN/SSGN)

BT

UNCLAS

MSGID/GENADMIN/XXXXXXXXXX/0054/AUG//

SUBJ/(SUBS) EPM CIRCUIT BREAKER OVERCURRENT TRIPS **UPDATE**//

REF/A/DOC/NAVSEA/14MAR1995//

AMPN/REF A IS NAVSEA 0942-LP-005-2020/(C) MAIN PROPULSION GEARS WITH CH-1.//

POC/XXXXX./ENGINEER/USS XXXXXXXXXXXX/LOC:AT SEA

/EMAIL:ENG(AT) XXXXXXXXXXXX.NAVY.SMIL.MIL//

RMKS/1. EXECUTIVE SUMMARY: EMERGENCY PROPULSION MOTOR (EPM) CIRCUIT BREAKER AT EPM CONTROL PANEL (EPMCP) IS STILL EXPERIENCING TRIPS ON OVERCURRENT WHEN TAKING THE EPM ABOVE 18 SHAFT RPM IN THE AHEAD DIRECTION. CONTROL OF EPM MOTOR ARMATURE CURRENT BETWEEN SPEEDS OF 13 AND 18 SRPM IS SENSITIVE, WITH MOTOR ARMATURE CURRENT SPIKING AS MOTOR SPEED IS INCREMENTALLY RAISED. THE EPM REMAINS OPERATIONAL AT SPEEDS LESS THAN 15 SRPM AHEAD. OPERATION ASTERN IS NORMAL.

2. BACKGROUND: SHIP IS CURRENTLY CONDUCTING POST-SRA SEA TRIALS. SHIPALT 3461K (EPM HIGH TORQUE CLUTCH) WAS INSTALLED DURING SRA. EPM OPERATION WAS TESTED SATISFACTORILY PIERSIDE ON XXAUGXX TO A MAXIMUM SPEED OF 15 SRPM AHEAD AND ASTERN WITH NO ABNORMALITIES NOTED.

3. DESCRIPTION OF PROBLEM:

A. WHILE SLOWLY BRINGING THE EPM FROM 13 TO 18 SRPM AHEAD BY INCREMENTALLY TURNING THE HANDWHEEL (LESS THAN 1/64TH TURN) CLOCKWISE THE MOTOR ARMATURE CURRENT SPIKES TO APPROXIMATELY 800 TO 1100 AMPS DC THEN RETURNS TO NORMAL STEADY RUNNING CURRENT (APPROX 250 AMPS DC). THE MAGNITUDE OF THE SPIKE IS DIRECTLY PROPORTIONAL TO THE MOTOR SPEED/HANDWHEEL POSITION. MOTOR FIELD CURRENT BEHAVES NORMALLY, RUNNING FROM 7-9 AMPS DC.

B. AS SPEED IS RAISED ABOVE 18 SRPM, AN ARMATURE CURRENT SPIKE OF 1800 AMPS DC IS INDICATED AS THE EPM BREAKER TRIPS. THE MOST LIKELY CAUSE OF THE BREAKER TRIP IS OVERCURRENT (RATED INSTANTANEOUS TRIP POINT IS 2800 AMPS DC), BUT THE AMMETER RESPONSE IS TOO SLOW TO REGISTER FULL DEFLECTION.

4. TROUBLESHOOTING EFFORTS:

A. PERFORMED CLEAN AND INSPECT OF EPM CONTROL PANEL AND CONTROLLER PER EL-26 A-5 AND A-2 SATISFACTORILY.

B. TESTED OPERATION OF EPMCP PER EL-26 R-2M SATISFACTORILY.

C. INSPECTED EPM CIRCUIT BREAKER SATISFACTORILY.

D. MEASURED RESISTANCE OF FIELD RHEOSTAT THROUGH ITS ENTIRE RANGE OF MOTION. INITIALLY DISCOVERED SEVERAL REGIONS OF HIGH RESISTANCE

CONTACT. CLEANED RHEOSTAT TO LESS THAN 0.1 OHM THROUGHOUT RANGE OF MOTION, WITH NO RESULTANT CHANGE IN OPERATING BEHAVIOR.

5. ASSISTANCE DESIRED: REQUEST FURTHER TROUBLESHOOTING GUIDANCE BY XXAUGXX.

6. CO ASSESSMENT AND REPAIR DESIRES: ORIG IS CONTINUING WITH POST-SRA SEA TRIALS, LIMITING EPM TO 15 SRPM AHEAD. ADDITIONAL TROUBLESHOOTING WILL BE PERFORMED UPON SURFACING. PER REF A VOL 2 TAB V-A TABLE 4-3, SHIP'S FORCE WILL INSPECT FIELD RESISTOR FOR A POSSIBLE OPEN CIRCUIT.//

BT

#0054

NNNN

NOTE: ENSURE MESSAGES ARE IN ACCORDANCE WITH CURRENT MESSAGE FORMAT AND CURRENT PLAD IS UTILIZED.

APPENDIX C

SAMPLE (SUBS) FINAL/CLOSEOUT MESSAGE

OATUZYUW RUCORGP0054 2282105-UUUU--RUCBKMC.

ZNR UUUUU ZUI RUCOMCB4998 2290310

O 1730XXZ AUG XX

FM USS XXXXXXXXXXX

TO COMSUBRON XXXXX//

INFO COMSUBLANT NORFOLK VA//

COMNAVSEASYS COM WASHINGTON DC//

COMSUBGRU XXX//

NAVSHIPYD NORFOLK VA//

XXXXX RMC XXXXX XX

SUBMEPP PORTSMOUTH NH

DIRSSP WASHINGTON DC// (FOR SSBN/SSGN)

BT

UNCLAS

MSGID/GENADMIN/XXXXXXXXXX/0054/AUG//

SUBJ/(SUBS) EPM CIRCUIT BREAKER OVERCURRENT TRIPS **FINAL**//

REF/A/DOC/NAVSEA/14MAR1995//

AMPN/REF A IS NAVSEA 0942-LP-005-2020/(C) MAIN PROPULSION GEARS WITH CH-1.//

POC/XXXXX./ENGINEER/USS XXXXXXXXXXXX/LOC:AT SEA

/EMAIL:ENG(AT) XXXXXXXXXXXX.NAVY.SMIL.MIL//

RMKS/1. EXECUTIVE SUMMARY: THE MATERIAL ISSUE OF OVERCURRENT TRIPS OF THE EMERGENCY PROPULSION MOTOR (EPM) CIRCUIT BREAKER HAS BEEN CORRECTED.

2. BACKGROUND: SHIP WAS CONDUCTING POST-SRA SEA TRIALS. SHIPALT 3461K (EPM HIGH TORQUE CLUTCH) HAD BEEN INSTALLED DURING SRA. EPM OPERATION WAS TESTED SATISFACTORILY PIERSIDE ON XXAUGXX TO A MAXIMUM SPEED OF 15 SRPM AHEAD AND ASTERN WITH NO ABNORMALITIES NOTED.

3. DESCRIPTION OF PROBLEM:

A. WHILE SLOWLY BRINGING THE EPM FROM 13 TO 18 SRPM AHEAD BY INCREMENTALLY TURNING THE HANDWHEEL (LESS THAN 1/64TH TURN) CLOCKWISE THE MOTOR ARMATURE CURRENT SPIKES TO APPROXIMATELY 800 TO 1100 AMPS DC THEN RETURNS TO NORMAL STEADY RUNNING CURRENT (APPROX 250 AMPS DC). THE MAGNITUDE OF THE SPIKE IS DIRECTLY PROPORTIONAL TO THE MOTOR SPEED/HANDWHEEL POSITION. MOTOR FIELD CURRENT BEHAVED NORMALLY, RUNNING FROM 7-9 AMPS DC.

B. AS SPEED WAS RAISED ABOVE 18 SRPM, AN ARMATURE CURRENT SPIKE OF 1800 AMPS DC WAS EXPERIENCED AND THE EPM BREAKER TRIPPED.

4. TROUBLESHOOTING EFFORTS:

A. PERFORMED TROUBLESHOOTING AS IDENTIFIED IN PROVIDED TECHNICAL ASSIST MESSAGES.

B. PROBLEM WAS FOUND TO BE THE FIELD RESISTOR WAS EXPERIENCING AN OPEN CIRCUIT DUE TO A LOOSE CONNECTOR LUG CAUSING A HIGH RESISTANCE CONNECTION. THIS PROBLEM WAS IDENTIFIED DURING THE INSPECTION OF EPM CONTROL PANEL AS DESCRIBED IN THE PROVIDED TECH ASSIST MESSAGE.

5. ASSISTANCE DESIRED: PROBLEM CORRECTED, NO FURTHER ASSISTANCE REQUIRED. THIS IS THE FINAL REPORT NO ADDITIONAL ACTION REQUIRED.

6. CO ASSESSMENT AND REPAIR DESIRES: EPM RESTORED TO FULL SERVICE. //

BT

#0054

NNNN

NOTE: ENSURE MESSAGES ARE IN ACCORDANCE WITH CURRENT MESSAGE FORMAT AND CURRENT PLAD IS UTILIZED.

(This Page Intentionally Left Blank)

APPENDIX D

SAMPLE (SUBS) SHIPALT/TEMPALT INSTALLATION MESSAGE

RATUZYUW RHBPHVA0098 0441139-UUUU--RUCBKMC.
 ZNR UUUUU ZUI RUCOMCB0075 0472222
 R 13XXXXZ FEB XX
 FM USS XXXXXX//
 TO COMSUBLANT NORFOLK VA//
 INFO CNO WASHINGTON DC//
 CNO WASHINGTON DC//
 COMLANTFLT NORFOLK VA//
 COMSUBGRU TWO//
 COMSUBRON EIGHT//
 NAVSUBSCOL GROTON CT//
 SPAWARSYSCEN CHARLESTON SC//
 SPAWARSYSCEN SAN DIEGO CA//
 CBTDIRSYSACT DAM NECK VA//
 NAVSURFWARCEN CARDEROCKDIV BETHESDA MD//
 NAVSURFWARCENDIV CRANE IN//
 SUPSHIP GROTON CT//
 SUPSHIP NEWPORT NEWS VA//
 NAVSHIPYD NORFOLK VA//
 BT
 UNCLAS
 MSGID/GENADMIN/UNIT NAME/FEB//
 SUBJ/(SUBS)COMPLETION OF TEMPALT XXXXK FIRE FIGHTING STATION UPGRADE
 INSTALLATION (TEMPALT)//
 REF/A/MSG/CSL/XXXXXXXXJUN05//
 REF/B/DOC/NAVSEA/MARXXXX//
 NARR/REF A IS COMSUBLANT MESSAGE AUTHORIZING INSTALLATION OF
 TEMPALT XXXXK FIRE FIGHTING STATION UPGRADE ON USS XXXXX.
 REF B IS NAVSEA TECHNICAL SPECIFICATION XXXXXXXXXXXX SHIP
 ALTERATION ACCOMPLISHMENT BY INSTALL TEAMS.//
 POC/JOHN SMITH/INSTALLATION MGR/NUWC DIV NEWPORT/-
 /TEL:XXX-XXX-XXXX//
 RMKS/1. **ACTIVITIES:** THIS IS A JOINT USS XXXXX NUWC DIV NEWPORT
 MESSAGE.
 2. **BACKGROUND:** TEMPALT 000K FIRE FIGHTING STATION UPGRADE
 WAS INSTALLED DURING PERIOD XXAUGXXXX THROUGH XXSEPXXXX. SOVT
 WAS COMPLETED XXNOVXXXX AND THE FIRE FIGHTING STATION WAS ACCEPTED
 AS OPERATIONAL.
 3. **PROVIDED INFORMATION:**
 A. TYPE INSTALLATION: FIRE FIGHTING STATION UPGRADE.
 B. ALTERATION NUMBER: XXXXK.
 C. CERTIFYING STATEMENT: ALL WORK WAS ACCOMPLISHED IN FULL COMPLIANCE
 WITH APPLICABLE CONTRACTUAL STANDARDS, SPECIFICATIONS AND INSTALLATION
 DRAWINGS. AS OUTLINED IN REF (A) SYSTEM OPERATION VERIFICATION TESTING (SOVT)
 WAS COMPLETED ON XXNOVXXXX. RESULTS WERE PROVIDED TO SHIP'S FORCE.
 D. INSTALLATION ISSUES: SHIP'S INSTALLATION DRAWINGS (SID) REQUIRE REVISION. ALL
 LIAISON ACTION REQUESTS (LAR) SUBMITTED TO THE PLANNING YARD WERE RESOLVED.
 SHIP'S FORCE HAS BEEN PROVIDED COPIES OF ALL LARS. RED LINE SHIPALT DRAWINGS WERE
 PROVIDED TO THE SHIP AND WILL BE PROVIDED TO PLANNING YARD.
 E. ALTERATION COMPLETION REPORT COMPLETED AND FORWARDED XXDECXXXX.

F. EQUIPMENT INSTALLED: FIRE FIGHTING PRESSURE ENHANCER.

G. ILS PROVIDED: TECHNICAL MANUALS ITEM (CD), MIP# 0000/000-00 AND MRC CARDS, FIRE FIGHTING STATION LIBRARY DATA (CLASSIFIED), SSN-XXX COP, (CDMD-OA WORK FILE). THE ON BOARD REPAIR PARTS (OBRP). WILL BE PROVIDED BY NAVICP WHEN THEY ARE PRODUCED BY SHIP'S FORCE.

H. TRAINING PROVIDED: MM1 JONES RECEIVED TWO HOURS OF OPERATIONAL TRAINING.

I. SUMMARY: THE INSTALLATION PROGRESSED ON SCHEDULE WITH NO MAJOR DELAYS. THE SUPPORT PROVIDED BY SHIP'S FORCE WAS EXCELLENT.

J. ANTICIPATED REMOVAL DATE. XXMARXXXX.

4. POC: NUWC DIV NEWPORT POC MR. JOHN SMITH (XXX)XXX-XXXX, E-MAIL SMITH (AT)NPT.NUWC.NAVY.MIL.

5. COMMANDING OFFICERS COMMENTS: NONE//

BT

#0098

NNNN

NOTE: ENSURE MESSAGES ARE IN ACCORDANCE WITH CURRENT MESSAGE FORMAT AND CURRENT PLAD IS UTILIZED.

APPENDIX E

SAMPLE (SUBS) SHIPALT/TEMPALT REMOVAL MESSAGE

RATUZYUW RHBPHVA0098 0441139-UUUU--RUCBKMC.
 ZNR UUUUU ZUI RUCOMCB0075 0472222
 R 13XXXXZ FEB XX
 FM USS XXXXXX//
 TO COMSUBLANT NORFOLK VA//
 INFO CNO WASHINGTON DC//
 CNO WASHINGTON DC//
 COMLANTFLT NORFOLK VA//
 COMSUBGRU TWO//
 COMSUBRON EIGHT//
 NAVSUBSCOL GROTON CT//
 SPAWARSSYSCEN CHARLESTON SC//
 SPAWARSSYSCEN SAN DIEGO CA//
 CBTDIRSYSACT DAM NECK VA//
 NAVSURFWARCEN CARDEROCKDIV BETHESDA MD//
 NAVSURFWARCENDIV CRANE IN//
 SUPSHIP GROTON CT//
 SUPSHIP NEWPORT NEWS VA//
 NAVSHIPYD NORFOLK VA//
 BT
 UNCLAS
 MSGID/GENADMIN/UNIT NAME/FEB//
 SUBJ/(SUBS) COMPLETED REMOVAL OF TEMPALT XXXXK FIRE FIGHTING STATION UPGRADE
 (TEMPALT)//
 REF/A/MSG/CSL/XXXXXXXXJUN05//
 REF/B/DOC/NAVSEA/MARXXXX//
 NARR/REF AIS COMSUBLANT MESSAGE AUTHORIZING REMOVAL OF
 TEMPALT XXXXK FIRE FIGHTING STATION UPGRADE ON USS XXXXX.
 REF B IS NAVSEA TECHNICAL SPECIFICATION XXXXXXXXXXXX SHIP
 ALTERATION ACCOMPLISHMENT BY INSTALL TEAMS.//
 POC/JOHN SMITH/INSTALLATION MGR/NUWC DIV NEWPORT/-
 /TEL:XXX-XXX-XXXX//
 RMKS/1. **ACTIVITIES:** THIS IS A JOINT USS XXXXX NUWC DIV NEWPORT
 MESSAGE.
 2. **BACKGROUND:** TEMPALT 000K FIRE FIGHTING STATION UPGRADE
 WAS INSTALLED DURING PERIOD XXAUGXXXX THROUGH XXSEPXXXX. SOVT
 WAS COMPLETED XXNOVXXXX AND THE FIRE FIGHTING STATION WAS ACCEPTED
 AS OPERATIONAL.
 3. **PROVIDED INFORMATION:**
 A. REMOVAL DATE: XXJUNXXXX
 B. CERTIFYING STATEMENT: SHIP RESTORED TO ORIGINAL CONFIGURATION.
 C. REMOVAL ISSUES: ANY OUTSTANDING ISSUE PREVENTING FULL RESTORATION.
 4. **POC:** NUWC DIV NEWPORT POC MR. JOHN SMITH (XXX)XXX-XXXX, E-MAIL
 SMITH(AT)NPT.NUWC.NAVY.MIL.
 5. **COMMANDING OFFICERS COMMENTS:** NONE//
 BT
 #0098
 NNNN

**NOTE: ENSURE MESSAGES ARE IN ACCORDANCE WITH CURRENT MESSAGE FORMAT AND
 CURRENT PLAD IS UTILIZED.**

(This Page Intentionally Left Blank)

VOLUME VI
CHAPTER 41
MAINTENANCE AND PROJECT TEAM

REFERENCES.

- (a) NAVSEA SL720-AA-MAN-030 - Navy Modernization Process Management and Operations Manual (NMP-MOM)

41.1 PURPOSE. The purpose of this chapter is to define and establish the membership and responsibilities of the Maintenance Team and Project Team (PT) and those supplemental members of both that support the maintenance and modernization process. The Maintenance Team, PT and those that supplement under the Planning Process are integral members of a complex evolution that requires communication, coordination and collaboration in order to accomplish availability planning, execution and close out efficiently and effectively. The contents of this chapter complement Volume II, Part II, Chapter 1, Volume VI, Chapter 31, Volume VI, Chapter 33, and Volume VII, Chapter 7 of this manual.

41.2 MAINTENANCE TEAM. Each ship shall have a formally structured Maintenance Team. The team is led by the Ashore Ship Maintenance Manager and consists of representatives from the ship and the supporting shore maintenance infrastructure. The responsibility of the Maintenance Team is to manage the advanced planning and planning of maintenance, the routine maintenance of the ship and modernization in accordance with the maintenance policies, directives and business rules of the Fleet Commander, Type Commander (TYCOM) and the Naval Supervisory Authority (NSA).

41.2.1 Crew Swap. When a crew swap occurs that rotates a different crew to a hull, the non-crew members of the Maintenance Team shall remain with the hull and provide continuity in planning and execution.

41.2.2 Maintenance Team Members. While there are many who contribute to the planning of ship maintenance and modernization, some key personnel have a continuing involvement in and responsibility for management of the overall advanced planning and planning of the ship's maintenance and modernization. The Maintenance Team forms the core of the PT. The Maintenance Team shall be permanently assigned to the ship and shall consist of the following members:

- a. Ashore Ship Maintenance Manager. Validates, screens and brokers all maintenance and modernization, including assessments, requiring off ship assistance. Ensures the Project Manager (PM) has visibility of all assigned work. For all combat systems related maintenance and modernization the Ashore Ship's Maintenance Manager will coordinate with the Combat Systems Port Engineer. Assignments are:
 - (1) Surface Force Port Engineer
 - (2) Naval Air Force TYCOM Maintenance Program Manager
 - (3) Submarine Force Maintenance Coordinator
- b. Ship's Commanding Officer. Primary representative for the ship. (The Commanding Officer may delegate to a representative.)
- c. I-Level Ship Superintendent. Manages Regional Maintenance Center (RMC)/Fleet Maintenance Activity (FMA) Government production work for Continuous Maintenance (CM), Continuous Maintenance Availability (CMAV) and Chief of Naval Operations (CNO) availabilities. Manages I-Level production work planning, integration, execution and close out, reporting progress/status to the Project Manager and Ashore Ship's Maintenance Manager.
- d. Project Manager. NSA support to the Ashore Ship's Maintenance Manager in the advanced planning and close out phases of the maintenance availability (not applicable for Submarine Fleet Availabilities).
- e. Ship Material Maintenance Officer. Coordinates Maintenance Team activities with Ship's Force personnel. Assignments are:
 - (1) Surface Force Ship Material Maintenance Officer

- (2) Naval Air Force Ship Maintenance Manager*
- (3) Submarine Force 3M Coordinator

* The Reactor Maintenance Officer fills this role for Nuclear Propulsion issues.

- f. Contractor Program Manager (when required). Manages authorized contractor/company work. Assignments are:

- (1) Surface Force Prime Contractor Program Manager
- (2) Naval Air Force Prime Contractor for RMC contracted (non Naval Shipyard (NSY)) work
- (3) Submarine Force Prime Contractor for RMC contracted (non NSY) work

- g. Maintenance Support Team (LCS class ships only).

41.2.3 The Principal Roles of the Maintenance Team.

- a. Management of Ship Maintenance. The Maintenance Team ensures the ship's Current Ship's Maintenance Project (CSMP) and Availability Work Package (AWP) are validated and accurately reflect the ship's material condition and current maintenance status. The Maintenance Team ensures there is an initial cost estimate in man-days and material dollars for all work candidates, including assessments and technical assistance. The estimates shall be developed by the Ashore Ship's Maintenance Manager during initial review of the work candidates to be as accurate as possible, based on available information such as return costs from similar jobs, Ashore Ship Maintenance Manager experience, NSA and other government prepared or approved estimates. These estimates shall be updated within the CSMP, as they are refined in order to provide the Maintenance Team with adequate data to plan maintenance actions. For Aircraft Carriers, these estimates will be entered in the Proposed AWP and finalized in the Authorized AWP. The Maintenance Team coordinates inspections, certifications, assessments and assist visits in support of the class maintenance plan. Additionally, the Maintenance Team may provide on-scene assessment of equipment condition to develop valid and accurate work candidates.
- b. Budgeting for Ship Maintenance. The Ashore Ship's Maintenance Manager is responsible for the ship's Maintenance and Modernization Business Plan (MMBP). The Maintenance Team develops the budget recommendation for funding maintenance requirements for the fiscal year. The Maintenance Team assesses the ship's anticipated material condition for budget consideration including the validated CSMP, Class Maintenance Plan, planned fleet alterations, outstanding Departures From Specification (DFS), Temporary Standing Orders and Casualty Reports. This MMBP shall address the funding required for execution year maintenance. Ashore Ship's Maintenance Manager and the Maintenance Team members will maintain their ship within the fiscal guidance defined by the approved MMBP. Chapter 33 of this volume describes the development and maintenance of the MMBP.
- c. Logistics and Technical Expertise. The Maintenance Team members maintain a current, valid CSMP and AWP that serve as the authoritative source for all information on maintenance requirements. All technical guidance and advice provided by the members of the Maintenance Team must be in compliance with Systems Command approved technical guidance and policy. In instances where action by a Technical Authority is needed, the Project Manager shall ensure this authorization is obtained. The effective logistics support for maintenance depends on the accuracy of the ship's configuration records. The Maintenance Team oversees prompt submission of change documentation pursuant to maintenance or modernization, validates change entries and ensures configuration records (e.g., Configuration Data Managers Database - Open Architecture) are updated.
- d. Availability Coordination. The Ashore Ship's Maintenance Manager works for the TYCOM to develop, plan and coordinate scheduled availabilities, CM opportunities and emergent repairs of assigned ships within the resources provided. The Ashore Ship's Maintenance Manager shall enter CNO availabilities, assessments, associated routine tasks and authorized Fleet and Programmed Alterations into the appropriate Maintenance Automated Information System in accordance with standard availability planning milestones. The Maintenance Team serves as the point of contact for the NSA/Lead Maintenance Activity (LMA) in coordinating maintenance and planning activities. The Maintenance Team facilitates the orderly conduct of work candidate identification, validation, screening and brokering.

NOTE: RESPONSIBILITIES FOR EACH MEMBER HAVE BEEN BROKEN DOWN INTO TWO CATEGORIES, ACCOUNTABLE AND RESPONSIBLE.

- e. **Accountable:** Owns the work, the person who makes the final decision on a task and has the ultimate ownership over that task.
- f. **Responsible:** A contributor, this will be the person or people assigned to do the work.

41.2.4 Specific Duties of Maintenance Team Members.

41.2.4.1 Ashore Ship's Maintenance Manager.

- a. For Aircraft Carriers, receives the Baseline Availability Work Package (BAWP) from the Carrier Planning Activity. Builds and refines the Proposed and Authorized AWP's.
- b. **Accountable:**
 - (1) Leads the Maintenance Team and maintains frequent contact with the Commanding Officer and conducts personal observations of shipboard conditions. Establishes and maintains an effective communications plan with the ship during deployment. More information can be located in Volume II, Part II, Chapter 1, paragraph 1.2.2 of this manual.
 - (2) Maintains the CSMP shore file accuracy and provides recommended changes for the shipboard CSMP to the Ship Material Maintenance Officer and 3M Coordinator. (See Volume II, Part II, Chapter 1, paragraph 1.3.1 of this manual.)
 - (3) Validates all off ship maintenance for assigned ship(s), including off-ship assessments. (See Volume II, Part II, Chapter 1, paragraphs 1.3.2, 1.3.4 and 1.3.5 of this manual.)
 - (4) Develops initial planning estimates based on information such as return costs from similar jobs and Government prepared or approved estimates. (See Chapter 31, paragraph 31.4.2 of this volume.)
 - (5) Screens/schedules work candidates to the right time period and maintenance availability based on the MMBP, operational schedule, material readiness requirements and cost benefit analysis. (See Volume II, Part II, Chapter 1, paragraphs 1.4.1 and 1.4.4 of this manual.)
 - (6) Brokering as discussed in Volume II, Part II, Chapter 1, paragraph 1.4.2 of this manual.
 - (7) Schedules, and assists the ship's Commanding Officer in conducting the Planning Board for Maintenance meetings, including agenda development. (See Volume II, Part I, Chapter 4, paragraph 4.2.5 of this manual.)
 - (8) Coordinates all off-ship maintenance and modernization requirements.
 - (9) Screens Automated Work Requests in support of 100%, 80% and 50% package lock, including CSMP, Class Maintenance Plan (CMP) and TYCOM routines.
 - (10) Initiates work candidates (OPNAV 4790/2K) for "service" work.
 - (11) Develops Business Case Analysis and generates applicable Engineering Services Request, provides advice and serves as the ship's point of contact for access to technical expertise for all ship maintenance and modernization requirements, including the development of Ship Changes.
- c. **Responsibilities:**
 - (1) Communicates, coordinates and tracks ship and applicable class problems.
 - (2) Ensures configuration change requests are promptly submitted.
 - (3) Ensures completion work candidates (OPNAV 4790/2K) are entered into the CSMP and the appropriate IT system. (See Chapter 2, paragraph 2.6.2 of this volume.)
 - (4) Executes the approved MMBP to best utilize windows of opportunity. (See Volume II, Part II, Chapter 2, paragraph 2.1.2 of this manual.)

- (5) Makes recommendations to the ship's Commanding Officer and management on any deferred work items. (See Volume II, Part II, Chapter 1, paragraph 1.4.5 of this manual.)
- (6) Coordinates maintenance availability scheduling and execution. (See Volume II, Part II, Chapter 2, paragraph 2.6.5 of this manual.)
- (7) (Surface Force only) Supports the RMC in planning assigned ship maintenance/modernization availabilities. (See Volume VII, Chapter 1, paragraph 1.3.8 of this manual.)
 - (a) Develops and schedules work packages. Recommends resolutions to CNO scheduling issues.
 - (b) Recommends CM opportunities to the ship's Commanding Officer and the NSA management. Creates CM availabilities.
 - (c) Screens work candidates (OPNAV 4790/2K) to appropriate level of maintenance (Organizational, Intermediate, Depot (O, I, D)). Reviews assessment results for inclusion in work packages.
 - (d) Assists Project Manager with work package analysis for Private Sector Industrial Activity (PSIA) contracts.
 - (e) Provides availability evaluation input documentation during availabilities supporting Contractors Performance Appraisal Reporting System (CPARS).
- (8) Supports Fast Cruise, Dock Trials, Sea Trials, Propulsion Plant Light Off Assessment (LOA) and Production Completion Date (PCD), Combat Systems or AEGIS Light Off and TYCOM validation of PCD.
- (9) Attends Integrated Project Team Development (IPTD), Work Package Integration Conference (WPIC), Work Package Execution Review (WPER), Lessons Learned Conference (LLC) Life Cycle Planning, Docking, Arrival, 25%/50%/75% reviews, Undocking, and Departure conferences,
- (10) Plans, coordinates and executes mid-deployment shipcheck.
- (11) Supports Ship's Force for AWP collection and management of Objective Quality Evidence (OQE).
- (12) Performs AWP risk assessments and verifies deliverables to contractor (O, I, D work items and Alteration Installation Team (AIT) schedule requirements).
- (13) Assists the NSA with technical close out and availability work certification. Assists ship in achieving maintenance phase exit criteria.
- (14) Supports the 100% Package Lock Letter.
- (15) Validates growth and new work, assists with the Regional Calibration Center process.
- (16) Supports and participates in work specification review.
- (17) Provides incremental funds for ordering Long Lead Time Material (LLTM) for both repair and alteration/modification work to meet required dates.
- (18) Submits change deferral request to appropriate platform planning activity.

41.2.4.2 Ship's Commanding Officer. Primary representative for the ship. Works with the Ashore Ship's Maintenance Manager on the development and prioritization of the ship's maintenance and modernization including the MMBP.

a. Accountable:

- (1) Reports progress weekly to the TYCOM. Recommends urgent and compelling decisions to the TYCOM.

- (2) Works with the Ashore Ship's Maintenance Manager to develop the final work package submission for the ship.
- (3) Directs efforts to identify all shipboard maintenance requirements and ensures accurate and timely entry into the CSMP. Reviews, plans and monitors accomplishment of organizational level work.
- (4) Initiates requests for technical assistance, including distance support.
- (5) Determines the affect of material deficiencies on mission capability and releases Casualty Reports.
- (6) Integrates maintenance planning in the ship's operational schedule.
- (7) Ensures the ship is prepared for and ready to conduct: propulsion plant PCD/LOA, combat systems PCD, combat systems light off events.
- (8) Chairs the Planning Board for Maintenance meeting.

b. Responsibilities:

- (1) Verifies technical assistance final resolution satisfies ship's maintenance issue.
- (2) Ensures Ship's Force assists with the management and oversight of work execution by maintenance activities and AITs.
- (3) Executes shipboard DFS process.
- (4) Ensures ship properly supports 25%/50%/75% reviews; Arrival, Docking, Undocking, Fast Cruise, Dock Trials, Sea Trials, Departure, and Completion key events and conferences; IPTD, WPIC, WPER events; and CSMP, DFS, BAWP Mid-Cycle reviews.
- (5) Ensures Integrated Logistics Support (ILS) is provided.
- (6) Assists in scheduling and execution of mid-deployment shipcheck.
- (7) Collaborates in the authorization of growth/new work.
- (8) Supports the Integrated Test Plan execution and work certification.
- (9) Assists in achieving maintenance phase exit criteria. Ensures proper space turnover, Ship's Force AWP collection and management of OQE, and availability technical closeout.

41.2.4.3 I-Level Ship Superintendent.

a. Accountable:

- (1) Manages the collection of I-Level OQE.
- (2) Manages RMC/FMA work planning, scheduling, integration, and work execution. Resolves conflicts with other Executing Activities. Ship checks work candidates (2K) as applicable and provides estimates on all I-Level work candidates. Recommends cancellation of invalid work candidates, if applicable.
- (3) Represents the RMC/FMA to Ship's Force for RMC/FMA production maintenance work. Coordinates the performance of I-Level work including all scheduling and availability coordination, ensuring the I-Level work package is fully accepted in accordance with milestones.

b. Responsibilities:

- (1) Ensures completion of I-Level production work supporting LOA, propulsion plant PCD, AEGIS and Combat Systems Lightoff, Docking, Undocking, Fast Cruise, Dock Trials, Sea Trials, and Availability Completion.
- (2) Assists ship in achieving maintenance phase exit criteria. Ensures I-Level work is complete in support of availability certification, completion, and technical close out.
- (3) Attends availability production meetings; Arrival, Docking, Undocking, Departure, WPIC and WPER conferences.

- (4) Coordinates work planned and performed by RMC production department. FMA repair division, submits I-Level schedule to NSA/LMA for integration, coordination of I-Level open and inspects, coordination of oversight for I-Level work (Product Verification Inspection (PVI), Procedure Evaluation (PE), Procedure Review (PR)).
- (5) Provides recommendations regarding assignment of work candidates to RMC production department/FMA repair division based on the capabilities and capacities of the RMC/FMA. Works closely with the Ashore Ship's Maintenance Manager on the validation and screening of all work candidates to the I-Level.
- (6) Ensures completed maintenance action (OPNAV 4790/2K) for completed work.

41.2.4.4 Project Manager.

a. Accountable:

- (1) Supports the Ashore Ship's Maintenance Manager in the performance of maintenance and modernization.
- (2) Accepts or rejects work candidates to scheduled availability periods and performing activities in accordance with guidance in Volume II, Part II, Chapter 1 of this manual. Integrates work candidates to form optimized work packages.
- (3) Establishes the availability in the appropriate maintenance execution IT system.
- (4) Ensures LLTM for Firm Fixed Price and PSIA contracts is ordered to support availabilities.
- (5) Conducts Work Specifications Review with Ashore Ship's Maintenance Manager.
- (6) Serves as the advanced planning manager for contracted maintenance during CNO availabilities and scheduled CMAVs conducted at contractor or Government depots. Coordinates the continuous cost estimate review process.
- (7) Provides timely financial accounting information during the execution of maintenance to customers.

b. Responsibilities:

- (1) Supports CSMP/DFS/BAWP mid-cycle review.
- (2) Attends IPTD events, scoping conferences (see Volume VII, Chapter 2, paragraph 2.12.1 of this manual), WPIC and WPER.
- (3) Assists in coordinating mid-deployment shipchecks.
- (4) Provides incremental funds for ordering LLTM for both repair and alteration/modification work to meet required dates.

41.2.4.5 Ship's Material Maintenance Officer. (The Reactor Maintenance Officer fills this role for Nuclear Propulsion issues.) Coordinates Maintenance Team activities with Ship's Force personnel.

a. Accountable:

- (1) Provides the Ship's Force work package to the Project Manager and executing activity. Assists in coordinating the integration of Ship's Force work for CNO and/or CMAV availabilities. Provides shipboard schedule inputs (see Volume II, Part II, Chapter 1, paragraph 1.2.2 of this manual). Interfaces with the Project Manager and the executing activity to resolve maintenance issues.
- (2) Commanding Officer's principal assistant for management of ship maintenance. Prepares the ship input to the Planning Board for Maintenance agenda in support of the Ashore Ship's Maintenance Manager. Works with the Maintenance and Material Management Coordinator to maintain an accurate shipboard CSMP. Approves, validates and ensures submittal of accurate work candidates (OPNAV 4790/2K).

- (3) Works with the Quality Assurance Officer and department representatives to submit and track DFSs.
- (4) Ensures initiation of work candidates (OPNAV 4790/2K) to request distance support and technical assists. Works with Subject Matter Experts (SME) to coordinate tech assist visits.
- (5) Monitors timely submission of configuration change requests.
- (6) Ensures Ship's Force verification of completed work and returns Completed Maintenance Action (OPNAV 4790/2K) to the Ashore Ship's Maintenance Manager.
- (7) Ensures valid deferred work is incorporated into the CSMP.

b. Responsibilities:

- (1) Ensures repair work candidates are submitted supporting 50%/80%/100% D-Level lock milestones.
- (2) Ensures Ship's Force I-Level work package 100% brokered and locked.
- (3) Ensures ship's initial conditions are set for work to begin by outside activities and Work Authorization Forms are properly executed. Ensures systems and equipment are properly tagged out, drained and depressurized.
- (4) Generates any new work requests along with supporting urgency information.
- (5) Ensures Ship's Force has planned and prepared for propulsion plant PCD, LOA, and AEGIS/combat systems PCD and light off, Fast Cruise, Dock Trials and Sea Trials mid-deployment shipchecks.
- (6) Attends the Docking, Arrival, 25%/50%/75%, Undocking and Departure conferences, WPIC, WPER, IPTD, LLC events, and CSMP/DFS/BAWP Mid-Cycle review.
- (7) Provides oversight and management to ensure AIT controls are in place, Regional Maintenance and Modernization Coordination Office requirements are met prior to starting work onboard ship, and assignment of SMEs to support AITs.
- (8) Ensures Ship's Force work is complete to support end of availability, space turnover, and availability work certification.
- (9) Supports Ship's Force ILS and consolidates software delivery.
- (10) Coordinates with Ship's Force the execution of the Integrated Test Plan.
- (11) Ensures Ship's Force, RMC, LMA, AWP collection and management of OQE.
- (12) Ensures AWP risk assessments are performed and deliverables to contractor verified.
- (13) Collaborates in the authorization of growth/new work.
- (14) Assists ship in achieving maintenance phase exit criteria.

41.2.4.6 Contractor Program Manager. Manages and supervises authorized contractor work (see Volume II, Part II, Chapter 1, paragraph 1.2.2 of this manual).

a. Accountable:

- (1) Schedules and oversees contractor required open and inspects.
- (2) Provides information and advice to the Government on matters of mutual concern to include contractor cost and time estimates, future work planning, contractor capability and capacity for varied work accomplishment (i.e., port loading), production management, integration of work from multiple activities and production problems for assigned availabilities.

- (3) Establishes and recommends availability milestones. Provides schedule for: Integrated Test Plan (ITP), Universal Process Control Procedure (UPCP), Process Control Procedures (PCP), availability planning and assessments.
- (4) Reviews and submits condition reports, initiates completion reports for authorized work completed.
- (5) Ensures progressing Cost/Schedule Status Reports.

b. Responsibilities:

- (1) Recommends scheduling of work to best take advantage of port work loading conditions, provides recommendations for reduction of premiums in the accomplishment of work.
- (2) Ensures completion of 50%, 80% and 100% D-Level maintenance work package 2Ks are planned and estimated. Publishes work package in the appropriate IT system. Conducts work specification reviews in support of each milestone, final package submission and cost proposal. Ensures work package is Technical Analysis Reported, negotiated and definitized.
- (3) Attends 25%/50%/75% reviews; Arrival, Docking, Undocking and Departure conferences; WPIC, WPER and LLC events.
- (4) Ensures completion of the ITP, propulsion plant PCD and LOA, Combat Systems\AEGIS PCD and Light Off, Fast Cruise, Dock Trials, Sea Trials, and Availability work certification.
- (5) Ensures consolidated software delivery and ILS support is provided.
- (6) Supports the PM to ensure the availability business and technical close requirements are met.
- (7) Supports the DFS process.
- (8) Ensures requirements are met to support the UPCP, PCP, cleanliness processes.
- (9) Provides contractor oversight of LMA checkpoint execution (V, G, I points) as well as PVI, PE, PR.
- (10) Provides personnel to coordinate with AIT, Fleet Maintenance Activity and Ship's Force to update production schedule (NSI 009-060).
- (11) Provides Integrated Total Ship Test Plan (NSI 009-067).
- (12) Ensures contractor work is complete to support space turnover.
- (13) Supports the authorization of growth/new work.
- (14) Ensures habitability items are complete.
- (15) Provides incremental funds for ordering LLTM for both repair and alteration/modification work to meet required dates, ensures delivery of material (LLTM and kitted materials) to executing activity.
- (16) Ensures work and support services are in place to support dock and undock.

41.3 **PROJECT TEAM.** (Augmentation to manage RMC-contracted maintenance in availabilities between A-120 and C+60). The PT shall be assigned to the ship availability and shall consist of those persons listed below and all members of the Maintenance Team. The Project Manager leads the PT and has the responsibility to ensure overall integration, execution and close out of a ship's availability. The PM is responsible for quality, schedule and cost. Some PT members may be assigned responsibilities for more than one ship.

- a. Project Manager
 - (1) RMC Project Manager. When a RMC is the NSA, the PM is responsible for integration, execution, and close out of the Work Package. When the NSY is the NSA the RMC PM is responsible for planning, integrating, coordinating, and executing the PSIA contracted maintenance work items, in support of the NSY Project Manager.
 - (2) NSY Project Manager (Superintendent). When a NSY is the NSA. Leads the PT. Manages Government production work for CNO availabilities. The Project Superintendent is the senior NSA representative and has the overall responsibility to plan, integrate and execute availabilities.
- b. Contract Specialist.
- c. Quality Assurance Specialist.
- d. NSA Logistical Representative.
- e. SEA 21 Hull, Mechanical and Electrical and AEGIS Combat Systems On-Site Logistician (where applicable).
- f. Project Support Engineer.
- g. Integrated Test Engineer.
- h. Assessment Director.
- i. Technical Matter Expert (Surface Force Ship critical work only).
- j. Shipbuilding Specialist.
- k. AIT On-Site Installation Coordinator.
- l. AIT Manager.
- m. Combat Systems Project Engineer (CSPE).
- n. SEA 21 Hull Manager (Surface Ship Program Office Modernization only).

41.3.1 Specific Duties of Project Team Members.

41.3.1.1 Project Manager.

- a. Accountable:
 - (1) Accepts and tracks all assigned maintenance work items through execution. Coordinates planning and cost estimating and design specification preparation and scheduling. Coordinates and manages shipchecks in accordance with Volume II, Part II, Chapter 2, paragraph 2.6.2.3 of this manual. Reviews specifications to ensure completeness and conformance with authorized work. Ensures all specifications for work are developed using approved technical guidelines ensuring maximum use of current NAVSEA approved Standard Items and Standard Work Item templates (Master Specification Catalogue).
 - (2) Analyzes feedback submissions in accordance with Chapter 39, Section 39.5 of this volume.
 - (3) Briefs Ship's Force on the status of all work, by work item (see Volume VII, Chapter 2, paragraph 2.8.8 of this manual).
 - (4) Acts as business agent with other activities on availabilities and contracts assigned that includes ensuring that TYCOM funds are utilized properly. Evaluates all Technical Analysis Reports (TAR) and supports the Contracting Officer in contract negotiations. Acts as assistant funds administrator (when designated in writing from the RMC Commanding Officer) for assigned availabilities and contracts.

- (5) (For Surface Force ships) Documents delay and disruption charges and lessons learned in accordance with Chapter 31, paragraph 31.5.3 of this volume.
- (6) Manages ship repair and modernization work items, job orders and contracts assigned by progressing and evaluating all work to anticipate, prevent and minimize delays, resolving all problems that affect the end cost, quality, schedule and performance of assigned availability or contract.
- (7) Evaluates and acts on the reports received from other members of the availability management team. Prepares reports on current status of assigned project or contract.
- (8) Maintains liaison with customers, the ships Maintenance Team, Ship's Force Representatives, and financial/accounting personnel.
- (9) (RMC PM only) Maintains liaison with RMC functional departments and the contractor.
- (10) Arranges and conducts the arrival conference (see Volume VII, Chapter 7, paragraph 7.7.1 of this manual), weekly progress conferences, weekly commanding officer's brief (see Volume VII, Chapter 7, paragraphs 7.7.2, 7.8.8, 7.12.1, 7.9.4 and Volume II, Part I, Chapter 3, paragraph 3.6.3.1 of this manual), Docking conference, and the Availability Completion conference. Attends weekly management meeting and on-site meetings to provide comprehensive information to all concerned and to remain current in all aspects of the project.
- (11) (RMC PM only) Arranges for RMC representation at all conferences pertaining to assigned availabilities and contracts. Coordinates the on-site work effort in observing the contractor's in process production performance and operational testing events for projects assigned to the team.
- (12) Reviews all work accomplished by assigned Shipbuilding Specialists to ensure compliance with regulations, directives, instructions, and policies as well as to ensure that intended work is practical and necessary.
- (13) (RMC PM only) Reviews contractors work schedules, manning curves, material ordering/receipt schedules and special tasking/equipment requirements. Evaluates contractors' proposals prior to and during contract execution. Takes corrective actions to eliminate conflicts and prevent work stoppages. Identifies and initiates action to correct, prevent, and minimize delays, resolving all problems that affect quality, schedule and contractor performance.
- (14) Provides written reports (CPARS) to the Contracting Officer for award fee evaluations on CNO availabilities.
- (15) Coordinates required action as a result of post overhaul/repair inspections with the NSA Technical Authority and Maintenance Team in accordance with Volume IV, Chapter 4, paragraph 4.3.2 of this manual.
- (16) Maintains records for the Contracting Officer to include but not limited to the following:
 - (a) Maintains a Significant Event Log (see Volume VII, Chapter 7, paragraphs 7.3.2 and 7.2.4 of this manual). All significant event logs from the shipbuilding specialist.
 - (b) Maintains correspondence files containing copies of all correspondence to the contracts office both internal and external.
 - (c) Obtains work authorizations for growth and new work. Work authorizations may be in the form of naval messages, speed letters, letters, other transmittals or documents. In the case of growth work, the authorization may be verbal, a memo at a meeting or a telephone call. Verbal authorizations should be documented with a memorandum for the record.

- (d) Maintains a ledger notebook or spreadsheet to assist in funds administration. For each contract modification initiated in the work package, the Project Manager shall show the title of the item, cite the proper funding authorization and account and show the Government estimate. The ledger shall show funds committed and obligated for each contract modification and other financial transactions and provide an indication of funds available for future use. When changes occur during the negotiation process, the funds reserved or obligated shall be changed to reflect the current funding status. Periodically, at least monthly, the Project Manager shall reconcile ledger accounts with the Contracting Officer and Comptrollers' accounts to ensure that funds are not over obligated or expended.
 - (e) Maintains material requisitions for Government Furnished Material (GFM) with prices.
 - (f) Maintains project orders and economy act orders issued to other Government activities.
 - (g) Maintains completion reports.
 - (h) Maintains departure reports including summary costs of individual work items.
- (17) (RMC PM only) Reviews contractor condition reports (see Volume VII, Chapter 7, paragraphs 7.10.2, 7.12.2 and 7.10.3 of this manual), exceptions list, and contract modifications for approval.
 - (18) Maintains contact with the ship through the guarantee period (see Volume VII, Chapter 7, paragraph 7.12.4 of this manual).
 - (19) Prepares a "Readiness to Start" report (see Volume VII, Chapter 7, paragraph 7.6.3 of this manual).
 - (20) Assists Contracting Officers (see Volume VII, Chapter 2, paragraph 2.7 of this manual), participate in the contract awards phase (see Volume VII, Chapter 7, paragraphs 7.6.1, 7.6.2, and 7.6.7 and Chapter 3, paragraph 3.7.5 of this manual), manages funding for option items in accordance with Chapter 31, paragraph 31.5.3 of this volume, participates in the pre-award survey, verifies adequate funding for acceptable berthing and messing and performs contract administration.
 - (21) (RMC PM only) Provides appropriate clearance letters to the ship for RMC and contractor personnel (see Volume VII, Chapter 7, paragraph 7.6.9 of this manual).
 - (22) Conducts underwater hull inspection and drydock walkthrough (see Volume VII, Chapter 7, paragraph 7.8.9.c of this manual).
 - (23) Provides a list of expected prorated items with work numbers assigned (see Volume II, Part II, Chapter 2, paragraph 2.4.6.2 of this manual).
 - (24) (RMC PM only) Establishes a Ship Specification Package within Navy Maintenance Database (NMD) Planning for CMAVs and set up availability in NMD to receive Automated Work Requests from the appropriate IT system. (See Volume II, Part II, Chapter 2, paragraph 2.6.2.2 of this manual.)
 - (25) (RMC PM only) Reviews and validates Automated Work Requests received in NMD Strategic Systems Programs planning availability daily (see Volume II, Part II, Chapter 2, paragraph 2.6.2.3 of this manual).
 - (26) Prepares and schedules the LOA/propulsion plant light off (see Volume II, Part I, Chapter 3, paragraph 3.3.4 of this manual).
 - (27) (RMC PM only) Reports costs, schedules and maintains the status of all CNO and CMAV work conducted at contractor and Government facilities.
 - (28) Coordinates, schedules and administers advance planning functions. Analyzes work package to maintain available dates and minimize premiums.

- (29) Participates in availability final cost validation.
- (30) Participates in establishing controls to fund all repairs for an availability.
- (31) (RMC PM only) Analyzes work package to level load contractor.
- (32) Assures planning estimates are established for timely receipt of funds, requests funds and distributes relevant availability information.
- (33) (RMC PM only) Coordinates review of both Government and contractor estimates for “reasonableness and fairness”. Recommends alternate contracting vehicles if applicable.
- (34) (RMC PM only) Submits contract work packages to appropriate procurement activity for solicitation and monitors progress of contract award.
- (35) (RMC PM only) Responds to contract bidders’ questions during Fleet Fast Pay solicitation.
- (36) Provides inputs for funding requirements and serves as the Maintenance Team funds manager for CNO availability preparation and execution.
- (37) Chairs advance planning meetings, reviews and accepts or modifies recommended availability milestones.
- (38) Updates appropriate product and pricing databases.
- (39) Prepares advance planning status messages, fuel and ammunition offload, readiness to start, pre-availability agreement, monthly availability status messages and completion messages for scheduled CNO/CMAV availabilities.
- (40) Coordinates interface of outside activities during availability execution (i.e., Systems Commander, TYCOM, In-Service Engineering Agent, AITs and other customers).
- (41) Oversees contractor and/or NSY work during availability execution. Progresses and monitors other integrated availability work.
- (42) Assists with business case analysis preparation.
- (43) Verifies that controls are sufficient to fund all repairs required to support operational commitments.
- (44) Reviews cost reports for cost performance.
- (45) Executes availability planning milestones. Enforces depot availability “lock”, planning and estimating dates.
- (46) Prepares the business case analysis for growth and new work recommendations and recommends resolutions to the Ashore Ship’s Maintenance Manager. Reviews the authorization and funding, and submits information to the contracting officer for negotiation on growth and new work.
- (47) Coordinates urgent and compelling requests.
- (48) Chairs weekly production progress meetings and provides regular status reports to Ashore Ship’s Maintenance Manager.
- (49) Reviews condition reports and evaluates submitted time and cost estimates for accomplishment or deferral in concert with the Ashore Ship’s Maintenance Manager's concurrence.
- (50) Oversees an independent Government review of brokered work candidates for obligation of Government funds and execution.
- (51) Ensures work candidate 2K documentation is complete and completion reports are initiated by the executing activity.
- (52) Verifies funds availability and maintains funds tracking reports.

- (53) (RMC PM only) Submits I-Level schedule to contractor for integration.
- (54) Ensures work is complete to support PCD, LOA, combat systems light off, propulsion plant light off, Dock Trials, Fast Cruise, Sea Trials (contractual milestone).
- (55) Provides oversight of AIT management.
- (56) Attends 25%, 50%, 75% reviews; Arrival, Docking, Undocking, Departure, and Completion conferences; IPTD, LLC, WPIC and WPER events.
- (57) Ensures work is complete and closed out to support business close.
- (58) Coordinates condition report responses.
- (59) Coordinates consolidated software delivery and ILS support.
- (60) Ensures work is complete supporting habitability completion.
- (61) Provides oversight of (PVI, PE, PR) and LMA checkpoint execution (V, G, I).
- (62) Ensures LMA coordinates with AIT, Fleet Maintenance Activity and Ship's Force to update production schedule (NSI 009-060).
- (63) Ensures LMA provides Integrated Total Ship Test Plan (NSI 009-067).
- (64) Requests funds for repair and modification work LLTM, orders LLTM Firm Fixed Price/PSIA.
- (65) (RMC PM only) Ensures contracted maintenance is complete supporting space turnover.
- (66) (RMC PM only) Performs risk assessments and verify deliverables to contractor (O, I, D work items and AIT schedule requirements).
- (67) Provides funds administration for all depot level funding on assigned ship(s) as designated in writing by the RMC Commanding Officer.

b. Responsibilities:

- (1) Provides supporting information for Business Case Analysis for new work.
- (2) Participates in CSMP/DFS/BAWP mid-cycle reviews, coordinates mid-deployment shipchecks, and participates in scoping conference (see Volume VII, Chapter 2, paragraph 2.12.1 of this manual).
- (3) Reviews and provides feedback on Engineering Service Request.
- (4) Ensures LMA and I-Level collection and management of AWP OQE.
- (5) Provides oversight of the Integrated Test Plan Execution.
- (6) (RMC PM only) Ensures contractor coordination of open and inspects with participating activities.
- (7) Progresses Cost/Schedule Status Reports.
- (8) Participates in risk letter development and signed out.
- (9) Assists with the authorization of growth and new work.
- (10) Assists ship in achieving maintenance phase exit criteria.

41.3.1.2 Contract Specialist. The Contract Specialist who acts as the Administering Contracting Officer (ACO) and whose duties parallel the responsibilities of the Contracting Officer. Their authority is limited as specified by the level of their Defense Acquisition Workplace Improvement Act qualifications level of authority, specific limitations of their warrant and specific assignments made by the Contracting Officer. The ACO is assisted by additional warranted, Defense Acquisition Workplace Improvement Act qualified personnel, who are assigned specific responsibilities for processing contractual issues and to assist with the management and administration of a contract. The contract specialist is a contributor and this will be the person or people assigned to do the work. The contract specialist's responsibilities are listed below in sub-paragraphs a. through d.

- a. Participates in negotiations. TAR, advance planning funding administration and definitization. Prepares for and participates in the award fee board/CPARS.
- b. Ensures financial and contractual requirements are met for availability completion and business close.
- c. Assists in developing pre business clearance, progressing Cost/Schedule Status Reports and participates in the Regional Calibration Center process.
- d. Provides incremental funds for ordering LLTM for both repair and alteration/modification work to meet required dates.

41.3.1.3 Quality Assurance Specialist. Supports the administration of the Contract Administration Quality Assurance Program to evaluate the effectiveness of the Contractor's Quality Management System on work being performed both shipboard and in the contractor's/subcontractor's plant.

- a. Accountable:
 - (1) Develops a Quality Management Plan for each CNO availability in accordance with Commander, Navy Regional Maintenance Center (CNRMC) Standard Operating Procedure (appropriate local instruction for SRF-JRMC).
 - (2) Reviews contract specification items to determine inspections/tests required, and PCPs for review (PR/PE/Program Quality Assurance).
 - (3) Verifies all critical tests and inspections associated with Level I work, Nondestructive Testing and critical welding such as P-1 piping.
 - (4) Reviews past contractor quality data (Quality Data Evaluation/PVI/Government and contractor generated corrective action reports) to support planned surveillance actions.
 - (5) Reviews submitted list of sub-contractors to be utilized to support identification of Defense Contract Management Agency notification requirements.
 - (6) Promulgates the Quality Assurance (QA) plan to the PT for use via the Project Manager.
 - (7) Participates in bid specification and work specification review with the PT supporting quality and technical requirements in accordance with invoked milestones. Provides feedback for incorporation into work specification requirements.
 - (8) Attends scheduled meetings, assesses contractor capabilities, monitors contract performance, provides technical support to the ACO, and participates in claims avoidance.
 - (9) Maintains a Significant Events Log. Provide a copy of the log to the contracting officer and PM at the completion of the availability.
 - (10) Completes Past Performance Information Surveys within 14 days of completing each availability and provides written reports to Contracts Department in support of Award Fee Evaluations and CPARS. Conducts Procedure Reviews for PCPs submitted by contractors.
 - (11) Maintains a copy of all Corrective Action Requests (CAR) generated by the Government, as well as those written by the contractor (when requested by the Government in accordance with NSI 009-04). Maintains a status of all CARs generated by the Government and updates the Project Manager.
 - (12) Informs Project Managers of quality problems that are, or have the potential to, affect their ship.
 - (13) Accomplishes Ship's Force QA Interface training prior to each CNO availability.
 - (14) Assists Shipbuilding Specialist, as functional responsibilities permit, in the coverage of G-Points.
 - (15) If, in the course of evaluating the prime contractor, AIT non-conformities are discovered, they are to be addressed to the Project Manager. If it is determined that the non-conformity warrants the issuance of a Government CAR, and the AIT manager/On-Site Installation Coordinator does not issue the CAR to the AIT, the RMC QA department shall notify NAVSEA 04XQ detailing the Government sponsor information.

- (16) Performs 100% final preservation record review to support work certification at the end of the availability.
- (17) Accomplishes in-process reviews of contractor's test and inspection plan to ensure compliance with NAVSEA Standard Item requirements.
- (18) Reviews and oversight of PCP, UPCP.

b. Responsibilities:

- (1) Provides quality assurance, quality control support of AEGIS Light Off, combat systems light off, propulsion plant light off, production completion date, Fast Cruise, Dock Trials and Sea Trials.
- (2) Provides quality oversight of AIT and AIT management
- (3) Provides quality oversight and input of business close, technical close.
- (4) Provides quality oversight and review and condition report submission.
- (5) Provides quality review of services request.
- (6) Provides quality oversight of AWP, LMA, I-Level collection and management of OQE.
- (7) Provides quality oversight of the Integrated Test Plan Execution.
- (8) Provides quality oversight of LMA Checkpoint Execution (V, G, I), and (PVI, PE, PR).
- (9) Provides quality control oversight of work certification.
- (10) Provides quality oversight of all work specifications Face to Face reviews.

41.3.1.4 NSA Logistical Representative. Responsible for supporting the configuration management of a ship and validating configuration of the ship following modernization efforts.

- a. Monitors the configuration management process.
- b. Ensures timely action on submittal of configuration change requests and follows up to update configuration records and associated logistics support.

41.3.1.5 SEA 21 Hull, Mechanical and Electrical and AEGIS Combat Systems On-Site Logistician (Surface Force Ships only). Accountable to ensure that all equipment has proper logistics support completed and available for delivery at the time of installation.

- a. Researches, documents and coordinates delivery of all ILS in support of combat system material readiness to the ship.
- b. Arranges storage and transportation of parts and equipment. Performs inventory audits of installation kits. Assists in the expediting of parts throughout the availability.
- c. Provides applicable logistics data to project engineers end of availability report.
- d. Provides assessment data, near real time, into ship's CSMP.

41.3.1.6 Project Support Engineer. The Project Support Engineer is a critical part of availability certification and will work closely with the Project Manager and Chief Engineer to help certify the availability.

- a. Accountable: Provides engineering/technical services during availability planning. The services include:
 - (1) Reviews of contractor work specifications ensuring the requirements of tasking documents are met, naval standards are invoked, and final acceptance testing will validate work performed.
 - (2) Attends all pre-availability planning meetings, assuming a leading role in addressing technical issues and coordinating resolution of technical authority issues.
 - (3) Maintains a records system of tasking documents, 2-Kilos, temporary DFS, a listing of specifications reviewed and documented comments forwarded for correction.

- (4) Coordinates resolution of technical issues during availability execution (i.e., DFS, Condition Reports, Liaison Action Requests).
- b. Provides engineering/technical services in support of ongoing waterfront production work at private contractor facilities. Serves as the principal point of contact for all engineering related technical issues between the Fleet Technical Support Divisions, the PT and other outside commands. These services include:
 - (1) Provides oversight of the contractor's technical performance of shipboard work for compliance to contract specifications.
 - (2) Provides oversight of contractor's quality assurance management program for technical documents and data.
 - (3) Provides oversight of contracted Original Equipment Manufacturer technical representatives.
 - (4) Provides technical evaluation and recommendations for contractor change proposals, growth and new work.
 - (5) Serves as the PT's technical authority point of contact. Assigned to resolve all technical issues, adjudicate non-conformances, DFS, waivers and deviations and provides for technical responses to contractor condition reports.
 - (6) Provides oversight of assigned planning yard on-site field personnel responsiveness and technical adequacy.
 - (7) Reviews and approves or disapproves contractor prepared PCP used to provide contractor mechanics guidance for accomplishment of critical repair processes.
 - (8) Initiates Liaison Action Request to document changes or questions to NAVSEA installation drawings.
 - (9) Technical point of contact for analyses during final acceptance testing, certifications and technical inspections.
 - (10) Attends all production meetings to assist and advise the PT in all matters concerning the repair and modernization of shipboard systems and equipment.
 - (11) Provides coordination for the ship availability technical closeout documents to ensure all technical related documents have been properly answered and/or adjudicated.
- c. Participates as a member of the Maintenance Control Team.

41.3.1.7 Integrated Test Engineer. The Integrated Test Engineer is a critical part of availability certification and will work closely with the Project Manager and Chief Engineer to help certify the availability.

- a. Approves and provides oversight of the contractor's development and management of the ITP. Ensures the ITP is functionally linked to the Integrated Production Schedule. Ensures the ITP is responsive to changes in production schedule such that when production items completion dates change, their associated test dates change as well. Ensures the ITP includes all testing for all maintenance activities.
- b. Reviews work specification to ensure appropriate work to test relationships have been developed.
- c. Reviews AWP to identify testing key events and milestones that may be required in addition to production key events and milestones (i.e., Aviation Certification and Combat Systems Command, Control, Communications and Computer Readiness Assessment).
- d. Coordinates with Project Manager to ensure the ITP accurately reflects the AWP and the integrated production schedule.
- e. Coordinates with the Program Executive Office in accordance with CSPE and Test Coordinator (if assigned) to provide information and status as required.

- f. Acts as the Governments primary point of contact to collect scheduling and testing information from all non-LMA maintenance activities including AITs, Fleet Maintenance Activity, In Service Engineering Agent (ISEA) and NSY. Provides this information as Government Furnished Information to LMA for inclusion into the Integrated Schedule and ITP.
- g. Acts as Government point of contact to coordinate Ship's Force testing schedule and major training evolution schedule information. Provides this information as Government Furnished Information to LMA for inclusion into the Integrated Schedule and ITP.
- h. Evaluates Test Sequence Networks provided by each maintenance activity prior to submitting to the LMA. Evaluates Integrated Test Sequence Networks provided by LMA.
- i. Ensures the Integrated Testing Schedule is updated at least weekly or as milestones and growth work changes dictate.
- j. Receives OQE for completed test procedures from all maintenance activities and evaluates results for completeness and accuracy. Ensures non-conformances are documented and action is taken to resolve or technically adjudicate.
- k. Serves as Government representative on Total Ship Testing Task Group as outlined in NAVSEA Standard Item 009-67.
- l. Provides a final report at the completion of the availability showing completion of all testing, or tests that remain unexecuted with exception reasons and plan for completion.
- m. Ensures the availability of special instrumentation, recording devices, support services, test ranges and data collection requirements to support Sea Trials events. Approves the LMA input to the Sea Trials agenda for submission to Ship's Force, ensuring all test procedures with underway requirements are properly scheduled.
- n. Participates as a member of the Maintenance Control Team.

41.3.1.8 Assessment Director. Leader of assessment execution. Provides management of military personnel, Government engineers and technicians, contractors, data entry personnel and logisticians in support of assessment program visits and events. Plans, schedules, organizes, directs and manages the execution of Total Ships Readiness Assessment visits and CMP assessment events.

- a. Accountable:
 - (1) Attends the AWP turnover with SURFMEPP and TYCOM managers to ensure visibility, resource allocation and scheduling of all CMP assessment tasks.
 - (2) Augments/assists the PT in CMP assessment accomplishment.
 - (3) Updates the PT on progress in meeting established milestones and deadlines for completion of assignments, projects and tasks, and ensures all team members are aware of and participate in planning for achievement of team goals and objectives.
 - (4) Manages dedicated Visit Support Team performing logistics validation, data entry and data collection support functions.
 - (5) Utilizes data provided by the Fleet Technical Assist (typically RMC Code 200) personnel to assist the Maintenance Team in documenting, completing and closing CMP assessment requirements.
 - (6) Assists Ship in achieving Maintenance Phase Exit Criteria through execution of Assessments.
- b. Responsibilities: Participates in CSMP/DFS/BAWP mid-cycle review and life cycle planning conference. Provides open and inspect oversight for screening potential repair.

41.3.1.9 Technical Matter Expert. The Technical Matter Expert is the Maintenance Control Team leader and acts as the principle assistant to the NSA for non-nuclear propulsion plant work. Accountable as owner of the work and the person who makes the final decision on a task and has the ultimate ownership over that task.

- a. Provides technical guidance in the execution of Controlled Work Packages.

- b. Reviews any revisions for technical adequacy. Verifies and provides recommendations in support of administrative changes. Represents the Government during selective check-points, to include testing, and acts as the RMC Chief Engineer's representative.
- c. Participates as a member of the Maintenance Control Team.

41.3.1.10 Shipbuilding Specialist. Shipbuilding Specialists are individuals that possess a primary trade background but effectively perform across trade lines in two or more trade skill disciplines. Team assignments are made to balance trade expertise appropriately with the type of work in the project. A wide variety of comprehensive duties and responsibilities are assigned to these individuals who are expected to act as decision makers with comprehensive knowledge of each work item assigned. Typical assignments include the following duties and responsibilities (as with Project Managers, this may vary depending on the supporting organization):

- a. Accountable:
 - (1) Provides current information relating to assigned work items to the Project Manager (see Volume VII, Chapter 7, paragraph 7.3.4a. of this manual).
 - (2) Attends meetings, resolves production problems, develops scope of work requirements, assists in the development of Government TARs and negotiation positions, assesses contractor capabilities, work progress and performance, provides technical support to the ACO, and participates in claims avoidance and provides other technical support as required (see Volume VII, Chapter 7, paragraph 7.3.4b. of this manual).
 - (3) Interfaces with members of the Ship's Force to provide current project information, notifies responsible personnel of scheduled evolutions and solicits required or desirable Ship's Force (see Volume VII, Chapter 7, paragraph 7.3.4c. of this manual).
 - (4) Receives and investigates contractor reports, assists with the development of the Government's technical response, requests engineering support, prepares necessary contract modifications, develops the Government cost estimates, estimates the delay and disruption that may occur because of a contract modification, assists with negotiation preparation relative to TARs and contract modifications (as authorized by the ACO), provides the ACO support in negotiations and maintains records of actions taken (see Volume VII, Chapter 7, paragraph 7.3.4d. of this manual).
 - (5) Performs and witnesses Government "G" notification points, identified in the work specifications, when the contractor calls them out. Accomplishes random PVIs utilizing checklists or an attribute system to determine contractor compliance with the quality and technical requirements of the work specifications/contract. Writes a Corrective Action Request when nonconformities are detected in accordance with Chapter 11 of this volume (see Volume VII, Chapter 7, paragraph 7.3.4e. of this manual).
 - (6) Determines the physical progress, as a percentage of work completed, of each work item and each contract modification assigned. Updates this information weekly in a comprehensive progress report that is used in calculating the contractor's entitlement to progress payments as well as in evaluating the contractor's schedule performance (see Volume VII, Chapter 7, paragraph 7.3.4g. of this manual).
 - (7) Monitors the GFM and Contractor Furnished Material report to anticipate actions that may be necessary to preclude schedule impact by unsatisfactory material delivery dates. Initiates material orders to replace unsatisfactory GFM or to provide items with unique Government control and confirms the necessity for the contractor to make cash purchases from the Naval Supply system when it is in the best interest of the Government (see Volume VII, Chapter 7, paragraph 7.3.4h. of this manual).

- (8) Monitors the contract guarantee period to help determine whether failure of equipment or systems covered by the guarantee clause is the responsibility of the Government or the contractor, ensures that the work determined by the ACO to be the responsibility of the contractor, whether it is covered by guarantee or was an exception to the completion of the contract, is repaired in accordance with the specification requirements and provides cost estimates for incomplete work so that the ACO can ensure that appropriate contract funds are retained in the event that the work must be deleted from the contract requirements or be procured from another contractor (see Volume VII, Chapter 7, paragraph 7.3.4i. of this manual).
 - (9) Provides positive lessons learned along with feedback related to deficient or inefficient work specifications or work authorizations to the appropriate planning group for use in improving future procurements (see Volume VII, Chapter 7, paragraph 7.3.4j. of this manual).
 - (10) Conducts oversight coordination and inspection of work-related environmental issues associated with Ship's Force and contractor's operations. This effort includes but is not limited to Hazardous Material and Hazardous Waste handling, removal, storage, transportation and disposal (see Volume VII, Chapter 7, paragraph 7.3.4k. of this manual).
 - (11) Provides input to the Project Manager to support Award Fee Evaluations and CPARS (see Volume VII, Chapter 7, paragraph 7.3.4n. of this manual).
 - (12) Maintains the following records: (see Volume VII, Chapter 7, paragraph 7.3.4o. of this manual)
 - (a) Significant Events Log.
 - (b) Work item specifications, references and estimates for the work package, updated to reflect all modifications.
 - (c) Contractor condition reports including Government replies.
 - (d) New work identified and not authorized.
 - (e) GFM delivery status.
 - (f) Records relating to the contractor's capabilities and capacity.
 - (g) Contractor performance evaluations.
 - (h) Supports LMA collection and management of AWP OQE.
 - (13) In the course of evaluating the prime contractor, report any AIT non-conformities to the Project Manager.
- b. Responsibilities:
- (1) Provides quality oversight to support propulsion plant, AEGIS and combat systems light off.
 - (2) Provides quality oversight of availability completion.
 - (3) Provides support of Business Case Analysis for new work.
 - (4) Reviews condition report submissions and responses.
 - (5) Coordinates consolidated software delivery.
 - (6) Provides quality oversight supporting Fast Cruise, Dock Trials, Sea Trials Docking and Undocking.
 - (7) Reviews Engineering Services Request.
 - (8) Provides quality oversight of Integrated Test Plan execution.
 - (9) Participates in quality check points supporting oversight of contracted work, PVI, PE and PR.
 - (10) Provides quality oversight of open and inspects.

- (11) Provides quality oversight of the Regional Calibration Center process.
- (12) Participates in work certification.
- (13) Conducts work specification review.

41.3.1.11 AIT On-Site Installation Coordinator. The AIT On-Site Installation Coordinator is the Government or military employee designated by, and acting with, the authority of the AIT Manager on-site.

- a. Provides the ship with: (see Chapter 3, paragraph 3.3.2 of this volume)
 - (1) All ILS equipment (including on-board spares) and documentation.
 - (2) Ship's Selected Records documentation.
 - (3) A complete set of installation drawings red-lined to indicate all variances.
 - (4) Hard copy Coordinated Shipboard Allowance List pages.
 - (5) A copy of the completion message.
- b. Performs additional duties as required by Appendix H of reference (a).

41.3.1.12 AIT Manager. The AIT Manager is the Government activity, ISEA, military person or Government civilian tasked and funded by the AIT Sponsor to initiate, fund, plan, coordinate, schedule, manage and oversee the successful accomplishment of the alteration/ship change.

- a. Coordinates with the NSA to ensure satisfactory completion of alterations. (See Volume II, Part I, Chapter 2, paragraph 2.1.1 of this manual.)
- b. Identifies support, schedule, and impact requirements according to required milestones. (See Volume II, Part II, Chapter 2, Appendix D of this manual.)
- c. Tasks and funds SID Development according to milestones. (See Volume II, Part II, Chapter 2, Appendix D of this manual.)
- d. Develops and submits the Memorandum of Agreement. (See Volume II, Part II, Chapter 2, Appendix D of this manual.)
- e. Performs additional duties as required by Appendix H of reference (a).

41.3.1.13 Combat Systems Project Engineer (Surface Force Ships only). These specialists monitor the contractor's performance of work and testing in the combat systems work package. The CSPE provides expert advice in the anticipation, identification and resolution of problems that may occur during the maintenance, repair and alteration installation phases, as well as during the grooming and complex systems level testing phases. The CSPE takes a more active role by accomplishing duties similar to those of production controllers/ship surveyors/shipbuilding specialists in addition to those of electronics engineers or technicians for Combat Systems work items during an availability or project.

- a. Provides current information relating to assigned work items to the Project Manager. This may also include reports to the ship's assigned Port Engineer for Combat Systems (see Volume VII, Chapter 7, paragraph 7.5.4a. of this manual).
- b. Attends meetings to resolve production problems, develops scope of work requirements, assists in the development of TARs to support the Government negotiation positions, assesses contractor capabilities, work progress and performance, provides technical support to the ACO, participates in claims avoidance and provides other technical support as required.
- c. Interfaces with members of the Ship's Force to provide current project information, notifies cognizant personnel of scheduled evolutions, solicits required or desirable Ship's Force participation and provides technical advice.

- d. Receives and investigates contractor reports, writes and receives answers to Liaison Action Requests, provides interim answers to Test Problem Reports, assists in developing the Government's technical response to contractor requests, assists the TAR writer by providing engineering support and in developing the Government cost estimates, assists in preparing necessary contract modifications, estimates the delay and disruption that may occur because of a contract modification, and provides the ACO support in negotiations and maintains records of actions taken.
- e. Observes "G" POINTS for electronic systems and equipment identified in the work specifications when they are presented by the contractor, witnesses required equipment or system tests and accomplishes random in-process inspections (PVI) at the work sites to determine contractor compliance with the requirements of the specification. Documents the contractor's failure to satisfy contractual responsibilities.
- f. Determines the physical progress, as a percentage of work completed, of each work item and each contract modification assigned. Updates this information weekly in a comprehensive progress report that is used in calculating the contractor's entitlement to progress payments as well as in evaluating the contractor's schedule performance.
- g. Monitors the GFM and Contractor Furnished Material report to anticipate actions that may be necessary to preclude schedule impact by unsatisfactory material delivery dates. Assist the Fleet and Industrial Supply Center or RMC Material Department in visually identifying and verifying receipt of GFM. Initiates material orders to replace unsatisfactory GFM or to provide items with unique Government control and authorizes the contractor to make cash purchases from the Naval Supply system when it is in the best interest of the Government.
- h. Monitors the contract guarantee period to help determine whether failure of equipment or systems covered by the guarantee clause is the responsibility of the Government or the contractor. Ensures that the work determined by the ACO to be the responsibility of the contractor, whether it is covered by guarantee or was an exception to the completion of the contract, is repaired in accordance with the specification requirements. Provides cost estimates for incomplete work so that the ACO can ensure that appropriate contract funds are retained in the event that the work must be deleted from the contract requirements or be re-procured.
- i. Provides lessons learned and feedback related to deficient or inefficient work specifications or work authorizations to the appropriate planning group for use in improving future procurements.
- j. Maintains a Significant Events Log.
- k. Coordinates the efforts of the Master Ship Repair Agreement/Agreement for Boat Repair and each combat systems related AIT.
- l. Participates in the Lessons Learned Conference as appropriate.
- m. Provides written reports to support Award Fee Evaluations and CPARS.
- n. Manages Combat System alteration package and AIT work and facilitates integration with the NSA.
- o. Submits work candidates (2K-MAF) for industrial assistance required for AIT efforts.
- p. Submits work candidates (2K-MAF) for Attack Weapons Systems Element Assessment CMP task accomplishment and uncovered deficiencies.
- q. Ensures that lessons learned identified during availability LLCs are applied across the ship class.
- r. Provides Combat System and Command, Control, Communications, Computers and Intelligence (C4I) test requirements and schedules.
- s. Coordinates C4I schedules and installations, and manages the AIT execution activities.
- t. Provides Combat Systems and C4I reach back to Participating Acquisition Resource Managers and ISEAs.

41.3.1.14 SEA 21 Hull Manager (Surface Force Ships only). Primary SEA-21 waterfront Surface Combatant Modernization and Integration Representative for execution, engineering, logistic and programmatic support. Primary interface between PT and program office funded activities for all program alterations.

- a. Accountable:
 - (1) Coordinates with ISEA/Participating Acquisition Resource Manager to identify, document and resolve issues of possible concern to the program office as they relate to Navy Modernization Process alteration development or installation.
 - (2) Delivers material (LLTM and Kitted Materials) to Executing Activity.
- b. Responsibilities:
 - (1) Participates in CSMP/DFS/BAWP mid-cycle review.
 - (2) Ensures work supports availability completion.
 - (3) Ensures consolidated software delivery and ILS support.
 - (4) Attends IPTD, Docking, Arrival, Undocking, Departure and 25%/50%/75% review events/conferences.
 - (5) Participates in work certification.
 - (6) Participates in work specification review.
 - (7) Performs risk assessments and verifies deliverables to contractor (O, I, D work items and AIT Schedule Requirements).

41.4 PLANNING PROCESS SUPPORT (Augmentation outside of maintenance availabilities). Supplements both the Maintenance and PTs in the planning and execution of engineered maintenance (CMP, Planned Maintenance System), modernization (Letter of Authorization) and corrective maintenance (CSMP) from advanced planning through close out. Consists of the following members and others as needed:

- a. TYCOM representatives.
- b. Program Executive Officer representatives.
- c. CNRMC representatives.
- d. Systems Command representatives.
- e. SUPSHIP representatives.
- f. Planning Yard representatives.
- g. Carrier Planning Activity representatives.
- h. Submarine Maintenance Engineering, Planning and Procurement representatives (SUBMEPP).
- i. SURFMEPP representatives.
- j. RMC Technical and Logistical SMEs.
- k. RMC Class Team Leaders.

41.5 PLANNING BOARD FOR MAINTENANCE. A regularly scheduled meeting between the ship's Maintenance Team members and stakeholders (e.g., TYCOM, Immediate Superior In Command, planning activity, Ship's Program Manager, etc.) to discuss ship-wide maintenance issues. This forum provides a routine and regularly scheduled management review of current planned off-ship and organizational maintenance, CSMP and AWP quality and accuracy, future maintenance and modernization planning, work prioritization, work integration and fiscal concerns. The objective is to ensure clarity of intent for both the ship's efforts and the shore infrastructure with respect to total ship maintenance, operational schedules and other concerns affecting ship material readiness. While the frequency of Planning Board for Maintenance meetings may vary due to a ship's schedule, a minimum of one meeting per quarter is expected. The Planning Board for Maintenance is the forum for discussing all maintenance issues, including metrics that are currently used to measure the maintenance effectiveness of the ship and the performance of the ship's assigned Maintenance Team.

41.5.1 Business Rules. Each maintenance team will incorporate the following business rules.

- a. Ashore Ship's Maintenance Manager will be responsible for all Planning Board for Maintenance decisions.
- b. The frequency of the Planning Board for Maintenance meetings may vary due to a ship's schedule; a minimum of one meeting per quarter is expected.
- c. The meeting will be chaired by the Commanding Officer.
- d. The core Maintenance Team shall participate in the Planning Board for Maintenance. Other attendees may participate as required.
- e. The Ashore Ship Maintenance Manager will prepare the agenda and provide it to the Commanding Officer and core team members 48 hours in advance.
- f. The agenda provides a list of topic areas to be reviewed during the Planning Board for Maintenance. It does not require an exhaustive examination of each topic during the meeting. Rather the meeting can be used to report the results of detailed reviews, updates, problem investigations and analyses conducted by assigned teams outside of the Planning Board for Maintenance meeting.

41.6 WORKFORCE DEVELOPMENT PROGRAM (RMC ONLY).

- a. The Work Force Development (WFD) Program is designed as a vehicle for professionalizing the Surface Force Ship workforce. That objective is accomplished through a formal training and certification process that is robust, standardized and repeatable at each RMC. The intent is to support the professional growth of RMC maintenance community personnel and promote career progression opportunities that enhance the long-term prospects for individual work force members, while maximizing overall effectiveness of the maintenance community as a whole. The net result of the WFD Program is a capability that maintenance and modernization work performed at one RMC is both repeatable and standardized with identical maintenance and modernization work performed at any other RMC.
- b. CNRMC serves as the WFD Program sponsor. CNRMC also serves as the Curriculum Control Authority for all WFD training courses and curricula. Each WFD course is delivered via a training team and WFD training covers the vital skills necessary to execute quality Surface Force Ship maintenance and modernization work.
- c. The WFD Program is a requirement for the Surface Force ship contracted maintenance management workforce (except at SRF-JRMC).
- d. All WFD Program courses include comprehensive classroom training, position-specific case-studies and practical exercises, and a detailed Job Qualification Requirement (JQR). While JQRs for a given position may be accomplished outside of the associated formal WFD course (i.e., either before or after completing the course), final certification of each course graduate is not granted by CNRMC until each JQR task is completed.

41.7 INTEGRATED PROJECT TEAM DEVELOPMENT (Surface Force Ships only). The PT develops a shared understanding of the assigned project and processes and works to build the rapport and trust required to meet their goals. New members, as well as experienced members, benefit from learning activities which focus on team building and teamwork.

- a. The IPTD curriculum focuses on development and integration of the PT; development of availability expectations and success criteria; advance planning; development, reviewing, refining, validating and communicating key strategies; aligning all members of the integrated PT; process improvement; availability execution processes; and knowledge sharing.
- b. In developing, executing and aligning training, there are many methods and curricula available, at both the corporate level and the individual organization level, to increase team member effectiveness. The IPTD staff works with the PT leadership to identify needs and offer solutions to schedule and logistic questions, topic selection, speaker selection and best learning techniques for each IPTD. From facilitation of arranged topics to customized training programs, the IPTD Staff will continually meet the needs of the PT.

41.7.1 Program Events. The IPTD program is notionally conducted in five events prior to the availability start date and one mid-availability. IPTD events are outlined below:

- a. Planning Event. Transition ownership and responsibility for the final development of the AWP from the Advanced Planning Phase (SEA 21 - Surface Maintenance Engineering Planning Program (SURFMEPP) responsibility), to the Planning Phase (CNRMC - NSA/RMC responsibility). Review, update and identify risks.
- b. 50% P&E COST/50% 2-Kilo Lock for Firm Fixed Price Event. This event will be scheduled based on the Joint Fleet Maintenance Manual tailored milestone determined at the Planning event. The event focuses on work package development, project strategies and reviewing, updating and identifying risks.
- c. 80% P&E/WPIC COST/WPIC Firm Fixed Price Event. This event will be scheduled based on the Joint Fleet Maintenance Manual tailored milestone determined at the Planning Event. The primary purpose of this event is to conduct the WPIC.
- d. WPER. The primary purpose of this event is to conduct the WPER meeting.
- e. Availability Completion Conference (in Accordance with Volume II, Part II, Chapter 2, Appendix D of this Manual). The primary purpose of this conference is to conduct a detailed review of the work package executed during the CNO Availability, and identify Lessons Learned that can be utilized for revising work items and class standard work templates for future maintenance availabilities. Additionally, this conference will serve as the transition (CNRMC - NSA/RMC) back to Advanced Planning (SEA 21 - SURFMEPP) to commence the next cycle in the Fleet Response Plan.
- f. 50% Review – Regroup
 - (1) Midlife Avails: 50% Conference
 - (2) Std Avails: 50% Conference/TBD by PT
 - (3) 1 day duration
 - (4) Focus: Regroup, Refocus & Realign

VOLUME VI

CHAPTER 42

MATERIAL READINESS ASSESSMENT

REFERENCES.

- (a) NAVSEA S9081-AB-GIB-010 - Reliability Centered Maintenance Handbook
- (b) CSL/CSPINST 9010.5 - Total Ship Readiness Assessment (TSRA)
- (c) CNRMCINST 4790.2 - Submarine Regional Maintenance Center (RMC) Fleet Technical Support (FTS) Roles and Responsibilities
- (d) OPNAVINST 4700.7 - Maintenance Policy for U.S. Naval Ships
- (e) COMNAVSURFPACINST 4700.1A/COMNAVSURFLANTINST 4700.1/CNRMCINST 4700.7 - Total Ship Readiness Assessment (TSRA)

LISTING OF APPENDICES.

- A Assessment Process
- B “Prerequisites and Test Requirements” Message (Example)
- C “Readiness to Commence” Message (Example)
- D “Completion Quicklook” Message (Example)
- E Job Originator Identification Table

42.1 PURPOSE. To maintain units in a material condition that supports the required degree of operational readiness and the ability to accomplish assigned missions using a process designed to assess the right things at the right time with the right people using the right standards at the right cost. This process applies to all activities (e.g., Type Commanders (TYCOM), Regional Maintenance Centers (RMC), shipyards, System Commands, etc.) executing periodic material assessments (scheduled event) and focused system assessments (not a scheduled event) of key systems, equipment and programs that follow an established framework and methodology. When evaluating material condition, either partially or in its entirety, the material assessment Common Assessment Procedures or approved technical documentation, shall be used and the results properly documented in accordance with this chapter via Automated Work Notifications (2-Kilo) to include material assessment tasks, (e.g., Condition-Directed Maintenance Tasks from the Class Maintenance Plan) and any discrepancies. The desired outcome of the assessment process is identification and documentation of required work to maintain adequate material condition. Appendix A provides an outline of the Assessment Process. In addition, this process applies and shall be followed for the material evaluation piece of inspections, certifications, and visits (e.g., Board of Inspection and Survey (INSURV), Afloat Training Group, Safety Center, etc.) as defined below:

- a. **Assessment:** A material assessment is part of the ship’s Reliability Centered Maintenance (RCM) plan conducted by Unit personnel or by an external agent (e.g., Command, Control, Communications, Computers and Combat Systems Readiness Assessment (C5RA)/Total Ship Readiness Assessment (TSRA)). Depending on the context, material assessments may be individual “tasks” or “events” that group together numerous individual material assessment tasks for accomplishment during a period of time in the ship’s operational schedule. Discrepancy documentation will be in accordance with this chapter.
- b. **Certification:** A certification is regulatory and is required at some periodicity to authorize operation of equipment or systems (e.g., Flight Deck Certification/Aircraft Launch and Recovery/Magazine Certification). Often, continued certification requires that some material assessments be accomplished or have been accomplished prior to certification. Results of a certification and their distribution will be in accordance with the associated certification’s instruction.
- c. **Inspection:** An inspection is an evaluation conducted by an internal or external activity with regards to the performance of equipment, systems, programs or functions to a recognized standard (e.g., Diesel/Boiler/INSURV/3-M). Depending on the evaluation plan, this may involve judging the material condition of equipment or systems. Results of an inspection and their distribution will be in accordance with the associated inspection’s instruction. Generally, results of the inspection will be provided to the unit’s superior and/or higher authority.

- d. Visit: A visit is the response to a request to provide technical assistance (e.g., NAVSAFECEN Visit). The technical assistance visit may or may not involve performing a material assessment. Required reports and their distribution from visits will be in accordance with the technical representative's organization's standard operating procedures.
- e. Reliability Centered Maintenance: A methodology to develop or revise a maintenance approach with the objective of maintaining the inherent reliability of the system or equipment, recognizing that changes in inherent reliability may be achieved only through design changes.
- f. Common Assessment Procedures: Common assessment procedures are assessments that, to the maximum extent possible, are common across platforms and serve all users for assessments, inspections and certifications. Common assessment procedures are RCM applicable and effective maintenance procedures that can be properly and consistently executed. They deliver accurate assessment and measurement of, determine and document discrepancies to, and specify repairs required to restore satisfactory material condition. Common assessment procedures satisfy the needs of work definition, inspections and certifications in a common document used both across ship classes and by all activities. The two types of commonality invoked are common across functional use and common across platforms with similar systems and equipment.

42.2 APPLICABILITY. This policy applies to all material condition assessments conducted on surface force ships, submarines, aircraft carriers, service craft and afloat/ashore activities under the cognizance of United States Fleet Forces Command and Commander, Pacific Fleet (e.g., Pre-Availability Testing, Point of Entry Testing, Common Assessment Procedures, TSRA, C5RA, Boiler Inspection, Diesel Inspection, etc.). This policy does not apply to the following special categories:

- a. Reactor and Primary support systems under Naval Sea Systems Command 08 cognizance.
- b. Fleet Ballistic Missile systems under the cognizance of Director, Strategic Systems Program.
- c. Naval aircraft and avionics equipment.
- d. Post repair testing (e.g., hydrostatic test, Non-Destructive Testing, etc.).
- e. Operational examinations (e.g., Tactical Readiness Examination, Pre-Overseas Movement certification, etc.).

42.3 OBJECTIVES. The principal objectives are:

- a. Identify and document system/equipment deficiencies.
- b. Improve unit's material readiness at the equipment/systems level.
- c. Identify and define work for upcoming maintenance availabilities.
- d. Standardize how the fleet conducts material assessments.
 - (1) Certifications, inspections and visits tasks shall use common assessment procedure standards and criteria in judging material condition.
 - (2) Assessments use standardized detailed procedures to determine material condition.
- e. Identify material assessment training deficiencies and document any deficiencies using a Work Notification (2-Kilo). Conduct over-the-shoulder training for unit personnel.
- f. Identify deficiencies with the Class Maintenance Plan (CMP) and document deficiencies using a Work Notification (2-Kilo).
- g. Identify deficiencies with configuration or configuration data using Maintenance Figure Of Merit (MFOM)/Mission Readiness Assessment System.

42.4 PRINCIPLES. The critical success factors for a single integrated, effective material assessment process are:

- a. Assessment procedures produced using a common assessment procedure development process based on RCM principles as discussed in reference (a).

- b. Assessment procedures standardized to the maximum extent possible and identified in the CMP.
- c. A standardized assessment tool set used to plan, execute and report assessments.
- d. Assessment results recorded in a common shared data warehouse.
- e. Accomplished using a common material assessment process, as defined below.
- f. Assessment process has an effective method of feedback for periodic reviews and analysis for improvements.

42.5 MATERIAL ASSESSMENT PROCESS.

42.5.1 Discussion. The primary focus of the material assessment process is to coordinate and integrate the various Navy material assessment processes into a single, integrated, effective process designed to evaluate, measure and report individual unit's material condition. This information will be used to improve fleet readiness, ship design, maintenance and modernization identification, as well as the self-assessment capabilities of fleet units. Activities performing assessments are encouraged to communicate with each other to avoid duplicate work. Additionally, the assessment process will provide data to help determine a unit's ability to reach its expected hull life, measure the effectiveness of the CMP and identify potential crew training deficiencies. (Submarines only) References (b) and (c) are applicable to all performing submarine material and maintainability readiness assessments.

42.5.2 Material Assessments. Units will undergo assessments per the CMP and as scheduled by the TYCOM. Systems and equipment are selected for assessment based upon:

- a. The CMPs.
- b. Ship Class trends.
- c. Unit requests.
- d. Review of the Current Ship's Maintenance Project (CSMP).
- e. Maintenance Team inputs.
- f. Integrated Condition Assessment Systems (ICAS)
- g. Integrated Performance Assessment Reports
- h. Corrosion Control Information Management Systems
- i. Master Assessment Index

42.5.2.1 Submarine TSRA Material Assessments. Reference (b) is applicable to TYCOM managed activities with responsibility to perform submarine material and maintainability readiness assessments. Reference (c) is applicable to Commander, Navy RMC managed activities with responsibility to perform submarine material and maintainability readiness assessments.

42.5.2.2 Surface Force TSRA Material Assessments. TSRA visits are nominally two weeks in duration. However, at the discretion of the TYCOM, TSRA events may be scheduled for more or less than two weeks in order to avoid conflicting with operational schedules. When the TSRA event is scheduled for less than two weeks, the focus of the TSRA will be identification and documentation of systems deficiencies.

42.5.3 Assessment Authorizing. The Platform Program Manager develops the CMP requirements as outlined in reference (d), and provides the requirements to the Platform TYCOM, who develop the assessment work packages and initiate assessments via "go assess work notifications" (GA2-K). Many factors determine what items will be selected for assessment, including the level of risk, funding constraints, ship's availability and ongoing maintenance and modernization. RMCs are tasked by Commander, Naval Sea Systems Command to support surface ships under the cognizance of Commander, Naval Surface Force Atlantic and Commander, Naval Surface Force Pacific to plan and execute TSRA's.

- a. The CMP contains two types of assessment notifications that may influence the agenda:
 - (1) Scheduled assessments.

- (2) **Unscheduled “As needed” or “pulled assessments” (“Go Assess” maintenance notification).** The Go Assess maintenance notification (GA2-K) identifies the equipment and the associated assessment procedure which shall be used.
 - b. Individual material assessments (not more than five assessment procedures) may be scheduled outside of a scheduled assessment event or availability if they can be planned and coordinated on a not to interfere basis with the unit’s combined schedule (operational and maintenance). A larger number of assessments or assessment events require additional planning, integrated scheduling and project management (e.g., C5RA, TSRA, Carrier Material Assessment Team, etc.). In this case, a maintenance availability should be used or added to the ship’s schedule. These assessment notifications are screened and brokered to the appropriate executing activity.
 - c. All material assessments are scheduled in accordance with the CMP and should not be repeated or duplicated by multiple activities. Assessment results shall be shared and used by multiple activities.
 - d. Surface Force TSRA’s will include comprehensive assessments of ship’s Hull, Mechanical and Electrical, combat systems, Command, Control, Communications, Computers and Intelligence systems, support equipment and logistics condition per reference (e). TSRA’s are tailored material assessment packages scheduled to occur at specific times during a ship’s schedule to improve maintenance availability planning, CSMP management, equipment repair, Ship’s Force technician proficiency and operational availability. The Master Assessment Index process is used by Surface TYCOM as a risk prioritization model to assist in the development of the TSRA agenda.

42.5.4 Assessment Planning. For scheduled material assessments or events, the Executing Activity identifies a Team Leader and develops the execution plan. The plan contains all of the necessary information required to complete the assigned tasks and should be integrated with the unit’s schedule. Conduct assessments using the applicable pieces of the standard assessment tool set. To facilitate planning and scheduling and avoid redundancy, assessments may be consolidated into a material inspection. Deficiencies identified during other major ship inspections and assessments such as C5RA’s shall be incorporated into the final INSURV inspection report if the assessment was conducted within 60 days of the scheduled material inspection or as negotiated between INSURV and the TYCOM. Although deficiencies generated during the assessment will become part of the final INSURV report, these deficiencies will be annotated as “corrected”, where applicable. The TYCOM will document this linked event by message request to INSURV, cognizant RMCs and the affected unit nominally four months prior to the scheduled material inspection. INSURV will evaluate the request and determine the scope and applicability of the linkage.

42.5.5 Assessment Execution.

- a. Work with the unit’s personnel to assess, analyze and document the material condition in accordance with standard procedures. Maintain good communications with all levels of unit personnel. Train unit personnel in assessment procedures and techniques.
- b. The assessment includes validation of equipment configuration, evaluation of the maintenance periodicity and effectiveness, evaluation of the assessment periodicity.
- c. Documentation of assessment results by the equipment Subject Matter Expert (SME) will include all required data. A maintenance ready work notification (2-Kilo) that is sufficiently defined, contains correct and complete information, provides an accurate diagnosis, and provides an applicable, effective and feasible recommended resolution. A properly validated maintenance ready work notification (2-Kilo) should allow the planning and executing activities the ability to understand the requirement and not to expend additional manpower or time obtaining needed information for any deferred maintenance, and completion of the assessment maintenance notification. All Unclassified Non-Nuclear Naval Propulsion Information/Naval Nuclear Propulsion Information assessment results and data will be handled in accordance with current regulations and standing guidance from NAVSEA 08.
- d. During Surface Force TYCOM TSRA assessments, repairs will be accomplished based on priority, availability of parts, Ship’s Force support, SME availability or time remaining in the TSRA.
- e. Conduct assessments using the Automated Work Notification software contained in Afloat Toolbox for Maintenance. This software is located in the MFOM Suite. All collected data is stored in the MFOM data warehouse.

- f. Certifications, inspections and visits shall document material deficiencies on an Automated Work Notification (2-Kilo) that at a minimum identifies the configuration item and adequately describes the symptoms and/or conditions that are below standards. For example, the 2-Kilo may identify that a specific component does not function properly and requests assistance to troubleshoot/diagnose system discrepancy. If the deficiency is clearly understood, the assessor is required to record what they know or understand the deficiency to be.

42.5.6 Assessment Reporting.

- a. The Executing Activity conducting the assessment should analyze assessment results and notify the Commanding Officer or his designated representative of any findings that could result in a Casualty Report, underway limiting or Repair Before Operate condition. The System Command (NAVSEA 05, SPAWAR 05 or NAVAIR) shall identify material improvement recommendations for new construction, future alterations or further analysis by the technical community.
- b. For Surface Force Ships, RMC shall send a Prerequisite and Test Requirements message per reference (e) at least three weeks prior to the start of the event.
- c. For Surface Force Ships, the ship shall send a Readiness to Commence message per reference (e) no later than five days prior to the scheduled event.
- d. Report assessment results using the standard assessment tool set:
 - (1) To include whether an assigned assessment procedure was completed, partially completed or not accomplished.
 - (2) To produce a maintenance ready work notifications (2-Kilo) for each discrepancy identified during the assessment. Determine with unit personnel their repair capability/capacity when recommending level of effort, (i.e., Organizational, Intermediate or Depot repair).
- e. To identify Integrated Logistic Support deficiencies and pass to TYCOM/Global Navy Distant Support to research and resolve, reporting any configuration discrepancies.
- f. To provide any procedure discrepancies, validation and periodicity feedback.
- g. To document man hours and costs.
- h. For Surface Force Ships, RMC shall send a TSRA Completion message per reference (e) no later than five business days after TSRA completion.

42.5.7 Standard Assessment Tool Kit.

- a. The standard assessment tool kit consists of:
 - (1) The catalog of approved assessments outlined in the ship's CMP. The procedure should be written in a format appropriate to the activity and experience of the personnel assessing (i.e., Maintenance Requirement Card for Unit personnel, Task Group Instruction for Naval shipyards, standard item for private shipyards, etc.).
 - (2) If an equipment or system assessment does not exist, one must be developed in accordance with the assessment technical guide and identified in the CMP.
 - (3) All assessments shall be planned, executed and reported using the Fleet approved assessment computer application(s) and the results recorded in the Fleet designated data warehouse.

42.5.8 Assessment Personnel.

- a. When assessments are conducted by the unit's personnel, they should be from a rating associated with the equipment being assessed (operationally knowledgeable) and should be experienced in conducting assessments.
- b. Outside activity personnel should be technically knowledgeable in the area they will be assessing and considered SMEs. Additionally, they should be trained on the assessment process, how to document the material condition of the equipment or system and basic RCM principles as discussed in reference (a).

42.6 RESPONSIBILITIES.

42.6.1 Fleet Commander. Fleet Commander shall:

- a. Maintain a common material assessment process and policy. Conduct periodic reviews of processes and procedures as recommended by TYCOMs and technical warrant holders.
- b. Be the Fleet's advocate and single point of contact for all material assessment issues to include:
 - (1) Policy.
 - (2) Training, assessment criteria.
 - (3) Procedures.
- c. Provide and support a standard material assessment tool set.
- d. Review the personnel and monetary resources required for the operation, improvement and support of the material assessment process and provide for these requirements in the budget effort.
- e. Establish minimum standards of continuous program improvements for the TYCOMs.

42.6.2 Type Commander. TYCOMs/Immediate Superior In Command shall:

- a. Schedule and authorize material assessments.
- b. Define the scope of material assessment.
- c. Provide funding for execution and support when not part of the mission funded executing activities Capabilities Plan.
- d. Conduct periodic reviews of the material assessment process.
- e. Establish standards of effectiveness to ensure continuous program improvement.
- f. Evaluate units ability to self assess and report training deficiencies to the appropriate activity.

42.6.3 Material Assessment Executing Activity. The Material Assessment Executing Activity shall:

- a. For RMC managed assessments, the RMC will send a Prerequisites and Test Requirements Message as directed by the TYCOM. Appendix B provides a sample message template. When requesting SMEs from another RMC for Assessment Events (TSRA, C5RA), the requesting RMC will fund travel and per diem expenses for government and military SMEs. For Surface Force Ships, use reference (e) sample message template and supplemental guidance for all TSRA events.
- b. Conduct unit pre-visit brief in order to affect maximum support for the visit.
- c. Assist the Assessment Team with access to the base and unit.
- d. Review documented system deficiencies. Determine system material condition using established test procedures and unit's input. Unit personnel shall be included in this process as a training effort.
- e. Task the Team Leader to provide daily progress reviews to unit assessment event coordinator.
- f. Determine, in concert with Unit personnel, the correct maintenance level (Operational, Intermediate, Depot) to correct deficiencies.
- g. Document man hours expended and assessment results using the standard assessment tool set and record the results of the "Go Assess" maintenance notification (GA2-K).
- h. Document assessment deficiencies via maintenance notification. Document follow-on repair or technical assist 2-Kilos by always starting the Block 35 narrative with the words "Per Job Control Number (JCN)", where '(JCN)' is the Assessment JCN that generated the repair or technical assist 2-Kilo followed by the characters "XX" (e.g., "Per YYYYYYEM01ZA56XX", where "YYYYYY" is the ship's Unit Identification Code and "XX" signifies a break between the JCN and the beginning of the 2-Kilo's text description). This methodology allows maintenance personnel to connect each follow-on repair or technical assist 2-Kilo to its initiating assessment.

- i. Establish configuration baseline (sight validation) of selected systems to upgrade logistics support documentation. Initiate configuration changes for direct input into the ship's maintenance management system.
- j. Assist unit personnel in repair and groom, as required, and as dictated by time/resource constraints and operational necessity.
- k. Assist unit personnel in identifying material requirements to effect repairs.
- l. Provide an out brief to the unit's Commanding Officer (or his representative), describing significant findings. Additionally, ensure all maintenance work notifications are loaded into the unit's CSMP and shore files complete and intact.
- m. For Surface Force Ships, RMC shall send a TSRA Completion message per reference (e) no later than five business days after TSRA completion.
- n. Support assessments as requested by the TYCOM.
- o. Initiate change recommendations for program improvement.
- p. Ensure all assigned personnel are experienced, knowledgeable and qualified as required.

42.6.4 Commanding Officer. Commanding Officers, as directed by the TYCOM, for scheduled assessments should:

- a. Prepare for assessments events in accordance with this instruction.
- b. Designate a senior management representative as the unit's assessment event coordinator.
- c. Send, as directed by the TYCOM, a Readiness to Commence assessment message no later than five working days prior to the scheduled start of the assessment event. Appendix C provides a sample message template. Reference (e) provides a sample message template for all TSRA events. Include contact information for the ship's coordinator and key unit personnel.
- d. Provide support for assessment team (e.g., ICAS data, access to specific spaces, electrical power and cooling water requirements, man aloft equipment tag-out and Radio Frequency radiation requirements, a secure space, Shipboard Nontactical Automated Data Processing Program/Legacy Organizational Maintenance Management System – Next Generation, Internet access and e-mail accounts).
- e. Prepare systems/equipment, tag outs, Work Authorization Form, request support services and generate Quality Assurance packages as required.
- f. Ensure there are no conflicting evolutions, training, drills, field days, major system overhauls or other events that would detract from the timely and efficient completion of the assessment event that have been planned or scheduled.
- g. Reschedule the preventive maintenance requirements that will be accomplished during the assessment event to eliminate redundant accomplishment if the assessment is scheduled to occur so that no greater than one-half (1/2) of the scheduled periodicity is exceeded.
- h. Host assessment event briefings.
- i. Ensure the 3-M Coordinator, Functional Area Supervisors and the Supply Officer (or representative) are available as needed during the Assessment.
- j. Ensure divisional personnel are assigned to work closely with the Assessment Team SMEs during testing and repair to maximize On the Job Training and awareness of identified equipment problems.
- k. Remove key maintenance personnel from the watch bill during normal working hours in order to improve efficiency of the assessment event.
- l. Correct material discrepancies as time permits.

- m. Send, as directed by the TYCOM, a Quicklook completion message within five working days following the completion of the assessment event. Appendix D provides a sample message template. Additionally, include in the Quicklook report feedback and recommendations to the TYCOM to support continuous improvement of the assessment event process.

NOTE: INDIVIDUAL MAINTENANCE ASSESSMENTS (NOT MORE THAN FIVE ASSESSMENT PROCEDURES) MAY BE SCHEDULED OUTSIDE OF A SCHEDULED ASSESSMENT EVENT OR AVAILABILITY. HOWEVER, THEY STILL NEED TO BE COORDINATED WITH THE SHIP'S SCHEDULE AND SHOULD NOT INTERFERE WITH OPERATIONAL REQUIREMENTS.

APPENDIX A
ASSESSMENT PROCESS

1. Assessment Background, Scope, and Organizational Responsibilities.
 - a. The Fleet Material Assessment Process provides comprehensive testing of equipment and/or system(s) to determine their current state of material readiness. The resultant data assists maintenance efforts to attain a high state of overall material readiness.
 - b. This document provides supplemental information to assist in the execution of a material condition assessment. This material assessment process does supersede or supplant other instructions or notices covering material assessment.
 - c. An SME may elect to conduct a material assessment procedure for the purposes of troubleshooting equipment and/or system(s) as part of a Fleet Technical Assistance.
 - d. Job Sequence Numbers will be assigned in accordance with Appendix E.
 - e. Only material assessment procedures currently identified in the CMP shall be used. If a material assessment is not in the CMP, the executing activity must process a Departure From Specification through the appropriate TYCOM and technical authority before it can be scheduled and performed.
 - f. A material assessment is part of the ship's RCM plan conducted by Unit personnel or by an external agent (e.g., C5RA/TSRA). Depending on the context, material assessments may be individual "tasks" or "events" that group together numerous individual material assessment tasks for accomplishment during a period of time in the ship's operational schedule.
2. Individual Material Assessment.
 - a. Scheduling and Preparing for an Individual Material Assessment.
 - (1) The term "Unit" applies to Ship's Force and shore personnel being assessed.
 - (2) Due to the simple nature of this type of assessment, requests will normally be accomplished through a Go Assess Maintenance Notification (GA2-K). The assessment may be requested by a unit's TYCOM, unit's Immediate Superior in Command (ISIC), Maintenance Team or by the unit itself.
 - (3) Once the assessment is scheduled, the SME assigned should ensure there will be proper support for performing the material assessment (e.g., tag-out, equipment operation, initial system conditions, material history, properly calibrated test equipment).
 - (4) If an assessment was scheduled more than two weeks in advance, the SME should make a courtesy phone call or send an email message as appropriate to ensure schedule changes have not occurred.
 - b. Conducting the Individual Material Assessment.
 - (1) Each Individual Material Assessment will have an in brief with the Commanding Officer or his designee. The in brief will include an agenda of the assessment, what procedures will be used to assess the equipment/system(s) and unit specific safety policies. Daily briefs will occur, as appropriate.
 - (2) Upon the completion of the in brief, the SME(s) will team with the unit's point of contact to begin the assessment. Benefits of this teaming arrangement include training of personnel and meeting all safety requirements. Training is part of the material assessment and unit personnel should be present during the assessment.
 - (3) In the event the assessment discloses significant equipment/system failure(s) that prevents completion of the assessment, the SME shall notify the Commanding Officer or his designee and coordinate repairs if appropriate.

- c. Completing the Individual Material Assessment.
 - (1) All material discrepancies will be documented on a maintenance notification (2-Kilo) and uploaded to the CSMP. The goal is to provide an uploadable file of all final discrepancies upon completion of the assessment but no later than five working days.
 - (2) The SME shall provide the Commanding Officer or his designee with an out brief. If requested by the unit, a formal final report of the assessment will be provided no more than 30 days after the conclusion of the individual assessment.
- 3. Assessment Availabilities.
 - a. Five or more concurrently scheduled assessments require additional planning, integrated scheduling and project management.
 - b. Preparing the assessment.
 - (1) The size and complexity of an assessment availability generally requires that it be scheduled as part of a maintenance availability or an individual event. All material discrepancies will be documented on a maintenance notification (2-Kilo) and uploaded to the CSMP. The goal is to provide an uploadable file of all final discrepancies upon completion of the assessment but no later than five working days.
 - (2) The unit should prepare and release the Readiness to Commence message no later than five working days prior to commencement of the assessment, if required by the TYCOM. Appendix C provides a sample format.
 - (3) The person designated to manage the Assessment Availability is referred to as the Team Leader or Assessment Director and his duties are as follows:
 - (a) Prepare and release the Prerequisites and Test Requirements message four weeks prior to the start of the assessment. Appendix B provides a sample format.
 - (b) Arrange for adequate work space and computer/network support.
 - (c) Ensure all members of the team are on the unit's access list.
 - (d) Work with the unit's maintenance team to ensure that the maximum benefit may be realized for the scheduled material assessments.
 - (4) Extend an invitation to the material assessment out brief to the appropriate TYCOM/ISIC and maintenance team.
 - c. Conducting the Assessment.
 - (1) The Team Leader/Assessment Director will:
 - (a) Perform the task listed in paragraph 2.a.(2) of this appendix.
 - (b) Conduct an in brief to ensure all assessment team members and unit personnel are given the latest guidance for the event.
 - (c) Verify the Standard Assessment tool kit is operational, that the proper configuration data is loaded and that the unit has provided the necessary computer network access (i.e., logins, passwords, accounts, etc.).
 - (d) Distribute appropriate technical documentation to conduct the assessment.
 - (e) Liaison daily or as required with the assessment team members to check on progress with their portion of the assessment.
 - (f) Conduct a daily brief of progress and report significant problem status with the Commanding Officer and/or designated staff.
 - d. Completing the Assessment.
 - (1) The Team Leader/Assessment Director will:
 - (a) Specify the time for final submission of assessment results.

- (b) Provide major findings that pose a threat to personnel safety or equipment (e.g., inoperative alarms or safety devices; readings exceeding the limits of the assessment that are deemed unsafe or excessive fuel/oil leaks).
 - (c) Provide minor findings which are defined as any finding not considered to be a major finding and poses no threat to personnel.
 - (d) Findings for material history which do not impact on equipment system operation.
 - (e) Any repairs performed.
 - (f) Any over-the-shoulder training in support of conducting the assessment.
- (2) The out brief will include:
- (a) Report major discrepancies.
 - (b) Report the system(s)/equipment for which testing was not attempted, testing not completed and configuration changes were needed.
 - (c) Results of logistics discrepancies.
 - (d) Discrepancies assigned for follow-on technical assistance.
- (3) Provide the ship with the draft Quicklook message within five working days of the completion of the assessment. A Quicklook message sample outline is provided as Appendix C.
- (4) All material discrepancies will be documented on a maintenance notification (2-Kilo) and uploaded to the CSMP. The goal is to provide an uploadable file of all final discrepancies upon completion of the assessment but no later than five working days.
- (5) The Team Leader shall provide the Commanding Officer or his designee with an out brief. If requested by the unit, a formal final report of the assessment will be provided no more than 30 days after the conclusion of the individual assessment.
- (6) When requested, provide special report(s) and/or brief(s) to the TYCOM, ISIC, maintenance team or designated representative(s) to facilitate repair of specific deficiencies.

(This Page Intentionally Left Blank)

APPENDIX B**“PREREQUISITES AND TEST REQUIREMENTS” MESSAGE (EXAMPLE)**

FM (RMC)
 TO USS (SHIP/SUB/CARRIER)
 (ISIC)
 (ADDITIONAL ADDRESSEES AS APPROPRIATE)
 INFO (APPROPRIATE TO SHIP/SUB/CARRIER)
 (ADDITIONAL ADDRESSEES AS APPROPRIATE)
 (TYCOMS ADDRESSEES AS APPROPRIATE)
 BT
 MSGID/GENADMIN/(RMC)//
 SUBJ/ASSESSMENT TASKING FOR USS (SHIP/SUB/CARRIER)//
 REF/A/RMG/(ASSESSMENT)/(REFERENCE)//
 REF/B/DOC/ASSESSMENT GUIDEBOOK/(DATE)//
 REF/C/DOC/(TEST PLAN PROVIDER IF APPLICABLE)/(DATE)//
 REF/D/CON/(SCHEDULING AUTHORITY)/(DATE)//
 NARR/REF A IS (ASSESSMENT REFERENCE). REF B IS ASSESSMENT GUIDEBOOK. REF C IS SHIP'S
 TEST PACKAGE, IF APPLICABLE, FOR USS (SHIP/SUB/CARRIER). REF D IS (SCHEDULING
 AUTHORITY).//
 POC/(LIST INFO AS APPROPRIATE)//
 RMKS/1. IAW REFS A THRU D, ASSESSMENT WILL BE CONDUCTED ONBOARD USS
 (SHIP/SUB/CARRIER) STARTDATE-ENDDATE YYYY.
 2. ASSESSMENT WILL PROVIDE THE FOLLOWING:
 A. READINESS ASSESSMENT OF SYSTEMS MATERIAL CONDITION.
 B. OVER-THE-SHOULDER MAINTENANCE TRAINING FOR SHIPBOARD
 PERSONNEL AS THEY PERFORM REQUIRED MAINTENANCE/CORRECTIVE ACTION.
 C. ENTRY OF MAINTENANCE READY 2-KILOS INTO THE CSMP AND A CSMP VALIDATION
 FOR SYSTEMS ASSESSED.
 D. (IF APPLICABLE) ASSESSMENT OF SHIP'S ELECTROMAGNETIC COMPATIBILITY POSTURE.
 E. (IF APPLICABLE) CONFIGURATION REVIEW OF COSAL/SNAP DATABASE AND INVENTORY
 OF TECHNICAL MANUALS FOR SYSTEMS/EQUIPMENT (ELECTRONICS ORDNANCE) BEING
 ASSESSED.
 F. (IF APPLICABLE) A SMALL ARMS READINESS REVIEW (SARR) IS OPTIONAL AND WILL BE
 CONDUCTED ONLY IF REQUESTED BY THE SHIP. THE SARR WILL HELP SHIP'S FORCE TO IDENTIFY
 POTENTIAL PROBLEM AREAS AND ENSURE QUALITY SMALL ARMS ARE ONBOARD FOR
 DEPLOYMENT.
 3. BRIEFS AND CLEARANCE DATA:
 A. PRE-BRIEF WILL BE CONDUCTED TO DISCUSS GUIDELINES, ESTABLISH REQUIRED
 SUPPORT, DISCUSS ANY TEST PLAN ISSUES AND REVIEW POSSIBLE CONFLICTING EVOLUTIONS.
 RECOMMEND ATTENDANCE BY CO, XO, DEPT HEADS, PRINCIPAL ASSISTANTS AND 3-M
 COORDINATOR.
 B. RECOMMEND KICK-OFF BRIEF BE HELD ON THE FIRST MORNING OF
 THE EVENT.
 C. ASSESSMENT DIRECTOR WILL PROVIDE DAILY PROGRESS UPDATES TO CO OR
 DESIGNATED REP.
 D. AN OUTBRIEF WILL BE CONDUCTED AT THE CONCLUSION OF THE EVENT.
 E. CLEARANCE DATA WILL BE PROVIDED BY SEPCOR.
 4. USS (SHIP/SUB/CARRIER):
 A. (IF APPLICABLE) RMC LOG REP WILL CONTACT SHIP FOR LOG DATA REQUIREMENTS
 PRIOR TO START OF ASSESSMENT.
 B. TRAINING IN MAINTENANCE PROCEDURES AND PRACTICAL APPLICATION OF ONBOARD
 TEST EQUIPMENT AND TOOLS FOR INSTALLED SYSTEMS IS CONDUCTED. (IF APPROPRIATE) FOR
 MAXIMUM BENEFIT, REQ ALL TECHS, SUPPLY SUPPORT PERSONNEL AND 3-M COORDINATOR BE
 AVAILABLE FOR DURATION OF EVENT.

C. (IF APPLICABLE) TO FACILITATE CRYPTO VOICE/DATA CKT TESTING, REQ LOAD ALL APPLICABLE CRYPTO PRIOR TO EVENT START.

D. (IF APPLICABLE) DUE TO LARGE NUMBER OF PERSONNEL BOARDING EACH DAY, REQ PROCESS BE ESTABLISHED TO EXPEDITE BOARDING ACCESS.

E. THIS ASSESSMENT IS NOT AN INSPECTION AND NO PRE-EVENT TESTING IS REQUIRED. CONTINUE NORMAL PMS SCHEDULE.

F. IAW REF B, REQ TRANSMIT "READINESS TO COMMENCE" MESSAGE NLT ONE WEEK PRIOR TO START OF THE EVENT.

G. (IF APPLICABLE) RMC 2-M FLEET COORDINATOR WILL REVIEW SHIP'S 2-M PROGRAM. REQ SHIP'S 2-M COORDINATOR PROVIDE MODULE TEST AND REPAIR TRACKING SYSTEM (MTRTS) DATA FOR THE LAST TWO QTRS.

H. REQ ADVISE EARLIEST OF ANY SCHEDULE EVOLUTIONS WHICH COULD IMPACT THE CONDUCT OF THIS EVENT.

5. (ISIC): REQ ADVISE ALCON NAME AND TELEPHONE NUMBER OF STAFF MEMBER DESIGNATED AS ISIC REP.

6. REQ ALL SUPPORT ACTIVITIES ADVISE ALCON NAME/CLNC LEVEL OF REP(S) PROVIDING SUPPORT.

(LIST AS APPLICABLE TO THE ASSESSMENT)

7. REQ ALL TEAM MEMBERS REPORT ONBOARD NLT (TIME), DD MMM YY TO MEET WITH THE ASSESSMENT DIRECTOR (AND AS APPROPRIATE) TO OBTAIN TEST PLANS AND CONTROL SHEETS.

8. FOR FURTHER INFO CONTACT (LIST POC E-MAIL ADDRESS). (RMC) STANDS READY TO SUPPORT ALL FLEET UNITS 24/7 THROUGH OUR COMMAND DUTY OFFICER: COMM (###) ###-####, DSN ###-####, UNCLASSIFIED E-MAIL (INSERT ADDRESS), CLASSIFIED E-MAIL (INSERT ADDRESS), AND BATTLE-CHAT SERVER (INSERT ADDRESS).//

BT

NOTE: ENSURE MESSAGES ARE IN ACCORDANCE WITH CURRENT MESSAGE FORMAT AND CURRENT PLAIN LANGUAGE ADDRESS DIRECTORY (PLAD) IS UTILIZED.

APPENDIX C

"READINESS TO COMMENCE" MESSAGE (EXAMPLE)

FM USS (XXX)
 TO (ISIC)
 INFO (AS APPROPRIATE TO ACTIVITY)
 BT
 UNCLAS
 MSGID/GENADMIN/USS XXX/-/OCT//
 SUBJ/READINESS TO COMMENCE (ASSESSMENT)//
 REF/A/DOC/TYCOM/YMD:2003XXXX//
 AMPN/XXX INSTRUCTION 9093.1J PROVIDED INSTRUCTIONS TO CONDUCT XXX//
 POC/XXX/LCDR/CMD/LOC:NORFOLK VA/TEL:XXX-XXX-XXXX//
 RMKS/FOLLOWING IS SUBMITTED IAW REF A:
 1. XXX ASSESSMENT SCHEDULED FOR: XXOCTOBERXX THRU XXOCTOBERXX.
 2. ASSESSMENT TEST PLAN NEGOTIATED DURING PRE-BRIEF ON XXOCTXX.
 COMMAND PREPARED TO SUPPORT ASSESSMENT EXCEPT FOR THE FOLLOWING
 CONFLICTING EVOLUTIONS:
 XXX INSPECTION XX-XX OCT XX
 FORCE PROTECTION/DIET DRILLS WITH DUTY SECTIONS-DAILY
 ALL HANDS TRAINING CONDUCTED WEEKLY.
 3. TEST EQUIPMENT: FOLLOWING TEST EQUIPMENT AT CAL OR REPAIR
 FACILITY. TEST EQUIPMENT SCHEDULED TO BE TURNED IN TO RMC
 PRODUCTION DEPT FOR CAL DURING WEEK OF XXOCTXX. EDD BASED ON
 SHOP LOADING:
 (LIST ALL APPLICABLE EQUIPMENT)
 4. PERSONNEL SHORTAGES/CRITICAL NEC
 RATE NEC NMP ONBRD REMARKS
 (LIST APPLICABLE BILLETS)
 5. THE FOLLOWING SYSTEMS HAVE HAD MAJOR AITS/UPGRADES WITHIN
 LAST 90 DAYS:
 SYSTEM TYPE OF WORK DATE COMPLETED
 (LIST ALL APPLICABLE EQUIPMENT)
 6. THE STATUS OF THE FOLLOWING:
 A. CURRENT ASI TAPES LOADED-823.
 B. CURRENT CRYPTO LOADED DAILY AT 0001Z.
 C. CURRENT SOFTWARE TAPES AVAILABLE IN ADP AND CS OFFICE.
 D. MESSAGES TO SUPPORT RADAR RADIATION, SONAR AND COMMS
 TRANSMISSIONS ARE IN PROGRESS. WILL COORDINATE WITH ASSESSMENT
 TEAM TO DETERMINE ACTUAL RADIATION REQUIREMENTS.
 E. KEYS FOR ORDNANCE ARE AVAILABLE.
 F. TEST EQUIPMENT (253) AND GAUGES (112) ARE IN CALIBRATION;
 WEIGHT TESTS AND CERTIFICATIONS ARE UP TO DATE FOR ORDINANCE
 HANDLING EQUIPMENT, STAR GAUGES, ETC.
 G. ULM-4 COMPLETED ON 10SEP07.
 H. TACAN HAS BEEN FAA CERTIFIED.
 I. OCSOT COMPLETED ON 30SEP07.
 7. LIST OF WORK CENTER 1ST/2ND POCS FOR SYSTEMS WILL BE
 PROVIDED AT 0900 IN-BRIEF ON 22OCT07 ON BOARD IWO JIMA.
 8. UNCLAS NETWORK ACCESS AND OUTSIDE PHONE LINE WILL BE
 PROVIDED IN CSMC.
 9. ALL PRE-ASSESSMENT PMS CHECKS HAVE BEEN COMPLETED.
 10. USS XXX IS READY TO COMMENCE ASSESSMENT ON XXOCTOBERXX.//
 BT

NOTE: ENSURE MESSAGES ARE IN ACCORDANCE WITH CURRENT MESSAGE FORMAT AND CURRENT PLAD IS UTILIZED.

APPENDIX D

"COMPLETION QUICKLOOK" MESSAGE (EXAMPLE)

FM (ASSESSMENT ACTIVITY OR USS)

TO (ISIC)

INFO (AS APPROPRIATE TO THE ACTIVITY)

BT

MSGID/GENADMIN/ASSESSMENT ACTIVITY OR USS/-/MAR//

SUBJ/QUICKLOOK REPORT FOR USS XXX MATERIAL INSPECTION (MI)//

REF/A/MSG/ASSESSMENT ACTIVITY/161402ZXXX04//

AMPN/REF A DOCUMENTS//

RMKS/1. AN ASSESSMENT WAS CONDUCTED ON USS XXX AT NAS NORTH ISLAND, CA DURING THE PERIOD XX-XX MAR 200X. CERTAIN DEFICIENCIES EXIST WHICH DEAL WITH THE XXX DEPARTMENT. THESE DEFICIENCIES ARE NOTED IN REF A.

2. SENIOR MEMBER COMMENTS:

A. THE SHIP WAS CLEAN AND WELL PREPARED FOR THE INSPECTION.

B. THE SHIP REPORTED A HISTORY OF XXX(SYSTEM AND DISCREPANCY).

C. THE RELIABILITY OF THE XXX SYSTEM IS SUSPECT. DURING THE COURSE OF THE INSPECTION, XXX WERE INOP DUE TO A NUMBER OF MATERIAL DEFICIENCIES AND XXX WERE INOP DURING THE DTE. THE SHIP HAS A MATERIAL HISTORY FILE THAT INDICATES A RECORD OF POOR RELIABILITY WITH XX CASUALTIES, INCLUDING XX CASREPS, DOCUMENTED OVER A PERIOD OF XXX DAYS. MANY OF THE CASREPS ARE RELATED TO PARTS NOT IN STOCK OR NOT CARRIED.

D. THE CONDITION OF THE DISTRIBUTED ELECTRICAL SYSTEM OUTSIDE OF THE XXX SPACES IS OF CONCERN. NUMEROUS UNLABELED/MISLABELED CIRCUITS, OVERSIZED/UNDERSIZED PROTECTIVE DEVICES, AND OTHER SAFETY DEFICIENCIES WERE NOTED.

E. TOPSIDE CORROSION, ESPECIALLY ALONG THE CATWALKS AND UNDER SPONSONS, WAS NOTED. THE SERIOUSLY DETERIORATED MAIN SPACE INTAKE PLENUMS SHOULD BE ADDRESSED IMMEDIATELY.

F. THE SHIP HAS NEVER HAD A COMPLETE OIL POLLUTION ABATEMENT SYSTEM (SPECIFICALLY AN OILY WATER SEPARATOR AND OIL CONTENT MONITOR) INSTALLED AND CONSEQUENTLY CANNOT COMPLY WITH EXISTING ENVIRONMENTAL PROTECTION LAWS. THE SHIP HAS ROUTINELY USED SPACE EDUCTORS TO REMOVE BILGE WATER WHILE AT SEA.

G. MINIMUM ACCEPTABLE EQUIPMENT FOR UNDERWAY OPERATIONS WAS ACHIEVED AT 1100 ON DAY TWO OF INSPECTION.

H. THE SHIP'S SELF-ASSESSMENT CAPABILITY WAS EVALUATED AS SATISFACTORY.

I. THE SHIP'S ABILITY TO RESOLVE SIGNIFICANT MATERIAL ISSUES DURING THE INSPECTION WAS EVALUATED AS SATISFACTORY.

3. THE FOLLOWING CASREPS WERE ACTIVE PRIOR TO THE MI:

NUMBER	NOMENCLATURE	CATEGORY
04XXX	XXXX	2
04XXX	XXXX	2
04XXX	XXXX	2

4. DEMONSTRATION RESULTS: SAT (0.80 - 1.00)/DEGRADED (0.60 - 0.79)/UNSAT (0.00 - 0.59):

- THE SELF-DEFENSE DTE WAS UNSAT (SCORE: 0.58) BECAUSE OF REDUCED DETECTION RANGES ON THE XXX SYSTEM, 3 OF 6 XXX WERE INOP OR DEGRADED, AND XXX FAILED TO CYCLE ROUNDS.

- THE XXX DEMONSTRATION WAS SAT (SCORE: 0.80).

- THE FULL POWER DEMONSTRATION WAS SAT (SCORE: 0.91). SEE REF A.

- THE QUICK REVERSAL AHEAD WAS SAT (SCORE: 0.98).

- THE QUICK REVERSAL ASTERN WAS UNSAT (SCORE: 0.50). SEE REF A.

- THE STEERING DEMONSTRATION WAS DEGRADED (SCORE: 0.63) BECAUSE THE RUDDER SWING RATES WERE OUT-OF-SPEC SLOW AND IMBALANCED.

- THE ANCHOR DROP DEMONSTRATION WAS SAT (SCORE: 0.89).

5. SIGNIFICANT MATERIAL DEFICIENCIES AND EQUIPMENT OPERATIONAL CAPABILITY (EOC) INCLUDE:

A. PROPULSION: 0.88. REF A DOCUMENTS DEFICIENCIES AND OBSERVATIONS NOTED IN THE XXX DEPARTMENT.

B. AUXILIARIES: 0.74.

- THE XXX WAS EXCESSIVELY WORN.

- 5 OF 8 XXX INDICATORS WERE INOP (CORRECTED).

- 10 OF 10 XXX HAD INOP OR OUT-OF-SPEC SAFETY SWITCHES (5 CORRECTED).

- 5 OF 5 XXX WERE INOP (3 CORRECTED).

- 17 OF 23 XXX HAD SIGNIFICANT DEFICIENCIES OR WERE INOP (13 CORRECTED).

- THE ACCOM LADDER UPPER PLATFORM WAS MISSING A THIRD LIFELINE.

C. COMBAT SYSTEMS: 0.83.

- 5 OF 6 XXX WERE INOP (2 CORRECTED).

- 2 OF 10 XXX WERE UNSAFE TO OPERATE (CORRECTED).

- 8 OF 10 XXX WERE UNSAFE TO OPERATE (CORRECTED).

- 25 OF 25 XXXX DID NOT HAVE REQUIRED FLOATATION AND HOLSTER SAFETY MODIFICATIONS INSTALLED.

- THE XXX WARNING BELL WAS INOP (CORRECTED).

- THE XXX WAS INOP (CORRECTED).

- THE CONDITION OF ELECTRONIC MATTING IN MANY XXX SPACES WAS NOT INSTALLED IAW NSTM CH 634 AND COVERED SIGNIFICANTLY CORRODED DECKS.

- THERE WERE SEVERAL SIGNIFICANT TOPSIDE AND MAST INSPECTION DISCREPANCIES INCLUDING VARIOUS CORRODED FERROUS FASTENERS AND ASSOCIATED HARDWARE, MISSING OR IMPROPERLY INSTALLED CLIMBER SAFETY RAIL PINS, AND MISSING ANTENNA SAFETY CUTOFF SWITCH RF HAZARD LABELS.

- THE CLIMBER SAFETY RAILS LOCATED ON THE XXX, NAVIGATION POLE, AND FANTAIL WERE NOT INSTALLED IAW THE NAVSEA STANDARD DRAWING.

- THE XXX WATER CIRCULATING PUMP WAS INOP (CORRECTED).

D. QUALITY OF SHIPBOARD LIFE: 0.83.

- THE FLAG PANTRY GARBAGE DISPOSAL HAD EXPOSED ELECTRICAL WIRES IN THE CABINET BENEATH THE SINK (CORRECTED).

PAGE 08 RUCOMFB8675 UNCLAS.

- THERE WERE NO DEEP FAT FRYER EMERGENCY DISCONNECT SWITCHES INSTALLED IN 5 OF 7 GALLEYS/PANTRIES.

- 17 OF 44 NEWLY INSTALLED GAYLORD HOOD FAIL-SAFE SWITCHES WERE INOP (CORRECTED).

E. NAVOSH: 0.84.

- 38 OF 41 XXX SAFETY NETS HAD DISCREPANCIES.

- IMMUNIZATION SUPPLIES WERE NOT STORED IN A BIOLOGICAL REFRIGERATOR THAT HAD HIGH/LOW TEMPERATURE AND LOSS OF POWER ALARMS INSTALLED (CORRECTED).

- 1 OF 5 BIOLOGICAL REFRIGERATORS WAS INOP.

- THE XXX CALL BUTTON SYSTEM AND XXX HEADS WAS INOP.

- 1 OF 3 MEDICAL/DENTAL STERILIZERS WAS INOP (CORRECTED).

6. VADM XXX, (CMD), RADM XXX, (CMD), AND RADM XXX, (CMD), WERE PRESENT FOR THE INSPECTION. CAPT XXX WAS THE SENIOR INSPECTOR.

7. PRESIDENT, BOARD OF INSPECTION AND SURVEY, CONCURS WITH THE FINDINGS.//

BT

NOTE: ENSURE MESSAGES ARE IN ACCORDANCE WITH CURRENT MESSAGE FORMAT AND CURRENT PLAD IS UTILIZED.

APPENDIX E

JOB ORIGINATOR IDENTIFICATION TABLE

Code	Short Description
A	HM&E RA (SUB/AIR)
B	C5RA (AIR) - Local TYCOM
C	C5RA (National)
D	C5RA (AIR) - Local TYCOM
G	RMC Inputs (AIR) - Local TYCOM
H	RMC Inputs (AIR) - Local TYCOM
J	ICAS (National)
K	C5RA (SURF) - Local TYCOM
P	PMT OSAR (SUB) - Local TYCOM
Q	Created by RMAIS (National)
R	INSURV (National)
S	Sail Deficiencies (SUB) - Local TYCOM
W	Class Maintenance Plans (AIR, SUB, SURFACE)
X	Class Maintenance Plans (AIR, SUB)
Y	MST (SURF) Class Maintenance Plans (AIR) - Local TYCOM
Z	MST (SURF), CMP (National) - Z-alpha (National), Z-numeric (MST)

References to "National" values indicate that, in accordance with SHIPMAIN direction, an Information Technology product has been identified as the only authorized tool that will create 4790-2-Kilos containing the respective Job Originator code.

(This Page Intentionally Left Blank)

VOLUME VI
CHAPTER 43

**GUIDANCE FOR ENHANCED MODERNIZATION AND ALTERATION INSTALLATION TEAM
INTEGRATION DURING AVAILABILITIES**

REFERENCES.

- (a) NAVSEA SL720-AA-MAN-030 - Navy Modernization Process Management and Operations Manual

43.1 CONCEPT.

- a. Scope. This policy applies to all modernization work (Ship's Force, shipyard, Intermediate Maintenance Activity and Alteration Installation Team) conducted during all types of Availabilities (Chief of Naval Operations, Continuous Maintenance Availability, Fleet Maintenance Availability, etc.) on all platforms. This chapter compliments the support policy of the Fleet Modernization Program as described in Chapter 3 and Chapter 36 of this volume.
- b. Overview. Ship availability duration must be limited to only that required to accomplish planned repairs and alterations. Unnecessary time in depot maintenance periods reduces the time when ships are operationally available to support the Fleet Response Plan. Accordingly, scheduling of production and test activity for all work must be optimized to keep availability schedule duration to a minimum. The key to duration optimization is rigorous, inclusive and detailed integrated planning, which encompasses all anticipated work into a balanced schedule. Once an integrated and executable schedule is established and agreed to by all participating activities, the Naval Supervisory Authority (NSA) shall be responsible and have the authority to manage the execution of the modernization through its completion.
- c. This chapter provides planning and execution requirements for all modernization activities participating in an availability. Disconnected or diffused planning and execution creates local delays and disruption to the overall availability effort, creates additional coordination challenges for NSAs and Ship's Force, and results in excessive availability durations and higher secondary costs.
- d. Essential to establishing an integrated and executable schedule is a stable and properly funded repair and modernization work package. Type Commanders and Program Managers must structure, plan and program repairs and installations with an understanding that they will be executed not in isolation, but as part of a larger, integrated effort with competing constraints and requirements. Accordingly, repair candidates and alterations not authorized at the Work Package Integration Conference (WPIC) will not be included in the integrated schedule, and will only be authorized after the WPIC when the NSA has advised the customer of the cost and schedule impact associated with a proposed late work addition.

NOTE: FOR SURFACE FORCE SHIPS SUSTAINMENT, TYPE 1 AND 2 ALTERATIONS (TERMED "INTERNAL EQUIPMENT ALTERATIONS") MAY BE INCORPORATED INTO THE PACKAGE UP TO THE 100 PERCENT LOCK.

43.2 AVAILABILITY PLANNING BUSINESS RULES.

- a. The NSA/Lead Maintenance Activity (LMA) has overall responsibility for the availability and possess the authority to organize, structure and coordinate availability execution matters. All other participants shall support the NSA/LMA in this regard. Accordingly, it is paramount that the NSA/LMA balance the needs of all participants and customers in the availability.
- b. All participating activities shall provide all availability requirements (specifications, Automated Work Requests, major Planned Maintenance System and Ship's Force projects, approved installation drawings, schedule needs, system and compartment release dates, industrial support requirements, etc.) to the NSA/LMA as specified by other applicable milestones in this manual. Technical Points of Contact (TPOC) for each repair or installation activity shall also be provided to the NSA/LMA to assist with integrated planning questions. These TPOCs shall also be present during the execution of the availability and have authority to represent their organization's interest in matters relating to their repair

or installation. For Aegis ships, all Combat System upgrade packages shall be assembled, scheduled and integrated by the Aegis Combat System Project Engineer and submitted to the NSA/LMA as a package via the SEA21 Hull Manager.

- (1) Alteration Installation Teams shall provide requirements in accordance with reference (a).
- (2) The LMA shall develop an inclusive, detailed, integrated and resource-loaded schedule of all participating activities. All participants shall meet and review the proposed plan and make necessary adjustments to render a balanced and optimized integrated schedule. This formal schedule review shall occur after the WPIC, but no later than the Work Package Execution Review. The NSA/LMA shall serve as the final arbiter of conflicts. By the Work Package Execution Review, all integrated schedule conflicts shall be resolved by the NSA/LMA.
- (3) The LMA shall be specifically tasked to accomplish integrated availability planning and execution. For Regional Maintenance Centers, the following related set of specifications achieving end-to-end integration shall be invoked in the availability Contract Line Item Number at a lead time commensurate with the complexity of the work package:
 - (a) "Availability Program Management Alteration Installation Team Integration" Standard Work Template 897-04 (Appendix ___).
 - (b) Combat Systems Light-off/AEGIS Light-off Compartment Release Schedule, SWT 813-01 (Appendix ___), as applicable.
 - (c) Propulsion Plant Light-off Assessment Standard Item(s), as applicable.
 - (d) Aegis Light-off NAVSEA Standard Item(s), as applicable.

NOTE: TASKING SHALL ENSURE THE NSA/LMA CAN PROVIDE INITIAL "SCHEDULE CONFLICT AWARENESS" AT THE WPIC.

- c. Costs for this integration effort shall be prorated amongst the participating customers using existing, standardized proration conventions.

43.3 AVAILABILITY EXECUTION BUSINESS RULES.

- a. During availability execution, the LMA shall manage and coordinate the project and recommend resolutions to conflicting issues. The NSA will exercise final arbiter for conflict resolution.
- b. The LMA shall host weekly production progress and work review meetings. All activity participants shall ensure their TPOC is present to assist in coordination and conflict resolution.
- c. LMAs also conduct daily production coordination meetings. It is recommended that all activity participants and TPOCs attend these on an as-needed basis to assist (in real-time) with coordination and conflict resolution.
- d. In all availability meetings, communications and forums, a forward-looking, anticipatory focus should be applied by all parties to intercept potential problems and resolve them as soon as possible and with least cost and schedule impact.

VOLUME VI

CHAPTER 44

**MAINTENANCE AND MODERNIZATION PERFORMANCE REVIEW MEETINGS
FOR SURFACE FORCE SHIPS**

THIS CHAPTER MOVED INTO CHAPTER 39 OF THIS VOLUME.

(This Page Intentionally Left Blank)

JOINT FLEET MAINTENANCE MANUAL
VOLUME VII
CONTRACTED SHIP MAINTENANCE
LIST OF EFFECTIVE PAGES

Page Numbers	Change in Effect	Page Numbers	Change in Effect
i	Change 5	VII-2-4 thru VII-2-5	REV C
ii	Change 4	VII-2-6	Change 3
iii	Change 5	VII-2-7 thru VII-2-29	REV C
iv thru viii	Change 3	VII-2-30	Change 3
ix	Change 4	VII-2-31	Change 1
x thru xiii	Change 3	VII-2-32	Change 3
xiv	Change 4	VII-2-33 thru VII-2-34	Change 1
xv thru xxiv	Change 3	VII-2A-1 thru VII-2A-4	REV C
VII-FWD-1	Change 1	VII-2B-1 thru VII-2B-2	REV C
VII-FWD-2	REV C	VII-3-1	Change 3
VII-FWD-A-1	Change 1	VII-3-2 thru VII-3-4	REV C
VII-FWD-A-2	Change 4	VII-3-5	Change 3
VII-FWD-A-3 thru VII-FWD-A-4	Change 3	VII-3-6	REV C
VII-FWD-B-1 thru VII-FWD-B-2	REV C	VII-3-7 thru VII-3-9	Change 3
VII-FWD-B-3 thru VII-FWD-B-4	Change 1	VII-3-10	Change 1
VII-FWD-B-5	Change 3	VII-3A-1 thru VII-3A-2	REV C
VII-FWD-B-6	Change 4	VII-3B-1 thru VII-3B-2	REV C
VII-1-1	REV C	VII-4-1	Change 4
VII-1-2	Change 3	VII-4-2	REV C
VII-1-3 thru VII-1-4	REV C	VII-4-3	Change 3
VII-1-5	Change 1	VII-4-4 through VII-4-11	Change 4
VII-1-6 thru VII-1-8	REV C	VII-4-12	REV C
VII-2-1 thru VII-2-2	REV C	VII-4A-1 thru VII-4A-6	REV C
VII-2-3	Change 1	VII-4B-1 thru VII-4B-2	REV C

Page Numbers	Change in Effect	Page Numbers	Change in Effect
VII-4C-1 thru VII-4C-2	REV C	VII-6-4	Change 2
VII-4D-1 thru VII-4D-4	REV C	VII-6-5	REV C
VII-4E-1	Change 4	VII-6-6	Change 3
VII-4E-2	REV C	VII-6-7 thru VII-6-10	REV C
VII-4F-1 thru VII-4F-9	REV C	VII-7-1	Change 3
VII-4F-10	Change 2	VII-7-2	REV C
VII-4F-11 thru VII-4F-12	REV C	VII-7-3	Change 1
VII-5-1	Change 1	VII-7-4	Change 3
VII-5-2	Change 3	VII-7-5 thru VII-7-6	Change 1
VII-5-3	Change 1	VII-7-7	REV C
VII-5-4	REV C	VII-7-8	Change 1
VII-5-5	Change 2	VII-7-9	Change 3
VII-5-6	Change 1	VII-7-10	Change 1
VII-5-7	REV C	VII-7-11 thru VII-7-12	Change 3
VII-5-8	Change 1	VII-7-13 thru VII-7-21	REV C
VII-5-9 thru VII-5-11	REV C	VII-7-22	Change 3
VII-5-12	Change 1	VII-7-23 thru VII-7-27	REV C
VII-5-13	REV C	VII-7-28 thru VII-7-32	Change 1
VII-5-14 thru VII-5-15	Change 1	VII-7-33 thru VII-7-34	Change 3
VII-5-16	REV C	VII-7-35 thru VII-7-36	Change 1
VII-5-17	Change 1	VII-7A-1 thru VII-7A-2	REV C
VII-5-18 thru VII-5-20	REV C	VII-7B-1 thru VII-7B-2	REV C
VII-5-21	Change 1	VII-7C-1 thru VII-7C-2	REV C
VII-5-22	REV C	VII-7D-1 thru VII-7D-2	REV C
VII-5A-1 thru VII-5A-2	REV C	VII-7E-1 thru VII-7E-2	REV C
VII-5B-1 thru VII-5B-2	REV C	VII-8-1	REV C
VII-5C-1 thru VII-5C-2	REV C	VII-8-2	Change 2
VII-5D-1 thru VII-5D-2	REV C	VII-8-3 thru VII-8-8	REV C
VII-6-1 thru VII-6-3	REV C	VII-8A-1 thru VII-8A-2	REV C

Page Numbers	Change in Effect	Page Numbers	Change in Effect
VII-9-1 thru VII-9-2	REV C		
VII-9-3	Change 1		
VII-9-4 thru VII-9-5	REV C		
VII-9-6	Change 1		
VII-9-7 thru VII-9-10	REV C		
VII-10-1 thru VII-10-6	REV C		
VII-11-1	Change 5		
VII-11-2	Change 1		
VII-11-3 thru VII-11-13	Change 2		
VII-11-14	REV C		
VII-11A-1 thru VII-11A-2	Change 2		
VII-11A-3 thru VII-11A-5	REV C		
VII-11A-6	Change 2		
VII-11A-7 thru VII-11A-14	REV C		
VII-11B-1 thru VII-11B-2	REV C		
VII-11C-1 thru VII-11C-4	REV C		
VII-12-1	Change 1		
VII-12-2	Change 3		
VII-13-1 thru VII-13-3	Change 3		
VII-13-4	REV C		

(This Page Intentionally Left Blank)

JOINT FLEET MAINTENANCE MANUAL
VOLUME VII
CONTRACTED SHIP MAINTENANCE
RECORD OF CHANGES

CHANGE NO.	DATE	TITLE OR BRIEF DESCRIPTION	ENTERED BY (INITIALS)

(This Page Intentionally Left Blank)

JOINT FLEET MAINTENANCE MANUAL CHANGE REQUEST FORM	
<p>FROM: ACTIVITY/SHIP _____ E-MAIL ADDRESS _____ CODE/DEPT/SHOP _____ DATE _____ ORIGINATOR _____ TEL EXT () _____</p>	
<p>VOL-PART-PARA NO. _____ FIGURE _____ TABLE _____ PROCESSING NORMAL _____ URGENT* _____ * (Justify in rationale below if urgent is marked and transmit via e-mail as "High Importance") PROBLEM DESCRIPTION:</p>	
<p>RECOMMENDED CHANGE: (Include any proposed text addition/deletion)</p>	
<p>RATIONALE:</p>	

E-mail to PTNH.SUBMEPP.JFMMMGR@Navy.Mil

(If mailing, fold on dotted line on reverse side and mail to Submarine Maintenance Engineering, Planning and Procurement (SUBMEPP) Activity or send facsimile to (207) 438-6210.)

FOLD

Commanding Officer

OFFICIAL BUSINESS

Commanding Officer
Submarine Maintenance Engineering,
Planning and Procurement (SUBMEPP) Activity
Attn: Code 1832JM
P.O. Box 2500
Portsmouth Naval Shipyard
Portsmouth, NH 03804-2500

FOLD

JOINT FLEET MAINTENANCE MANUAL
VOLUME VII
CONTRACTED SHIP MAINTENANCE
TABLE OF CONTENTS

	Page No.
LIST OF EFFECTIVE PAGES	i
RECORD OF CHANGES	v
JOINT FLEET MAINTENANCE MANUAL CHANGE REQUEST FORM.....	vii
FOREWORD - CONTRACTED SHIP MAINTENANCE	
1.1 Purpose	VII-FWD-1
1.2 Scope	VII-FWD-1
1.3 Changes and Corrections	VII-FWD-1
1.4 Request for Copies of the Manual	VII-FWD-2
Appendices	
A List of Acronyms	VII-FWD-A-1
B Glossary of Terms.....	VII-FWD-B-1
CHAPTER 1 - CONTRACTED SHIP REPAIR FUNCTIONS, TASKS AND STANDARDS OF CONDUCT	
1.1 Contracted Ship Repair Functions and Tasks Overview.....	VII-1-1
1.2 Contracted Ship Repair Functions and Tasks	VII-1-1
1.2.1 Functions	VII-1-1
1.2.1.1 Mission Tasks	VII-1-1
1.2.2 Procurement and Contract Administrative Functions of the Regional Maintenance Center.....	VII-1-2
1.2.3 Relationship with Contractors	VII-1-2
1.2.4 Standards of Conduct.....	VII-1-3
1.2.5 Fraudulent Violations or Irregularities.....	VII-1-3
1.3 Organizational Relationships for Vessel Modernization, Overhaul, Repair and Maintenance Contracting.....	VII-1-4
1.3.1 General.....	VII-1-4
1.3.2 Chief of Naval Operations	VII-1-4
1.3.3 Systems Commands	VII-1-4
1.3.4 Naval Sea Systems Command	VII-1-5
1.3.5 Program Executive Office Program Offices	VII-1-6
1.3.6 Logistics, Maintenance and Industrial Operations Directorate (SEA 04).....	VII-1-6
1.3.7 The Atlantic and Pacific Fleets	VII-1-6
1.3.8 Type Commanders.....	VII-1-6
1.3.9 Naval Shipyards.....	VII-1-7
1.3.10 U.S. Ship Repair Facility, Yokosuka, Japan	VII-1-7
1.3.11 User Commands or Activities (Users).....	VII-1-7
1.3.12 Naval Inactive Ship Maintenance Facilities.....	VII-1-7
1.3.13 Naval Reserve Force Vessels.....	VII-1-7
1.3.14 Defense Finance and Accounting Service Offices.....	VII-1-7
1.3.15 Defense Contract Audit Agency	VII-1-7
1.3.16 Defense Contract Management Agency Components	VII-1-7
1.3.17 General Accounting Office	VII-1-8
1.3.18 Naval Reactors Representatives.....	VII-1-8
1.3.19 Foreign Governments	VII-1-8
1.3.20 Private Companies - Demilitarizing and Stripping	VII-1-8

CHAPTER 2 - CONTRACTS AND CONTRACT ADMINISTRATION

2.1	Purpose	VII-2-1
2.2	Overview of the Federal Acquisition Process.....	VII-2-1
2.2.1	Procurement from Private or Government Sources	VII-2-1
2.2.2	Contracting Techniques	VII-2-2
2.2.3	General Procurement Statutes.....	VII-2-2
2.2.4	Procurement Regulations.....	VII-2-2
2.2.4.1	Federal Acquisition Regulation.....	VII-2-2
2.2.4.2	Department of Defense Federal Acquisition Regulation Supplement.....	VII-2-3
2.2.4.3	Navy Marine Corp Acquisition Regulation Supplement.....	VII-2-3
2.2.4.4	NAVSEA Contracts Handbook.....	VII-2-3
2.2.4.5	Other Navy Publications	VII-2-3
2.2.4.6	Command Publications	VII-2-3
2.2.4.7	Joint Fleet Maintenance Manual Relationship to Other Directives.....	VII-2-3
2.2.4.8	Field Instructions and Notices.....	VII-2-4
2.2.4.9	Waiver of Regulations and Directives.....	VII-2-4
2.2.4.10	Impact of Statutes and Regulations	VII-2-4
2.3	Budget/Appropriations/Allocation Process.....	VII-2-4
2.3.1	Constitutional Authority	VII-2-4
2.3.2	Statutory Authorization.....	VII-2-4
2.3.3	Budget Authority	VII-2-4
2.3.4	Authorization of Appropriations.....	VII-2-4
2.4	Contracts.....	VII-2-5
2.4.1	Types of Contracts	VII-2-5
2.4.2	Contract Selection.....	VII-2-5
2.4.2.1	Fixed Price Contracts	VII-2-5
2.4.2.1.1	Administration	VII-2-5
2.4.2.2	Cost Reimbursement Type Contracts.....	VII-2-6
2.4.3	Time and Materials Contract	VII-2-6
2.4.4	Indefinite-Delivery Indefinite-Quantity Contracts.....	VII-2-6
2.4.5	Letter Contracts	VII-2-6
2.4.6	Basic Agreements	VII-2-6
2.4.7	Basic Ordering Agreements.....	VII-2-6
2.4.7.1	Description.....	VII-2-6
2.4.7.2	Background	VII-2-6
2.4.8	Other Contracting Methods	VII-2-6
2.4.9	Five (5) Elements of a Contract.....	VII-2-7
2.4.9.1	The Offer.....	VII-2-8
2.4.9.2	The Acceptance.....	VII-2-8
2.4.9.3	Consideration	VII-2-8
2.4.9.4	The Legal and Possible Objective	VII-2-8
2.4.9.5	Competent Parties	VII-2-8
2.5	Overview of Contracting Procedures.....	VII-2-8
2.5.1	Sealed Bidding.....	VII-2-8
2.5.1.1	The Purposes of Sealed Bidding	VII-2-8
2.5.1.2	Success of Sealed Bidding	VII-2-8
2.5.1.3	Responsibilities of the Planning and Procuring Activities	VII-2-8
2.5.1.3.1	Requiring/Planning Activity	VII-2-9
2.5.1.3.2	The Procuring Activity	VII-2-9
2.5.1.4	Invitation for Bid Summary	VII-2-9
2.5.2	Contracting by Negotiation.....	VII-2-9
2.5.3	Basic Acquisition Process.....	VII-2-10
2.5.4	Clearance	VII-2-10
2.6	Writing Contracts.....	VII-2-10

2.6.1	Uniform Contract Format	VII-2-10
2.6.2	Standard Procurement System	VII-2-10
2.6.3	Procurement Deficiencies	VII-2-10
2.7	Contracting Officer Authority and Responsibilities	VII-2-10
2.7.1	Authorized Officials	VII-2-10
2.7.2	Typical Contracting Officer's Representative Responsibilities.....	VII-2-11
2.7.3	Typical Contracting Officer's Representative Duties.....	VII-2-11
2.7.3.1	Actual Authority Required	VII-2-11
2.7.4	Implied Authority	VII-2-12
2.7.5	Contractually Related Functions.....	VII-2-12
2.8	Contract Administration	VII-2-12
2.8.1	Regional Maintenance Centers	VII-2-12
2.8.2	Assignment of Contract Administration	VII-2-12
2.8.3	Contract Manager Representatives	VII-2-13
2.8.4	Correspondence and Visits	VII-2-13
2.8.5	Contracting Officer Warrants	VII-2-13
2.8.6	Involvement	VII-2-13
2.8.7	Special Requirements in Schedules	VII-2-13
2.8.8	Communications with Fleet Representatives.....	VII-2-13
2.8.9	Communications and Familiarity with Contractors	VII-2-13
2.8.10	Government Furnished Property.....	VII-2-14
2.8.11	Use of Change Orders and Avoiding Constructive Change Orders.....	VII-2-14
2.8.12	Avoidance of Delays.....	VII-2-14
2.8.13	Improper or Unsatisfactory Work.....	VII-2-14
2.8.14	Records	VII-2-14
2.9	Socioeconomic Programs	VII-2-14
2.9.1	Deputy for Small Business	VII-2-15
2.9.2	Subcontracting Program Administration	VII-2-15
2.10	Processing Contractual Actions	VII-2-15
2.10.1	Policies.....	VII-2-15
2.10.1.1	Forward Price Rate Agreement	VII-2-15
2.10.1.2	Pricing of Deleted Work	VII-2-15
2.10.1.3	Awarding Job Orders	VII-2-15
2.10.1.4	Objective of Procurement Process and Contract Pricing.....	VII-2-15
2.10.1.5	Pricing Responsibility	VII-2-15
2.10.1.6	Adjudications on the Basis of Estimates	VII-2-15
2.11	Proposal Analysis	VII-2-15
2.11.1	Cost Analysis.....	VII-2-15
2.11.2	Field Pricing Support.....	VII-2-16
2.11.3	Cost Realism Analysis	VII-2-16
2.11.4	Subcontract Pricing Considerations	VII-2-16
2.11.5	Requests for Procurement Requiring Information on Purchased Materials.....	VII-2-16
2.11.6	Price Analysis	VII-2-16
2.11.7	Use of Independent Estimates.....	VII-2-16
2.12	Work Scope	VII-2-16
2.12.1	Reaching Work Scope Understandings.....	VII-2-16
2.12.2	Work Scope Conferences.....	VII-2-17
2.12.3	Work Scope Data.....	VII-2-17
2.13	Technical Analysis Reports	VII-2-17
2.13.1	General.....	VII-2-17
2.13.2	Local Instructions and Procedures	VII-2-18
2.14	Audit Evaluation of Change Proposals and Submission of Advisory Audit Reports	VII-2-18
2.14.1	Audit Evaluation.....	VII-2-18
2.14.2	Contractual Audit Reports	VII-2-18

2.14.3	Advisory Audit Reports	VII-2-18
2.15	Contract Modifications	VII-2-18
2.15.1	Introduction	VII-2-18
2.15.2	Restrictions	VII-2-19
2.15.3	Types of Contract Modifications	VII-2-19
2.15.4	Order of Preference for Contract Modifications	VII-2-19
2.15.5	Notification of Contract Changes	VII-2-19
2.15.6	Funding	VII-2-20
2.15.7	Notification of Substantial Impact on Employment.....	VII-2-20
2.15.8	Identification of Foreign Military Sales Contract Modifications	VII-2-20
2.15.9	Change Orders	VII-2-20
2.15.9.1	Authority to Issue Change Orders	VII-2-20
2.15.9.2	Change Order Accounting Procedures	VII-2-20
2.15.10	Change Order Documentation	VII-2-20
2.15.11	Definitization	VII-2-21
2.15.12	Complete and Final Equitable Adjustments.....	VII-2-21
2.15.13	Consideration as Command Key Indicator	VII-2-21
2.15.14	Forms	VII-2-21
2.16	Claims Policy.....	VII-2-22
2.16.1	Definitions and Approval Levels	VII-2-22
2.16.2	Claims Prevention.....	VII-2-22
2.16.3	Processing Claims and Requests for Equitable Adjustment	VII-2-23
2.17	Maintenance Centers	VII-2-25
2.17.1	Regional Maintenance Center Procedures and Reports	VII-2-25
2.17.2	Operational Deficiencies.....	VII-2-26
2.17.3	Regional Maintenance Center Authority to Formalize Identified Constructive Changes.....	VII-2-26
2.17.4	Processing Identified Constructive Changes.....	VII-2-26
2.18	Contract Claims	VII-2-26
2.18.1	Claims Program	VII-2-26
2.18.2	Common Basis for Claims	VII-2-27
2.18.2.1	Breach of Contract	VII-2-27
2.18.2.2	Insufficient Compensation for Formal Change	VII-2-27
2.18.2.3	Late or Defective Government Furnished Property and Information.....	VII-2-27
2.18.2.4	Constructive Change Orders	VII-2-27
2.18.3	Receipt of Proposals for Changes	VII-2-27
2.18.4	Contract Misinterpretation	VII-2-28
2.18.4.1	Defective Specifications.....	VII-2-28
2.18.4.2	Failure to Disclose Vital Information.....	VII-2-28
2.18.4.3	Constructive Acceleration	VII-2-28
2.18.4.4	Failure to Cooperate/Hindrance of Performance.....	VII-2-28
2.18.5	Data.....	VII-2-28
2.18.5.1	Significant Events	VII-2-28
2.18.6	Significant Events Data	VII-2-29
2.19	Resolution of Disputes.....	VII-2-29
2.19.1	Appeals	VII-2-29
2.19.2	Negotiations with Appeal Pending	VII-2-29
2.19.3	Third Party Lawsuits.....	VII-2-29
2.20	Contract Terminations	VII-2-29
2.20.1	Extent of Termination.....	VII-2-29
2.20.2	Effect of Termination	VII-2-30
2.20.3	Termination Contracting Officer	VII-2-30
2.21	Overtime and Multi-Shift Work	VII-2-30
2.21.1	Labor.....	VII-2-30
2.21.2	Overtime	VII-2-30
2.21.3	Procedures	VII-2-30

2.21.3.1	Pre-Award Considerations	VII-2-30
2.21.3.2	Fixed-Price Contracts	VII-2-31
2.21.3.3	Cost-Reimbursable and Letter Contracts	VII-2-31
2.21.4	Approval of Overtime	VII-2-31
2.22	Subcontracts	VII-2-31
2.22.1	Subcontracting	VII-2-31
2.22.2	Consent Requirements	VII-2-32
2.22.3	Additional Regional Maintenance Center Consent Procedures	VII-2-32
Appendices		
A	Memorandum of Understanding Between NAVSEA and NAVSUP of August 2004	VII-2A-1
B	Basic Acquisition Process	VII-2B-1

CHAPTER 3 - PRIMARY CONTRACTING STRATEGIES - MASTER AGREEMENT FOR REPAIR AND ALTERATION OF VESSELS AND PRIVATE SECTOR INDUSTRIAL ACTIVITY

3.1	Purpose	VII-3-1
3.2	Policy	VII-3-1
3.2.1	Policy Sources	VII-3-1
3.2.2	Defense Federal Acquisition Regulation Supplement 217.7102 Policy	VII-3-1
3.3	Agreements	VII-3-2
3.3.1	Master Agreement for Repair and Alteration of Vessels	VII-3-2
3.3.2	Job Order	VII-3-2
3.3.3	Clauses	VII-3-2
3.4	Eligibility Requirements for Master Ship Repair Agreement and Agreement for Boat Repair Program	VII-3-2
3.4.1	Major Requirements for a Master Ship Repair Agreement Certification	VII-3-2
3.4.2	Master Ship Repair Agreement Requirements	VII-3-2
3.4.3	Additional Requirements	VII-3-3
3.4.4	Remote Site Work Performance Plan	VII-3-4
3.4.5	Agreement for Boat Repair Requirements	VII-3-4
3.4.6	336611 Ship Building and Repairing	VII-3-4
3.4.7	336612 Boat Building and Repairing	VII-3-5
3.5	Responsibilities Applicable to the Master Ship Repair Agreement and/or Agreement for Boat Repair Program	VII-3-5
3.5.1	Contractors	VII-3-5
3.5.2	Contracting Officers at Regional Maintenance Centers	VII-3-5
3.5.2.1	Mid-Atlantic Regional Maintenance Center (Code 400)	VII-3-5
3.5.2.2	NAVSEA Director, SUPSHIP Management Group (NAVSEA 04Z)	VII-3-6
3.5.2.3	NAVSEA Fleet Support Contracts Division (NAVSEA 024)	VII-3-6
3.6	Procedures for Master Ship Repair Agreement and Agreement for Boat Repair	VII-3-6
3.6.1	Period of Agreement	VII-3-6
3.6.2	Solicitations for Job Orders Outside of Existing Contracts	VII-3-7
3.6.3	Pre-Award Survey for Job Orders and Determination of Eligibility	VII-3-7
3.6.4	Award of a Job Order	VII-3-7
3.6.5	Emergency Work	VII-3-8
3.6.6	Modification of Master Agreements	VII-3-8
3.6.7	Resolving Inconsistencies Between Master Agreements and Job Orders	VII-3-8
3.6.8	Transfer of Master Agreements	VII-3-8
3.7	Private Sector Industrial Activity Contracts	VII-3-8
3.7.1	Private Sector Industrial Activity Contract	VII-3-8
3.7.2	Requirement	VII-3-9
3.7.3	General Contract Structure	VII-3-9
3.7.4	Pre-Availability Planning	VII-3-9
3.7.5	Availability Oversight	VII-3-9

3.7.6	Growth and New Work.....	VII-3-9
3.7.6.1	Growth or New Work Proposals.....	VII-3-9
3.7.6.2	Business Case Analysis.....	VII-3-10
3.7.6.3	Maintenance Figure of Merit.....	VII-3-10
3.7.6.4	Option Items.....	VII-3-10
Appendices		
A	Master Ship Repair Agreement.....	VII-3A-1
B	Agreement for Boat Repair.....	VII-3B-1
CHAPTER 4 - CONTRACT SPECIFICATION DEVELOPMENT		
4.1	Preparation of Specifications and Estimates of Cost.....	VII-4-1
4.1.1	Purpose.....	VII-4-1
4.1.2	Scope.....	VII-4-1
4.1.3	Design Versus Performance Specifications.....	VII-4-2
4.1.4	Regulatory Requirements for Specifications.....	VII-4-2
4.1.5	Restrictive and “Brand Name or Equal” Specifications.....	VII-4-3
4.2	Work Package Development.....	VII-4-3
4.2.1	Work Packages for Non-Private Sector Industrial Activity Contracts.....	VII-4-3
4.2.2	Work Packages for Private Sector Industrial Activity Contracts.....	VII-4-3
4.2.3	Naval Sea Systems Command Standard Specification Program.....	VII-4-3
4.2.4	Standardization Usage.....	VII-4-4
4.3	Specifications.....	VII-4-4
4.3.1	Preparation of Specification Work Items.....	VII-4-4
4.3.2	The Specification Package.....	VII-4-4
4.3.3	Master Specification Catalog.....	VII-4-4
4.4	Preparation.....	VII-4-4
4.4.1	Steps in Preparing a Work Item Specification.....	VII-4-4
4.4.2	Determining Requirements and Understanding What the Contractor Must Do.....	VII-4-5
4.4.3	Research, Data Gathering and Analysis.....	VII-4-5
4.4.4	Availability of References.....	VII-4-5
4.4.5	Preparation of a Detailed Outline.....	VII-4-6
4.4.6	Preparation of the Initial Draft.....	VII-4-6
4.4.7	Material Requirements.....	VII-4-6
4.4.7.1	Qualified Products Lists.....	VII-4-7
4.4.7.2	Turnaround Items.....	VII-4-7
4.4.8	Tests, Inspections and Performance Criteria.....	VII-4-7
4.4.9	Split Repair Responsibility.....	VII-4-8
4.5	Specification Review.....	VII-4-8
4.5.1	Review and Editing by the Writer.....	VII-4-8
4.5.2	Review and Editing by Someone Other Than the Writer.....	VII-4-9
4.5.3	Team Review and Modification.....	VII-4-9
4.6	Other Functions of the Work Item Planner.....	VII-4-9
4.7	Planning Review.....	VII-4-9
4.8	Non-Scheduled Availabilities.....	VII-4-10
4.8.1	Special Planning Procedures.....	VII-4-10
4.8.2	Other Non-Scheduled Work.....	VII-4-10
4.9	Regional Maintenance Center Actions Upon Receipt of Work Requests.....	VII-4-11
Appendices		
A	Specification Review Check List.....	VII-4A-1
B	Specification Review Summary Sheet.....	VII-4B-1
C	Summary Cost Estimates.....	VII-4C-1

D	Work Specification Transmittal.....	VII-4D-1
E	Procedures for the Preparation and Use of Work Item Specifications for Ship Repair	VII-4E-1
F	Work Package Integration Conference Agenda and Check List.....	VII-4F-1

CHAPTER 5 - COST ESTIMATING

5.1	Introduction	VII-5-1
5.2	Types of Estimates.....	VII-5-1
5.2.1	Pre- and Post-Contract Award Estimating.....	VII-5-1
5.2.2	Preliminary Cost Estimate	VII-5-1
5.2.3	Contract Cost Estimate	VII-5-1
5.2.4	Final Cost Estimate.....	VII-5-2
5.2.5	Predicted-End-Cost.....	VII-5-2
5.3	Classification of Cost Estimates	VII-5-2
5.3.1	Class A - Detailed Cost Estimate.....	VII-5-2
5.3.2	Class C - Budget Quality Estimate	VII-5-2
5.3.3	Class D - Feasibility Estimate.....	VII-5-2
5.3.4	Class F - "Ballpark" Estimate	VII-5-2
5.3.5	Class X - Directed or Modified Estimate.....	VII-5-2
5.4	Standard Estimating.....	VII-5-3
5.4.1	Average Contractor.....	VII-5-3
5.4.2	Elements of Standard Estimating.....	VII-5-3
5.4.3	Standard Estimating Example.....	VII-5-3
5.5	Estimating Environment	VII-5-5
5.5.1	Environment Defined.....	VII-5-5
5.5.2	Cost Accounting Standards.....	VII-5-5
5.5.3	Other Factors Affecting the Contractors' Estimating Environment	VII-5-5
5.5.4	Regional Maintenance Center Estimating Instructions.....	VII-5-6
5.6	Cost Estimating Methods, Standardization and Standards.....	VII-5-7
5.6.1	Variables.....	VII-5-7
5.6.2	Standardization of Cost Estimates	VII-5-8
5.6.2.1	Estimating Standards.....	VII-5-8
5.6.2.2	Naval Shipyard Labor Standards.....	VII-5-8
5.6.3	Detailed Estimating Techniques	VII-5-8
5.6.4	Use of Historical Data.....	VII-5-9
5.6.5	Parametric Cost Estimating/"Rules of Thumb"/Cost Estimating Relationships	VII-5-9
5.6.5.1	Return Cost Statistics	VII-5-10
5.6.5.2	Estimated Cost Statistics	VII-5-10
5.6.5.3	Adjustments to Historical Cost Data.....	VII-5-10
5.7	Preparing the Cost Estimate.....	VII-5-10
5.7.1	Preparation.....	VII-5-10
5.7.2	Developing the Estimate.....	VII-5-10
5.7.3	Quantification of the Labor Estimate.....	VII-5-11
5.7.4	Material Estimating	VII-5-14
5.7.4.1	Contractor vs. Government Furnished Material.....	VII-5-14
5.7.4.2	Sources of Pricing Information	VII-5-15
5.8	Estimating for Contract Modifications	VII-5-15
5.8.1	Contractor Modifications.....	VII-5-15
5.8.2	Acceleration.....	VII-5-15
5.8.3	Disruption	VII-5-15
5.8.4	Delay.....	VII-5-16
5.9	Ship Change Estimates	VII-5-16
5.9.1	Navy Modernization Process	VII-5-16
5.9.2	Classification of Ship Change Estimates	VII-5-16

5.9.3	Sources of Ship Change Estimating Data	VII-5-16
5.9.4	Ship Change Estimating Techniques	VII-5-16
5.9.5	Prorated Cost Estimates	VII-5-16
5.10	Labor Rate Estimating	VII-5-17
5.10.1	Projections	VII-5-17
5.10.2	Labor Rates	VII-5-17
5.10.2.1	Private Contractor Labor Rates	VII-5-17
5.10.2.2	Other Direct Labor Factor	VII-5-17
5.10.2.3	Labor Rate Determination	VII-5-17
5.10.2.4	Sample Other Direct Labor Factor and Labor Rate Determination.....	VII-5-18
5.10.2.5	Contractor Rate List	VII-5-19
5.10.2.6	Labor Rate Evaluation for Competitive Procurements	VII-5-20
5.10.2.7	Labor Rates for Noncompetitive Procurements	VII-5-20
5.10.2.8	"The Right Labor Rate" Determination.....	VII-5-20
5.10.2.9	Market Conditions Assessment.....	VII-5-20
5.11	Forward Pricing Rates	VII-5-21
Appendices		
A	Standard Cost Estimate	VII-5A-1
B	Estimating Check-Off List.....	VII-5B-1
C	Category I Standard Item Hard-Core Labor Considerations.....	VII-5C-1
D	Excaliber Contractor Other Direct Labor Factor Calculation (6 Month Period).....	VII-5D-1

CHAPTER 6 - FUNDING AND ACCOUNTING

6.1	Purpose	VII-6-1
6.2	Scope	VII-6-1
6.3	Policy	VII-6-1
6.4	General Information Concerning Funding and Funds Administration	VII-6-2
6.4.1	Appropriations	VII-6-2
6.4.1.1	Operation and Maintenance, Navy	VII-6-2
6.4.1.2	Operation and Maintenance, Naval Reserve	VII-6-3
6.4.1.3	Shipbuilding and Conversion, Navy	VII-6-3
6.4.1.4	Weapons Procurement, Navy	VII-6-3
6.4.1.5	Other Procurement, Navy	VII-6-3
6.4.1.6	Research, Development, Test and Evaluation	VII-6-3
6.4.1.7	Foreign Military Sales	VII-6-3
6.4.2	General Classifications of Funds Transactions	VII-6-3
6.4.3	Repair Funds	VII-6-3
6.4.4	Navy Modernization Process Funds	VII-6-4
6.4.5	Berthing and Messing Funds	VII-6-4
6.4.6	Commercial Industrial Services Contracts.....	VII-6-4
6.4.7	Environmental Compliance Oversight.....	VII-6-4
6.5	Legislated Responsibilities for Control of Public Funds	VII-6-4
6.5.1	Commanding Officer Responsibility	VII-6-4
6.5.2	Comptroller	VII-6-5
6.5.3	Fund Administrators/Funds Managers.....	VII-6-5
6.6	Responsibilities for Ship Maintenance Funding Management Business Rules	VII-6-6
6.6.1	Maintenance Team Funding Business Rules Responsibilities	VII-6-6
6.6.2	Regional Maintenance Center Funding Business Rules Responsibilities	VII-6-6
6.6.3	Type Commander Responsibilities	VII-6-7
6.7	Funding Violation Reporting	VII-6-8
6.8	Funding Violation Penalties.....	VII-6-8

6.9 Funding Methods and Accounting..... VII-6-8

6.9.1 Accounting and Reporting..... VII-6-8

6.9.2 Operating Budgets VII-6-8

6.9.3 Reimbursable Orders VII-6-8

6.9.4 Project Orders VII-6-9

6.9.5 Economy Act Order VII-6-9

6.9.6 Direct Citations VII-6-9

6.9.7 Requests for Contractual Procurement VII-6-9

6.9.8 Letters of Authority VII-6-9

6.9.9 Orders Placed With Government Agencies VII-6-9

6.10 General Information Concerning Availability and Obligation of Funds VII-6-10

6.10.1 General..... VII-6-10

6.10.2 Effects of the Grassley Amendment VII-6-10

CHAPTER 7 - AVAILABILITY AND PROJECT MANAGEMENT

7.1 Purpose VII-7-1

7.2 General..... VII-7-1

7.2.1 Areas of Responsibility..... VII-7-2

7.2.2 Standards of Conduct in Availability Management VII-7-2

7.2.3 Improper Actions VII-7-2

7.2.4 Documenting Significant Events VII-7-2

7.3 Project Management VII-7-3

7.3.1 Project Management Team VII-7-3

7.3.2 Project Manager..... VII-7-3

7.3.2.1 Material Expediter..... VII-7-4

7.3.3 Ashore Ships Maintenance Manager VII-7-4

7.3.4 Shipbuilding Specialists..... VII-7-5

7.3.5 Quality Assurance Manager..... VII-7-6

7.3.5.1 Contractor Quality Management System VII-7-6

7.3.5.2 Alteration Installation Teams VII-7-6

7.4 Contract Administration Team VII-7-6

7.4.1 Administrative Contracting Officer VII-7-7

7.4.2 Commercial Industrial Services Contract Program Managers VII-7-7

7.4.3 Contract Specialist VII-7-8

7.4.4 Cost Monitors VII-7-8

7.4.5 Navy Property Administrator for Contracts..... VII-7-8

7.4.6 Allowance Specialist VII-7-8

7.4.7 Accounting Technician VII-7-8

7.5 Support Staff..... VII-7-9

7.5.1 Functional Support Staff..... VII-7-9

7.5.2 Design Coordinator..... VII-7-9

7.5.3 Planners and Estimators..... VII-7-9

7.5.4 Combat Systems Managers/Representatives VII-7-9

7.5.5 Manager - Environment Compliance and Occupational Safety and Health Act..... VII-7-10

7.5.6 Technical Representatives from Other Activities VII-7-10

7.5.7 Planning Yard Technical Representative VII-7-10

7.6 Availability Performance..... VII-7-11

7.6.1 Preparation for a Contracted Availability VII-7-11

7.6.2 Pre-Award Survey VII-7-11

7.6.3 Readiness to Start VII-7-11

7.6.4 Work Specification Review VII-7-11

7.6.5 Ammunition Off-Load Prior to an Industrial Availability VII-7-11

7.6.6 Fuel Off-Load Prior to an Industrial Availability VII-7-12

7.6.7 Berthing of Ship and Crew VII-7-12

7.6.8	Contractor's Assumption of Responsibility	VII-7-12
7.6.9	Security	VII-7-12
7.6.10	Special Events During Availabilities	VII-7-13
7.7	Scheduled Conferences and Meetings	VII-7-13
7.7.1	Arrival Conference	VII-7-13
7.7.2	Weekly Commanding Officer's Conference	VII-7-14
7.8	Availability Management.....	VII-7-14
7.8.1	Quality Assurance.....	VII-7-14
7.8.2	Constructive Changes	VII-7-15
7.8.3	Work Stoppage	VII-7-15
7.8.4	Award Fee Board Conferences	VII-7-15
7.8.5	Fire Fighting and Fire Prevention Conference.....	VII-7-15
7.8.6	Fire Prevention, Safety and Housekeeping.....	VII-7-15
7.8.7	Fire Watches	VII-7-16
7.8.8	Docking Conference	VII-7-16
7.8.9	Drydocking	VII-7-16
7.8.10	Hazardous Material.....	VII-7-17
7.8.11	Government Furnished Material.....	VII-7-17
7.8.12	Testing of Ship's Systems and Equipment.....	VII-7-18
7.8.13	Ship's Selected Records	VII-7-18
7.8.14	Documentation.....	VII-7-19
7.8.15	Fast Cruise, Dock Trials and Sea Trials.....	VII-7-19
7.9	Availability Processes.....	VII-7-19
7.9.1	Schedules	VII-7-19
7.9.2	Progressing	VII-7-22
7.9.3	Progress Payments	VII-7-24
7.9.4	Progress Conferences.....	VII-7-24
7.10	Funds Administration	VII-7-27
7.10.1	Over Obligation	VII-7-27
7.10.2	Growth and New Work.....	VII-7-28
7.10.3	Contract Modifications	VII-7-28
7.11	Delays In Performance.....	VII-7-29
7.11.1	Risk.....	VII-7-29
7.11.2	Performance	VII-7-29
7.11.3	Material.....	VII-7-29
7.11.4	Excusable Delays.....	VII-7-29
7.11.5	Non-Excusable Delays.....	VII-7-31
7.11.6	Compensable Delays	VII-7-31
	7.11.6.1 Government Delay of Work.....	VII-7-31
	7.11.6.2 Excusable Delay Relief	VII-7-32
7.11.7	Concurrent Delay.....	VII-7-32
7.12	Availability Finalization	VII-7-32
7.12.1	Availability Completion Conference	VII-7-32
7.12.2	Exceptions to Completion of the Contract.....	VII-7-33
7.12.3	Availability Completion	VII-7-33
7.12.4	Contract Guarantee Period.....	VII-7-33
7.12.5	Completion Reports	VII-7-33
7.13	Insurance.....	VII-7-33
7.13.1	Introduction	VII-7-33
7.13.2	Master Ship Repair Agreements/Private Sector Industrial Activity Contracts - Loss or Damage to Government Property.....	VII-7-34
7.13.3	Administration of Insurance Requirements	VII-7-35
	7.13.3.1 Responsibilities of the Assistant Secretary of the Navy Research, Development and Acquisition - Acquisition and Business Management	VII-7-35

7.13.3.2 Procuring Contracting Officer/Regional Maintenance Center Administrative Contracting Officer Responsibilities and ActionsVII-7-35

7.13.3.3 Notification of Legal Actions Against the Contractor.....VII-7-36

Appendices

A Arrival Conference AgendaVII-7A-1

B Fire Fighting and Fire Prevention Conference AgendaVII-7B-1

C Drydocking Conference Agenda.....VII-7C-1

D "Activity" Progressing Method Example.....VII-7D-1

E Progress GuidelinesVII-7E-1

CHAPTER 8 - TESTING, TRIALS, REDELIVERY AND GUARANTEES

8.1 PurposeVII-8-1

8.2 ScopeVII-8-1

8.3 Application of Total Ship Test Program to Modernization and Repair WorkVII-8-1

8.3.1 IntroductionVII-8-1

8.3.2 Ship System Testing (Hull, Mechanical and Electrical)VII-8-2

8.3.3 Combat System TestingVII-8-2

8.4 Trials for Overhaul and Repair Availabilities.....VII-8-2

8.4.1 General.....VII-8-2

8.4.2 Post Repair TrialsVII-8-2

8.4.2.1 Dock Trials.....VII-8-2

8.4.2.2 Fast Cruise.....VII-8-2

8.4.2.3 Sea TrialsVII-8-3

8.5 Finalization Procedures for Repair and Modernization AvailabilitiesVII-8-3

8.5.1 General.....VII-8-3

8.5.2 Availability Completion and Readiness for SeaVII-8-3

8.5.3 Completion Report.....VII-8-3

8.5.4 Terminal Inventory ReportVII-8-4

8.5.5 Release of Retained Funds and Final Payment to the ContractorVII-8-4

8.5.6 Release of Retained Funds.....VII-8-4

8.5.7 Final Payment to ContractorVII-8-4

8.5.8 Departure ReportsVII-8-5

8.5.9 End of Availability CertificationVII-8-5

8.5.10 Guarantee Engineer and Industrial Availability Quality Assessment Reports.....VII-8-5

8.5.11 Integrated Logistic Support RequirementsVII-8-5

8.6 Final AcceptanceVII-8-6

8.6.1 Guarantee PeriodVII-8-6

8.6.2 Correction of Defects.....VII-8-6

8.6.3 Availability Extensions.....VII-8-6

8.6.4 Notices to ContractorVII-8-6

8.6.5 Work Correction Under Another Naval Supervisory AuthorityVII-8-6

Appendices

A Work Item Completion ReportVII-8A-1

CHAPTER 9 - PROPERTY ADMINISTRATION

9.1 ScopeVII-9-1

9.2 Real and Personal PropertyVII-9-1

9.2.1 Government Property Types.....VII-9-2

9.2.2 Duties and Responsibilities for Contract Administration of Government Property.....VII-9-2

9.2.2.1 Head of Regional Maintenance Center Contracts Department.....VII-9-2

9.2.2.2 Regional Maintenance Center Property Administrator Duties and ResponsibilitiesVII-9-2

9.2.2.3	Contractors	VII-9-3
9.3	Providing Government Property to Contractors	VII-9-4
9.3.1	Property	VII-9-4
9.3.2	Material.....	VII-9-4
9.3.2.1	"Cash Sales" Procedures	VII-9-4
9.3.3	Special Tooling	VII-9-5
9.3.4	Special Test Equipment	VII-9-5
9.3.5	Agency-Peculiar Property.....	VII-9-5
9.3.6	Facilities.....	VII-9-5
9.3.7	Industrial Plant Equipment	VII-9-5
9.3.8	Automated Data Processing Equipment	VII-9-5
9.4	Contractor Use and Rental of Government Property	VII-9-5
9.5	Administration of Government Property	VII-9-5
9.5.1	Regulation and Contractual Requirements	VII-9-5
9.5.1.1	Oversight of Contractor Operations	VII-9-5
9.5.1.2	Liens and Title Clause.....	VII-9-5
9.5.1.3	Transfer of Government Property Between Contracts	VII-9-6
9.5.1.4	Annual Property Administration Plan and Report.....	VII-9-6
9.5.1.5	Annual Reports	VII-9-6
9.5.1.6	Additional Reports	VII-9-6
9.5.2	Responsibilities and Duties.....	VII-9-6
9.5.2.1	Appointment and Duties of Property Administrators.....	VII-9-6
9.5.2.2	Appointment and Duties of Plant Clearance Officers	VII-9-6
9.5.2.3	Training Requirements for Property Administrators and Plant Clearance Officers.....	VII-9-6
9.5.3	Plant Clearance	VII-9-6
9.5.3.1	Procedures.....	VII-9-6
9.5.3.2	Disposal Methods.....	VII-9-6
9.5.3.3	Disposing of Hazardous Material/Hazardous Waste.....	VII-9-6
9.5.3.4	Disposal Actions Resulting From Engineering Changes	VII-9-7
9.5.3.5	Disposal Provisions Under Different Types of Contracts	VII-9-7
9.6	Responsibilities of the Contractor.....	VII-9-8
9.7	Repair or Modification of Government Furnished Property	VII-9-8
9.8	Facilities and Leases	VII-9-8
9.8.1	General.....	VII-9-8
9.8.2	Property Accountability.....	VII-9-8
9.8.3	Use of Facilities	VII-9-8
9.8.4	Rental Payment.....	VII-9-8
9.8.5	Insurance.....	VII-9-8
9.8.6	Need for Funds	VII-9-8
9.8.7	Maintenance Responsibility Under Facilities Use Agreements	VII-9-9
9.8.8	Inspection and Report of Machinery and Equipment Maintenance	VII-9-9
9.8.9	Inspection and Report of Maintenance of Civil Works	VII-9-10
9.8.10	Inspection of Dry Docks.....	VII-9-10
9.8.11	Fire Protection Measures	VII-9-10
9.8.12	Inspection and Report of Mobilization Readiness	VII-9-10
9.8.13	Shore Facilities Planning System.....	VII-9-10
9.8.14	Redistribution and Disposal.....	VII-9-10

CHAPTER 10 - ENVIRONMENTAL, SAFETY AND HEALTH

10.1	Purpose	VII-10-1
10.2	Environmental Protection	VII-10-1
10.2.1	Background.....	VII-10-1
10.2.2	General Policy	VII-10-1

10.2.3 Regional Maintenance Center Responsibilities VII-10-1
 10.2.3.1 Regional Maintenance Center Commanding Officers VII-10-1
 10.2.3.2 Manager for Environmental Protection VII-10-2
 10.2.3.3 Environmental Self Evaluations VII-10-2
 10.2.4 Regional Maintenance Center Oversight Functions VII-10-2
 10.2.5 Hazardous Waste VII-10-3
 10.3 Occupational Safety and Health VII-10-3
 10.3.1 Background VII-10-3
 10.3.2 Policy Guidance VII-10-3
 10.3.3 Regional Maintenance Center Responsibilities VII-10-3
 10.3.4 Occupational Safety and Health Oversight Functions VII-10-4
 10.3.5 Inspections VII-10-5

CHAPTER 11 - CONTRACT ADMINISTRATION QUALITY ASSURANCE PROGRAM

11.1 Purpose VII-11-1
 11.1.1 Scope VII-11-1
 11.1.2 Applicability VII-11-1
 11.1.3 Quality Assurance Directives VII-11-1
 11.1.4 NAVSEA Evaluations VII-11-2
 11.2 Program Direction and Control VII-11-2
 11.2.1 Contractor Responsibilities VII-11-2
 11.2.2 Government Responsibilities VII-11-2
 11.2.2.1 Compliance VII-11-2
 11.2.2.2 Quality VII-11-2
 11.2.2.3 Verification VII-11-2
 11.2.2.4 Evaluation VII-11-2
 11.2.2.5 Preservation Oversight of Critical Coated Areas VII-11-2
 11.2.3 Specification Review VII-11-3
 11.2.4 Retention and Disposal of Inspection Records VII-11-3
 11.3 Personnel Capability Requirements VII-11-3
 11.3.1 Quality Assurance Manager/Department Head VII-11-3
 11.3.2 Training VII-11-3
 11.3.2.1 Coating Inspection VII-11-4
 11.3.2.2 Oxygen Cleanliness VII-11-4
 11.3.2.3 Electrical Cableway VII-11-4
 11.3.3 Nondestructive Test Personnel Requirements VII-11-4
 11.3.3.1 Training/Qualification VII-11-4
 11.3.3.2 Qualification VII-11-4
 11.3.3.3 Certification VII-11-4
 11.3.3.4 Certification Maintenance VII-11-5
 11.3.3.5 Inspector Oversight VII-11-5
 11.3.3.6 Nuclear Nondestructive Testing Qualifications VII-11-5
 11.3.4 Ship's Force Quality Assurance Interface VII-11-5
 11.4 Surveys and Conferences VII-11-5
 11.4.1 Bidders' Conference VII-11-5
 11.4.2 Pre-Award Surveys VII-11-6
 11.4.3 Post-Award Conference VII-11-6
 11.4.4 Arrival Conference VII-11-6
 11.5 Elements of the Contract Administration Quality Assurance Program VII-11-6
 11.5.1 Planning VII-11-6
 11.5.2 Document Review VII-11-6
 11.5.2.1 Procedure Review Criteria VII-11-7
 11.5.2.2 Technical Data Review Criteria VII-11-7
 11.5.2.3 Acceptance of the Contractor's Documented Quality Management System VII-11-7
 11.5.2.4 Approval of Procedures VII-11-7

11.5.2.5	Documentation.....	VII-11-7
11.5.3	Procedure Evaluation.....	VII-11-7
11.5.3.1	Conduct of Procedure Evaluation	VII-11-7
11.5.3.2	Documentation	VII-11-7
11.5.4	Product Verification Inspection	VII-11-7
11.5.4.1	Conduct of Product Verification Inspection.....	VII-11-7
11.5.4.2	Documentation	VII-11-7
11.5.5	Quality Audits.....	VII-11-8
11.5.5.1	External Audit.....	VII-11-8
11.5.5.2	Internal Audit	VII-11-8
11.5.5.3	Documentation	VII-11-9
11.5.6	Corrective Action.....	VII-11-9
11.5.6.1	Corrective Action Request	VII-11-10
11.5.6.2	Requesting Corrective Action	VII-11-11
11.5.6.3	Documentation	VII-11-11
11.5.7	Quality Data Evaluation.....	VII-11-11
11.5.7.1	Data Evaluation.....	VII-11-11
11.5.7.2	Documentation	VII-11-11
11.6	Government Contract Quality Assurance Actions at Source	VII-11-11
11.6.1	General.....	VII-11-11
11.6.2	Exception.....	VII-11-12
11.6.3	Requesting Government Contract Quality Assurance at Source	VII-11-12
11.6.3.1	Government Contract Quality Assurance Criteria	VII-11-12
11.6.3.2	Purchase Order Clause	VII-11-12
11.6.3.3	Amending Subcontract After Release	VII-11-12
11.6.3.4	Letter of Delegation	VII-11-13
11.6.3.5	Distribution of Letters of Delegation	VII-11-13
11.6.3.6	Letter of Delegation Follow-up System	VII-11-13
Appendices		
A	Preservation Departures from Specifications Process Decision Tree	VII-11A-1
B	Corrective Action Request.....	VII-11B-1
C	Letter of Delegation (Example Only)	VII-11C-1

CHAPTER 12 - CONTRACTED SUBMARINE PRESERVATION SYSTEM REPAIRS

12.1	Purpose	VII-12-1
12.2	Scope.....	VII-12-1
12.3	Applicability	VII-12-1
12.4	Submarine Preservation Requirements for Contracting	VII-12-1
12.4.1	Structural Integrity	VII-12-1
12.4.2	Tanks	VII-12-1
12.4.3	Blasting	VII-12-2
12.5	Reporting	VII-12-2
12.5.1	Existing Conditions.....	VII-12-2
12.5.2	As Arrived Conditions	VII-12-2
12.5.3	SSN 21 and SSN 774 Class Submarines.....	VII-12-2
12.6	Submarine Preservation Waivers and Deviations	VII-12-2
12.6.1	Requirements	VII-12-2
12.6.2	Notification	VII-12-2

CHAPTER 13 - SHIPBOARD CONTRACTING STRATEGY AND UTILIZATION

13.1	Purpose	VII-13-1
13.2	Scope	VII-13-1

13.3 Applicability VII-13-1

13.4 Objective..... VII-13-1

13.5 Background..... VII-13-1

 13.5.1 Optimal Use of Surface Force Ship/Aircraft Carrier Private Sector Industrial Activity
 Contracts VII-13-1

 13.5.2 Indefinite Delivery/Indefinite Quantity Contracts VII-13-2

 13.5.3 Industrial Capabilities VII-13-2

 13.5.4 Contracts Portfolio VII-13-2

13.6 Overview..... VII-13-2

13.7 Responsibilities VII-13-2

 13.7.1 Fleet Maintenance Board of Directors VII-13-2

 13.7.2 Contracts Governance Council VII-13-2

 13.7.3 Systems Commands and Program Executive Offices VII-13-2

 13.7.4 Fleet Maintenance Activities VII-13-2

13.8 Contracts Governance Council VII-13-3

 13.8.1 Structure..... VII-13-3

 13.8.2 Contracts Governance Council Process VII-13-3

 13.8.3 Contracts Governance Council Membership VII-13-3

 13.8.4 Contracts Governance Council Policy VII-13-3

 13.8.5 Contracts Governance Council Products VII-13-3

 13.8.6 Contracts Governance Council Expectations..... VII-13-4

 13.8.6.1 Contracts Governance Council Monthly Meetings VII-13-4

 13.8.6.2 Contracts Governance Council Consideration VII-13-4

 13.8.6.3 Contracts Governance Council Decision..... VII-13-4

 13.8.6.4 Meeting Administration VII-13-4

 13.8.6.5 Quarterly Briefing VII-13-4

(This Page Intentionally Left Blank)

VOLUME VII
FOREWORD
CONTRACTED SHIP MAINTENANCE

LISTING OF APPENDICES.

- | | |
|---|-------------------|
| A | List of Acronyms |
| B | Glossary of Terms |

1.1 PURPOSE. This volume provides information relative to the procurement, oversight and execution of ship maintenance and modernization work performed in the private sector. Supervisor of Shipbuilding (SUPSHIP) Operations Manual (0910-LP-012-7750 Rev 1) has served as the primary source for information contained in this manual.

1.2 SCOPE. This volume applies to all ships and shore activities under the cognizance of United States Fleet Forces Command, Commander, Pacific Fleet (COMPACFLT), and Commander, Naval Reserve Forces (COMNAVRESFOR). Additionally, although new ship construction is the primary mission area for the remaining SUPSHIPS, this volume is also applicable to those SUPSHIPS that continue to have repair and modernization responsibilities for submarines and aircraft carriers. These SUPSHIPS should familiarize themselves with appropriate sections of this manual as it applies to the repair and modernization contracts that they procure and administer. This volume is not intended to be all encompassing, since the guidance for many elements of the maintenance programs and their execution are promulgated by higher operational, contracting and technical authority (e.g., Office of the Chief of Naval Operations Instructions, Naval Ships Technical Manuals, and Federal Acquisition Regulations (FAR)).

- a. This volume contains general topics, applicable to all ships and units under the cognizance of COMLANTFLT or COMPACFLT. In those cases where chapters are not applicable to certain Forces, an applicability statement has been used for clarification.
- b. Equipment under the cognizance of the Strategic Systems Project Office or Naval Sea Systems Command Nuclear Propulsion Directorate (NAVSEA 08) is maintained in accordance with Strategic Systems Project Office and NAVSEA 08 directives, respectively.
- c. In relation to contractual matters, where a policy or requirement is not established by FAR, Defense Federal Acquisition Regulation Supplement (DFARS), Navy and Marine Corps Acquisition Regulation Supplement (NMCARS), Naval Sea Systems Command Contracts Handbook (NCH), or other Navy or DoD directive, this manual contains the procedural requirements for compliance. Otherwise, the FAR, DFARS, NMCARS, NCH, and other Navy and DoD Directives take precedence over this manual. When a new or revised policy or requirement is promulgated by FAR, DFARS, NMCARS, NCH, or other Navy and DoD Directives that is not consistent with this manual, the new or revised policy and requirements will be followed. Material required to be submitted to higher authority by the NMCARS or NCH will be forwarded via the Regional Maintenance Center Contracts Department Head or Chief of the Contracting Office at SUPSHIP to NAVSEA 02.
- d. Appendices A and B of this chapter contain a list of acronyms and a glossary of terms used throughout all chapters of this volume.

1.3 CHANGES AND CORRECTIONS. Changes and corrections will be issued as required. Comments and suggestions for improving or changing this volume are invited. Address comments, recommendations and requested changes to Submarine Maintenance Engineering, Planning and Procurement Activity utilizing the change request form located in the front of this manual. If changes are submitted in electronic format, facsimile or e-mail, each change request shall contain the information required on the change request form.

1.4 REQUEST FOR COPIES OF THE MANUAL. Activities on distribution for the Joint Fleet Maintenance Manual (JFMM) that require additional copies, or activities wanting to be added to distribution, should submit a letter to their applicable Type Commander, identifying CD-ROM/paper requirements along with justification for the request. To the maximum extent possible, technical publication libraries at each activity will receive copies of the manual for that activity and coordinate local distribution and updates.

APPENDIX A
LIST OF ACRONYMS

2-Kilo	3-M Maintenance Action Form
3-M	Maintenance and Material Management
AAA	Authorized Accounting Agency
AAR	Advisory Audit Report
ABM	Acquisition and Business Management
ABR	Agreement for Boat Repair
ACO	Administrative Contracting Officer
ACWP	Actual Cost of Work Performed
AIT	Alteration Installation Team
ASN	Assistant Secretary of the Navy
ASR	Availability Status Report
BAC	Budgeted Availability Cost
BCWP	Budgeted Cost of Work Performed
BCWS	Budgeted Cost of Work Scheduled
BOA	Basic Ordering Agreement
BSR	Bid Specification Review
BVC	Best Value Contracting
CAM	Contract Audit Manual
CAO	Contract Administration Office
CAQAP	Contract Administration Quality Assurance Program
CAR	Corrective Action Request
CAS	Contract Administration Services
CAS	Cost Accounting Standards
CASREP	Casualty Report
CDA	Contract Disputes Act
CER	Cost Estimating Relationships
CFM	Contractor Furnished Material
CGC	Contracts Governance Council
CIRS	Contractor Inventory Redistribution System
CIS	Commercial Industrial Services
CMAV	Continuous Maintenance Availability
CMP	Class Maintenance Plan
CNO	Chief of Naval Operations
CNRMCC	Commander, Navy Regional Maintenance Center
CO	Commanding Officer
COAR	Customer Order Acceptance Record
COFD	Contracting Officer's Final Decision
COMNAVRESFOR	Commander, Naval Reserve Forces
COMNAVSEA	Commander, Naval Sea Systems Command
COMNAVSURFLANT	Commander, Naval Surface Forces Atlantic
COMPACFLT	Commander, Pacific Fleet
CONUS	Continental United States
COR	Contracting Officer's Representatives
CPARS	Contractors Performance Appraisal Reporting System

CPI	Cost Performance Index
CPM	Critical Path Method
CPMS	Contract Property Management System
DAWIA	Defense Acquisition Workforce Improvement Act
DCAA	Defense Contract Audit Agency
DCMA	Defense Contract Management Agency
DFARS	Defense Federal Acquisition Regulation Supplement
DL	Direct Labor
DoD	Department of Defense
EA	Executing Activity
EF	Early Finish
EP	Environmental Protection
EPA	Environmental Protection Agency
ES	Early Start
ESH	Environmental Safety and Health
ESR	Engineering Support Request
FAR	Federal Acquisition Regulation
FEO	Facilities Engineering Office
FFP	Firm Fixed Price
FLC	Fleet Logistics Center
FLTCOM	Fleet Commands
FMBOD	Fleet Maintenance Board of Directors
FMR	Field Modification Request
FMS	Foreign Military Sales
FP	Fixed Price
FPRA	Forward Price Rate Agreement
G&A	General and Administrative
GAO	General Accounting Office
GCQA	Government Contract Quality Assurance
GFI	Government Furnished Information
GFM	Government Furnished Material
GFP	Government Furnished Property
HAZMAT	Hazardous Material
HCA	Head of Contracting Activity
HW	Hazardous Waste
IDIQ	Indefinite Delivery, Indefinite Quantity
IFB	Invitation For Bid
ISO	International Organization for Standardization
JFMM	Joint Fleet Maintenance Manual
LF	Late Finish
LOA	Letter of Authority
LOA	Light-Off Assessment
LOD	Letter of Delegation

LS	Late Start
LWT	Local Work Template
MARMC	Mid-Atlantic Regional Maintenance Center
MIL-SPEC	Military Specification
MIL-STD	Military Standard
MMBP	Maintenance and Modernization Business Plan
MOU	Memorandum of Understanding
MSRA	Master Ship Repair Agreement
MT	Maintenance Team
NAICS	North American Industry Classification System
NAVAIRSYSCOM	Naval Air Systems Command
NAVCOMPT	Navy Comptroller
NAVFAC	Naval Facilities Engineering Command
NAVOSH	Navy Occupational Safety and Health
NAVSEA	Naval Sea Systems Command
NAVSEA 02	NAVSEA Contracts Directorate
NAVSEA 021	NAVSEA Contract Policy Office
NAVSEA 024	Fleet Support Contracts Division
NAVSEA 08	Naval Sea Systems Command Nuclear Propulsion Directorate
NAVSEASYSYSCOM	Naval Sea Systems Command
NAVSUPSYSCOM	Naval Supply Systems Command
NCH	NAVSEA Contracts Handbook
NDT	Nondestructive Testing
NMCARS	Navy and Marine Corps Acquisition Regulation Supplement
NMD	Navy Maintenance Database
NMP	Navy Modernization Process
NSA	Naval Supervisory Authority
NSI	NAVSEA Standard Item
NSY	Naval Shipyard
O&MN	Operation and Maintenance, Navy
O&MNR	Operations and Maintenance, Naval Reserve
OB	Operating Budget
ODL	Other Direct Labor
ODLF	Other Direct Labor Factor
OF 336	Optional Form 336
OFPP	Office of Federal Procurement Policy
OH	Overhead
OSH	Occupational Safety and Health
OSHA	Occupational Safety and Health Administration
PCB	Polychlorinated Biphenyls
PCD	Production Completion Date
PCN	Project Control Number
PCO	Procuring Contracting Officer
PE	Procedures Evaluation
PEC	Predicted-End-Cost
PEO	Program Executive Office
PMS	Planned Maintenance System

PNS	Portsmouth Naval Shipyard
PQA	Process Quality Audit
PR	Procedure Review
PSIA	Private Sector Industrial Activity
PVI	Product Verification Inspection
PY	Planning Yard
QA	Quality Assurance
QAR	Quality Assurance Representative
QDE	Quality Data Evaluation
QMS	Quality Management System
QPL	Qualified Products Lists
RD&A	Research, Development & Acquisition
REA	Request for Equitable Adjustment
RFS	Readiness for Sea
RMC	Regional Maintenance Center
SARP	Ships' Alteration Repair Package
SC	Ship Change
SCN	Shipbuilding and Conversion, Navy
SF 30	Form SF 30, Amendment of Solicitation/Modification of Contract
SHIPALT	Ship Alteration
SI	Standard Items
SPAWARSYSCOM	Space and Naval Warfare Systems Command
SPD	Ship Project Directive
SPI	Schedule Performance Index
SPM	Shipbuilding Program Manager
SSPC	Society for Protective Coatings
SSR	Ship's Selected Records
SSRAC	Standard Specification for Ship Repair and Alteration Committee
STARS	Standard Accounting and Reporting System
SUPSHIP	Supervisors of Shipbuilding, Conversion and Repair
SWLIN	Ship Work List Item Number
SWT	Standard Work Template
SYSCOM	Systems Command
TAR	Technical Analysis Report
TIP	Test and Inspection Plan
TM	Technical Manuals
TMMP	Technical Manual Management Program
TOB	Technical Operating Budget
TYCOM	Type Commander
USFF	United States Fleet Forces
WPIC	Work Package Integration Conference

APPENDIX B
GLOSSARY OF TERMS

<u>TERM</u>	<u>DEFINITION</u>
Administrative Change	A unilateral contract change, in writing, that does not affect the substantive rights of the parties (e.g., a change in the paying office or the appropriation data).
Administrative Contracting Officer	A contracting officer who is administering contracts.
Approved Purchasing System	A contractor's purchasing system that has been reviewed and approved in accordance with FAR Part 44.
Attribute	A characteristic or property that is used to determine acceptability or unacceptability with respect to a given requirement.
Bilateral Modification	A contract modification that is signed by the contractor and the contracting officer.
Business Unit	Any segment of an organization or an entire business organization not divided into segments.
Certification	The procedure and action by a duly authorized body of determining, verifying and attesting in writing to the qualifications of personnel, processes, procedures or items in accordance with applicable requirements.
Change Order	A written order signed by a contracting officer. It directs the contractor to make a change that the Changes clause authorizes the contracting officer to order without the contractor's consent.
Characteristic	A physical, chemical, visual, functional or any other identifiable property that helps differentiate between items of a given sample or population. The difference may be either quantitative (by variables) or qualitative (by attributes).
Check Point (G)	A symbol inserted in a Work Item to establish a point in the sequence of accomplishment of work at which time the Government shall be notified to permit observation of a specific inspection or test by the Government.
Check Point (I)	A symbol inserted in a Work Item to establish a point in the sequence of accomplishment of work at which time the contractor shall inspect/verify and document the inspection or test. (I) Inspections require verification by a separate individual, other than the person who has accomplished the work, qualified as an inspector.
Claim	A written demand or written assertion by one of the contracting parties seeking, as a matter of right, the payment of money in a sum certain, the adjustment, or interpretation of contract terms or other relief arising under or related to a contract.
Consent to Subcontract	The contracting officer's written consent for the prime contractor to enter into a particular subcontract.

Contract Modification	Any written change in the terms of a contract.
Contracting Officer	A person with the authority to enter into, administer, and/or terminate contracts and make related determinations and findings. The term includes certain authorized representatives of the contracting officer acting within the limits of their authority as delegated by the contracting officer.
Contractor	A business unit.
Contractor Acquired Property	Property acquired or otherwise provided by the contractor for performing a contract and to which the Government has/takes title.
Contractor Furnished Material	Material provided by the contractor to which the Government has acquired a lien or title solely because of partial, advance or progress payments.
Contractor Purchasing System Review	The complete evaluation of a contractor's purchasing of material and services, subcontracting and subcontract management from development of the requirement through completion of subcontract performance.
Corrective Action	An action taken to correct a specific nonconformance by repair, rework, replacement or a change in requirements and the elimination of the causes to prevent recurrence.
Corrective Action Request	Any request to the contractor for the correction of a non-conformance.
Cost Analysis	The review and evaluation of the separate cost elements and proposed profit of an offeror's or contractor's proposal, including cost and pricing data or information other than cost or pricing data. This requires the application of judgment to determine how well the proposed costs represent what the cost of the contract should be, assuming reasonable economy and efficiency.
Cost or Pricing Data	All facts that prudent buyers and sellers would reasonably expect to significantly affect price negotiations. This concerns data as of the date of price agreement or, if applicable, another date agreed upon between the parties that is as close as possible to the date of agreement on price. Cost or pricing data is information requiring certification in accordance with FAR 15.408.
Deviation	Written authorization granted prior to the manufacture of an item, to depart from a particular performance or design requirement of a specification, or referenced document, for a specific number of units or specific period of time.
Document	A medium and the information recorded on it that generally has permanence and can be read by a person or machine.

Effective Date	<p>Effective date has one of the following meanings, based on the circumstances in which it is used:</p> <ol style="list-style-type: none"> (1) For a solicitation amendment, change order or administrative change, the effective date will be the issue date of the amendment, change order or administrative change. (2) For a supplemental agreement, the effective date will be the date agreed upon by the contracting parties. (3) For a modification issued as a confirming notice of termination for the convenience of the Government, the effective date of the confirming notice will be the same as the effective date of the initial notice. (4) For a modification converting a termination for default to a termination for the convenience of the Government, the effective date will be the same as the effective date of the termination for default. (5) For a modification confirming the termination contracting officer's previous letter determination of the amount due in settlement of a contract termination for convenience, the effective date will be the same as the effective date of the previous letter determination.
Estimating System	<p>A contractor's policies, procedures and practices for generating cost estimates which forecast costs based on currently available information. An estimating system includes the organizational structure; established lines of authority, duties and responsibilities; internal controls and managerial reviews; flow of work, coordination and communication; and estimating methods, techniques, accumulation of historical costs and analyses used to generate costs estimates and other data included in proposals.</p>
Government Furnished Property	<p>Property which the Government has possession of and provides to a contractor or directly acquires to provide to the contractor, including related data and information requested or furnished to the contractor that is reasonably required for the intended use of the property.</p>
Growth Work	<p>Any additional work that is identified after contract award or definitization that is related to a work item included in the contract award. Growth does not include pre-priced options or reservations that were specifically identified in the solicitation or defined package.</p>
Indirect Appeal	<p>Assertion by the subcontractor of the prime contractor's right to appeal or the prosecution of an appeal by the prime contractor on the subcontractor's behalf.</p>
Inspection	<p>The act of measuring, examining, testing, gauging or otherwise comparing of supplies or services with requirements to determine conformity.</p>
Inspection Record	<p>Recorded data concerning inspection results.</p>
International Organization for Standardization (ISO)	<p>A worldwide federation of national standards bodies.</p>
Lead Auditor/Team Leader	<p>A person who is qualified to perform and designated to lead/manage a quality audit team.</p>

Major Nonconformity (Method B)	A nonconformance that judgment and experience indicate could impair the performance or life of the product and/or result in hazardous or unsafe conditions for the user.
Minor Nonconformity (Method A)	A nonconformance or flaw that will probably not impair the performance or life of a product, nor result in unsafe conditions for the user (previously referred to as Method A corrective action).
NAVSEA Standard Item (NSI)	Those items written to describe procedures and general requirements for the Item performance of work to be accomplished under the job order. The Standard Specification for Ship Repair and Alteration Committee approves NSIs. NSI numbers are assigned in a 009-XX series.
New Work	Any additional work identified after contract award or definitization that is not related to a work item that was included in the original contract award.
Nonconformance	A departure of a quality characteristic from its intended level or state that occurs with a severity sufficient to cause an associated product or service not to meet a specification requirement.
Objective Quality Evidence (OQE)	Any statement of fact, either quantitative or qualitative, pertaining to quality of a product or service based on observations, measurements or tests that can be verified.
Observation	An action that occurs when one attribute is verified to one unit of product.
Preventive Action	An action taken to eliminate the causes of a potential nonconformity, or other undesirable situation, to prevent occurrence.
Process	A set of interrelated resources and activities that transform inputs into outputs with the aim of adding value.
Process Quality Audit	An analysis of elements of a process and appraisal of completeness, correctness of conditions and probable effectiveness.
Product Quality Audit	A quantitative assessment of conformance to required product characteristics.
Products	The results of activities or services; a generic term that denotes goods and/or services.
Quality	The composite of all features and characteristics of a product or service that bear on its ability to satisfy given needs.
Quality Assurance	A planned and systematic pattern of all actions necessary to provide adequate (QA) confidence that the product or service conforms to established technical requirements.
Quality Audit	A systematic and independent examination to determine whether quality activities and related results comply with planned arrangements and whether these arrangements are implemented effectively and are suitable to achieve objectives.
Quality Management System	The organizational structure, responsibilities, procedures, processes and resources for implementing quality management.

Quality Management System Audit	A functional audit where a documented activity is performed to verify, by examination and evaluation of System objective evidence, that applicable elements of the quality management system are suitable and have been developed, documented and effectively implemented in accordance with specified requirements.
Record	A document that contains objective evidence that shows activities performed or results achieved.
Significant Estimating System Deficiency	A shortcoming in the estimating system which is likely to consistently result in proposal estimates for either total cost or a major cost element which are not an acceptable basis for negotiation of fair and reasonable prices.
Specification	The document that prescribes the requirements with which the product or service has to conform.
Subcontract	Any contract as defined in FAR Subpart 2.101 and entered into by a subcontractor to furnish supplies or services for performance of a prime contract or a subcontract. A subcontract includes but is not limited to purchase orders and changes and modifications to purchase orders.
Subcontractor	Any supplier, distributor, vendor or firm that furnishes supplies or services to or for a prime contractor or another subcontractor.
Supplemental Agreement	A contract modification that is accomplished by the mutual action of the parties.
Systemic/Critical Nonconformance (Method C or Method D)	A nonconformance related to system or critical failures that require a high level of management action.
Technical Data	Recorded information (regardless of the form or method of recording) of a scientific or technical nature (including computer databases and computer software documentation). This term does not include computer software or financial, administrative, cost or pricing, or management data or other information incidental to contract administration. The term includes recorded information of a scientific or technical nature that is included in computer databases. For these purposes, technical data includes the characteristic of a particular science, trade or profession.
Termination Contracting Officer	A contracting officer who is settling terminated contracts. A single contracting officer may be responsible for duties in any or all of these areas.
Testing	A means of determining the capability of an item to meet specified requirements by subjecting the item to a set of physical, chemical, environmental or operational actions and conditions.
Unilateral Modification	A contract modification that is signed only by the contracting officer.
(V)	A symbol inserted in a Work Item to establish a point in the sequence of accomplishment of work at which time the contractor shall inspect/verify and document the inspection or test. (V) inspections require verification by the trade supervisor, inspector or qualified tradesperson.
Verification	The process of confirming by examination and provision of objective evidence that specified requirements have been fulfilled.

Waiver	A written authorization to use or release a quantity of material, components or stores already manufactured but not conforming to the specified requirements.
Waterline	The term “waterline” in this manual refers to where the hull of a ship meets the surface of water when afloat.
Work	a. Any action that actually or potentially changes (including disassembly for the purposes of inspection or repair) the approved configuration of any part, component or ship’s system.
Work (Cont’d)	b. Any action that removes or affects the ship’s ability to operate ship’s systems or components in accordance with ship’s systems/operating manuals or reactor plant manuals. c. Any testing or inspections required to establish, maintain or reestablish certification. d. Any design, engineering, planning or configuration management functions that involve the final review and/or approval of technical information. Examples of work include the following: 1. Action which disassembles or removes any part, component or ship’s system. 2. Action specified in a Technical Work Document. 3. Any action that removes or affects the ship’s ability to operate ship’s systems or components in accordance with ship’s systems manuals, operating manuals or reactor plant manuals, excluding tagout in accordance with the Tagout Users Manual, including but not limited to: (a) Component or system tests. (b) Intrusive inspections (such as breaking the plane of electrical panels requiring electrical safety). (c) Valve line ups that alter the normal system line up not governed by operating procedures. (d) Removing valve hand wheels, disconnecting of reach rods.
Work Items	Work Items are work specifications that are prepared to accomplish repair or alteration work in ship repair. These items must be locally reviewed for applicability, quality and technical requirements and tailored to suit the specific work requirements.

VOLUME VII

CHAPTER 1

CONTRACTED SHIP REPAIR FUNCTIONS, TASKS AND STANDARDS OF CONDUCT

REFERENCES.

- (a) FAR Part 14 - Sealed Bidding
- (b) FAR Part 15 - Contracting by Negotiation
- (c) FAR 42.201 - Contract Administration Responsibilities
- (d) FAR 42.302 - Contract Administration Functions
- (e) FAR 42.2 - Contract Administration Services
- (f) FAR 42.3 - Contract Administration Office Functions
- (g) 5 CFR 2635 - Standards of Ethical Conduct for Employees of the Executive Branch
- (h) DoD Directive 5500.7 - Standards of Conduct
- (i) U.S. Navy Regulations Article 1115
- (j) SECNAVINST 5430.92 - Assignment of Responsibilities to Counteract Fraud, Waste and Related Improprieties within the Department of the Navy
- (k) OPNAVINST 4700.7 - Maintenance Policy for U.S. Naval Ships
- (l) NAVSEA SL720-AA-MAN-030 - Navy Modernization Process Management and Operations Manual (NMP-MOM)
- (m) DoD Directive 5000.1 - The Defense Acquisition System
- (n) SECNAVINST 5400.15 - Department of the Navy Research, Development and Acquisition, and Associated Life Cycle Management Responsibilities
- (o) OPNAVINST 4780.6 - Policy for Administering Service Craft and Boats in the Navy
- (p) FAR 203
- (q) NAVSEAINST 5730.1 - Legislative and Congressional Matters
- (r) NAVSEAINST 7500.1 - Audits of NAVSEA by External Audit Organizations

1.1 CONTRACTED SHIP REPAIR FUNCTIONS AND TASKS OVERVIEW. This chapter provides an overview of the Regional Maintenance Center (RMC) functions, responsibilities, standards of conduct and organizational relationships.

1.2 CONTRACTED SHIP REPAIR FUNCTIONS AND TASKS.

1.2.1 Functions. This section outlines RMC responsibilities for ship repair and modernization work that is contracted to the private sector for accomplishment. These may include:

- a. Performing functions of Procuring Contracting Officer (PCO) and Administrative Contracting Officer.
- b. Developing specifications necessary to solicit contract proposals and bids for assigned PCO functions and Naval Sea Systems Command (NAVSEA) procurements.
- c. Providing planning and estimating, workload forecasting and oversight for planned and unplanned availabilities.
- d. Conducting engineering, technical and design oversight, evaluation and surveillance.
- e. Performing engineering and design services in support of waterfront (emergent) technical issues.
- f. Budgeting, administering and accounting for funds.
- g. Providing management coordination and oversight of contracts to ensure requisite quality, schedule attendance and cost propriety.
- h. Monitoring and evaluating integrated logistics support and procurement of Government Furnished Material.

1.2.1.1 Mission Tasks. Other mission tasks include the following:

- a. Providing guidance to area Commanders and RMCs.

- b. Ensuring a comprehensive security program.
- c. Performing mobilization logistics planning.
- d. Training Navy reserve units for mobilization requirements.
- e. Administering facilities contracts covering Government-owned materials in private shipyards as assigned.
- f. Administering real property and Navy facility leases as assigned.
- g. Administering Government-owned drydocks leased to private shipyards as assigned.
- h. Performing berthing and messing program administration during contract execution.
- i. Executing civilian personnel services as assigned.
- j. Performing planning responsibilities.
- k. Performing Ship Availability Planning and Engineering Center Planning Activity responsibilities as assigned.
- l. Providing Contracting Officer's Representative support.
- m. Developing standard specifications.
- n. Performing annual inspection on Navy ship memorials as assigned.
- o. Provide oversight of demilitarization and stripping of ships programmed for disposal or for sale to private concerns.

1.2.2 Procurement and Contract Administrative Functions of the Regional Maintenance Center.

- a. The RMC performs the functions of the PCO for purposes of placement of job orders under the Master Agreement for Repair and Alteration of Vessels, Master Ship Repair Agreement or the Agreement for Boat Repair as described in Chapter 3 of this Volume by sealed bidding, by negotiation, reference (a) or reference (b). The RMC also exercises the options under Private Sector Industrial Activity contracts and other contracts as assigned.
- b. The RMC is responsible for performing all of the contract administration services listed in references (c) and (d) to the extent applicable to Master Ship Repair Agreement job orders, Private Sector Industrial Activity contracts and to other contracts assigned at commercial shipyards under RMC cognizance.
- c. With respect to the administration of contracts other than shipbuilding, conversion and repair, the RMC will perform contract administration functions listed in references (e) and (f) when requested by the PCO. When resources are not available to perform such functions, the RMC will advise the activity awarding the contract which functions cannot be performed and why.

1.2.3 Relationship with Contractors.

- a. In official transactions with contractors, the RMC Contracting Officer is the direct representative of the U.S. Government and Commander, Naval Sea Systems Command as Head of Contracting Agency. Therefore, contractors will address any correspondence on such matters directly to the RMC Contracting Officer who, if deemed advisable, may discuss it with or refer it to NAVSEA for resolution. When making referrals to NAVSEA, the RMC will include definitive recommendations for action. NAVSEA, after resolving referrals, should keep the RMC informed of the proposed resolution prior to initiating discussions with or instructions to the contractor.
- b. The RMC shall ensure that contractors are not given access to Navy files, even when requested under the Freedom of Information Act, unless approved by counsel. Neither should contractors be furnished copies of correspondence or included as an addressee on correspondence pertaining to a claim, controversial subject matter or any subject matter on which it may become necessary for the command to issue instructions or render decisions.

- c. RMC personnel shall exercise good judgment when originating constructive changes. This refers to any communication, other than a change order or formal contract modification, received by a contractor from a representative of the Government, or as an act of omission of the Government, that has the effect of requiring a contractor to perform work different from or in addition to that which the contract prescribes. When RMC correspondence is sent to a contractor that will have a significant impact on operations, progress payments, responsibility, etc., it shall be signed by a contracting officer or an authorized representative, and a receipt shall be obtained for mail or hand-carried delivery.
- d. Contractual direction can be given only in writing by the PCO or Administrative Contracting Officer.

1.2.4 Standards of Conduct.

- a. Congress has passed numerous ethics laws such as reference (g). The Executive branch has promulgated Government-wide regulations addressing the standards of ethical conduct expected of Government employees, both military and civilian. Reference (h) promulgates more stringent guidelines and regulations that are specifically imposed on personnel who represent the Government in business dealings with representatives of industry and occupy positions of trust and responsibility that require them to observe the highest ethical standards. Practices that may be acceptable in the private business world are not necessarily acceptable for naval personnel. Acceptance of favors, gratuities or entertainment may be a source of embarrassment to the Department of the Navy and to the naval personnel involved. These favors may affect the objective judgment of the recipient and may impair public confidence in the integrity of business relations between the Department and industry.
- b. No person shall place himself or herself in a position in which conflict of interests might arise or might justifiably be suspected. Such a conflict might entail gratuities, entertainment of any kind or any other action that could influence or be reasonably interpreted as influencing the strict impartiality that must prevail in all business relationships involving the public interest. Favors, gratuities or entertainment bestowed upon members of the immediate household of naval personnel shall be considered in the same light as those bestowed upon Navy personnel.
- c. All personnel shall exercise special diligence to prevent fraud, collusion, larceny, embezzlement or other improper conduct within the area of their responsibilities and shall report immediately to the RMC any instance of fraud or other improper conduct they observe or suspect.
- d. The RMC Commanding Officer, by means of a local instruction, shall provide each of his personnel with the policy and procedures promulgated by the Department of Defense (DoD), Secretary of the Navy, and NAVSEA with respect to standards of conduct, and shall establish a plan of action that institutes measures to minimize the possibility of improper conduct.

1.2.5 Fraudulent Violations or Irregularities.

- a. References (i) and (j) require Navy personnel, both military and civilian, who have any reason to suspect or have knowledge of any fraud in connection with Government procurement, to report it immediately to proper authority. Since many RMC personnel are in close contact with contractors, RMC Commanding Officers shall ensure all personnel are familiar with these directives and understand that violations may be cause for appropriate disciplinary action that may include fines, imprisonment.
- b. RMCs shall develop and execute a plan to minimize the potential for misconduct. In formulating the plan, the following shall be considered:
 - (1) Increasing visits to Government personnel at remote contractors' sites through unscheduled inspections of specific operations by military or civilian supervisors.
 - (2) Reducing tour length of Government personnel at remote sites.
 - (3) Requiring that preparation of a specification and inspection/acceptance of work under that specification be performed by different individuals.
 - (4) Auditing work authorized on-site for actual completion.
 - (5) Auditing accepted work for conformance to specifications.

- (6) Auditing Government property administrator's decision on scrap, repairable items and mandatory returnable items.
- (7) Auditing scrap materials sold to the contractors by Government property administrators to insure that it is scrap.
- (8) Being alert for signs of affluence not commensurate with economic status of Government employees.
- (9) Providing for the personal attention of the RMC and first line supervision in order to indicate a command requirement for absolute adherence to the Standards of Conduct.
- (10) Being observant for possible falsification of inspection records.

1.3 ORGANIZATIONAL RELATIONSHIPS FOR VESSEL MODERNIZATION, OVERHAUL, REPAIR AND MAINTENANCE CONTRACTING.

1.3.1 General. The following sections discuss the basic responsibilities of Navy and other activities as they affect the operations and functions of the contracting process and the relative position of the RMC in this organization.

1.3.2 Chief of Naval Operations.

- a. The Chief of Naval Operations (CNO) is responsible to the Secretary of the Navy for the readiness, use and logistics support of all U.S. Naval Forces. As the military chief of the Navy, the CNO is the principal advisor to the Secretary of the Navy and the executive branch of the Government on naval military matters. The CNO formulates detailed strategic plans to carry out the missions assigned to the Navy. These strategic plans generate broad logistics requirements that are assigned to the several Systems Commands (SYSCOM) and offices for further implementation. In this manner, the CNO justifies and supports requests to Congress for the necessary funds to carry out specific ship modernization, repair and maintenance programs. Acting in staff capacity in the office of CNO, the Ships Characteristics Improvement Panel, which supports the Resources and Requirements Review Board, determines the characteristics of the ships which the Navy's military missions demand. These characteristics are subsequently translated into requirements that are then assigned to NAVSEA for action. After assignment to NAVSEA, proposed changes to operational requirements (military characteristics) through conversion or modernization must be approved by the CNO.
- b. The CNO ship maintenance and repair policy is provided in reference (k). Policies and procedures for maintenance of ships and modernization are established in reference (l), Volumes I and II. Further information on the Navy Modernization Process (NMP) is contained in Volume VI, Chapters 3 and 36 of this manual. In establishing Navy policy for Fleet maintenance and modernization and budgeting and scheduling for ship repair and modernization availabilities, the CNO is assisted by an operating staff in the Office of Naval Operations. The Office of Naval Operations staff includes specific ship type and logistics support sponsors who consolidate budget submissions from the Fleet and assist in the overall development and administration of the Navy's maintenance and modernization budget. The platform sponsors are major participants in the development of the NMP. In the case of repair and modernization, the CNO has retained approval authority for:
 - (1) Establishing modernization and repair availability schedules and major changes to those schedules.
 - (2) Determining military characteristics of ships and of alterations that affect these military characteristics.

1.3.3 Systems Commands.

- a. To provide support for the operating Fleet, the Navy has established five SYSCOMs with specific support responsibilities. These SYSCOMs are:
 - (1) Naval Sea Systems Command (NAVSEASYSCOM or NAVSEA).
 - (2) Naval Air Systems Command (NAVAIRSYSCOM).
 - (3) Space and Naval Warfare Systems Command (SPAWARSYSCOM).

- (4) Naval Supply Systems Command (NAVSUPSYSCOM).
- (5) Naval Facilities Engineering Command (NAVFAC).
- b. The Navy SYSCOMs establish technical requirements and meet logistics, maintenance and support requirements of Fleet Commanders in the area of new construction and ship maintenance. In addition, these SYSCOMs provide technical requirements for maintenance and conduct analyses to determine the proper balance between design improvement and logistics support to achieve the required operational availability.

1.3.4 Naval Sea Systems Command.

- a. For procurement purposes, Commander, Naval Sea Systems Command (COMNAVSEA) is Head of Contracting Agency with delegated authority in the Federal Acquisition Regulation to enter into and administer contracts for materials and services for which the Commander is responsible. COMNAVSEA, in turn, has delegated this authority to the Deputy Commander for Contracts (NAVSEA 02). Delegation of authority to the RMC Contracts Department Head is addressed in the NAVSEA Contracts Handbook and in subsequent chapters of this volume. Only COMNAVSEA and individuals designated by NAVSEA 02 who are duly authorized and acting within the limits of their written delegated authority can commit the Government to any contractual action.
- b. Specific NAVSEA mission functions include the provision of material support to the Navy and Marine Corps for ships and craft, shipboard weapons systems and components, ammunition, guided missiles, mines, torpedoes and all other surface and underwater ordnance expendables. Material support encompasses the complete life cycle from research and design through sustained technical direction and acquisition in support of Fleet readiness. These responsibilities include ships, submarines and other sea platforms, except service craft assigned to the NAVFAC and ships administratively assigned to the Military Sealift Command.
- c. As the agent of the CNO, NAVSEA maintains the Maintenance and Modernization IT Systems and develops documentation for all authorized alterations. NAVSEA also authorizes and funds all program alterations not authorized and funded by the cognizant Type Commander (TYCOM). The maintenance, repair and modernization of ships, submarines, craft and boats assigned to the operating forces may be carried out by assignment of work to Naval Shipyards (NSY) or by procurement of services and material from private industry through the RMCs or Supervisors of Shipbuilding, Conversion and Repair, USN (SUPSHIP).
- d. Under the CNO, NAVSEASYSCOM's basic mission as related to ship modernization, repair and maintenance is to provide acquisition, engineering, logistic and material support for the Navy. As the technical and engineering authority for ships of the Navy, NAVSEA, in support of the designated Program Executive Office (PEO), is responsible for the life cycle management of Navy ships, submarines, craft and boats, including the following:
 - (1) Developing Maintenance Plans for each ship class.
 - (2) Supporting Fleet Maintenance Officers in scheduling ships for availabilities.
 - (3) Managing alteration development and executing the NMP.
 - (4) Providing acquisition, engineering and technical authority, Occupational Safety and Health, environmental support, and Contract Administration Quality Assurance Program assistance to the Fleet Maintenance Officers and RMCs.
 - (5) Operation of the NSYs, SUPSHIP, and RMC Contracting Offices.
- e. NAVSEA provides direct support to the PEOs who report directly to Assistant Secretary of the Navy (Research, Development and Acquisition) (ASN (RD&A)).
- f. Developing, validating and maintaining Organizational, Intermediate and Depot-level maintenance requirements and tasks in the Planned Maintenance System.

1.3.5 Program Executive Office Program Offices. The Navy Acquisition Executive Responsibilities assigned to the ASN (RD&A) are contained in references (m) and (n) and include supervision of the SYSCOM Commanders (NAVSEA) and PEOs relative to Research, Development and Acquisition matters. In most cases, PEOs function in matrix type organizational structures with reporting responsibilities to both ASN (RD&A) and the Commanders of the respective SYSCOMs. The PEOs are tasked with acquisition and life cycle management of their assigned programs. Within the PEO organizational structure are the Program Management Offices that report directly to the PEO. Within each program office, an individual manager is assigned as the Ship Program Manager and is responsible for a specific ship class. The Ship Program Managers provide centralized management for assigned ship classes. This assignment may be for ship conversion, modernization, repair or life cycle maintenance.

1.3.6 Logistics, Maintenance and Industrial Operations Directorate (SEA 04). The consolidation of the Fleet Logistics Support Directorate (SEA 04) and the Regional Maintenance and Industrial Operations Directorate (SEA 07) as well as several functions of other NAVSEA Directorates into the Logistics, Maintenance and Industrial Operations Directorate (SEA 04), was designed to strengthen and improve important headquarters functions. The organization is constituted to closely support the requirements and functions of the Deputy Chief of Naval Operations (Logistics) (N4) and Fleet Maintenance Officers as customers. The Directorate will develop policy and infrastructure associated with ship maintenance, logistics support, environmental and safety programs and related efforts.

1.3.7 The Atlantic and Pacific Fleets. The Commander, United States Fleet Forces Command and the Commander, Pacific Fleet are responsible for the readiness condition of their assigned ships. The Commanders must balance the competing needs of the operational Fleets with the need for maintenance and modernization of the Fleet. Ships and craft under their cognizance comprise the largest portion of the repair and overhaul workload. Fleet Commanders, through their respective Fleet Maintenance Officers, are responsible for the budgeting, scheduling and execution of CNO-scheduled ship maintenance and modernization availabilities plus emergent maintenance requirements. Fleet Commanders and COMNAVSEA are actively developing new ship maintenance procedures and processes, and initiatives that are being integrated into this manual that support the concept of Continuous Maintenance. The Fleet Commanders determine ship deployment schedules and, within guidelines published by the CNO, approve changes in scheduled maintenance availability dates for their assigned ships. Through the respective TYCOMs, the Fleet Commanders provide funding for advance planning and execution of scheduled ship maintenance availabilities. In the area of new construction, Fleet activities provide input to the development of ship characteristics and become involved in final trials, delivery, Post Shakedown Availabilities and guarantee periods of newly delivered ships.

1.3.8 Type Commanders.

- a. TYCOMs and RMCs are responsible for budgeting to support modernization, repair and maintenance availabilities and for the material readiness and training of their assigned ships. Under guidelines established by the CNO and Fleet Commanders, the TYCOMs and RMC manage funds for advance planning for repairs and some selected alterations, and execution of the availabilities. Within guidelines established by the CNO and Fleet Commanders, the TYCOMs in concert with the numbered Fleet Commanders (Commander, Second Fleet, Commander, Third Fleet, etc.) schedule ships for deployment and other operational assignments. In this regard, the TYCOM is one of the most important activities involved in scheduling ship repair planning activities that directly involve the ship or the ship's crew.
- b. TYCOMs provide advanced planning funding to the respective ships Maintenance Team for availability planning. After the availability work package has been identified and documented, the TYCOM provides funding for accomplishment of repairs and some of the alterations. The Ashore Ships Maintenance Manager, working with their respective Maintenance Team, is responsible for management of all TYCOM advance planning and works closely with the contract administrative team to execute the terms and conditions of contracts for their assigned ship(s). The CNO has delegated authority to RMC COs to assign unscheduled availabilities for ships under their cognizance. In support of new construction, TYCOMs have a primary mission to provide input to the development of ship characteristics and become involved in trials, delivery and guarantee periods of newly delivered ships as outlined in Volume I of this manual.

1.3.9 Naval Shipyards. The NSYs are operated by Commander, Naval Sea Systems Command and report directly to NAVSEA 04 for business and technical matters. The NSYs are strategic industrial assets with mobilization responsibilities. They maintain core ship conversion, modernization and repair industrial capabilities to support our national strategies for forward force projection. The core capabilities include extensive nuclear and non-nuclear ship engineering disciplines, nuclear and non-nuclear repair and productive capabilities.

1.3.10 U.S. Ship Repair Facility, Yokosuka, Japan. This U.S. Navy managed repair facility is manned by U.S. military and civilian personnel along with Japanese employees. It has the same basic industrial capabilities as those of our industrial naval shipyards except that there are no nuclear maintenance capabilities.

1.3.11 User Commands or Activities (Users). In accordance with reference (o), the CNO assigns service craft and boats to Users. These craft and boats are maintained and overhauled from funds granted by Support Commanders to their subordinate activities that are the Users. Service craft and boats under the cognizance of the Users comprise a portion of the RMC repair and overhaul workload. For example, Naval Station Port Operations are assigned service craft that support home ported or visiting ships.

1.3.12 Naval Inactive Ship Maintenance Facilities. The RMC may be required to support the inactivation of ships scheduled for retention at Inactive Ship Maintenance Facilities. The work involved is the effort that is beyond the capability of Ship's Force and includes such tasks as hull blanking, gas freeing of tanks, hydro-blasting Collection, Holding and Transfer systems and towing preparations. The TYCOM normally authorizes the work and NAVSEA funds such work. In some cases, inactive ships may be reactivated for delivery to foreign Governments through the Foreign Military Sales Program. This work is normally authorized and funded by NAVSEA or higher authority.

1.3.13 Naval Reserve Force Vessels. Ships assigned for training Naval Reserve Force personnel comprise a portion of the RMC workload. The TYCOM who has cognizance over these ships authorizes and funds the repair and overhaul work.

1.3.14 Defense Finance and Accounting Service Offices. Accounting and disbursing operations in the continental United States and Hawaii are consolidated at designated Defense Finance and Accounting Service Centers and Operating Locations. All contracts, agreements and orders citing Navy appropriations and funds paid by Defense Finance and Accounting Service disbursing offices will show the appropriate paying office.

1.3.15 Defense Contract Audit Agency.

- a. Contract auditing is a function of Defense Contract Audit Agency (DCAA). The DCAA has subordinate field offices including district/regional, branch, procurement liaison, contractor residency and contract audit coordination offices. The DCAA office performs these basic functions:
 - (1) Advising on the allowance of costs under cost-reimbursement-type contracts.
 - (2) Providing, as a minimum, quarterly advisory audit reports to assist in pricing actions under all types of contracts.
 - (3) Validates the contractor's finances and accounting system that is used by the RMC's Contracts Department to establish forward pricing rates.
 - (4) Performs financial capability audits when requested by the Contracting Office.
 - (5) Conduct floor audits to validate personnel assignments to work sites.
- b. DCAA auditors render assistance in connection with payments, termination settlement proposals, adjudication of claims and pricing of certain negotiated changes. The DCAA plays an important role in the award and administration of contracts; however, this role is that of an advisor to the RMC Contracts Department Head, with RMC retaining responsibility for subsequent contractual actions. The RMC has full responsibility for contract administration and shall make final decisions regarding advice provided by DCAA. Any departure from DCAA recommendations must be fully justified.

1.3.16 Defense Contract Management Agency Components.

- a. Within an assigned area, a DoD Contract Administration Service component is responsible for the field administration of all contracts placed by DoD activities. Reference (p) identifies all Defense Contract Management Agency and other agency components engaged in the performance of contract administration services, together with their geographic or plant cognizance assignments, and the services they perform. The directory can be accessed electronically via the World Wide Web.
- b. The RMC may be required to perform certain contract administration functions, such as performance of quality assurance, source inspection, etc., at a subcontractor's plant under the cognizance of another Defense Contract Management Agency component. These services are requested in accordance with reference (e).
- c. In vessel acquisition procurements, the Defense Contract Management Agency Component usually is responsible for:
 - (1) Administering DoD contracts for components to be provided as Government Furnished Material to vessel acquisition contractors.
 - (2) Performing source inspection, progressing and expediting actions in connection with Government Furnished Material services and technical data.
 - (3) Acting as disposal officer in the sale of terminal inventories.

1.3.17 General Accounting Office. The General Accounting Office (GAO), although not a part of the Navy, is involved with Navy fiscal and contract matters. The GAO is entirely separate from the executive branch of the Government and acts as the agent of Congress in investigating all matters relating to Government procurement. Representatives of GAO make periodic visits to maintenance related activities. All communications to GAO on matters involving contracts will be processed in accordance with references (q) and (r).

1.3.18 Naval Reactors Representatives. A representative of the U.S. Department of Energy, entitled "Naval Reactors Representative", is assigned to each shipyard performing naval nuclear propulsion plant work. The Naval Reactors Representative reports to the Director, Division of Naval Reactors and Department of Energy. The representative performs an independent review and surveillance of all shipyard work relating to naval nuclear propulsion matters. The representative has free access to all elements of the shipyard and the RMC office that deals directly or indirectly with naval nuclear propulsion. The representative's review and surveillance does not detract from, change or diminish the existing responsibility of any shipyard or RMC officials. The Naval Reactors Representative is provided suitable and sufficient office space in the shipyard and other administrative support to carry out assigned functions.

1.3.19 Foreign Governments. RMCs may interact with foreign Governments, when requested by the CNO or NAVSEA, to procure commercial repair work to:

- a. Recondition and otherwise repair Navy ships that are to be, or have been, transferred to foreign Governments.
- b. Effect emergency voyage repairs or other services for vessels of foreign Governments, when approved by CNO.

1.3.20 Private Companies - Demilitarizing and Stripping. The RMC may be required to arrange for the demilitarization and stripping of ships that are programmed for disposal or for sale to private concerns. In the case of ships programmed for disposal, these functions, when not performed by the activity having cognizance of the vessel, are carried out by the responsible RMC. When the ships are sold to private concerns, the work will be performed by the purchasing contractor as a condition of sale. In these cases, the RMC will be requested to provide surveillance over the work to ensure its proper performance. Of particular concern is the compliance with Environmental Protection Agency rules and regulations where there is potential for environmental impacts resulting from work associated with disposal action.

VOLUME VII
CHAPTER 2
CONTRACTS AND CONTRACT ADMINISTRATION

REFERENCES.

- (a) NMCARS 5201 - Federal Acquisition Regulations System
- (b) FAR Part 1.3 - Agency Acquisition Regulations
- (c) FAR Part 1.4 - Deviations
- (d) DFARS 201.4 - Deviations From the FAR
- (e) ONRINST 5400.1 - Obtaining Waivers Under Office of Naval Research Designation as a Reinvention Laboratory
- (f) 31 U.S. Code 1535 - Agency Agreements
- (g) FAR Part 2.1 - Definitions
- (h) FAR Part 9 - Contractor Qualifications
- (i) FAR Part 16 - Types of Contracts
- (j) FAR Part 14 - Sealed Bidding
- (k) FAR Part 15 - Contracting by Negotiation
- (l) FAR Part 1.6 - Career Development, Contracting Authority and Responsibilities
- (m) NAVSEAINST 4200.17 - Contracting Officer's Representative
- (n) FAR Part 42 - Contract Administration and Audit Services
- (o) NMCARS 5242 - Contract Administration and Audit Services
- (p) NAVSEA Contracts Handbook (NCH)
- (q) DoD Directive 5000.1 - The Defense Acquisition System
- (r) DFARS 219 - Small Business Programs
- (s) NMCARS 5219 - Small Business Programs
- (t) SECNAVINST 4380.8 - Implementation of the Department of the Navy Small and Disadvantaged Business Utilization (SADBU) Program
- (u) FAR Part 49 - Termination of Contracts
- (v) FAR Part 43 - Contract Modifications
- (w) NAVSEAINST 9210.4 - Changes, Repair and Maintenance to Nuclear Powered Ships
- (x) NMCARS 5233 - Protests, Disputes and Appeals
- (y) DFARS 252 - Solicitation Provisions and Contract Clauses
- (z) DFARS 222 - Application of Labor Laws to Government Acquisitions
- (aa) FAR Part 44 - Subcontracting Policies and Procedures
- (ab) FAR Part 52 - Solicitation Provisions and Contract Clauses
- (ac) NMCARS 5219.7 - The Small Business Subcontracting Program
- (ad) 10 U.S. Code 2306 - Kinds of Contracts
- (ae) 41 U.S. Code 254 - Contract Requirements

LISTING OF APPENDICES.

- A Memorandum of Understanding Between NAVSEA and NAVSUP of August 2004
- B Basic Acquisition Process

2.1 **PURPOSE.** This chapter provides an overview of contracts and contract administration as it applies to Navy ship repair and modernization work. It is specifically intended to provide an understanding of these processes to non-contracting personnel and should not be used as a reference for contractual actions undertaken by Procuring or Administrative Contracting Officers (ACO).

2.2 OVERVIEW OF THE FEDERAL ACQUISITION PROCESS.**2.2.1 Procurement from Private or Government Sources.**

- a. Once it is determined that an agency is authorized to undertake certain activities, it must then be determined what the appropriate way for the agency to accomplish its particular objectives is. The authority of the agency to use contractual agreements with private sources in carrying out authorized

programs is generally assumed in the absence of express statutory prohibitions or limitations. In some instances it may be more efficient and economical for an agency to use its own employees or requisition its needs from another agency in a position to supply those needs.

- b. Executive agencies have traditionally enjoyed broad discretion to achieve their objectives using Government employees or by contract with the private sector. Because of concerns that Government competition with private enterprise is inappropriate, the executive branch has an express policy that the Government should rely on the private sector to the greatest extent possible.

2.2.2 Contracting Techniques. Executive agencies generally have wide latitude in selecting the methods for awarding contracts, as well as the terms and conditions to be included. The contracting parties must be aware of the large number of statutes and regulations giving specific guidance on the techniques to be followed in entering into most Government contracts. Contracting Officers are expected to adhere to such statutes and regulations and, in most instances, the validity of contracts can be affected if they are not followed.

2.2.3 General Procurement Statutes. Congress has enacted two principal statutes establishing procedures for awarding Government contracts. The two statutes are the Armed Services Procurement Act of 1947 and the Federal Property and Administrative Services Act of 1949. These two Acts have governed the federal procurement process. They were revised by the Competition in Contracting Act of 1984, the Small Business and Federal Procurement Competition Enhancement Act of 1984, the Defense Procurement Reform Act of 1984, among other Acts. The Armed Services Procurement Act applied to purchases of the Army, Navy, Marine Corps, Air Force, Coast Guard and the National Aeronautics and Space Administration. The Federal Property and Administrative Services Act applied to purchases of the General Services Administration and other executive agencies except those covered by the Armed Services Procurement Act.

2.2.4 Procurement Regulations.

- a. Regulations issued by the various executive agencies contain detailed guidance as to both procedures for award and terms and conditions of contracts. The Federal Acquisition Regulations (FAR) replaced the Federal Procurement Regulation, the Defense Acquisition Regulation and the National Aeronautics and Space Administration Procurement Regulation. The chief goal of the FAR is to bring greater simplification and uniformity to the complex body of federal procurement regulations.
- b. While the policy concerning Government contracts is formulated and implemented largely within the executive agencies that enter into these contracts, such activity is also directly affected by pronouncements issued by the President and the Office of Federal Procurement Policy (OFPP). The President issues executive orders that authorize and require the use of clauses implementing various social and economic programs. As the paramount regulations in the executive branch, these orders must be complied with by the executive agencies. The Office of Management and Budget periodically issues circulars that embody executive policy and may be directed to regulating contracting activities. As regulations emanating from the Office of the President, Office of Management and Budget circulars have a status in the hierarchy of executive regulations above the procurement regulations promulgated by the agencies. The OFPP was created for the purpose of providing overall direction to federal procurement policy. The OFPP has the responsibility for formulating and implementing a uniform federal procurement system that consists of a single FAR and agency regulations limited to those necessary to implement or supplement the FAR. In addition, it granted the Administrator of the OFPP, with the concurrence of the Director of Office of Management and Budget, the authority to "issue policy directives for the purpose of promoting the development and implementation of the uniform procurement system."
- c. The procurement regulations and directives of major interest to contractual and technical personnel of the field office are briefly described below. Specific regulations, directives and other procurement publications are also referenced throughout the text.

2.2.4.1 Federal Acquisition Regulation. The FAR is the primary regulation for use by all Federal Executive agencies in their acquisition of supplies and services. The FAR precludes agency acquisition regulations that unnecessarily repeat, paraphrase or otherwise restate the FAR and limits agency acquisition regulations to those necessary to implement FAR policies and procedures within an agency. The FAR provides for coordination, simplicity and uniformity in the Federal acquisition process. The FAR can be electronically accessed at <https://www.acquisition.gov/far/>.

2.2.4.2 Department of Defense Federal Acquisition Regulation Supplement. The Defense Federal Acquisition Regulation Supplement (DFARS) is issued by the Secretary of Defense and establishes uniform policies and procedures that implement and supplement the FAR for Department of Defense (DoD). The DFARS contains guidance and direction to DoD personnel as to which provisions, clauses, cost principles and cost accounting standards are authorized for DoD contracts and what other procedures and actions must be followed in awarding and administering DoD contracts. The DFARS contains material that implements the FAR, as well as supplementary material that is unique to the DoD. This supplement is not a stand-alone document and must be read in conjunction with the FAR. The DFARS can be electronically accessed at <http://www.acq.osd.mil/dpap/dars/>.

2.2.4.3 Navy Marine Corp Acquisition Regulation Supplement. The Navy Marine Corp Acquisition Regulation Supplement (NMCARS) implements and supplements the FAR and the DFARS and establishes uniform policies and procedures for the acquisition of supplies and services for the Department of the Navy. The NMCARS is not a stand-alone document and must be read in conjunction with the FAR and DFARS. The NMCARS can be electronically accessed at <https://acquisition.navy.mil/rda/home/policyandguidance/nmcars>.

2.2.4.4 NAVSEA Contracts Handbook. The NAVSEA Contracts Handbook (NCH) is the Naval Sea Systems Command (NAVSEA) supplement to the FAR, DFARS, NMCARS and other acquisition policy and procedures for contracts, other transactions, cooperative agreements and grants. The NCH is not a stand-alone document. The NCH is authorized by reference (a). The NCH applies to NAVSEA Headquarters, Program Executive Officers and NAVSEA field organizations and representatives including the Regional Maintenance Center (RMC) Contracts Department Head and warranted Contracting Officers, for which Commander, Naval Sea Systems Command (COMNAVSEA) is the Head of Contracting Activity (HCA). In the event of a conflict, the FAR, DFARS or NMCARS shall take precedence over the NCH. Additionally, the NCH takes precedence over the guidance provided in this manual on contractual matters. The NAVSEA Contract Policy Office (NAVSEA 021) maintains the NCH and issues changes as required. Requests for deviations from the NCH must be submitted to NAVSEA 02B via NAVSEA 021.

2.2.4.5 Other Navy Publications. Although the NMCARS is the basic procurement publication issued at the Navy departmental level, procedures are further refined in directives, instructions, notices and other publications issued by direction of the Secretary of the Navy. Distribution of these publications may differ from the distribution of the NMCARS because of security considerations and other reasons. Accordingly, they are generally not made available to organizations outside the Government.

2.2.4.6 Command Publications. Subject to the provisions of references (b) and (c), procuring activities may issue procurement and related directives, instructions and other publications to implement and supplement FAR, NMCARS and other departmental publications. Each Command issues directives, instructions, notices and other publications that are necessary for the efficient performance of procurement operations.

2.2.4.7 Joint Fleet Maintenance Manual Relationship to Other Directives.

- a. This volume is issued in accordance with Memorandum of Understanding (MOU) between Commander, United States Fleet Forces Command, Commander, Pacific Fleet, Commander, Fleet Logistics Centers, Commander, Naval Supply Systems Command and COMNAVSEA. Additionally, reference (a) permits procuring activities to issue directives, instructions and other publications to supplement the FAR, DFARS, NMCARS, NCH and other Navy instructions.
- b. To the extent that a policy or a procedure is not addressed by the FAR, DFARS, NMCARS, NCH or other Navy and DoD Instructions, this manual provides the NAVSEA, United States Fleet Forces Command and Pacific Fleet policy and procedures concerning the contracting processes that are to be used by individual RMCs and Supervisors of Shipbuilding for procurement or administration of contracts for the conversion, modernization, repair and maintenance of ships, submarines, boats and craft, that are assigned to the respective RMC or Supervisor of Shipbuilding as the Naval Supervisory Authority (NSA). Where a policy or requirement is not established by FAR, DFARS, NMCARS, NCH or other Navy and DoD directives, this manual contains the procedural requirements for compliance. Otherwise, the FAR, DFARS, NMCARS, NCH and other Navy and DoD Directives take precedence over this manual. When a new or revised policy or requirement is promulgated by FAR, DFARS, NMCARS, NCH or other Navy and DoD Directives that are not consistent with this manual, the new or

revised policy and requirements shall be followed. Material required to be submitted to higher authority by the NMCARS or NCH shall be forwarded via the RMC Contracts Department Head or Chief of the Contracting Office at Supervisor of Shipbuilding to NAVSEA 02.

- c. Appendix A definitized the alignment of contracting responsibility among their subordinate commands.

2.2.4.8 Field Instructions and Notices. Each RMC is authorized to issue instructions and notices pertaining to contracting procedures that govern the internal operations of the office. Instructions may be issued to establish or explain organization, policy and procedures affecting more than one department of the RMC office and may remain in effect up to seven years. Notices may be issued to provide information of temporary interest and application to more than one department of the office. Each notice shall state its period of effectiveness up to a period of one year.

2.2.4.9 Waiver of Regulations and Directives. Reference (d) identifies policy for submitting requests for deviation from the FAR and reference (e) identifies policy for implementation of the Waiver and Reinvention Laboratory Programs within NAVSEA. Fleet personnel are encouraged to identify any regulation, directive, policy or procedure that can be modified, waived or eliminated in improving or streamlining business operations.

2.2.4.10 Impact of Statutes and Regulations. Regulations are issued by many offices in the agencies of the executive branch. There is frequently a substantial question as to their legal effect. When a board or court rules that a regulation is legally binding on either a contractor or the Government, that regulation is characterized as having the "force and effect of law". In such cases, the regulation is treated in the same manner as a statute. Generally, regulations shall have the force and effect of law if they are promulgated pursuant to specific statutory authority or formulated to implement a fundamental procurement policy and are appropriately published. RMCs should obtain the assistance of legal counsel in all such matters.

2.3 BUDGET/APPROPRIATIONS/ALLOCATION PROCESS. In order for any contract with the Government to be enforceable it must comply with certain legal requirements that apply to all Federal Government contracts.

2.3.1 Constitutional Authority. The Federal Government must be authorized by the Constitution to engage in the activity that is the subject of a contract.

2.3.2 Statutory Authorization. Before a contract can be entered into, there must be statutory authorization for the work being performed. Most agencies have a continuing grant of general authority to work in designated areas as a part of their basic mission. The Constitution also provides that "No money shall be drawn from the Treasury, but in consequence of appropriations made by law". Using this constitutional authority, Congress has prohibited the executive branch from entering into contracts prior to the appropriation of funds or in greater amounts than contained in appropriations.

2.3.3 Budget Authority.

- a. Budget authority may be provided either in the form of an appropriation act or by a grant of contract authority. Contract authority is permitted by the last phrase of reference (f) and shall usually be found in specific language in statutes authorizing programs and permitting the contracts prior to the passage of an appropriation act. Most contracting actions of the Federal Government are not based on contract authority and absence of appropriation legislation shall result in the contract not being enforceable against the Government. Leases made for periods longer than that covered by appropriated funds, and contracts made for amounts greater than appropriations, are not binding on the Government.
- b. In some cases, the executive agencies enter into agreements with contractors in advance of or in excess of appropriations, making the Government's obligation contingent on the passage of an appropriation. Since such agreements are not binding obligations of the Government until the passage of the appropriation, they do not violate the restrictions of reference (e).

2.3.4 Authorization of Appropriations.

- a. Prior to the passage of an appropriation act, funds for agency programs are usually "authorized" by special "authorization acts," which annually fund programs with dollar limitations. By the process of authorization legislation, the congressional committees with legislative jurisdiction over the agency conduct their initial review of the scope of agency programs and decide on the amount of funds that should be provided. This assures that these committees shall retain their prerogatives of control over the programs under their jurisdictions, and limits the appropriations committees to providing funds up to but not exceeding the authorized amounts. Since the authorization process is a working rule of

Congress, it would seem that an appropriation, even without the required authorization, would provide the necessary authority to enter into contracts. The courts have held, however, that an appropriation is not valid if there has been no authorization legislation because Congress may not legislate through appropriations laws. Authorization may also be in the form of provisions in the general legislation of the agency authorizing expenditures up to specified limits for designated programs.

- b. The legislative committees also retain control of this area in cases where “contract authority” is contained in the statute authorizing the undertaking of a program. In such cases, there is no process for review of the matter by the appropriations committees, yet the agency is authorized to enter into contracts. Of course, subsequent appropriations are necessary before the contractor can be paid, but it is assumed that such appropriations shall be forthcoming without contest.

2.4 **CONTRACTS.** A contract is an agreement between two or more parties that is enforceable by law. It may be agreed to either orally or in writing either as bilateral (two promises) or unilateral (promise for an act or forbearance of an act). Reference (g) contains a specific definition of a contract.

2.4.1 **Types of Contracts.** The Government enters into many types of contracts. Reference (f) lists the factors to consider when making a determination of what contract type best suits the specific procurement. In addition, Appendix A definitizes the contract authority for each activity’s subordinate commands. Reference (f) authorizes the use of various basic types of contracts (e.g., fixed-price, cost-reimbursement, etc.). Of these, the following are most commonly used by NAVSEA and RMCs for repair and modernization work:

- a. Firm Fixed Price (FFP).
- b. Fixed Price Incentive.
- c. Cost Plus Incentive Fee.
- d. Cost Plus Award Fee.
- e. Cost Plus Fixed Fee.
- f. Indefinite Delivery Type Contracts.
- g. Federal Acquisition Regulations also authorizes the use of any combination of the approved contract types. A fixed-price-award-fee contract may also be used when appropriate.

2.4.2 **Contract Selection.** The Government’s cost of an acquisition can be influenced substantially by the type of contract selected and the manner in which the contract is administered. Contract type and administrative practices can substantially influence quality and delivery. For the contractor, the improper use of contract types can result in financial setbacks or excessive profit.

2.4.2.1 **Fixed Price Contracts.** Fixed Price (FP) contracts usually stipulate a firm price. Under some circumstances, it may leave portions of the price open and provide for a later adjustment. The degree of risk assumed by the contractor shifts from the contractor to the Government when any variation of the FP type contract is used other than the FFP. In an FFP contract, the contractor bears the entire risk of both cost and performance. In the FP contract with economic price adjustment, the contractor bears all cost risks except that portion which is covered by the adjustment provisions. A Fixed Price Incentive contract provides for adjusting profit and establishing the final contract price by a formula based on the relationship of final negotiated total cost to total target cost, with the contractor bearing any costs in excess of ceiling price.

2.4.2.1.1 **Administration.** Market conditions cause contractors to submit bids well under what the work can reasonably be expected to cost in order to be the successful bidder. This “buy in” situation causes the winning contractor to aggressively seek every opportunity for contract growth and claims, and often at significantly higher cost than would normally be expected. The pre-award survey, reference (h), should screen out bids from contractors that are not responsible, meaning the contractor does not possess the managerial, financial and technical or facilities capabilities and capacities to comply with the terms and conditions of the contract. Non-responsive contractors are those that do not respond to the Invitation For Bid (IFB) in a timely manner or address the specific items of the contract in their bids. Contractors who do not have the capabilities required should not be awarded FFP contracts.

2.4.2.2 Cost Reimbursement Type Contracts.

- a. Cost reimbursement contracts, discussed in reference (i) are used when the estimate of costs is as reasonable as the circumstances permit, but because of the magnitude of uncertainties involved in the procurement, the risk is too great to expect a contractor to accept a FP arrangement of any type. In the Cost Plus Fixed Fee type, the Government agrees to pay all allowable costs that are incurred under the contract, plus a fixed-dollar amount of fee. A Cost Plus Incentive Fee type contract provides for an initially negotiated fee to be adjusted later by a formula based on the relationship of total allowable costs to total target costs. Under the Cost Plus Award Fee, the allowable costs are paid plus a fee. The fee typically consists of two parts, a fixed amount that does not vary with performance, and an award amount. The award amount is based upon a subjective evaluation of contractor performance by the Government, judged in light of criteria set forth in the contract. The criteria and rating plan should be tailored to the specific procurement in order to provide the most positive way to motivate a contractor toward improved performance.
- b. In a cost reimbursement type contract actual cost, plus fee, equals price.

2.4.3 Time and Materials Contract. This contracting method provides for payment to the contractor of direct labor hours at specified fixed hourly rates that include wages, overhead, general and administrative expenses and profit and materials at cost. A labor-hour contract is a variation of the time and material contract, differing only in that materials are not supplied by the contractor.

2.4.4 Indefinite-Delivery Indefinite-Quantity Contracts. These contracts are used when there is a recurring demand for an item and the timing and extent of demand cannot be determined at the time of award. The contract establishes all terms and conditions except those to be included in orders issued there under.

2.4.5 Letter Contracts. Letter contracts are used to authorize urgent work when work must be started immediately and negotiating a definitive contract is not possible in sufficient time to meet the requirement.

2.4.6 Basic Agreements. Basic agreements are umbrella-type arrangements to affect time savings for recurring requirements. While they are not contracts, they establish ground rules for the required and applicable clauses that shall be incorporated in contracts at future dates. The Master Ship Repair Agreement and Agreement for Boat Repair are examples of agreements and are discussed in Chapter 4 of this volume.

2.4.7 Basic Ordering Agreements. Basic Ordering Agreements (BOA) resemble the basic agreement. They go further by including a description of the supplies and services to be ordered and provide methods for pricing, issuing and determining future orders under the basic ordering agreement.

2.4.7.1 Description. A BOA is a written instrument of understanding, negotiated between an agency, contracting activity or contracting office and a contractor, that contains terms and clauses applying to future contracts between the parties during its term, a specific description of supplies or services to be provided, and methods for pricing, issuing and delivering future orders under the BOA. A BOA is not a contract.

2.4.7.2 Background. BOAs may be used to accomplish procurement for research and development, studies, services and shipbuilding post shakedown availabilities and hardware. Formal current internal instructions or procedures on effective field management control are required in conjunction with the responsibilities and authority delegated to the assigned RMC. Reference (i) provides additional information on BOAs.

2.4.8 Other Contracting Methods.

- a. Multi-Agency Contract means a task-order or delivery-order contract established by one agency for use by Government agencies to obtain supplies and services, consistent with the Economy Act. Contracts for information technology services are often procured as multi-agency contracts.
- b. Private Sector Industrial Activity (PSIA) contracts enhance the Procuring Contracting Officer's (PCO) flexibility by allowing the PCO to package several ship repair availabilities spanning several fiscal years into one procurement package. The cost-type contract awards the initial availability with options to execute the remaining availabilities, provided the contractor's cost and performance are satisfactory. PSIA contracts are routinely procured as cost-type contracts, although they could be procured as FP contracts.

- c. Best Value Contracting. Best Value Contracting (BVC) is a DoD endorsed procurement method that presents an alternative to the traditional low-bid method of contracting. It is to be used for all procurements with an estimated value exceeding \$500,000. It is a competitive contracting process requiring projects to be awarded to the contractor offering the best combination of price and qualifications instead of just the lowest bid. It is an approach for awarding contracts that, when properly designed and administered, rewards high-performance contractors who have trained, skilled workers and other essential qualifications for performing high quality projects in a safe, timely and cost-efficient manner.
 - (1) BVC is used in relation to Request for Proposal procedures, but it may also be referred to by other terms in the commercial business environment, such as “competitive sealed proposal contracting,” or “negotiated contracting.” Because the award decision is not based on price or price-related factors alone, BVC is never accomplished under Sealed Bidding (IFB) procedures.
 - (2) Under the BVC process, bidding is typically open to qualified contractors who submit detailed information on their past performance and qualifications in response to the Request for Proposal process. If designed properly, the BVC system should require mandatory pre-listing when a subcontractor’s level of effort is expected to exceed a specific dollar threshold as set by the PCO.
- d. Required information, and past performance, can include areas that have the potential to impact the success of a project. They typically include the past performance, technical expertise and management team of the general or prime contractor and subcontractors. Key craft labor issues should also include:
 - (1) Skill training/apprenticeship.
 - (2) Project staffing/labor sources.
 - (3) Safety initiatives.
 - (4) Law compliance.
- e. In reviewing this information and researching past projects (Contractor Performance Appraisal Reporting System, etc.) the Government Contracting Officer shall employ various types of procurement evaluation and selection procedures to assist in identifying the contractor or contracting team that offers the best combination of price and qualifications.
- f. The past performance of a contractor, or proposed contracting teams, are usually rated or scored by a team of Government contracting and technical personnel, working for the PCO and using pre-established evaluation criteria. The designated evaluation team reviews submittals provided by contractor/subcontractor teams and evaluate performance data and other relevant information from prior projects and submits their recommendations to the PCO with substantiating data to support their analysis.
- g. The PCO analyzes the inputs and recommendation in relation to the terms and conditions of the contract and its scope to make the final decision as to the contractor or contracting team that has offered the best value for the Government.

2.4.9 Five (5) Elements of a Contract. Whatever form the contract takes following the solicitation, it shall contain the following five elements:

- a. Offer.
- b. Acceptance.
- c. Consideration.
- d. Legal and possible objective.
- e. Competent parties.

2.4.9.1 The Offer. An offer is nothing more than a promise, conditioned either upon performance of an act by the offer or upon a return promise by the offer, to perform this act. In order for the offer to be valid, the expression must be intended as an offer, it must be complete in all its essential terms, it must be communicated (in the manner intended) to the offeree and it must be clear and without ambiguities. If after the contract is formed, it is found to be imprecise or ambiguous in some minor detail so that reasonable persons could differ as to its meaning, the “Rule of Ambiguities” comes into play and the contract shall be reformed at the expense of the party who drafted the contract.

2.4.9.2 The Acceptance. Acceptance is an expression of consent to the proposed contract. In order for the acceptance to be effective, i.e., to create a valid contract, it must be:

- a. Clear and unequivocal.
- b. Timely (i.e., it must occur before the offer is revoked).
- c. In the same terms as the offer (to avoid the problem of counteroffers). If the acceptance conditions change or alter any of the terms of the offer, a counteroffer results. Once a counteroffer is made, the original offer is terminated, and the offer then has the power of accepting or rejecting the counteroffer. As it relates to Government contracts, the acceptance becomes effective on dispatch to the offer as long as it is properly addressed.

2.4.9.3 Consideration. Consideration is the price bargained for, and paid, for a promise. It may consist of an act, a forbearance of an act or a return promise. To be valid, consideration must be legally sufficient, that is, the consideration must have value in the eyes of the law. The courts shall not check into the adequacy or fairness of the consideration.

2.4.9.4 The Legal and Possible Objective. The purpose of a contract (what it is the offer or is trying to accomplish) must be a legal and possible objective. If the objective is illegal, the contract is unenforceable. Likewise, impossibility can excuse performance under the contract.

2.4.9.5 Competent Parties. Both parties to a contract must have legal capacity to enter into the contract. In the Government, this must be a duly authorized and properly warranted Contracting Officer who has the legal authority to obligate the Government, using authorized funds to comply with the agreed upon terms and conditions of the contract. Private companies are required to designate in writing the names of the individuals who are authorized to represent the contractor in contract matters and to obligate the company in writing to a promise to meet the agreed upon terms and conditions of the contract.

2.5 OVERVIEW OF CONTRACTING PROCEDURES. The two methods the Government uses to enter into its contracts are sealed bidding and negotiation.

2.5.1 Sealed Bidding. Sealed bidding, described in reference (j), was established by statute as the preferred procurement method. Sealed bidding relies wholly upon competition to obtain fair and reasonable prices for services and materials.

2.5.1.1 The Purposes of Sealed Bidding. The two main purposes of sealed bidding is: to realize the price and other benefits derived from full, free competition and to give all interested and qualified sources an equal opportunity to compete for the contract. The Comptroller General states the following: “The courts and accounting offices of the Government have frequently and consistently held that Section 3709, Revised Statutes, was designed to give all persons equal right to compete for Government business, to secure for the Government the benefits which flow from competition, to prevent unjust favoritism by representatives of the Government in making purchases for public account, and to prevent collusion and fraud in procuring supplies or letting contracts.”

2.5.1.2 Success of Sealed Bidding. Achieving these goals depends entirely upon the existence of real competition among bidders and upon the integrity of the system throughout its operation. Each bidder must be put on an equal basis and given the same opportunity to develop and submit the best bid initially. Sealed bidding procedures are prescribed in detail in reference (j) and cannot be deviated from. Regardless of the strict conformity to procedure, the use of sealed bidding is not intended to prohibit flexibility nor eliminate good judgment.

2.5.1.3 Responsibilities of the Planning and Procuring Activities.

2.5.1.3.1 Requiring/Planning Activity. The activity that plans or requires the goods or services to be procured must prepare the initial request for technical support that clearly identifies the specifics of the requirement. In addition, it must provide all applicable specifications, plans or drawings. If nothing better is available, the activity shall provide a purchase description that adequately specifies to the warranted buying or procuring office all the essential features of the item or service to be procured.

2.5.1.3.2 The Procuring Activity.

- a. The PCO is responsible for ensuring the specifications in the offer are sufficiently descriptive to provide for maximum competition. This solicitation package is issued via an IFB. Contract law provides that, "If the specifications are not sufficiently descriptive so as to provide for full and open competition, then the offer is invalid and no award may be made."
- b. The PCO is charged with the responsibility to challenge any delivery or performance schedule that appears unrealistic. The time of delivery or performance is an essential element for inclusion in a contract and must be clearly set forth in the IFB. Delivery and performance schedules that are unreasonably tight or difficult to attain are unfavorable to full competition, inconsistent with small business policies and may result in higher contract prices. All personnel must be alert to question any requirement that does not make sense or appears to involve unnecessary or excessive costs for any reason.
- c. The PCO determines whether the purchase is susceptible to sealed bidding. A purchase is susceptible to sealed bidding if all four of the following conditions are present.
 - (1) Time permits the solicitation, submission and evaluation of sealed bids.
 - (2) The award shall be made on the basis of price and other price-related factors.
 - (3) It is not necessary to conduct discussions with the responding offerors about their bids.
 - (4) There is a reasonable expectation of receiving more than one sealed bid.
- d. The PCO ensures that the information is transferred from the purchase description to the schedule of an IFB that shall be issued in such terms that the requirements are completely defined; determines that the terms included in the schedule of the IFB fully and completely describe the needs of the Government without ambiguity; determines that the offer is responsive; determines that the company that submits the offer is a responsible entity; determines which bid actually offers the Government the lowest price; and as the legally authorized agent of the Government, awards a contract to the contractor who fulfills all of the essential provisions of the IFB and whose price is found to be fair and reasonable.

2.5.1.4 Invitation for Bid Summary.

- a. Even this brief outline of sealed bidding procedures shows that it is a substantial and complex process involving considerable administrative expense. All these steps must be taken in every purchase accomplished by sealed bidding. Although this discussion has necessarily been quite general, each step of the process can be broken down into a myriad of further considerations and problems. An intricate system attempts to secure the best result for the Government by the use of widespread competition. Great emphasis must be placed on maintaining the integrity of the system to the end that the prospective bidders must know the rules in advance and must be ensured of fair and equal treatment.
- b. These procurement rules have been established by the Comptroller General to protect the interests of both the bidder and the Government. Frequently, project officers and operational personnel view the process as too restrictive and would like to circumvent some of these rules. The problem is not one of changing the rules, but rather of ensuring the use of this method of procurement is appropriate for the given circumstances.

2.5.2 Contracting by Negotiation. Congress has recognized sealed bidding cannot satisfy all procurement requirements and has authorized procurement by means of negotiation in accordance with reference (k). A contract awarded by means other than sealed bid is a negotiated contract. Negotiation has an inherent flexibility that is almost completely absent from sealed bidding. Negotiated contracts can be made with or without competition, and contractors that submit an offer may or may not be aware of the presence or absence of competition when

establishing their prices. The flexibility of the negotiation provides the means of achieving a fair and reasonable pricing basis without reliance upon competitive pressure alone. Negotiated contracts are solicited through Requests for Proposals.

2.5.3 Basic Acquisition Process. Appendix B provides a simplified diagram of the major steps frequently required in the acquisition process.

2.5.4 Clearance. The purpose of a business clearance is to demonstrate that the proposed acquisition conforms to good business practice, law or regulation and to justify by written evidence that the cost and price established are fair and reasonable. In addition, a business clearance serves as the historical record of the business cost and pricing aspects of an acquisition and contains all required approvals by higher authority.

2.6 WRITING CONTRACTS.

2.6.1 Uniform Contract Format. With the implementation of the FAR, all Federal Government contracts have a Uniform Contract Format as to section headings used. This contract format consists of listed parts and sections that are found in reference (j) for sealed bids and reference (k) for negotiated procurements.

2.6.2 Standard Procurement System. DoD has mandated the Standard Procurement System shall be the standard used by all services and individuals involved in the preparation of a contract. The Standard Procurement System is an automated contract writing system that standardizes procurement processes across the DoD within the Acquisition Domain. Standard Procurement System capabilities are:

- a. Provide an enterprise-wide automated contract writing system for the DoD from receipt of requirements to contract closeout.
- b. Used in a mobile, forward-deployed version (Battle Ready Contingency Contracting System) in support of contingency missions worldwide.

2.6.3 Procurement Deficiencies. Among the items which obscure the intent of a contract are:

- a. Inadequate item descriptions, inaccurate, illogical and confusing specifications and incomplete and sometimes ambiguous requirements.
- b. Unclear pricing aspects.
- c. Special clauses with ambiguous or incomplete terms.
- d. Related clauses and requirements in several different sections of the contract.
- e. Inconsistent treatment of general provisions with regard to their preprinted forms and the applicability of clauses incorporated by reference.

2.7 CONTRACTING OFFICER AUTHORITY AND RESPONSIBILITIES.

- a. The Federal Government conducts activities through employees with varying degrees of authority and responsibility. For contract administration purposes, this work is accomplished through Contracting Officers assisted by the Project Manager.
- b. It is difficult to determine the exact authority of Government employees when they and contractor personnel are in frequent contact. This difficulty is compounded by the fact that the rules that govern the extent of Government employee's authority are complicated and scattered throughout various statutes, regulations, instructions and legal principles. Problems frequently arise regarding which employees have the authority to bind the Government and what limitations, if any, have been placed on the employee's authority. The most common problems involve situations where the Government refuses payment of claims because the contractor dealt with an unauthorized agent, or where the Government seeks to revoke or countermand action taken by its employees or agents.

2.7.1 Authorized Officials.

- a. Persons who have met the prerequisites and formal training requirements mandated by the Defense Acquisition Workforce Improvement Act and who possess the actual authority to contractually bind the Government are generally referred to as "Contracting Officers".

- (1) “Contracting Officer” is defined as a person with the authority to enter into, administer and/or terminate contracts and make related determinations and findings. The term includes certain authorized representatives of the Contracting Officer acting within the limits of their authority as delegated by the Contracting Officer.
 - (2) “Administrative Contracting Officer (ACO)” refers to a Contracting Officer who is administering contracts.
 - (3) “Termination Contracting Officer” refers to a Contracting Officer who is settling terminated contracts. A single Contracting Officer may be responsible for duties in any or all of these areas.
- b. Reference (1) requires that Contracting Officers below the level of a HCA shall be nominated, selected and appointed by use of a Certificate of Appointment. Such appointment must state any limitation on the scope of authority to be exercised, other than limitations contained in applicable laws or regulations. Agencies sometimes impose limitations on the authority of their Contracting Officers by prescribing procedures that must be followed in order for the Contracting Officer’s action to be binding on the Government.

2.7.2 Typical Contracting Officer’s Representative Responsibilities. Personnel performing other functions (e.g., auditors, lawyers, engineers, shipbuilding specialist/production controllers and other technical personnel) are frequently designated as Contracting Officer’s Representatives (COR). These personnel assist Contracting Officers by providing advice and frequently deal directly with contractors, but normally are not vested with contracting authority. CORs must have met training requirements and selection criteria established by higher authority in accordance with reference (m) and have a letter of appointment from the Chief of the Contracting Office entered into the contract files. Individuals authorized to be a COR have a much narrower scope of authority than the person specifically designated as a Contracting Officer. Procurement regulations usually contain express limitations on the delegation of authority to CORs. A common limitation is that CORs are not authorized to sign formal contract documents on behalf of the designated Contracting Officer. Further, CORs are not authorized to make any contractual commitments or otherwise obligate the Government, or authorize any changes that affect the contract’s price, terms or conditions.

2.7.3 Typical Contracting Officer’s Representative Duties. CORs are responsible for the technical aspects of the contract. This may include reviewing (and frequently preparing) the contract work statement, delivery requirements and specifications, clarifying technical requirements, preparing independent estimates, providing technical liaison with the contractor and monitoring contractor performance. In performing these functions, a COR must:

- a. Ensure that the contract does not become a personal service contract.
- b. Ensure that constructive changes are avoided.
- c. Control, formalize and issue technical direction.
- d. Ensure necessary file documentation.
- e. Monitor contractor performance regarding cost, quality and delivery.
- f. Communicate with the Contracting Officer.
- g. Ensure that the work being required is within the scope of the Statement of Work for the terms and conditions of the contract.
- h. Certify contractor’s invoices.
- i. Provide reports associated with the task order.
- j. Maintain the Significant Events log.
- k. Provide a past performance information survey at completion of contract evaluation.

2.7.3.1 Actual Authority Required.

- a. One of the concerns regarding CORs is that contractors may not understand the process necessary to create an “authorized representative”. It is the ACO’s responsibility to clearly articulate the authority of individuals participating in the Contract Administration Process. NAVSEA requires that proper training be completed prior to formally designating employees as CORs. There are other Government representatives who interface directly with contractors in the normal course of their duties but who are not designated as having any formal status (e.g., where technical evaluation, testing, quality control, inspections, etc., are performed by individuals other than those specifically designated as CORs).
- b. Government personnel must avoid all acts that could lead the contractor to conclude that a “constructive change” has been given even though the individual has no contractual authority to do so. The ACO must clearly state to the contractor’s representatives that no Government personnel and specifically the COR, personnel in the Waterfront Operations Department and Ship’s Force are authorized in any form to supervise the Contractor’s personnel in the performance of the terms and conditions of the contract. This action is essential because in certain cases of contractor claims the courts and boards tend to look more at the actual functions that such personnel perform than at their formal status. When they are given contract-related functions as part of their official duties, they may well be treated by the courts as authorized representatives with “implied authority” even though they are not authorized to act in a formal capacity to obligate the Government in accordance with their action.
- c. Recognizing the importance of effective Government control over the conduct of its agent, the boards and courts have frequently stated the rule that the Government is not bound by the unauthorized acts of its agents even though they are acting with “apparent authority”.
- d. It is important to recognize that the actual authority rule does not apply to contractors (i.e., contractors are governed by the usual rules of apparent authority). This means that a contractor shall normally be bound by acts of its employees with apparent authority, even though these employees may lack actual authority.

2.7.4 Implied Authority. While “apparent authority” shall not be sufficient to hold the Government bound by the acts of its agents, the boards and courts have frequently granted contractors relief on the basis of “implied authority” when such authority is considered to be an integral part of the duties assigned to a Government employee. Most of the litigated cases involving implied authority arise where Government technical personnel, lacking authority to order changes, issue interpretations or give instructions which induce the contractor to perform work beyond actual contract requirements. In such cases, the boards and courts frequently hold the Government to a “constructive change” when it is found that the Government has acted to change the contract without actually going through the “Changes” clause formalities.

2.7.5 Contractually Related Functions. Successful contract performance depends heavily on the Contracting Officer and COR relationship. This relationship should be a harmonious and close partnership, where the expertise of each is best utilized, consistent with their inherent responsibilities. The authority, responsibility and duties of the COR shall be clearly defined by the Contracting Officer, understood by the COR and discussed in detail with the contractor. The duties of assigned COR are to be included in the contract where feasible but as a minimum are to be reduced to writing by the Contracting Officer, with the original provided to the COR and a copy to the contractor and contract files. Since the COR functions not just as an official representative of the Government but also as the “eyes and ears” of the Contracting Officer he/she is required to interface directly with the Contracting Officer.

2.8 CONTRACT ADMINISTRATION.

2.8.1 Regional Maintenance Centers. RMCs are responsible for performing contract administration functions listed in references (n), (o) and (p). This responsibility extends to all Federal contracts awarded to contractors for whom the RMC is the designated Contract Administration Services (CAS) Activity, as designated in the Federal Directory of CAS Components.

2.8.2 Assignment of Contract Administration. An RMC performing CASs under a plant cognizance assignment may require performance of quality assurance, source inspection, etc., at a subcontractor’s plant which is under the cognizance of another Federal CAS component. In such a case, the RMC is to request the responsible CAS component to perform the CAS as prescribed within reference (n).

2.8.3 Contract Manager Representatives. RMC's point of contact for general contract matters is the Fleet Support Contracts Division (NAVSEA 024) of NAVSEA Contracts Directorate (NAVSEA 02). Other Divisions of NAVSEA 02 are also available to provide assistance. They generally deal with specific programs such as NAVSEA 022 (Shipbuilding Contracts Division), NAVSEA 025 (Surface Systems Contracts Division) and NAVSEA 026 (Undersea Systems Contract Division), etc.

2.8.4 Correspondence and Visits. Refer to reference (n) for contract administration correspondence, pertinent correspondence conducted between the Contract Administration Office (CAO) and the contractor and visits to contractor's facilities.

2.8.5 Contracting Officer Warrants. NAVSEA (SEA 02) issues all Contracting Officer warrants to RMC Contracting Officers, including Corporate ACO warrants and leasing warrants, in accordance with the provisions of reference (l).

2.8.6 Involvement. Involvement, previously called engagement, is defined as aggressive contract administration based on an in-depth knowledge of the contractor's operations, especially any weaknesses in areas such as policies, procedures and performance. Reference (q) incorporates new laws and policies, improving in the area of teamwork, with the goal of creating an acquisition system that capitalizes on the strengths of each and every participant. To implement involvement for ship repair work, RMCs shall take the actions described in this section when appropriate. The complexity and duration of the work shall significantly influence the extent to which these functions should be performed.

2.8.7 Special Requirements in Schedules. When the work effort is extensive or availability dates short and the work complex, PCOs may require in the solicitation that the prospective contractor submit data on the proposed manning of the ship work, by trades, and the subcontractors to be used during the contract. The docking date and date(s) for accomplishing certain test(s) may be included in the specifications, if considered necessary because of significant known or suspected work. Contract completion dates have been missed due to inadequate scheduling of tests that did not permit time to correct deficiencies or because planning for the test schedule was inadequate.

2.8.8 Communications with Fleet Representatives. RMCs should provide the Type Commanders any estimated impact on availability completion dates due to approval of new work items. Such approvals should be received early in the availability to minimize cost and impact to the schedule. Periodic meetings of RMC personnel with the ship's Commanding Officer and department heads shall be held in accordance with Volume II, Part I, Chapters 3 and 4 of this manual. The ship is the customer and the Commanding Officer often knows when work is not progressing properly or the quality of work is unsatisfactory. During these meetings, the Availability Project Manager shall brief Ship's Force on the status of all work-by-work items and on corrective measures being taken by the contractor to advance the work or redo unsatisfactory work.

2.8.9 Communications and Familiarity with Contractors.

- a. Essential information is generally provided by the contractor while briefing RMC personnel on work status and problem areas. During scheduled progress meetings, the RMC should obtain or generate a list of Government actions or inactions that the contractor claims are delaying the work (e.g., delays in receipt of Government Furnished Material or in Government authorization to proceed with new or changed work). To the extent the contractor identifies any Government action or inaction which he claims is delaying work, the RMC representative shall advise the contractor to comply with the contract's notification of change requirements, advise the ACO and document the significant event.
- b. Appropriate RMC personnel, especially the senior designated RMC representative at the work site, shall become familiar with the contractor's Work Breakdown Structure generally used for both cost control and scheduling. The designated RMC representative should know how the contractor uses the system and what reports the system generates. Many shipyards prepare a percent for completion report and generate a report of Work Breakdown Structure items that have missed the completion date. Access to such reports should provide the RMC with the data needed to require timely corrective action by the contractor to meet the job order completion date. Information on work status, which the RMC is generally required to maintain for progressing purposes, is also provided through use of the bar charts. A missed milestone for a controlling work item should alert the RMC that corrective action might be needed.

2.8.10 Government Furnished Property. RMCs are primarily concerned with two types of Government Furnished Property (GFP): Government Furnished Material, which includes all types of tangible items (e.g., equipment, repair parts, consumables, etc.), and Government Furnished Information (GFI), which includes tangible and electronic forms of Government data, such items as plans, blueprints, test memos and technical manuals. GFP is addressed in detail in Chapters 7 and 10 of this volume.

2.8.11 Use of Change Orders and Avoiding Constructive Change Orders. RMCs shall establish procedures to minimize the need for change orders, particularly in the case of FFP contracts. RMCs should always avoid creating constructive change orders. A constructive change order is an informal change to the contract resulting from Government actions or inactions that require the contractor to perform work beyond that which is required by the contract. These constructive changes can result in unauthorized commitment of Government funds, claims or litigation against the Government. RMCs shall provide guidance to Ship's Force and other Government personnel to preclude intentional or unintentional creation of a constructive change order.

2.8.12 Avoidance of Delays. RMCs shall establish procedures to require the designated Availability Project Manager to provide timely information to the responsible project officer. When the RMC representative at the work site judges that work progress is unsatisfactory, that test schedules are improper because they do not permit sufficient time to correct deficiencies, that open-and-inspect items are not being accomplished promptly, that the contractor is manning the job improperly, or that the procurement and receipt of contractor-procured material is delayed, the RMC representative should advise the contractor and document the significant event. Pertinent data should be communicated to the contractor and confirmed in writing through the Contracting Officer. If the contractor insists that progress, performance and scheduling are in order, the Availability Project Manager should consult the ACO for appropriate contractual action. If it appears that contract performance may be slowed because of delay in a Government approval required by the work item or because of delay in issuing a required change to the job order or other omission by the Government, the RMC representative at the work site should request that the cognizant RMC department either expedite the required approval for the change or correct the omission.

2.8.13 Improper or Unsatisfactory Work. When work performance is determined to be improper or unsatisfactory, the contractor shall be so advised. Before advising the contractor, the RMC representative at the work site shall review the work item to ensure that no defect in the specifications contributed to or caused the deficiency. The RMC shall not include improper or unsatisfactory work in the base for computing progress payments. When a contractor disagrees with an RMC determination that corrective action is necessary, the RMC representative at the worksite shall try to resolve the issue with the contractor to mutual satisfaction. If this is unsuccessful, the RMC representative shall consult with the ACO. The ACO shall review the RMC/contractor disagreement and direct the contractor to take appropriate corrective action, as required. See Chapter 11 of this volume for additional information concerning corrective action documentation.

2.8.14 Records. Throughout contract performance, the RMC representative at the work site shall maintain written records of deficiencies in work progress and accomplishment. These records shall be used for such purposes as the determination of liquidated damages and evaluation of claims. The records shall also serve as the factual account for briefing higher authority if required. Written records must reflect on the deficiencies and the steps the RMC has taken to obtain corrective action including all actions the contractor takes. These records serve as input to significant events files. The use of the records for responsibility determinations is of particular importance. Government policy requires contracts be awarded to responsible contractors (i.e., contractors which can perform if awarded the contract). The RMC shall maintain sufficient written records of past contractor performance to permit an informed determination of responsibility or non-responsibility to ensure an adverse determination of responsibility is not overturned by higher authority or the Small Business Administration. These records shall be used to evaluate a contractor's proposal where past performance is an evaluation factor.

2.9 SOCIOECONOMIC PROGRAMS. The Small Business, Veteran-Owned Small Business, Service-Disabled Veteran-Owned Small Business, Historically Underutilized Business Zone Small Business, Small Disadvantaged Business and Women-Owned Small Business programs are founded in law and cover both prime contracting and subcontracting, for which annual goals are assigned to NAVSEA by the Office of the Secretary of the Navy. Command goals are based upon the share or percentage of total obligated dollars. As HCA for RMC contracting, the Commander, NAVSEA, is responsible for achievement of program goals and implementation.

2.9.1 Deputy for Small Business. Commanding Officers shall appoint a full-time or part-time Deputy for Small Business, who shall report directly to the appointing official on Small Business Program matters. The appointment should reference the pertinent responsibilities in references (r) and (s). The appointment shall be in accordance with reference (t). Individuals appointed shall possess business acumen, knowledge of contracting policies and procedures, and the training and background essential to accomplish the objectives of the Small Business Program.

2.9.2 Subcontracting Program Administration. Reference (r), sections 705-2 and 705-4, contain the responsibilities of the Contracting Officer. These responsibilities include determining the need for a subcontracting plan and reviewing the subcontracting plan. Reference (r), section 706(a)(i) contains the responsibilities of the ACO. These responsibilities include reviewing, evaluating, and approving master subcontracting plans.

2.10 PROCESSING CONTRACTUAL ACTIONS.

2.10.1 Policies. This section discusses policy concerning the processing of the more common contractual actions.

2.10.1.1 Forward Price Rate Agreement. A Forward Price Rate Agreement (FPRA) is a written agreement negotiated between a contractor and the Government to make certain rates available during a specified period for contractual actions. Such rates represent reasonable projections of specific costs that are not easily estimated for, identified with or generated by a specific contract, contract end item or task. These projections may include rates for labor, indirect costs, material obsolescence and usage, spare parts provisioning and material handling. Negotiation of FPRAs may be requested by the Contracting Officer, the contractor or initiated by the ACO. In determining the need for an FPRA, the ACO should evaluate whether the benefits from the agreement are worth the effort of establishing and monitoring it. FPRAs should only be negotiated with contractors having a significant volume of Government contract proposals. The responsible RMC shall determine whether to establish an FPRA. Indirect costs commonly defined as overhead are defined and described in reference (u) including treatment and application of indirect costs to contracts.

2.10.1.2 Pricing of Deleted Work. Deletions should be based on the reasonable value of the change at the time the work would have been performed. The deletion values should not be based on itemized estimates provided by the contractor at the time of contract award. The deletion value should include all costs reasonably associated with the deleted work, including profit.

2.10.1.3 Awarding Job Orders. The Government uses the sealed bidding and negotiation methods of contracting in awarding contracts, including job orders. These methods of contracting are covered in detail in references (j) and (k).

2.10.1.4 Objective of Procurement Process and Contract Pricing. The objective of the procurement process is to acquire supplies and services of the desired quality in a timely manner at "fair and reasonable" prices. The objective of contract pricing is to establish and administer an arrangement that poses a fair and reasonable price for delivery of a product or service.

2.10.1.5 Pricing Responsibility. The Contracting Officer is responsible for exercising proper judgment and is solely responsible for the final pricing decision. Although the Contracting Officer is responsible for the final pricing decision, the Contracting Officer is not expected to perform all functions leading to the contractual document's execution. Although the recommendations and counsel of contributing specialists, including auditors, are advisory only, the Contracting Officer should include comments in the price negotiation memorandum when significant auditor or other specialists' recommendations are not adopted.

2.10.1.6 Adjudications on the Basis of Estimates. NAVSEA policy requires changes to be adjudicated on the basis of estimates. Adjudications shall not be deliberately delayed to allow the determination of actual incurred costs from which to adjudicate.

2.11 PROPOSAL ANALYSIS.

2.11.1 Cost Analysis. The purpose of proposal analysis is to ensure that the final agreed-to price is fair and reasonable. Proposals are evaluated using price analysis or cost analysis. Price analysis, which evaluates the bottom line pricing, is the preferred method when the action is below the cost or pricing data threshold (\$700,000) and when information is available on which to base price analysis. Cost analysis, which evaluates each cost element of a proposal, is used when proposals exceed \$700,000, when no basis for price analysis exists or when deemed appropriate by the Contracting Officer. Exercising sole responsibility for the final pricing decision, the Contracting

Officer shall coordinate a team of experts in such fields as logistics, finance, law and contract audit, quality control, engineering, technical and pricing to provide assistance and advice in proposal analysis, including participation in negotiations with the contractor.

2.11.2 Field Pricing Support. Field pricing support is a review and evaluation of the contractor's or subcontractor's proposal by any or all field pricing support personnel. When cost or pricing data are required, contracting offices shall request a field pricing report (which may include an audit review by the cognizant contract audit agency) before negotiating any contract or modification.

2.11.3 Cost Realism Analysis. Even when adequate price competition exists, cost realism analysis may be appropriate, especially for cost-reimbursement contracts, and to ensure a reasonable expectation that proposed costs are consistent with the technical proposal. Cost realism analysis should also be used when the solicitation contains new requirements that may not be fully understood by competing contractors, when there are quality concerns, or when past experience has indicated that contractors have proposed costs which have resulted in quality or service shortfalls.

2.11.4 Subcontract Pricing Considerations. The Contracting Officer is responsible for the determination of price reasonableness for the prime contract. To make this determination, an analysis is required of all relevant facts and data, including required subcontractor cost or pricing data, results of the prime or higher tier subcontractor's analyses of subcontractor proposals, the field pricing support, if any, and historical pricing data. Even if a contractor or higher tier subcontractor has an approved purchasing system or performs an analysis of subcontractor cost or pricing data, the Contracting Officer or field pricing support team still has the responsibility of analyzing the prime contractor's submission, including the subcontractor cost or pricing data. The prime contractor or higher tier subcontractor is responsible, however, for conducting appropriate price and cost analysis before awarding a subcontract.

2.11.5 Requests for Procurement Requiring Information on Purchased Materials. Purchased materials are raw materials, purchased parts, components or end items to be delivered under a contract which are not fabricated or produced by the contractor. Timely submission of information is required by negotiators or other contracting personnel who can properly evaluate the purchased materials portion of price quotations. This information is necessary particularly when competition is lacking or is inadequate to control the prices initially proposed. The prime categories requiring treatment are new contracts where a sole source or competition is limited, re-pricing of re-determinable and incentive contracts and equitable adjustments under the Changes clause (and other clauses having similar provisions for such adjustments).

2.11.6 Price Analysis. Price analysis is the process of examining and evaluating a proposed price without evaluating its separate cost elements and proposed profit. Price is cost plus any fee or profit applicable to the contract type. The Contracting Officer is responsible for selecting and using whatever price analysis techniques shall ensure a fair and reasonable price. Price analysis shall generally be used in lieu of cost analysis, regardless of the dollar amount for contracts, where the conditions of reference (k) are met (e.g., prices are based on adequate price competition).

2.11.7 Use of Independent Estimates. Independent estimates are preferred for pricing sole source contracts and contract modifications less than the cost and pricing data threshold of \$700,000. An independent estimate forms the basis for pricing. Such estimates should be made without reference to the supporting or back-up cost or pricing data the contractor has, nor shall such data be requested when price analysis is to be employed. When cost or pricing data is submitted or identified, a cost analysis shall be performed on the data.

2.12 WORK SCOPE.

2.12.1 Reaching Work Scope Understandings. It is unusual for an RMC to have to reach a work scope understanding with the contractor for a contract itself. Such understandings are usually reached in pre-bid/negotiation conferences or other discussions. Therefore, work scope understandings are addressed in the context of contract changes. Before a contractor can prepare an estimate of the cost of a change, it first must determine the work scope of the change. There should be an understanding between the contractor and the negotiating team on the work scope before the change is adjudicated. If there is no common basis of understanding the requirements of the change, there cannot be a common basis for adjudication. Reaching an early understanding of work scope prevents later conflicts and permits the negotiating team to limit the evaluation of the contractor's proposal to the estimated cost of performance. For un-priced modifications, a work scope understanding should be reached with the contractor before issuing the un-priced modifications. Work scope understandings shall be reached before

completion of the technical analysis. These understandings may be accomplished by any reasonable means including work scope conferences. The difficulty in reaching work scope understandings and the need and timing for holding work scope conferences is directly related to the clarity and accuracy of the applicable specifications. When the specifications are clear and accurate, a work scope conference may not be needed, especially if the contractor's proposal raises no serious technical questions.

- a. A work scope conference shall be required if the specifications are not clear and accurate or if the contractor's proposal raises serious technical questions. If the specifications are not clear, the conference should be held before proposal submission. If the specifications raise serious technical questions, the conference should be held after receipt of the proposal. When there are serious disagreements about the work scope, a work scope conference should be held, preferably before receiving the proposal. The ACO shall establish local procedures for reaching work scope understandings with the contractor including the use of work scope conferences.
- b. When a work scope understanding is reached before proposal submission, the proposal for pricing the change is to be submitted in accordance with the understanding. The contractor's proposal shall be submitted based on the work scope understanding reached. The technical analyst reviewing the work scope description prepared by the contractor or attending the work scope conference should conduct, if possible, the technical evaluation of the proposal when it is received.

2.12.2 Work Scope Conferences. The extent of participation by the Government and contractor representatives at work scope conferences shall be determined based on type and complexity of work, issues for resolution and gross dollar value. Participants should be limited to necessary personnel. A work scope understanding reached by a meeting between only the technical analyst and contractor's counterpart is generally better for the participants. The negotiator, legal counsel, ACO, auditor, engineers and other specialists should also be included when there is a legitimate need for them.

2.12.3 Work Scope Data. Work scopings shall include, but not be limited to, the following data:

- a. Description of the work required by the contract before the change, work that is deleted by the change and work deleted by the change that already has been completed. The description is to include a list of components, equipment and other identifiable property.
- b. The status of manufacture, procurement or installation of such property is to be indicated. Personnel shall furnish separate descriptions for design work and production work. Raw materials, purchase parts, components and other identifiable hardware that the change makes expendable, and which the contractor shall or shall not retain, are to be listed for later disposition.

2.13 TECHNICAL ANALYSIS REPORTS.

2.13.1 General. A Technical Analysis Report (TAR) shall be prepared in accordance with Volume VI, Chapter 31 of this manual. The TAR shall contain a statement of the extent to which the analyst recognized that any cost or pricing data submitted or made available by the contractor was inaccurate, non-current or incomplete.

- a. When the statement advises that there was defective data, the analyst shall clearly delineate how the evaluation was conducted and the effect of deficient data on man-hours or material dollars in the proposal and the analysis.
- b. The TAR shall clearly delineate the data not relied on during the evaluation.
- c. The TAR shall reflect the technical analyst's professional judgment of the reasonableness of the man-hours and material estimates in the contractor's proposal, the data accompanying the proposal and the back-up data used by the contractor in preparing the proposal when a technical cost analysis is performed.
- d. The TAR shall specifically address material which has been made excess or obsolete by a change and whether the Government has been given a credit or was charged for the material. The Government property administrator must be advised when title to Contractor Acquired Property is to remain in the Government at the end of the contract.

- (1) If the technical analyst concludes the contractor's proposed labor hours and material is reasonable, the TAR must state the basis for the conclusion, e.g., historical data or actual return cost data. If, in the professional opinion of the technical analyst, the contractor's labor or material estimate is too high or too low in any area, the report must indicate the exact area of the proposal or back-up data in which the differences appear. The report also must indicate the rationale of the technical analyst and the contractor.
- (2) The TAR shall reference the local instructions and procedures followed in the evaluation instead of spelling out the steps in detail. When local instructions and procedures are not followed, the TAR shall detail the steps taken in the evaluation and the rationale for not following the local instructions and procedures. The technical analyst shall sign the TAR, which shall be approved in accordance with local procedures. When independent estimates are made, the independent estimate shall serve the purpose of a TAR. Technical analysts should in particular keep in mind that they should provide the negotiator with data that can be used in negotiations.

2.13.2 Local Instructions and Procedures.

- a. RMCs shall establish local instructions and procedures to cover the steps to take in conducting technical evaluations of various types of proposals and the preparation of TARs to submit under various circumstances. Such instructions and procedures shall:
 - (1) Ensure practices among the technical analysts shall be uniform.
 - (2) Ensure only essential steps and information shall be included.
 - (3) Require formats for preparation of the TAR be standardized and simplified to the maximum extent possible.
- b. Local instructions and procedures shall stress that for small gross value proposals and changes which are not complex the procedural steps are to be followed with the expenditure of minimum effort and the use of spot-check techniques, where appropriate. Procedures shall provide for notification of the Government property administrator when material has been made excess or obsolete by a change and the Government is charged for the material.

2.14 AUDIT EVALUATION OF CHANGE PROPOSALS AND SUBMISSION OF ADVISORY AUDIT REPORTS.

2.14.1 Audit Evaluation. This section is closely related to field pricing support described in paragraph 2.11.2 of this chapter. The key difference is that where field-pricing support envisions involving two or more Contracting Officers for a contractual action, audit evaluation envisions only one Contracting Officer (i.e., the ACO at the RMC responsible for the contractual action). Field pricing support primarily addresses the award of contracts and major modifications, while audit evaluation primarily addresses the more routine contractual modifications processed by RMCs.

2.14.2 Contractual Audit Reports. RMCs are not precluded from requesting audits regarding contractual modifications for less than the dollar thresholds of those pertaining to certified cost or pricing data where deemed necessary by the Contracting Officer. The audit evaluation to be performed by the auditor shall be in accordance with the directives under which the auditor operates, the procedural arrangements made between the ACO and the head of the audit office, the contents of the TAR and the special considerations identified in the request for audit evaluation and submission of the Advisory Audit Report (AAR).

2.14.3 Advisory Audit Reports. On completion of the audit evaluation, the auditor shall prepare the AAR in accordance with the directives under which the auditor operates and the procedural arrangements made with the ACO and submit the report to the negotiator. The AAR shall incorporate the finding of the TAR, when provided, and address any additional items requested by the ACO or ACO representative. The ACO or ACO representative may request that a discussion of the audit findings be held prior to the release of the formal audit report.

2.15 CONTRACT MODIFICATIONS.

2.15.1 Introduction. This section covers the more pertinent regulatory requirements regarding contract modifications contained in the FAR, DFARS and NMCARS.

2.15.2 Restrictions. Reference (l) contains extensive coverage of the various types of contract modifications. The requirements apply to both new construction and repair and overhaul contracts, where appropriate, unless otherwise indicated.

- a. Only Contracting Officers acting within the scope of their authority are empowered to execute contract modifications on behalf of the Government. Other Government personnel shall not:
 - (1) Execute contract modifications.
 - (2) Act in such a manner as to cause the contractor to believe that they have authority to bind the Government.
 - (3) Direct or encourage the contractor to perform work that should be the subject of a contract modification.
- b. Contract modifications, including changes that could be issued unilaterally, shall be priced before their execution if this can be done without adversely affecting the interest of the Government. If a significant cost increase could result from a contract modification and time does not permit negotiation of a price, at least a maximum price shall be negotiated unless impractical.

2.15.3 Types of Contract Modifications. There are two types of contract modifications: bilateral and unilateral.

- a. A bilateral modification (supplemental agreement) is a contract modification that is signed by the contractor and the Contracting Officer. Bilateral modifications are used to:
 - (1) Make negotiated equitable adjustments resulting from the issuance of a change order.
 - (2) Definitize letter contracts.
 - (3) Reflect other agreements of the parties modifying the terms of contracts.
- b. A unilateral modification is a contract modification that is signed only by the Contracting Officer. Unilateral modifications are used to:
 - (1) Make administrative changes.
 - (2) Issue change orders.
 - (3) Make changes authorized by clauses other than a changes clause (e.g., Property clause, Options clause, Suspension of Work clause, etc.).
 - (4) Issue termination notices.

2.15.4 Order of Preference for Contract Modifications. The order of preference for contract modifications is:

- a. Fully adjudicated supplemental agreement.
- b. Maximum/minimum priced supplemental agreement.
- c. Un-priced, time-adjudicated; supplemental agreement, time only.
- d. Change order.

2.15.5 Notification of Contract Changes.

- a. When a contractor determines the Government has affected or may affect a change in the contract that has not been identified as such in writing and signed by the Contracting Officer, it is necessary that the contractor notify the Government in writing as soon as possible. This shall permit the Government to evaluate the alleged change and perform the following:
 - (1) Confirm that it is a change, direct the mode of further performance and plan for its funding.
 - (2) Countermand the alleged change.
 - (3) Notify the contractor that no change is considered to have occurred.
- b. The clause at reference (v):
 - (1) Incorporates the policy expressed above.

- (2) Requires the contractor to notify the Government promptly of any Government conduct that the contractor considers a change to the contract.
- (3) Specifies the responsibilities of the contractor and the Government with respect to such notifications.

2.15.6 Funding. The Contracting Officer shall not execute a contract modification that causes or shall cause an increase in funds without having first obtained a certification of funds availability. The certification shall be based on the negotiated price, except that modifications executed before agreement on price may be based on the best available estimate of cost. The exception is for modifications to contracts that:

- a. Are conditioned on availability of funds.
- b. Contain a limitation of cost or funds clause.

2.15.7 Notification of Substantial Impact on Employment. The Secretary of Defense is required to notify the Secretary of Labor if a modification of a major defense contract (over \$5,000,000) or subcontract (over \$500,000) shall have a substantial impact on employment. This requires the contractor notify the Contracting Officer when a contract modification shall have a substantial impact on employment.

2.15.8 Identification of Foreign Military Sales Contract Modifications. Each Foreign Military Sales (FMS) modification must be identified by clearly stamping or otherwise indicating "FMS Requirement" on the face of the modification. It also must specify within the modification each FMS case identifier code by line or sub line item number, e.g., FMS Case Identifier GY-D-DCA.

2.15.9 Change Orders. Government contracts contain a "Changes" clause that permits the Contracting Officer to make unilateral changes, in designated areas, within the general scope of the contract. These are accomplished by issuing written change orders on Form SF 30, Amendment of Solicitation/Modification of Contract (SF 30), unless otherwise provided. The contractor must continue performance of the contract as changed, except that in cost-reimbursement or incrementally funded contracts the contractor is not obligated to continue performance or to incur costs beyond the limits established in the "Limitation of Cost or Limitation of Funds" clause. The Contracting Officer may issue a change order by electronic message under unusual or urgent circumstances, provided that:

- a. Copies of the message are furnished promptly to the same addressees that received the basic contract.
- b. Immediate action is taken to confirm the change by issuance of an SF 30.
- c. The message contains similar information to that required by the SF 30 (except that the estimated change in price is not to be indicated), including in the body of the message the statement, "Signed by (Name), Contracting Officer".
- d. The Contracting Officer manually signs the original copy of the message.

2.15.9.1 Authority to Issue Change Orders. Change orders are to be issued by the Contracting Officer except when authority is delegated to an ACO. This authority has been delegated by COMNAVSEA to RMC Contracting Officers.

2.15.9.2 Change Order Accounting Procedures. Contractors' accounting systems are seldom designed to separate the costs of performing changed work. Therefore, before prospective contractors submit offers, the Contracting Officer should advise the contractors of the possible need to revise their accounting procedures to comply with the cost segregation requirements of the Change Order Accounting clause in reference (v). The following categories of direct costs can be made separate and accountable under the terms of the "Change Order Accounting" clause:

- a. Nonrecurring costs (e.g., engineering costs and costs of obsolete or re-performed work).
- b. Costs of added distinct work caused by the change order (e.g., new subcontract work, new prototypes or new retrofit or back-fit kits).
- c. Costs of recurring work (e.g., labor and material costs).

2.15.10 Change Order Documentation. When changes are not forward-priced, they require two documents: the change order, and a supplemental agreement reflecting the resulting equitable adjustment in contract terms. If an equitable adjustment in the contract price or delivery terms or both can be agreed upon in advance, only a supplemental agreement need be issued. However, administrative changes and changes issued according to a clause

giving the Government a unilateral right to make a change (e.g., an “Option” clause) initially require only one document. In situations where an un-priced or undefinitized change is issued, the change must generally be sufficiently definitive so that the contractor is obligated to total performance within a stated period of time for a maximum not-to-exceed price that the Government can be charged under the change order. Exceeding this price is not an item subject to negotiation with the Government. The maximum not-to-exceed price shall bear a reasonable relationship to the work to be performed. All such un-priced or undefinitized changes are to contain definitization schedules that provide for definitization by the earlier of two periods. The first is the end of a 180-day period beginning on the date of issuance of the change. (This period may be extended, as required, but may not exceed the 180-day period beginning on the date the contractor submits a qualifying proposal.) The second is the date on which the amount of funds expended under the change order is equal to more than 50 percent of the maximum not-to-exceed price.

2.15.11 Definitization. Contracting Officers shall negotiate equitable adjustments resulting from change orders in the shortest practical time. ACOs negotiating equitable adjustments are to obtain the Contracting Officer’s concurrence before adjusting the contract delivery schedule.

2.15.12 Complete and Final Equitable Adjustments. To avoid controversies that may result from a supplemental agreement containing an equitable adjustment as the result of a change order, the Contracting Officer shall:

- a. Ensure that all elements of the equitable adjustment have been presented and resolved.
- b. Include in the supplemental agreement, a release similar to the following:

“CONTRACTOR’S STATEMENT OF RELEASE”

“In consideration of the modification(s) agreed to herein as complete equitable adjustments for the contractor’s _____ (describe) _____ proposal(s) for adjustment, the contractor hereby releases the Government from any and all liability under this contract for further equitable adjustments attributable to such facts or circumstances giving rise to the proposal(s) for adjustment (except for) _____.”

2.15.13 Consideration as Command Key Indicator. HCAs are to consider the backlog and age of undefinitized change orders as a command key indicator, placing routine management emphasis on undefinitized change orders.

2.15.14 Forms.

- a. Except for the options stated in reference (w) section (a)(2), the SF 30, Amendment of Solicitation/Modification of Contract, shall be used for the following:
 - (1) Any amendment to a solicitation.
 - (2) Change orders issued under the “Changes” clause of the contract.
 - (3) Any other unilateral contract modification issued under a contract clause authorizing such modification without the consent of the contractor.
 - (4) Administrative changes such as the correction of typographical mistakes, changes in the paying office and changes in accounting and appropriation data.
 - (5) Supplemental agreements.
 - (6) Removals, reinstatement or addition of funds to a contract.
- b. The SF 30 may be used for modifications that change the price of contracts for the acquisition of petroleum as a result of economic price adjustment, termination notices and purchase order modifications as specified in reference (w) section (a)(2). If it is anticipated that a change shall result in a price change, the estimated amount of the price change shall not be shown on copies of the SF 30 furnished to the contractor. The Optional Form 336 (OF 336), Continuation Sheet or a blank sheet of paper, may be used as a continuation sheet for a contract modification.

2.16 CLAIMS POLICY.

2.16.1 Definitions and Approval Levels. A claim is defined in reference (x). A written demand or written assertion by the contractor seeking the payment of money exceeding \$100,000 is not a claim under the Contract Disputes Act (CDA) of 1978 until certified as required by the Act and reference (x). The contractor must request a Contracting Officer's decision under the CDA of 1978. All claims, regardless of amounts, shall be reported to NAVSEA 024 by the RMC Contracting Officer. Claims received in the field shall be handled by the RMC. This includes reviewing the claims for sufficient processing, unless the specific circumstances of a claim dictate that NAVSEA Headquarters shall handle these matters. NAVSEA 024 shall notify the RMC in such cases. If all data necessary to adequately support the requested compensation is included in the contractor's submission, a contract modification should be executed so that payment can be made. Any submission from a contractor requesting payment beyond the obligations covered in the contract, which does not request a Contracting Officer's decision under the Disputes Act and contains the claim certification (if applicable), is considered a claim.

2.16.2 Claims Prevention. NAVSEA's policy is to try to resolve all contractual issues by mutual agreement at the Contracting Officer's level without litigation. In appropriate circumstances, the Contracting Officer should consider the use of informal discussions between parties or individuals who have not participated substantially in the matter in dispute to aid in objectively resolving the differences. Any issue that remains unresolved between the contractor and the Navy represents a potential claim. To minimize the potential for claims, Navy personnel are expected to be aware of problem areas and to keep adequate records of events, particularly significant events. Matters having potential problems raised with or by the contractor must be fully documented and brought to the attention of the responsible Contracting Officer for prompt resolution. Issues leading to claims are often based on assessments made, opinions expressed or other actions or inactions by Navy personnel that caused the contractor to perform additional work. Lack of schedule adherence or cost control by the contractor may lead the contractor to seek recovery of consequent losses through a claim. Identification of significant actions regarding contractor management and performance must be documented, including actions pertaining to manning, facilities, methods and procedures. Proper analysis of data may lead to the identification and mitigation or avoidance of potential trouble areas. In an effort to prevent claims, the RMC Commanding Officers shall:

- a. Ensure the participation of all departments in the identification and elimination of potential claims items throughout the procurement process.
- b. Avoid, to the maximum practicable extent, all Government actions or inactions that impede contractor performance, particularly those that impede efforts to improve productivity. Contractors should be encouraged to report any such Government conduct.
- c. Monitor contractor performance and ensure that sufficient data is developed during contractor performance to enable prompt and accurate analysis of any claim. Use this same documented data to identify actual and potential problems and to defend against claims, overruns and other problems.
- d. Strive to improve the ability to analyze and develop positions on contractor proposals that include delay and disruption, particularly those involving an allegation concerning cumulative effects. This requirement is closely related to the requirements above regarding monitoring of contractor performance.
- e. Conduct claims avoidance presentations periodically to ensure that CAO personnel are instructed in claims avoidance procedures. Emphasis should be placed on increasing the effectiveness of the local claims avoidance program.
- f. Assess contractor responsibility, through pre-award surveys and records of past performance under Government contracts, to ensure that award is made only to those companies that are capable of meeting the contract requirements.
- g. Maintain lines of communication with PCOs to ensure that the lessons learned while administering current contracts can be used to benefit the Navy when planning and drafting future contract actions.
- h. Promptly review all new contracts assigned for administration and identify all clauses, provisions, specifications and any other contract requirements that are new to the CAO or have the potential for causing a claim if not properly administered. CAO personnel shall be properly briefed. These requirements also apply to job orders and modifications, where appropriate.

- i. Adhere to requirements for properly documenting significant contract events.

2.16.3 Processing Claims and Requests for Equitable Adjustment. Contracting Officers must be familiar with the CDA of 1978 which establishes procedures and requirements for asserting and resolving claims by or against contractors arising under or relating to a contract subject to the Act. The Act provides for payment of interest on contractor claims, for the certification of contractor claims in excess of \$100,000, and for a civil penalty for contractor claims that are fraudulent or based on misrepresentation of fact. For claims exceeding \$100,000 the Act requires the Contracting Officer's Final Decision (COFD) within 60 days or notification to the contractor of the time within which the COFD shall be issued. A direct appeal to the Armed Services Board of Contract Appeals is allowed if there is an undue delay in issuance of the COFD, under such circumstances, the FAR considers such actions to be deemed denial of the contractor's claim.

- a. Fleet Support Contracts Division (SEA 024) shall have overall responsibility for NAVSEA claims settlement as specified below:
 - (1) Provide direction and assistance to field activities relative to claims and Requests for Equitable Adjustment (REA), as requested.
 - (2) Assign claims for processing.
 - (3) Process particular claims and REAs that are deemed to be of a precedent-setting nature, as determined by Headquarters.
 - (4) Provide technical support to field claims and REA teams, as requested.
 - (5) Compile and report status and statistics relative to claims and REAs which are either active, settled or under appeal.
 - (6) Review and approve all field-originated COFDs under disputes which are valued by the contractor at \$1 million or over. Review and revision shall be done in conjunction with NAVSEA 00L for evaluation of entitlement, accuracy and completeness. Following Headquarters' review and approval, the COFD shall be returned to the ACO for execution and delivery to the contractor.
 - (7) Budget for, control and allocate the required resources for Headquarter's claims management efforts, including computer services and litigation support contracts.
 - (8) Support field efforts to secure funding for claim settlement.
- b. RMC Contracting Officers shall report all claims, regardless of amount, and REA claims of \$250,000 and over to NAVSEA 024 and forward copies of all claims and reported REAs within one week of receipt. NAVSEA shall report any claims in excess of \$1 million to Assistant Secretary of the Navy (Research, Development and Acquisition) within one week after receipt. The cognizant RMC shall be responsible for establishing a claim analysis team and for assigning to the team a Contracting Officer or negotiator to act as the Claims Team Manager, an engineer to be the Claims Team Engineer, and additional personnel (Legal, Defense Contract Audit Agency Auditor or Project Officer) as necessary for effective claim processing. The claim analysis team should be physically separate from the rest of the RMC operation and shall not include personnel involved in the claim allegations.
- c. REAs and claims often involve complex legal, factual and financial issues. These issues normally require extensive fact-finding and analyses. A system of checks and balances is needed to determine entitlement, if any, and any expenditure of Government funds. In REA and claim submissions, contractors often fail to differentiate between factual and judgmental assertions or fail to support all assertions with specific evidence; such submissions only serve to delay the process and frustrate the contractor and the Government. Rejection and return of the REA or claim is required should the documentation and support remain deficient. Before the claim can be evaluated and payment made for any Government-responsible costs, the contractor must provide data that illustrates that all claimed costs are accurate and the Government is responsible for the claimed costs.

- d. Preliminary review of the claim shall be made to determine acceptability and regulatory compliance. On REAs and claims with allegations proposing an impact of delay, disruption (local and cumulative), congestion, and acceleration and in cases involving specific constructive changes, the following or similar documentation (to the extent applicable and practicable) needs to be included in the claim or REA to enable Government evaluation and to avoid the rejection and return of the submission to the contractor as unsupported:
- (1) The assertions must be supported by specific evidence (including applicable historical evidence such as bid and planned costs supported by shop-level production data from contractor's books and records). In general, the Government shall not acknowledge damages based on a reason-value or total cost concept. The contractor must establish a causal link or connection between the alleged Government-responsible act and the increased costs. Opinions, conclusions or judgmental assertions not supported by such evidence or by a sound and reasonable rationale are without probative value and are unacceptable.
 - (2) Claimant's documentation or charts of production manning for all trades and all projects throughout the period of performance, proposed and actual, should be available.
 - (3) A copy of the claimant's master schedule originally developed to support work items/packages and start and finish milestones must be included. Documentation supporting all updates and the interrelationship of schedule slippage with REA or claim items, sequence, data, etc. should also accompany a claim or REA.
 - (4) Claimant's shop manning requirements for all trades through period (proposed and actual) of performance must be provided.
 - (5) Contractors must provide basic bid data broken down into prime contractor hours by item with prime contractor responsibility, prime contractor material by item number, identification of material source and price bid, and the subcontracted portion of the basic bid, by item, with copies of subcontractor contracts definitizing the tasks to be performed by the subcontractors and the material to be supplied by the subcontractor as part of the basic bid. The total of all items must equal the bid price, or an explanation must be provided.
 - (6) Contractor must provide its planned or budgeted man hours after contract award for each item by trade and define whether the hours were performed by the prime contractor or subcontractor at a regular or premium time.
 - (7) Claimant's actual man-hours expended for each work item by trade excluding modifications as performed by the prime contractor and subcontractors must also be included. Documentation needs to support the prime contractor's actual material costs for the basic job order and subcontractor costs and if the subcontractor has made a demand on the prime contractor. Hours should be broken down by straight time and premium time hours.
 - (8) A listing of all contract modifications by work item with the man hours proposed, budgeted, agreed to and actually expended by modification must be provided.
 - (9) A breakdown of the entire claimant's overtime expended by work item or modification by trade, weekly through the contract performance period must be provided.
 - (10) Copies of all individual purchase orders, invoices and receipts for payment of all subcontracts and material in support of REAs or claims must be provided.
 - (11) A written description by sequence, providing a logical, auditable trail, of the interrelationship between the as bid, as planned, and the actual as accrued schedule by work item distinguishing item labor hour details by trade and the event causing the delay or disruption must be provided.
 - (12) A copy of all RMC written work authorizations ("authorized work chits") against any disputed effort included in the claim must be provided.

- e. There is no privity of contract between the Government and subcontractors. Subcontractors' claims exist between the prime contractor and the subcontractor. The Government is not in a position to consider subcontractor claims that are simply passed through the prime contractor to the Government by a letter of transmittal. The prime contractor must provide the Court of Appeals certification required and submit the claim on behalf of the subcontractor in order for the Government to evaluate the claims.
- f. All REAs or claims involving subcontractors shall establish the prime contractor's damage, payment for damage or commitment to pay damage. Prime contractor's claims that show no commitment to pay the subcontractor do not constitute damage. The prime contractor must evaluate the subcontractor's claim, obtain objective evidence and demonstrate that cause and effect were beyond the control of the prime contractor's prudent management business practices. The prime contractor must definitize what positive management actions were taken to minimize the prime contractor's exposure. A "Reason-Value" concept shall not be accepted by the Government for subcontractor submittals. Prime contractors are to be cautioned to analyze subcontractor allegations thoroughly under prime contractor certification. When a contractor submits a claim exceeding \$100,000, the CDA requires the contractor to make certain representations above the claim in the form of a certification. The claim certification must be in accordance with reference (x).
- g. Certification is necessary before a Contracting Officer can consider the claim, analyze it and issue a final decision. The contractor should properly certify the claim prior to submission to the Contracting Officer. When a contractor must certify the claim, supporting data and the amount of the contractor's entitlement must also be certified. To submit a proper certification, the person who signs the certification must have authority to bind the contractor with respect to the claim. An individual SF 1411, Contract Pricing Proposal cover sheet, must be submitted for each element of the contractor's REA or claim at the time of submission, for any material revision of the REA or claim, and prior to the execution of a settlement agreement on each element.
- h. According to the provisions of the CDA, the Contracting Officer shall issue a decision on any submitted claim of \$100,000 or less within 60 days from the receipt of a written request for a decision from the contractor. For claims of more than \$100,000, the Contracting Officer shall, within 60 days, either issue a decision or notify the contractor of the time when a decision shall be issued. The time established shall be "reasonable", based on such factors as the size and complexity of the claim, and the adequacy of the information in support of the claim provided by the contractor.

2.17 MAINTENANCE CENTERS.

2.17.1 Regional Maintenance Center Procedures and Reports. For processing constructive changes, local instructions and procedures shall be prepared and issued to ensure that the regulatory requirements are met. Copies of the local instructions and procedures, and all revisions thereto, shall be submitted to NAVSEA 024. The following shall be considered when preparing local instructions and procedures:

- a. The occurrence of a constructive change is to be treated as a serious action similar to a violation of the administrative control of funds.
- b. RMC personnel involved in planning and Quality Assurance of contracted work should be thoroughly briefed on the requirements of this chapter, with emphasis on the limitation of their authority to direct the contractor to perform work.
- c. A follow-up procedure shall be established to ensure timely replies for RMC correspondence to NAVSEA, contractors and other organizations when such correspondence requires action by them, and when delays could result in a constructive change if correspondence is not promptly answered.
- d. Reports shall be submitted by the head of a department to the RMC Commanding Officer when personnel of the department are responsible for a constructive change. The penalties to be recommended in the report should be similar to those that would be imposed for a violation of the administrative control of funds. The report shall contain a complete explanation of the circumstances that led to the constructive change, the status of the vessels for which the constructive change is applicable, and an estimate of cost for the change.

- e. A report shall be submitted to NAVSEA 04X when NAVSEA Headquarters personnel are responsible for a constructive change. This requirement would apply, among others, to constructive changes incurred as the result of actions of audit or review teams other than RMC teams.
- f. The Contracts Officer and legal counsel, when assigned to the RMC, shall concur with controversial correspondence to the contractor not signed by a Contracting Officer. RMC personnel are not required to report failure of visiting personnel to send standard visit request letters prior to the visit, but shall be responsible for the preparation of reports delineating the status of any unresolved problems, agreements made and dates requested from the contractor.
- g. Constructive changes shall be resolved as soon as is practical. In no case is a constructive change to be held for resolution as part of an overall claim under the contract or for resolution as part of final settlement, unless approved by NAVSEA. If the RMC considers that delayed resolution would be in the best interest of the Government, the prior concurrence of NAVSEA 024 shall be obtained.

2.17.2 Operational Deficiencies. Local procedures for the processing of deficiency reports to identify operational deficiencies shall be developed and agreed to by all parties involved (i.e., the RMC, PCO and contractor). The definition of operational deficiency shall be developed by the RMC and Ship's Force. Items noted during inspection that require alterations to ship design (potential constructive changes) will be prescreened by the RMC prior to transmittal to the contractor. All involved personnel shall be briefed on local procedures that govern the processing of deficiency reports. The procedures shall provide for coordination with the inspections of the RMC's Quality Assurance personnel.

2.17.3 Regional Maintenance Center Authority to Formalize Identified Constructive Changes.

- a. Except for contracts containing reference (v), the RMC may recognize an identified constructive change and prepare and approve a covering Supplemental Agreement or Field Modification Request (FMR) only when all of the following prerequisites have been met:
 - (1) The constructive change is the responsibility of a person in the RMC office.
 - (2) Reporting procedures have been complied with by the appropriate head of the department.
 - (3) Funds for reservation purposes are available in RMC in the amount of the estimated cost of the change.
 - (4) The work is actually beyond the contract requirements and resulted in a benefit to the Government, and the contractor didn't perform work voluntarily.
- b. It must be work that would have been authorized by a contract change if proper procedures had been followed. For repair work, Supplemental Agreements may be approved by the ACO. For new construction related contracts (e.g., Post Shakedown Availabilities), only the person designated in writing may approve the change and the issuance of an FMR.
- c. If the contract contains reference (v), the contractor is required to notify the Contracting Officer of the issuance of the constructive change and, other than in a situation described in the clause, is not to proceed with the change unless and until the Contracting Officer has responded to such notice in accordance with the clause. The authority to approve and issue an FMR in such a situation is the same as for Engineering Change Proposals. In addition, any prerequisite listed above applies to determinations under this section.

2.17.4 Processing Identified Constructive Changes. When a constructive change has been identified, it shall be processed in the format and in accordance with the procedures required for Engineering Change Proposals, unless such procedures hinder the requisite expeditious processing of the constructive changes or conflict with the stated time requirements of specific contract clauses for response to such changes.

2.18 CONTRACT CLAIMS.

2.18.1 Claims Program. RMCs shall establish a claims program. NAVSEA 02 may be contacted for assistance in accomplishing this. A claims program should not be confused with claims avoidance. Claims avoidance, although extremely important, is just one aspect of a claims program. The purpose of a claims program is to:

- a. Determine the basis for claims.

- b. Generate, analyze and store data related to the claim.
- c. Analyze the merits of claims through the preparation of TARs.
- d. Resolve claims.

2.18.2 Common Basis for Claims. The basis for claims can be broadly categorized into breaches of contract, insufficient compensation for formal change, late or defective GFP or GFI and constructive changes.

2.18.2.1 Breach of Contract. A breach of contract is defined as an unexcused nonperformance of a contract occurring when one party to a contract fails to perform wholly or in part, gives notice beforehand that he will not perform the contract when the time for performance arrives (anticipatory breach) or makes performance impossible for himself or for other party.

- a. A breach of contract gives the injured party the right to collect damages. Additionally, the party harmed by the breach may sometimes be excused from performing that party's part of the contract.
- b. Damages are an award to compensate an injured party for the harm suffered because of the breach of contract. Damages for breach of contract are awarded to place the injured party in a position as good as it would have been in had the contract not been broken. Damages are not awarded to punish the party who has breached the contract. Therefore, if the innocent party is not ultimately harmed by the breach, the innocent party can collect only "nominal damages" (e.g., the costs of the legal action). In general, the courts attempt to fulfill the injured party's reasonable expectancy of profit or benefit from the contract.

2.18.2.2 Insufficient Compensation for Formal Change. Claims for insufficient formal change compensation may arise when contractors believe adjudicated contract modifications for formal changes have been insufficiently compensated or when an agreement with the Government on the equitable adjustments for non-adjudicated formal changes has not been reached. In the first case, contractors normally assert Government responsibility for additional impact costs such as disruption beyond that recognized in contract modifications covering formal changes. Contractors usually allege unforeseen costs and circumstances associated with implementing a particular change or cumulative effects of formal and informal changes and attack any caveats or attempt to overcome any claim release language included in the modifications. In the second case, contractors simply assert the Government's offer for equitable adjustment is inadequate.

2.18.2.3 Late or Defective Government Furnished Property and Information. When a contract obligates the Government to provide GFP and information to a contractor, the Government must provide it by the date specified, or if no date is specified, whenever the contractor reasonably requires it. Failure to do so may entitle the contractor to an equitable adjustment. The GFP or GFI must be suitable for its intended use or purpose when the contractor receives it, unless the contract provides otherwise, or the contractor may similarly be entitled to an equitable adjustment. Late or defective furnished Government property and information ranks second only to constructive change orders as the most frequent basis for claims.

2.18.2.4 Constructive Change Orders. A constructive change order is generally recognized as an unwritten change to the contract as a result of Government actions or inactions, which the contractor did not perform voluntarily, and has the effect of requiring the contractor to perform work different from, or in addition to, that prescribed by the terms of the contract. The constructive change order doctrine is a judicially developed doctrine, the purpose of which is to achieve equity. A constructive change is generally held to have occurred when some course of conduct by the Government is treated as the equivalent of a formal change order issued pursuant to the "Changes" clause of the contract; and so the designation "constructive change order".

2.18.3 Receipt of Proposals for Changes. For change orders, the proposal is generally received after execution and issuance of the change order. For repair contracts, this receipt of the proposal is generally 10 days; for new construction contracts, receipt of the proposal is generally 45 days after receipt of the change order. However, these periods may vary or be extended by the Contracting Officer. For supplemental agreements, the time of receipt of the complete proposal shall vary with the type of supplemental agreement. For example, complete proposals for fully priced supplemental agreements are received before issuing the modification, and less than a complete proposal may be received for other supplemental agreements. Less than a complete proposal, or no proposal, may be received before issuing a change order.

2.18.4 Contract Misinterpretation. The most common and earliest type of constructive change order occurs where the contractor and the Government disagree on the work necessary to meet contract requirements. In this situation, either the contractor proposed to perform the contract in a certain manner and the Contracting Officer insists a more expensive method is required, or the parties disagree on whether completed work complies with contract requirements. Contractors generally perform in accordance with the Government's interpretation to avoid the risk of default but frequently submit a claim later. The basic rule of constructive change in this area has been summarized by the Armed Services Board of Contract Appeals as:

“Where as a result of the Government's misinterpretation of contract provisions a contractor is required to perform more or different work, or to higher standards, not called for under its terms, the contractor is entitled to an equitable adjustment pursuant to the Changes Article, including extensions of time.”

2.18.4.1 Defective Specifications. A second major category of constructive change order occurs when the Government provides defective specifications and the contractor incurs additional expense attempting to perform. The Government's breach of the implied warranty of specifications information is claimed to have occurred when the contractor is required to perform work beyond that originally contemplated by the Government's design specifications.

2.18.4.2 Failure to Disclose Vital Information. Nondisclosure is a change to the contract where the contractor undertakes to perform the contract without knowledge of vital information that affects performance. In order to be liable, the Government must be aware the contractor had no such knowledge, the specifications misled the contractor and did not put the contractor on notice to make inquiry and the Government failed to provide the information.

2.18.4.3 Constructive Acceleration. Excusable delays give the contractor entitlement to schedule extensions. Constructive acceleration occurs when the Government refuses to recognize a new contract schedule extension based upon excusable delay and demands that the contractor complete performance in advance of the original schedule or complete performance within the original schedule. Acceleration can occur even in the case of non-excusable delay if the Government directs the contractor to accelerate. The Government does have the right to terminate for default in the event of non-excusable delay. The contractor's acceleration efforts need not be successful. A reasonable attempt to meet the completion date is sufficient for recovery should acceleration be found. In some instances, a contractor may accelerate on the contractor's own initiative to assure completion within the contract schedule or even ahead of schedule. The costs of such acceleration are, of course, not recoverable from the Government.

2.18.4.4 Failure to Cooperate/Hindrance of Performance. A category of constructive changes is the failure of the Government to cooperate with the contractor or to administer the contract in such a manner that hinders, delays or increases the cost of performance. These obligations can be expressed or implied. The Government may actively interfere with the contractor, making performance more costly or difficult. If the Government's interference is justified, there is no Government liability. If the Government's action is wrongful, the Government will be held to have breached its implied duty not to hinder or interfere with the contractor's performance. When some Government action is essential for the contractor to perform, the Government will be held liable if the Government wrongfully fails or refuses to take the action. In such cases, the Government is said to have breached its implied duty to cooperate. These implied duties are a part of every Government contract.

2.18.5 Data. Generating, analyzing and storing of data can determine the success of resolving a claim by negotiation or litigation, especially the latter. These actions are necessary to ensure effective involvement by RMCs to monitor contractors' performance adequately, regardless of whether claims are submitted.

2.18.5.1 Significant Events. One of the best approaches to ensure the generation of necessary data to analyze and resolve claims is requiring all relevant data on significant events be promptly generated. A significant event is anything that occurs pertaining to a contract, other than formal contract modifications, having a material impact on cost, quality or delivery. Normally, a separate file should be established for each significant event. An individual should be assigned to ensure that a file is established and all relevant future data is generated and properly filed. A cross-reference on the location of documents that are impracticable to include in the file should be included. Significant events can be caused by either the Government or contractors and include the following:

- a. Ship delivery schedule changes or problems.
- b. Drawings, designs and specifications that are ambiguous, defective or impossible to perform.

- c. Differences in interpretation of contract provisions.
- d. Delay and disruption of contractor effort.
- e. Changes in method of sequence of work.
- f. Late or defective Government-furnished material, property or information.
- g. Rejections, rework, waivers and deviations.
- h. Planned versus actual performance milestones.
- i. Delays in Government actions such as processing engineering change proposals, consent to subcontracts and review of technical data.
- j. Contractor error and noncompliance with contract terms.
- k. Any other Government or contractor actions or inactions which have the effect of requiring the contractor to perform work different from the work prescribed by the original terms of the contract.

2.18.6 Significant Events Data. Data that should be generated for each significant event should include as a minimum:

- a. The nature and pertinent circumstances of the event.
- b. The date of the event and the identification of Government and contractor personnel involved, including the name and function of the respective individuals.
- c. Identification of any relevant documents involved.
- d. The substance of any oral communications related to the event.
- e. A statement concerning the possible consequences or effects of the event described upon the contract cost, schedule or technical performance, including manner or sequence of performance.

2.19 RESOLUTION OF DISPUTES. NAVSEA policy is that a dispute between a contractor and NAVSEA should be resolved by the assigned CAO. NAVSEA does not serve as a higher level of appeal for contractors in the event of disagreements between the contractor and the CAO.

2.19.1 Appeals. When a contractor's appeal of a Contracting Officer's decision is received by the ACO, the appeal shall be forwarded immediately to NAVSEA 00L and NAVSEA 024 with a copy to the Litigation Office, Contract Appeals Division of the Office of the General Counsel of the Navy. On notification of an appeal, the ACO shall compile all documentation and files applicable to the matter appealed.

2.19.2 Negotiations with Appeal Pending. While the Navy is not precluded from seeking further agreement with the contractor after an appeal is filed, all such attempts are to be in accordance with Regulatory Requirements.

2.19.3 Third Party Lawsuits. If a third party enters a suit against a contractor who holds a cost-reimbursement or other type of contract under which the judgment of litigation fees might be reimbursable, the ACO should immediately inform NAVSEA counsel and the PCO, forwarding copies of the summons and complaint.

2.20 CONTRACT TERMINATIONS. Reference (y) grants Contracting Officer the authority to suspend or terminate contracts when it is in the Government's interest. Terminations may be either a Termination for Convenience or a Termination for Default depending on the nature of the termination. A contract may be terminated for convenience for any reason that the Contracting Officer determines would be in the best interest of the Government. Terminations for Default are also performed when it is in the Government's best interest, but the reason for the termination is based on the contractor's actual or anticipated failure to perform contractual obligations.

2.20.1 Extent of Termination. Terminations can be either partial or complete. A partial termination means the termination of a part, but not all, of the work that has not been completed and accepted under the contract. A complete termination means the termination of all of the work that has not been completed and accepted under the contract.

2.20.2 Effect of Termination. Terminations are very serious matters. Depending on factors such as the dollar amount of the contract, the contractor's financial condition and the availability of other work to the contractor, a termination can severely impact a contractor's financial condition or even drive the contractor into bankruptcy and out of business. The contractor is not the only one hurt, however, as the contractor must terminate any subcontractors under the contract. Further, the contractor must lay off employees unless the contractor has other work to assign to employees working on the terminated contract. Such circumstances frequently result in political involvement.

2.20.3 Termination Contracting Officer. After the Contracting Officer has issued a notice of termination, a Termination Contracting Officer shall be assigned to handle the termination actions. Refer to reference (u) for the details of these actions, required notifications, and procedures for negotiating settlements with the contractor.

- a. Fortunately, termination of ship repair and modernization contracts is a rare occurrence. It has been necessary to terminate a ship repair contract for convenience of the Government in order to meet unplanned operational commitments. Because of the need to support impending operations, availabilities for these ships may be cancelled or completion dates were greatly accelerated. Contracts can be terminated completely for availabilities that have not begun or can be partially terminated for those availabilities where planned work has to be stopped in order to meet the revised completion date.
- b. It should be noted that in the case of PSIA contracts, it is not necessary to terminate the entire contract in order to cancel work on a single availability. In this situation, it is usually a matter of not invoking the option for that availability, or if work has already begun, canceling any remaining work.

2.21 OVERTIME AND MULTI-SHIFT WORK.

2.21.1 Labor. Reference (z) prescribes contracting policy and procedures for implementing pertinent labor laws and contract clauses. References (aa) and (p) also address the application of labor laws to Government acquisitions. Significant terms, as utilized in this section, are defined in reference (z) and include:

- a. "Normal work week" generally means a work week of 40 hours. Outside the United States, its possessions and Puerto Rico, a work week longer than 40 hours is to be considered normal if the work week does not exceed the norm for the area, as determined by local custom, tradition or law and if the hours worked in excess of 40 in the work week are not compensated at a premium rate of pay.
- b. "Overtime" is time worked by a contractor's employee in excess of the employee's normal work week.
- c. "Overtime premium" means the difference between the contractor's regular rate of pay to an employee for the shift involved and the higher rate paid for overtime; it does not include a shift premium.
- d. "Shift premium" is the difference between the contractor's regular rate of pay to an employee and the higher rate paid for extra-pay shift work.

2.21.2 Overtime. Contractors shall perform all contracts so far as practicable without using overtime, particularly as a regular employment practice, except when lower overall costs to the Government will result or when it is necessary to meet urgent program needs. Any approved overtime, extra-pay shifts and multi-shifts should be scheduled to achieve these objectives. Funds must not be obligated for contingencies that may or may not occur during the performance of the associated contract. Only overtime hours included in the definitized amount for availability are those which both parties agree will be used in executing known and defined work items.

2.21.3 Procedures. Solicitations shall not specify delivery or performance schedules that may require overtime at Government expense. In negotiating contracts, Contracting Officers should, consistent with the Government's needs, attempt to ascertain the extent that offers are based on the payment of overtime and shift premiums, and negotiate contract prices or estimated costs without these premiums or obtain the requirement from other sources.

2.21.3.1 Pre-Award Considerations. Regardless of contract type, when cost or pricing data has been submitted, the parties have an opportunity to negotiate the contractor's planned use of overtime. The price or estimated cost agreed to should include appropriate amounts for overtime only when it is required. If cost or pricing data has not been submitted (e.g., when sealed bidding has been used or where competitive negotiation is used, adequate price competition is expected, and the evaluation is to be based solely on price and price related factors), the Government generally does not know, nor does it need to know, what amount of overtime the contractor has planned to use.

When it becomes apparent during negotiation of a cost-reimbursement contract, the amount of which is expected to be over \$100,000, that overtime will be required in contract performance, the Contracting Officer shall secure from the contractor a request for all overtime to be used during the life of the contract so the overtime can be estimated with reasonable certainty. The contractor's request is to contain the information required by reference (ab). Based on this and other information, NAVSEA and the NSA will consider the justification for the overtime. Necessary determinations regarding premium payments to be included in the contract price shall be made. These determinations are provided to the contractor and to the RMC to administer the contract. The previous requirement does not apply to a cost-reimbursement contract for the operation of vessels or a cost-plus-incentive-fee contract that will provide a swing from the target fee of at least plus or minus 3 percent with a contractor's share of at least 10 percent being contemplated.

2.21.3.2 Fixed-Price Contracts. DoD overtime and multi-shift premium regulations have been established to limit the amount of premium overtime and shift compensation that the Government may allow or consider in pricing. Overtime or shift premiums may not be authorized at Government expense when the contractor is already obligated to meet the required delivery dates without the right to additional compensation. Thus, a contractor performing under a fixed-price contract generally is not entitled, under the overtime regulations, to obtain any compensation for overtime or shift pay in addition to the original contract price. Changes under NAVSEA fixed-price contracts are not subject to FAR requirements for overtime approval. The responsible RMC has authority to approve overtime work with adjudication of such changes.

2.21.3.3 Cost-Reimbursable and Letter Contracts. Cost-reimbursable and letter contracts require Government approval of contractor overtime and multi-shift premium payments. This contractual control is necessary since the premium payments are subject to audit and reimbursement. The contract provisions may require that all overtime and multi-shift premiums be approved by the Contracting Officer or the duly authorized representative. The terms of individual contracts shall be examined to ascertain exact requirements and the applicability of the requirements to overtime and multi-shift premium work by subcontractors. When forwarding any contractor request for overtime or multi-shift premium approvals to NAVSEA, the NSA shall ensure that all information necessary to make a determination is included, comment on the accuracy of the facts in the contractor's request and advise whether or not the request should be approved. The responsible Defense Contract Audit Agency office shall be requested to provide advice to the RMC with respect to the contractor's request.

- a. NAVSEA may authorize the ACO to make determinations and approve overtime under reference (v). When such authority is granted, the NSA is to submit a monthly report of overtime.
- b. For changes under cost-reimbursement contracts requiring overtime, the amount of overtime is limited to the ceiling established by NAVSEA for the contract. Any increase in ceiling required due to the change must be authorized by NAVSEA.
- c. For repair and overhaul contracts, the responsible RMC accomplishes the NAVSEA functions described above, unless NAVSEA 02 has retained responsibility for these functions.

2.21.4 Approval of Overtime.

- a. The Contracting Officer shall review the contractor's request for overtime. Approval of the overtime may be granted by an agency approving official after determining in writing that overtime is necessary to:
 - (1) Meet essential delivery or performance schedules.
 - (2) Eliminate foreseeable extended production bottlenecks that cannot be eliminated in any other way.
- b. Refer to references (z), (ac) and (p) for additional information regarding approvals.

2.22 SUBCONTRACTS.

2.22.1 Subcontracting.

- a. This section prescribes policies and procedures for consent to subcontract and for review, evaluation and approval of contractor's purchasing systems. Subcontracting policies and procedures addressed herein are based upon references (ad), (ae) and (p). Subcontract consent for repair and overhaul contracts under evolving maintenance strategies require an increased effort by the Contract Administration staff due to:
 - (1) Even though over 50% of the dollars associated with repair and overhaul contracts are for labor, in many cases the emerging contract strategies have significantly increased the level of subcontracting by the prime contractor.
 - (2) Many repair and overhaul contracts are PSIA or multiple award contracts wherein the subcontractors' are often parties to the Basic Agreements and Terms and Condition established in the original solicitation. For Headquarters procured PSIA contracts, the prime contractor is required to subcontract at least 40 percent of the work to small business.
- b. Contractors generally attempt to award at least the major subcontracts shortly after receiving award of the prime contract. For this reason the NSA should expect and be prepared to provide prompt service in order to avoid delaying the contractor.
- c. Subcontract consent is not the sole responsibility of the Contracts Department. Other departments within the NSA should be involved to ensure that all pertinent aspects for which they are responsible are adequately covered in subcontracts. All departments involved in subcontract consent shall develop and use checklists to assist in their reviews.

2.22.2 Consent Requirements. If the contractor has an approved purchasing system, consent is required for subcontracts specifically identified by the Contracting Officer in the subcontracts clause of the contract. The Contracting Officer may require consent to subcontract if the Contracting Officer has determined that an individual consent action is required to protect the Government adequately because of the subcontract type, complexity or value, or because the subcontract needs special surveillance. These can be subcontracts for critical systems, subsystems, components or services. Subcontracts may be identified by subcontract number or by class of items (e.g., subcontracts for engines on a prime contract for airframes).

- a. If the contractor does not have an approved purchasing system, consent to subcontract is required for cost-reimbursement, time-and-materials, labor-hour or letter contracts, and also for un-priced actions (including un-priced modifications and un-priced delivery orders) under fixed-price contracts that exceed the simplified acquisition threshold, for:
 - (1) Cost-reimbursement, time-and-materials or labor-hour subcontracts.
 - (2) DoD, fixed-price subcontracts that exceed the greater of the simplified acquisition threshold or 5 percent of the total estimated cost of the contract.
- b. The Contracting Officer's written authorization for the contractor to purchase from Government sources constitutes consent.
- c. Refer to the specific contract clauses actually included in each contract to ascertain specific subcontract consent requirements.

2.22.3 Additional Regional Maintenance Center Consent Procedures. The RMC shall prepare a local instruction that delineates the field activity organizational responsibilities for conducting required subcontract consent reviews.

- a. ACOs shall give the contractor's request for consent equal review, whether the ACO has consent authority or must endorse the request(s), to the PCO. The ACO endorsements to the PCO shall contain all necessary information and recommendations for PCO action.
- b. The Subcontract clauses permit the ACO to ratify a subcontract that has been placed by the contractor even though prior consent was required. ACOs shall not ratify subcontracts as a routine procedure in lieu of granting consent prior to their placement. Ratification should be the exception to the rule and should be granted only on a case-by-case basis. If it appears that the ultimate cost to the Government may have been increased by the placement of the subcontract without consent, the ACO shall consult

with counsel about placing the contractor on notice that the Government shall not be liable for such an increase. If it appears that a change in the contractor's procedures is required to preclude further placement of subcontracts prior to consent, the ACO shall direct the contractor to take corrective action.

(This Page Intentionally Left Blank)

APPENDIX A

MEMORANDUM OF UNDERSTANDING BETWEEN NAVSEA AND NAVSUP OF AUGUST 2004



DEPARTMENT OF THE NAVY
 COMMANDER U.S. FLEET FORCES COMMAND
 1562 MITSCHER AVE STE 250
 NORFOLK VA 23551-2487
 COMMANDER U.S. PACIFIC FLEET
 250 MAKALAPA DRIVE
 PEARL HARBOR HI 96800-3131
 COMMANDER, FLEET AND INDUSTRIAL SUPPLY CENTERS
 957 NORTH HARBOR DRIVE, SUITE 1
 SAN DIEGO CA 92132-0661

IN REPLY REFER TO

CFFC
 4000
 Ser N43/031
 27 Aug 04

COMPACFLT
 4000
 Ser N43/4830
 27 Aug 04

COMPISCS
 4000
 Ser 00/08
 18 Aug 04

MEMORANDUM OF UNDERSTANDING
 AMONG

COMMANDER, U.S. FLEET FORCES COMMAND (N43)
COMMANDER, U.S. PACIFIC FLEET (N43)
COMMANDER, FLEET AND INDUSTRIAL SUPPLY CENTERS
DEPUTY COMMANDER FOR CONTRACTS, NAVAL SEA SYSTEMS COMMAND
AND
DEPUTY COMMANDER, CONTRACTS, NAVAL SUPPLY SYSTEMS COMMAND

Subj: MEMORANDUM OF UNDERSTANDING

1. PURPOSE: The purpose of this Memorandum of Understanding (MOU) is to definitize implementation of the Commander, Naval Sea Systems Command (COMNAVSEA) and Commander, Naval Supply Systems Command (COMNAVSUP) MOU signed 25 June 2002; for afloat Fleet assets. The MOU required local offices to develop a plan to align contracting responsibility in the most efficient manner. This MOU covers the management of boat, service-craft, ship and all other classes of water-borne vessels that come under the program management of the Naval Sea Systems Command and affiliated Program Executive Offices (PEOs).

2. BACKGROUND: NAVSEA and NAVSUP have developed expertise in various areas of contracted Fleet support. NAVSEA and NAVSUP have partnered to align contracting responsibility within organic shipyards. This MOU aligns Fleet contracting functional responsibility in order to capitalize on the expertise of each organization's skills, to reduce redundancies and overall cost to the Navy, while ensuring conformance with NAVSEA's responsibility for ship contracting and technical authority.

Repairs and alterations aboard ship require: schedule coordination of the contracted and organic workforce; direction and compliance of the technical authority; and processes to ensure quality assurance of services performed. The Regional Maintenance Center (RMC), merging Supervisor of Shipbuilding

Subj: MEMORANDUM OF UNDERSTANDING

(SUPSHIP), and Fleet maintenance activities, is responsible for repairs and alteration of ships and is the principal on-site manager for efficient and effective work, resolution of technical issues and assurance of the delivery of required quality. The complexity of ship repair and maintenance necessitates adherence to the policy that private sector repair contracting requirements identified are contracted for and administered by the RMCs.

3. SCOPE: The scope of this MOU is contracting and execution of commercial ship repair and modernization requirements for all Navy vessels during planned and emergent availabilities.

4. DELINEATION OF CONTRACTING RESPONSIBILITIES:

Headquarters Contracting Authority (HCA) exists in both NAVSEA and NAVSUP for material and services that support ship repair and maintenance. Since HCA may be delegated to a field contracting office, and since functional consolidations are taking place among NAVSEA, NAVSUP, and Fleet activities, appropriate alignment of contracting functions is needed to support the consolidated waterfront effort. The following bullets delineate organizational responsibilities for ship maintenance and modernization contract support.

- RMC serves as the PCO and/or ACO for execution of all shipboard repairs and modernization accomplished by the private sector.
- FISC contracts for government furnished material and engineering/technical services using consolidated contracts with technical requirements established by cognizant technical authority. RMC serves as the ACO for all orders for government furnished material and shipboard services issued by the RMC under contracts awarded by FISC.
- RMC serves as the ACO for private shipyards within the respective regions.
- FISC contracts for habitability and assigns ACO responsibility to the RMC.

Subj: MEMORANDUM OF UNDERSTANDING

- All orders for regional services against the consolidated FISC contracts are originated by an RMC ordering officer formally designated in the contract.
- Regional services provided by FISC contracts under orders issued by the RMC will be accepted by a COR who is formally assigned by the RMC designated ACO.
- If a consolidated FISC contract supporting necessary regional services exists, respective RMCs should utilize that contract. If a consolidated contract does not exist, the RMCs should coordinate with the local FISC to determine the optimal approach to contracting for those services.
- NAVSUP will continue to manage the component depot overhaul programs for non-consumable supply items where a carcass turn-in is involved.
- Contract support for organic shipyards and IMFs will be accomplished in accordance with existing FISC/Shipyard and/or SUPSHIP/Shipyard agreements.
- Ship repair efforts other than in CONUS and Hawaii will continue to be contracted for by the supporting FISC/NRCC under the technical cognizance and quality assurance of the numbered Fleet Commander's maintenance organization.

Questions regarding performance of the contract function will be resolved at the regional level. In the event a resolution cannot be affected at the regional level, the issue shall be raised to NAVSEA 02 and NAVSUP 02 to coordinate resolution.

5. PARTIES TO THE MOU: FFC N43, PACFLT N43, COMFISCS, NAVSEA 02, and NAVSUP 02 are the parties to this Memorandum of Understanding. The MOU is established to strengthen the professional cooperation among their subordinate contracting activities, reduce overlap of contracting responsibility, and achieve contracting efficiencies.

6. EFFECTIVE DATE: This MOU is effective upon the date signed by all parties and shall remain in effect until changed by mutual agreement of the parties.

Subj: MEMORANDUM OF UNDERSTANDING

7. APPROVING OFFICIALS:

Director, Fleet Maintenance,
U.S. Fleet Forces Command

Deputy Chief of Staff for
Fleet Maintenance,
U.S. Pacific Fleet

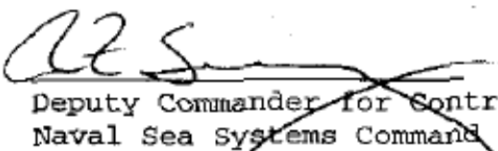

Commander,
Fleet and Industrial Supply
Centers

Deputy Commander for Contracts
Naval Sea Systems Command

Deputy Commander for
Contracting Management
Naval Supply Systems Command

APPENDIX B

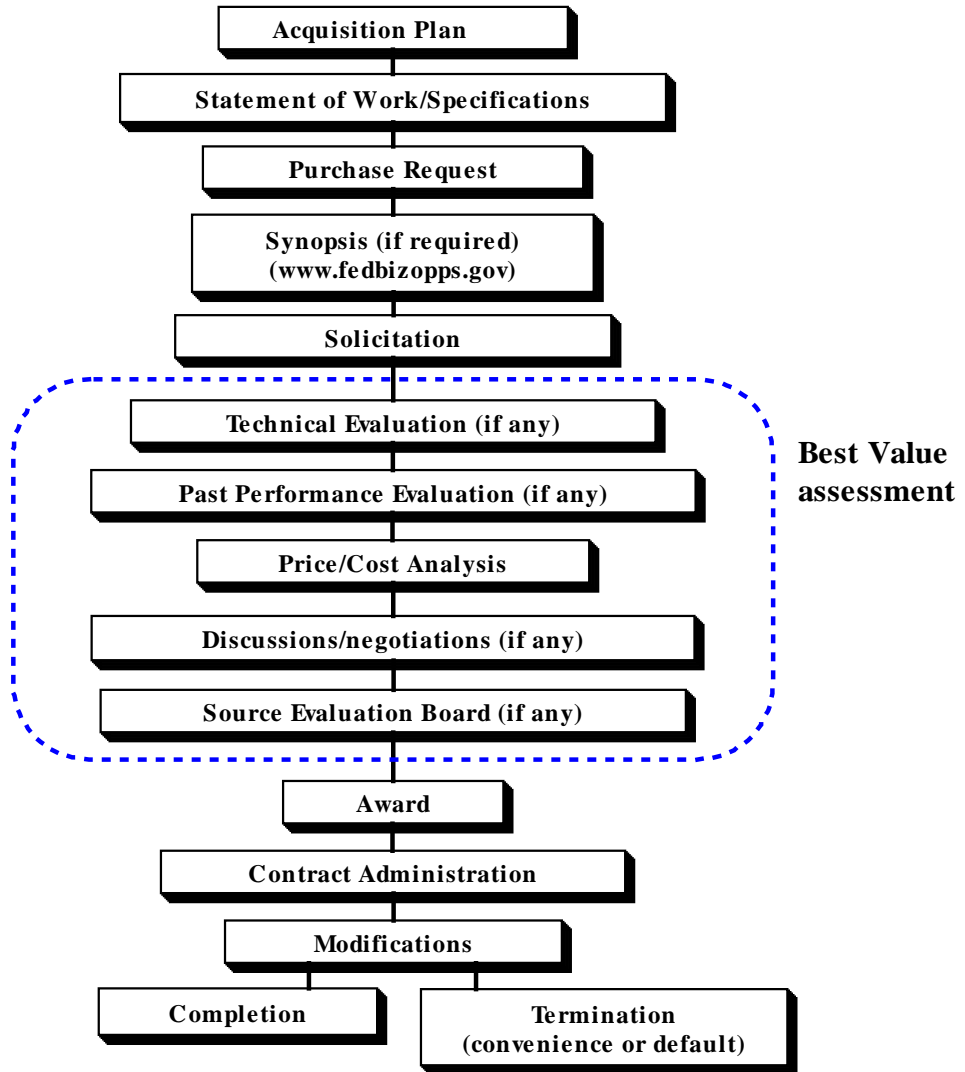
BASIC ACQUISITION PROCESS



(This Page Intentionally Left Blank)

VOLUME VII

CHAPTER 3

PRIMARY CONTRACTING STRATEGIES - MASTER AGREEMENT FOR REPAIR AND ALTERATION OF VESSELS AND PRIVATE SECTOR INDUSTRIAL ACTIVITY

REFERENCES.

- (a) DFARS Part 217 - Special Contracting Methods
- (b) NAVSEAINST 4280.2 - Master Agreement for Repair and Alteration of Vessels, Master Ship Repair Agreement (MSRA) and Agreement for Boat Repair (ABR)
- (c) NAVSEA Contracts Handbook (NCH) - Master Agreement for Repair and Alteration of Vessels
- (d) DFARS 217-7104 - Clauses
- (e) The North American Industry Classification System (NAICS)
- (f) DFARS 217.71 - Master Agreement for Repair and Alteration of Vessels
- (g) FAR 9.1 - Responsible Prospective Contractors
- (h) FAR 6.302-2 - Unusual and Compelling Urgency
- (i) DFARS 206.302-2 - Unusual and Compelling Urgency

LISTING OF APPENDICES.

- A Master Ship Repair Agreement
- B Agreement for Boat Repair

3.1 PURPOSE. The purpose of this chapter is to describe the two primary contracting methods generally employed by the Navy for the procurement of ship repair and modernization work in the private sector.

- a. Procurement of individual contracts for each ship repair availability through the use of firm fixed-price contracts awarded under a Master Agreement for Repair and Alteration of Vessels. These agreements exist as either a Master Ship Repair Agreement (MSRA), Appendix A, or an Agreement for Boat Repair (ABR), Appendix B.
- b. Procurement of a single contract for multiple availabilities on multiple ships through the use of cost reimbursable contracts. These Private Sector Industrial Activity (PSIA) contracts are usually procured to support several ships of the same class within a specific port.

3.2 POLICY.

3.2.1 Policy Sources. Basic policy is established by references (a) and (b). Reference (a) addresses only the MSRA, while reference (b) addresses both the MSRA and the ABR. Reference (c) provides additional policy established by Naval Sea Systems Command (NAVSEA) 02.

3.2.2 Defense Federal Acquisition Regulation Supplement 217.7102 Policy.

- a. The MSRA shall be entered into with all prospective contractors, located within the United States, that request ship repair work and possess the organization and facilities to perform such work satisfactorily. Issuance of the MSRA does not indicate approval of the contractor's facilities for any particular acquisition. Activities may also use the MSRA in selected work with prospective contractors located outside the United States, its possessions or Puerto Rico.
- b. The Government may issue job orders referencing or by attaching the MSRA for repairs, alterations or additions to vessels belonging to foreign governments, however, there are specific directives that should be referred to concerning repairs to foreign vessels. When repairs and alterations to foreign government vessels are to be acquired under the MSRA, the contracting officer will comply with the Federal Acquisition Regulation (FAR) and Defense Federal Acquisition Regulation Supplement (DFARS), addressing foreign military sales regulations, or other governing provisions of law. The solicitation and job order will identify the vessel and the foreign government.

3.3 AGREEMENTS.

3.3.1 Master Agreement for Repair and Alteration of Vessels. The Master Agreement for Repair and Alteration of Vessels, in accordance with reference (a), provides the authority for the Navy and other agencies to utilize special contracting methods for the repair and alteration of vessels. The authority and prerequisites related to obtaining special agreements are identified in reference (a), Sub-part 217.71. It is a written agreement, negotiated between a contracting activity and a contractor containing contract clauses, terms and conditions applying to future contracts for repairs, alterations and/or additions to vessels. The agreement contemplates separate future contracts that will incorporate, by reference or attachment, the required and applicable clauses agreed upon in the master agreement. It is not a contract.

3.3.2 Job Order. A “job order” is a fixed price contract incorporating, by reference or attachment, a Master Agreement for Repair and Alteration of Vessels. It may include clauses pertaining to subjects not covered by the master agreement, but applicable to the job order being awarded. It applies to a specific acquisition and sets forth the scope of work, price, delivery date and other appropriate terms that apply to the particular job order.

3.3.3 Clauses. Appendices A and B are identical in form and content except for the cover sheet and preface. Each must be approved by NAVSEA 02. Appendices A and B are agreements, not contracts, and contain no specifications or statement of work. These two agreements are primarily a compilation of required clauses which are peculiar to ship repair and modernization work and certain general terms and conditions under which the Navy or any other Department of Defense agency can issue firm-fixed-price job orders for efforts involving repairs, alterations or additions. The clauses which are to be included in each agreement are listed in reference (d). Only firm fixed-price job orders may be awarded in conjunction with these agreements, and the associated job orders may only be issued to contractors who hold a current NAVSEA approved “Agreement”. The job order applies to a specific acquisition and describes the scope of work, price, delivery date and additional matters peculiar to the requirements of the specific acquisition. The job order incorporates the clauses from the applicable agreement as well as all the other contract clauses and terms and conditions which are appropriate for the specific contract effort by reference or appendage. The Deputy Commander for Contracts, NAVSEA 02, has issued and maintains a standard solicitation package that is mandatory for use by the NAVSEA Designated Certifying Official and by the Contracting Officer at the Regional Maintenance Centers (RMC) when processing an application for the agreements. Contracting Officers shall ensure that the applicants’ responses to the standard solicitation package are prepared in accordance with NAVSEA 02 direction.

3.4 ELIGIBILITY REQUIREMENTS FOR MASTER SHIP REPAIR AGREEMENT AND AGREEMENT FOR BOAT REPAIR PROGRAM.

3.4.1 Major Requirements for a Master Ship Repair Agreement Certification.

- a. The most significant eligibility requirements set forth in reference (b) are that a Contractor must:
 - (1) Be capable of accomplishing a Selected Restricted Availability on a FFG 7 class ship or larger.
 - (2) Have the capability to perform at least 55% of a Selected Restricted Availability on a FFG 7 class ship using their own facilities and their own workforce.
 - (3) Possess or have access to a pier with the requisite support and technical services available. (There is no requirement for a dry dock.)
- b. While it is not a specific requirement for obtaining an MSRA, the contractor must be capable of providing a “Remote Site Work Performance Plan” to the Contracting Officer prior to issue of the job order that permits the start of the work performance period.

3.4.2 Master Ship Repair Agreement Requirements. The complexity of ship repair and the conditions under which work is performed require that NAVSEA contract only with ship repair companies that are fully capable of conducting most aspects of shipboard work. The compact arrangement of machinery and systems aboard ship, the sophistication of systems installed in Navy ships and the Navy’s absolute requirement for reliable operation create a unique repair environment that demands special experience and capability.

- a. A thorough understanding of these effects and the ability to manage shipboard work as an integrated package are absolutely essential. Naval ships are designed and built with a high degree of interaction among components and systems. Repairs or modifications to a single system or component may have widespread effects on the operation of many other systems or components that are physically remote from the one being repaired.
- b. The ability to co-ordinate a wide variety of concurrent tasks among numerous people with a wide mix of skills. These tasks may include:
 - (1) Advance planning and scheduling.
 - (2) Engineering.
 - (3) Subcontractor management.
 - (4) Material identification and procurement.
 - (5) Material/Integrated Logistics Support management.
 - (6) Manpower scheduling.
 - (7) Work site preparation.
 - (8) Ripping out and removal of interferences.
 - (9) Handling, removal and disposal of hazardous materials or wastes.
 - (10) Removal, disassembly, repair and reassembly.
 - (11) Reinstallation and test.
 - (12) Restoration and test of interferences.
 - (13) Work site restoration.
 - (14) Quality assurance.
 - (15) Integrated system testing.
 - (16) Correction of documentation.
- c. Timeliness and quality control are of utmost importance in ship repair so that a ship may return to and remain in a mission-ready state until the next scheduled maintenance.
- d. Limits on Navy resources affect the ability of RMCs to coordinate the work of multiple contractors during an availability on the same ship. If the work is subdivided among several contractors, the Navy must either perform this coordinating role or schedule the work sequentially, which may increase the overall time required for repairs. Time and quality considerations require that prime contractors who are capable of managing the whole job be given full responsibility, which includes managing subcontracted work.

3.4.3 Additional Requirements. MSRA contractors are required to be capable of utilizing their own facilities and work force to perform 55 percent of a Selected Restricted Availability work package on a ship of FFG-7 Class size or larger when the ship is located at a contractors' own or leased facilities or at government provided piers or drydock. Further, the MSRA contractor must be capable of subcontracting for those elements beyond their managerial, technical or physical capability or capacity. MSRA contractors must also manage and assume full responsibility for the integrated scheduling, cost and quality of subcontractor performance.

- a. The MSRA contractor must be a company recognized as engaged in ship repair work. The MSRA contractor must possess an organization capable of the full scope of planning, engineering, quality control, shipboard/off-ship production, ship and crew security and component/system testing and trials.
- b. A competent contractors' organization shall include the established organizational elements as set forth below. These characteristics will be evaluated during the application process to determine a firm's eligibility for an MSRA and periodically after the Agreement is in place:

- (1) Administration/Management Control.
 - (2) Financial Control (evaluated by the Defense Contract Audit Agency).
 - (3) Production Control.
 - (4) Production Technical Support.
 - (5) Material/Procurement Control.
 - (6) Subcontractor Control.
 - (7) Quality Control/Test and Trials.
 - (8) Safety.
 - (9) Security in compliance with Force Protection Mandates.
 - (10) Hazardous Material/Waste Control.
 - (11) Facilities. Although facility requirements may vary with the work authorized for a specific ship, the MSRA holder must be a ship repair company that possesses or has available the following facilities:
 - (a) Pier, with services in place in the immediate homeport area which a FFG-7 Class size ship can access and at which it can be berthed.
 - (b) Structural Shop.
 - (c) Machine Shop.
 - (d) Pipe Shop.
 - (e) Electrical/Electronics Shop.
 - (f) Carpentry Shop.
 - (g) Rigging Equipment.
- c. Further, ship repair firms are evaluated on their ability to accomplish several kinds of work. These include: shipfitting types of work; sheet metal work; welding; pipefitting; machinist/mechanical (shop and marine); electrical; electronics; woodworking and rigging.

3.4.4 Remote Site Work Performance Plan. To enable an MSRA holder to be awarded a job order to work at a site other than the home location, the MSRA holder must submit a remote site performance plan acceptable to the responsible RMC Contracting Officer located in that remote site. The plan must address management of the effort, production control, hazardous waste and material control, technical support, material procurement and control, subcontracting, safety/security and quality control. The plan must also include a hazardous waste generator number issued to the MSRA holder for that specific remote site.

3.4.5 Agreement for Boat Repair Requirements.

- a. To qualify for an ABR, a contractor must be primarily engaged in ship and/or boat/craft repair.
- b. Reference (e) lists codes “for use in the classification of establishments by type of activity. Each establishment is assigned an industry code on the basis of its primary activity”.
- c. Prospective ABR contractors must provide sufficient documentation to the responsible RMC to indicate that they meet the general criteria of one of the following applicable reference (e) codes. (Documentation can include the contractor’s listing, including one of the below listed Standard Industrial Classification codes, in the latest editions of Standard and Poor’s Register of Corporations, Dunn and Bradstreet Reference Book or any similar publication.)

3.4.6 336611 Ship Building and Repairing. This code involves establishments primarily engaged in building and repairing ships, barges and lighters, whether self-propelled or towed by other craft. This industry also includes the conversion and alteration of ships and the manufacture of offshore oil and gas well drilling and production platforms

(whether self-propelled or not). Establishments primarily engaged in fabricating structural assemblies or components for ships, or subcontractors engaged in ship painting, joinery, carpentry work and electrical wiring installation, etc., are classified in other industries.

3.4.7 336612 Boat Building and Repairing. This code involves establishments primarily engaged in building and repairing boats.

- a. In addition to meeting the general criteria of either reference (e) codes, an ABR contractor must possess the same basic characteristics listed for MSRAs, but to a lesser degree. Reference (b) clearly delineates these characteristics.
- b. Since ABR firms have the potential to perform a diverse scope of repair work, from boat and/or craft overhauls to selected topside repairs to major vessels, ABR firms will also be evaluated on their ability to accomplish the following: shipfitting type work, sheet metal work, welding, pipefitting, machinist/mechanical (shop and marine), electrical, electronics, woodworking and rigging.
- c. ABR Contractors are required to have a "Remote Site Performance Plan" if they intend to work at a site other than their home location.

3.5 RESPONSIBILITIES APPLICABLE TO THE MASTER SHIP REPAIR AGREEMENT AND/OR AGREEMENT FOR BOAT REPAIR PROGRAM.

3.5.1 Contractors. Contractors that do not hold an MSRA or ABR, but have the managerial, technical and facilities capabilities and capacities to conduct ship or boat repairs may make application to NAVSEA through the responsible RMC. The basic application package consists of two standard forms:

- a. Facilities Available for the Construction or Repair of Ships, SF 17.
- b. Solicitation Mailing List Application, SF 129.

3.5.2 Contracting Officers at Regional Maintenance Centers.

- a. Ensure that all private shipyards, in their respective area of cognizance, that are applying for an MSRA/ABR understand the requirements of reference (b).
- b. For all new applicants, contact the responsible Defense Contract Audit Agency. Request that a formal financial capability evaluation be conducted which at a minimum should provide an evaluation of the firm's accounting system, its ability to segregate costs, determine current and acid test ratios, credit availability and whether accounts payable are aging.
- c. After verifying that the application is complete and obtaining the Defense Contract Audit Agency Audit, forward the application for an MSRA or ABR to NAVSEA 04Z, with a copy to Mid-Atlantic Regional Maintenance Center, Code 400.
 - (1) Inform the contractor by means of a separate letter that the application has been sent to NAVSEA.
 - (2) Upon request from the NAVSEA Designated Certifying Official, provide team members in support of MSRA/ABR certification and recertification surveys.
- d. Recommend to NAVSEA 04Z and 024 that an existing Agreement be cancelled based on the events noted in paragraph 3.6.1 of this chapter.

3.5.2.1 Mid-Atlantic Regional Maintenance Center (Code 400).

- a. As the NAVSEA Designated Certifying Official, plan, schedule, coordinate and conduct MSRA/ABR certification and recertification surveys, with NAVSEA 04Z concurrence, and liaison with the RMC to obtain survey team members.
- b. Notify the RMC of pending survey schedules so they may provide adequate notice to contractors of the site survey date.
- c. Document the site survey findings, develop the survey team recommendation, draft the formal survey report and forward it to NAVSEA 04Z.

- d. Maintain the necessary documentation and backup data to support survey team recommendations in the event of contractor debriefings, media inquiries or Congressional correspondence.

3.5.2.2 NAVSEA Director, SUPSHIP Management Group (NAVSEA 04Z).

- a. Review all MSRA and ABR survey results to ensure consistent application of the eligibility criteria, provide a recommendation and forward the package to NAVSEA 024.
- b. If the recommendation is to cancel an existing MSRA/ABR, obtain NAVSEA 04 concurrence prior to forwarding the package to NAVSEA 024 and 02 for concurrence and forwarding to NAVSEA 00 for approval.
- c. Conduct debriefings with MSRA/ABR applicants on survey results and respond to media and congressional inquiries on MSRA/ABR program non-contractual issues.
- d. Act as the point of contact and liaison with other agencies such as the Maritime Administration, Military Sealift Command, United States Coast Guard and the Army for MSRA and ABR contractual issues.

3.5.2.3 NAVSEA Fleet Support Contracts Division (NAVSEA 024).

- a. Review all MSRA and ABR applications and the recommendations forwarded by NAVSEA 04Z.
- b. If the recommendation from 04Z is to cancel an existing MSRA/ABR, obtain NAVSEA 02 concurrence prior to forwarding the package to NAVSEA 00 for approval.
- c. As NAVSEA Contracting Officer, issue all MSRAs and/or ABRs that have been jointly approved by NAVSEA 04Z, and issue correspondence on recertifications and denials.
- d. Act as the point of contact and liaison with other agencies such as Maritime Administration, Military Sealift Command, the Coast Guard and the Army for MSRA and ABR contractual issues.
- e. Provide NAVSEA 04Z and the Contracting Officer at the responsible RMC with copies of the correspondence from NAVSEA 02 to the Contractor.

3.6 PROCEDURES FOR MASTER SHIP REPAIR AGREEMENT AND AGREEMENT FOR BOAT REPAIR.

3.6.1 Period of Agreement.

- a. In accordance with reference (f) either party to the Agreement will have the right to cancel the Agreement without affecting the rights and liabilities under any job order in existence at the time of cancellation by giving 30 days written notice. The contractor will perform and complete all work covered by any job order and any modifications entered into prior to the effective date of cancellation. The Agreement will remain in force until canceled by either party. NAVSEA policy requires that the RMC Contracting Officer consider recommending to NAVSEA 04Z and NAVSEA 024 that an Agreement be cancelled for any of the following reasons or events:
 - (1) Bankruptcy.
 - (2) Change of firm's name, management or owner.
 - (3) Default under a job order.
 - (4) Inclusion in List of Parties Excluded from Federal Procurement and Non-Procurement Programs compiled by the General Services Administration.
 - (5) Removal or sale of facilities.
 - (6) Merger.
 - (7) No longer meeting the standards for award of the agreement.

- b. If NAVSEA cancels an Agreement, NAVSEA 02 will issue notification of cancellation upon approval by NAVSEA 00. Likewise, if a contractor cancels an Agreement, NAVSEA will acknowledge the cancellation by letter. (Originals will be sent directly to the Contractor.) NAVSEA 024 will provide copies of letters to the cognizant RMC and NAVSEA 04Z. The RMC will make additional distribution to notify all other interested parties.

3.6.2 Solicitations for Job Orders Outside of Existing Contracts. In accordance with reference (f), when a requirement arises that is determined to be beyond the intended scope of an existing PSIA or similar contract, and the requirement is determined to be for the type of work covered by the MSRA/ABR within the United States, bids, proposals or quotes will be solicited by the RMC Contracting Officer from prospective contractors who have previously executed an MSRA or ABR. If time permits, solicitations can be issued to prospective contractors who have a pending application for an MSRA or ABR, who potentially possess the necessary qualifications to perform the work, and who has requested to participate in the solicitation process.

- a. The RMC Contracting Officer will ensure that solicitations are prepared in the Uniform Contract Format and that they comply with reference (c), Sections 14 and 15, and the NAVSEA Standard Solicitation package, as applicable. When the Government invites a contractor to submit a bid or proposal for the repair, conversion, alteration of, or addition to a vessel, the RMC Contracting Officer will include in the solicitation the nature of the work, the date the vessel will be available to the contractor and the date the work is to be completed. The notice will state when bulk ammunition is aboard the vessel.
- b. Where practical, the contractor will be given an opportunity to inspect the items of work to be accomplished on the vessel. The contractor will submit a bid, proposal or quotation as requested by the RMC Contracting Officer for the performance of the work described in the solicitation.

3.6.3 Pre-Award Survey for Job Orders and Determination of Eligibility. The Contracting Officer at the RMC will apply the standards set forth in reference (g) for making the determination of responsibility. A pre-award survey of the contractors' operations including any analysis of the contractors' proposed subcontractors, may be directed before making a responsibility determination. A pre-award survey should be used if there is a concern with the adequacy and suitability of facilities, contractors' management, financial capability and Quality Assurance system, including safety standards, fire protection, hazardous materials and waste control, adequacy of facilities for the health, comfort and welfare of the crew and sufficient plant protection to safeguard the vessel and government property plus other issues at the discretion of the Contracting Officer. To be determined responsible, a prospective contractor must possess the following capabilities under reference (g):

- a. Adequate financial resources to perform the contract, or the ability to obtain contracts.
- b. Ability to comply with required or proposed delivery or performance schedule, taking into consideration all existing commercial and governmental business commitments.
- c. Satisfactory performance record. A prospective contractor shall not be determined responsible or non-responsible solely on the basis of a lack of relevant performance history, except as provided in reference (g).
- d. Satisfactory record of integrity and business ethics.
- e. Necessary organization, experience, accounting and operational controls, and technical skills or the ability to obtain them (including, as appropriate, such elements as production control procedures, property control systems, quality assurance measures and safety programs applicable to production of materials or performance of services by prospective contractor or subcontractor).
- f. Necessary production, construction, and technical equipment and facilities or the ability to obtain them.
- g. Other qualifications and eligibility to receive an award under applicable laws and regulations.

3.6.4 Award of a Job Order. Per reference (f) Job Orders are to be awarded in accordance with reference (g) Subpart 14.4 or 15.5. After the receipt and evaluation of bids or proposals and selection of the contractor, the price for the work and other pertinent data will be set forth in a job order. This job order is subject to the provisions of the MSRA/ABR. When the acquisition solicitation process has been made under sealed bid procedures, issuance/award of a job order may be accomplished by a warranted contracting officer's signature. When discussions have been held on a negotiated procurement, the job order must be signed by the contractor and returned to the contracting

officer for signature prior to award. NAVSEA 02 has determined that all of its purchase activities will use the Uniform Contract Format. When using sealed bidding procedures, RMCs will use Form SF 33, Solicitation, Offer and Award as an award sheet for job orders issued under the MSRA and ABR. Electronic copies of SF 33, along with instructions for completing these forms, are available at the FAR and DFARS web sites.

3.6.5 Emergency Work. As outlined by section 6.302-2 of reference (c), the RMC Contracting Officer may issue a written order for work to a contractor who has previously executed an MSRA without inviting bids or proposals when a vessel, its cargo or stores would be endangered by delay in performing necessary repair work or when military necessity requires immediate work on a vessel. As soon as practical after the issue of such an order, the parties are required by the MSRA to negotiate a price for the work. When agreement is reached upon a price, the responsible contracting officer will issue a job order pricing the work.

- a. When emergency work or voyage repairs are necessary and fully justified by the Type Commander, reference (h) exception allows a waiver from the requirements of full and open competition "because of unusual and compelling urgency". Reference (i) states that the urgency exception may be cited for essential equipment or repair needed at once to comply with orders for a ship when such equipment or repair is required to meet the operational commitment/deployment message of the ship.
- b. The procuring activity must prepare a Justification and Approval. The standard format is reference (c) section 53.6-1, Justification and Approval to Approve Other than Full and Open Competition and it can be tailored to local requirements. The requiring activity must certify the requirement and provide data, estimated cost or other rationale on the extent and nature of the harm to the Government if the number of sources is limited due to urgency. The Justification and Approval may be written and approved after contract award when preparation and approval prior to award would unreasonably delay the acquisition. For contract actions over \$1 million to be performed under the urgency exception, authorization to proceed will be obtained from NAVSEA 00, Head of Contracting Activity, through NAVSEA 02.

3.6.6 Modification of Master Agreements. Each Master Agreement will be reviewed per reference (f) at least annually before the anniversary of its effective date and will be revised to incorporate all changes made necessary by the revision of the FAR or DFARS. Statutory or other mandatory changes may require review and revision earlier than one year. The agreement, however, may be modified only by mutual agreement of the parties. The Government has the right to cancel the agreement on 30 days written notice when the parties fail to agree on a modification to the Agreement, which is required by statute, Executive Order, FAR or DFARS. A modification to a Master Agreement will not affect any job order issued before the effective date of the modification.

3.6.7 Resolving Inconsistencies Between Master Agreements and Job Orders. The rights and obligations of the parties to a Master Agreement will be subject to and governed by the provisions of the Master Agreement, the provisions of job orders issued under the Agreement and the drawings, designs, plans and specifications. To the extent of any inconsistency between the Agreement and a job order, including any drawings, designs, plans and specifications, the provisions of the Agreement will govern.

3.6.8 Transfer of Master Agreements. Master agreements are not transferable when a repair yard is sold or undergoes a transfer of title regardless of whether a name change occurs or not. When such a sale or change of title takes place, the Master Agreement may be canceled. If the new owner desires a Master Agreement, the new owner may make application to NAVSEA 04 via the RMC in their geographic region. Previous qualifications of a repair yard for a Master Agreement do not always indicate that the shipyard will be qualified under the new ownership, since different financial and management considerations may be present.

3.7 PRIVATE SECTOR INDUSTRIAL ACTIVITY.

3.7.1 Private Sector Industrial Activity Contract. This specific cost reimbursable contract strategy is addressed in a stand-alone discussion primarily because it is a component of the evolving Fleet Maintenance Strategy and is the contractual instrument that has been approved by higher authority to meet the long-range maintenance and modernization requirements and Force surge requirements to response to Request for Procurement objectives. The goal of the PSIA contract is to provide a maintenance alternative and readily available qualified resources from the Maritime Industrial Base that can be rapidly activated to respond to Fleet surge requirements in addition to supporting scheduled availabilities and continuous maintenance objectives. The PSIA Contractor and approved subcontractors are key "team players" in improving depot level work scheduling, maintaining qualified production

skills while focusing on production efficiency through proper work loading. The PSIA Contract is coupled with the End to End Maintenance and Modernization Process for sustaining the level of readiness of the Force as directed by Commander, United States Fleet Forces Command and the Commander, Pacific Fleet.

3.7.2 Requirement. Surge maintenance requirements and the Fleet Response Plan required re-evaluation of the Fleet maintenance and modernization strategy to meet National Strategy Tasking. Evaluation of the multiple options available to obtain the services of the Nations ship repair base led to the decision that a Navy and Contractor “teaming arrangement” to meet fleet readiness goals should have significant benefits for all parties in addition to contributing to the benefits that are derived from the learning curve process while reducing the overall cost for maintaining the Force. To achieve these goals, PSIA Contracts are being awarded.

3.7.3 General Contract Structure. The PSIA Contract is typically awarded as a Cost Reimbursable, Incentive Fee (or similar) Contract, as the preferred most responsive contractual document that can be used to achieve the Fleet Response Plan surge requirements (it can also be a fixed price contract). The PSIA Contract consists of a pre-selected grouping of ships by class that is awarded, using the best value basis, to a single contractor for a base year with several year options. Additionally the contract contains Contract Line Item Numbers for numerous scheduled availabilities plus Continuous Maintenance and Emergent Maintenance on several different ships. The contract is used to obtain as a minimum: the Contractors advice on depot level work item scheduling to maximize efficiency to reduce cost, provide ship specific technical expertise, perform work item planning support, provide production support services including material management and assist in effectively work loading depot level maintenance trade skills. The PSIA Contractor, with qualifications in line with those required of a MSRA holder, teams with each ship’s Maintenance Team (MT) to provide long-term support and commitments to meet Fleet Maintenance and Modernization Strategic Plans.

3.7.4 Pre-Availability Planning. The advanced planning processes in Volume II, Part II and Volume VI, Chapter 31 of this manual detail the planning requirements in preparation for repairs and modernization when the work is to be performed using the resources available through the private sector industrial base for Chief of Naval Operations scheduled availabilities plus Continuous Maintenance Availabilities. Through the PSIA Contract the government engages the contractor to plan the work, write detailed specifications and proposals and takes advantage of the best available and appropriate level of repair capabilities. The Contractor also establishes relationships with proven vendors on a long-term basis to assist in reducing costs because the contract requires that 40 percent of the work must go to subcontractors. The Contractor prepares specifications for the work candidates that are brokered for inclusion in the work item package. The ship’s MT validates the Contractor prepared work item specification packages in relation to the Technical Analysis Report that is prepared for each work item (developed by RMC Technical Analyst) that is developed in response to the contractor’s proposal(s). The terms and conditions as agreed upon in the MT authorized work package and the scheduled performance period are solidly defined by the warranted RMC Contracting Officer who authorizes the Contractor to proceed with the repair and modernization work as approved and outlined in each work item specification.

3.7.5 Availability Oversight. After defining the work package between the government and the PSIA Contractor, the Project Manager and Contracting Officer are charged with the responsibility and authority associated with their positions to perform Contract Administration with their assigned Availability Management Team. Project Management Team representation and responsibilities are as outlined in Chapter 7 of this Volume.

3.7.6 Growth and New Work. It is the responsibility of the Project Team, using the Maintenance and Modernization Business Plan as the guide, to authorize the Contracting Officer to commit funds for any growth and/or new work.

- a. Growth Work is defined as any additional work that is identified after contract award or definitization that is related to a work item included in the contract award or definitization. Growth does not include pre-priced options or reservations that were specifically identified in the solicitation or defined package.
- b. New Work is defined as any additional work identified after contract award or definitization that is not related to a work item that was included in the original contract award or definitization.

3.7.6.1 Growth or New Work Proposals. The MT will evaluate the Technical Analysis Report prepared by the Technical Analyst for each work item submitted by the contractor. The Technical Analysis Report examines and evaluates the contractor’s proposal to determine the reasonableness of the contractor’s estimates and overall proposal. The Analyst examines all aspects of the proposal including labor, material and subcontractor or teaming members’ pricing.

3.7.6.2 Business Case Analysis. A cost/benefit-based evaluation may be performed by the MT to determine if growth and new work should be accomplished in an ongoing availability as required by Volume VI Chapter 31 of this manual. The Business Case Analysis performed by the MT is not a specific, formatted process but rather a deliberate, thoughtful decision process used whenever growth and new work is identified. This thought process should weigh the additional costs (premiums) against operational requirements. In some cases, it may be advantageous to complete the growth or new work during the availability; in other cases, it may make more sense to defer the work to a follow-on Continuous Maintenance period. The MT should consider all premiums associated with adding the work to the availability including the effect on the contractors' workload and the premium associated with the late addition of work.

3.7.6.3 Maintenance Figure of Merit. In addition the MT will utilize the Maintenance Figure of Merit to validate that new work most critical to mission accomplishment receives priority when allocating maintenance resources. Maintenance Figure of Merit does not apply to modernization items.

3.7.6.4 Option Items. In some cases the added work may have been covered by an option item that was included in the contract as a stand-alone work specification with a defined work scope that is not to be accomplished unless specifically invoked. Option items are used when there is uncertainty at the time of availability package lock as to whether or not specific, defined work is required. Requirements for use of option items are the same as those for Firm Fixed Price Contracts as defined in Volume VI Chapter 31 paragraph 31.5.3 of this manual.

APPENDIX A

MASTER SHIP REPAIR AGREEMENT

This AGREEMENT is entered into this ____ day of _____ by the UNITED STATES OF AMERICA, hereinafter called the "Government," represented by the Contracting Officer, Naval Sea Systems Command, Washington Navy Yard, DC 20376 and _____, a corporation organized and existing under the laws of the State of _____, (the "Contractor").

The purpose of an MSRA is to provide a contracting vehicle for the issuance of job orders for the repair and overhaul of ships. The specific qualification requirements governing MSRAs are contained in the latest version of NAVSEAINST 4280.2. This Master Agreement does not indicate approval of the contractor's organization and facility for any particular acquisition and is not an affirmative determination of responsibility under FAR Subpart 9.1 for any particular acquisition.

The clauses in this Agreement will be incorporated, by reference or attachment, in job orders issued under this Agreement to affect repairs, alterations and/or additions to vessels.

By giving 30 days written notice, either party to this Agreement has the right to cancel it without affecting the rights and liabilities under any job order existing at the time of cancellation. The contractor will perform, under the terms of this Agreement, all work covered by any job order awarded before the effective date of the cancellation.

This Agreement may be modified only by mutual agreement of the parties. A modification of this Agreement will not affect any job order in existence at the time of modification, unless the parties agree otherwise.

The rights and obligations of the parties to this Agreement are set forth in this Agreement and the clauses of any job orders issued under this Agreement. In the event there is an inconsistency between this Agreement and any job order, the provisions of this Agreement will govern.

This Agreement will remain in effect until canceled by either party.

THE UNITED STATES OF AMERICA

by _____

(NAVSEA Contracting Officer)

(Contractor)

by _____

(Authorized Individual)

(Title)

The RMC Contracting Officer will insert the following required clauses in all job orders awarded under this Agreement:

- (1) 252.217-7003 Changes
- (2) 252.217-7004 Job Orders and Compensation
- (3) 252.217-7005 Inspection and Manner of Doing Work
- (4) 252.217-7006 Title
- (5) 252.217-7007 Payments
- (6) 252.217-7008 Bonds
- (7) 252.217-7009 Default
- (8) 252.217-7010 Performance
- (9) 252.217-7011 Access to Vessel
- (10) 252.217-7012 Liability and Insurance
- (11) 252.217-7013 Guarantees
- (12) 252.217-7014 Discharge of Liens
- (13) 252.217-7015 Safety and Health
- (14) 252.217-7016 Plant Protection, as applicable. (Use this clause in job orders where performance is to occur at the contractor's facility.)

The RMC Contracting Officer will insert in all job orders any other clauses on subjects not covered by this Agreement, but applicable to the job order to be awarded.

This Agreement is applicable to job orders awarded by either the Naval Sea Systems Command or the Military Sealift Command.

Each job order awarded under this Agreement will specify the Contract Administration Office.

APPENDIX B

AGREEMENT FOR BOAT REPAIR

This AGREEMENT is entered into this ____ day of _____ by the UNITED STATES OF AMERICA, hereinafter called the "Government," represented by the Contracting Officer, Naval Sea Systems Command, Washington Navy Yard, DC 20376 and _____, a corporation organized and existing under the laws of the State of _____, (the "Contractor").

The purpose of an Agreement for Boat Repair (ABR) is to provide a contracting vehicle for the issuance of job orders for boat/craft overhaul/repair work, and/or selective component, and/or selective ship repair work. The specific qualification requirements governing ABRs are contained in the latest version of NAVSEAINST 4280.2. This Agreement for Boat Repair does not indicate approval of the contractor's organization and facility for any particular acquisition and is not an affirmative determination of responsibility under FAR Subpart 9.1 for any particular acquisition.

The clauses in this Agreement will be incorporated, by reference or attachment, in job orders issued under this Agreement to affect repairs, alterations and/or additions to vessels.

By giving 30 days written notice, either party to this Agreement has the right to cancel it without affecting the rights and liabilities under any job order existing at the time of cancellation. The contractor will perform, under the terms of this Agreement, all work covered by any job order awarded before the effective date of the cancellation.

This Agreement may be modified only by mutual agreement of the parties. A modification of this Agreement will not affect any job order in existence at the time of modification, unless the parties agree otherwise.

The rights and obligations of the parties to this Agreement are set forth in this Agreement and the clauses of any job orders issued under this Agreement. In the event there is an inconsistency between this Agreement and any job order, the provisions of this Agreement will govern.

This Agreement will remain in effect until canceled by either party.

THE UNITED STATES OF AMERICA

by _____

(NAVSEA Contracting Officer)

(Contractor)

by _____

(Authorized Individual)

(Title)

The RMC Contracting Officer will insert the following required clauses in all job orders awarded under this Agreement:

- (1) 252.217-7003 Changes
- (2) 252.217-7004 Job Orders and Compensation
- (3) 252.217-7005 Inspection and Manner of Doing Work
- (4) 252.217-7006 Title
- (5) 252.217-7007 Payments
- (6) 252.217-7008 Bonds
- (7) 252.217-7009 Default
- (8) 252.217-7010 Performance
- (9) 252.217-7011 Access to Vessel
- (10) 252.217-7012 Liability and Insurance
- (11) 252.217-7013 Guarantees
- (12) 252.217-7014 Discharge of Liens
- (13) 252.217-7015 Safety and Health
- (14) 252.217-7016 Plant Protection, as applicable (Use this clause in job orders where performance is to occur at the contractor's facility.)

The RMC Contracting Officer will insert in all job orders any other clauses on subjects not covered by this Agreement, but applicable to the job order to be awarded.

This Agreement is applicable to job orders awarded by either the Naval Sea Systems Command or the Military Sealift Command.

Each job order awarded under this Agreement will specify the Contract Administration Office.

VOLUME VII
CHAPTER 4
CONTRACT SPECIFICATION DEVELOPMENT

REFERENCES.

- (a) FAR 14.201-1 - Uniform Contract Format
- (b) FAR 14.204-1 - Records of Invitations for Bids and Records of Bids
- (c) DFARS 217.71 - Master Agreement for Repair and Alteration of Vessels
- (d) DFARS 211 - Describing Agency Needs
- (e) FAR 11.104 - Use of Brand Name or Equal Purchase Descriptions
- (f) NAVSEAINST 9070.1 - Standard Specification for Ship Repair and Alteration Committee
- (g) NAVSEAINST 4710.9 - Requirements for Turnover of Planning Products and Specification Package
- (h) FAR 45.303 - Providing Material
- (i) NAVSEA S9086-7G-STM-010 - NSTM Chapter 997 (Docking Instructions and Routine Work in Dry Dock)
- (j) NAVSUPPUB 437 - Material - Required Delivery Date Processing
- (k) OPNAVINST 4614.1 - Uniform Material Movement and Issue Priority System
- (l) OPNAVINST 4780.6 - Policy for Administering Service Craft and Boats in the U.S. Navy

LISTING OF APPENDICES.

- A Specification Review Check List
- B Specification Review Summary Sheet
- C Summary Cost Estimates
- D Work Specification Transmittal
- E Procedures for the Preparation and Use of Work Item Specifications for Ship Repair
- F Work Package Integration Conference Agenda and Check List

4.1 PREPARATION OF SPECIFICATIONS AND ESTIMATES OF COST.

4.1.1 Purpose. This chapter provides a general discussion and specific guidance for the preparation of specifications that are developed for specific work items or ship alterations brokered for accomplishment by the private sector. The specification shall be integrated into a solicitation work package that upon contract award forms the basis for supervising and administering the agreed upon terms and conditions of the contract.

4.1.2 Scope. Contracts with commercial shipyards follow the Uniform Contract Format as specified in references (a) and (b). The Navy uses a variety of contract types, as stated in Chapter 2 of this volume, to obtain the required services, products, material and Integrated Logistic Support for the repair and modernization of surface force, aircraft carrier and submarines. The substance of these contracts depends upon clear, well defined specifications developed for each specific repair work item or alteration included in the work package accompanying each solicitation or job order presented to the contractor for use in preparing an offer. A job order is the contractual vehicle that is used under the Master Ship Repair Agreement or Agreement for Boat Repair as addressed in Chapter 3 of this Volume. The Master Agreement for Repair and Alteration of Vessels as authorized by reference (c) applies. If naval standards are required for proper accomplishment of the work by the contractor, the specifications prepared by the work item planner must invoke these requirements.

- a. The Navy Modernization Program is discussed in Volume VI, Chapters 3 and 36 of this manual. The end product of the processes must fully support the development of well defined technical specifications, associated guidance, identification of Long Lead Time Material, installation drawings, etc., that are prerequisites for developing an effective specification.
- b. The validation of work items identified in the Current Ships Maintenance Program and the associated planning processes addressed in this manual are critical to the work item planner tasked with the responsibility for development of each individual specification.

- c. To facilitate the development of work items and modernization packages in support of contracted ship maintenance, long-range planning and action milestones are required. Typical availability planning milestones for Chief of Naval Operations (CNO) availabilities for Submarines, Surface Force and Aircraft Carriers can be found in Volume II of this manual.

4.1.3 Design Versus Performance Specifications. Well-written specifications are a prerequisite to successful repair and modernization work. The two major benefits resulting from well-written specifications are reduction in costs and higher standards of workmanship. Unlike job orders prepared for use at Naval Ship Yards, specifications used by commercial shipyards must not only describe the work to be accomplished, but must clearly outline the contractual obligations and responsibilities of the repair contractor. It is particularly important that specifications be clear, concise, complete and definitive since unclear specifications not only cause technical questions and difficulties but also result in higher prices and scheduling problems. The Government assumes the risk of contractor performance when the specifications it furnishes are not suitable for their intended purpose. Specification adequacy arises only when the Government furnishes a specification, which only provides for the accomplishment of end results.

- a. A design specification details the manner or method of contractor performance. The implied warranty of specification usually includes precise measurements, tolerances, required processes and finished product tests. The contractor is bound to follow all of the Government's directions in a design specification. If the contractor follows these directions and is unsuccessful, the Government has assumed the risk, and as a result the Government has breached the implied warranty of specification adequacy.
- b. A performance specification provides for the operational requirements and only dictates end results. The contractor assumes the risk of choosing its method of achieving the end results in a performance specification. If the contractor fails to achieve the end results in a performance specification, and the specification is neither impossible nor commercially impracticable, the Government has not breached the implied warranty of specification adequacy.
- c. Many Government specifications are a combination of design and performance specifications. Accordingly, it must be determined which requirement has caused the problem, if any, and then that requirement must be analyzed using the above rules. It is recommended to confer with responsible contract personnel and legal counsel when addressing problems associated with alleged implied warranty of specification adequacy.
- d. Determining if a specification is performance-based is difficult. Specifications in which the vast majority of requirements are performance-based and contain a design definition appropriate for the particular phase of the effort should be considered compliant with Department of Defense (DoD) policy.
- e. Specifications are composed of a set of requirements statements. Requirement statements contain the word "shall". Any statement that is not mandatory should be reviewed only from the standpoint of clarifying to the requirement definition. The review of specifications consists of locating the requirements ("shall") statements and assessing whether those statements are performance-based.
- f. Performance-based requirements statements should bring about a solution at a very high level, whereas detail requirements statements should constrain the solution at a very low level (most often only a single or preferred option for resolution). Determining whether a requirement statement brings about a solution at a "high" or "low" level is judgmental.

4.1.4 Regulatory Requirements for Specifications. Important considerations for the specification writer are derived from the Federal Acquisition Regulations (FAR) and the Defense Federal Acquisition Regulation Supplements. The FAR defines a specification as a description of the technical requirements for materials, products or services that includes the criteria for determining whether these requirements are met.

- a. The FAR further requires that specifications state only the Government's actual minimum needs and be designed to promote full and open competition. The FAR has the force of law and must be followed. Therefore, anyone preparing specifications must necessarily understand certain regulatory requirements. Reference (d) contains the regulations that govern specifications, standards and other purchase descriptions. These regulations should be read carefully and understood by any specification writer.

- b. To achieve the contract objectives of obtaining satisfactory performance and full and open competition, certain basic standards in drafting specifications must be observed. They must be drafted in a clear, well-defined manner. Less than clear provisions may limit full and open competition in the acquisition process by preventing those making offers from competing on a “common” or equal basis. This occurs when those making offers interpret the specifications and arrive at different reasonable conclusions about what kind of performance they will be required to render. The result is that they submit offers reflecting different kinds of performance. In sealed bid acquisitions, bidding on an equal basis has generally been considered to require bidding documents that are so clear and precise that all bidders are offering essentially the same product or service. The outcome is that bids can be compared and selection for award made solely on the basis of price and other price-related factors. In negotiated acquisitions, which sometimes involve a balancing of technical merit and price, those making offers may submit markedly different technical proposals to meet the Government’s needs. Competition on an equal basis generally means that specifications must be sufficiently clear and complete to afford all potential bidders an equal basis to understand the Government’s basic requirements.

4.1.5 Restrictive and “Brand Name or Equal” Specifications. Specifications also must be written in an “unrestricted” manner. Specifications are “restrictive” if they include requirements that limit competition and are not necessary to ensure satisfaction of the Government’s basic needs. This kind of restrictiveness of competition may favor one contractor over another and it may also prevent the Government from getting the kind of performance which can best satisfy its needs at the most reasonable price. Where the contractor supplies ship repair materials or equipment, the work item planner should not specify the products of individual manufacturers. Instead, the work item planner should describe the technical specifications which the material or equipment must meet to obtain satisfactory performance. This will ensure free and open competition among suppliers and subcontractors and, ultimately, will result in lower costs for the Navy. If it is difficult or impossible to give suitable specifications for materials or equipment, the work item planner may stipulate that the contractor supply a specific manufacturer’s model “or equal” and state the salient characteristics that make it “equal” pursuant to reference (e).

4.2 WORK PACKAGE DEVELOPMENT.

4.2.1 Work Packages for Non-Private Sector Industrial Activity Contracts. In writing work item specifications, the Executing Activity (EA) planner(s) may frequently include requirements from multiple Ship Work List Item Numbers (SWLIN) in a single work item. Conversely, work requirements of a single SWLIN may be included in multiple work items; however, the most common and most desirable practice is to prepare a single work item to include all work requirements of a single SWLIN. During review, the specification must be checked to ensure that each SWLIN work requirement authorized for shipyard accomplishment is contained in the Specification Package. Appendices A through D provide formats that should be used by the planner when writing specifications and assembling solicitation/work packages for projects that are not covered by the Private Sector Industrial Activity Contract. Work items normally specify only what the contractor is to do rather than how to perform the work. There may be instances when adherence by the contractor to a specific manner of accomplishing the work will be required because of a requirement in a Navy document or manual. The procedures must be clearly defined for the performance of the work. Specifications must be written in a logical sequence of work operations (i.e., remove, disassemble, inspect, report, repair, reassemble, shop test, reinstall and ship test). Each specification shall clearly define the work requirements and be as self-contained as possible to enable the contractor to understand the requirements without having to research referenced data. Specifications must never upgrade equipment and installations to exceed the existing configuration of the ship. Furthermore, material requirements will be equal, as a minimum, to the original installation and service requirements. Appendix E provides guidance for work item planners charged with development of ship repair and modernization specifications.

4.2.2 Work Packages for Private Sector Industrial Activity Contracts. Work Package Preparation is discussed in Volume II, Part II, Chapter 2 of this manual.

4.2.3 Naval Sea Systems Command Standard Specification Program.

- a. Under reference (f), the Standard Specification for Ship Repair and Alteration Committee (SSRAC) is responsible for the generation, revision and control of Naval Sea Systems Command (NAVSEA) Standard Items (SI) commencing with SI -009-01 and Standard Work Templates. The SSRAC meets annually to review and approve changes to NAVSEA Standard Items, Standard Work Templates, and procedures for preparation and use of work templates. Specification improvement recommendations are welcomed and shall be provided to the SSRAC.

- b. Work items shall be written consistently so that identical work activities and requirements are specified at the same time they are included in a contract specification. Consistent language throughout a contract makes it easier to understand. Through continuous use, the phrases used take on a special meaning and gain acceptance within the industry. The SSRAC develops and publishes Standard Phraseology yearly. Specification writers should become familiar with the material in Appendix E. It shall be consulted frequently to ensure Standard Phrases are used properly. Like Standard Items, Standard Phrases are published by fiscal year designation. Specification packages shall be prepared using the standards when they are issued by the SSRAC chairman regardless.

4.2.4 Standardization Usage. Once a work item specification has been prepared, as is the case with the Master Specification Catalog, to address a specific set of SWLIN requirements, it shall be used whenever the same requirements are authorized for accomplishment on another ship of the class. In most cases, an original work item has the greatest chance of resulting in a contract change. The fundamental thrust of the NAVSEA standardization program is that tried and proven contract requirements are generally superior. Standardization and consistent usage of approved standards tends to strengthen the quality of specification packages over time by improving the ship repair industry acceptance of the standards used.

4.3 SPECIFICATIONS.

4.3.1 Preparation of Specification Work Items. All specification work items must conform to the same basic format and will comply with the requirements and policies established by reference (f) and amplified by Appendix E. These documents establish the organization and responsibilities for development, revision and control of standard specifications. Specification work items are written to convey the Government's requirements to the contractor. They are extremely important for several other reasons. The specifications are the heart of the contract and serve as the basis for the formation of offers by the shipyards, the baseline for the evaluation of offers and, after award, the means for binding the contractor to required performance. In judging acceptable performance, the Government is bound by the contents of the specifications when testing or inspecting the contractor's work results. The specifications serve as the basis for determining whether desired work is a change to the contract or is already required.

4.3.2 The Specification Package. The specification package may consist of applicable NAVSEA Standard Items, Standard Work Templates and unique templates, as discussed in Chapter 2 of this Volume, that are contained in the Master Specification Catalog, resident in the Navy Maintenance Database (NMD) in the Planning Module. These Items and Templates are written to standardize the requirements across the Maritime Industry to specify action that is required by the contractor to accomplish the intent of the work authorized for shipyard accomplishment. The requirements for planning products and the specification package are identified in reference (g). This directive provides detailed guidelines on turning over work package products from the Planning Activity to the Procuring Contracting Officer (PCO) for solicitation and from the PCO to the Administrative Contracting Officer after contract award.

4.3.3 Master Specification Catalog. Master Specification Catalog is discussed in Volume II, Part II, Chapter 2 of this manual. Planning Activities/Executing Activities Planning who are responsible for the preparation of work item solicitation packages shall use the Master Specification Catalog databases to the maximum extent possible when planning assigned work using NMD and other Maintenance Automated Information System. Additionally, they shall also provide input to the Master Specification Catalog gatekeepers for improvement of the existing catalog or to propose new candidates for the catalog.

4.4 PREPARATION.

4.4.1 Steps in Preparing a Work Item Specification. Unless clearly unnecessary, the steps to follow in preparing a specification are:

- a. Determining the Government's requirements and a preliminary understanding of what the contractor must do in order to satisfy these requirements.
- b. Research, data gathering and analysis.
- c. Preparation of a detailed outline.
- d. Preparation of the initial draft.

- e. Review and editing by the writer.
- f. Team review and modification.

4.4.2 Determining Requirements and Understanding What the Contractor Must Do. The specification writer must begin with obtaining a clear and full understanding of the Government's requirements through the use of on-site ship checks, validation of the work candidate against the system/equipment operating conditions and discussions with the point of contact or those familiar with the work request. Failure to do so will at best result in less than the Government wanted and at worst a useless product. Once a clear and full understanding of the Government's requirements is obtained, the specification writer shall determine what the contractor must do to satisfy the requirements. In some instances this determination will only be a preliminary one, as the performance of subsequent steps will frequently result in changes to the original determination.

4.4.3 Research, Data Gathering and Analysis. Part of the first step frequently involves research and data gathering. In some instances, it may be necessary to essentially reverse the order of performance. The specification writer can best make that determination based on all attendant facts and circumstances. The specification writer should avoid believing that everything one needs to know to write a proper specification is readily available.

- a. In general, the best place to start in research and analysis is to determine if the Government has previously accomplished the same or similar work. This can be accomplished by coordinating with appropriate project and contracting officers and by checking with other activity planners. The Master Specification Catalog Maintenance Office maintains the database of master specifications for D-Level maintenance and another maintenance Automated Information System contains data for I-Level maintenance. Once previous work items are identified, a copy of the specification(s) should be obtained along with information regarding problems that may have arisen pertaining to the specification. Where sufficient information does not exist, the specification writer should not be hesitant to contact other agencies for information. For example, DoD may provide useful information pertaining to aerial photography. The Army Corps of Engineers or the Environmental Protection Agency may provide information on such subjects as disposal of hazardous waste.
- b. Previously used specifications, regardless of their source, shall never be used without reviewing for current applicability. Regulations, processes and procedures frequently change. In addition, Government requirements sometimes change, capabilities between contractors are widely variable and the unedited use of previously used specifications may cause the recurrence of mistakes or deficiencies in the specification.
- c. There are many other potential sources of information (e.g., textbooks, commercial associations, Federal and military specifications and standards, manufacturers' catalogs, periodicals, microfilm files and society publications such as American Society for Testing and Materials and the American National Standards Institute).
- d. Federal specifications should be selectively applied and tailored to their application. ("Selective application" is the process of reviewing specifications, standards and related documents to ensure that only those that have application to a particular acquisition are included or tailored in the solicitation.) A number of existing specifications may be included in the contract specification.
- e. "Tailoring" is the process by which individual sections, paragraphs or sentences of the selected specifications, standards and related documents are reviewed and modified so that each one selected states only the Government's minimum requirements.
- f. The American Bureau of Shipping Rules and U.S. Coast Guard Regulations provide specific direction. American Bureau of Shipping and NAVSEA have an active program to develop Naval Vessel Rules that will have future application.

4.4.4 Availability of References. Contractors are required to obtain, from sources designated as repositories, copies of standard Navy drawings, referenced specifications and standards. Other required references are provided by the planning activity/PCO with the solicitation package or are made available for examination at a designated location. Required references not made a part of the solicitation package are turned over to the successful contractor at award. The work item planner ensures the requirements specified for each work item adhere to prescribed technical standards of work. These technical standards are included in publications such as:

- a. Naval Ships' Technical Manuals cover general operating and maintenance instructions on shipboard systems, equipment and material under the cognizance of NAVSEA.
- b. Military and Federal specifications provide uniform standards and specified tests for materials, products, or services used by the military services. Specific data on particular designs of equipment set forth in equipment Technical Manuals (TM), manufacturer's instruction books and manufacturer's drawings.
- c. Specific data for particular ship system applications set forth in the Ships Information Books, General Information Booklets, Piping Systems Instructions Book, etc., as appropriate to a particular ship and item.
- d. Specific details on electronics installations, maintenance standards and procedures as set forth in the Electronics Installation and Maintenance Book.
- e. The Planned Maintenance Subsystem supplied to the ship for scheduled preventive maintenance.
- f. NAVSEA and other Systems Commands directives applicable to specific processes, procedures or standards.
- g. Master Specification Catalog containing D-Level work item templates for multiple ship classes planned in NMD.
- h. Locally prepared drawings, sketches, design instructions and similar data.
- i. The General Specifications for Overhaul of Surface Ships.
- j. The General Specifications for Ships of the U.S. Navy.
- k. Deep Diving General Overhaul Specifications.
- l. American Bureau of Shipping Rules.

4.4.5 Preparation of a Detailed Outline. After completion of the first two steps, it may be helpful to arrange the data selected for use into an organized format that identifies the key areas to be covered. This step may not be necessary for easier specification preparation efforts but will be very useful for more complex efforts. A detailed outline approach is recommended. To prepare the outline, the data accumulated in the preceding steps should be further analyzed, organized and presented in chronological order and desired format. The outline should consist of the key words and skeleton phrases of the proposed specification. The outline is sufficiently detailed, contains all key aspects and be organized properly to be as useful as possible. Once complete, the outline serves as a "road map" for the specification writer. It allows the writer to expand and fill in necessary details without being overly concerned about the organization of the specification. Such an approach will make the task of writing the actual specification less difficult and enhance the quality of the specification.

4.4.6 Preparation of the Initial Draft. Once the detailed outline is complete (if determined necessary), the initial draft of the specification should be written. The difficulty of this step will depend primarily on how well the preceding three steps have been performed. If they were adequately performed, the preparation of the initial draft should not be overly difficult. The experience and other pertinent qualifications of the writer will also determine the difficulty of the effort. The draft should closely parallel the outline unless deficiencies are discovered. By using the outline, the writer should be able to write quickly and not ponder over those aspects already considered in the outline.

4.4.7 Material Requirements. The contractor shall furnish material required for the performance of any contract unless provided as GFM. Any other material required for performance is Contractor Furnished Material. In contracts it is Government policy, in accordance with reference (h), for contractors to supply all labor and material required for performance of the terms and conditions of the contract. One exception is the Government has the right to provide material as GFM whenever it is determined to be in the best interest of the Government. Long Lead Time Material should be provided as GFM. This material is defined as that which is not commercially or otherwise available to the contractor in time to support the performance schedule. The following material should be considered GFM:

- a. Parts unique to or obtainable only through the Government.
- b. Standardization material (System Procured Material/Contractor Procured Material for Alterations) (for configuration consistency).
- c. LLT Material (including any material not available in time to support production).
- d. Parts requiring provisioning of technical documentation (new components not supported in the Navy supply system).
- e. Stocked material: In long supply (supplies far in excess of demand), expiring shelf life (material in stock will expire if not used) or Class Maintenance Plan (CMP) programmed material (pre-positioned for special CMP programs).
- f. Whenever it is in the best interest of the Government.

4.4.7.1 Qualified Products Lists. It is required that some materials of a specialized nature be procured only from suppliers who have been found qualified to produce or install these materials to Navy standards. Contractors so qualified are identified on Qualified Products Lists (QPL). The QPLs contain lists of all items for which qualified suppliers are required, arranged by military specification number, and indicate the qualified suppliers for each item. In preparing descriptions for work items which will require use of materials shown on a QPL, the planner should specify that the contractor will obtain these materials from a supplier on the QPL and should provide a list of the qualified suppliers from whom the contractor may obtain these materials.

4.4.7.2 Turnaround Items. Work items may require the contractor to remove certain items of equipment and ship them to specific Government activities for necessary repairs. These "turnaround" procedures are frequently desirable in the case of highly technical equipment such as gun sights and gyroscopes. They shall be used, however, only when specific activities have been designated to repair or service such equipment. They shall not be used when equipment is to be shipped to subcontractors selected by the prime contractor for the performance of specialized work. The work items may require that the contractor provide the services of a manufacturer's field representative to supervise and instruct contractor personnel in the performance of repair work on specific equipment produced by that manufacturer.

4.4.8 Tests, Inspections and Performance Criteria. Inspection and test requirements in work items shall be equal to the level of criticality of the work to be performed and shall be included in all specifications in accordance with the information provided in and the guidance for Appendix E Specifications. The work item planner shall be thoroughly familiar with the requirements outlined in Volumes IV and V of this manual that specifically address the minimum tests and inspections that are to be accomplished in association with various types of availabilities.

- a. After specifying acceptable performance requirements, equally acceptable performance criteria, if different, must be stated. The criteria must be definitive and, above all, reasonable. The work item should contain simple performance criteria that can be used to prove the contractor's compliance with the specifications. The criteria should be precisely stated to satisfy the minimum needs of the Government for the work. Vague, nebulous or indefinite criteria shall be avoided. The performance criteria shall be based on applicable reference documentation. Performance standards are prescribed for many ship repair requirements in various publications and drawings and these standards should be used in performance criteria. Cleanliness standards, machined surface standards, non-destructive testing standards and numerous other standards unique to trade groups, processes or materials shall be used wherever possible.
- b. When a well-established standard cannot be identified for use in specifying performance criteria, a simple test can be created to prove the contractor's work. In devising such tests, tolerances may be all that are required. A minimum, a maximum or a range of tolerances may be sufficient to prove performance. Simple tests can be performed such as hydrostatic tests, weight tests, pressure tests or pull tests. In more difficult situations, it may be necessary to require an engineered test to prove satisfactory performance.
- c. When tests are required for equipment after repair, such tests shall be fully described and set forth in the work items. Work items may specify certain tests are to be conducted during normal working hours. For a critical test and inspection, it may be necessary to ensure that the Regional Maintenance Center

(RMC) quality assurance representative or a cognizant government representative be available to simultaneously witness the event normally called out as a Government required "G" inspection or observation check point. Where tests will be elaborate or complex, the work item planner may obtain test memoranda from the appropriated RMC or naval shipyard design engineers that describe the tests conducted. The planner then incorporates these memoranda in the appropriate work item.

- d. If appropriate Technical Authority requires dock trials or sea trials, the trials will be specified in the job order. The specifications will include requirements for such trials if they are considered necessary and authorized by the Type Commander (TYCOM) or NAVSEA. For sea trials, the ship is normally operated by the Ship's Force and the contractor provides a specified number of personnel by trade to be aboard the ship during the trial. RMC should provide the ship with the list of personnel who will be aboard. Reference (i) contains further information on dock trials and sea trials. The requirement for trials specifies a scheduled number of days before the completion of work. Normally, the sea trials are scheduled from 4 to 7 days before the job order completion date to allow for adequate adjustment and correction of defects found during the trial. For similar reasons, the dock trial should be scheduled from 2 to 3 days before the sea trial.

4.4.9 Split Repair Responsibility. To avoid doubts about responsibility for completed work and to minimize physical interference and safety hazards, ship's personnel should not work on any unit or system on which the contractor is also working. Work items, to the maximum extent possible, shall not be written to require the performance of work by both the Government Personnel or Government obtained Third Party Contracts/Vendors and the executing contractor on the same unit or system.

4.5 SPECIFICATION REVIEW.

4.5.1 Review and Editing by the Writer. After the initial draft of the specification is complete, the writer will need to review and edit it. Organization, content and material covered, format and sequence or chronology will need review. Poor grammar and punctuation, ambiguities, gaps or omissions, wordiness and clerical errors should be corrected. A work item specification check list and review summary sheet are provided in Appendices A and B to assist reviewers in making a systematic and thorough evaluation of a work specification package. The check list contains a listing of each element of the work item heading and each paragraph of the work item. Under each listing, a description of applicable requirements from the regulations is provided with a block to check for each element. This check list is a consolidated listing of things to look for during the review. Work specification reviews can now be performed online via the Online Specification Review process that utilizes www.spear.navy.mil.

Questions useful to the specification writer in determining the adequacy of the efforts are:

- a. Does the specification clearly tell the contractor what is required?
- b. Is only information necessary to assist the contractor in understanding what is required included (e.g., have the "nice to have" items been eliminated from the "essential" items)?
- c. Will the Government and contractor be able to achieve reasonable pricing?
- d. Will the contractor's tasks, when accomplished, produce results consistent with contract objectives?
- e. When appropriate, does the specification clearly tell the contractor how to perform?
- f. Can the Government representative who accepts the required supplies or services tell whether the contractor has complied with contract requirements (e.g., are standards for measuring performance clearly stated)?
- g. Is the specification sufficiently detailed to permit the Government and the contractor to identify manpower resources, special facilities, equipment, subcontracts and similar requirements?
- h. Is information differentiated so that background information, suggested procedures, etc. are clearly distinguishable from contractor responsibilities? (Statements that do not directly contribute to an understanding of requirements should normally be avoided since they may create ambiguities, confusion and greater costs.)
- i. Are reference documents (e.g., specifications, standards and exhibits) properly shown and cited? Are they pertinent to the task(s)? Do they fully apply or only partially?

- j. Are milestone completion or delivery dates appropriately established? If “elapsed” time is used, is it clear concerning calendar days or workdays?
- k. Are proper quantities shown?
- l. Have data requirements (e.g., technical, financial and progress reports) been properly identified for such things as frequency, content, format and place of submission?

4.5.2 Review and Editing by Someone Other Than the Writer. Once the writer has completed the preceding step, it is a good practice to have someone else who has the necessary technical qualifications or editing skills, review, edit and critique the draft specification. The technical review and editing functions may be performed by different individuals.

4.5.3 Team Review and Modification. The last step is team review and modification. In many cases this will be performed by the Ship’s Maintenance Team and other government representatives as appropriate. The completed draft may be routed for review by contracting, legal and other personnel, as appropriate, and depending in part on the complexity or government’s and contractor’s liability or risk associated with the contractor’s performance in complying with the specification. Contracting and legal personnel often identify language or other aspects of the specification they know from prior experience will cause problems. The technical content must not be adversely affected by recommended changes to the specification. The process of team review and modification may be required a number of times before all recommendations and comments are adequately resolved. Once all necessary modifications to the specification are made, it is finished and ready for insertion into the solicitation work package and for the PCO’s action.

4.6 OTHER FUNCTIONS OF THE WORK ITEM PLANNER. In addition to writing work items and preparing cost estimates for them, the planner is responsible for starting other actions for successful performance of proposed modernization and repair work.

- a. The work item planner must determine the drawings and technical instructions (e.g., manufacturers’ TMs) which will be required for preparation of the work items and for the contractor’s guidance in accomplishing the required work. The planner must initiate requisitions for these publications sufficiently far in advance of the specifications’ cut-off date to permit their use.
- b. The work item planner is responsible for determining the ship repair materials and the GFM provided as alteration materials, if any, which the Government will provide the contractor. The purpose is to initiate requisition actions for these materials sufficiently far in advance of the overhaul period to allow for their timely receipt by the contractor.
- c. After award, a work item planner (or other cognizant RMC personnel) may have to secure for the contractor certain items of GFM which, because of changes to the job order, were not set forth in the original specifications. In addition, certain items that were available from commercial channels at the time the job order specifications were prepared may not be available when the contractor actually attempts to procure them. In such cases, the material may be obtained from Navy supply channels. However, it is preferable that the contractor procures the material from the Navy on a cash sale basis rather than the RMC provide it to the contractor as GFM. In a cash sale, the contractor maintains complete responsibility for procuring the items from the appropriate Navy supply activity. The RMCs’ only function is to certify that the material is not, in fact, available to the contractor through commercial sources and that it is required for accomplishing the job order.
- d. To obtain material from the Navy Supply System, the contractor is required to submit a request to the RMC procurement personnel for requisitioning the material in accordance with reference (j). Detailed instructions for the assignment of a priority to a requisition are in reference (k).

4.7 PLANNING REVIEW. After completion by work item planners, the work items and cost estimates are assembled and reviewed by the Technical Analysis Report Analyst. The work items should be subjected to a close “technical and contract review” to ensure that:

- a. Coverage of work conforms to that authorized for the availability or project.
- b. All technical aspects of the work are itemized and conform to requirements established by NAVSEA technical instructions and other publications.

- c. All necessary drawings and instructions are referenced.
- d. Identical work (such as cleaning and painting in identical areas) is not set forth in two or more work items.
- e. Work items are definitive, clear and explicit, and conform to quality assurance requirements.
- f. Work items meet the requirements of Appendix E.
- g. The Government will provide the proper documentation to support the contractor's preparation of the proposal. The PCO will designate the method and number of drawings and specifications for distribution. Ensure that the Ship's Force and Maintenance Team is provided with a set of specifications and references as soon as possible and in no case later than the date the solicitation is issued.
- h. The planning coordinator may summarize the budget estimates for the required work on a form similar to that in Appendix C. Appendix D is used to transmit the completed work specifications when the package is prepared by a planning activity that is other than the PCO or the RMC. The Planning Department transmits the proposed package to the RMC Contract Department. Appendix F provides the Work Package Integration Conference Agenda and Checklist. This conference may be performed as the Work Package Integration Review for Private Sector Industrial Activity Contracts.

4.8 NON-SCHEDULED AVAILABILITIES. One of the RMC's most important functions is to provide a process for performance of emergency work on Navy ships or work which cannot be delayed until the ship's next scheduled availability. This work may be accomplished during any of the availabilities listed in Volume II, Part I, Chapters 3 and 4 of this manual.

4.8.1 Special Planning Procedures. While some non-scheduled availabilities can be handled the same way as scheduled availabilities, others present severe planning problems for RMC personnel. For example, the Maintenance Team and work item planner will frequently not have an opportunity to make a planning inspection of the work on the ship but will have to prepare work items or estimated costs solely on the basis of the ship's work requests or from descriptions of the work contained in dispatches from the ship. Where it is not possible to perform an inspection of the work item, the port engineer may find it necessary to telephone the RMC technical codes and describe the work to be set forth in the work items in order to minimize planning time. At this time, the planner should also begin priority procurements, if required, for GFM and drawings. In addition, the planner should check to see if the job or similar work descriptions already exist in the technical library. Unscheduled maintenance requirements mandate the establishment of special procedures. Frequently, the first notice of a non-scheduled availability will come in the form of a telephone call from the cognizant TYCOM or Operational Commander. If time is short, the available members of the ship's Maintenance Team together with the RMC representatives and planner should obtain the following information during this call:

- a. As complete a description as possible of the nature of the difficulties.
- b. Present location of the ship.
- c. Nature and urgency of the ship's current operating commitments.
- d. Whether the ship is disabled or can move to the repair yard under its own power.
- e. Whether "hot work" (such as welding or burning) will be required, and whether this will require off-loading of fuel or ammunition (if off-loading is required, it should be accomplished before entering the contractor's yard).
- f. Whether the ship has suffered underwater damage which will require dry-docking and, if so, if other routine dry-dock work can be done (such as the renewal of zincs, bottom cleaning and painting, sea chest/sea valve repair and repairs to underwater sound equipment).

4.8.2 Other Non-Scheduled Work. RMCs may from time to time receive work requests from ships under the management control of miscellaneous user activities. Examples include service craft and boats (under the cognizance of a USER command) and inactive ships in Inactive Ship Maintenance Facilities (under the cognizance of the Inactive Ship Maintenance Facilities Officer-in-Charge). The information provided would be similar to that described above.

- a. In accordance with reference (1), RMCs may be requested to provide technical assistance and advice for the preparation of work lists, overhaul schedules and cost estimates for service craft and boats. If the RMC personnel are available for the task, every effort shall be made to fulfill such requests.
- b. Preparation of clear, comprehensive and accurate work requests by the user activity is a prerequisite to successful overhaul and repair. On the basis of these work requests, the RMC planner shall prepare the work items for the work to be performed, estimate the costs and time required for the work and determine and order the necessary plans and material which the Government will furnish to the contractor. While the planner, whenever possible, will inspect the work to be accomplished, inadequate work requests will make it impossible to perform advance-planning functions such as obtaining necessary drawings and TMs. Adequate work requests are particularly important when, because of operating commitments, it is necessary to delay the planning inspection beyond the desired time or to omit it completely.

4.9 REGIONAL MAINTENANCE CENTER ACTIONS UPON RECEIPT OF WORK REQUESTS. Upon receipt of a work request from another government agency, the RMC Planning Officer or the individual designated by the Planning Officer, as the potential project coordinator, will distribute copies to individual planners who have previously been assigned cognizance over repair work in specific trade categories (e.g., hull, machinery, etc.) for the specific ship. The work item planner should initiate action at this time to obtain required drawings and other technical information necessary for the preparation of work item specifications or for inclusion in the work package that will be issued in the job order. In many cases it will not be feasible to do this until after the planning inspection when the planner determines the drawings or technical information that will be required based on inspection of the equipment.

- a. When the scope of work can be anticipated with reasonable accuracy before the planning inspection, the planner may be able to utilize the Master Specification Catalog to prepare the specification and initiate advance requisitions for GFM required for the work. As in the case of drawings and technical information, however, it will often be difficult to make a final determination in this respect until after the planning inspection.
- b. The planner shall review previously prepared work items to ascertain if any work item is similar to the work requested. If the unit has previously been through an availability, a review of the work items accomplished during that availability could be of assistance in determining the extent of work which may be required to repair a system or a piece of equipment. This is especially true if a piece of equipment must be opened or a system tested by the contractor to ascertain the extent of the repairs. As a result of this review of prior work, “open and inspect” or “test and report” work items can be minimized.

(This Page Intentionally Left Blank)

APPENDIX A
SPECIFICATION REVIEW CHECK LIST

A. SHIP:

B. CUSTOMER ORDER ACCEPTANCE RECORD (COAR):

C. ITEM NO:

D. PROJECT CONTROL NUMBER (PCN):

E. CMP:

F. PLANNER:

G. SCOPE:

1. Title:
2. Location of Work:
3. Identification:
4. Security Classification of Equipment, Spaces and Documents:
 - a. Spaces:
 - b. Equipment:
 - c. Documents:

H. REFERENCES:

I. REQUIREMENTS:

J. NOTES:

K. GOVERNMENT FURNISHED MATERIAL (GFM):

(This Page Intentionally Left Blank)

INSTRUCTIONS FOR APPENDIX A

- A. SHIP:** Enter the ships name and hull number.
- B. COAR:** Enter the Customer Order Acceptance Record (Funding Code and Availability No.) as assigned by the RMC.
- C. ITEM NO:** Enter the Prime SWLIN and Three-Digit Serial No. as assigned by the RMC.
- D. PROJECT CONTROL NUMBER (PCN):** Enter the SWLIN and Item Numbers Addressed in Work Item. Verify and record that SWLIN items listed under PCN are covered in the work item and that nothing more is added in excess of the requirements authorized.
- E. CMP:** Enter the CMP Item Number (omit if not applicable).
- F. PLANNER:** Enter the last name of the specification writer of work item as assigned by the RMC.
- G. SCOPE:**
1. **Title:** Enter the brief work scope description in plain language. Check to ensure the scope is correct and consistent with the Maintenance and Material Management (3-M) Maintenance Action Form (2-Kilo). Ensure the objective is accurate and logical; for example, inspect, repair or replace.
 2. **Location of Work:** Enter the compartment name, number, frame, location description or “throughout the ship” where applicable (omit when not applicable). Ensure that the location is a logical expression in context with the requirements paragraph.
 3. **Identification:**
 - a. Enter the equipment or component name, identification numbers (Allowance Parts List, Equipment Identification Code/Component Identification) and quantities to be worked on (omit when not applicable).
 - b. Verify by comparison with the Ship Systems Configuration Index.
 - c. Ensure that the identification provided is logical in context with the requirements in the requirements paragraph. An error here can have great impact on the requirements.
 - d. Verify quantities agree with 2-Kilo requirements.
 4. **Security Classification of Equipment, Spaces and Documents:** Identify if any Equipment, Space or Document is classified and subject to the applicable provisions of the Industrial Security Manual, DoD 5220.22M (0526-LP-522-0060) (omit when not applicable).
 - a. Spaces: Identify spaces where access to classified work is required and level of classification required. (omit when not applicable).
 - b. Equipment: Identify any classified equipment and level of classification required. (omit when not applicable).
 - c. Documents: Identify any classified documents and level of classification required. (omit when not applicable).
- H. REFERENCES:** (All references to paragraphs refer to the Work Item Specifications for Ship Repair (Appendix E Specifications)).
- a. “Standard Items” shall be listed first if referenced in the item.
 - b. References required for performance must be listed.
 - c. Documents listed must be addressed in paragraph 3.
 - d. References used must be applicable for the ship’s configuration.
 - e. References shall address only applicable portions.

- f. General Specifications for Overhaul is a primary technical data source. It should not be referenced but paraphrased in requirements.
- g. References shall be listed in order of appearance in paragraph 3.
- h. Standard Items always appear first in paragraph 2.1 when Category II Standard Items are invoked in the work item.
- i. References are listed in lower case letters.
- j. If there are no references, the word "None" shall appear after "1".
- k. References should not begin an unlisted chain of sub-tier references.
- l. References shall not use restricted (proprietary) data.
- m. References shall identify the required version/revision or none at all if the version/revision in effect at the time of issue of the solicitation is applicable for the requirements.
- n. Listed references must be available.
- o. Listed references must be essential.
- p. If a reference on a reference is required for performance, it must be listed in paragraph 2.
- q. If references are classified, the classification is shown parenthetically following the title (i.e., (C) for Confidential or (S) for Secret).
- r. Military Specifications (MIL-SPECS) are not listed in paragraph 2 but are included in paragraph 3 when applicable.
- s. Basic Government specifications, standards or Navy Standard Plans are listed without prefix zeros or suffix letters or numbers.
- t. Non-standard drawings are listed by number, revision and title as on the drawing.
- u. References shall be limited to applicable technical data including: Standard Items, Drawings, TMs, Military Standards (MIL-STD) and Test Memos.
- v. Instructions/Notices/Letters/etc. shall not be used as references.

I. REQUIREMENTS:

- a. The requirements shall contain a detailed description of work and material required to meet the minimum needs of the Government.
- b. Requirements shall be specified as performance specifications containing the criteria to determine satisfactory performance or accept delivery.
- c. Design specifications shall not contain accept/reject or performance criteria unless directly related to the design.
- d. The requirements shall provide or reference all information needed by the contractor to understand what he is required to do and to price the cost of performance.
- e. The requirements shall include all descriptions of reports or other data required.
- f. All applicable Cat II SI shall be invoked using the standard phraseology in Appendix E.
- g. Abbreviations and acronyms shall be spelled out and followed with the abbreviation or acronym in parentheses the first time used in a work item.
- h. Interferences in systems identified in SI 009-23 shall be specifically identified in the requirements paragraph.
- i. It is not necessary to require compliance with public law/regulations.
- j. The requirements sentence structure should be in verb-noun format (imperative mood).
- k. The requirements shall describe work only as authorized in the 2-Kilo.

- l. Work requirements shall be written in logical sequence (chronological order) with one idea per paragraph and one thought per subparagraph.
- m. No more than four levels of subparagraphs are allowed in specifications; for example, four levels of indentation are represented by the subparagraph 3.1.1.1.
- n. Requirements can be broken down by trade or component, but chronology shall be maintained within trade or component requirements.
- o. The requirements language shall be simple, clear and concise.
- p. The accept/reject criteria for each performance requirement are clear and definite.
- q. Mandatory parts (GFM and Contractor Furnished Material) to be replaced shall be identified in the requiring paragraph as follows: TOTAL QUANTITY REQUIRED, NAME OF PART, and PIECE NO. ON 2, *FIGURE DRAWING NO., and PART NO. * (DELETE "figure" and/or "drawing" as applicable).
- r. Miscellaneous materials (e.g., fasteners, gaskets, seals, etc.) shall be listed as needed in the requirements text, giving the specifications (Military/Federal/etc.) required.
- s. G Points must be inserted where needed for the Government to verify in-process performance attributes (i.e., (G) Hydrostatic Test).
- t. Use of process control procedures shall be required where tests and inspections are not suitable for product conformance determinations.
- u. Specifications cannot require directed "sole source" subcontracts or products (i.e., technical representatives, vendors, name brands, unless justified and authorized).
- v. A name brand "or equal" product can be specified if the salient characteristics of the "or equal" provision are included in the requirements.
- w. All references shall be invoked in the requirements. Using the words "in accordance with 2.x" directs strict compliance with the reference. Using the words "using 2.x for guidance" means that the reference is for information only and not for strict compliance. The latter should be used sparingly and not as a "catch all" phrase.
- x. If references are not fully applicable, the applicable portions should be specifically identified in the requirements paragraph.

J. NOTES:

- a. Notes are used to provide essential explanations or information. They should never contain work requirements or any kind of contractor requirements.
- b. 2-KILO Notes identifying work items as a special category of work should be included in the specification work item notes, i.e., "This is a Level of Effort Item."

K. GOVERNMENT FURNISHED MATERIAL (GFM):

- a. If material is to be provided as GFM, it must be listed in this paragraph.
- b. If there is no GFM to be provided, enter the word "None" in this paragraph.
- c. GFM should be specified in the following format: TOTAL QUANTITY PROVIDED, NAME OF PART, PIECE NO., REFERENCE NUMBER, NATIONAL STOCK NO. and PARAGRAPH NUMBER.
- d. Verify that the GFM is identified in the paragraph number listed.

(This Page Intentionally Left Blank)

APPENDIX B
SPECIFICATION REVIEW SUMMARY SHEET

The review summary sheet has four columns. Column 1 is for recording the work item number. Column 2 is for recording the corresponding “prime” SWLIN and items under that SWLIN, which are covered in the work items. The first five digits of the work item will be the same as the SWLIN number for the prime SWLIN covered by the work item. The work item may also include other requirements from other SWLINS. These additional SWLINS and related items covered in the work item are recorded in Column 3. Column 4 is for recording review remarks.

Since work items and Ships’ Alteration Repair Package (SARP) requirements are sorted in SWLIN order, the review should for the most part be a parallel process. To ensure that the review systematically covers all work item requirements and all SARP requirements, use the following procedures:

1. Record the first work item number in Column 1 and the corresponding SWLIN and items under the SWLIN, which is covered in the work item in Column 2. The PCN in the heading of the work item should identify all SWLINS and related items covered in the work item. If additional SWLINS and items are listed under the PCN, record those SWLINS and item numbers in Column 3. Review the work item to ensure that all SARP requirements noted as “covered” are, in fact, covered in the work item. Note deficiencies in Column 4, “Remarks.” Also record in Column 4 any requirements in the work item not authorized in any of the SWLINS and items noted in Columns 2 and 3. Additional remarks should be recorded in Column 4 to reflect other work item deficiencies. The specification review check list should be used as a guide.
2. If the work item covers all items under the prime SWLIN, then go on to the next work item to continue the review. If the prime SWLIN contains additional items not covered by the work item, record them under that SWLIN on the next line of the review summary sheet. Limit the number of items on each line to three or four items unless all on a single line are clearly related and will be covered in the same work item. The objective in recording the items on the next line down is to leave space in Column 1 to record the work item number. At this point in the review, simply record the items not covered on the next line or lines as needed. This will record all items that are not covered under the prime SWLIN.
3. Review the next work item and repeat steps 1 and 2. Continue this review until all work items have been reviewed.
4. After the review of the total work package, examine each SWLIN and item listed in Column 3, starting at the top of the first page and going to the end of the review sheets. For the first SWLIN listed in Column 3, look under that SWLIN in Column 2 to see if its items match item numbers in Column 3. If there is a match, record the work item number corresponding to the SWLIN from Column 3 in Column 1 next to the matching SWLIN/item number in Column 2. If there is no match for an item in Column 2, record under the “Remarks” column that the SWLIN item is not contained in the SARP. Repeat this process for all items in Column 3.
5. All SWLIN items listed under Column 2 which do not have a work item number associated with them in Column 1 are SARP requirements which may not be covered in the work items. Some of these requirements may be covered by requirements identified in the remarks under step 1. Review the remarks to identify those work item requirements covered in a work item but which are not part of the SWLIN items listed for the work item. If there is a match, note the correct work item number next to the SWLIN item. Review the work item requirements again to verify that they correctly address the scope of work from the SARP and note the remarks as needed. For these requirements, note under the “Remarks” column that the work item PCN needs to be changed to include the additional SWLIN/item.
6. When the last review is complete, items in Column 2 which do not have related work item numbers in Column 1 should be noted in Column 4 as SARP requirements not covered in the specification work package.

USS _____ SPECIFICATION REVIEW SUMMARY SHEET

REVIEWER: _____ CODE: _____ DATE: _____

1	2	3	4
WORK ITEM NUMBER	SWLIN AND ITEMS	ADDITIONAL SWLINS/ITEMS	REMARKS

APPENDIX C
SUMMARY COST ESTIMATES

U.S.S. _____

<u>Cognizant Funding Authority</u>	RMC/ Naval Shipyard <u>Services</u>	<u>GFM</u>	<u>Contract</u>	<u>Total</u>
FLTCOM (TYCOM)				
NAVSEA (SHIPALTS)				
NAVSEA (ORDALTS)				
Other				
Contingency				
<u>TOTAL</u>				

(This Page Intentionally Left Blank)

APPENDIX D
WORK SPECIFICATION TRANSMITTAL

Spec. No. ---/---/---

DATE _____ 1 _____

SHIP _____ 2 _____

TYCOM _____

TYPE OF AVAILABILITY	_____	FROM	_____	TO	_____
APPROVAL GRANTED BY	_____ 3 _____	ON	_____ 4 _____	BY	_____ 5 _____
	_____ 3 _____	ON	_____ 4 _____	BY	_____ 5 _____
	_____ 3 _____	ON	_____ 4 _____	BY	_____ 5 _____

SPECIFICATION NOS. _____ 6 _____

PLANNING ESTIMATES ESTABLISHED BY APPROVING AUTHORITY

REPAIRS \$ _____ BY _____ 7 _____

ALTS \$ _____ BY _____ 7 _____

OTHER \$ _____ BY _____ 7 _____

RMC ESTIMATES

	<u>HOURS</u>	<u>RATE</u>	<u>DOLLARS</u>
MANUFACTURING	_____	_____ 8 _____	_____
ENGINEERING	_____	_____ 8 _____	_____
MATERIAL			_____ 9 _____

THE ESTIMATED DIVISION OF THE ESTIMATE BY FUNDING AUTHORITIES IS

_____ 10 _____

_____ GEOGRAPHIC LIMITATION ESTABLISHED FOR _____ 11 _____ BY

_____ 12 _____ SPLIT BIDDING IS NOT RECOMMENDED FOR THE FOLLOWING

REASON(S) _____ 13 _____

_____ THE WORK ITEMS AND WORK PERIOD FOR EACH SPLIT BID LOT ARE

DRY-DOCKING

_____ 14 _____

TOPSIDE

_____ 14 _____

IT IS CONSIDERED THAT THE WORK WILL _____ 15 _____ REQUIRE OVERTIME. THE RMC ESTIMATE INCLUDES _____ HOURS AT \$ _____ FOR THE OVERTIME.

THE WORK REQUIRED BY THE SPECIFICATIONS REQUIRES SPECIAL CAPABILITIES AS FOLLOWS

_____ 16 _____

_____ 16 _____

_____ 16 _____

THE WORK 17 DOES 17 DOES NOT REQUIRE ACCESS TO CLASSIFIED MATTER OR SPACES.

PREPARED BY _____ 18 _____ DATE: _____.

APPROVED _____ 19 _____ DATE: _____.

INSTRUCTIONS FOR PREPARING WORK SPECIFICATION TRANSMITTAL

(NOTE: No numbers are shown in blank spaces that are self-explanatory.)

- 1 Indicate date of the transmittal.
- 2 Indicate ship name and hull number.
- 3 Indicate authority approving repairs and alterations as appropriate.
- 4 Indicate date the approval received by RMC.
- 5 Indicate serial and date or date/time group of the authorizing correspondence.
- 6 Specify the work item numbers of the specification enclosed with the transmittal.
- 7 Indicate serial and date or date/time group of the correspondence establishing the planning estimates if other than 5 above.
- 8 Indicate composite rates provided by Contracts Department.
- 9 Value of material at commercial rates. Do not use Navy stock material prices.
- 10 Provide percentage breakdown of the estimate by grantor of funds.
- 11 Indicate the limitations established. If none, so state.
- 12 Indicate activity establishing limitation and serial number and date or date/time group of correspondence.
- 13 To be filled in only if split bidding is not recommended.
- 14 List the work items for each lot and the work period to be specified in the solicitation.
- 15 If no overtime is required, insert "not", otherwise leave blank and complete remainder of statement.
- 16 Indicate that work requiring special capabilities in the shipyards such as size of dry dock, special ordnance or electronic skills.
- 17 Indicate if access is required. If required, attach a completed DD Form 254.
- 18 Signature of preparer.
- 19 Signature of individual designated by RMC to transmit specifications to the Contracts Department.

(This Page Intentionally Left Blank)

APPENDIX E
PROCEDURES FOR THE PREPARATION AND USE OF
WORK ITEM SPECIFICATIONS FOR SHIP REPAIR

This appendix is provided and maintained by the Standard Specification for Ship Repair and Alteration Committee (SSRAC) in accordance with NAVSEAINST 9070.1 series. Due to its size and need for annual updating, it is not practical to enclose the contents of Appendix 4E in this manual. In this regard, revisions/updates will be issued as an enclosure to the report of annual SSRAC meetings. When the results of the annual meetings are finalized, the website will be updated. It typically takes about 90 days to process the changes and post the update.

Appendix 4E can be located on the SSRAC website, <http://www.navsea.navy.mil/CNRMC/SERMC/SSRAC1/default.aspx>, or copies can be obtained by e-mail request to <http://www.navsea.navy.mil/Home/RMC/CNRMC/OurPrograms/SSRAC.aspx> or by phone to 757-443-2650 ext 4196.

(This Page Intentionally Left Blank)

APPENDIX F
WORK PACKAGE INTEGRATION CONFERENCE AGENDA
AND CHECKLIST

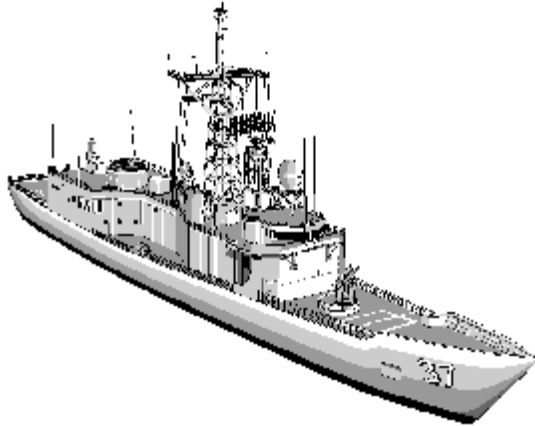

USS

_____ *HULL NO.* _____

TYPE OF AVAILABILITY _____

Strategic Systems Project (SSP NO.) _____

DATE: _____

**WORK PACKAGE INTEGRATION CONFERENCE (WPIC)
AGENDA CHECKLIST**

USS: _____ HULL NO: _____ SSP: _____

TYPE OF AVAILABILITY: _____ DATE: _____

CONFERENCE AGENDA

A. REVIEW HABITABILITY ISSUES

1. DISCUSS HABITABILITY IMPACT
2. DISCUSS OFF-SHIP MESSING/OFF-SHIP BERTHING REQUIREMENTS
3. DISCUSS AVAILABILITY OF BERTHING BARGE
4. DISCUSS HABITABILITY "WORK AROUNDS" IF NO BERTHING BARGE WILL BE PROVIDED
5. FOR BOQ/BEQ, VERIFY QUANTITY OF SHIP'S FORCE PERSONNEL

B. REVIEW CRITICAL PATH / CONTROLLING ITEMS

C. IDENTIFY REQUIREMENTS THAT THE SHIP MUST MEET PRIOR TO AVAILABILITY START

1. DISCUSS AMMUNITION OFF-LOAD
2. DISCUSS FUEL OFF-LOAD/ON-LOAD
3. DISCUSS DEWATERING (COMPENSATED FUEL SYSTEMS)
4. DISCUSS REEFER / STORES OFF-LOAD

D. DISCUSS NEW WORK, DELETIONS OR MAJOR REWRITES

1. OBTAIN 2-KILOS FOR NEW WORK
2. DOCUMENT SPECIFICATION DELETIONS
3. IDENTIFY MAJOR SPECIFICATION REWRITES

E. REVIEW ALTERATION INSTALLATION TEAM (AIT) REQUIREMENTS

1. REVIEW QUARTERLY AIT SCHEDULE
2. IDENTIFY AIT INSTALLATIONS SCHEDULED DURING AVAILABILITY
3. OBTAIN 2-KILOS FOR ANY OUTSTANDING AIT SERVICES AND SUPPORT REQUIREMENTS

F. REVIEW AIT INTERFACE PROBLEMS

G. REVIEW POTENTIAL IMA AND SHIP'S FORCE INTERFACE PROBLEMS

1. PORT ENGINEER RESOLVE POTENTIAL CONFLICTS

H. REVIEW EARLY START AVAILABILITY REQUIREMENTS

1. TYCOM ISSUE AVAILABILITY MESSAGE (IF REQUIRED)

I. IDENTIFY ANY WORK ITEMS IN JEOPARDY

1. GFM NOT AVAILABLE
2. CUSTOMER FUNDING NOT AVAILABLE
3. DRAWINGS / REFERENCES NOT AVAILABLE
4. SCOPE OF WORK NOT DEFINED
5. INSUFFICIENT AVAILABILITY DURATION

J. DEFINE WORK THAT MUST BE STARTED BY A CERTAIN DATE (OTHER THAN OPTION ITEMS)

1. IDENTIFY WORK START DATES

K. DEFINE WORK THAT MUST BE ACCOMPLISHED BY PRODUCTION COMPLETION DATE (PCD)

1. REVIEW AND SIGN LOA/PCD MILESTONE SHEET

L. REVIEW TESTING REQUIREMENTS

1. COMBAT SYSTEMS TESTS
2. HM&E TESTS
3. SPECIAL TEST/CERTIFICATION REQUIREMENTS

M. REVIEW OPTION ITEMS AND INVOKE NLT DATES

N. REVIEW LIST OF PRORATED WORK ITEMS

O. REVIEW AVAILABILITY DURATION REQUIREMENTS

1. REVIEW CONTRACT AND CNO DATES
2. DETERMINE IF THERE IS SUFFICIENT TIME TO ACCOMPLISH SHIPALTS, MAJOR REPAIRS AND LOA REQUIREMENTS

P. REVIEW REMAINING ADVANCE PLANNING AND CONTRACTING MILESTONES

1. PLANNING ACTIVITY PROVIDE COPY OF AVAILABILITY STATUS REPORT (ASR)

Q. REVIEW STATUS OF ANY OUTSTANDING CUSTOMER FUNDING REQUIREMENTS

R. REVIEW UNRESOLVED BID SPEC REVIEW (BSR) REQUIREMENTS

S. ASSIGN ACTION ITEMS AND COMPLETION DATES

T. PROVIDE ALL WPIC ATTENDEES A COPY OF THE CONFERENCE ATTENDANCE LIST

U. TYPE DESK ISSUE WPIC COMPLETION MESSAGE

WORK PACKAGE INTEGRATION CONFERENCE (WPIC)

USS: _____ AVAILABILITY: _____ SSP: _____ DATE: _____

A. HABITABILITY ISSUES

Item Number/SWLIN	System/Equipment	Habitability Impact		Remarks
		Major	Minor	

Off-Ship Messing Req'd?		Off-Ship Berthing Req'd?		Barge Assigned?		Work Around If Barge Not Available
Yes	No	Yes	No	Yes	No	

Quantities Of Ship's Force Personnel (For BOQ/BEQ)	CO/XO	Officers	CPOs (E7 - E9)	Enlisted (E5 - E6)	Enlisted (E1 - E4)
Male					
Female					

B. CRITICAL PATH/CONTROLLING ITEMS

CRITICAL PATH			CONTROLLING ITEMS		
Item Number	Title	Mandays	Item Number	Title	Mandays

C. REQUIREMENTS THAT SHIP MUST MEET PRIOR TO AVAILABILITY START

Event	Applicable?		Remarks
	Yes	No	
Ammunition Off-Load			
Fuel Off-Load/On-Load			
Dewatering (Compensated Fuel Systems)			
Reefer/Stores Off-Load			

D. NEW WORK, DELETIONS OR MAJOR REWRITES

New Work

JCN Number	Nature of Work/Title	Remarks

Deletions

JCN Number	Work Item Number	Remarks

Major Rewrites

Work Item Number	Remarks

E. AIT INSTALLATIONS SCHEDULED TO BE ACCOMPLISHED DURING AVAILABILITY

AIT Sponsor	Work To Be Accomplished By	AIT Point of Contact/Phone Number	Support Services Req'd		Installation Dates
			Yes	No	

F. AIT INTERFACE PROBLEMS		
AIT Installation	Installation Accomplished By	Interface Problems

G. POTENTIAL IMA AND SHIP'S FORCE INTERFACE PROBLEMS		
JSN/SWLIN	Nature Of Work	Remarks

H. EARLY START AVAILABILITY REQUIREMENTS			
JSN	Work Item	Proposed Availability Dates	Remarks

I. WORK ITEMS IN JEOPARDY						
JSN	Item Number	Material	Reason for Jeopardy Status			Remarks
			Funding	Drawings	Insufficient Time	

J. WORK THAT MUST BE STARTED BY A CERTAIN DATE (OTHER THAN OPTION ITEMS)

Work Item	Title	Start Not Later Than

K. WORK THAT MUST BE COMPLETED BY PRODUCTION COMPLETION DATE (PCD) Review and sign Key Event Worksheet - Attachment (1)

Work Item	Title	Location	Description of Work To Be Accomplished

L. TESTING AND CERTIFICATION REQUIREMENTS

Work Item	Title	Type of Test/Certification Required	Activity Responsible for Testing/Certification	Complete NLT

M. OPTION ITEMS AND INVOKE NOT LATER THAN DATES

	Work Item Number	Title	Invoke Date (NLT)	
			A - Date	Calendar Date
Option (1)				
Option (2)				
Option (3)				
Option (4)				
Option (5)				
Option (6)				
Option (7)				
Option (8)				
Option (9)				
Option (10)				
Option (11)				
Option (12)				
Option (13)				
Option (14)				

N. LIST OF PRORATED WORK ITEMS

Work Item	Title	CNSL %	NAVSEA %	SHIPALT To Prorate Against	
				S/A Number	Title

O. AVAILABILITY DURATION REQUIREMENTS

Review the length of the Availability to determine if there is sufficient time to accomplish all SHIPALTs, major repairs and to support Light Off Assessment

P. REMAINING ADVANCE PLANNING AND CONTRACTING MILESTONES

Planning Activity provide AVAILABILITY STATUS REPORT (ASR)

Q. STATUS OF OUTSTANDING CUSTOMER FUNDING REQUIREMENTS

Amount of Funding Required	Customer Responsible for Funding	Funds Required NLT	Remarks

R. UNRESOLVED BID SPEC REVIEW (BSR) REQUIREMENTS

Work Item	Unresolved BSR Requirement/Issue	Action Required	
		NLT	Responsible Activity

S. ASSIGNED ACTION ITEMS AND COMPLETION DATES

Work Item	Responsible Activity	Action Required	Complete NLT

T. WPIC LIST OF ATTENDEES (Provide all attendees a copy) - Attachment (2)

U. TYPE DESK ISSUE WPIC COMPLETION MESSAGE (including outstanding issues/concerns and action items)

WORK PACKAGE INTEGRATION CONFERENCE

KEY EVENT WORKSHEET

USS _____ HULL NO. _____ SSP _____

KEY EVENT/MILESTONE	A + DATE	SCHEDULE DATE
START AVAILABILITY		
COMPLETE INITIAL GAS-FREEING		
DOCKING	NLT 25%	
UNDOCKING	Contractor Provide	
COMPLETE BILGE PRESERVATION (Complete Before PCD)		
CREW MOVE ABOARD		
FUEL SHIP		
PRODUCTION COMPLETION DATE (Machinery Space Turnover)		
START (LOA) TRAINING		
START LIGHT-OFF ASSESSMENT (LOA)		
PROPULSION PLANT LIGHT-OFF		
START DOCK TRIAL		
START FAST CRUISE		
START SEA TRIAL		
AEGIS LIGHT-OFF		
COMBAT SYSTEM LIGHT-OFF		
COMPLETE PIER-SIDE COMBAT SYSTEM TESTING		
COMPLETE AVAILABILITY (CONTRACTOR)		
COMPLETE AVAILABILITY (CNO)		

PORT ENGINEER: _____ **DATE** _____

SHIP REPRESENTATIVE: _____ **DATE** _____

PROJECT MANAGER: _____ **DATE** _____

ADV PLNG MANAGER: _____ **DATE** _____

Attachment (1)

WORK PACKAGE INTEGRATION CONFERENCE (WPIC)

USS: _____ AVAIL TYPE: _____ SSP: _____
 WPIC LOCATION: _____ DATE: _____

LIST OF ATTENDEES

NAME	ACTIVITY/CODE	TELEPHONE	E-MAIL ADDRESS
1.			
2.			
3.			
4.			
5.			
6.			
7.			
8.			
9.			
10.			
11.			
12.			
13.			
14.			
15.			
16.			
17.			

VII-4F-11

Attachment (2)

COMUSFLTFORCOMINST 4790.3 REV C

(This Page Intentionally Left Blank)

VOLUME VII
CHAPTER 5
COST ESTIMATING

REFERENCES.

- (a) DCAAM 7640.1, July 2004 Edition - DCAA Contract Audit Manual (CAM), Chapter 9-1004.2
- (b) SWT 857-01 - Temporary Galley and Messing Facilities; provide
- (c) SWT 857-011 - Temporary Off Ship Berthing Equivalent to BOQ/BEQ; provide
- (d) Standard Work Template (SWT) 077-01 - Hazardous Waste Produced on Naval Vessels; control
- (e) NAVSEA SL720-AA-MAN-030 - Navy Modernization Process Management and Operations Manual

LISTING OF APPENDICES.

- A Standard Cost Estimate
- B Estimating Check-Off List
- C Category I Standard Item Hard-Core Labor Considerations
- D Excaliber Contractor Other Direct Labor Factor Calculation (6 Month Period)

5.1 INTRODUCTION. The Federal Acquisition Regulation establishes the requirements for proposal evaluations. An independent Government cost estimate is one method that can be used in the evaluation of bids and proposals. Cost estimates form the basis for management decisions by Fleet and Naval Sea Systems Command (NAVSEA) customers in the planning, programming and budgeting of repair and modernization work, including repair work brokering decisions, and in determining the developmental costs for ship alterations. Contracting activities require cost estimates for new procurements prior to issue of a solicitation, for modifications to a contract after award, for resolution of entitled claims and to close out contracts that have been terminated.

5.2 TYPES OF ESTIMATES. There are five types of estimates that Regional Maintenance Centers (RMC) commonly produce in conjunction with ship repair and modernization contracts. These include Pre-Contract Award, Post-Contract Award, Preliminary Costs, Contract Costs, Predicted End Costs and Costs for Contract Modifications.

5.2.1 Pre- and Post-Contract Award Estimating. Pre-award estimating can be associated with either competitive or noncompetitive procurements. Estimating non-competitive procurements is less complex because the identity of the contractor is known prior to award. Estimating for competitive awards can be more complex because of the uncertainty associated with the identity of the contractor. Estimates prepared for either competitive or noncompetitive procurements will be made using the Standard Government Estimating System. In both cases, the approach to preparing the labor hours and material estimate is the same.

5.2.2 Preliminary Cost Estimate. The preliminary cost estimate is the estimate prepared in terms of labor and material quantities required, without reference to labor rates or the cost of materials. This is the estimator's fully refined estimate, normally expressed in terms of man-hours and material required to accomplish the specific work identified in the work item. Contingencies for growth and other uncertainties are not considered in the estimate. To get the contract cost estimate, labor and material costs must be incorporated into the preliminary estimate. Material rates to be applied to material quantities required should be based on current prices. The rates to be applied to the labor estimate are dependent on the competitive environment. In the case of noncompetitive procurements, the rate used is that applicable to the contractor who will do the work. In the case of competitive procurements, a composite rate must be determined.

5.2.3 Contract Cost Estimate. Prior to award of a contract, the Contracting Officer must be satisfied that the contract price is fair and reasonable. An integral part of this process is comparing and analyzing the contractor's price to an independent estimate prepared by the Government. This estimate is referred to as the Government estimate for the contract or the "Contract Cost Estimate" and is determined by adjusting the composite rate to reflect current market conditions. The Contract Cost Estimate is determined by applying the appropriate composite rate to the preliminary labor estimates and current material prices to required material quantities. The composite rate must be adjusted to reflect current market conditions as discussed above. The sum of the labor and material estimates is the Contract Cost Estimate.

5.2.4 Final Cost Estimate. The original Contract Cost Estimate is retained as a part of the contract file. After contract award, the Contract Cost Estimate is adjusted to reflect the successful contractor's current labor rates. The contracting officer will determine the current Other Direct Labor Factor (ODLF) applicable to the contractor and apply it to the contractor's current forward pricing rate to determine the labor rate to be used in establishing the Final Cost Estimate. This labor rate, in lieu of the competitive composite rate, is applied to the Preliminary Cost Estimate to calculate the Final Cost Estimate. The difference between the Final Cost Estimate and the contract award price represents the potential profit or loss of the contractor that should be maintained throughout the performance period, as stated in the Doctrine of Equitable Adjustment. A contractor that "buys-in" to a contract should not be allowed to recover the loss through excessive prices in contract modifications after award. Likewise, the Government must not attempt to reduce the contractor's potential profit by allowing insufficient consideration for changes after award.

5.2.5 Predicted-End-Cost. The Predicted-End-Cost (PEC) is the RMC's estimated cost of all ship work, which consists of several factors. PEC equals the Award Price/Base Cost plus the estimated cost of other items that are not covered by the Award Price/Base Cost. Other items can include such elements as fees, growth, new work, Government Furnished Material (GFM), messing and berthing and boat repairs, if these were not included in the Award Price/Base Cost. Advance planning funds or funds that are provided to other activities should not be included in the estimate. The PEC does not establish financial obligations on customers, but rather is the RMC's estimate of what the availability is most likely to cost. The RMC may be required to adjust the PEC when it is obvious that circumstances (i.e., buy-ins, potential for major growth/new work, etc.) exist that would inhibit the determination of a realistic PEC. These extenuating conditions shall be clearly reported, documented, assigned a dollar value and considered in the computation of a realistic PEC.

5.3 CLASSIFICATION OF COST ESTIMATES. There are five classifications of cost estimates: Class A, C, D, F and X.

5.3.1 Class A - Detailed Cost Estimate. An extensive cost estimate based on detailed engineering drawings, material lists and man-hours by required skills and trades. The level of detail addressed in a Class A estimate should be to the maximum extent feasible. It is comparable to a fixed-price offer developed by a Naval Shipyard (NSY) or a manufacturing estimate prepared in private industry. Variance is not expected to exceed 10 percent.

5.3.2 Class C - Budget Quality Estimate. Class C estimates are considered to be the best-cost estimate attainable for ship repair. It is the recommended level of estimates of cost developed by a field activity to be used in budget submissions. They are normally prepared for ship repair work prior to the start of availability. Variance is not expected to exceed 15 percent. Class C estimates are the expected level of estimation by both the Private Sector Industrial Activity contractor and the Government Planning and Estimating Teams supporting the Independent Government Estimate, Continuous Execution Increment Planning and Review Process, Technical Availability Repair and Definitization processes. As a result, the Private Sector Industrial Activity planning floor, Shipbuilding Specialists and Planning Yard Representatives shall provide Class C estimates.

5.3.3 Class D - Feasibility Estimate. Class D estimates are required prior to completion of the design or preparation of detailed specifications, reflecting the uncertainty associated with having incomplete information available for estimating purposes. It is usually exploratory in nature and is prepared to perform trade-offs and cost effectiveness analysis. Variance is not expected to exceed 20 percent.

5.3.4 Class F - "Ballpark" Estimate. Class F estimates are known as "ballpark" estimates. This is a quick cost estimate prepared in the absence of minimum design and cost information and is based on gross approximations. It is calculated by escalating previous costs to current dollars, using empirical costs for similar work and adding factors for expected changes in design, processes procedures and other economic considerations. Acceptable when higher-level estimates are not possible due to insufficient time or incomplete information. Variance is not expected to exceed 40 percent.

5.3.5 Class X - Directed or Modified Estimate. An estimate provided by other Government activities or as directed by higher levels of authority. It is generally a total cost restriction without a developed design, engineering or a detailed cost estimate. A directed estimate is also a modification of any previous cost estimate, Classes A through F, to conform to budget reductions or restrictions on cost which is not based on a change in the scope of work required.

5.4 STANDARD ESTIMATING.

5.4.1 Average Contractor. In a competitive procurement, the identity of the contractor cannot be determined until after contract award. Therefore, some assumptions must be made about the contractor in order to define the estimating environment. For estimating purposes, the planner assumes that an average contractor under average conditions will perform the work. This assumption, however, also leads to problems since it is difficult to define an “average” contractor; i.e., one that possesses average facilities, equipment, tools, work force, etc. To address this problem, United States Fleet Forces Command has directed that estimates for competitive procurements be prepared on Appendix A. This chapter, together with the “average contractor” and “average condition” assumptions, defines the framework for Standard Estimating for competitively awarded ship repair work. To ensure the validity of estimates, labor rates applied to labor estimates must be consistent. This requirement derives from the basic accounting requirement that estimating systems be consistent with applicable accounting systems.

5.4.2 Elements of Standard Estimating. Appendix A requires that estimates be prepared for only 13 labor elements and quality assurance personnel. These labor elements can be categorized as “hard-core” direct labor elements. These labor category titles, as shown in Table 5-1, are general descriptions of labor categories that would be found in any ship repair facility. The titles in the formal contractor chart of accounts will vary from contractor to contractor. However, the work performed by personnel in those labor categories is always charged as direct labor. For this reason, these labor elements are defined as “hard-core” labor elements in all discussions regarding estimating systems. In Standard Estimating, the hard-core labor elements are the only labor elements estimated by the estimator. All other labor required to perform the work being estimated is considered to be overhead labor or “other direct labor.” Neither overhead nor other direct labor is ever estimated by the estimator. These two elements, “overhead” and “other direct labor,” are accounted for by applying factors for overhead and other direct labor to the total hard-core labor estimate. See section 5.10 of this chapter for an example of the labor rate determination process.

5.4.3 Standard Estimating Example. Contractors are required to estimate work requirements using a method or system consistent with their accounting system. It has been shown through audits of contractors’ accounting systems that the hard-core labor elements identified in Appendix A are always charged as direct labor. It is also true that all contractors have other direct labor elements in the chart of accounts that must be considered in estimating work to be performed. Table 5-1 shows two sample charts of accounts for contractor direct labor. In these two samples, an asterisk notes those direct labor elements that are comparable to the Standard Estimating hard-core labor elements. The determination of which labor categories are hard-core is a matter of judgment. Any contractor labor category judged to be comparable to a labor category listed in Table 5-2 is designated as a hard-core labor element. The remaining labor categories are included in the term “other direct labor.” The factors to be applied to Government estimates are based on actual audit of contractors’ accounting systems. For example, based on past accounting data for all direct labor charges in a contractor’s accounting system, other direct labor requirements are computed as a percentage of the direct labor charges covered by the hard-core direct labor elements. Typically, a Government estimate of 100 man-hours would be comparable to 140 man-hours in the contractor’s estimating system where the other direct labor factor was computed to be 40 percent of the hard-core charges. The key to achieving equity in estimating for a particular estimating system is to determine the appropriate factors to be applied to the Government estimate. The fundamental principle of estimating in Standard Estimating is for the estimator to estimate only those direct labor elements necessary to satisfactorily complete the task requirements, such as those listed on Appendix A.

Conversely, consideration of overhead and other direct labor is accounted for by applying the proper factors for overhead and other direct labor. It would be improper to estimate the cost of supervision, scheduling, material handling, fire watches and the like when those labor elements are properly accounted for in the labor rate applied to the labor estimate.

Table 5-1

SAMPLE CONTRACTOR CHARTS OF ACCOUNTS OF DIRECT LABOR			
Contractor A		Contractor B	
*Machinist	Mechanical Engineering	*Inside Machinist	Estimating
*Shipfitter	Marine Engineering	*Outside Machinist	Purchasing
*Chipper and Burner	Program Planning	*Pipe Covering	Contract Administration
*Crane Service	Program Management	*Pipefitting	Planning
*Welder	Financial Analysis	*Sheetmetal	Temporary Services
*Carpenter	Graphic Services	*Electrical	Material Support
*Painter	Technical Illustrators	*Carpentry	Laboratory Services
*Installation and Testing	Plant Protection and Safety	*Paint	Industrial Engineer
*Pipefitting and Covering		*Laborer and Sandblaster	Progressing
*Sheetmetal Worker		*Welding	Clerical Support
*Quality Assurance		*Cleaning Services	Program Management
Material Handler		*Staging	Accident Prevention
Procurement Personnel		*Shipfitting	Production Support
Change Control		*Mold Loft	Material Receipt
Cost Estimator		*Nondestructive Testing (NDT)	Scheduling
Secretary and File Clerk		*Inspection	Production Control
Naval Architecture		Technical Support	Material
Electrical Engineering		Drafting	

*Hard-core labor elements

Table 5-2

STANDARD COST ESTIMATE FORM LABOR CATEGORIES	
Shipfitter	Pipefitter
Sheet metal	Insulation/Lagger
Welder/Burner	Carpenter/Shipwright
Inside Machinist	Electronics/Ordnance
Outside Machinist	Painter/Sandblaster
Boilermaker	Rigger/Laborer
Electrician	Quality Assurance and NDT

5.5 ESTIMATING ENVIRONMENT.

5.5.1 Environment Defined. An estimating environment is defined as the estimating system and that collection of facilities, tools, equipment, materials, labor, skills, procedures, environment and other factors that may impact on the cost of performance of the activities estimated. Knowledge of the estimating environment as a frame of reference for the estimator is one of the fundamental prerequisites for estimating. In a NSY, this requirement is met as a natural consequence of the way business is conducted, while in the RMCs the estimator may be estimating for work that will be awarded competitively to a contractor whose identity is not known. Where contracts are sole-sourced, the estimator does have the opportunity to adjust the estimating to match the contractor's estimating environment.

5.5.2 Cost Accounting Standards. Most contractors will prepare cost estimates using an estimating system consistent with the contractor's accounting system. For large commercial contractors subject to the Cost Accounting Standards (CAS), the contractor is required under reference (a) to use an estimating system consistent with the methods used for recording or accounting for costs and to submit a formal CAS Board Disclosure Statement showing the chart of accounts used for all direct and indirect costs and the methods used to account for those costs.

- a. Small contractors and those not subject to CAS are required to use an accounting system which meets generally acceptable accounting standards. The Defense Contract Audit Agency (DCAA) periodically audits contractor's records to determine that the actual practices of estimating costs are consistent with the accounting system.
- b. Contractor estimates are generally consistent with the contractor's accounting system. In the case of businesses where the company owns two or more contractors, the estimating systems used in all contractors are similar since all use the same accounting system. The charts of accounts used to identify direct and indirect cost centers and accounting practices are essentially the same at all of the company's contractors. However, estimates from one of the contractors may not be valid in any of the other company contractors, since estimating is a function of more than the accounting system. For example, estimating is also a function of facilities, tools and equipment available to the work force for performance. If one contractor uses a state-of-the-art end-prep machine to machine piping joints for welding and another uses a hand grinding tool, the estimates of labor hours required may vary by as much as 400 percent for the exact same scope of work. Likewise, the use of precise numerically controlled machine tools is more efficient than the use of manually operated machine tools. Generally speaking, the use of new, modern facilities improves performance when compared to performance in older, obsolete facilities. In a contractor's accounting system, however, the cost of new, modern facilities and state-of-the-art machinery and tooling will increase the indirect cost factors used to determine the billing rate applied to direct labor hours. No two contractors have the same collection of facilities, tools or equipment available for performance and, therefore, there may be differences in estimates among contractors owned by the same company.

5.5.3 Other Factors Affecting the Contractors' Estimating Environment. Contractor estimating is a function of the labor skills available, the experience of the work force and the workload. Highly skilled employees can perform more efficiently than unskilled employees, but at a higher wage rate. A contractor work force experienced in overhaul of a particular ship class benefits from the learning experience and can perform more efficiently on subsequent ships of the same class. Other considerations, such as the ship repair market and level of work backlog, also play an extremely important role in estimating for competitive procurements. For example, market conditions may dictate a contractor estimate that can be significantly at variance with the estimate of actual costs. If the market is saturated, that is all contractors are at capacity or are operating with a significant backlog of work, the contractor does not need additional work. The addition of more work under these conditions may be very disruptive to ongoing work and the disruptive effects would have to be considered in estimating the costs of more work. Under these conditions, contractors may also seek higher profits to compensate for the added disruption. Therefore, any precise estimate of total costs based on work scope and labor rates would be overridden by an increase to account for the market being at, or in excess of, capacity. Conversely, when there is not enough work to keep all contractors busy, the marketplace becomes more competitive. Under this condition, contractor management will normally undercut well-conceived estimates in order to remain competitive. A basic principle of estimating is that an estimate prepared for any one contractor will not be valid for any other contractor. The estimator must know the estimating environment that is used and estimates must be prepared to reflect the total environment of where the work is to be performed.

5.5.4 Regional Maintenance Center Estimating Instructions. For each contractor actively performing a Master Agreement Job Order, the Administrative Contracting Officer (ACO) will identify to RMC estimators the set of direct labor categories to be estimated. No other estimates for labor will be provided. Indirect labor costs (overhead) and all other direct labor required for performance will be accounted for in the labor rate to be applied. The ACO/Procuring Contracting Officer (PCO) will determine through understandings with contractors, and as audited by DCAA, the appropriate rates and factors to be applied to ensure that Government estimates and rates are consistent with the contractor's accounting and estimating system. To the maximum extent possible, RMC estimates will be prepared using Appendix A. Where changes in the labor categories to be estimated are required, the ACO will provide written direction as to the changes to be made. Once the changes are made, all estimates for changes with that contractor will be made using the modified Appendix A. No other direct labor will be estimated. In all cases, independent Government estimates for changes will be prepared by consistently estimating direct labor only for the direct labor categories identified by the ACO/PCO. All other labor required for performance will be accounted for as a subcontracted effort or in the labor rate overhead applied to the direct labor cost estimate. Individual estimators are not authorized to change the labor categories on the Cost Estimate Sheet except as directed by the ACO/PCO.

- a. For those contractors who do not establish an understanding with the ACO about the contractor's estimating system, the ACO will establish appropriate rates and factors for use in Standard Estimating. If time and resources are available, this can be achieved by RMC examinations of the contractor's chart of accounts to identify hard-core and other direct labor categories, and then requesting audit by DCAA to establish the other direct labor factor as addressed earlier and in reference (a).
- b. If audit resources are not readily available, the ACO will establish in advance, from the contractor's chart of accounts, a listing of all hard-core and other direct labor categories as defined earlier. The ACO may request the contractor to prepare accounting records detailing the actual man hour expenditures in specific direct and other direct labor categories to support DCAA audits. Accounting records may be requested for periods not less than the preceding six months nor greater than the preceding three years. From this data, DCAA will compute and recommend to the ACO an appropriate ODLF. Labor rates used for pricing changes must be consistent with the factors determined.
- c. The contractor's estimating system must provide for reaching work scope understandings with the RMC when required. The parties must have a common understanding of the work requirements in order that the contractor's estimates and subsequent analysis by RMC will be made on the same basis. That portion of the estimating system dealing with the definition of work scope should cover the disposition of material made obsolete or excess as the result of the change.
- d. The understanding to be reached with the contractor must include provisions for the contractor to submit proposed revisions to procedures and practices which involve an understanding previously reached, in order that they may be evaluated and a new understanding reached. Periodic reviews will be made by the ACO and the audit office to see that the contractor's written procedures and practices are current.
- e. Any deviation from the estimating system must be clearly supported. Any estimate based on standards is designed to give reasonable figures on the average. To argue in any given case that a standard results in too many or too few man hours will probably open up arguments on other standards or other cases. There is one important exception to the need for consistency; if actual costs, hours, overhead, etc. are known, they must be used.
- f. The contractor's estimating system should provide for periodic adjustments in the labor and overhead rates to be applied in establishing estimated costs. The system should also provide a means for the contractor and the ACO to reach an understanding on the rates to be applied for work performed or to be performed during specified periods. Such rate understandings and the consistent use of the rates by the contractor in preparing change proposals will expedite proposal evaluations and negotiations.
- g. In establishing rates, factors and percentages to be used in estimating systems, it is essential to remember that the mix of overhead and direct labor skills will change with different kinds of work. Contractors that perform a variety of work for the Navy may require that multiple rates, factors and

percentages be prepared for each type of work performed by the contractor. For example, a contractor that builds and repairs ships would require different rates, factors and percentages for construction, repair and for each type of ship (e.g., submarines, aircraft carriers or surface force ships).

- h. In achieving understandings with contractors, the ACO must consider that many contractors will not have established estimating systems, nor can small businesses be required to establish formal estimating systems. Therefore, the ACO will be required to provide guidance and suggestions to the contractor to establish a mutually agreeable and beneficial system for both parties.
- i. Estimates developed on the basis of judgment without any analytical support must be reconciled with historical costs. Therefore, contractors should be encouraged to develop procedures for comparing estimates to the cost of performance as a basis for assessing the accuracy and reliability of their estimating practices.
- j. For pricing actions exceeding \$700,000, the Federal Acquisition Regulation requires that the contractor certify that his or her proposal is current, accurate and complete. If a contractor's estimating system, procedures and practices are inadequate, the proposal will be considered unacceptable. The ACO will require the contractor to correct the unsatisfactory elements or performance prior to completing the work package negotiations. For pricing actions less than \$700,000, the ACO should require that the contractor correct the unsatisfactory performance and revise the estimating system in order to resolve the problems prior to completing work package negotiations.
- k. The RMC estimator is responsible for the preparation of the following cost estimates, either concurrently with or subsequent to the preparation of the work item;
 - (1) Direct labor hours.
 - (2) Direct labor overtime hours.
 - (3) Direct material cost, including subcontracts which the prime contractor will have to procure. Subcontractor costs will not be estimated for competitive procurements except where a directed subcontractor is specified in the work item.

5.6 COST ESTIMATING METHODS, STANDARDIZATION AND STANDARDS.

5.6.1 Variables. A number of estimating methods and techniques have evolved which are applicable only under particular conditions. Cost estimates must take into consideration the current estimating environment, market conditions, weather, and any other factors that influence the labor hours and material costs associated with a cost estimate. In preparing detailed cost estimates for work activities, the estimator shall always use the best information available. Where standards are available and applicable, they shall be used. Where the estimator lacks experience or knowledge of the work being estimated, it is essential that other sources of information be examined. These sources include the following:

- a. Master Specification Catalog.
- b. Other estimators who have longer service or experience.
- c. Engineered labor standards prepared by naval or private contractors.
- d. Material catalogs from industry vendors.
- e. Contract files for similar work packages.
- f. Personal records made from past jobs or negotiations.
- g. Other Government agencies that have performed similar work.
- h. Personal observations made during job execution.
- i. "Rules of Thumb".
- j. Historical data.

5.6.2 Standardization of Cost Estimates. Original work items customized by a planner frequently result in contract changes. For this reason, planners should utilize the proven Standard Work Templates (SWT) found in the Navy Maintenance Database (NMD)/Master Specification Catalog whenever possible. Standardization of work items is coordinated by the Standard Specification for Ship Repair and Alteration Committee described in reference (b). The planner shall use an applicable Class Standard Work Template if possible to prepare a work item addressing an authorized Ship Work List Item Number (SWLIN). If an applicable Class Standard Work Template is unavailable, an applicable SWT should be tailored to the SWLIN item requirements. If an SWT is unavailable, a Local Work Template (LWT) should be tailored to the SWLIN requirements. As a last resort, the planner should develop an original work item, using current standard phraseology and applicable Category II NAVSEA Standard Items (SI). Estimates should be standardized to the maximum extent possible. When estimating work items to be used in a competitive environment, previous estimates used for the same item should be modified only after a careful justification and then only to reflect changes in scope or changes in the estimating system. When a previously used work item is tailored to meet a new SWLIN item requirement, the previously used estimated should also be tailored to meet the new requirements.

5.6.2.1 Estimating Standards. Estimating standards are established by relating labor and material costs to specific characteristics of products or services delivered. The use of estimating standards is designed to save time in estimating and is particularly effective in estimating the costs of recurring work. Estimating standards are used to estimate the cost of a single material item required for the work in question or the cost of a single labor operation, (e.g., welding rods per ton of steel, labor hours per linear foot of weld, gallons of paint per square feet or surface area, etc.). More complex estimating standards may also be used to estimate the costs of groups of materials or components or broader classes of labor operations. Estimating standards used must be consistent with the estimating system used to develop estimates. Standards derived from industry-wide statistics are generally applicable industry-wide. Standards that include contractor-specific procedures are applicable only in that contractor's estimating system. The use of such standards is limited to the environment where the standard was developed. When estimating for changes where the contractor is known, any approved engineering standards applicable at the contractor's plant should be used by both the contractor and the Government in developing estimates for the work. Large numbers of Engineered Standards and other standards have been developed by both naval and private contractors. Many of these standards contain basic charts and tables that depict labor and material allowances for various work elements. These allowances are then modified by unique factors to reflect skill levels of workers, facilities and tools available, etc. Some of these standards can be adapted for use in any contractor's facility, provided appropriate factors are used to modify the standard allowances.

5.6.2.2 Naval Shipyard Labor Standards. Standards applicable to all NSYs are categorized as Uniform Engineered Methods and Standards, while yard-specific standards are categorized as Engineered Methods and Standards. Estimating standards must be changed whenever any prime element affecting the standard changes. Engineered Standards are developed using industrial engineering techniques to estimate a repetitive item of work in a stable environment. Development of such standards involves such things as time and motion studies, application of fatigue and lost time factors, etc. The prerequisites for an engineered standard are:

- a. Specific method.
- b. Actual time for accomplishing the task or operation must be observed and recorded.
- c. Performance of the individual(s) is leveled by a performance rating technique applicable to the contractor.
- d. Allowances for personal needs and any special circumstances must be identified.

5.6.3 Detailed Estimating Techniques. Inherent in the concept of detailed estimating is a requirement that the estimator know how the work being estimated is to be accomplished. The "how" of work accomplishment is always unique at any contractor and it may also vary with time, workload and other considerations. The method of accomplishing the work must be consistent with the applicable estimating system. Detailed estimating requires that an estimate for hard-core labor and material for each activity of work required be developed and summed to obtain the total hard-core item estimate. This type of estimate can be referred to as a detailed estimate because the work required is broken down into as many detailed activities as needed to facilitate the estimating. A detailed estimate is built from the bottom up, starting with the lowest element of work required and building on it until the total job is estimated. The greater the level of detail, the greater the refinement is possible.

5.6.4 Use of Historical Data. When historical data has established a standard allowance in labor and material for a work item, that standard shall normally be used when estimating that item of work. The estimated cost will change, because labor rates and the price of materials change with time. The labor-hours and material quantities should remain constant, except for changes in work scope or the estimating system. The use of such historical standards should be validated with each use to ensure that new technology and work practices have been properly considered and that they are representative of the actual cost elements being estimated. When collecting and analyzing cost data, care should be used to distinguish between estimated costs and return or actual reported costs. When using return costs in historical files, an effort should be made to make adjustments to eliminate the excess costs that can be attributed to inefficiencies or other factors that are unique to the availability and the way the work package was executed. Use of return cost data in historical files without appropriate adjustment causes inefficiencies in performance to be extrapolated needlessly into future cost estimates. For this reason, historical files based on estimated costs are generally preferred over files based on return cost. Historical files can incorporate both estimated and return cost, but any return cost used should be properly adjusted.

5.6.5 Parametric Cost Estimating/"Rules of Thumb"/Cost Estimating Relationships.

- a. Parametric cost estimating is broadly defined as a technique employing one or more Cost Estimating Relationships (CER) for the estimating of costs associated with work to be performed or products to be delivered. In this sense, CERs represent the relationships between the cost of materials, labor or services and the products delivered or work performed. Simple CERs can be derived arithmetically from historical data. For example, examine the cost of quality assurance in performing machine shop work. If historical records show that the costs of quality assurance over the last six months of operations amount to 10 percent of the total effort expended in the direct labor pool, then it would be safe to use a CER which projects the cost of quality assurance as 10 percent of the total effort required in operations over the next six months, unless some prime condition changes which may impact the overall cost of performance. It is difficult to use sophisticated CERs in ship repair estimating because of the nonrecurring nature of most ship repair work. CERs are more useful in estimating manufacturing and construction costs as opposed to repair, overhaul or modernization costs. This does not mean, however, that simple CERs cannot be effectively used. They are used frequently, but they are generally referred to as "Rules of Thumb." Experienced estimators who have observed and recorded the results of prior estimates and adjusted them for changing conditions have developed many "Rules of Thumb" over the years. "Rules of Thumb" allow for estimates to be made on the basis of such concepts as cost per pound or hours per foot or unit. As with all CERs, "Rules of Thumb" are subject to change and, therefore, should be used in an informed manner. When changes occur in technology, procedures or other areas of cost affecting a CER, it should be modified to reflect the impact in cost expected.
- b. The first step in developing a CER is to determine its need and usefulness. Applications for CERs can be readily identified through logical reasoning and hypothesizing about the factors affecting the costs of performance. Once a need has been identified, the next step in developing the CER is to determine what it is that will be estimated and how it will be estimated. If labor hours are the desired items to be estimated, which categories of labor will be included, is there a fixed ratio of one category to another or which labor categories are to be excluded? The next step is to determine which factors will be used to estimate or drive the CER. All significant factors that cause costs to be incurred such as specific material quantities and prices, procedures or processes applicable, environment, etc., must be identified. Of these factors, isolate those that make the most significant cost contribution. The number of factors selected should be the smallest number possible to make the CER understandable and effective in producing the required estimates. Next, obtain historical data on both the cost variable being estimated and all the driving factors selected for use in the CER. The data collected must be consistent with the CER parameters isolated for analysis and must be extensive enough to represent a broad sampling of the costs expected under normal conditions when the CER would apply. Next, the data must be analyzed to determine the relationships that exist and the usefulness of those relationships in determining a CER. Then the relationship that best describes the data used is selected. The CER is quantified for use by providing a description of the CER, the independent variable or variables that are used and the method to predict the cost of the dependent variable.
- c. CERs may be presented in many forms, such as graphs, tables or charts. They may be based on relationships from simple straight-line (one-to-one correspondence) to complex multivariable non-linear relationships. CERs, like most tools used in estimating, must be tempered by good judgment.

The data used to develop CERs must be viewed in light of current conditions. New processes, technology or other factors may make CERs obsolete. It is necessary that estimators have some knowledge of the factors involved in CER development. Blind application of CERs can lead to disastrous results.

5.6.5.1 Return Cost Statistics. It is easy to accept a running average of historical return costs as the best estimate of future costs for the same or similar requirements. This practice does not always give the best estimate possible. This estimating technique may easily incorporate prior inefficiencies that have persisted unchecked. Worse yet, historical files based on return costs run an even greater risk of perpetuating erroneous estimates because of inaccuracies in reporting those costs and a lack of consistency in execution. The actual cost of performance of a job is a function of time as much as it is the hard-core cost elements of labor and material. Collecting actual cost data in a contractor cost accounting system is a requirement for all ship repair contractors and NSYs. The data collected does not always reflect the actual work accomplished. This can happen when workers erroneously charge labor to the wrong job order number or to the wrong contract. In private sector availabilities executed under a Master Ship Repair Agreement, return costs reported on departure reports are usually based on a prorated share of the contract price plus the negotiated costs of applicable contract modifications. The basis for the proration is the Government estimate of each work item. Thus, a return cost based on a substantial buy-in by a contractor would be terribly misleading when applied to a sole source negotiation or at a time when the market is saturated. For these and other reasons, return costs should be used only with great care in developing standard estimates for future work.

5.6.5.2 Estimated Cost Statistics. The best estimate of future costs is the statistical mean of a number of independent estimates for the same requirements. Even in the case of standard estimates derived from independent estimates, the standard shall be reviewed periodically to challenge its validity in all elements of cost estimated.

5.6.5.3 Adjustments to Historical Cost Data. When collecting completion cost data for historical files, acceleration, disruption and delay costs should be subtracted before entering the cost figures into the files. These costs are unique to a specific availability and should not be extrapolated for use in future availabilities.

5.7 PREPARING THE COST ESTIMATE.

5.7.1 Preparation. Estimates for labor required are limited to those direct labor categories contained in Appendix A. The form was designed for use in preparing work item estimates for both competitive and noncompetitive procurements, as well as contract modifications after award. In the case of estimating for a work item, the estimate is broken down by paragraph number in the work items and by Category I Standard Items, where applicable. In estimating for work items, the material requirements are designated as Contractor Furnished Material (CFM) or GFM. The form is designed to show only CFM requirements in the estimate breakdown by paragraph. The GFM requirements are estimated separately.

5.7.2 Developing the Estimate. In the estimating process, the estimator describes in broad terms the sequence of activities required to accomplish the work being estimated. Typical repair sequences are shown in Table 5-3. Next, each of these activities is further broken down to the lowest level of detail necessary to facilitate the estimating process. For example, in Sequence B of Table 5-3, the “inspect” activity may require a detailed inspection of a specific set of internal components. Each of the inspections may require a unique set of activities and measurement criteria. Thus, each component inspection could be estimated as a separate activity.

- a. In quantifying the work required, the estimator should envision what is to be done, as in a mental time and motion construction of the physical activity required to accomplish the work. Inherent in this task is a requirement that the estimator know the details of the work to be performed. If the estimator is unsure of the work activities required, a knowledgeable person should be consulted to determine the applicable requirements. It is essential that the correct processes, technology, tools and sequence of work activities be considered in developing a detailed estimate.
- b. After the mental time and motion analysis is complete, the estimator prepares a detailed listing of all activities that are to be estimated separately. The level of detail should reflect that level needed to support the estimating requirement. Experienced estimators do not normally need to break the work down into as many activities as an inexperienced estimator. In determining the activities to be considered in the estimate, it is helpful to use a check-off list of typical requirements in ship repair. The estimating check-off list shown in Appendix B is provided as an example and can be modified as

necessary to suit particular situations. Using the check-off list will prevent inadvertent omissions of incidental support requirements for the major activities of work required, (e.g., assist trades, rigging, staging, temporary lighting and ventilation).

- c. In developing the estimate activity list, examine each major activity in the repair sequence, shown in Table 5-3, to determine whether or not a further breakdown is needed and to identify the sublevel activities. Each of the new activities identified may also require further breakdown until the level of activities is detailed enough to develop a reasonable estimate.
- d. Once all of the activities to be estimated have been identified, the estimator has to assign labor-hours for each trade and support craft needed to accomplish each activity. The cost of material to support required work is also estimated for each activity. The work item estimate is the sum of all labor-hours and material cost estimates. Work item estimates of labor are normally expressed in terms of man-days rather than man-hours (one man-day being equal to eight man-hours). Labor estimates for contract modification are normally expressed in man-hours vice man-days.

Table 5-3

TYPICAL REPAIR SEQUENCES				
WORK ACTIVITY	SEQUENCES			
	A	B	C	D
1	REMOVE	OPEN	PREP AREA	RIP OUT
2	DISASSEMBLE	INSPECT	MASK	FOUNDATION
3	INSPECT	REPAIR	PAINT	LAND EQUIP
4	REPAIR	CLOSE	CLEAN	HOOK UP
5	TEST	TEST	TOUCH-UP	COLD CHECK
6	REINSTALL		CLOSE OUT	HOT CHECK
7	TEST			TEST

5.7.3 Quantification of the Labor Estimate.

- a. Most work activities are estimated on the basis of the estimator’s judgment and experience. Even in the absence of experience, the estimator can still assign reasonable estimates based on good judgment and knowledge of the work being estimated. By mentally going through each step of the work required, the estimator can assign a labor estimate based on judgment of the time required to accomplish each step of the work process. Such detailed estimating can parallel the industrial engineering methods used to develop estimating standards for repetitive type work. Industrial engineering standards are the result of comprehensive time and motion studies of a work process. The time required to perform each operation is measured repetitively. Through analysis, a standard is developed for each step, allowances are made for distractions and rest periods and a standard allowance is made by summing the standard for each step plus other applicable allowances. In mentally paralleling this process, the estimator is providing the time for each step or motion required. The estimates for each step are summed and additional allowances are added for distractions, rest periods and other possible considerations. The other considerations include such items as the following:
 - (1) Location of Work: Estimates for a work operation should be greater when the operation is performed in a congested area. For example, repairs to a water fountain in a congested machinery space with other work in progress would be more time-consuming than the same repairs to a similar water fountain located on the mess decks, in the absence of other work. Work operations of any kind are more time-consuming when performed in conjunction with other work (mutual interference) or when performed in a cramped or congested area.

Likewise, estimates should be escalated for work performed in a hostile environment such as in tanks or voids, in poorly ventilated spaces, in hot or cold spaces, in contaminated atmospheres, etc.

- (2) Ship's Force Work: When work is being performed on the same equipment or system by both the contractor work force and the Ship's Force, there is normally an added degree of mutual interference to be considered. Even when the two work forces are not in the same space, the mutual interference may lead to inefficiencies that should be considered in estimating the contractor work.
- (3) Prevailing Weather: When the geographic area for an assigned availability is known, the geographic weather pattern should be considered. Likewise, if the time of year is known, the seasonal weather should be considered. For example, it is normally more costly to blast and paint the underwater body of a ship hull in below freezing weather than in milder weather. Similarly, the weather may also impact paint curing times and other time factors considered.
- (4) Ship's Material Condition: Estimating Standards, historical estimates, "Rules of Thumb" and other estimating tools available for use are generally applicable under "average" conditions. Estimates for many work operations should be factored to reflect the material condition of the ship. If the ship is in average condition the standards need not be factored. If the ship is new, then the standards should be reduced to reflect the better than average material condition. If the ship is in very poor material condition the estimate should be increased. Not all work operations are affected by the ship's general material condition; however, many are, such as surface preparations, painting, insulation and lagging, structural repairs, etc.
- (5) Category I Standard Items: The NAVSEA Category I SIs are invoked in work packages in accordance with the guidance provided by the Standard Specification for Ship Repair and Alteration Committee. When invoked in a job order, the provisions of the Category I SI apply for the duration of the availability without further reference. The estimator must know which Category I SI is applicable for the work and what the direct, hard-core labor cost impact of each SI is on the work required. Each time the provisions of the Category I SI are applicable in a work item, an allowance should be made to accomplish the hard-core labor requirements of the SI. An SI will be invoked if any work in the areas addressed in the SI is likely in the work package. Not all Category I SIs will have a direct hard-core labor cost impact. Those that do are discussed briefly in the following sections.
 - (a) SI 009-04: Quality System; provide. Invoked for all significant availabilities. This item requires the contractor to develop and use an inspection system acceptable to the Government. The contractor must develop an inspection plan for each item and record inspection results. This plan must provide for a corrective action program to correct defective or non-conforming work, maintain a calibration system for test equipment, control non-conforming material, conduct periodic quality reviews and provide notification to the Government for each CHECKPOINT. When this SI is invoked, nearly every work item should have approximately 10 percent of the effort allocated to Quality Assurance and NDT.
 - (b) SI 009-07: Fire Prevention and Housekeeping; accomplish. Invoked for all manned vessels, unless the Type Commander (TYCOM) requests SI 009-35. This item requires the contractor to provide acetylene or gas supply manifold systems off the ship with shutoff valves to gas supply on the pier. This requirement should be considered in each instance of gas use. When SI 009-07 is invoked, approximately 25 percent of the hot work effort should be allocated for estimating fire watch requirements.
 - (c) SI 009-10: Shipboard Asbestos-Containing Material; control. Invoked when any machinery, piping and compartment insulation and lagging may be removed. Under this item, the contractor is required to provide a process control procedure for the control of asbestos-based insulation and lagging materials. All insulation and lagging

materials are assumed to be asbestos-based until shown to be otherwise. Work accomplished must conform to Occupational Safety and Health Act requirements regarding insulation removals, work zones, protective equipment and clothing, and disposal of insulation. Compliance with these requirements is a labor-intensive operation that must be considered for each time and place the work is required. When SI 009-10 is invoked, approximately 33 percent should be added to the insulating and lagging estimate of the work item.

- (d) SI 009-24: Isolation, Blanking and Tagging Requirements; accomplish. Invoked when equipment, systems, piping or circuits require isolating, blanking and tagging for safety or cleanliness and to prevent operation of a system or equipment while work is being accomplished. Under the requirements of this item, the contractor is required to comply with the Ship's Force system for isolation, blanking and tagging of equipment or systems in the performance of required work. The contractor has to notify Ship's Force in each instance of starting or completing work and a contractor representative must sign the ship's tag out log. Further, the contractor has to provide, install and remove blanks on piping, valves, equipment and components that are isolated or removed during performance. Items removed must be tagged with metal tags. Electrical cables disconnected must be insulated and taped. Each of these requirements requires hard-core labor for accomplishment and must be considered as part of the work activity even though not specifically spelled out in the work item (2-Kilo). When invoked, approximately 5 percent of the trade hours should be added to the estimate to cover the requirements of SI 009-24.
- (e) SI 009-61: Shipboard Use of Fluorocarbons; control. Invoked for all specifications. Under this item, the contractor is required to develop and use a process control procedure to govern control of shipboard use of fluorocarbons. The contractor must notify the Government in each instance of use of fluorocarbons and must provide ventilation and telephonic communications for transfer operations, suspend hot work in spaces affected by atmospheric fluorocarbons, use at least two people for quantities in excess of 10 pounds and vent gases to ship exterior atmosphere. These requirements must be considered in all estimates involving the use of fluorocarbons. Approximately 20 percent should be added to the estimate to cover the requirements of SI 009-61.
- (f) SI 009-65: Polychlorinated Biphenyls (PCB); control. Invoked for all specifications. Under this item, the contractor is required to develop and use a process control procedure for control, clean up and disposal of PCBs. The contractor must inspect each equipment or component containing PCBs and make a report. These requirements must be considered in any work estimate where PCBs are involved.
- (g) SI 009-73: Shipboard Electrical/Electronic/Fiber Optic Cable; remove, relocate, repair and install. Invoked for all specifications requiring electrical work. Under this item, the contractor is required to remove completely all electrical cables no longer necessary due to work required in the job order. Work required includes blanking bulkhead and deck penetrations, removal of unused hangers and installation of new banding for remaining cables. Relocation of existing cables and installation of new cables requires banding, installation of hangers, deck and bulkhead penetrations and connection of cable leads to components or equipment. These requirements must be included as work activities in all work on shipboard electrical cables.
- (h) SI 009-106: Work Authorization and Control Process; accomplish. Invoked for all specifications. This requires the contractor to comply with Volume IV, Chapter 10 of this manual regarding work authorization. Specifically, the contractor is required to submit a Work Authorization Form to the designated representative of the ship's Commanding Officer for authorization to start work on each Work Item in the Job Order. This is considered an overhead/indirect charge so no direct labor charges are included in any estimates.

- b. References (b), (c) and (d) also can have significant labor impact. Appendix C is provided as a check-off list to assist the estimator in properly considering the impact of Category I Standard Items. Each of these SIs must be fully understood before an estimator can properly allow for the cost impact in performance of the work required. Those items characterized as “labor intensive” must have detailed estimates prepared to reflect the scope of work required. The scope of work will vary significantly from job to job.

5.7.4 Material Estimating.

- a. The material estimate usually receives the least attention of all the estimates provided. This may not significantly affect a small job, but the accumulation of small errors on a large package can affect the total estimate considerably. When estimating material costs, the following shall be considered:
 - (1) The kinds and quantity of each material required to accomplish the work.
 - (2) Whether the materials are procurable or will be manufactured.
 - (3) The “lead time” for procuring the material.
 - (4) Is the material commercially available?
 - (5) The current or future price for the material.
- b. The estimator is not expected to be as familiar with the material pricing as a purchasing agent, but should be familiar with the market, should know what is scarce and what is not available from commercial sources and should keep up with current prices and availability. The estimator should also use drawing material lists, equipment technical manuals and Allowance Parts Lists to determine material requirements. Cost estimates are then based upon records of previous recent purchases, current Government and vendor catalogs and consultation with Government and commercial sources.

5.7.4.1 Contractor vs. Government Furnished Material. In estimating material costs, no distinction is made between CFM and GFM. All material will be priced the same way using either Government or commercial prices, whichever is most readily available and appropriate. Generally speaking, because the Government purchases supplies in large lot quantities, the cost to the Government will be less than it would be to a private contractor making single item or small lot purchases. For this reason, Government prices should not be used when estimating costs for CFM in a work item, however, because the allowable variance in Class F estimates is 40 percent, it is permissible to use either commercial or Government material prices for Class F material estimates. This estimate should not include the cost of material to be provided as Special Program Material or Centrally Procured Material in support of the Navy Modernization Process (NMP). Likewise, the cost of repairable items under special turn-around programs should not be included in the work package. In developing estimates for work items, a decision about CFM vs. GFM must be made before the estimate can be finalized. CFM estimates are provided on the reverse side of Appendix A. It is general Department of Defense policy that contractors provide all material necessary for performance. That means simply that all material should be CFM except where it is in the best interest of the Government to provide material as GFM. Exceptions to the CFM policy include:

- a. Items in long supply in the Navy Supply System (i.e., items stocked far in excess of expected item demand) should be provided as GFM since it would be wasteful to require contractors to buy such materials.
- b. Items with a set shelf life that will expire before normal draw down in the supply system should be issued as GFM if such usage remains within the shelf life requirements.
- c. Long Lead Time Material should be provided as GFM. In Government procurements, items that are not commercially available within the time period after contract award and the time the contractor needs the material for production should be considered as Long Lead Time Material.
- d. Standardization material should be provided as GFM. This material is the Special Program Material and the Centrally Procured Material purchased in support of the NMP.
- e. Material requiring Provisioning Technical Data should be provided as GFM. Normally, repair material does not require Provisioning Technical Data because it is already stocked in the supply system.

- f. Material items to be changed out under special turnaround or repairable programs should be provided as GFM.
- g. Material for contractor work performed outside of the U.S. Overseas contractors may not have ready access to materials meeting Navy specifications and are often procured as GFM.

5.7.4.2 Sources of Pricing Information. The most important source of pricing information for ship repair material is the Navy price list for stocked supplies and repair parts. This pricing information, when used in estimating, is adequate for pricing material requirements. Navy stock prices should not be used for estimating the cost of CFM in work items because the cost to industry for the same repair parts and supplies can be considerably higher. When the use of Navy pricing information is not appropriate or when the required pricing information is not available, the best source of current pricing information is the manufacturer or dealer who is in the business of distributing the materials or parts needed. Every estimator should maintain a listing of vendors, manufacturers, distributors, etc., that can be consulted to obtain current pricing information. Where available, catalogs of pricing data should be ordered and maintained in a central repository for reference by all estimators who may require the pricing information. Each RMC should maintain a library of current material pricing data for materials frequently required in typical ship repair activities estimated by the RMC.

5.8 ESTIMATING FOR CONTRACT MODIFICATIONS.

5.8.1 Contractor Modifications. For contract modifications, including Master Agreement Job Order modifications and for noncompetitive procurements, estimates must include allowances for known conditions in the estimating environment. The scope of the modification estimate must include consideration of additions and deletions required by the change, the impact on completed work by the change and the current status of materials made obsolete by the change. The cost estimate must consider the means of performing the work, the completion date and other factors impacting on performance such as delay, disruption or acceleration. These cost elements must be identified, quantified and included in any cost estimate. In considering the means of performance, due consideration must be given to the contractor's normal operating procedures. The estimate should be prepared based on the methods, procedures, facilities, equipment and employees available to the contractor. In such a sole source environment, it is unfair to the contractor to negotiate changes on any basis other than those that impact on the costs of performance by the contractor. Estimates for changes must be prepared based on the way the contractor would perform the work, considering current workload as well as contractor inefficiencies and disruptions that may result from the change. The estimate must also consider the timing of the work to be done. Change work authorized early in availability is less costly than change work authorized later. For example, work in a propulsion space, authorized three weeks prior to a Light Off-Examination by the Afloat Training Group could easily be three to four times the cost of the same scope of work authorized a week or two after the start of an availability.

5.8.2 Acceleration. Acceleration should be considered in developing estimates for contract modifications that increase the scope of work. Simply defined, acceleration is a speeding up of the work in an attempt to complete performance earlier than otherwise anticipated. Acceleration consists of such items as increased manning, added shift work, overtime, rescheduling of work force, new hires, new subcontracting, etc. Acceleration, when required, must be considered in any estimate for changed work in a job order. Acceleration costs will nearly always be incurred when significant growth or new work is added to a work package that is to be completed in the original contract performance period. A contract is also "accelerated" if the original performance period is decreased without an accompanying decrease in the scope of work. When acceleration is required, it must be identified in the contract modification (scope of work) and estimated as any other work element is estimated.

5.8.3 Disruption. Disruption costs should also be considered in developing cost estimates for contract modifications. It is the cost of the man-hours, materials and other costs that are expended to offset inefficiencies experienced as a result of Government-caused or contractor-caused changes or other departures from the original schedule that includes the effect of changed work on unchanged work. It is also the process by which the above inefficiencies in the performance of contract work are created. Disruption, when it can be identified, must be quantified and accounted for in any contract modification estimate prepared. As with most estimating, quantifying disruption is an inexact process and there are few official guidelines to draw on for assistance. The real requirements to be kept in mind are that it must be considered in determining the scope of work and, if present, the contractor must be compensated for disruption attributable to the change. Disruption attributable to the contractor's past performance, without regard for the change, must not be considered.

5.8.4 Delay. When a contract change affects the completion of the contract, a contractor may request additional compensation for this “delay”. Delay can also be an element of the contractor’s cost estimate when other Government action or inaction causes a delay to the contractor’s efforts. Delay is defined as that period of time a contractor is required to perform beyond the planned delivery or completion date, due to contractually remediable Government action or inaction (e.g., changes, stop work orders, suspension or late or defective GFM). Delay must also be considered whenever any time-oriented event affects the length of or causes a suspension in scheduled contract work. As with any other cost element, if present, it must be identified, quantified and accounted for in any estimate provided. Delay attributable solely to the contractor’s execution of the job order is not considered in any estimate for a contract modification.

5.9 SHIP CHANGE ESTIMATES.

5.9.1 Navy Modernization Process. Reference (e) defines policies and procedures and assigns responsibilities for the establishment and revision of man-day estimates, man-day cost estimates and material cost estimates for Ship Change (SC) installations. Realistic estimates of required man-days and correct application of man-day rates are important in programming and budgeting for the NMP. Additionally, capturing post-availability return costs for SCs, particularly when available in terms of both labor hours and material costs (as in the case of Cost Reimbursable contracts), provide a valuable resource to NMP managers in refining cost estimates for future installations.

5.9.2 Classification of Ship Change Estimates. SC estimates are usually prepared at either the Class F or Class C level. When Class C estimates have been previously prepared for a specific SC, that estimate, or the historical average of the estimate, should be used as the estimate for that work when it is authorized in future SCs. Recall that Class F estimates are “ballpark” estimates prepared in the absence of detailed design or engineering data, repair instructions and detailed material requirements. Before preparing such an estimate, all other sources of estimating data shall first be exhausted.

5.9.3 Sources of Ship Change Estimating Data. The preferred way to estimate a SC is to use the historical estimate for that item if it has been previously estimated. Generally, historical estimates are preferred over actual return costs. In both cases, differences in ship conditions (e.g., docking vs. non-docking availability) and the nature and location of other repair and modernization work performed on the ship during a given availability can significantly influence the return costs of the work performed. Selection of the best estimate source is a matter of good judgment based on the pertinent facts. If historical estimates or return costs are not available, the next preferred approach is to examine the estimates or return costs for similar work. By making adjustments to account for the differences in the actual work required, those estimates can be used as the basis for a new estimate.

5.9.4 Ship Change Estimating Techniques. When historical estimates or return costs are not available for use in SC documents, a Class F or Class C estimate must be prepared based on the SC work scope descriptions and estimating data available. All of the techniques available for estimating repair work items are also applicable in developing SC estimates. The basic difference between developing a SC estimate and an estimate for a repair work item is that repair work generally has more detailed information available in the work statement. In estimating a SC, the work scope statement is often a relatively simple direction to install in accordance with drawings. Particularly in the case of a first-time SC, the challenge for the estimator comes from a detailed review of what is required to accomplish the requirements of the SC drawings and any associated technical manuals and bills of material. The approach to estimating and the techniques used should still closely parallel those that would be used to estimate repair work. The work scope should be broken down into logical elements that can be estimated readily. The estimates for each element are then added together to obtain the total estimate.

5.9.5 Prorated Cost Estimates.

- a. In the preparation of total availability budgets and cost projections, as well as preliminary and final review estimates for SCs, it is necessary to identify each funding activity’s (e.g., TYCOM and NAVSEA) share of the prorable costs associated with the availability. Proration costs will vary between availabilities depending upon the relative magnitude of the work package under each customer funding account. Only those general type services that apply to more than one customer and are performed during an availability are prorable, (e.g., temporary services, crane services, docking services, guarantee engineer, etc.). Services that are performed in support of a specific job are not prorable. As an example, consider an access cut for removals in a machinery space where both repairs and alterations require removals. In this case, the cost of the access should be prorated. In the case of an access cut solely to support repair work, the cost of the access cut is not prorable and the

cost would be borne by the TYCOM. Labor elements and other direct costs not estimated in the Government estimating system should not be considered in the cost to be prorated. These elements are accounted for in the Overhead (OH) or Other Direct Labor (ODL) categories of the labor rate used for the cost estimate. These costs include such items as the costs associated with scheduling, material handling, fire watches, etc.

- b. In general, the actual Direct Labor (DL) hours charged to the Government and attributable to a benefiting customer should be used as the basis to prorate service costs. In those cases where these costs are not available, it is appropriate to use the estimated labor hours to be funded by a benefiting customer as the proration basis.

5.10 LABOR RATE ESTIMATING.

5.10.1 Projections. Each fiscal year within the Department of Defense Planning, Programming and Budgeting System, the Navy is required to submit proposed changes to the Future Year Defense Plan that represent the proposed pricing of approved programs. This process forms the basis for the Navy budget. Each year in support of this budget request, NAVSEA will issue a call to the RMCs for projections of private contractor labor rates for the current fiscal year and five future fiscal years. The TYCOMs and NAVSEA Project Managers use this data in developing maintenance budgets. The following discussion related to labor rates addresses the importance and variability of labor rates used in estimating for ship repair:

5.10.2 Labor Rates. The term “labor rate(s)” is not used to denote just wage rates, but all costs except material (and profit, in the case of private contractors).

5.10.2.1 Private Contractor Labor Rates. Reference (e) directs RMC Contracting Officers to identify labor rates for the current fiscal year and to project labor rates for the next five future fiscal years for each active ship repair contractor. NAVSEA publicizes this information for use by Office of the Chief of Naval Operations sponsors, NMP sponsors, Fleet Maintenance Officers, TYCOMs, RMCs, Supervisors of Shipbuilding, Conversion and Repair, United States Navy (SUPSHIP) and Ship Availability Planning and Engineering Center planning activities. The information should be used in advance planning work definition and authorization, in pricing of solicitation work packages and in budgeting for pricing of approved maintenance projects.

5.10.2.2 Other Direct Labor Factor. ODLF is that factor which accounts for all direct labor charged by the contractor that is not identified and accounted for on Appendix A. A sample calculation is described in paragraph 5.10.2.4 of this chapter.

5.10.2.3 Labor Rate Determination.

- a. In determining private contractor labor rates, the RMCs and SUPSHIPS obtain accounting data from DCAA and each contractor. This data is analyzed to compute the ODLF required to make estimates prepared in the Standard Government Estimating System comparable to estimates prepared in the contractor’s estimating system. The ODLF will range from 10 percent to as much as 80 percent or more, with the average being between 30 percent and 40 percent. What this means is that for the same scope of work, the Government estimate will always be less than the contractor’s estimate because the contractor’s estimate will contain labor hours for the ODL categories that are not estimated in the Standard Government Estimating System. To account for the differences in the estimating systems, two approaches can be taken. The Government man-hour estimate can be inflated by the ODLF and be used with the contractor’s current forward pricing labor rate or the contractor’s labor rate can be inflated by the ODLF to obtain a new labor rate which is used with the Government man hour estimate to obtain costs. For budgeting purposes, the latter course of action is directed by NAVSEA. This method of equating the estimating systems is also recommended for other Government estimating. In any case, it is inequitable to apply the contractor’s labor rate to the Government estimate to project expected costs. This method will always result in understated costs.
- b. For a variety of reasons, including the many variations and complexities in contractors’ accounting systems, there are many different approaches to labor rate determinations. Indeed, the terminology varies as well with local customs and the vernacular. Labor rate determinations for contractors can be very simple or very complex, depending on such things as the size of the contractor’s work force and the sophistication of the contractor’s accounting system. The contractor’s labor rate is a function of many things related to the contractor. For example, the efficiency and skill of the work force, the mix

of trade categories required to perform the work, the facilities and tools available and other factors will impact the rate. Further, the rate will differ for different kinds of work. For example, work on nuclear power plants requires more inspection and verification than conventional power plant work. For this reason, the factors developed must be applicable to the type of work contemplated. Some contractors will require that factors be developed for each category of work performed (i.e., submarines, surface force, aircraft carrier or barge and boat work). An example of a typical rate determination follows:

Accounting data for a representative period, usually the firm's accounting year, is examined and after elimination of non-allowable costs, the costs in the various categories are computed. In this example, the cost categories are identified as DL, OH, and General and Administrative (G&A). The total DL hours computed to be worked are divided into the total wages computed to be paid for DL (excluding overtime premium) to determine the average DL wage rate. The OH and G&A rates are determined essentially the same way. However, DCAA may make other recommendations. The OH rate is divided into variable and fixed components. The variable portions such as certain fringe benefits vary with changes in the DL base hours worked, whereas the fixed portion does not change (within certain limits). The DCAA examines the contractor's rate proposal in conjunction with the ACO, discusses issues with the contractor and forwards the rate proposal to the ACO with recommendations for approval or partial approval where some data is unacceptable. The ACO then establishes a labor rate based upon the DCAA audit report results and discussions with the contractor. This composite rate is the sum of DL, OH, and G&A.

5.10.2.4 Sample Other Direct Labor Factor and Labor Rate Determination. A sample computation of a contractor's labor rate determination follows:

- a. For simplicity, assume this contractor does not have G & A and melds those costs into OH such that variable and fixed costs for the OH associated with 130,000 DL hours worked are:

Variable	\$700,000
Fixed	<u>\$600,000</u>
Total	\$1,300,000

The OH rate is then $\frac{\$1,300,000}{130,000 \text{ hr}} = \$10.00/\text{hr}$ (assuming the contractor allocates OH on a direct labor hour basis)

- b. The direct labor wages paid are \$2,600,000 and the average DL rate is $\frac{\$2,600,000}{130,000 \text{ hr}} = \$20.00/\text{hr}$.
- c. The rate then becomes: DL Rate + OH or 20 + 10 = \$30.00/hr.
- d. Now using the sample figures shown in Appendix D, we calculate the ODLF, which when applied to the contractor's forward pricing rate will make the rate applicable to estimates prepared in the Standard Estimate. The ODLF is ODL expressed as a percentage of the Total Direct Labor or:

$$ODLF = \frac{ODL}{TDL} \times 100$$

- e. The contractor's forward pricing rate is increased by this percentage to make it applicable to Government estimates prepared on the Standard Cost Estimate Sheet. According to the totals in Appendix B, the TDL is 130,090 man-hours. The total hard-core labor is 101,010 man-hours. The ODL is 29,080 man-hours. Therefore, the ODLF is:

$$ODLF = 29,000 / 101,000 \times 100 = 28.71\%$$

- f. Thus, the forward pricing rate of \$30.00/hr is factored by 1.2871 to yield \$38.61/hr. Add to this a profit factor of 10 percent to yield \$42.48/hr. This hourly rate converts to a daily rate of \$339.80, which is the rate applicable to estimates prepared by the Government. It is also the rate reported by the RMCs and SUPSHIPs to NAVSEA 017 for use in the Planning, Programming and Budgeting System. Where contractors apply variable OH rates for different kinds of work, a labor rate must be established for each different category of work performed. For example, it is usually true that factors for new construction

and repair would be significantly different. Likewise, rates could differ appreciably for nuclear or non-nuclear plant work or surface force ship, aircraft carrier or submarine work. For contractors that do different kinds of work such as new construction and repair, nuclear or non-nuclear work or surface ship or submarine work, specific rates should be determined for each category of work contemplated in the Future Year Defense Plan.

5.10.2.5 Contractor Rate List.

- a. NAVSEA collects the rate data from all RMCs and SUPSHIPS for all contractors and prepares a contractor rate list. Table 5-4 is a sample of the contractor rate list.

Table 5-4

SUPSHIP SAMPLE					
	FY97	FY98	FY99	FY00	FY01
Contractor "A"	\$300	\$305	\$310	\$315	\$320
Contractor "B"	\$305	\$315	\$326	\$337	\$349
Contractor "C"	\$308	\$318	\$329	\$341	\$353

- b. In addition to the listing of contractor labor rates for each RMC and SUPSHIP, a composite labor rate for each port is developed to reflect the average labor rate for the area. Table 5-5 is a typical port composite labor rate projection for the West Coast.

Table 5-5

PORT COMPOSITE LABOR RATE (WEST COAST)					
	FY97	FY98	FY99	FY00	FY01
San Diego	\$300	\$305	\$310	\$315	\$320
Long Beach	\$310	\$325	\$342	\$359	\$377
San Francisco	\$326	\$342	\$359	\$377	\$396
Seattle	\$325	\$341	\$358	\$376	\$395
Pearl Harbor	\$350	\$367	\$386	\$405	\$425

- c. And finally, a composite coast labor rate for each coast is developed to reflect the average labor rate of all the major private contractors on that coast. Pearl Harbor is not included in the West Coast composite labor rate since West Coast solicitations are restricted to the Continental United States. Table 5-6 is a typical coast-wide composite rate projection.

Table 5-6

COAST COMPOSITE LABOR RATE					
	FY97	FY98	FY99	FY00	FY01
WEST	\$325	\$341	\$358	\$376	\$395
EAST/GULF	\$275	\$289	\$303	\$318	\$334

- d. The solicitation area must be considered in making the decision on which labor rate to use. Some of the choices to consider are:

- (1) A single contractor's labor rate can be selected if it is probable this particular contractor will be awarded the contract.
- (2) A port composite labor rate can be selected.
- (3) The coast composite labor rate can be assigned.

5.10.2.6 Labor Rate Evaluation for Competitive Procurements. Competitive procurements require at least two or more contractors be considered as "competitive" for the procurement. To be considered competitive for a procurement, a contractor must be capable of doing the work required by having requisite facilities capacity and, more importantly, the interest in responding to the solicitation. All contractors in the solicitation area may be interested in the solicitation, but some may not be competitive. The Government must assess the competitiveness of each contractor in order to determine an appropriate labor rate, which is representative of the net competitive environment to apply to the preliminary cost estimate.

5.10.2.7 Labor Rates for Noncompetitive Procurements. In noncompetitive procurements, the contract price is negotiated on a sole source basis with the contractor. The contractor labor rate can be computed to be consistent with the Government Estimating System or if the Government agrees with the contractor to use another estimating system, then the labor rate must be compatible with that system.

5.10.2.8 "The Right Labor Rate" Determination. Meaningful estimates depend on the prediction of the labor rate to be used in determining the dollar value of the estimate in question. In order to accurately predict the labor rate, it is necessary to identify the contractors within the solicitation area likely to be awarded the contract. A "composite rate" is computed from the contractors' labor rates and an evaluation of the "net" competitive situation. This evaluation should include consideration for:

- a. Solicitation area contractor attitudes, competitive assessment, recent award prices for similar types of work, other commercial and Navy workload, contractor profit considerations and other market conditions.
- b. Technical and production "risk" analysis of the availability work package.
- c. Input from other Government activities (Military Sealift Command, United States Coast Guard, DCAA).

5.10.2.9 Market Conditions Assessment. Cost estimates must be realistic if they are to be of use for the purpose for which they are intended. To be realistic, cost estimates must be based on present market conditions, which, in turn, must be related to the procurement in-hand and to the conditions in the private contractors being solicited. Cost estimates predicted solely on man hour and material estimates without considering current market conditions are unrealistic and may result in bids or proposals received for ship repair work that are too high or too low when compared with Government estimates. In assessing the impact of market conditions, the following elements are generally considered:

- a. When most yards are at full capacity the composite rate is adjusted upwards, somewhere between 10 and 30 percent, depending on the surge capacity of labor resources in the solicitation area.
- b. When most yards are below capacity the composite rate is adjusted downwards, depending on the extent of excess labor resources available. Potential "buy-ins" must be anticipated. The downward adjustment may be as great as 50 percent of the Government estimate.
- c. When making adjustments in rates, the nature of the work required is also considered. For highly technical or new, complex work, the larger yards should be more competitive.
- d. For well-written, tight specifications, where little or no growth or new work is anticipated, a composite rate as close as possible to the expected actual rate is used.
- e. For loosely written specifications with great potential for growth and for new work after award, a "buy-in" should be expected and the estimate should be adjusted downward at least 30 percent to 40 percent.
- f. In a very competitive market, award prices in the recent past for similar work packages in the same area are examined. The composite rate is adjusted to be somewhat less but comparable to the average of the rates that is determined by dividing the award prices by the total labor hours (or man-days) estimated for the work packages awarded.

5.11 FORWARD PRICING RATES. A forward pricing rate is a written agreement negotiated between a contractor and the Government to make certain rates available during a specified period for use in pricing contracts or modifications. Such rates represent reasonable projections of specific costs that are not easily estimated or identified. Generally, the RMCs and other administrative contracting officers will annually (or more frequently as needed) negotiate a forward pricing rate with contractors awarded Government contracts. Contractors and the Government can facilitate forward pricing of contract modifications by reaching an understanding regarding the estimating system and forward pricing rates to be used. Reference (e) allows contractors to propose forward pricing rate agreements or formula pricing agreements to incorporate cost estimating relationships which will reduce proposal documentation efforts and enhance the ease with which Government personnel can understand the contractors' estimating system. The RMC Contracting Officers normally negotiate with the ship repair contractors at least every six months to determine forward pricing rates. As with competitive labor rates discussed in earlier sections, forward pricing rates for labor calculations generally include projected work-load (direct labor), total overhead, labor costs and profit. An example of the calculation is shown in Table 5-7.

Table 5-7

FORWARD PRICING RATE CALCULATION	
DIRECT LABOR (HOURS)	100,000.00
FIXED OVERHEAD (\$)	200,000.00
VARIABLE OVERHEAD (\$)	800,000.00
TOTAL OVERHEAD (\$)	1,000,000.00
OVERHEAD RATE (\$/HOUR)	\$10.00
DIRECT WAGES (\$)	\$1,400,000.00
DIRECT LABOR RATE (\$/HOUR)	\$14.00
TOTAL HOURLY RATE (\$/HOUR)	\$24.00
PROFIT @ 10 PERCENT	\$2.40
HOURLY RATE W/PROFIT (\$/HOUR)	\$26.40
	x 8
FORWARD PRICING LABOR RATE (Man-day)	\$211.20

*For simplicity, it is assumed that G&A is included in OH and ODL is included in DL.

(This Page Intentionally Left Blank)

**APPENDIX B
ESTIMATING CHECK-OFF LIST**

ESTIMATING CHECK-OFF LIST												SWLIN:	
												ITEMS:	
REQUIREMENTS/ CONSIDERATIONS		ACTIVITY/ITEM											
		1	2	3	4	5	6	7	8	9	10	11	12
1	INTERFERENCES												
2	ACCESSES												
3	GAS FREE REQUIREMENTS												
4	COFFERDAMS/DIVING SERVICES												
5	CRANE/RIGGING SERVICES												
6	STAGING/PROTECTIVE COVERS												
7	INSULATION/LAGGING												
8	TEMPORARY LIGHTING												
9	TEMPORARY VENTILATION												
10	SANDBLASTING												
11	LABORERS												
12	OTHER ASSIST TRADES												
13	PRELIMINARY/SHOP TEST												
14	OPERATIONAL TEST												
15	TRANSPORTATION												
16	CLEANING												
17	CHIPPING/GRINDING												
18	SYSTEM PURGE												
19	SYSTEM FLUSH												
20	CALIBRATIONS/ADJUSTMENTS												
21	REPORTS/DATA												
22	CERTIFICATIONS/SURVEYS												
23	MANUFACTURING												
24	FABRICATION/ASSEMBLY												
25	TOUCH-UP PAINTING												
26	WASTE/DAMAGE/REWORK												
27	PREVAILING WEATHER												
28	SHIP'S FORCE WORK												
29	MATERIAL CONDITION												
30	CATEGORY I STANDARD ITEMS												
31	CHECKPOINTS												
32	QUALITY ASSURANCE/NDT												
33	MATERIAL REQUIRED												

(This Page Intentionally Left Blank)

APPENDIX C

CATEGORY I STANDARD ITEM HARD-CORE LABOR CONSIDERATIONS		ACTIVITY/ITEM									
STANDARD ITEM	HARD-CORE LABOR REQUIREMENTS										
009-04	INSPECTION SYSTEM (ROH/SRA) (QA & NDT)										
009-07	FIRE PREVENTION AND HOUSEKEEPING										
009-10	CONTROL OF SHIPBOARD THERMAL INSULATING MATERIAL (LABOR INTENSIVE)										
009-24	ISOLATING, BLANKING, AND TAGGING (LABOR INTENSIVE)										
009-61	CONTROL OF SHIPBOARD USE OF FLOROCARBONS (LABOR INTENSIVE)										
009-65	SHIPBOARD ELECTRICAL CABLE (LABOR INTENSIVE)										
007-73	SHIPBOARD ELECTRICAL CABLE (LABOR INTENSIVE)										
009-74	CONTROL OF NON-ASBESTOS THERMAL FIBER INSULATING MATERIAL (LABOR INTENSIVE)										

(This Page Intentionally Left Blank)

APPENDIX D
EXCALIBER CONTRACTOR
OTHER DIRECT LABOR FACTOR CALCULATION
(6 MONTH PERIOD)

Direct Labor Categories	Hours	Other Direct Labor Categories	Hours
*Boilermaker	4,520	Planning and Progressing	2,508
*Bricklayer	4,276	Testing	992
*Burner	10,224	Program Manager	1,620
*Carpenter	23,958	Material Control	1,176
*Chipper	4,764	Hi-Lo Operator	1,302
*Electrician	7,744	Crane Operator	3,274
*General Labor	13,440	Calibration	2,266
*Grinder	1,784	Firewatch	12,606
*Joiner	900	Safety	1,714
*Lagger	3,000	Security	410
*Painter	3,610	Equipment Control	306
*Pipefitter	10,416	Transportation	826
*Plumber	1,682	Total Other Direct Labor	29,000
*Rigger	10,652		
*Scaler	1,230		
*Sheetmetal	2,000		
*Shipfitter	17,852		
*Welder	20,292		
*Inside Machinist	15,966		
*Outside Machinist	34,282		
Total Hard-Core Direct Labor	101,000		

$$TDL=HC+ODL$$

$$ODL=TDL-HC$$

(This Page Intentionally Left Blank)

VOLUME VII
CHAPTER 6
FUNDING AND ACCOUNTING

REFERENCES.

- (a) 31 USC 1301(a) - Application
- (b) 31 USC 1341 - Limitations on Expending and Obligating Amounts
- (c) 31 USC 1342 - Limitation on Voluntary Services
- (d) 31 USC 1349 - Adverse Personnel Actions
- (e) 31 USC 1517 - Prohibited Obligations and Expenditures
- (f) 31 USC 1518 - Adverse Personnel Actions
- (g) DoD 7000.14-R - Volume 14 - Administrative Control of Funds and Anti-Deficiency Act Violations
- (h) DoD Directive 7200.1 - Administrative Control of Appropriations
- (i) NAVCOMPT Manual - Navy Comptroller Manual Volume 2
- (j) NAVSO P-3006 - Financial Management of Resources Operations and Maintenance, (Shore Activities)
- (k) NAVCOMPT Manual - Navy Comptroller Manual Paragraph 035400-035452
- (l) NAVCOMPT Manual - Navy Comptroller Manual Volume 3, Appropriation, Cost, and Property Accounting (Field)
- (m) 41 USC 23 - Orders or Contracts for Material Placed with Government-owned Establishments Deemed Obligations
- (n) 31 USC 1535 - Agency Agreements
- (o) Public Law 97-114 - DoD Appropriations Act
- (p) STARS Users Manual (FMSO P-104)
- (q) NAVCOMPT Form 2168/1 - Expense Operation Budget
- (r) DoD Financial Management Policy Manual
- (s) NAVCOMPT Form 2275 - Orders for Work and Services

6.1 **PURPOSE.** To provide information concerning the appropriation, allocation, management and accounting for funds that pay for services and materials used for ship maintenance, repair, modernization and during availabilities assigned to contractors through various types of contracts. This chapter provides discussion concerning the infrastructure and processes that must be considered and implemented to assure that the fiduciary responsibilities of the Procuring Contracting Officer and Administrative Contracting Officer and their appointed assistant financial managers are understood and consequences for noncompliance are articulated.

6.2 **SCOPE.** A Command's financial management program for the administration of funds is defined as an integral part of management. To accomplish the objective of financial management this chapter addresses the responsibilities associated with managing public funds that are appropriated for specific purposes as authorized by Congressional action, Department of Defense (DoD) allocations and Department of the Navy financial policies. The main purpose of financial management is to aid the higher-level management of ship repair planning and executing organizations. Appropriate accounting processes are engaged to account for funds and obligations committing funds of the Government's Treasury. This chapter specifically concerns financial management of funds authorized for the purpose of entering into contracts awarded to the private sector to accomplish repairs and modernization to ships, craft and other Government assets administered by Regional Maintenance Centers (RMC).

6.3 **POLICY.** Funds must be administered in accordance with current laws, regulations established by higher authority and policies established to provide for specific situations. The following are statutory requirements outlined in United States Code and other directives that establish funding controls requirements and policies:

- a. Reference (a) states that appropriations will be applied only to the objects for which the appropriations were made, except as otherwise provided by law. There is no requirement to report a violation of this statute. The accounting, however, must be corrected to reflect the proper funding. This accounting correction can lead to a reportable violation of the Anti-deficiency Act if the proper funds were not available at the time of the obligation or expenditure.

- b. Reference (b) states that an officer or employee of the United States may not make or authorize an expenditure or obligation exceeding an amount available in an appropriation or fund for the expenditure or obligation or involve the Government in any contract or other obligation for the payment of money before an appropriation is made, unless authorized by law.
- c. Reference (c) states that no officer or employee of the United States will accept voluntary services not authorized by law, except in cases of emergency involving safety of human life or protection of property.
- d. Reference (d) states an officer or employee of the United States Government or of the District of Columbia Government violating section 1341 and 1342 of this title shall be subject to appropriate administrative discipline including, when circumstances warrant, suspension from duty without pay or removal from office.
- e. Reference (e) states that an officer or employee of the United States may not make or authorize an expenditure or obligation exceeding an apportionment or the amount permitted by regulations prescribed.
- f. Reference (f) states an officer or employee of the United States Government or of the District of Columbia Government violating section 1517 (a) of this title shall be subject to appropriate administrative discipline including, when circumstances warrant, suspension from duty without pay or removal from office.
- g. Reference (g) provides that the Commanding Officer (CO) of an activity is solely responsible under 31 United States Code 1517 for the administration of all authorization of funds granted to the CO.
- h. Reference (h) addresses the statutory responsibilities inherent in the administrative control of funds.
- i. Reference (i), Appendix A addresses administration of funding by funds administrators. These individuals must also be informed of principles concerning the administration of the appropriations as contained in reference (i), Chapter 2.
- j. Reference (i), Chapter 3 and Reference (j) provide guidance to funds administrators concerning the administration of allotments and operating budgets.
- k. Reference (k) discusses the principles and procedures that are to be used concerning the use of various requests for work and services.
- l. Reference (l), Chapter 5, Section V states that all funded, reimbursable orders are subject to the recipient activity projecting that at least 51 percent of the funds will be used for "in-house" work.
- m. Reference (m) states that a project order is provided as a specific, definite and certain order issued for the production of material for repair, maintenance, or overhaul or for other specific work and services. It serves to obligate appropriations and funds in the same manner as contracts with a commercial enterprise.
- n. Reference (n) provides the authority as an economy act order is issued for work or services of a recurring nature where the scope of the work is not specific.
- o. Reference (o) requires that funds current at the start of a major availability must finance the cost of the modernization or repair, including all scope-of-effort changes necessary to complete it.

6.4 GENERAL INFORMATION CONCERNING FUNDING AND FUNDS ADMINISTRATION.

6.4.1 Appropriations. An appropriation is the authority provided by an Act of Congress to incur obligations for specified purposes and to make payments for them out of the Treasury. The following is a brief description of the seven types of appropriations most often used by a Naval Supervisory Authority. Refer to the Department of the Navy Financial Policy Manual for a detailed explanation of appropriations.

6.4.1.1 Operation and Maintenance, Navy. Operation and Maintenance, Navy (O&MN) funds are for expenses, not otherwise provided for, that are necessary for the operation and maintenance of the Navy, as authorized by law. Equipment purchases under this appropriation are limited to a unit price of less than \$250,000. This limitation may be changed in any future Congressional session. Operation and Maintenance funds are authorized on an annual basis.

6.4.1.2 Operation and Maintenance, Naval Reserve. This appropriation is for expenses, not otherwise provided for, necessary for the operation and maintenance of the Navy Reserve Fleet, as authorized by law. Equipment purchases under this appropriation are limited to a unit price of less than \$250,000. Operation and maintenance funds are authorized on an annual basis.

6.4.1.3 Shipbuilding and Conversion, Navy. The funds finance the construction of new ships and conversion of existing ships, including all hull, mechanical and electrical equipment, electronics, guns, torpedo and missile launching systems and communications systems. This appropriation is a multiyear appropriation and normally remains available for obligation for five fiscal years.

6.4.1.4 Weapons Procurement, Navy. Weapons Procurement, Navy is used to finance the procurement of missiles, torpedoes, guns, munitions and the installation of modernization equipment. This appropriation is a multiyear appropriation and remains available for new obligations for three fiscal years.

6.4.1.5 Other Procurement, Navy. Other Procurement, Navy finances the procurement, production and modernization of equipment not otherwise provided for. Such equipment ranges from the latest electronic sensors to training equipment and spare parts. The unit price of this equipment must be in excess of \$250,000. This appropriation is a multiyear appropriation and remains available for obligation for three fiscal years.

6.4.1.6 Research, Development, Test and Evaluation. Is used for expenses necessary for basic and applied research, development, test and evaluation, including maintenance, rehabilitation, lease and operation of facilities and equipment as authorized by law. This appropriation is a multiyear appropriation and remains available for obligation for two fiscal years.

6.4.1.7 Foreign Military Sales. Foreign Military Sales provides military assistance through the sale of defense articles and services to eligible foreign Governments and international organizations. The United States normally receives full reimbursement for costs associated with these sales.

6.4.2 General Classifications of Funds Transactions. All expenditures must be preceded by an authorization to expend from the available funds. In theory, every transaction progresses through the following four stages:

- a. **Initiations.** An administrative action that identifies funds set aside (reserved) for planning purposes before establishment of commitments or obligations related to the purpose of the reservation. Initiations will not be maintained as a part of the official fiscal records.
- b. **Commitment.** A firm administrative reservation of funds based on solid procurement directives, orders, requisitions, authorizations to issue travel orders or requests which authorize the recipient to create obligations without further recourse to the official responsible for certifying the availability of funds. A commitment is generally recorded when the comptroller signs the document to certify that the funds are available and properly cited for the effort. This is mandatory in the Standard Accounting and Reporting System (STARS) per reference (p).
- c. **Obligation.** Incurred when an order is placed, contract is awarded, service is received, orders are issued directing travel and similar transactions are entered into during a given period requiring future payment of money in an agreed amount. By law, obligations must be supported by documentary evidence of a mutual agreement in writing. Each individual transaction must meet the test of the following principles:
 - (1) A determination that the specific goods, supplies or services required according to contracts entered into or orders placed obligating an annual appropriation are intended to meet a bona fide need of the fiscal year charged.
 - (2) Contracts entered into or orders placed for goods, supplies or services will be executed only with a bona fide intent that the performing activity will commence work and perform the contract without unnecessary delay.
- d. **Disbursement.** Made when the bill is paid. This, plus accounts payable transactions processed by the RMC or disbursing office, as applicable, result in a reflection of expenditures.

6.4.3 Repair Funds.

- a. The Fleet Commanders budget, (based mostly on the ship's Maintenance Team proposed annual Maintenance and Modernization Business Plan), and fund repairs from O&MN and Operation and Maintenance, Naval Reserve (O&MNR) appropriations, as applicable. The funds are normally

provided to the RMC for specific use by the Type Commanders (TYCOM). These funds pay for contractual costs of authorized repairs and modernization of ships and for the incidental costs which include:

- (1) Naval Supervisory Authority material.
 - (2) Travel and salary cost for overseas ship check.
 - (3) Ship Change and preparation of drawings or sketches to be contracted out.
 - (4) Sustainment Type One or Sustainment Type Two Fleet or Program Ship Changes on installed equipment.
- b. Repair funds are received by the RMC from Fleet Commands (FLTCOM) on reference (q) based on quarterly or monthly phasing plans approved by the TYCOMs. An Operating Budget (OB) is subject to the statutory limitations of reference (e). OBs pass funds for the execution of centrally managed procurement programs. Details on ship repair and modernization funds, including current year and prior year availabilities, may be found in reference (r).

6.4.4 Navy Modernization Process Funds. This program is covered in detail in Volume VI, Chapter 36 of this manual. Effective in Fiscal Year 90, the Navy Modernization Process was transferred from the O&MN and O&MNR appropriations to the Other Procurement, Navy appropriation. The transfer shifted the emphasis from ship alteration to equipment orientation. Installation of equipment is now funded with the same appropriation and fiscal year funds that procured the Government Furnished Equipment. Naval Sea Systems Command (NAVSEA) provides Project Directives for the accomplishment of Program and Fleet Alterations (Ship Changes). This funding covers expenses incidental to the accomplishment of alterations such as:

- a. Preparation and reproduction of alteration drawings contracted out.
- b. Travel costs, other than local, for overseas ship checks of alterations.

6.4.5 Berthing and Messing Funds. FLTCOMs provide berthing and messing funds using an Operating Budget Form, reference (q), to the Project Manager. In addition, NAVSEA may provide funds for this purpose through project directives. Fleet Commander's directives concerning the berthing and messing of crews undergoing scheduled availabilities should be reviewed.

6.4.6 Commercial Industrial Services Contracts. The Commercial Industrial Services Program, when utilized and funded, provides work or services to ships by use of Indefinite Delivery Indefinite Quantity Contracts, likewise there are also standalone Indefinite Delivery Indefinite Quality Contracts for selected service or productive capabilities awarded by a Fleet Logistics Center or the RMC Contracts Department. Orders are placed for repair of individual items for a predetermined price and performance period. The TYCOM authorizes the repairs to be included in these contracts. O&MN and O&MNR funding is provided to RMCs on OBs.

6.4.7 Environmental Compliance Oversight. This function is funded by FLTCOMs and NAVSEA (travel and training) and includes hazardous waste and shore environmental protection. This section is addressed further in Chapter 10 of this volume.

6.5 LEGISLATED RESPONSIBILITIES FOR CONTROL OF PUBLIC FUNDS.

6.5.1 Commanding Officer Responsibility. Reference (g) provides that the CO of an activity is solely responsible, per reference (e), for the administration of all authorizations of funds granted to the CO. The responsibility cannot be delegated in whole or in part within the Command. The CO will be held personally responsible for any act or an act of a subordinate within the activity that causes an over-commitment, over-obligation or over-expenditure of an authorization of funds. COs shall take all necessary action to establish accountability and enhance the administrative control of funds, including:

- a. Establish and maintain adequate fiscal controls to prevent the over-authorization, over-commitment, over-obligation or over-expenditure of funds made available to the activity.
- b. Issue an activity instruction providing for the authority, responsibility and procedures required in the administrative control of funds.

- c. Delegate funds administration authority to individuals at the appropriate level to ensure that the individuals are personally aware of the necessary detail to establish total accountability. Funds administrators shall be enabled to provide absolute technical input to funds control. Financial management remains the responsibility of the activity comptroller.
- d. Ensure that subordinates delegated the authority to act as funds administrators are authorized in writing, by name, clearly specifying the extent of the authority and the responsibility delegated.
- e. Ensure that designated funds administrators are familiar with the statutory responsibilities inherent in the administration of funds, including the provisions of the Administrative Control of Funds addressed in references (h) and (i). These individuals must also be knowledgeable of principles concerning the administration of the appropriations as contained in reference (i), Chapter 2, understand the administration of allotments and operating budgets as contained in reference (i), Chapter 3, reference (j) and the principles and procedures concerning the use of various requests for work and services contained in reference (k).

6.5.2 Comptroller. The activity's Comptroller has the responsibility for financial management and shall report directly to the CO of the Activity. Depending on the activity, the senior person in the finance office is normally the Comptroller or the Budget Officer. The Comptroller shall obtain guidance to resolve any questions on the interpretation of these laws.

- a. The Comptroller is the allocation holder who has three basic functions:
 - (1) Budget Formulation including those actions performed in development, review, justification and presentation of the budget estimates.
 - (2) Execution encompassing budgetary actions required to effectively and efficiently accomplish the programs for which funds were requested, as authorized by appropriate authority.
 - (3) Managerial Accounting providing management with financial information necessary to support the preparation of budget estimates and facilitate the budget execution process. The process shall ensure all funds are administered in accordance with the law, administrative policies and regulations of higher authority.
- b. The Comptroller shall be responsible for recording commitment and obligation transactions in the designated accounting system (STARS) chargeable to OBs, Project Directives or Work Requests, performing periodic reviews of un-liquidated obligations and unmatched disbursements, validating expenditures and advising the funds grantor of excess funds available for recapture.

6.5.3 Fund Administrators/Funds Managers. Individuals who are delegated authority in writing by the CO to authorize, commit, obligate and expend specific funds related to a specified authority and responsibility are agents of the Comptroller. These individuals provide technical input to financial management and can be held accountable and personally liable for over-commitment, over-obligation or over-expenditure of the funds administered.

- a. Any individual who is duly authorized by the CO as a Funds Administrator will familiarize themselves with the policies directives that are outlined in paragraph 6.3 of this chapter. In particular:
 - (1) Clearly understand the statutory responsibilities inherent in the administration of funds, including the provisions of the Administrative Control of Funds addressed in reference (h) and (i), Appendix A.
 - (2) Be informed of principles concerning the administration of the appropriations as contained in reference (i), Chapter 2.
 - (3) Understand the administration of allotments and operating budgets as contained in reference (i), Chapter 3, reference (j) and the principles and procedures concerning the use of various requests for work and services contained in reference (k).
- b. Funds Administrators will manage the funds, in whole or in part, as specified by the Comptroller and that have been allocated to individual projects in accordance with the delegated authority for the CO.

- c. Duly authorized individuals are required to request additional funds from the grantor of funds. Likewise, the individual will advise the grantor of funds when funds in excess of requirements are available for recapture.

6.6 RESPONSIBILITIES FOR SHIP MAINTENANCE FUNDING MANAGEMENT BUSINESS RULES. The goals of the Entitled Funding process are to reduce premiums paid for maintenance while at the same time improving the ability to respond to maintenance and operational requirements. The funding business rules for the Maintenance Team in managing the controls required to support all maintenance for a given ship are established in Volume VI, Chapter 31 of this manual.

6.6.1 Maintenance Team Funding Business Rules Responsibilities. The Maintenance Team identifies budget needs based on requirements in the Current Ship's Maintenance Project, Class Maintenance Plan, the Baseline Availability Work Package and historical data. The Maintenance Team identifies the total funding requirement to support the ship during the execution year, along with advance and availability planning and funding requirements for availabilities to be executed in future years. It also establishes the allocation of the "controls" or "phasing" plan that the team will utilize to support the ship.

- a. The Maintenance Team, with TYCOM N43 concurrence, has the ability to shift controls between the Chief of Naval Operations (CNO) availability and Continuous Maintenance budget lines in order to most efficiently accomplish required maintenance and modernization.
- b. The Maintenance Team, with TYCOM N43 concurrence, has the ability to adjust the Maintenance and Modernization Business Plan in response to changes in ship operations, planned maintenance periods and other business case reasons provided the intended distributions do not exceed the total remaining annual budget requirement allocated for that ship. This redistribution will be documented via a revised quarterly phasing plan, which will be submitted to the RMC, for approval and adjustment of the Maintenance Team controls. If funding controls permit, the Maintenance Team is permitted to accomplish maintenance that falls below the Maintenance Figure of Merit threshold provided the maintenance is accomplished during the most cost effective maintenance period available.
- c. Depot level maintenance will normally be screened to the Private Sector Industrial Activity (PSIA) contractor. The Maintenance Team may go to other contracting vehicles when there is no PSIA contract in place or:
 - (1) The contractor and Government cannot agree on cost and scope.
 - (2) The contractor does not have the capability or capacity.
 - (3) Indefinite Delivery, Indefinite Quantity/Commercial Industrial Services (or Simplified Acquisition Purchases and a qualified vendors list) is available.
 - (4) Other organic RMC assets are available and have the capability for the work.
 - (5) Work is to be accomplished outside of homeport area.
 - (6) Work is to be accomplished by an Alteration Installation Team.
- d. When work deferral reduces the total cost of the job or maintenance completes with a cost under-run and funds can be recaptured, the funding controls will normally remain under the control of the respective Maintenance Team. If the funds are needed for critical work on another ship or to cover a funding shortfall at the TYCOM/Fleet level, the RMC, with TYCOM concurrence, may redistribute or recapture controls from all or selected Maintenance Teams. The change will be documented in a revised quarterly phasing plan and the Maintenance Team(s) should provide to the RMC, and TYCOM, an impact statement and recommended plan to mitigate the effects of the plan change.
- e. PSIA contractors normally submit cost reports to Maintenance Teams on a bi-weekly basis. The Maintenance Team will utilize these reports to assess the cost performance of the PSIA contractor and address items of concern to the RMC.

6.6.2 Regional Maintenance Center Funding Business Rules Responsibilities.

- a. Based on input from the Maintenance Teams and the TYCOM regarding modernization requirements, the RMC Commander will develop a consolidated spending plan for the execution year.

- b. The RMC will evaluate Maintenance and Modernization Business Plan (MMBP) adjustment requests based on the Summary of Events, recovery plan, and quarterly adjustment provided by the Maintenance Teams. If the RMC supports the request but lacks the spending controls required, the RMC will forward the issue to the TYCOM for consideration and resolution.
- c. The RMC, with TYCOM N43 concurrence, has the ability to redistribute controls across the surface force ship Maintenance Teams for which he is responsible. The RMC shall inform the TYCOM whenever redistributions are required on any ship and shall obtain prior approval from the TYCOM when controls require adjustment in excess of twenty (20) percent. The RMC may not redistribute funds between Active Fleet and Reserve Fleet funding lines or between different TYCOMs. The RMC shall provide the TYCOM a record of all control changes for tracking purposes.
- d. In the event of significant program wide control changes the RMCs shall:
 - (1) Provide an impact statement to the TYCOM regarding the effect on the execution of maintenance.
 - (2) Provide a recommendation to minimize the impact on Force readiness.
- e. The RMC shall evaluate the financial status of each of the Maintenance Teams on a monthly basis.
- f. The RMC shall submit end of quarter financial summary reports to the respective surface TYCOM. This end of quarter report provides a comparison of actual versus planned funding execution. The last quarterly report for the execution year shall include an annual summary showing how the funds were utilized, sorted by Naval Operations resource sponsor.
- g. Normally, Emergency Maintenance funds will be used to fund C3 or C4 Casualty Report (CASREP) related maintenance. The RMC Commander has the authority and responsibility to determine when Emergency Maintenance funds should be used for the correction of C2 CASREPs or other non-CASREP related, but nonetheless urgent maintenance. The RMC Commander may, with the respective TYCOM's approval, use Emergency Maintenance funds to execute CNO availability or Continuous Maintenance.

6.6.3 Type Commander Responsibilities.

- a. The TYCOM will provide a list of Fleet Alteration requirements for the execution year as input to the RMC business plan no later than 15 February in the year prior to execution. To assist with business plan development, the TYCOM will identify which alterations are scheduled for accomplishment and will provide the RMC with the cost estimates for accomplishment.
- b. When the Fleet issues the spending controls to the TYCOM, the TYCOM will in turn issue spending controls to the RMC and update them on a quarterly basis.
- c. The TYCOM has the authority to recapture spending controls previously issued to the RMCs in response to unforeseen Force budget requirements.
- d. Funds will be provided to Maintenance Teams early enough to avoid premiums associated with late contract award or assignment of work.
- e. If it is determined that the best course of action is not to fund a CNO availability, the TYCOM must approve the removal of funds before the RMC initiates this action. The TYCOM shall ensure Program Executive Office, Ships are included in the decision process to not fund any availability where Program Alterations are scheduled for accomplishment during that availability.
- f. The TYCOM will evaluate MMBP adjustment requests forwarded by the RMC, based on the Summary of Events, recovery plan and quarterly adjustment provided by the Maintenance Team. If the TYCOM supports the request but lacks spending "controls" required, the TYCOM will forward the issue to the Fleet for approval and additional controls.
- g. The TYCOM will evaluate the RMCs end of quarter financial status report to assess the degree of conformance to the approved RMC consolidated spending plan.

6.7 FUNDING VIOLATION REPORTING. When an over-commitment, over-obligation, over-authorization or over-expenditure of funds occurs, the violation must be reported in accordance with reference (g). Reports of violations are unique when compared to routine reports required by other laws or regulations. Each report shall be submitted through the chain of command to the Assistant Secretary of the Navy (Financial Management and Comptroller), who will forward it through the DoD to Office of Management and Budget for transmission to the President. Copies of the report will also be forwarded to the President of the Senate and the Speaker of the House of Representatives.

6.8 FUNDING VIOLATION PENALTIES.

- a. RMC personnel must avoid violation of the funding regulations addressed in reference (a), (b), and (c). Penalties are contained in reference (d). For non-criminal acts, appropriate administrative discipline is required. This could include removal. For criminal acts, which must be proven to be knowing and willful, a fine of not more than \$5,000 and/or imprisonment for no more than two years is required.
- b. Penalties for violation of reference (e) are contained in reference (f). For non-criminal acts, appropriate administrative discipline that could include removal is required. For criminal acts that must be proven to be knowing and willful, a fine of not more than \$5,000 and/or imprisonment for no more than two years is required.

6.9 FUNDING METHODS AND ACCOUNTING.

6.9.1 Accounting and Reporting.

- a. STARS is the official accounting system for Navy organizations with funding and accounting detailed in reference (p). This system, plus other command unique accounting systems, will eventually be integrated into the overarching Navy Enterprise Resource Planning System.
- b. Financial managers may issue funds usage documents or provide funds to other financial managers through the Comptroller through various funding documents. FLTCOM funds are provided on OBs. Modernization funding from NAVSEA is provided on Project Directives.
- c. RMCs are responsible for performing local accounting of all funds granted for maintenance and modernization in addition to other funding sources. Each RMC Comptroller is responsible for recording commitment and obligation transactions, performing periodic reviews of un-liquidated obligations and unmatched disbursements, validating expenditures and advising the funds grantor of excess funds available for recapture.

6.9.2 Operating Budgets.

- a. Ship repair and modernization funds are typically transmitted by means of OBs. The basic policy of funding mission operations is by use of OBs through command lines. However, in some instances a Technical Operating Budget (TOB) may still be the funding vehicle. TOBs are apart from a regular operating budget and may be issued, by a claimant or expense limitation holder, to a RMC within the chain of command or across command lines that are issued for implementation and execution of a headquarters-administered, centrally managed procurement program. The OBs and TOBs, carrying the same obligation and expense authority, and are governed by the same administrative and statutory controls, including reference (e).
- b. The RMC is responsible for obligating transactions in the approved accounting system. The Authorized Accounting Agency (AAA) is responsible for posting expenditures. The Defense Finance and Accounting Service, Defense Accounting Office is the designated AAA for FLTCOM funds. The AAA will prepare and submit official accounting reports as required by references (i) through (l). The RMC should maintain only necessary records and should not duplicate records readily available through other accounting systems. RMCs receive many funds from NAVSEA and other users on various funding documents. The Fleet, via each individual Ships Maintenance Team annual MMBP approved by the TYCOM establishes planning estimates for anticipated requirements.

6.9.3 Reimbursable Orders. Reimbursable orders are written agreements between components of the Federal Government requiring the performance of work or services by one component and payment by the other component. Reimbursable orders are accepted in accordance with reference (l), Section V. All funded reimbursable orders are

subject to the recipient activity projecting that at least 51 percent of the funds will be used for “in-house” work. If less than 51 percent of the work will be in-house effort, the funding for tasks to be contracted out should be provided on a Request for Contractual Procurement. Reimbursable order accounting requires extra effort in supporting documentation and accounting workload.

6.9.4 Project Orders. A project order is provided on reference (s). It is a specific, definite and certain order issued under the authority contained in reference (m) for the production of material, repair, maintenance or overhaul or for other specific work and services. It serves to obligate appropriations and funds in the same manner as contracts with a commercial enterprise. Funds are not obligated until the performing activity signs acceptance of the project order. The accounting is the responsibility of the accepting activity. The funds provided on a project order cannot be exceeded without written amendment by the ordering activity. The funds provided by project order remain available for completion of the work or services requested regardless of the date the funds cited in the order expire. Research, Development, Test and Evaluation funds cannot be utilized on a Project Order.

6.9.5 Economy Act Order. An Economy Act Order, like the project order, is issued on reference (s). The order is issued, however, under the authority contained in reference (n) and is intended for work or services of a recurring nature where the scope of the work is not specific. These orders are for services such as janitorial work, utilities and transportation. The funds are not obligated until acceptance is signed by the performing activity. The accounting is the responsibility of the accepting activity. The funds provided by an Economy Act Order cannot be exceeded without written amendment by the ordering activity. The funds provided can only be charged during the fiscal year of the availability of the funds cited on the document.

6.9.6 Direct Citations. Direct citations are requests from one Government activity to another for material, equipment or services that provide appropriate accounting data. The performing activity will cite the requesting activity’s complete line of accounting data for any obligation or expenditure of funds. The accounting function will remain the responsibility of the requesting activity and it’s AAA. The funding cited on the document will not be exceeded without an amendment issued by the requesting activity. The funds retain all legal limitations that existed when the requesting activity accepted them.

6.9.7 Requests for Contractual Procurement. Requests for Contractual Procurement are issued on NAVCOMPT Form 2276. This document is issued when the receiving activity will contract out at least half of the work. The document becomes effective when the performing activity signs acceptance. The performing activity must comply with all restrictive statements contained in the document and ensure that confirmed copies of the contracts or orders that result are promptly provided to the requesting activity and it’s AAA for posting of obligations and expenditures. For funds received from other STARS/Human Capital Management users, a Project Directive is the preferred funding document in order to reduce memorandum accounting and reporting.

6.9.8 Letters of Authority. A Letter of Authority (LOA) can be used in funding work or services in instances when the activity requesting the work or services does not have the authority to issue a TOB and no other appropriate funding document can be identified for use. LOAs authorize the recipient to direct-cite the funds of the requesting activity on applicable financial documents. LOAs shall contain complete line of accounting data, a statement of the maximum dollar amount authorized and the purpose for which the LOA is issued. If the LOA requires requisitioning material from stock, a universal fund code should be provided. The LOA should be assigned a standard document number. The LOA must provide for acceptance by the performing activity. The document becomes effective when the performing activity signs acceptance. RMCs will promptly provide a copy of all financial documents issued to the requesting activity. Due to this requirement for official accounting at the source activity, the use of LOAs is minimized.

6.9.9 Orders Placed With Government Agencies. Orders required by law to be placed with Government agencies will be recorded as obligations at the time the orders are issued. This category includes orders placed with the General Services Administration, Federal Prison Industries, Government Printing Offices, Defense Supply Agency, printing plants authorized to be established by the Joint Committee on printing and the Navy Publications and Printing Service Management Office. Military Interdepartment Purchase Request, DD Form 448, is used for orders placed with non-Navy DoD activities.

6.10 GENERAL INFORMATION CONCERNING AVAILABILITY AND OBLIGATION OF FUNDS.

6.10.1 General. In funding an availability, RMCs should treat any contingent liabilities such as the difference between the Government estimate and a lower bid price, as commitments, rather than as obligations, in accordance with NAVCOMPT and DoD policy. The use of commitments will allow RMCs to encumber balances needed to finance future valid obligations and help to prevent possible Anti-Deficiency Act violations. Increases of ship work funds, if required, should be requested from the grantor of funds. If the increases are not granted, the work items to be included in the solicitation must be reduced in accordance with the priority requirements of the funds' grantor so the RMC estimate is equal to the funds authorized. Funds must be obligated at contract award. Contract solicitations may be advertised before receiving funding authorization when there is reasonable expectation that the requirements are firm and valid. The award of a contract or job order can in no case be made in excess of the funds available.

- a. Reference (o) requires that funds current at the start of a major availability must finance the cost of the modernization or repair, including all scope-of-effort changes necessary to complete it. Material requisitions entered into the supply system after normal expiration of the funds must cite the law. This provision does not apply to availability or modernization efforts not directly related to the completion of the modernization availability. This provision extends the fiscal year availability of induction-appropriated funds for overhaul scope-of-effort changes from one year to indefinite availability. Changes authorized within the scope of the job order for other than a major availability are chargeable to the funds supporting the job order.
- b. Un-priced contract or job order modifications cannot be executed when the RMC estimate exceeds the funds available. It is extremely important that un-obligated funds be returned to the grantor of funds as soon as the excess can be identified so that the funds may be applied to other requirements before expiration. If funds are required for the authorization of changes after the end of the fiscal year, the funds will be requested from the fund's grantor when an upward obligation has been approved. Job order modifications that are outside the scope of the job order are chargeable to funds current at the time the modification is authorized.

6.10.2 Effects of the Grassley Amendment. The Grassley Amendment requires the validation of obligations in the accounting systems before making a payment to the contractor. This validation applies to all invoices contractors submit (New Construction and Repair), regardless of the value of an invoice. When the accounting system finds a matching obligation, it moves it into the accounts payable account and freezes the account. This action prevents the account from being reduced until payment is made. A delay of several weeks in payment to the contractor may result. If payment is late, no interest is paid on progress payments. Because progress payments are made for the contractor's financial convenience, no interest is paid. Payments are most often made late for the following reasons:

- a. Improper or late distribution of contracts.
- b. Direct Cite Funding - Most payment problems arise in this category. The funding activity inputs obligations for direct cite lines of accounting. If the obligation is not input or is input incorrectly, the RMC cannot correct the obligation. The reason is the RMC does not have access to the funding activity's Unit Identification Code in the accounting systems. Thus the Defense Finance and Accounting Service office must obtain a guarantee from the activity that the obligation is awaiting payment.
- c. Delete Modifications - Contractors tend to ignore "delete" modifications or bill them at a much later date. When validation is attempted, insufficient funds are available. The result is the contractor has to resubmit the invoice.
- d. Misapplied Payments - Misapplied payments are the most time-consuming reason for late processing of invoices. The processing of previous payments to the wrong line of accounting results in insufficient funds. It often takes a great deal of time to identify and correct the problem.

VOLUME VII
CHAPTER 7
AVAILABILITY AND PROJECT MANAGEMENT

REFERENCES.

- (a) NAVSEAINST 5370.1 - Standards of Conduct and Statements of Affiliations and Financial Interests
- (b) NMCARS 5233.9000 - Documentation of Significant Contract Events
- (c) NAVSEA SI 009-04 - Quality Management System
- (d) NAVSEA SL720-AA-MAN-030 - Navy Modernization Process Management and Operations Manual
- (e) NAVSEA Technical Specification 9090-100 - Planning Yard (PY) Representatives
- (f) NAVSEAINST 4710.8 - Cost and Performance Reporting for CNO Scheduled Ship Maintenance Availabilities
- (g) NAVSEA OP-4 - Ammunition Afloat
- (h) NAVSEA SI 009-01 - General Criteria; Accomplish
- (i) NAVSEA SI 009-08 - Fire Fighting and Fire Prevention
- (j) NAVSEA SI 009-07 - Procedures and Equipment Required for the Prevention of Fire
- (k) DFARS 252.217-7015 - Compliance With OSHA Regulations
- (l) NAVSEA S9086-7G-STM-000 - NSTM Chapter 997 (Drydocking of Naval Vessels)
- (m) 10 USC 7311 - Repair or Maintenance of Naval Vessels: Handling of Hazardous Waste
- (n) FMP Manual Section 4-11 - Procedures for Ships Selected Records
- (o) FAR 4.802 - Contract Files
- (p) NAVSEA SI 0009-60 - Schedule and Associated Reports for Availabilities over 9 Weeks in Duration
- (q) FAR 52.232-16 - Progress Payments Clause
- (r) 31 USC 1517 - Prohibited Obligations and Expenditures
- (s) 31 USC 1301(a) - Application
- (t) DFARS 252.217-7012 - Master Ship Repair Agreement (MSRA) Liability and Insurance

LISTING OF APPENDICES.

- A Arrival Conference Agenda
- B Fire Fighting and Fire Prevention Conference Agenda
- C Drydocking Conference Agenda
- D "Activity" Progressing Method Example
- E Progress Guidelines

7.1 **PURPOSE.** This chapter provides general guidance concerning the statutory and contractual requirements for management of availabilities and emergent work on Fleet units. In this chapter, the term Project Manager refers to the individual that has been assigned the administrative and statutory authority for the management of an availability or an assigned project that is to be or has been awarded as a contract. This chapter focuses on the management team and in particular addresses the fact that the Project Manager and the Contracting Officer (Procuring Contracting Officer (PCO) and Administrative Contracting Officer (ACO)) for the assigned project or availability must have a strong communications network through various commands and individuals who assist them in exercising their responsibility.

7.2 **GENERAL.**

- a. The awarded contract establishes the rights and obligations of the contractor and the Government. The Government's actions or inactions in performing responsibilities such as providing Government Furnished Information and Government Furnished Material (GFM) to support the contractors' schedules, approving or disapproving of contractors' requested contractual actions, responding to contractor reports and participating in conferences to discuss technical and contractual issues as well as performance, could have a significant impact on the contractors' ability to perform contract requirements. These responsibilities make the Government an active participant in the management of the contract.

- b. The execution of any availability or contract with the private sector requires personnel with special training in their select area of responsibility when it applies to the administration of contracts.

7.2.1 Areas of Responsibility. Two of the more important general areas of responsibility are:

- a. Personal conduct in working with the contractor to ensure that the terms and conditions of the contract are complied with.
- b. The necessity to validate observations and maintain accurate records of these observations in “significant events” logs that include action that was taken to resolve the issues.

7.2.2 Standards of Conduct in Availability Management. All personnel engaged in matters related to contractual action must be familiar with and comply with the Standards of Conduct, avoiding not only situations involving an actual conflict of interest, but also any appearance of such a conflict. Personnel performing certain functions in the Regional Maintenance Centers (RMC) must submit the Status of Filing Report, RCS NAVSEA 5370-2, by 15 November of each year in accordance with reference (a).

7.2.3 Improper Actions. While participating in the management of a contract, personnel must avoid certain actions even if not specifically prohibited. Command instructions provide in-depth guidance on personal conduct including regulations concerning fraud, waste and abuse. Personnel involved in Contract Administration or Availability Management shall avoid any actions that might create the appearance of:

- a. Using a Government office for private gain.
- b. Giving preferential treatment to any person or entity.
- c. Impeding Government efficiency or economy.
- d. Losing complete independence or impartiality.
- e. Making a Government decision outside official channels that might affect public confidence in the integrity of the Government.

7.2.4 Documenting Significant Events. This is one of the most significant actions that every member of the availability management team shall comply with. Significant events are personal observations of conditions or actions by or to any party to the contract which would affect the performance of the contract.

- a. Reference (b) requires that “significant events” be recorded to assist in maintaining adequate documentation to be used to verify, qualify or refute matters relating to a contractor’s claim or Request for Equitable Adjustment (REA). The documentation of “significant events” is required for all contracts in excess of \$5 million or for which a claim is expected. A claim can be expected against any contract associated with ship modernization and repair. All Government personnel who are responsible for observing a contractors’ performance, production processes, observing “G” check points and monitoring operational tests and evaluations shall document their observations and maintain a continuous real time notebook of significant events. Notebooks shall be turned over to the ACO, via the Project Manager, at the completion of the availability.
- b. The contracting officer retains this documentation in the “Significant Events” file. All Government personnel involved in the performance of such contracts shall maintain this continuous real time notebook to record significant events that occur during the contract period.
- c. The significant events file and related documentation allows the Government to support or refute claims, terminations of contracts, settlements and determinations or to provide evidence for litigation to investigative bodies, as required. They also include written records of nonconformities in work progress and accomplishment. Contract related documentation such as correspondence, meeting minutes, labor records, material purchase orders, project schedules, schedule updates, productivity data and project monitoring information form the basis for the assertion or rebuttal of a claim. This information is beneficial in documenting the contractors’ performance reported in the Contractors Performance Appraisal Reporting System (CPARS) submitted at the conclusion of the performance period.

- d. The individual's significant events notebook should be a ledger-type, bound notebook having sequentially numbered pages. Events shall be recorded in black ink as they occur. Each recorded event shall indicate the date, time and a brief but complete description of the event. No page shall be removed. Mistakes shall be deleted with only a single line through the text and initialed, permitting an unobstructed view of the mistake. This notebook and related memoranda will become a part of the "Significant Events" file and will be marked "FOR OFFICIAL USE ONLY."

7.3 PROJECT MANAGEMENT.

7.3.1 Project Management Team. The Project Management Team as defined in Volume VI, Chapter 41 of this manual is included in the advanced planning processes as well as the contract type to be awarded. The Project Team for availability must be designated well in advance to preserve the continuity of the planning and execution phases of the acquisition process. The Project Manager, Comptroller, Support Staff and the Contracting Officer and their assigned teams shall coordinate their actions. The overall Project Management Team is accountable, and in some cases liable, for administering the contract and associated contractor and Government actions following award and throughout the contract execution phase as specified in the period of performance. The Government's Project Management Team shall insure that the contractors' performance complies with the specific terms and conditions of the contract and that the services are provided at a fair and reasonable price.

7.3.2 Project Manager. The Project Manager is the individual who is responsible for the management of the Project Team during an availability or emergent unscheduled work. The Project Manager is assigned by the Commanding Officer (CO) of the RMC and is the coordinator of the on-site shipbuilding specialist team. The authority of the Project Manager shall be clearly defined, identified to all concerned, and in particular the Contractor in relation to contract administration. Duties of this position include but are not limited to the following:

- a. Acts as business agent with other activities on availabilities and contracts assigned that includes ensuring that Type Commander (TYCOM) funds are utilized properly.
- b. Maintains liaison with customers, the ships Maintenance Team, Ship's Force Representatives, RMC functional departments, financial/accounting personnel and contractor.
- c. Acts as assistant funds administrator (when designated in writing from the RMC CO) for assigned availabilities and contracts.
- d. Coordinates planning and cost estimating and design specification preparation and scheduling.
- e. Reviews specifications to ensure completeness and conformance with authorized work.
- f. Arranges and conducts the Arrival Conference, weekly progress conferences and attends or arranges for RMC representation at all conferences pertaining to assigned availabilities and contracts.
- g. Evaluates all Technical Analysis Reports (TAR) and supports the Contracting Officer in contract negotiations.
- h. Evaluates and acts on the reports received from other members of the availability management team.
- i. Manages ship repair and modernization work items, job orders and contracts assigned by progressing and evaluating all work to anticipate, prevent and minimize delays, resolving all problems that affect the end cost, quality, schedule and performance of assigned availability or contract.
- j. Prepares reports on current status of assigned project or contract.
- k. Coordinates the on-site work effort in observing the contractor's in process production performance and operational testing events for projects assigned to the team.
- l. Acts as the availability management team point of contact for outside agencies seeking information relating to the project, the contractors performance or technical issues under review.
- m. Attends on-site meetings to provide comprehensive information to all concerned and to remain current in all aspects of the project.
- n. Reviews all work accomplished by assigned Shipbuilding Specialists to ensure compliance with regulations, directives, instructions and policies as well as to ensure that intended work is practical and necessary.

- o. Identifies and initiates action to correct, prevent and minimize delays, resolving all problems that affect quality, schedule and contractor performance.
- p. Reviews contractors work schedules, manning curves, material ordering/receipt schedules and special tasking/equipment requirements. Evaluates contractors' proposals prior to and during contract execution. Takes corrective actions to eliminate conflicts and prevent work stoppages.
- q. Performs all administrative duties and actions normally assigned to a supervisor.
- r. Maintains a Significant Event Log.
- s. Participates in the "Hot Wash Up/Lessons Learned Conference" following the completion of a major availability and in support of availability planning, execution and close out.
- t. Provide written reports to the Contracting Officer for Award Fee Evaluations Private Sector Industrial Activity (PSIA) contracts.
- u. Prepares CPARS for Chief of Naval Operations (CNO) Availabilities.
- v. Project Manager records to be passed to the Contracting Officer should include but are not limited to the following:
 - (1) Correspondence files containing copies of all correspondence to the Contracts Office both internal and external.
 - (2) Work authorizations for growth and new work. Work authorizations may be in the form of naval messages, Speed Letters, letters, other transmittals or documents. In the case of growth work, the authorization may be verbal, a memo at a meeting or a telephone call. Verbal authorizations should be documented with a Memorandum for the Record.
 - (3) The Project Manager shall maintain a ledger notebook to assist in funds administration. For each contract modification initiated in the work package, the Project Manager shall show the title of the item, cite the proper funding authorization and account and show the Government estimate. The ledger shall show funds committed and obligated for each contract modification and other financial transactions and provide an indication of funds available for future use. When changes occur during the negotiation process, the funds reserved or obligated shall be changed to reflect the current funding status. Periodically, at least monthly, the Project Manager shall reconcile ledger accounts with the Contracting Officer and Comptrollers' accounts to ensure that funds are not over obligated or expended.
 - (4) Material requisitions for GFM with prices.
 - (5) Project orders and economy act orders issued to other Government activities.
 - (6) Completion reports.
 - (7) Departure reports including summary costs of individual work items.
 - (8) All significant events logs from the shipbuilding specialist.

7.3.2.1 Material Expediter. The RMC will normally assign a material expediter to monitor the GFM that has been ordered for an availability or project. The material expediter, working with the RMC Material Personnel, Fleet Logistics Center (FLC) Representatives and contractor should be able to provide the current status of GFM, but will challenge the system to improve delivery dates or identify alternative sources to satisfy production schedule requirements.

7.3.3 Ashore Ships Maintenance Manager. As defined in Volume VI of this manual, the Ashore Ships Maintenance Manager for each ship is responsible for identifying the extent of modernization and repair to be addressed in the specification package to be awarded to a private contractor. The Ashore Ships Maintenance Manager works with the Project Manager in the day-to-day activity of work execution that is being performed on the ship by all activities. The Project Manager and the TYCOM shall approve new work items that have the potential to impact the schedule, finances or other aspects of the progression of the availability and the completion date. Generally, the Project Team supports accomplishing additional work items or contract modifications through the contracting

officer only when on-site inspection of actual material conditions supports a need for repairs to meet the established operational performance criteria following the availability. During contract performance, contractors are not to accomplish new work or growth work without authorization from the Contracting Officer. For Surface Force ships only, the Naval Supervisory Authority Chief Engineer will review requested growth and new work items for technical compliance. The Systems Command/TYCOM will authorize or reject each new work candidate submitted. The Ashore Ships Maintenance Manager's primary input on all matters related to Combat System integration, modernization and Combat Systems Light-off and testing schedules will be from the AEGIS Combat Systems Project Engineer, as assigned.

7.3.4 Shipbuilding Specialists. Shipbuilding Specialists are individuals that possess a primary trade background but effectively perform across trade lines in two or more trade skill disciplines. Team assignments are made to balance trade expertise appropriately with the type of work in the project. A wide variety of comprehensive duties and responsibilities are assigned to these individuals who are expected to act as decision makers with comprehensive knowledge of each work item assigned. Typical assignments include the following duties and responsibilities (as with Project Managers, this may vary depending on the supporting organization):

- a. Provides current information relating to assigned work items to the team leader who is usually a Project Manager.
- b. Attends meetings, resolves production problems, develops scope of work requirements, assists in the development of Government TARs and negotiation positions, assesses contractor capabilities, work progress and performance, provides technical support to the ACO, participates in claims avoidance and provides other technical support as required.
- c. Interfaces with members of the Ship's Force to provide current project information, notifies responsible personnel of scheduled evolutions and solicits required or desirable Ship's Force.
- d. Receives and investigates contractor reports, assists with the development of the Government's technical response, requests engineering support, prepares necessary contract modifications, develops the Government cost estimates, estimates the delay and disruption that may occur because of a contract modification, assists with negotiation preparation relative to TARs and contract modifications (as authorized by the ACO), provides the ACO support in negotiations and maintains records of actions taken.
- e. Perform/witness Government "G" notification points, identified in the work specifications, when the contractor calls them out. Accomplish random Product Verification Inspections (PVI) utilizing checklists or an attribute system to determine contractor compliance with the quality and technical requirements of the work specifications/contract. Write a Corrective Action Request when nonconformities are detected in accordance with Chapter 11 of this volume.
- f. Participates in various Government evolutions such as boat inspections, hull inspections, combat systems inspections, drydocking and undocking, habitability inspections, pre-Light Off Assessments and other evolutions that may require or benefit from technical trade expertise.
- g. Determines the physical progress, as a percentage of work completed, of each work item and each contract modification assigned. This information is updated weekly in a comprehensive progress report that is used in calculating the contractor's entitlement to progress payments as well as in evaluating the contractor's schedule performance.
- h. Monitors the GFM and Contractor Furnished Material (CFM) report to anticipate actions that may be necessary to preclude schedule impact by unsatisfactory material delivery dates and initiates material orders to replace unsatisfactory GFM or to provide items with unique Government control and confirms the necessity for the contractor to make cash purchases from the Naval Supply system when it is in the best interest of the Government.
- i. Monitors the contract guarantee period to help determine whether failure of equipment or systems covered by the guarantee clause is the responsibility of the Government or the contractor, ensures that the work determined by the ACO to be the responsibility of the contractor, whether it is covered by guarantee or was an exception to the completion of the contract, is repaired in accordance with the

specification requirements and provides cost estimates for incomplete work so that the ACO can ensure that appropriate contract funds are retained in the event that the work must be deleted from the contract requirements or be procured from another contractor.

- j. Provides positive lessons learned along with feedback related to deficient or inefficient work specifications or work authorizations to the appropriate planning group for use in improving future procurements.
- k. Conducts oversight coordination and inspection of work-related environmental issues associated with Ship's Force and contractor's operations. This effort includes but is not limited to hazardous material (HAZMAT) and hazardous waste (HW) handling, removal, storage, transportation and disposal.
- l. Conducts safety inspections jointly with the contractor, Ship's Force and Government Environmental Safety and Health (ESH) Representative(s).
- m. Maintains a Significant Events Log.
- n. Provides written reports to support Award Fee Evaluations and CPARS.
- o. Shall maintain the following records:
 - (1) Work item specifications, references and estimates for the work package, updated to reflect all modifications.
 - (2) Contractor condition reports including Government replies.
 - (3) New work identified and not authorized.
 - (4) GFM delivery status.
 - (5) Quality Assurance (QA) records.
 - (6) Records relating to the contractor's capabilities and capacity.
 - (7) Contractor performance evaluations.

7.3.5 Quality Assurance Manager. The RMC QA Manager will administer the Contract Administration Quality Assurance Program outlined in Chapter 11 of this Volume to evaluate the effectiveness of the Contractor's Quality Management System on work being performed both shipboard and in the contractor's/subcontractor's plant. Shipbuilding Specialists and/or Quality Assurance Specialists will conduct and document in-process inspections (PVI) of the contractor's/subcontractor's work, attend "G" point call outs and, if appropriate, document a Corrective Action Request when the contractor fails to satisfy contractual quality and technical requirements. In addition, Shipbuilding Specialists/Quality Assurance Specialists on site maintain a significant events log and provide written documentation that supports Award Fee Evaluations and CPARS.

7.3.5.1 Contractor Quality Management System. The contractor is required by the contract to have a government approved Quality Management System that meets the requirements of reference (c). The Quality Management System is an ISO 9001 based quality system that includes a staff and an inspection system with procedures to ensure that all of the terms and conditions identified in the work specification/contract requirements are adequately met. The goal is to ensure the contractor inspects its own work and inspects and accepts the work of subcontractors before presenting it to the Government for acceptance.

7.3.5.2 Alteration Installation Teams. Alteration Installation Teams (AIT) are activities tasked by a Naval Sea Systems Command (NAVSEA), Program Executive Office or TYCOM to accomplish an alteration under Government authorization and supervision. Reference (d) provides requirements for the planning, estimating, programming, budgeting, scheduling, funding, design and accomplishment of alterations as well as the Quality System to be used during accomplishment of such work. Whenever an alteration, to be accomplished by an AIT, is scheduled for an availability, AIT coordination with the RMC and Project Manager is required from planning through installation and testing.

7.4 CONTRACT ADMINISTRATION TEAM. The Contracts Administration Team assists the Project Manager and consists of the Administrative Contracting Officer, Contract Program Managers, Contracting Specialists, Cost Monitors and others as are necessary for a specific project. The main types of contracts administered are cost reimbursable contracts and fixed price contracts.

- a. Cost reimbursable contracts require functional expertise and sufficient contract administration staffing to monitor the contractor's actions and validate that the terms and conditions of the contract have been complied with. The level of effort shall include frequent and unscheduled observations to preclude incurring unnecessary costs by inefficient or excessive performance of contract requirements. This action is required since the contractor is reimbursed for cost of labor expenditures based on the accounting documented in the contractor's performance measurement system (time keeping documentation) and material costs incurred during the execution phase of the contract. The Defense Contract Audit Agency audit results shall be utilized to assist with validating observations of manpower utilization. The accounting for labor and material charges is essential when a contractor is working both cost reimbursable and fixed priced contracts in their facility. Any proposed change by the contractor should have a TAR prepared with all details of the Contractor's proposed change available for Project Managers and Contracting Officer to use in the negotiation process. Since the contractor will be reimbursed for all allowable costs incurred, most of the risk in a cost type contract is on the Government.
- b. Firm Fixed Price contracts, particularly those with short durations, may require more technical personnel during the performance period because contract modifications that may be essential to the accomplishment of the intent of the contract must be quickly identified and resolved to minimize costly delay and disruption to the contractor's schedule. After award, changes are negotiated on a sole source basis. These contractor-developed reports require time-consuming investigation and a timely written response to the contractor and each could result in a contract modification. In this situation significant effort must be expended by Government technical personnel to develop a reasonable Government position and, when required, a TAR for negotiation of the cost of the change. Under these conditions, the contractor's negotiation position is significantly strengthened. It may be difficult to reach an equitable position on the cost of the change. Government's action or inaction has the potential to create increased costs to the Government. Additionally, because of the risk on the contractor, efforts to minimize costs associated with a fixed price contract could result in poor compliance with requirements of the contract that in turn will require more contract supervision and performance monitoring.

7.4.1 Administrative Contracting Officer. Chapters 1 and 2 of this Volume provide extensive coverage on contracting and the contract administration responsibilities. After a contract has been awarded for ship repair or modernization, only the assigned warranted ACO, within the designated limit of the warrant, may change the terms or conditions of the contract or make a contractual commitment on behalf of the Government. In RMCs, the Contracts Department Head, Code 400, is the senior contracting officer within the Command with the inherent authority and responsibility for the day-to-day administrative contracting functions. The Contracts Department Head may appoint subordinates to perform some or all of the functions of administering a specific contract whose authority is contingent upon the individual's warranted authority from NAVSEA. Typically, the ACO is assisted by a Contracts Specialist and Cost Monitor who reside in close proximity to the location where the availability is being performed. Administrative functions may be delegated to individuals with special technical or trade skill backgrounds who will obtain or have received additional training in the relevant contract administration areas including the Defense Acquisition Workforce Improvement Act (DAWIA) process so that they can function as a Contracting Officers Representative. The complex technical requirements of ship repair and modernization require the assignment of trade skill and technical personnel from a variety of functional disciplines who must work closely with the Project Manager and Contracting Officer to ensure that the specified terms and conditions of the contract are complied with and that upon final closure of the contract there are no non-conformant or exceptions to the work items except those that have been approved for deviation or waiver by the Contracting Officer.

7.4.2 Commercial Industrial Services Contract Program Managers. The Commercial Industrial Services (CIS) Program/Indefinite Delivery, Indefinite Quantity (IDIQ) Contract Managers administer the CIS program or IDIQ Contracts. The managers are part of the availability management organization due to technical determinations required and the need to recognize and coordinate interfaces to preclude contract delay and disruptions. Consolidation in one office provides the most efficient organization. Duties and responsibilities of a CIS/IDIQ Program Manager are:

- a. Represents the command and acts as the command point of contact in all matters pertaining to the contract.
- b. Chairs the IDIQ Contract Advance Planning Committee to review current contracts and to determine the need for and propriety of additional contracts.

- c. Coordinates daily program operations.
- d. Manages and coordinates requirements with Project Managers to resolve schedule conflicts and interface problems with other contracts and activities.
- e. Performs the duties and responsibilities of the Assistant Funds Administrator for all IDIQ Contracts.
- f. Accepts or rejects the request for work based on the scope of work required, the necessity of the work requested, the appropriateness of the contracts or program and the capacity of the contractor.
- g. Determines the scope of the actual work requirements to develop the Government position.
- h. Makes ordering decisions such as grouping the work with other requests, assessing the time available and time required to accommodate the contracted performance period, determining other work to be scheduled in the area, identifying interface requirements with other scheduled work, assessing how the work will impact the contractor's capacity to complete other work ordered and deciding whether to order against an existing IDIQ contract, propose the use of an appropriate Master Ship Repair Agreement (MSRA)/Agreement for Boat Repair (ABR) job order or initiate a one-time procurement with FLC or the RMC Contracts Department.
- i. Coordinates preparation of the specification package to provide to the appropriate procurement office.
- j. Authorizes and initiates contract changes with the ACO to accomplish growth within the scope of the work authorized.
- k. Performs contract department duties in the acceptance of work.
- l. Provides support to the ACO in negotiations and the resolution of contractor claims.

7.4.3 Contract Specialist. The ACO duties parallel the responsibilities of the Contracting Officer but their authority is limited as specified by the level of their DAWIA qualifications level of authority, specific limitations of their warrant and specific assignments made by the Contracting Officer. The ACO is assisted by warranted, DAWIA qualified personnel, who are assigned specific responsibilities for processing contractual issues and to assist with the management and administration of a contract.

7.4.4 Cost Monitors. Working directly for the Contracting Officer and administratively with the RMC Comptroller, these personnel primarily function in the capacity of "keeping the books" that track the financial status of each project. Following contract award, all contract changes shall be reviewed by the assigned cost monitor who will work directly with the Contracting Officer who is designated as the Funds Administrator and who is accountable for financial management and obligating the Government funds that are provided to the contractor.

7.4.5 Navy Property Administrator for Contracts. The Navy Property Administrator, assigned by official appointment from the RMC Contracting Officer, is responsible for all Government property related to a specific contract including GFM, CFM for which the Navy claims title and material removed from the ship by contract requirements. The disposition of salvage and scrap material is determined by the Property Administrator in accordance with Chapter 9 of this Volume. The Property Administrator screens work specification clauses to determine the contractor's responsibility for Government property. Generally, the contractor is responsible for the proper care and protection of all Government property in the contractor's custody. The contract will not be closed until the contractor has accounted for all Government property or the Government has received acceptable consideration.

7.4.6 Allowance Specialist. The Allowance Specialist is responsible for allowance list corrections made necessary by modifications to existing equipment or the substitution of new for old equipment during an availability. The Allowance Specialist screens work specifications and identifies necessary changes.

7.4.7 Accounting Technician. The Comptroller assigns specific accounting responsibilities to an Accounting Technician knowledgeable of the type of funds and cost codes applicable to each availability or project who works closely with the contract Cost Monitor, Project Manager and Contracting Officer. The Accounting Technician is the only official source for obtaining a balance for a given account. Delegated Funds Administrators for each availability should establish a close working relationship with their assigned Accounting Technicians.

7.5 SUPPORT STAFF.

7.5.1 Functional Support Staff. Typically the waterfront receives significant support from technical and functional specialists who support several availabilities and special projects.

7.5.2 Design Coordinator. When workload permits, an engineer or engineering technician, accountable to RMC Chief Engineer, will be assigned the responsibility of coordinating requests for all design assistance to resolve technical problems identified during performance of the contract that are not the responsibility of the Planning Yard (PY). The waterfront design coordinator assigned to the availability or project arranges for the appropriate engineering discipline to investigate the identified problems and provide engineering guidance. Maintains a significant events log and when appropriate provides reports to support Award Fee Evaluations and CPARS.

7.5.3 Planners and Estimators. Government trade skilled and technical personnel are assigned to prepare work specifications, in accordance with Chapter 4 Appendix E of this Volume (4E specification procedures), and planning estimates. They are also responsible to identify material requirements for a solicitation when responsibility for this task is not assigned to a contractor as in the case with the PSIA contract. They may also be tasked to assist with the preparation of TARs for work items to support the Contracting Officers negotiations. These personnel may be required to prepare work specifications for essential growth and new work authorized during the performance of an existing contract or may be required to perform work on-site in order to resolve production problems.

7.5.4 Combat Systems Managers/Representatives. Electronics Engineers or Electronics Technicians with experience in the various disciplines involved in combat systems are assigned to availabilities that include significant combat systems requirements. These specialists monitor the contractor's performance of work and testing in the combat systems work package. The combat systems representative provides expert advice in the anticipation, identification and resolution of problems that may occur during the maintenance, repair and alteration installation phases, as well as during the grooming and complex systems level testing phases. RMCs may assign Electronics Engineers or Technicians as Combat Systems Managers for the availability. The Combat Systems Managers take a more active role by accomplishing duties similar to those of Production Controllers/Ship Surveyors/Shipbuilding Specialists in addition to those of Electronics Engineers or Technicians for combat systems work items during an availability or project. Combat Systems Managers responsibilities include the following:

- a. Provide current information relating to assigned work items to the Project Manager. This may also include reports to the ship's assigned Port Engineer for Combat Systems.
- b. Attend meetings to resolve production problems, develops scope of work requirements, assists in the development of TARs to support the Government negotiation positions, assesses contractor capabilities, work progress and performance, provides technical support to the ACO, participates in claims avoidance and provides other technical support as required.
- c. Interface with members of the Ship's Force to provide current project information, notifies cognizant personnel of scheduled evolutions, solicits required or desirable Ship's Force participation and provides technical advice.
- d. Receive and investigate contractor reports, writes and receives answers to Liaison Action Reports, provide interim answers to Test Problem Reports, assist in developing the Government's technical response to contractor requests, assist the TAR writer by providing engineering support and in developing the Government cost estimates, assist in preparing necessary contract modifications, estimate the delay and disruption that may occur because of a contract modification, provide the ACO support in negotiations and maintains records of actions taken.
- e. Observes "G" POINTS for electronic systems and equipment identified in the work specifications when they are presented by the contractor, witnesses required equipment or system tests and accomplishes random in-process inspections (PVI) at the work sites to determine contractor compliance with the requirements of the specification. Documents the contractor's failure to satisfy contractual responsibilities.
- f. Determine the physical progress, as a percentage of work completed, of each work item and each contract modification assigned. This information is updated weekly in a comprehensive progress report that is used in calculating the contractor's entitlement to progress payments as well as in evaluating the contractor's schedule performance.

- g. Monitor the GFM and CFM report to anticipate actions that may be necessary to preclude schedule impact by unsatisfactory material delivery dates. Assist the FLC or RMC Material Department in visually identifying and verifying receipt of GFM. Initiate material orders to replace unsatisfactory GFM or to provide items with unique Government control and authorizes the contractor to make cash purchases from the Naval Supply system when it is in the best interest of the Government.
- h. Monitor the contract guarantee period to help determine whether failure of equipment or systems covered by the guarantee clause is the responsibility of the Government or the contractor. Ensure that the work determined by the ACO to be the responsibility of the contractor, whether it is covered by guarantee or was an exception to the completion of the contract, is repaired in accordance with the specification requirements. Provide cost estimates for incomplete work so that the ACO can ensure that appropriate contract funds are retained in the event that the work must be deleted from the contract requirements or be re-procured.
- i. Provide lessons learned and feedback related to deficient or inefficient work specifications or work authorizations to the appropriate planning group for use in improving future procurements.
- j. Maintains a Significant Events Log.
- k. Coordinate the efforts of the MSRA/ABR and each combat systems related AIT.
- l. The Combat Systems Manager is the primary point of contact for combat systems technical issues during the availability that arise with other technical organizations.
- m. Participate in the "Hot Wash Up/Lessons Learned Conference" following the completion of a major availability and in support of availability advanced and pre-planning, integration, execution and close out.
- n. Provide written reports to support Award Fee Evaluations and CPARS.

7.5.5 Manager - Environment Compliance and Occupational Safety and Health Act. The Manager for ESH may have subordinate Safety Inspectors and Environmental Compliance Representatives in addition to the Shipbuilding Specialist who also perform similar observations. The ESH Manager assists the availability management team in understanding and recognizing obligations of the contractor and the Government. The Safety Officer shall be the first point of contact in matters relating to the safety of people and equipment; environmental issues, such as oil spills or other contamination of the water; asbestos and ceramic fiber insulation control and all HW control. Any personnel injuries occurring at the work site (whether Government or contractor, military or civilian) shall be immediately reported to the Safety Officer. Unresolved issues noted in the daily safety and housekeeping walk-through or as required by contract shall be referred to the Safety Officer for assistance or resolution as appropriate. All observed or suspected safety or environment violations or any related issue shall be brought to the immediate attention of the Manager for ESH. The Manager for ESH reports directly to the CO of the RMC on safety-related matters and on environmental and other related matters. The Manager for ESH maintains a significant event's log and provides written reports to support Award Fee Evaluations and CPARS. Detailed information on this subject is contained in Chapter 10 of this Volume.

7.5.6 Technical Representatives from Other Activities. Throughout the availability there are typically a large number of other Government activities that are participants in the execution phase of a contract. It is essential that these activities be identified prior to commencement of the performance period and they must comply with all of the contractor's security requirements prior to gaining access into the production facility. These activities should designate one individual as the Point Of Contact to facilitate coordination of their work or involvement with the contractor's production, to interface with the RMC Contracting Officer, Project Manager and Ship's Maintenance Team/Maintenance Manager, and for coordination and attendance at appropriate progress and production status meeting.

7.5.7 Planning Yard Technical Representative. The PY provides technical liaison services regarding PY drawings or technical documentation. The PY Technical Representative provides additional information or interpretation of PY drawings and technical documents, resolves requests for drawing changes, waivers or deviations and initiates drawing changes when the change is approved by the PY. PY liaison requirements are addressed in reference (e).

7.6 AVAILABILITY PERFORMANCE.

7.6.1 Preparation for a Contracted Availability. The Contracting Officer that is charged with the responsibility and accountability, in accordance with Federal Acquisition Regulation (FAR) and Defense Federal Acquisition Regulation Supplement (DFARS), to assure that the contractor is prepared to execute the availability or project in accordance with any previous agreements and the specific terms and conditions of the specifications for the availability. The level of effort that is required to administer a contract depends on numerous factors that include the completeness of the advanced planning effort, the type of contract, level of effort and complexity of the modernization package, performance period versus size of the total work package including forces afloat work and key events and seasonal consideration during the production phase. Once the work package is defined and the contract solicited when required, outside of the PSIA concept, there is sufficient cause to involve the other participants in preparations for the availability at the earliest opportunity. Contract administration personnel should be assigned as early as possible. If the availability is not with a PSIA contract, the Project Manager and as many other key personnel as possible shall be assigned to the availability in time to participate in the contract award phase.

7.6.2 Pre-Award Survey. In some instances, the PCO may direct a full or modified pre-award survey to assess areas where past performance has been less than satisfactory as noted in previous CPARS or other documents. When the PCO directs a full or limited Pre-Award Survey of the apparent low bidder, RMC personnel may be assigned to participate in the survey, particularly for those contractor(s) selected for award of Master Agreement for Repair and Alteration of Vessels job orders. An in depth Pre-Award Survey is most often not required for contractors who hold a PSIA Contract or MSRA or ABR due in part to their compliance with the Agreement Process plus the familiarity of the PCO and ACO with the capabilities and past performance of the contractor. This familiarity with a specific contractor does not relieve the PCO of the accountability attendant to making the award. The Project Manager shall participate as a minimum. In addition to being able to comment knowledgeably on the contractor's qualifications and readiness for performance of the work, the survey team members may gain additional insights about the contractor's approach to accomplishing the work which will facilitate the management of the contract.

7.6.3 Readiness to Start. A "Readiness to Start" report is required by reference (f) and shall be prepared by the assigned Project Manager. In some projects or availabilities it may be necessary to obtain written pre-availability agreement(s) initiated by the executing activity with the customer(s) or other Department of Defense activities and the status of any required agreement(s) should be addressed as well.

7.6.4 Work Specification Review. Where there is a PSIA contract, the Ship's Management Team/Ashore Ships Maintenance Manager and other personnel assigned for availability management shall review the work specifications as well as all references to understand the full scope of the work package details and to identify discrepancies and areas of concern. For non-PSIA contracts, the Planning Activity and other personnel, as required, should conduct the specification review procedures that are outlined in Chapter 4 of this Volume. The planning objective should be to have the executing activity participate in the pre-award specification review. If such participation is not possible, at the earliest opportunity personnel charged with administering the specifications of the contract shall review and familiarize themselves with the specification package. Every detail that could have a negative impact on the performance schedule, quality of work or cost must be identified early so that intelligent decisions can be made to remove work from the contract, modify work requirements in the contract or add essential work necessary to accomplish the intent of the work authorized. Personnel may be able to recognize potential contract deficiencies from familiarity with the contractor's practices or from experience with a class of ships or a particular ship. Early action on the part of the Government helps to minimize the impact of contract modifications on the contractor's schedule and the final contract price.

7.6.5 Ammunition Off-Load Prior to an Industrial Availability. In general, to obtain maximum safety during industrial work periods, all or most of the ammunition should be off-loaded prior to the commencement of work during a scheduled availability unless there is a specific waiver approved. The specific off-load requirements will be in accordance with the instructions of the TYCOM, the Senior Officer Present Afloat, the Commander of the Naval Base or Naval Station and local port regulations. Ships and crafts entering contractors' facilities for a period in excess of six weeks shall offload all ammunition and other explosive materials except for those for Anti-Terrorism Force Protection. Navy units entering contractor's or Naval Station facilities for industrial work periods of less than six weeks will provide data required for necessary waivers in accordance with reference (g). The message should identify appropriate work boundaries with respect to ammunition storage areas (e.g., ammunition

and other HAZMAT must be separated from hot work by one compartment, tank or void (two bulkheads or two decks), a minimum of 20 feet and when such work does not result in heating the exterior boundary surface of the separated compartment, tank or void).

7.6.6 Fuel Off-Load Prior to an Industrial Availability. Surface force ships and aircraft carriers should enter any significant availability with a maximum fuel load of 15-20 percent unless there is an approved waiver to enter with more fuel onboard. The extent of this requirement will be determined by the nature and magnitude of work to be accomplished. Tanks that will be directly involved or in known or anticipated hot work boundaries should be at low suction levels. It is difficult, very costly and disruptive to off-load and transport or even shift fluids during any availability, especially in a contractor's facility that has the potential to result in a REA or even a claim for delay and/or disruption. The RMC shall advise the ship of specific off-load or transfer requirements sufficiently in advance of the availability start to allow the ship to schedule and accomplish the required effort.

7.6.7 Berthing of Ship and Crew.

- a. Messing and berthing, transportation and other related issues that impact the quality of life of the crew must be anticipated during the availability planning period and provisions made to satisfy the requirements in accordance with current United States Fleet Forces Command instructions. The designated Planning Activity or Maintenance Team (MT) have the responsibility to determine if the authorized work package will render the ship or a part of the ship uninhabitable. If any off-ship berthing is authorized, the Project Manager must verify that there is adequate funding and consult with Ship's Force prior to making final arrangements for acceptable berthing and messing for the duration of the uninhabitable conditions.
- b. Any requirement to be satisfied by the contractor must be included in the specification work package. If the availability is to be conducted in the contractor's facility, arrangements must be made for a safe and timely transfer of the ship into the contractor's facility and for the immediate connection of utilities and services. The MSRA and PSIA Contract requires the contractor to make provisions for the personnel assigned to the ship to have access to the ship at all times. Contract requirements shall state that the contractor not interfere with the normal berthing and messing of personnel attached to the ship. If the crew will be berthed off of the ship, written agreements should be established clearly identifying what is being provided, the responsibilities of the provider of the facilities and the responsibilities of the crew. Normally, the crew will be responsible for all routine maintenance and housekeeping that would be accomplished on the ship. Conditions existing in the facilities prior to use by the crew must be carefully documented to resolve questions that may arise when the crew leaves the facility. It is the RMC's responsibility to ensure a smooth transition with a minimum loss of time for the crew during the move and to validate arrangements for transportation of the crew to and from the ship when the crew is berthed off of the ship or to and from meals when the ship is unable to prepare meals because of authorized contractor work in the messing facilities or support systems.

7.6.8 Contractor's Assumption of Responsibility. If availability is to be accomplished in a contractor's facility, the contractor's responsibility for the ship will commence when the contractor's tugs accept the ship's lines or the contractor's line handlers accept the ship's lines at the contractor's pier. Except as otherwise specified in the contract or job order, the contractor will furnish all necessary labor, material, services, equipment, supplies, power, accessories, facilities and other supplies and services as are necessary for accomplishing the work specified in the job order.

7.6.9 Security.

- a. Force Protection and physical security within the contractor's facility is the contractor's responsibility in accordance with the requirements outlined in the contract or job order. The contractor must establish and maintain a personnel identification system, control visitor access to the facility and control the receipt and removal of property from the facility. Government personnel, when in the contractor's facility, must comply with the contractor's security regulations. If the Government wants physical security arrangements other than those the contractor is required to provide, then the requirement must be authorized by the funds grantor, funded and added to the contract requirements. Additional security requirements could include such items as security guards in Ship's Force parking areas, barriers to preclude access to the ship by unauthorized waterborne craft or the patrol of water approaches to the contractor's facility.

- b. Both the contractor and RMC must provide personnel access lists to the ship that identify security clearances and the nationality of assigned personnel. The contractor must also provide access lists for subcontractors. The contractor should provide sample identification badges including those of subcontractors to Ship's Force to facilitate worker identification and access. Foreign nationals are not permitted to work on naval vessels without a waiver approved by the RMC. A workable procedure for granting contractors and other non-Ship's Force personnel access to the ship and work areas on the ship must be established by the ship's CO prior to the start of work. The RMC and Ship's Force, working together with the contractor, must ensure that the contractor's performance schedule is not delayed or disrupted because workers were not given access to the ship or the work site in a reasonable time.
- c. The contractor, like Government personnel, must also comply with the requirements of the Industrial Security Manual. Prior to contract award, the Contracting Officer is required to validate that the contractor and/or the designated subcontractor possesses the appropriate up to date documentation that specifies the level of security clearance that the contractor has been authorized, and to verify that he is authorized to have access to classified material and spaces as specified in the contract and that the contract does not require a clearance level that exceeds the level of classification which is documented. In this regard, the contractor is responsible for ensuring that personnel with appropriate security clearances are assigned for work in classified areas, on classified equipment or on work requiring the use of classified information. The Project Manager must ensure that appropriate clearance letters are provided to the ship, both for RMC and contractor personnel. Reference (h) provides the requirements for the contractor to obtain access to classified spaces or materials.
- d. During an industrial availability, the ship's CO remains responsible for the security of the ship and the material and equipment onboard. Ship's Force should be reminded to provide for the safeguarding of pilferable items onboard. Likewise, the contract administration team shall be alert for potential breaches in security and the inappropriate handling and unauthorized access to classified material.

7.6.10 Special Events During Availabilities. When special events such as changes of command, special training or drills are to be conducted by Ship's Force, readiness for light off, etc. are anticipated during an availability, certain contractual and administrative safeguards shall be used to preclude the potential for the contractor to submit REAs or claims for delay and disruption to the contract that resulted from Government actions that were not covered by the specification package or prior arrangements to minimize impacts on production.

7.7 SCHEDULED CONFERENCES AND MEETINGS. Conferences and meetings should be requested any time there is a perceived need to resolve matters concerning the scope of work, a quality or safety issue, a schedule or progress issue, or to coordinate or harmonize the participants in the availability. Certain regularly scheduled meetings may require participation by managers with decision-making authority.

7.7.1 Arrival Conference. The Project Manager arranges and conducts an Arrival Conference on the ship's arrival for the availability or immediately preceding the availability if the ship is available. The arrival conference is a two-part meeting attended by RMC representatives, the Maintenance Team members, other ship representatives, other Government representatives with an interest in the availability and the contractor. Contractor representatives shall not attend the part of the conference on Government issues and funding. The purpose of the Arrival Conference is to:

- a. Introduce the key personnel involved and explain their roles and responsibilities.
- b. Discuss specific work items and explain the impact of the Standard Items referenced.
- c. Discuss local policies and procedures.
- d. Explain constructive changes and discuss avoidance techniques.
- e. Explain procedures for the acceptance of contractor work.
- f. Review the schedule and the availability execution "game plan".
- g. Define growth and new work and the impact of each.
- h. Discuss the scheduling interface requirements between contractor and Ship's Force work, as well as Government events.
- i. Discuss fire watches, housekeeping and other matters pertinent to the availability.

- j. Explain the contractor's plan, procedures, schedules and key events.
- k. Describe contractor-furnished facilities and services.
- l. Describe contractor fire watch requirements.
- m. Discuss safety, housekeeping, and environmental policies and procedures, as well as other pertinent issues requiring clarification.
- n. Establish the ship's security requirements for personnel access to the ship. A typical agenda for an Arrival Conference is provided in Appendix A.

7.7.2 Weekly Commanding Officer's Conference.

- a. A briefing report of the results of the weekly progress meeting and other issues of significance to the Government including AIT progress, safety issues, environmental compliance, physical security and funding status may be required for review by the RMC CO. The Project Manager will conduct the brief. The brief will address the results of the progress meeting and specific high visibility problems and actions planned or requested to resolve the problems. Based on this report and the comments and positions of the various Government representatives, the CO will approve the planned actions or direct other action as needed. After each briefing concerning the status of the overall availability has been presented, the RMC CO may conduct a Weekly Conference with all or selected COs of ships in current availabilities. The purpose of this conference is to give both the RMC CO and the ship COs an opportunity to discuss availability issues face-to-face and resolve the significant differences that may exist. The RMC CO will present a current status report to the ship's CO on the high visibility issues, and the CO will in turn address the customers' concerns to the RMC.
- b. The CO of the ship is required by Navy regulations to be aware of the status of the ship at all times, and during a depot-level availability the ship's CO should pay particular attention to work being performed by Ship's Force, the Government's shore maintenance activity, CIS/IDIQ contractors, AITs and others as well as the ship repair contractor. Therefore, in advance of the Weekly Conferences, the ship's CO should conduct a shipboard meeting with the Project Team, MT, Ship's Force availability managers and department heads to obtain a current assessment of the status of the overall availability. Through such meetings, the ship's CO should be sufficiently well informed to contribute meaningfully to the substance of the Weekly Conferences.
- c. The Weekly Conference is an integral part of the weekly routine established for availability management. The routine will not be the same at all RMCs, nor for that matter need it be the same for each availability. Typically, the routine will include the following:
 - (1) The week begins by assessing the weekend's activities and planning for activities to be accomplished during the week ahead. Typically, individual work items that must be progressed that week are assessed on Monday and Tuesday, and during this time preparations are made for the progress meeting.
 - (2) The availability progress meeting is typically held during the middle part of the week as previously discussed. On Wednesday or Thursday, the RMC and senior staff are briefed and actions are taken to affect the plans approved or directed. In the latter part of the week, the Weekly Conference is held with the ship's CO. On Friday, required availability status reports are prepared and forwarded as required.

7.8 AVAILABILITY MANAGEMENT.

7.8.1 Quality Assurance.

- a. The contractor is required by reference (c) to maintain a quality management system. The Contract Administration Quality Assurance Program is addressed in Chapter 11 of this volume. The contractor is responsible for offering to the Government for acceptance, only products that conform to required quality standards and for maintaining and furnishing substantial evidence of this conformance.
- b. The work item specifications include "G" points at selected points in the performance requirements. The purpose of the "G" point is to require the contractor to give the designated RMC Representative advance notification of the event noted in the "G" point. Having such advance notification gives the

Government the option of concurrently witnessing the contractor's performance at the "G" point. "G" points are included in work items for all important tests or inspections, at critical points in the repair process or at points where the next step in the performance will conceal critical work accomplished.

7.8.2 Constructive Changes. A constructive change to a contract occurs whenever the Government, through its action or lack of required action, causes the contractor to depart from plan or perform other than as specified in the contract. During the performance period of the contract, the on-site team must exercise great care to minimize the impact of constructive changes. Constructive changes are discussed in detail in Chapter 2 of this volume.

7.8.3 Work Stoppage. The contractor cannot be directed to stop work by anyone other than the ACO or another authorized contracting officer with one exception. The only exception to this requirement is to protect the safety of personnel or prevent the loss of or destruction of property and equipment. Because the Government is a self-insurer or may otherwise be liable for some portion of large insurance claims, the Government has a vested interest in any conditions or actions of the contractor or the contractor's employees which may lead to an insurance claim. The Government is liable for the loss or damage of Government property in excess of the specified limits in the contract. Further, the Government may be liable in situations where third party claims against the contractor exceed the contractor's commercial insurance coverage. Government employees involved in the availability shall be vigilant and, when necessary, act to correct situations or conditions which could easily lead to personnel injury or damage to Government property. In situations where the loss of or damage to Government property is imminent and economically significant, the Government employee should act immediately to stop the work in progress or otherwise correct or rectify the cause of the problem. Likewise, if unsafe conditions or contractor work practices are observed which could lead to imminent injury to personnel or loss of life, the Government employee should act to stop the unsafe practice, correct the condition or otherwise remove the imminent threat. In situations where the danger or potential for loss or damage is not imminent, the Government employee should refer the matter to the appropriate Supervisor Shipbuilding Specialist or Project Manager for action.

7.8.4 Award Fee Board Conferences. An Award Fee Board Conference is required for all Cost-Plus-Award-Fee contracts. An appointed Award Fee Board representing NAVSEA, the ACO, the RMC and customers, chaired by the Waterfront Operations Department Head, convenes to hear presentations from the on-site Project Management Team and the contractor. The Board then evaluates the contractor's performance against established award fee criteria and determines the amount of award fee to which the contractor is entitled for a set period of contract performance.

7.8.5 Fire Fighting and Fire Prevention Conference. When the ship enters the contractor's facility for availability, the contractor is required by reference (i) to conduct a Fire Fighting and Fire Prevention Conference. This conference should be attended by RMC representatives, Ship's Force representatives, contractor representatives and a representative from the municipal or other local fire fighting organization, as applicable, if possible. This conference must be conducted within five days after arrival at the contractor's facility. The meeting familiarizes the Ship's Force with the contractor's procedures for fire prevention and fire fighting, as well as the procedures used by the local fire fighting organizations. The contractor and the local fire fighting organization should be familiarized with the ship's fire fighting systems and plans. Appendix B provides a list of subjects that must be addressed.

7.8.6 Fire Prevention, Safety and Housekeeping.

- a. The contractor must comply with the Occupational Safety and Health Administration (OSHA) under the cognizance of the United States Department of Labor. The RMC Representative for Occupational Safety and Health, who is typically the Command Safety Officer, or the designated Safety Office Representative for the ship, monitors the contractor's compliance with OSHA requirements. This monitoring function is passed from Department of Labor to agencies that provide Contract Administration Services. Any Government employee that observes an accident, a fire, an unsafe act, or unsafe or hazardous conditions on or around the work site should immediately inform the RMC Safety Office and provide as many pertinent details as possible. The designated Safety Office will investigate all incidents and issue the required reports. When deemed necessary, an investigative team may be required to prepare findings for the Judge Advocate General. All Government personnel will cooperate fully with the Judge Advocate General investigators.
- b. In addition to the Federal, state and local laws and ordinances, contract clauses require the contractor to exercise reasonable care to protect the vessel and Government property. These clauses also require the contractor to keep the site of the work on the vessel free from the accumulation of waste material or

rubbish caused by its employees or the work, and at the completion of the work to remove all rubbish from and about the site of the work and leave the work in its immediate vicinity "broom clean" unless more exactly specified in the job order or contract specifications.

- c. In addition to the contract clauses, reference (j) specifies procedures and equipment required for the prevention of fire. These requirements address the gas-free checking of tanks, the training and use of fire watches, the use of fire retardant materials, the conduct of daily fire prevention and housekeeping inspections and the establishment and maintenance of fire zone boundaries. When the ship is in a contractor's facility reference (i) requires the contractor to provide fire protection capabilities in addition to the OSHA requirements, including a requirement to conduct the Fire Fighting and Fire Prevention Conference.

7.8.7 Fire Watches. The contractor is required by OSHA and references (j) and (k) to provide fire watches for contractor hot work. The ship's CO is always responsible for the safety of the ship and crew and may desire to supplement the contractor's system with additional fire watches or establish a fire watch monitoring system. In some cases the TYCOM may direct the Ship's Force to provide fire watch personnel to save Government funds.

7.8.8 Docking Conference. When the ship is required to be drydocked during availability, a Docking Conference is scheduled by the dockmaster or the RMC docking officer. This conference is held onboard or near the ship, conducted by the dockmaster or docking officer and attended by the Project Manager, the ship's CO, Project Team, the MT and Ship's Force representatives, particularly the Engineer Officer and Damage Control Assistant, and the contractor's dockmaster and other cognizant personnel. The details of determining the docking position, establishing the stability conditions before docking and undocking, and defining safety and service requirements are discussed as well as responsibilities for a ship's movement in and out of dock. A typical agenda for a Docking Conference is provided in Appendix C.

7.8.9 Drydocking.

- a. Reference (l) provides procedures for the safe drydocking and undocking of Navy Ships. Drydocking requirements are included as a work item in the contract and identify the required drydock position and other pertinent information for docking the ship. The details of drydocking the ship, the stability conditions that must be established and requirements for the protection of underwater projections are discussed at the Drydocking Conference. The RMC is represented at all drydock evolutions by an experienced dockmaster, a docking officer or both. In addition, experienced RMC docking observers should monitor docking evolutions.
- b. When docking in a contractor's facility, the contractor assumes the duties and responsibilities that Navy Regulations prescribe for the docking officer. The ship is under operational control of the contractor's dockmaster while the ship is in the drydock and while the ship is entering or leaving the drydock. For safety, while the ship is under the operational control of the dockmaster, the Ship's Force must comply with dockmaster's requests. The only time that the Government shall interfere with the dockmaster's operational control of the ship is in the case of dire circumstances involving the safety of the ship.
- c. As soon as practical after the ship is safely positioned on the blocks and the water is removed from the drydock, the ship's underwater hull should receive a cursory inspection by the ship's MT/Maintenance Manager to include the ship's Chief Engineer, dockmaster, and other interested parties to identify additional work that may be mandatory. After the underwater hull has been cleaned, a more comprehensive underwater hull inspection is accomplished by the Project Manager, engineers, Shipbuilding Specialists, dockmaster, the ship's CO, Ashore Ships Maintenance Manager, ship's engineer, other representatives and the contractor's cognizant personnel. This inspection is a detailed inspection to document the condition of the underwater hull, the underwater machinery, all projections and underwater devices, and the effectiveness of the cathodic protection system and to determine if the contract paint requirements for the underwater hull will be sufficient.
- d. Before undocking, the Ship's Force must notify the RMC and dockmaster of significant changes in stability factors created by Ship's Force actions. This information is provided to the contractor and will be included by both the RMC and the contractor in stability calculations for the ship to determine if corrections are needed for a safe undocking. Ship's Force will be advised of necessary actions required, if any.

- e. When all drydock work is completed, a joint walk through is conducted by the MT/Maintenance Manager, Project Manager, and the contractors to ensure that all work is complete and all openings have been properly closed. Ship's Force monitors all underwater valves and openings such as propulsion shafting seals to ensure watertight integrity while the drydock is being flooded.

7.8.10 Hazardous Material.

- a. HW means any discarded material (liquid, solid or gaseous) that may, because of quantity, concentration, or physical or chemical characteristics, cause or significantly contribute to an increase in mortality or in serious irreversible or incapacitating reversible illness, or pose a substantial present or potential hazard to human health or the environment when improperly treated, stored, transported, disposed or otherwise managed (excluding infectious or radioactive waste provided that neither is mixed with Environmental Protection Agency/state-regulated HW), or any material designated as HW by the Environmental Protection Agency (EPA), the state or local regulations. Chapter 10 of this volume outlines the policy and RMC oversight functions for environmental matters.
- b. The CO of RMC shall appoint by letter the Manager for Environmental Protection. The Manager provides information on the identification of HAZMAT and HW to coordinate storage, control and handling procedures required by current applicable Federal, state and local regulations. They also will identify types and amounts of HW expected to be generated by Ships' Force, Navy Fleet Maintenance Activities or other Navy personnel during the availability. AITs are accountable for HW handling that is generated in the course of their work.
- c. Reference (m), and applicable state laws define the responsibilities of the generator in the disposal of HW. HW is listed in three types of waste: contractor-generated, Navy-generated and co-generated. All HW/HAZMAT identified for disposal will be transferred to an authorized disposal site through an HW manifest identified with an EPA generator number. When the ship is located in the contractor's facility, the contractor is tasked to handle all HW generated during the contract. The RMC furnishes an EPA generator number for use by the contractor in the disposal of Navy and co-generated HW. When the ship is located at a Government facility, Navy-generated HW is handled by the local Navy public works center. Contractor-generated HW is handled by the contractor using the contractor's EPA generator number. Co-generated HW is handled by the contractor with the RMC furnishing a Government EPA generator number for use in the disposal in concert with the contractor's EPA generator number. HW training for Ship's Force is available through the Manager for Environmental Protection.
- d. COs of naval vessels will be responsible for removing known HW, including expired shelf life material, from the vessel before the contract start date or the vessel's arrival at a contractor's facility, whichever is earlier, to the extent such removal is feasible. Because the disposal of HW is difficult and costly, and to reduce the adverse impact of HAZMAT and HW, Ship's Force will maintain the absolute minimum inventory of HAZMAT and will offload HAZMAT and HW in excess of minimum requirements.

7.8.11 Government Furnished Material.

- a. If material is available in a Government supply system, GFM identified by the Planning Activity is ordered from the providing source. If GFM requirements are not available from a Government source or exceed the purchase limitation authority of the RMC, the material requirement must be forwarded to a local Naval Supply Systems Command contracting office for procurement. The RMC material department may receive and store GFM and subsequently issues this material to the contractor.
- b. The status of GFM and CFM is monitored by the on-site team and discussed at progress meetings. Material status reports are developed and maintained by material expeditors who should also attend progress meetings and work closely with the RMC on-site team in locating required material. Every effort should be made to resolve material shortages before shortages affect the production schedule. Techniques such as changing GFM to CFM, when it has been determined that the contractor can find an alternate source for late GFM are appropriate if a Government-responsible delay in the contractor's schedule can be avoided.
- c. After the award of the contract, the contractor may discover that material that was commercially available during the pre-award period is no longer available. Although under most circumstances the contractor remains responsible for the potential impact of late or missing CFM, it is still in the best

interest of the Government to work with the contractor to resolve CFM problems. If the contractor can show that for unforeseeable and unusual conditions the material that should have been available is no longer commercially available, then the contractor may be entitled to an equitable adjustment in contract price and delivery schedule for the adverse impact. In any event, if the Government can mitigate the adverse impact, it is best to do so. Assistance to the contractor can include the following:

- (1) When required materials are delayed at a subcontractor's plant over which another Defense Contract Management Agency Contract Administration Office has cognizance, the RMC may request assistance from that office in expediting delivery of the materials. If the original subcontractor or supplier is unable to deliver the required materials and the prime contractor has been unable to locate an alternate supplier, the RMC may provide the names of other sources or may contact the local Defense Contract Management Agency office for the names and addresses of firms which may be able to provide the desired material.
 - (2) Authorize, by means of a contract modification, the use of substitute material if the substitution will not degrade the work. The job order modification authorizing the substitution will reflect an appropriate change in the job order price for any increased or decreased cost to the contractor. The material may be obtained directly from Ship's Force stores or other afloat vessels, from Government Supply Systems or from the Navy Supply System under the Navy Cash Sales Program.
 - (3) Convert the CFM to GFM by means of a job order modification, if the Government has the material available and the modification results in a decrease in job order price, which is negotiated on the basis of what it would have cost the contractor to procure the material from commercial sources. This procedure will be used as a last resort and only after a determination is made by the ACO.
 - (4) In some extreme cases and with TYCOM approval, the material may be obtained by cannibalization from other ships.
 - (5) The RMC should determine if the needed material is available in the Navy Supply System. If the material can be located, then a decision must be made whether or not to authorize the contractor to make a cash sale procurement. When possible, a cash sale procurement by the contractor is the preferred alternative since the contractor will remain responsible for any potential schedule impact. The cash sale procedure requires the contractor to complete a form which identifies the item and the vendor's price and requests that the item be provided as a cash sale from the Navy Supply System. Items obtained through the cash sales program cannot exceed a cost of \$5,000. A member of the Governments' on-site team certifies the requirement, and the RMC material department then verifies the information provided by the contractor and certifies that the material is required and not available commercially. The contractor may then procure the material from the Navy source at a cost of the higher of either the vendor's price or the Navy list price.
- d. The material office may also procure services, within given limitations, in support of a specific ship availability, such as the services of a manufacturer's technical representative to provide technical assistance to RMC personnel.

7.8.12 Testing of Ship's Systems and Equipment. The Ship's Force will operate all systems and equipment installed in the ship for testing or any other purpose. The contractor is not permitted to operate installed ship's systems or equipment for any purpose. The RMC should impress upon Ship's Force personnel the importance of this contractual obligation. Failure in this matter may lead to delay, disruption and claims against the Government. Detailed guidance on testing is provided in Volume IV of this manual.

7.8.13 Ship's Selected Records. The MT/Ashore Ships Maintenance Manager is required to assist Ship's Force to obtain the required documentation that includes:

- a. Ship's Selected Records (SSR) contain significant technical information on the ship's operation, maintenance, supply and other logistic requirements and are maintained current throughout the life cycle of the ship. SSRs are comprised of:

- (1) Selected Record Drawings: Consist of basic hull, mechanical and equipment drawings and are selected for their reference value for operational, maintenance, training and consulting purposes.
 - (2) Selected Record Data: Consist of basic technical information relative to certain shipboard arrangements, equipment and systems under the cognizance of NAVSEA that is selected because of its value for operational, maintenance, training and consulting purposes.
 - (3) Allowance Lists: Depict authorized onboard repair parts and equipment support of shipboard equipment and components and are published as a Consolidated Shipboard Allowance List. The Consolidated Shipboard Allowance List also includes authorization for non-component-related equipment and miscellaneous categories of material.
- b. The delivery of this documentation is required before the TYCOM/RMC will accept redelivery of the ship to the Fleet. Detailed SSR update procedures are addressed in reference (n).

7.8.14 Documentation. The contracting officer is required to maintain contract files as prescribed in reference (o). Chapter 2 of this Volume provides detailed information on the responsibilities of the Contracting Officer. The ACO is required to document each contract transaction sufficiently to provide a complete history of actions taken. The ACO's files provide background information supporting actions taken, provide information for reviews and investigations, and document the essential facts to support potential litigation. Some of the more significant data that should be found in the ACO's files include the following:

- a. A copy of the contract and all modifications with copies of supporting documents.
- b. Pre-award survey information.
- c. Progressing, expediting and production surveillance records. All documents that are considered pertinent from the Project Manager, Shipbuilding Specialist and other project members.
- d. QA records.
- e. Property administration records.
- f. Documentation regarding termination actions for which the contract administration office is responsible.
- g. A cross-reference to other pertinent documents that are filed elsewhere.
- h. Significant Events files from all sources.
- i. Copy of the CPARS.

7.8.15 Fast Cruise, Dock Trials and Sea Trials. Information on these subjects is available in Volume II of this manual.

7.9 AVAILABILITY PROCESSES.

7.9.1 Schedules. Availability scheduling is governed by the processes outlined in Volume II of this manual. The contract will have a start date and a completion date (Period of Performance) for the work specified in the contract. These dates will be determined with input from the TYCOM. Considerations will be based on the type and magnitude of the work to be accomplished, as well as other factors such as port workload and the ship's scheduled events. The dates may or may not coincide with the assigned availability. Fleet Commanders or TYCOMs are authorized to delay or advance scheduled starting dates up to five weeks and delay completion up to five weeks from the latest approved date. The TYCOM's authority to delay or advance starting dates and delay completion dates is limited to 15 days from the latest approved date. The RMC must concur and the modified starting dates must remain in the same fiscal year as the original dates. Early completion of availabilities may be authorized by the Fleet Commanders or TYCOMs if so designated. Changes in the start and completion dates of complex overhauls which will exceed established CNO duration must be approved by CNO.

- a. The Navy's ship repair scheduling requirements included in reference (p) are network based and the methodology is commonly described as the Critical Path Method (CPM).
- b. In developing a CPM schedule, the key steps include:

- (1) Generation of a listing of project related activities.
 - (2) Arranging the activities in a network strictly on the basis of the logic of assembly showing the relationships of all the tasks/activities required to complete the project.
 - (3) Identifying each activity by narrative description and an event numbering system.
 - (4) Estimating and assigning time durations to each activity (except for dummy activities).
 - (5) Setting the time boundaries or limits for each activity by accomplishing basic CPM computations known as the forward pass and backward pass.
 - (6) Computing the amount of float or slack that the various activities in the network possess.
- c. An activity is any portion of a project which consumes time and/or resources and has a definable beginning and end. The Critical Path is defined as that sequence of activities, which forms the longest duration and directly affects the completion date of an availability. It depicts the project's activity sequence and interdependency allowing determination of project duration, start and finish dates and project end date. Since a CPM schedule is network-based, and since the project's Critical Path is along a path of activities, the identification of critical activities' logic "relationships" or interdependencies within the network is vital to the legitimacy of the schedule. A logic "relationship" defines the relationship between two activities identifying when one can start in relation to another. For example, a Finish-to-Start logic relationship requires that the succeeding activity cannot start before the preceding activity has finished. The network provides a graphic display showing the planned sequence and interdependent relationship of activities, milestones and key events within a Job Order. It identifies the work that is sequential and the work that can be done in parallel. The network must not have loops. The total number of days that a path of activities can be delayed without affecting the project finish date is known as Total Float. Total Float is the difference between Early Start (ES) and Late Start (LS) or between Early Finish (EF) and Late Finish (LF) dates (i.e., $TF=LS-ES$ or $LF-EF$).
- d. Distributing the number of persons on a project so as to optimize performance is known as manpower leveling. Generally, ship repair and new construction contractors forecast the required manpower and then level it. Prior to leveling the manpower on a project, it must first be determined what the manpower requirements are at the activity level. In this regard, it is useful to determine the total number by discipline or trade for each project day, week and month based on all the activities being performed at their early start-finish dates. Then it is possible to estimate total reasonable levels. To understand manpower leveling in conjunction with CPM scheduling, it is necessary to understand that an activity with float time is permitted to start somewhere between its ES and LS dates. Float is the scheduling tool or the wherewithal of resource leveling. For by judicious allocation of float, the peaks of manpower and equipment required to execute the project are reduced while still completing the project on schedule. An alternative method of manpower leveling is the sequencing of key resources through the addition of crew movement constraints to the network.
- e. The contractor may have developed the best possible schedule with input from various specialists regarding activity content, sequencing, duration and manning estimates. But unless the project's performance is measured against the schedule, you will never know where the project is and, most important, where it is going. To this end, it becomes necessary to track actual progress against planned progress.
- f. If it becomes apparent that the contractor is falling behind in some areas of the availability with regard to the established percentage of schedule completion, controlling work items or non-achievement of specified key dates or milestones, the RMC should apprise the contractor of this fact and request remedial action. The RMC should ensure that the contractor is informed of this fact sufficiently in advance of the scheduled completion date to permit the necessary action to be taken. Among the remedies which may be available to the contractor are multi-shift work, overtime and the employment of additional workers. When addressing this subject with the contractor, the Government shall take great care to ensure that the contractor cannot interpret the discussion as an "order" from the Government to accelerate the work. Other alternatives to explore to determine whether time can be recovered include re-sequencing of activities, reduction in durations and deletion of work, if feasible. The Government cannot order acceleration without incurring the risk of a claim from the contractor.

Therefore, the contractor should specifically be advised that the Government is not ordering acceleration, that the responsibility for acceleration, if it is undertaken, remains solely with the contractor and that any acceleration ordered by the Government will be in the form of a contract modification.

- g. In addressing schedule adherence with the contractor, the Government must also assess the impact of Government actions or failures to act, when required, on the contractor's performance. If the Government is responsible for even a small portion of the perceived delay or for disruption which has caused the delay in performance of scheduled work, then that issue should be addressed in a contract modification to properly compensate the contractor for the required acceleration to recover and maintain schedule adherence.
- h. If the contractor alone is responsible for failure to produce as scheduled and such failure is viewed by the RMC as significant enough to place availability completion in jeopardy, then the Government concerns should be conveyed in writing to the contractor. Such a letter can be referred to as a "View with Concern" or "View with Alarm" letter, depending on the degree of severity of the contractor's situation. In the letter, the RMC should identify the areas of concern and how the Government "views" the situation and offer perceived reasons for the situation. The contractor should also be requested to provide a written response to the letter, identifying action the contractor proposes to take to prevent delay in completing the availability. Where the contractor insists that work can be completed on schedule without acceleration or other measures involving added cost, the Government cannot direct the contractor to perform otherwise. Any direction contrary to the contractor's plan will generally result in an REA or a subsequent claim.
- i. While the contractor is trying to recover from poor schedule adherence, the Government should be as cooperative as possible, doing all that needs to be done to make it possible for the contractor to recover on its own. If it becomes clear that the contractor is not performing in a manner that will allow completion on schedule, a meeting should be convened with the contractor's top-level managers and the contracting officer. At this meeting, the contracting officer should again convey the Government's concern over the contractor's lack of progress and discuss the specific issues of concern. The contractor should be requested to address the specific issues causing problems, including the contractor's view of the cause of the problem. If the contractor identifies the Government as the primary cause of the schedule slippage, the issues raised must be addressed by the contracting officer. If the RMC agrees with the contractor that the Government is a party to the schedule delay following review of the contractor's contemporary schedule and cost documentation, then action must be taken to compensate the contractor for the impact. If the Government does not agree with the contractor about responsibility for the schedule slippage, then the contracting officer must make this view clear to the contractor. The meeting should result in an agreement about the actions to be taken to ensure availability completion on schedule. In the very worst of cases, termination should be considered. Otherwise, the results of the meeting should be documented in a letter from the contracting officer to the contractor. This letter should document the relative positions of the parties to the contract where there is disagreement and document the agreement made. This letter serves to place the matter on a business-like footing, documents the contract file for future reference and should be used in future pre-award surveys in assessing the contractor's past performance.
- j. Personnel attached to the ship may not unduly interfere with the contractor's work or the contractor's employees. The contractor is obligated to accomplish the work specified by the contract within the dates specified by the contract. Therefore, when progress is impeded by some action or lack of required action on the part of the Government that will cause delay or disruption in the contractor's scheduled work, the contractor will generally be entitled to an equitable adjustment in contract price and delivery schedule. This will be resolved by awarding the contractor compensation in the form of additional time or additional money or both as agreed by the parties.
- k. A detailed schedule of the work to be accomplished by Ship's Force should be developed as well as the work that will be accomplished by other activities not under the control of the RMC. The complexity of this schedule will be determined by the resources that the ship can apply, the magnitude of work and interfaces and the perceived need. Automated scheduling systems may be made available to the ship. However, as a minimum, a simple bar chart schedule or GANTT chart should be developed and

maintained by Ship's Force to assist in working around the contractor's schedule whenever possible. On occasion, Ship's Force will not be able to work around the schedule, and in such cases, the RMC must work with the contractor for resolution and coordination. Reference (p) requires the contractor to provide a representative whose only function is to coordinate Ship's Force work with contractor work. In addition to the representative being required to meet daily with the Ship's Force coordinator, the representative among other things, is required to submit weekly a report of conflicts where programmed Ship's Force work interferes with the contractor's schedule. When the RMC or the Ship's Force becomes aware of approaching disruptive events (e.g., work schedule conflict, planned power outages, drills, visits, Change of Commands) the contractor should be notified immediately to mitigate the impact on the contractor's schedule by allowing time for a shift of resources.

7.9.2 Progressing. A project or availability that is not planned cannot be controlled. Once the project has commenced, project control is possible only when one knows the status of the project at a given point in time. The process of creating the project schedule baseline established the benchmark against which schedule progress is measured. The dynamic nature of a ship repair availability necessitates change. Some of the primary factors, which influence such change, include added and deleted work, delays, strikes, weather problems, changes in sequence and acceleration in the work, among others. "Updating" involves the periodic review of the project plan, schedule and progress to provide a complete and accurate report of actual versus planned progress. It can be utilized as a basis for the purpose of determining the amount of periodic progress payments to which the contractor is entitled. It may also serve as a basis for allowing the parties to schedule their remaining work in order to achieve the overall schedule objectives.

- a. The pertinent information to be gathered and analyzed during each update period includes the following:
 - (1) Commencement and completion dates for all activities commenced and/or completed during the update report period.
 - (2) Current progress of activities which commenced in prior update periods, indicating actual completion dates or, if still in progress, the remaining time duration.
 - (3) The determination of what activities need to be re-sequenced, added, deleted or modified to clarify or reflect a change in plan or operation which to maintain requires schedule detail for proper monitoring and controlling.
 - (4) Fragments, which have been incorporated into the network diagram, to reflect delays and/or changes.
- b. RMCs are required to develop an independent assessment of progress for use in comparison with the contractor's production progress report. A progress report is developed by determining the ratio of the planning estimate for labor and material separately for each work item compared to the planning estimate for labor and material for the total contract. This will establish a weight factor for the labor and a weight factor for the material for each work item. Every attempt should be made at the outset of the availability to reach agreement with the contractor on the relative value of each work item for progressing purposes. To ignore a contractor's justified concern about potential progress payments could be extremely harmful. In every case where there is a significant disparity between the Government's weight factor and that of the contractor, the RMC should investigate the cause and adjust the factors as needed. Contractors may attempt to front load the contract for progressing purposes to maximize early cash flow. In this regard, the weight factors for items scheduled for early accomplishment may be inflated. On the other hand, the contractor may have good justification for a weight factor significantly in excess of the RMC developed factor. Where the contractor has adequate justification for a weight factor, the RMC factor should be adjusted. In those cases where the RMC does not agree with the contractor, the Government weight factor must be used.
- c. The total of all weight factors for labor added to the total of all weight factors for material should equal 100 percent. The actual percentage of completion of work is then determined independently for labor completion and material for each work item. Material progress assessments are made on the basis of the estimated dollar value of satisfactory material received by the contractor. The percentage of completion of the labor for each work item is multiplied by the labor weight factor established for that work item, and the percentage for material for each work item is multiplied by the material weight

factor established for each work item. The sum of the products for labor and material for a work item is the total percentage of completion of the work item. For example, the weight factor for a work item is determined to be .01 percent and at a point in the contract the estimated actual labor and material completion is 50 percent; the contractor could be authorized a progress payment of .005 percent of the current contract value, less retentions. The sum of the products for the labor completed for all work items is the total percentage of labor completion, and the sum of the products for material for all work items is the total percentage of material completion. The total labor completion added to the total material completion is the total percentage of completion of the contract.

- d. Contract modifications including change orders and other changes waiting to be adjudicated are included in the progress determinations when they are executed by the contracting officer. A contract modification may be considered along with the basic work item modified or for major modifications for growth or new work or may be considered as a separate item for progressing purposes. When considered along with the work item modified, weight factors for each modification, including changes waiting to be adjudicated, are based on the Government estimate for the changes and not on the contractor's proposal. However, if settled, the settled price should be used. After the weight factors are initially established, the factors should not be changed except when the contract is modified. Each time the contract is modified, all weight factors in the program must be reconfirmed or changed as required.
- e. The on-site Shipbuilding Specialist usually estimates the actual percentage of completion of assigned work items and modifications and routinely accomplishes in-process inspection. The Shipbuilding Specialist also reviews contractor condition reports on assigned work items and prepares responses and contract modifications, if necessary. Commands that do not have Shipbuilding Specialists may assign progressmen, production controllers, ship surveyors or others to accomplish the percent progress determinations. Typically, personnel who are Shipbuilding Specialists determine progress percentages only. The current contract value and value of the earned progress payment to the contractor is determined by the ACO, based on the technical progress assessment percentage. Labor progress determinations are made for each work item requiring a productive effort. For those work items currently not being worked by the contractor, the progress status from the previous week will simply be carried forward in the current week's progress assessment. Progress determinations on the remaining work items are made by physically assessing the status of work performed and comparing it to the total work required for the items. The progress assessment must be based on a valid progressing method appropriate for the nature of the work required. There are four basic approaches to progressing a work item: the uniform method, the 0 or 100 method, physical percent complete and the activity method.
- (1) The uniform progressing method is applicable to work items that require a constant level of effort throughout the availability. The Level of Effort classification of work measurement includes general or supportive activities having no definitive or deliverable product. Budget is scheduled over the period of performance. The Budgeted Cost of Work Performed (BCWP) earned is based on the passage of time. Typical Level of Effort work activities include, but are not limited to, program management, production engineering, contract administration and field engineering. Hotel services to the ship can also be progressed as a uniform item, such that when the elapsed time of the availability is at 40 percent, the item is 40 percent complete.
 - (2) The 0 or 100 percent progressing method is applicable to small work items that will require a relatively short period of time to complete. The progress status of the items is carried at 0 percent until completed and at 100 percent after completion. Final acceptance remains the responsibility of the ACO.
 - (3) The physical percent complete classification of work measurement often depends upon individual evaluation of work accomplished. It is also commonly expressed as follows: BCWP cumulative divided by Budgeted Availability Cost (BAC)

$$\text{Percent Complete} = \frac{\text{BCWP cum}}{\text{BAC}}$$

Percent complete, when defined as an activity's percentage of completion based on duration is often misleading and should be avoided.

- (4) The activity progressing method is applicable to large or complex work items that cannot be progressed by a simpler means. To apply this method of progressing, the work item is broken down into a number of discrete work activities consistent with the requirements specified in the work items. A weight factor is assigned to each activity that is approximately equal to the estimate for the work item paragraphs covered by the activity.
- f. Two examples of activity progressing are provided in Appendix D and Appendix E. In the following examples, a work item requiring in shop overhaul of a fire pump is broken down into discrete activities.
 - (1) In the first example the Shipbuilding Specialist has broken the work item down into 11 significant activities that cover 100 percent of the work required, and a percentage of the total is assigned to each activity which is approximately equal to the percentage of the estimate of the activities covered to the total work item estimate. For example, the estimate for repairs to be accomplished in the shop is about 20 percent of the total work item estimate.
 - (2) In this second example there are 12 activities that contribute to achieving 100 percent complete. Progressing is accomplished by using each significant activity that is associated with the work item as a cumulative percentage of the total of all completed activities. In this example, the work item will be reported as 75 percent complete when the pump is delivered back to the ship and reinstalled. Examples are also provided for “on-ship repair” and Ship Change installations. For large activities, progress credit can be taken at a uniform rate for the time allocated to the activity, or the activity can be further divided into sub-activities to facilitate more detailed progressing.
- g. Contractor’s incurred costs and unsatisfactory work are not to be considered in the determination of the percentage of progress completion. The RMC must certainly monitor a contractor’s incurred cost as a matter of principle. Incurring costs in excess of the expected cost for the percentage of work completed may indicate that the contractor will have trouble financing the completion of the work. For this and related reasons, the Government must be aware of the contractor’s financial condition and the contractor’s relative loss or gain position for the contract. That a contractor has expended a specific percentage of the contract value cannot be used in any way to influence the progress determination. Likewise, the contractor cannot be given credit for progress on a work item when deficient work has been reported. If a work item has a Corrective Action Report/Quality Deficiency Report issued against it, the progress for that work item should not be changed until the Corrective Action Report/Quality Deficiency Report is resolved. Progress percentages cannot be adjusted as a punitive measure in attempting to resolve a problem with the contractor; the ACO has other methods available to resolve such problems.
- h. Material progress is based on the material cost incurred by the contractor. The material must be satisfactorily receipted and paid for by the contractor. This amount is divided by the overall material amount to determine the percentage of material completion. The contractor submits a progress report with completion percentages as required by the contract, normally each week. Independently, Shipbuilding Specialists will mark up the Government-generated work item labor and material completion percentages. The marked-up percentages will then be used to determine the contractor’s current progress and to update the official progress reports. Differences in opinion with the contractor should be resolved in the weekly progress meeting.

7.9.3 Progress Payments. There are two types of payments provided by Government contracts: “Provisional Payments” associated with cost reimbursable type contracts, and “Progress Payments” associated with fixed price type contracts. Progress payments are further categorized as “customary” and “unusual”. Customary payments are based on a payment rate, cost base and a frequency of payment. The unusual type of progress payment is based upon the actual amount of work completed and material acquired by the contractor for the work. Details of these types of payments may be found in reference (q). The process described in paragraph 7.9.2 of this chapter to determine the progress of repair and modernization is normally used to verify the payment of contractor’s invoices.

7.9.4 Progress Conferences.

- a. Progress Conferences should be scheduled with the contractor, Ship’s Force or both, when there is a need to resolve schedule or progress issues. The RMC and ships MT may require these meetings with the contractor, Ship’s Force and other activities as needed to address problems.

- b. During the Progress Conference, the discussion of contractual issues must be avoided unless the ACO is present. A discussion of the status of funding must be avoided if the contractor is present. The purpose of the Progress Conference is to:
- (1) Review the progress of each work item and modification.
 - (2) Identify and evaluate the controlling jobs.
 - (3) Resolve identified production problems or devise work around solutions.
 - (4) Review quality and safety problems.
 - (5) Review the status of GFM and CFM.
 - (6) Discuss key events or evolutions.
 - (7) Review and discuss the project's schedule including, but not limited to, the critical path's total float value.
- c. Weekly progress meetings are conducted by the Project Manager and are usually held onboard or near the ship and are attended by key personnel from the RMC, the ship's CO and other MT members, key Ship's Force personnel and the contractor's key representatives. The Project Manager shall ensure that an agenda of issues developed from input previously solicited from the participants in the weekly progress meetings is prepared at least one day prior to the meeting. Ship's Force should discuss problems with the contractor's performance, workmanship or the actions of the contractor's personnel with the RMC before addressing the problems with the contractor. All issues between Ship's Force and the RMC should be resolved prior to meeting with the contractor. If such issues cannot be resolved before meeting with the contractor, the Government only issues should not be discussed in the presence of the contractor. The Government must speak with one voice to the contractor as this is an opportunity for the contractor to perceive that the discussion was a constructive change to the contract.
- d. The contractor is required by the scheduling work item to "provide cognizant management representation to participate." The specification further states, "The representative must be authorized to make management decisions relative to routine requirements of the job order which, in good faith, commit the contractor." The contractor is normally required by contract to submit among other things, the following information to the RMC and Project Manager one working day prior to the weekly progress meeting:
- (1) The revised production schedule including additions, completions, modifications, progress and completions.
 - (2) Manpower utilization data.
 - (3) A report listing each work item's scheduled start date, scheduled completion date, actual start date and percentage complete.
 - (4) A report listing contractor and GFM not received, expected delivery date, required delivery date and action proposed to resolve problems resulting from late delivery.
 - (5) A report listing late or deficient Government Furnished Information and proposed corrective action.
 - (6) A report of overdue contractor condition reports and expected submission date. The report shall also include those deficiency or condition reports for which Government response is outstanding.
 - (7) The revised weekly test schedule.
- e. Two of the most critical aspects of ship repair and modernization project management is the management of resources and communication to accomplish the required work. Unlike other tasks, project management communications center largely around time-sequenced and logic-sequenced events and the resources required to complete them. It includes the processing of project data to plan and control a project in terms of cost and time. When discussing and evaluating production problems

during weekly progress meetings, or when evaluating or negotiating the cost and time impact of contract changes, communicate with the contractor, contract cost and schedule variances. To do so, knowledge of the contractor's production control and cost systems is necessary. In order to communicate and understand performance measurement for specific work, identify and discuss BCWP, Budgeted Cost of Work Scheduled (BCWS) and Actual Cost of Work Performed (ACWP) up through the contractor's Work Breakdown Structure and Organizational Breakdown Structure. Review the contractor's cost accounts and cost account descriptions (typically available through the local Defense Contract Audit Agency office, should the contractor be reluctant to provide such information). The "cost account" is a key and natural management control point as it represents the work assigned to a specific responsible organizational element on one work breakdown structure element. It is an element of work for which responsibility is assigned, and is further defined by work packages and work orders. In forecasting and evaluating problem areas on any given project, focus more on BCWP trends rather than ACWP trends. $\text{Cost Variance} = \text{Earned Value or BCWP} - \text{ACWP}$. By documenting and comparing actual hours expended to date (ACWP) to the earned value of the work performed (BCWP), it is possible to project the cost at completion and the completion date. Furthermore, the parties can then also compare the projects past work history to the amount of remaining work as a reality check on forecasts by the contractor's scheduling department.

- f. The difference between the BCWS and BCWP is referred to as the schedule variance (and is favorable if the earned value is greater than the BCWS). The difference between the ACWP and the earned value is referred to as the cost variance (and is favorable if the earned value exceeds the actual costs). The ratio of the earned value to ACWP or BCWP/ACWP is referred to as the Cost Performance Index (CPI). The CPI indicates the cost efficiency with which contract work has been accomplished. A CPI of less than one implies a cost overrun, of more than one implies a cost under-run and of unity implies an on target condition. CPI data at the cost account level or below is particularly helpful when asked to measure and estimate loss of efficiency or "disruption". Be advised that most of the commercially available project management software allows the determination/calculation of CPI at the work order level and above. For more information on earned value management techniques and contemporary program management software capabilities, access the Earned Value Management Home Page at www.acq.osd.mil/pm/.
- g. Cost Performance Index (CPI)/Schedule Performance Index (SPI) (Surface Force Ships only) On a weekly basis, the CO, Project Team and RMC shall report CPI and SPI.
 - (1) Cost Performance Index (CPI) - This is an earned value analysis technique that is used to calculate cost performance efficiency with which contract work has been accomplished. CPI should consider only the "projected" cost of an availability against the actual cost of an availability over the timeline associated with that availability. This will provide the CPI with raw factual data to give you the most accurate and true indication of CPI. The formula for CPI is: $\text{Projected Cost/Actual Cost}=\text{CPI}$
 - (2) Schedule Performance Index (SPI) - This is a performance index that calculates schedule performance efficiency with which contract work has been accomplished. SPI should consider only the "projected" schedule of work to be performed during an availability against the actual work performed during an availability over the timeline associated with that availability. This will provide the SPI with raw factual data to give you the most accurate and true indication of SPI. The formula for SPI is: $\text{Project Schedule/Actual Schedule}=\text{SPI}$

NOTE: REBASELINING PROJECTED FIGURES IN EITHER CASE SHALL NOT BE PRACTICED AS IT WILL RENDER REAL TIME DATA USELESS IN THE PERFORMANCE OF THE AVAILABILITY.

- (3) Based on SPI and CPI, an availability will be referred to as green, yellow or red as seen in Figure 7-1.
 - (a) In order for an availability to be referred to as GREEN, the SPI/CPI must be .95-1.05.
 - (b) In order for an availability to be referred to as YELLOW, the SPI/CPI must be .94-.80 or 1.06-1.20.

- (c) In order for an availability to be referred to as RED, the SPI/CPI must be >1.20 or <.80.

Figure 7-1 SPI/CPI Metrics Chart

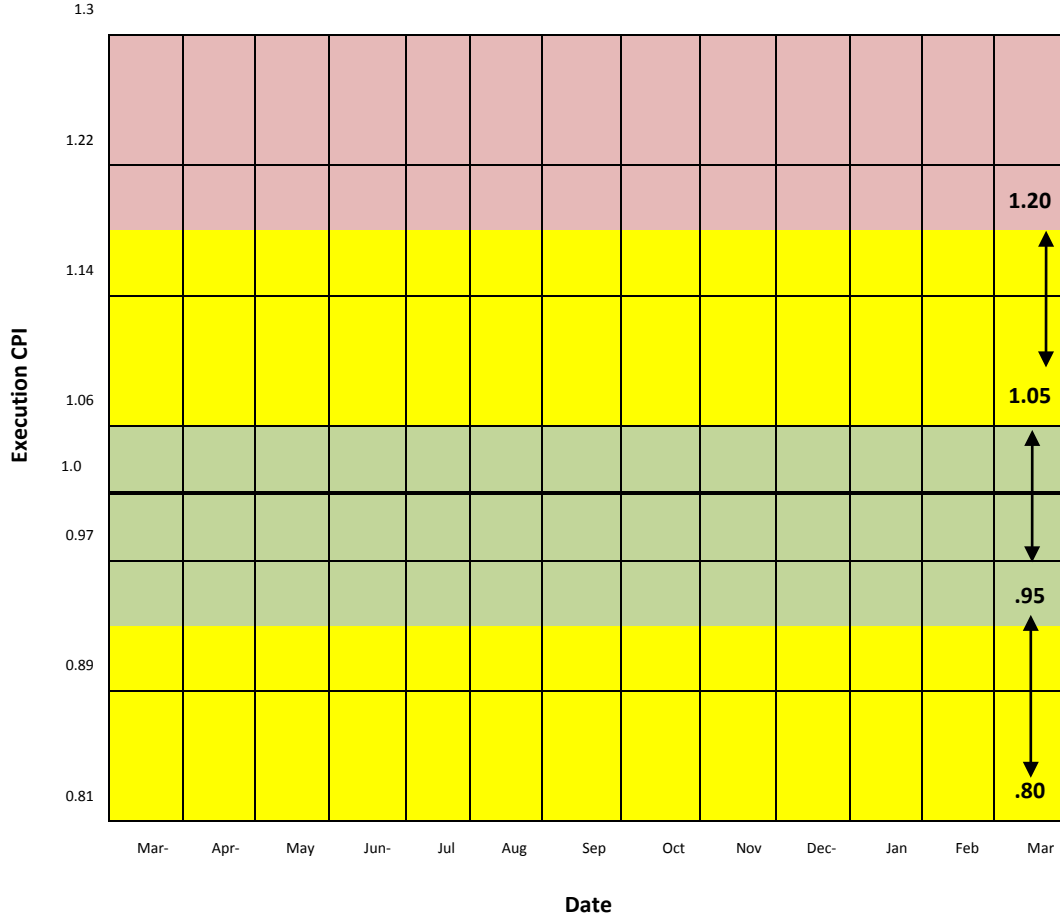

7.10 FUNDS ADMINISTRATION.

7.10.1 Over Obligation. Reference (r) establishes that Government funds may not be over obligated or over expended. Severe penalties may be imposed on the CO, RMC as well as any individual involved in such an infraction. Reference (s) establishes that funds must be obligated or expended only for the purpose for which the funds were authorized. Funds administration has been addressed further in Chapter 6 of this Volume.

- a. Personnel in Waterfront Operations must be involved in the funds administration process for the same reason that these personnel are involved in contract administration. The ACO is responsible for ensuring that the contract is properly funded and the Comptroller is responsible for proper financial management. Individuals in these positions will not normally be aware of the validity of the technical requirement for an obligation or expenditure. It is usually the waterfront staff that knows that the material ordered is actually required for the project that the funds grantor provided the funds to accomplish. It is usually the waterfront staff that is aware of the proper funds to apply to a project and shall not proceed until the Funds Administrator obtains the proper authorization to use the funds from the funds grantor.

- b. The Funds Administrator shall be assigned in writing by the CO of the RMC and will be held responsible for the use of funds granted as well as for technical accountability. The funds administrator is then responsible for identifying funding requirements to the funds grantors, apprising the Comptroller on the advisability of acceptance and returning excess funds to the funds grantor.
- c. Generally, the funds administrator is the only individual who can authorize the Comptroller to initiate, commit, obligate or expend the funds for an assigned availability or project. Requirements to increase work in an availability, no matter how critical, must be authorized by the funds administrator. Prior to the preparation of contract modifications, Shipbuilding Specialists must receive authorization from the funds administrator, who will cause the estimated funds to be committed. Funds must be available before negotiations can begin with the contractor or before the ACO can direct a change order, except in the case of impending disaster. In some cases, the funds administrator may be required to receive authorization from the funds grantor to authorize a modification, such as for growth work in excess of an established threshold. In the case of insufficient funds, the funds administrator must obtain additional funds before authorizing any obligation.

7.10.2 Growth and New Work.

- a. Contract clauses and NAVSEA Standard Items require contractors to submit reports identifying additional work or material procurement necessary to produce a reliable or complete repair. The contractor is additionally required in various work items to submit condition reports that identify additional work necessary to accomplish the intent of the work authorized. The contractor may also submit unsolicited reports that may generate additional work, increase the value of the contract and affect the scheduled completion of the contract.
- b. In the process of nearly continuous work identification, some new work may be identified that was not contemplated in the contract nor considered to be within the intent of the original work authorization. That work necessary to complete a satisfactory repair covered in the specifications will usually be authorized as growth within scope, or simply growth work by a contract modification if the funds can be made available. New work to be added to the contract should be the subject of a new work request. New work should not be added to the contract unless it is considered to be mission critical or a safety item and it is reviewed by the Naval Supervisory Authority Chief Engineer for technical compliance. Growth work should not be authorized except as necessary to complete the intent of the original work scope authorization. Growth work, above budget controls, requires the same level of review by the Naval Supervisory Authority Chief Engineer and adjudication by the TYCOM as new work. Any work, new work or growth work added to the contract after award will impact the contractor's scheduled requirements and will require additional resources, additional time or both.
- c. The contractor condition reports will normally be received by the Shipbuilding Specialist that is assigned responsibility for the trade area of concern who will review the work item and references, as well as all related work items, to determine whether or not the work is already covered in the basic specifications. If the work identified in the condition report is not already a part of the contract, the Shipbuilding Specialist and the ship's Port Engineer for surface force ships and the Maintenance Manager for aircraft carriers will go to the ship, inspect the work site and, if possible, discuss the problem with the individual who generated the report for the contractor. If in the judgment of the Shipbuilding Specialist and the Port Engineer or Maintenance Manager, the work is already required by the contract, is not necessary to accomplish the intent of the work authorized, or can be deferred for later accomplishment, the Shipbuilding Specialist will annotate the report with the appropriate disposition and return it to the contractor after review by the Project Manager. The timing of the condition report review process is critical. Reports shall be time stamped upon receipt from the contractor and returned within three days. When issues raised in a condition report require a longer processing time, the contractor should be advised as to the expected response time.

7.10.3 Contract Modifications.

- a. When the Shipbuilding Specialist and MT/Ashore Ships Maintenance Manager concludes that a condition report identifies an additional work requirement necessary to complete a reliable repair and accomplish the intent of the work authorized, the Project Manager will be notified that a contract

modification is necessary and a TAR will be necessary for the additional work. The ACO shall likewise be alerted that a contract action will be forthcoming. If the Project Manager, Ashore Ships Maintenance Manager and MT agree the contractor's initial estimate is within the funds grantor's authorization and the necessary funds are available, the Project Manager should immediately request the ACO to commit the necessary funds and authorize the preparation of the work item specification and a TAR to support the negotiation process associated with a contract modification.

- b. In some cases, the activity providing funds may place a dollar limit on individual growth work changes which can be authorized by the Project Manager and the ship's MT/Ashore Ships Maintenance Manager without the grantor's prior approval. Changes for growth work under this established threshold can be authorized by the Contracting Officer to process the change. For other changes, the Project Manager must obtain concurrence from the MT/Ashore Ships Maintenance Manager and advance approval from the funds grantor before the change can be authorized and in some cases additional funds will be required. This requirement may cause delay in processing needed changes and increase the cost of the additional work. The Project Manager shall do all that can be done to expedite the funding authorization to minimize the potential delay impact.
- c. In some situations, problems may be identified which cannot be addressed adequately by the Project Team. When needed, the Shipbuilding Specialist will initiate a request for technical advice, assistance or direction from the RMC engineering department or the cognizant technical agent, as appropriate. For example, the local engineering department and Chief Engineer should be consulted first for any problem related to the repair work package. Additional consultation with other outside activities should be initiated only after local resources have been exhausted. Problems with the authorized alteration package should be referred to the on-site design liaison representative of the cognizant PY. Local engineering services and PY liaison services do not require funding from availability funds. However, requests for reimbursable services from other activities should be initiated only with the approval of the Project Manager, after consulting with the MT/Ashore Ships Maintenance Manager and Contracting Officer, who must be able to provide the required funding.

7.11 DELAYS IN PERFORMANCE.

7.11.1 Risk. Generally, the contractor bears the risk of both time and cost for delays which the contractor causes or which are within the contractor's control. This may be excused for delays caused by factors for which the contractor is not responsible.

7.11.2 Performance. Contractors are always responsible for providing plant, machinery, labor and finances required for the performance of contracts awarded. Failure to have the necessary machinery or other such means for performance, whether at the time of contracting or subsequently, generally is not a valid excuse for delay or failure to perform. For example, a breakdown of a contractor's machinery is not excusable unless the breakdown was caused by an excusable event.

7.11.3 Material. In a fixed price contract, the contractor assumes the risk of obtaining the materials necessary for performance and a subsequent market shortage is not an excusable cause for nonperformance. The fact that supplies cannot be obtained except at a cost in excess of the contract price is no excuse. Unwillingness to perform at a loss does not relieve the contractor from its contractual obligation. A contractor, even in a time of volatile prices, is deemed to have assumed the risks of increases in material cost. This does not apply in a cost type contract. The Government assumes the risk for providing GFM to meet the contract requirements and contractor's production schedule as mutually agreed upon.

7.11.4 Excusable Delays.

- a. In most cases of excusable delay, the contractor must bear the cost impact of such delays. For excusable delay in a contractor's facility, the Government usually will compensate the contractor only for the cost of services provided for the benefit of the crew of the vessel and no other costs. The Government, however, will compensate the contractor for both the time and cost effect of delays caused by the Government.
- b. Most excusable delays involve temporary work interruptions. When the impediment is removed, the contractor is expected to resume performance. Generally, the contractor is not liable for any excess costs if failure to perform the contract arises from causes beyond the control and without the fault or

negligence of the contractor. "Fault or negligence" deals with acts or omissions of the contractor which cause delay. Examples of events beyond the contractor's control and without the contractor's fault or negligence may include:

- (1) Acts of God or of a public enemy.
- (2) Acts of Government in either its sovereign or contractual capacity.
- (3) Fires.
- (4) Floods.
- (5) Epidemics.
- (6) Quarantine restrictions.
- (7) Strikes.
- (8) Freight embargoes.
- (9) Unusually severe weather.
- (10) Terrorist Acts including bomb threats.

- c. In each instance, the delay must be beyond the control and without the fault or negligence of the contractor. The element of "foresee-ability" must be considered regardless of any specifically enumerated excusable factors in order for a contractor to be entitled to excusable delay. If a delay is caused by a subcontractor at any tier, and if the delay is beyond the control of both the contractor and subcontractor and without the fault or negligence of either, the contractor is excused for the delay unless the subcontracted supplies or services were obtainable from other sources in sufficient time for the contractor to meet the required delivery schedule. Generally, delay is not excusable if the supplies or services were obtainable from other sources in sufficient time to permit the contractor to meet the required delivery schedule. Delays caused by sole source subcontractors, even those designated by the Government, do not qualify for excusable delays if the subcontractor is at fault. When the Government directs the installation of a sole source item, it represents only that the requirements of the contract can be met by using that item. However, such representation is predicated upon the assumptions that the item has been properly manufactured and timely delivered by the vendor and that it will be installed properly and timely by the contractor. Excusable delay may result from:

- (1) Acts of God: Delays caused by "Acts of God" (such as delay caused by earthquake) or other naturally occurring events are generally excusable. An "Act of God" has been defined as a "singular, unexpected and irregular visitation of a force of nature."
- (2) Strikes: Delays caused by strikes are generally excusable. Strikes include job actions by a contractor's own employees and by a subcontractor's employees. Excusable delay may also be allowed for other job actions which have the effect of a strike against the contractor, such as organizational strikes, jurisdictional strikes, pickets protesting another contractor at a site, delays caused by impending strikes and wildcat strikes. In order to obtain an excusable delay for a strike, a contractor must prove that it acted reasonably by not wrongfully precipitating or prolonging the strike and took steps to avoid its effect. In the absence of a strike or other enumerated cause of delay, a contractor is generally not excused for labor difficulties. These difficulties usually involve either the loss of key personnel or an unexpected labor shortage. The boards have strictly adhered to the rule that the contractor assumes the risk of hiring and retaining a competent work force.
- (3) Weather: Generally, delay caused by unusually severe weather is excusable. Unusually severe weather is that weather which is abnormal compared to the past weather at the same location for the same time of year. Normally, proof that weather is unusually severe is accomplished through the comparison of the United States weather statistics for past periods in the area with those recorded during the period of performance. When weather conditions are not totally abnormal from a statistical or average standpoint, but are abnormal and unusually severe in

their effect on the particular type of contract work being performed, the contractor may be entitled to excusable delay. In cases where the nature of the work requires specific environmental conditions and when the work is delayed because of weather conditions, the delays are excusable to the extent that the weather conditions exceed the normal weather delays contemplated for the period of the performance.

- (4) Government Acts: Acts of the Government in either its sovereign or contractual capacity may be cause for excusable delay.
 - (a) Contractual Acts: For a contractor to be excused by an act of the Government in its contractual capacity, the contractor must show that delay resulted from the Government's failure to perform its express or implied contractual duties.
 - (b) Sovereign Acts: Sovereign acts which delay the contractor's performance may be grounds for excusable delays. In general, however, when the Government's acts are for the general public good and are indirect in nature, the contractor is not excused for any resultant delay.

7.11.5 Non-Excusable Delays. Even though it may be argued that the following delays occurred through no fault of the shipyard and were unforeseeable, the shipyard is typically held responsible and the resulting delays are not excusable.

- a. Subcontractor delay involves delay occasioned by a shipyard's own subcontractors. A shipyard assumes a non-delegable duty to perform a construction contract, and it is generally no excuse to allege that a shipyard has been delayed by its own subcontractors. The shipyard can, of course, look to the subcontractor for any damages incurred as a result of such delay.
- b. Lack of sufficient working capital does not constitute an excusable cause of delay. A shipyard is expected to have the financial ability to perform the contract. The shipyard's delay or failure to perform resulting from its inability to obtain money is ordinarily inexcusable regardless of the reason; whether due to an economic downturn, general financial distress or failure of a third party on whom it relied on in furnishing support.

7.11.6 Compensable Delays. A contractor's ability to recover increased costs resulting from delays will depend upon the cause of the delay, the nature of its impact on the contractor and the contractual provisions dealing with compensation for delays. Generally, compensable delays result from either changes in the work, the existence of a differing site condition, or an unreasonable suspension of work or failure of the Government to perform its duties under the contract.

7.11.6.1 Government Delay of Work. The contractor cannot be directed to stop work by anyone other than a warranted ACO with one exception. The only exception to this requirement is to protect the safety of personnel, environmental compliance or prevent the loss of or destruction of property and equipment. If the contracting officer orders the contractor to suspend or stop work, the contractor will always be entitled to an equitable adjustment in both contract price and delivery schedule to compensate for the impact on performance. In other situations, the Government will be at fault if it breaches its implied duty not to hinder or interfere with the contractor's performance or its implied duty to cooperate with the contractor. Generally, the Government will be at fault when it is responsible for:

- a. Delays in making the work site available.
- b. Delays caused by interference with the contractor's work.
- c. Delays in providing required Government reviews and approvals.
- d. Delays in providing funding.
- e. Delays in performing required inspection of work.
- f. Delays in issuing changes.
- g. Delays in furnishing Government Furnished Property.
- h. Delays which are unreasonable in duration.
- i. Delays caused by conflicting or defective Government specifications.

7.11.6.2 Excusable Delay Relief. A contractor is not entitled to relief upon the mere occurrence of an event that qualifies as an excusable delay. The contractor must show that the delay was caused by an excusable event and that the event caused delay to the overall completion of the contract, and the contractor must establish the number of days of relief to which the contractor is entitled. The event alone is insufficient to justify the granting of an excusable delay. Not every fire, quarantine, strike or freight embargo is an excuse for delay. Events may not be beyond the contractor's control if the contractor could have overcome the effects of the event, and further, when the event is considered foreseeable, the contractor may be held responsible for making alternative arrangements for performance. Even though a contractor can establish that an event or occurrence was unforeseeable, beyond its control and occurred without its fault or negligence, the contractor is not entitled to an excusable delay unless the contractor can prove that the time lost delayed the completion of the job. It is not sufficient to establish that some work was prevented. The work prevented must be work that will delay the overall completion of the job. When the CPM of schedule control is used, the delay must be on the critical path.

- a. Generally, the duration of the time extension is governed by the extent to which the excusable cause of delay either increases the amount of time required for performance of the contract work as a whole, or defers the date by which the last of the required work will be reasonably capable of completion. The extension granted may be longer, shorter or of the same duration as the delay period.
- b. Generally, the amount of equitable adjustment recoverable by a contractor is equal to the costs that were greater than those which would have been incurred but for Government caused delay. Generally, cost increases attributable to the delay, such as those associated with increased labor rates, time-related labor, equipment, insurance and overhead, if any, are accepted and negotiated. Acceleration costs are also recoverable against the Government if they are incurred in mitigation of the effects of a Government caused delay. When reviewing a contractor's request for delay or acceleration costs, particularly unabsorbed overhead, it is helpful to confer with responsible contracting personnel and legal counsel in order to ensure the appropriate criteria is applied to the specific alleged entitlement.

7.11.7 Concurrent Delay. Generally, in a case where the Government and the contractor are each responsible for delay in completing the work, the Government is barred from assessing liquidated damages against the contractor and the contractor is precluded from recovering delay damages. Concurrent delay does not bar extension of time, but it does bar monetary compensation for, among others, daily fixed overhead costs because such costs would have been on account of the concurrent delay even if the Government responsible delay had not occurred.

7.12 AVAILABILITY FINALIZATION.

7.12.1 Availability Completion Conference.

- a. After Sea Trials and before the scheduled availability completion date, the Project Manager will arrange for the Availability Completion Conference. Generally, the scheduling of the conference will be deferred until most of the contractor's deficiencies have been corrected. The Availability Completion Conference is chaired by the Project Manager and should be attended by the Project and Maintenance Teams, TYCOM Representative, ship's MT, NAVSEA (if significant NAVSEA alterations were accomplished), the ship's CO and the contractor's representatives including the ship superintendent. For major availabilities, the CO of the RMC shall also attend the conference.
- b. The purpose of the Availability Completion Conference is to establish the date and conditions under which the TYCOM and NAVSEA will accept redelivery of the vessel. To complete the availability and redeliver the vessel, the contractor's work must be completed or exceptions to completion must be documented and agreed upon by the parties concerned. For each exception permitted, a plan to complete the work must also be agreed upon and documented. Additionally, the RMC must ensure that Government responsible work is completed before redelivery or completed with exceptions.
- c. Exception items that the contractor is allowed to complete after the redelivery date must be monitored by Ship's Force and RMC Representatives to ensure contractor compliance with contract requirements. Additionally, the ACO will retain sufficient retention funds to cover the estimated value of the incomplete work. Final payment and release of other retained funds is made when the ACO is satisfied that the contractor has substantially complied with all contract requirements and documented exception agreements.

7.12.2 Exceptions to Completion of the Contract. The exception list developed at the Availability Completion Conference will be reviewed by the Project Manager and the ACO to determine if the contract should be declared complete with the exceptions remaining to be completed. The Project Manager reviews the list with the MT/Ashore Ships Maintenance Manager and Project Management Team to identify items that should be deleted from the contract. Items that should be deleted are those items requiring Long Lead Time Material for completion or items that cannot be completed because of factors beyond the control of the contractor. Work item specifications and TARs are then prepared to support negotiation of contract modifications to delete the work from the contract and reduce the contract value. The on-site team also provides estimates for the outstanding items on the exception list so that the ACO can ensure that adequate funding is retained to complete the outstanding items. The redelivery date of the ship is established by the ACO when agreement is reached by all parties on the disposition plan for all exception items.

7.12.3 Availability Completion. When the RMC considers the ship ready for redelivery to the Fleet, the TYCOM is notified. The TYCOM generally concurs if, in the TYCOM's judgment, the exception list does not include outstanding work which would prevent the ship from being fully capable of accomplishing its mission or an accumulation of smaller items which would seriously affect the ship's safety or operations. When agreements of the Availability Completion Conference have been met (if applicable for the class of ship), the TYCOM will accept redelivery of the ship to the Fleet, the contract is declared complete with exceptions and the availability is officially ended.

7.12.4 Contract Guarantee Period.

- a. When the ship is redelivered to the Fleet, the contract guarantee period begins. The PSIA contract guarantee period is typically 60 days. For fixed price contracts, the contractor must correct deficiencies in the work performed or in the materials supplied for a period of 90 days. The guarantee period on the items that were exceptions to the completion of the contract will start when the RMC accepts the completed work. Defective contractor work or material deficiencies identified after completion by Ship's Force or others must be reported to the RMC promptly. RMC Representatives investigate the deficiency, and, if it is determined to be a contractor-responsible deficiency, the ACO notifies the contractor in writing. If it is reasonable to do so, the Government must allow the contractor access to the ship to correct the noted deficiencies. If the ship is in port and accessible, the contractor has the option to accomplish the repairs or arrange for another contractor to accomplish the repairs. If the contractor corrects the defect directly or by the use of a subcontractor, then a new guarantee period begins when the repairs are accepted by the RMC. The total guarantee period for any item under a fixed price contract cannot exceed a maximum of 180 days.
- b. If the contractor fails to arrange for the correction of the deficiencies, then the ACO will arrange for the defects to be corrected by other means and execute a contract modification with the contractor for an equitable reduction in the contract value. The defects can be corrected by various Government resources, including Ship's Force or by another prime ship repair contractor. If the ACO contracts with another contractor to correct the defect, then the new contractor is responsible for a new contractor 90-day guarantee period when the repair is accepted by the RMC.
- c. In the case of split availabilities, the contract guarantee period may begin prior to redelivery of the ship to the Fleet if the Navy uses the equipment provided or the repaired item prior to redelivery.
- d. Throughout the guarantee period, the Project Manager must maintain contact with the ship and monitor the contractor's completion of exception items and the correction of guarantee defects. Disputes about guarantee work items must be resolved by the ACO.

7.12.5 Completion Reports. The RMC reviews the records and compiles a number of reports at the conclusion of the availability, the completion of the guarantee period and the closing of the contract.

7.13 INSURANCE.

7.13.1 Introduction. NAVSEA's insurance policy differs from most Government agencies since NAVSEA is basically a self-insurer beyond contractually specified deductibles for which the contractor is responsible. In general, there are two types of insurance coverage. The first covers loss, damage or destruction to the vessel, its equipment or materials; the second covers third party and collision, protection and indemnity liabilities. It is essential to remember that insurance claims are different from contract claims. Specifically:

- a. Require direct physical damage to vessel from external cause.
- b. Excludes delay, disruption, faulty work and materials, cost of sea trials and consequential damages.
- c. Excludes fixed overhead.
- d. Excludes overtime, unless authorized.
- e. Excludes cost of money.
- f. Can pay negotiated profit influenced by degree of contractor fault and based upon profit of all yard work.
- g. Reimbursement not to be based on estimates, but on return costs for labor performed and bills paid for material.
- h. Can settle outside contract price (targets).
- i. Deductible is not a contract cost.

7.13.2 Master Ship Repair Agreements/Private Sector Industrial Activity Contracts - Loss or Damage to Government Property. Reference (t) does not refer to any Navy Syndicate Forms (i.e., the coverage is self-contained). The contractor is directed to exercise reasonable care and use best efforts to prevent accidents, injury or damage to all employees, persons and property in and about the work and to the vessel or part on which work is being done. The term "reasonable" is normally defined in terms of criteria established by the National Fire Protection Association. Of course, any specific contract requirements will govern. Issues regarding Insurance should be directed by the Contracting Officer and the Counsel for the RMC. For example, the requirements are very complex and the Department of Defense is self insured as noted in the following:

- a. The contractor will not, unless otherwise directed or approved in writing, carry or incur the expense of any insurance against any form of loss or damage to the vessels or to the materials or equipment to which the Government has title, or which have been furnished by the Government for installation by the contractor. The Government assumes the risks of loss or damage to the vessels and such materials and equipment. The Government does not assume any risk with respect to loss or damage compensated for by insurance or otherwise, or resulting from risks with respect to which the contractor has failed to procure or maintain insurance, if available, as required or approved.
- b. Further, the Government does not assume risk with respect to and will not pay for any costs of the contractor for the inspection, repair, replacement or renewal of any defects themselves in the vessel(s) or such materials and equipment due to the following:
 - (1) Defective workmanship or defective materials or equipment performed by or furnished by the contractor or subcontractors.
 - (2) Workmanship or materials or equipment performed by or furnished by the contractor or subcontractors which does not conform to the requirements of the contract, whether or not any such defect is latent or whether or not any such nonconformance is the result of negligence.
- c. In addition, the Government does not assume the risk of and will not pay for the costs of any loss, damage, liability or expense caused by, resulting from or incurred as a consequence of delay or disruption of any type; or willful misconduct or lack of good faith on the part of any of the contractor's directors, officers, and any of its managers, superintendents or other equivalent representatives who have supervision or direction of all or substantially all of the contractor's business or all or substantially all of the contractor's operations at any one plant. However, for such risk assumed and borne by the Government, the Government will be subrogated to any claim, demand or cause of action against third persons which exists in favor of the contractor, and the contractor will, if required, execute a formal assignment or transfer of claims, demands or causes of action. Moreover, nothing in the above will create or give rise to any right, privilege or power in any person except the contractor, nor will any person (except the contractor) be or become entitled to proceed directly against the Government or join the Government as a codefendant in any action against the contractor brought to determine the contractor's liability, or for any other purpose. In addition, the contractor will bear the first \$50,000 of loss or damage from each occurrence or incident, the risk of which the Government otherwise would have assumed under the provisions specified above.

- d. The Insurance Clause typically requires that the contractor will, at the contractor's expense, procure and maintain such casualty, accident and liability insurance in such forms and amounts as approved by the Government, insuring the performance of its obligations under paragraph (c) of the clause. Further, the contractor will procure and maintain Workers' Compensation Insurance (or its equivalent) covering employees engaged on the work and will insure the procurement and maintenance of such insurance by all subcontractors engaged on the work. The contractor will provide evidence of such insurance as required by the Government.

7.13.3 Administration of Insurance Requirements.

7.13.3.1 Responsibilities of the Assistant Secretary of the Navy Research, Development and Acquisition - Acquisition and Business Management. The Assistant Secretary of the Navy (ASN) Research, Development and Acquisition (RD&A) - Acquisition and Business Management (ABM) is available to contracting activities to provide guidance on insurance matters. The ASN (RD&A) - ABM is authorized by direction of the Secretary of the Navy, or the duly authorized representative of the head of a contracting activity, the contracting officer or any other naval official designated in such a contract, to do the following:

- a. Require or approve insurance when a contract provides that a contractor will procure such insurance.
- b. Execute, sign or endorse in the name of and by direction of the Secretary of the Navy any and all lost policy releases, proofs of loss, subrogation agreements, endorsements of policies for claims or return premiums, payment orders and insurance drafts made payable to the Secretary of the Navy and not affecting the obligating of appropriations.
- c. For risk pooling arrangements, confirm to the cognizant activity the amount of premium due and, if the funds allocated to the contract are not sufficient, the amount due shall be paid as an item of cost under the contract out of other appropriated funds.
- d. Advise and recommend to the Secretary of the Navy or other authorized interested officials of the Navy Department regarding insurance drafts that affect the obligating of appropriations and assignment, in order to assure payment of premiums found to be due after the completion of a contract.

ASN (RD&A) - ABM should be consulted if any assistance is required in determining Government responsibility. All matters concerning self-insurance covering any kind of risk will be submitted to the ASN (RD&A) - ABM.

7.13.3.2 Procuring Contracting Officer/Regional Maintenance Center Administrative Contracting Officer Responsibilities and Actions. Responsibilities outlined in the NAVSEA Contracts Handbook, Subpart 28.301, include:

- a. Establishing and maintaining adequate records on required contractor insurance.
- b. Expediting acquisition of the required insurance by the contractor.
- c. Reviewing insurance policies. The previous requirement to forward insurance policies to the ASN (RD&A) - ABM for review has been canceled. If problems exist with specific contractor insurance policies that the ACO cannot resolve, then NAVSEA 02 assistance should be requested.
- d. Ensuring the contractor maintains qualifying insurance under the annual Public Law 85-804, Secretary of the Navy Determination or individual authorization (see FAR Part 50.3).
- e. Establishing and maintaining adequate contract records of contractor claims when the Government assumes the risk or indemnifies the contractor under the contract, analyzing such claims to ascertain patterns of neglect or misconduct, and calling such matters to the attention of the contractor.
- f. Taking action on insurance as directed by NAVSEA.
- g. Ensuring that contract modifications for repairs to GFM are not issued when the need for corrective action results from damages of an insurance nature.
- h. Ensuring that any loss or damage that may be the subject of an insurance claim is promptly reported by the contractor in writing to the ACO.
- i. Take the following actions and record the specified information for loss or damage that may be the subject of an insurance claim:

- (1) Contractor's name and contract number.
- (2) Navy classification symbol and hull number, if appropriate (not the contractor's hull number).
- (3) Claim number or job order number.
- (4) Date of occurrence.
- (5) Full description of damage and of accident or event causing damage in simple, non-technical language.
- (6) Estimated or actual cost of repair in full detail.
- (7) Comment on any circumstances that make the contractor responsible for the loss, such as willful misconduct, with the Navy not having title to the material because the material was in the possession of a subcontractor, or where the damages were not accidental. The ACO's investigation concerning responsibility must be thorough (the contractor's investigation will not be the only investigation made). When the ACO considers that there are mitigating circumstances concerning the responsibility of either party, the ACO's comments should provide a full report of the circumstances.
- (8) Comment on any need to place the contractor on notice that, due to a repetitive pattern of claims, the Government would not be liable for any future claims.
- (9) Comment to the extent of the contractor's entitlement.
- (10) Legal review by activity counsel.

7.13.3.3 Notification of Legal Actions Against the Contractor. As required by the insurance clause(s) of job orders or contracts, a contractor will immediately, or as soon as practical, notify the ACO of any legal action filed against the contractor if the legal action arises out of the performance of the contract and if the cost may be reimbursable, the risk is uninsured or the amount claimed is in excess of the amount of insurance coverage. The ACO will then direct the contractor to immediately furnish copies of all pertinent papers received in connection with the claim, if not provided with the contractor's notification. The ACO will also promptly notify the NAVSEA contracting officer, or NAVSEA 02, and NAVSEA counsel of any such legal actions filed against the contractor and forward copies of all papers and statements of available facts concerning any action resulting from bodily injury, death or property damage and involving a member of the public or any employee of the contractor or subcontractor.

APPENDIX A

ARRIVAL CONFERENCE AGENDA	
Introduce key players and their roles	Discuss paper flow of contractor reports
Brief RMC role	Define growth and new work and impact
Brief contractor organization and history	Discuss delay and disruption
Brief local policies and procedures	Explain the contractor's fire watch responsibilities
Explain weekly management review cycle	Discuss housekeeping and safety
RMC explain the contract terms	Have contractors explain their approach
Brief each work item	Discuss procedures of communication
Brief each Standard Item referenced	Have contractors discuss the schedule
Outline key event and milestone dates	Identify the contractor-furnished facilities and services
Discuss contractor's and Ship's Force schedules	Discuss security of the ship and the contractor's facilities
Explain constructive changes and acceptance of work	

(This Page Intentionally Left Blank)

APPENDIX B

FIRE FIGHTING AND FIRE PREVENTION CONFERENCE AGENDA	
Fire alarm and response procedures	Shipboard arrangement including access routes, availability of fire fighting systems (installed and temporary) and communication systems
Contractor fire fighting capability and procedures	Shipboard fire fighting organization, systems, drills and equipment
Municipal fire fighting capability and procedures	Ship, space and equipment security consideration
Fire fighting jurisdictional cognizance	Compatibility of ship, contractor and municipal fire fighting equipment
Communication system for fire reporting and control of fire fighting efforts	Industrial work scope, including location of ship, and effect on fire fighting systems, access and communications

(This Page Intentionally Left Blank)

APPENDIX C

DRYDOCKING CONFERENCE AGENDA	
Date of drydocking and time across the sill	RMC dockmaster responsibilities
Docking position	Contractor dockmaster responsibilities
Tugs and pilots	Line handling
Stability for moving into and out of drydock	Sounding tanks after ship has landed on the blocks
Liquid load	Monitoring weight changes while in drydock
Electrical power	Drydock services
Fire pumps	Drydock safety precautions

(This Page Intentionally Left Blank)

APPENDIX D

“ACTIVITY” PROGRESSING METHOD EXAMPLE	
Rip out	10%
Ship to Shop	5%
Disassemble	10%
Shop Report	5%
Repairs accomplished	20%
Reassemble	15%
Shop Test	5%
Shop to Ship	5%
Reinstall	10%
Test in Place	10%
Final Acceptance	<u>5%</u>
	100%

(This Page Intentionally Left Blank)

APPENDIX E

PROGRESS GUIDELINES					
In-Shop Repair	%	On-Ship Repair	%	Ship Changes	%
Interferences Removed	5	Interference Removed	5	Interference Removed	5
Equipment Removed	15			Rip Out Started	15
Equipment Opened	25	Equipment Opened	20	Rip Out Complete	25
Inspection Report Submitted	30	Inspection Report Submitted	25	Installation Started	35
Repairs Started	35	Repairs Started	30		
Repairs Completed	60	Repairs Completed	60		
Equipment Reassembled	70	Equipment Reassembled	75	Installation Complete	70
Equipment Reinstalled	75				
Interferences Replaced	85	Interferences Replaced	85	Interferences Replaced	75
Testing Completed	95	Testing Completed	95	Testing Completed	90
Test Report Submitted	98	Test Report Submitted	98	Test Report Submitted	95
Touch-Up Completed	100	Touch-Up Completed	100	Touch-Up Completed	100

(This Page Intentionally Left Blank)

VOLUME VII**CHAPTER 8****TESTING, TRIALS, REDELIVERY AND GUARANTEES**REFERENCES.

- (a) NAVSEAINST 3960.4 - Implementation of Total Ship Test Program for Ship Production
- (b) NAVSEAINST 3960.5 - Policy on Ship Testing
- (c) NAVSEA S9095-AD-TRQ-010/TSTP - Total Ship Test Program Manual
- (d) DFARS 222.101 - Labor Relations
- (e) NAVSEAINST 4790.14 - Ship Departure and Alteration Completion Reports
- (f) NAVSEAINST 4700.6 - Guarantee Engineer and Industrial Availability Quality Assessment
- (g) OPNAVINST 4700.7 - Maintenance Policy for U.S. Naval Ships

LISTING OF APPENDICES.

A Work Item Completion Report

8.1 PURPOSE. To provide an overview of the processes and requirements that are to be used in the final phases of the performance period in validating satisfactory completion of all work items through post production testing and trials in preparation for the Naval Supervisory Authority (NSA) to certify completion and redelivery of the ship to the Fleet following a maintenance or modernization availability.

8.2 SCOPE. This chapter provides general guidance and identifies processes, testing and trials plans and specific events and meetings that are the responsibility of the NSA as contract administrator to use in validating that the terms and conditions of the contract have been complied with and certifying completion of the contract. The discussion centers on actions to ensure that the contractors work performance is demonstrated during production acceptance testing and trials. Guarantees are required following preliminary acceptance of the work to offset the cost of any premature failures resulting from poor performance that could not be determined before the ship was redelivered to the Fleet.

8.3 APPLICATION OF TOTAL SHIP TEST PROGRAM TO MODERNIZATION AND REPAIR WORK.

8.3.1 Introduction. Production acceptance testing is required by references (a) and (b). Volume I, Chapter 4 and Volume V, Part I, Chapter 7 of this manual contain additional guidance on Tests and Inspections that may apply to significant modernization availabilities or overhauls.

- a. Depending upon the complexity and duration of the Chief of Naval Operations (CNO) availability, the NSA will ensure that test program management and testing is accomplished in accordance with reference (c). The objectives of the Total Ship Test Program principles are to provide a test program that will effectively and efficiently assure that the work performed by all organizations was properly completed and to assess the ship's readiness to perform its mission at the completion of the industrial period.
- b. The technical and inspection requirements to be met by the contractor are detailed in the work item specifications. Normally, both the work specification and the Naval Sea Systems Command (NAVSEA) Standard Items (or other requirements) referenced in the work item must be used to determine the complete technical requirements, check points and other testing to be satisfied by the contractor.
- c. The extent of system testing required will be determined by an engineering analysis performed by the NAVSEA designated Ship Systems Test Development Director or Combat Systems Test Development Director and will be specified in the Integrated Test Package. The Total Ship Integrated Test Package will be provided according to milestones established by the Regional Maintenance Center (RMC) Project Manager or Supervisor of Shipbuilding Advanced Planning Manager or by the Type Commander (TYCOM) or the ship's Maintenance Team.
- d. Reference (c) contains a detailed description of test methodology, development, organizations, processing, witnessing and test problem reporting.

8.3.2 Ship System Testing (Hull, Mechanical and Electrical). The primary assessment agent for Light Off Assessments will be determined by the Immediate Superior In Command. For major availabilities, a Fleet Engineering Mobile Assessment Team may visit as necessary to conduct inspections onboard the ship prior to the Light Off Assessment so corrective action can be identified and written into the work package, as required.

8.3.3 Combat System Testing. Requirements are invoked in the specifications by appropriate work items based on the NAVSEA standard work item 009-67. Work Item 009-67 tasks the contractor to prepare and manage a comprehensive test plan in accordance with general specifications for overhaul. The Lead Maintenance Activity will develop a test plan, generate test sequence networks, arrange for temporary services to support testing and manage the testing to ensure an orderly and timely completion. Combat system testing normally occurs during the last weeks of the availability. Current NAVSEA guidance has established the following criteria:

- a. For short availabilities, normally less than 120 days, Stage 3 (equipment tests) and Stage 4 (intra-system tests) of the Total Ship Test Program will be scheduled only for equipment and systems modified, overhauled or repaired. Selected additional Stage 4 and Stage 5 through Stage 7 testing will be specified in the Integrated Test Package to check interfaces disconnected or changed during the availability. Except for testing associated with Ship Changes, testing requirements for shorter availabilities is a TYCOM/RMC decision.
- b. Testing requirements will increase proportionally with the length and complexity of the combat system work. Longer availabilities require Stage 3 testing of all equipment, Stage 4 intra-system and Stage 5 through Stage 7 testing of all systems to demonstrate overall combat system operability readiness. Lower level testing of equipment modified, overhauled or repaired will be accomplished by the activity screened to perform the work item.
- c. The industrial activity should accomplish the higher level intersystem testing (Stage 5 and above).
- d. If assigned, the Combat Systems Project Engineer will assist with integration of the work package and develop the Combat Systems Test Sequence Network as an input to the Integrated Total Ship Test Plan. Working with Ship's Force, the In-Service Engineering Activity and Alteration Installation Teams, the Combat Systems Project Engineer is responsible for all applicable stage testing requirements and will confirm that at availability completion, the Combat Systems are ready to commence training.

8.4 TRIALS FOR OVERHAUL AND REPAIR AVAILABILITIES.

8.4.1 General. The Master Ship Repair Agreement (MSRA) discussed in Chapter 3 of this volume requires that if dock trials or sea trials are required by the NSA, the trials will be specified in the job order. Accordingly, the specifications will include requirements for such trials if the trials are considered necessary. For a commissioned ship, the ship is operated by Ship's Force and the contractor normally provides a specified number of personnel by trades to ride the ship. The NSA will provide the ship with the list of personnel who will be onboard for the trial. The Naval Ships Technical Manual contains further information on dock and sea trials. The requirement for these trials will specify a scheduled number of days before the completion of work, usually from four to seven days to allow for adequate adjustment and correction of defects found during the trial. The dock trial should be scheduled from two to four days prior to the sea trial for similar reasons.

8.4.2 Post Repair Trials. When required by the specifications, dock trials and post-repair sea trials are conducted before the completion of modernization and extensive repair availabilities primarily to determine satisfactory work performance by the contractor. The ship's Commanding Officer, in coordination with NSA and Repair Yard, is responsible for the scheduling and conduct of trials, preparation of the trial agenda and arrangement of necessary services.

8.4.2.1 Dock Trials. The primary purpose of this trial is to conduct preliminary checks and tests necessary to ensure the ship is ready for operations at sea. Operation of all equipment during dock trials will be attended by NSA and contractor personnel. In addition to tests of the propulsion and damage control systems, special attention should be given to the electrical, electronic and mechanical equipment required for safe navigation at sea.

8.4.2.2 Fast Cruise. The purpose of this evaluation is for Ship's Force to operate the ship while still secured to the pier, as if the ship were at sea. NSA Representatives may be present to witness the operation of certain equipment whose condition was suspect during dock trials. Special attention is given to operation of the combat systems and casualty control drills during this period.

8.4.2.3 Sea Trials. When a post-repair sea trial is required by the specification, RMC Supervisor of Shipbuilding will provide a list of RMC/NSA and contractor personnel required for the sea trials.

8.5 FINALIZATION PROCEDURES FOR REPAIR AND MODERNIZATION AVAILABILITIES.

8.5.1 General. After completion of the required dock and sea trials, the contractor must remedy all contractor-responsible defects (non-conformities) uncovered during the trials and other work which may be authorized. The contractor must make every effort to complete all unfinished work items by the scheduled job order or contract completion date. Where delays are due to the fault or negligence of the contractor, the contractor should be reminded that failure to meet the scheduled delivery date will make the contractor liable to assessment of liquidated damages, in accordance with the terms of the contract. When the contractor's failure to complete the work within the specified time arises from causes beyond the control of and without the fault or negligence of the contractor, as defined in Clause 15(b) of the MSRA or Agreement for Boat Repair, any additional time required for adjustment of job order price for hotel costs for the ship's crew to complete the work may be granted as a job order modification. Reference (d) contains guidance on labor disputes. Disagreements on whether delays are or are not excusable under the terms of this clause are resolved in accordance with procedures established by Clause 17, Disputes, of the MSRA. Disagreements on whether delays are or are not excusable under the terms of this clause are resolved in accordance with procedures established in the job order contract. In either case, the NSA must obtain an extension of the availability period from the parent TYCOM. If an extension cannot be obtained, the percentage of uncompleted work must be determined.

8.5.2 Availability Completion and Readiness for Sea.

- a. The successful completion of an availability or modernization period depends on reaching a mutual agreement between the NSA and the customer (ship's Commanding Officer, TYCOM, NAVSEA Ship's Program Manager) that all work authorized in the approved work package specifications and supplemental work authorizations have been either satisfactorily completed, or an agreement has been reached concerning a completion plan and schedule for any items partially completed. The job order completion date is determined by the contracting officer and formalized by an Availability Completion Certificate. Format for such certificates varies by NSA offices.
- b. (Surface Force Ships only) The Readiness for Sea (RFS) period is a period immediately following the maintenance or modernization availability period that is scheduled for active Fleet ships to provide time to complete additional preparations before commencing active sea duty. The RFS period allotted to a ship will not normally exceed seven days and will frequently be less. The RFS period may even be omitted entirely when there is an immediate operational need for the ship. If a ship has been assigned an RFS period immediately following a major availability, the contractor is not normally permitted to use this period for the accomplishment of work items which the contractor has been unable to complete by the scheduled delivery date without obtaining authority from the TYCOM/RMC. If such authority cannot be obtained, the RMC should obtain the assignment of a new availability or an extension of the present availability.

8.5.3 Completion Report.

- a. Based on evaluations of work completion made during the final progressing conference, the senior NSA representative at the contractor's yard should prepare a Completion Report reflecting the final status of all authorized work for the Administrative Contracting Officer (ACO) and other NSA personnel. This report should list and describe each work item and indicate for each item:
 - (1) The dollar value assigned.
 - (2) The final percentage of completion, as determined at the final progressing conference.
 - (3) The final amount due the contractor.
- b. In addition, the report should include a statement on the value of any scrap sold by the contractor so that this amount may be deducted from the final sum due. If the contractor has not yet sold such scrap or if the sale is to be handled by a naval activity, an appropriate notation will be made on the Completion Report, Appendix A.

- c. The ACO may subsequently use the Completion Report as the basis for releasing funds retained from progress payments and for final adjudication with the contractor on any revisions in the contract price resulting from uncompleted work, sale of scrap and similar factors. Any disagreements between the contractor and NSA representative on the percentage of completion of unfinished work items or dollar value of uncompleted work may be resolved with the ACO at this time. Once agreement has been reached, a decrease cost supplemental agreement will be prepared reflecting this agreement.

8.5.4 Terminal Inventory Report. After completion of the availability, the contractor must make a terminal inventory of all excess Government property, including material, equipment, scrap and salvage. This report should be forwarded to the NSA property administrator for appropriate disposal action. The quantity or value of any scrap sold by the contractor in accordance with NSA directions should also be included in this report, as well as in the Completion Report.

8.5.5 Release of Retained Funds and Final Payment to the Contractor. The ACO is required under the progress payments provision of the Payments clause of the MSRA and Agreement for Boat Repair to retain funds sufficient to protect the Government's interests at all times. Conversely, as the contractor meets or, by mutual agreement with the ACO, settles contractual obligations, funds previously retained for these purposes should be released for making payments to the contractor.

8.5.6 Release of Retained Funds. On receiving the Completion Report, the ACO will schedule the release of retained funds in accordance with the sequence of events listed below and advise the contractor of the amount that the contractor may be paid on submitting each invoice. Except as indicated below, the ACO has no authority to retain a percentage of the value of progress payments as a guarantee reserve until expiration of the 90-day guarantee period in anticipation of guarantee defects for which the contractor would be responsible.

- a. First Event - Completion and Acceptance of All Work: Release all retained funds, except those estimated by the ACO to be required to cover the net value of the amount due the Government, if any, resulting from the algebraic addition of all estimated cost changes (unsatisfactory work and incomplete work including missing software), liquidated damages and outstanding increased cost changes.
- b. Second Event - Final Payment to Contractor: On receiving the invoice marked Final Payment, release the balance of the funds retained if the adjusted job order price shown on the invoice includes all equitable adjustments for:
 - (1) Decreased cost changes.
 - (2) Contractor-responsible guarantee defects not corrected by the contractor.
 - (3) Increased cost changes adjudicated before the date of final payment invoice.

8.5.7 Final Payment to Contractor.

- a. Based on the Completion Report and after allowing for any payment from the retained funds, the contractor may make the final billing to the NSA for approval and referral to the local payment office. This billing will normally be made for the final sum specified in the Completion Report (or the sum reached as the result of subsequent negotiations between the contractor and the ACO, less the sum of all previous progress payments and the sum of any payment of retained funds).
- b. The balance of retained funds may not be released for payment until all of the conditions prescribed in section 8.6 of this chapter are fulfilled, including delivery of all of the software required by the job order. If spares have been borrowed by the contractor from the ship, funds should be retained to cover the cost until the NSA is notified of the ship receiving the spares. Although the final billing may be made before the disposition of Government property listed on the terminal inventory report, the final billing should not be certified by the NSA for final payment until receipt of the inventory report, even though the report may be negative.
- c. The NSA certification of the contractor's final invoice is similar to certification of invoices for progress payments. In brief, the cognizant NSA representative and the Inspection Officer should first certify that the work for which the contractor claims payment has been satisfactorily accomplished. Appropriate personnel in the Contracts Department should then make a further check to ensure the accuracy of the computations. The ACO should provide an appropriate certifying statement and affix the ACO

signature. The ACO or other appropriate NSA personnel must indicate on the invoice the amount of the total sum to be paid from each cost category or allotment. The invoice is then forwarded to the paying office for final payment.

- d. When liquidated damages are to be assessed against the contractor, the ACO should include a statement with the contractor's final invoice, notifying the paying office to the applicability of the Liquidated Damages clause of the job order. The paying office will then assess liquidated damages based on the NSA calculation of the amount of liquidated damage that is based on scheduled completion date, the actual date and hour of completion as stated in the final invoice and the daily rate established in the job order for the computation of liquidated damages. If the ACO determines that delays in the completion of the vessel are excusable, a job order modification extending the date should be prepared. In the absence of this modification, the paying office will assess liquidated damages based on the stated completion date.

8.5.8 Departure Reports.

- a. In accordance with reference (e), the NSA is required to submit a Departure Report consisting of the following:
 - (1) Ship Departure Report, reference (e).
 - (2) Alteration Completion Report, reference (e).
- b. The reports required by reference (e) apply to the NSA administering contracts for the performance of repairs and alterations to U.S. Navy ships and crafts for all CNO scheduled availabilities and any other availabilities of 3000 man-days or greater. These availabilities include complex overhauls, regular overhauls, selected restricted availabilities, conversions, inactivations, activations and phased maintenance availabilities. Reference (e) is not applicable to new construction and normally will not be applicable to conversions. These reports would be applicable to conversions only when the authorization procedures used parallel those for regular overhauls of the same type of ship.
- c. Departure Reports and Alteration Completion Reports are to be submitted within 60 calendar days after completion of the availability, unless separately negotiated with individual customers.

8.5.9 End of Availability Certification. The NSA will certify to the NAVSEA Ships Program Manager the status of each logistic element with respect to its completed delivery and receipt onboard the ship. Copies of this certification shall be provided to the TYCOM, Planning Yard and the ship. This form is due 30 days after the end of the availability.

8.5.10 Guarantee Engineer and Industrial Availability Quality Assessment Reports. Reference (f) defines the Guarantee Engineer as the manager for the correction of guarantee items on CNO-scheduled modernization or repair availabilities accomplished by naval and private shipyards. NAVSEA policy requires that a guarantee engineer be assigned to each ship completing a major modernization availability. This guarantee engineer will have the authority to establish the contractor's position on all discrepancies and to initiate immediate corrective action on those considered contractor-responsible. In addition, this instruction requires an Industrial Availability Quality Assessment Report for all CNO-scheduled availabilities. Following the completion of the guarantee period, the Guarantee Engineer Report will be submitted to NAVSEA in accordance with the flowchart provided with this instruction. The NSA will flag any discrepancies on the Guarantee Engineer Report with which the NSA disagrees. The Industrial Quality Assessment Report, a comprehensive appraisal of the availability and a narrative assessment of the Guarantee Engineer's Report will be provided, noting any disagreements or questionable data found. Both reports must be submitted within 30 days after completion of the guarantee period.

8.5.11 Integrated Logistic Support Requirements. Reference (g) states that all logistics required for the support of maintenance during the life of new ships or classes will be identified, and necessary resources will be programmed and budgeted, sufficiently in advance of ship deliveries to ensure that all required maintenance logistic support is in place on ship delivery and will be fully supported during the life cycle of the ship. Specific Intergrated Logistic Support reporting is located throughout Volume VI of this manual.

8.6 FINAL ACCEPTANCE.

8.6.1 Guarantee Period. The contractor is responsible for the correction or repair of defects in work performed by the contractor on the ship, if such defects are discovered within a period of 90 days after completion of the job order. The responsibilities of the NSA are specified by Clause 11, Guarantees, of the MSRA and Agreement for Boat Repair. This clause also provides that the starting date of the guarantee period for items which were incomplete at the time of completion of the job order is the date that work on that item is completed. For example, if a pump repair is only 75 percent complete at the time the availability is completed but this repair is finished 10 days afterwards, then the initial guarantee period for this pump repair is end of overhaul plus 10 days to end of overhaul plus 100 days. The NSA will maintain a record of the completion dates of such items to establish the guarantee period.

8.6.2 Correction of Defects. If defects in the work performed or material furnished by the contractor are found during the guarantee period, the NSA will, if practical, afford the contractor an opportunity to effect such corrections and repairs. When the condition, location or operating commitments of the vessel require immediate use of the defective equipment, or for any other reason returning the vessel to the contractor is impractical or undesirable, or when the contractor fails to proceed promptly with the repairs when directed by the contracting officer, such correction and repairs will be effected at the contractor's expense at another location which the Government will determine.

8.6.3 Availability Extensions. If additional time is required for correction of defects, the NSA shall request from the TYCOM or RMC a Continuous Maintenance Availability. The ACO shall obtain certification of completion from the Commanding Officer of the ship once the defect has been adequately corrected. In addition, if the corrective work is of sufficient scope and importance, the ACO may request the NSA nearest to the current location of the ship to act as the inspection officer and provide further certification after satisfactory completion of the work. When qualified private contractors are unavailable in a given area, the contractor may prefer to have a Naval Shipyard perform the work. In such cases, the NSA should contact the Naval Shipyard to determine whether it can accept the work and, if so, to make appropriate administrative arrangements with the shipyard and the TYCOM for performing the work. The contractor will then be required to deposit funds adequate to cover the performance of the work in advance. Excess funds will be returned to the contractor after completion of the work.

8.6.4 Notices to Contractor.

- a. If returning the ship to the contractor is considered practical and feasible, the notice to the contractor will advise the contractor of:
 - (1) The nature of the defects and deficiencies deemed to be the contractor's responsibility.
 - (2) The reason why the contractor is responsible, including references to the applicable job order, specification work item and work item requirements.
 - (3) The place and date the ship will be available for the contractor to inspect the defects and deficiencies involved and the arrangements made for the contractor's inspection.
- b. If returning the ship to the contractor is considered impractical or undesirable, the notice to the contractor will advise the contractor of:
 - (1) Nature of the defects and deficiencies deemed to be the contractor's responsibility.
 - (2) Reason why the contractor is responsible, including references to the applicable job order, specification work item and work item requirements.
 - (3) Explanation why returning the ship to the contractor for repairs is impractical or undesirable.
 - (4) Place and date the ship will be available for the contractor's inspection of the defects and deficiencies involved and the arrangements made for the contractor's inspection.

8.6.5 Work Correction Under Another Naval Supervisory Authority. When permitting the contractor to repair the defect is not practical, the TYCOM/RMC should arrange for an additional availability of the ship under another NSA or at a Naval installation. The original NSA should provide the Authorization Letter and applicable Work Specifications to the other NSA or Naval Installation. The original NSA should be furnished a copy of the Departure Report after completion of the work describing the work performed and the costs incurred. The original NSA should ensure that no other repairs of a non-guarantee nature are included or, if such work were performed, that the repairs are charged to the TYCOM and not to the original contract. Once the costs for the corrective work

have been determined, the NSA should advise the contractor of the costs and should obtain a check in the billed amount made out to the U.S. Treasurer. This check should be deposited at the proper Authorized Accounting Agency with the request that the amount be credited to the funds used originally to pay for the work.

(This Page Intentionally Left Blank)

APPENDIX A
WORK ITEM COMPLETION REPORT

From:	Senior NSA Representative	
To:	Contracting Officer,	
Subject:	DD-175 USS Ready, Completion Report	
Contractor:	Jones Corporation	Type Availability:
Availability:		Work Started:
Arrived:		Undocked:
Dry-docked:		Departed:

<u>Item</u>	<u>Description</u>	<u>Percent Completed</u>
099-00	GENERAL CRITERIA (NEW 3/73)	
099-02	CALIBRATION AND CERTIFICATION REQUIREMENTS (2/73)	
099-04	CHECK POINTS (2/73)	
099-06	ABRASIVE BLASTING	
099-09	PROCESS CONTROL PROCEDURE REQUIREMENTS (2/73)	
099-14	DOCUMENTATION (2/73)	
099-23	INTERFERENCE (2/73)	
099-50	GOVERNMENT PROPERTY (NEW 3/73)	
099-51	GANGWAYS/BROWS (NEW 3/73)	
099-52	KEY EVENT/REPORT SCHEDULE FOR SHIPS (NEW 3/73)	
099-62	PROCUREMENT OF PARTS (REV 10/73)	
099-63	INSTALLATION OF ELECTRICAL AND ELECTRONIC CABLES (NEW 3/73)	
099-64	PAINT WORK (NEW 6/73)	
099-65	POST REPAIR TRIALS	
099-66	TEMPORARY SERVICES	
099-67	TOWBOAT SERVICES	

<u>Item</u>	<u>Description</u>	<u>Percent Completed</u>
099-68	GAS FREEING LOT I (APPLICABLE TO LOT I ONLY)	
099-68	GAS FREEING LOT III (APPLICABLE TO LOT III ONLY)	
099-70	PURCHASE ORDERS AND PURCHASE ORDER INDEX (NEW 8/73)	
099-72	INSPECTION SYSTEM REQUIREMENTS (NEW 8/73)	
999-01	DRYDOCKING AND UNDOCKING	
999-02	STATIC GROUNDING	
999-03	UNDERWATER HULL INSPECTION	
999-04	BOTTOM CLEANING AND PAINTING	
999-05	WATER SLEEVES REPAIR	
999-06	FATHOMETER TRANSDUCER REPLACEMENT	
999-07	RUDDER REPAIRS	
999-08	UNDERWATER LOG VALVE REPAIRS	
999-09	DRAFT MARKS VERIFICATION (S/A 150K IN PART)	
999-10	SEA VALVES REPAIR	
999-11	PROPELLER REPAIRS	
999-12	SHAFTING AND BEARINGS	
999-8	CATHODIC PROTECTION, ANODES REPLACEMENT	

8,000 lbs of Scrap sold by the contractor

I certify that the above percentage of completion is correct as of date shown, all Navy-owned Scrap has been accounted for, and all reports and test results as required have been received.

Senior NSA Representative

VOLUME VII
CHAPTER 9
PROPERTY ADMINISTRATION

REFERENCES.

- (a) Federal Acquisition Regulation (FAR) Part 45 - Government Property
- (b) Defense Federal Acquisition Regulation Supplement (DFARS) Part 245 - Government Property
- (c) Navy and Marine Corps Acquisition Regulation Supplement (NMCARS) Part 5245 - Government Property
- (d) NAVSEA Contracts Handbook (NCH), Part 45 - Government Property
- (e) Department of Defense (DoD) Manual 4161.2 - Manual for Performance of Government Property Administration
- (f) DFARS 245.505 - Records and Reports of Government Property
- (g) NMCARS 5245.505 - Records and Reports of Government Property
- (h) DFARS 245.7001 - Selection, Appointment and Termination
- (i) DFARS 245.7002 - Duties and Responsibilities of Plant Clearance Officers
- (j) 10 USC 1724 - Defense Acquisition Workforce Improvement Act (DAWIA)
- (k) DD Form 1638 - Report of Disposition of Contractor Inventory
- (l) FAR 45.6 - Scope of Subpart
- (m) FAR 45.102 - Policy
- (n) FAR 45.5 - Management of Government Property in Possession of the Contractor
- (o) FAR 45.306 - Providing Special Tooling
- (p) FAR 45.307 - Providing Special Test Equipment
- (q) FAR 45.310 - Providing Agency Peculiar Property
- (r) FAR 45.302 - Providing Facilities
- (s) FAR 45.301 - Definitions
- (t) DFARS 245.302 - Providing Facilities
- (u) NMCARS 5245.302 - Providing Facilities
- (v) DFARS 245.301 - Definitions
- (w) DoD Automation Resources Manual 7950.1-M
- (x) FAR 45.4 - Contractor Use and Rental of Government Property
- (y) FAR 52.245-4 - Government-Furnished Property (Short Form)
- (z) DFARS 245.6 - Reporting, Redistribution and Disposal of Contractor Inventory
- (aa) DFARS 245.608-70 - Contractor Inventory Redistribution System (CIRS)
- (ab) OPNAVINST 5090.1 - Environmental and Natural Resources Program Manual
- (ac) FAR 52.245-2 - Government Property (Fixed Price Contracts)
- (ad) Naval Facilities Engineering Command (NAVFAC) Manual MO-322 - Inspection Guides, Structural, Mechanical and Electrical
- (ae) NAVFAC Technical Publication DM-29 - Drydocking Facilities

9.1 SCOPE. Government property administration will be accomplished in accordance with specific contract requirements and references (a) through (e). This chapter provides additional guidance to be used in application of Government property administration. When terms of the contract conflict with other directives, the terms of the contract will generally govern.

9.2 REAL AND PERSONAL PROPERTY. Government Property includes all property, both real and personal, and generally falls into one of the following types of property:

- a. Land.
- b. Other Real Property.
- c. Industrial Plant Equipment.
- d. Other Plant Equipment.
- e. Special Tooling.

- f. Special Test Equipment.
- g. Agency Peculiar or Military Property.
- h. Material - Government Furnished Material (GFM) and Contractor Furnished/Provided Material (CFM).

9.2.1 Government Property Types. Definitions of types of Government Property are found in reference (a) and (b). The following paragraphs provide key additional information.

- a. Government property consists of both Government Furnished Property (GFP) and contractor-acquired property. GFP is property that the Government has possession of and provides to a contractor or directly acquires to provide to the contractor, including related data and information requested or furnished to the contractor that is reasonably required for the intended use of the property. The definition of GFP is especially important in the material area because of the requirement to report, as a separate line, the value of GFM on DD Form 1662 of references (f) and (g).
- b. Contractor acquired property is property acquired or otherwise provided by the contractor for performing a contract and to which the Government has/takes title. When a contract is a cost type, all property purchased as a direct charge to the contract becomes Government-owned contractor-acquired property. Under fixed price and fixed price incentive contracts, all property purchased by the contractor which is spelled out as a line item in the contract or is a change order line item becomes Government-owned contractor-acquired property. A requirement exists to report the value of Contractor Acquired Material as a separate line on the DD Form 1662 of reference (f).
- c. CFM is a term in common use in the property administration field that is not used in the Federal Acquisition Regulation or Defense Federal Acquisition Regulation Supplement. CFM is considered to be material provided by the contractor to which the Government has acquired a lien or title solely because of partial, advance or progress payments (usually a fixed price contract). The requirements of reference (a) do not apply. This definition allows the discussion of all types of material in the contractor's possession related to a fixed price contract, that is: GFM and Contractor Acquired Material, which are covered by reference (a) requirements and CFM, which is not covered under reference (a) requirements. Any other property to which the Government acquired title or lien solely because of partial, advance or progress payments can be considered contractor-furnished property to which the requirements of reference (a) do not apply.

9.2.2 Duties and Responsibilities for Contract Administration of Government Property.

9.2.2.1 Head of Regional Maintenance Center Contracts Department.

- a. Select, appoint and terminate Property Administrators in writing to comply with references (e) and (h).
- b. Appoint the Plant Clearance Officer in writing with responsibilities as outlined in reference (i). The Property Administrator may serve in this capacity.
- c. Validate that Property Administrators and Plant Clearance Officers have completed and continue to satisfy the mandatory training course requirements for their certification level as required by reference (j).

9.2.2.2 Regional Maintenance Center Property Administrator Duties and Responsibilities.

- a. Administer Government Property per the guidance in references (a), (b), (c) and (e) and as outlined in the Government Property Clauses or specific contractual provisions (e.g., Insurance clauses and the Liens and Title Clause) of each contract ensuring that all types of government property are considered in property administration oversight.
- b. Conduct annual property control surveys and validate that the contractor's approved Property Control Procedures comply with government requirements and contract clauses for the upcoming fiscal year.
- c. Review each contract to determine the requirements and clauses in effect concerning GFM, Government Furnished Information, CFM, Special Tooling and Test Equipment, Rental of Property and Agency – Peculiar Property.
- d. Verify that contract clauses exist which allows contractor access to the supply system for purchase of material for particular purposes such as "cash sales".

- e. Oversee disposition of excess government property as prescribed in the contract or direct disposition when required. This includes submitting a quarterly report per reference (k).
- f. Ensure the transfer of Government property between contracts when required.
- g. Certify that contractors annually, as required by contract, enter data in the appropriate contract property information system or submit information to Assistant Secretary of the Navy (Research, Development and Acquisition).
- h. With the Contracting Officer authorization, coordinate the repair or modification of Government Furnished Property when it has been received in a condition that is not suited for its intended use.
- i. Administer all facility contracts and leases for which Regional Maintenance Center (RMC) has been designated contract administrator, either by specific letter, contract document or by Naval Sea Systems Command (NAVSEA) instruction.
- j. When required, supervise the contractor's preparation and maintenance of property record cards for Class III property, maintaining individual equipment identification logos, ensuring that equipment is properly marked and identified and taking periodic inventories.
- k. Ensure that contractors use facilities in accordance with lease agreements and in the event that the involved contractor is using the facilities for commercial work when such work is not authorized, immediately direct the contractor, in writing, to cease the unauthorized use.
- l. Review and approve the contractor's program for the inspection, maintenance, repair, adjustment, protection and preservation of equipment under facilities contracts. Such reviews are conducted at the inception of a contract and at least annually thereafter, as long as the facilities remain in the contractor's possession.
- m. Monitor rental payments for facility contracts, floating drydock leases and production equipment leases to ensure payment in accordance with the agreements and report pertinent information to NAVSEA as required.
- n. For government-owned facilities, when required, verify that the contractor or lessee maintains the proper type of insurance in amounts acceptable to the Insurance Examiner of the Navy.
- o. Provide the annual inspection of civil works.
- p. Arrange for periodic inspections of fire protection measures at reserve plants under RMC's cognizance.
- q. Maintain Shore Facilities Planning System documents for facilities under RMC's cognizance.
- r. Administer the removal/transfer and disposal of facilities under RMC's cognizance.

9.2.2.3 Contractors.

- a. Annually, as required by contract, enter data in the appropriate contract property information system or submit information to Assistant Secretary of the Navy (Research, Development and Acquisition).
- b. Identify Government property when it is no longer needed to perform the contract, in accordance with reference (l), the terms and conditions of the contract, and report excess property to the Plant Clearance Officer.
- c. Coordinate the disposal of all government property with the Plant Clearance Officer as directed by contract or in compliance with Contractor Inventory Redistribution System (CIRS) or other Navy plant clearance programs designated for the reutilization and disposal of excess material.
- d. Coordinate the disposal of hazardous material and hazardous waste in accordance with the terms and conditions of the contract and in coordination with the Plant Clearance Officer and Environmental Coordinator.

9.3 PROVIDING GOVERNMENT PROPERTY TO CONTRACTORS.

9.3.1 Property. Under reference (m), contractors are ordinarily required to furnish all property necessary to perform Government contracts. If contractors are provided Government property, the Navy is required to ensure that the requirements of reference (m), concerning minimization of competitive advantage, use of Government property only as authorized, rental when appropriate, contractor responsibility and accountability, contractor justification for retention and reutilization of contractor inventory within the Government, are met.

9.3.2 Material.

- a. Contractors ordinarily furnish all material for performing Government contracts. The Navy provides material to a contractor when necessary to achieve significant economy, standardization, expedited production or when otherwise in the Government's best interest in accordance with references (a) and (b). These directives also provide guidance for economic utilization of available Government-owned material as GFM (in lieu of CFM).
- b. In repair and overhaul contracts, GFM is usually identified by the Planning Activity in the schedule of the contract or the specifications. In new construction contracts, GFM is usually identified in Schedule A of the contract, with Government Furnished Information identified in Schedule C. Outfitting material provided as GFM is usually identified (by the Navy Inventory Control Point - NAVICP, Mechanicsburg, PA) in the Consolidated Shipboard Allowance List, which is considered to be part of the contract.
- c. During the performance of the contract, if the contractor has difficulty in obtaining CFM for contract use, the Government has three options:
 - (1) Issuing a supplemental agreement authorizing substitute material (with no degradation or increase in contract price and appropriate reduction in price if substitution results in lower overall cost to contractor).
 - (2) Authorizing the contractor to obtain the required CFM through the "cash sales" procedure in accordance with Naval Supply Systems Command guidance.
 - (3) Issuing a supplemental agreement converting the CFM to GFM with a decrease in contract price and release of any government responsibility for delay or disruption if subsequent material is not received in a timely manner. This method should only be used as a last resort.
 - (4) The Property Administrator should ensure that contractor's approved Property Control Procedures address special considerations when any of the three options are used.

9.3.2.1 "Cash Sales" Procedures.

- a. Naval Supply Systems Command Manuals contain procedures to permit contractor purchase from Navy sources, as well as providing direction to the Administrative Contracting Officer for developing local instructions on use of the cash sales method. The Property Administrator must ensure that the contractor has specific procedures to address requests for cash sales purchases, as well as procedures for receiving and tracking of cash sales material to ensure that all Navy policies and requirements for control, use and return (if required) of cash sales material are met. The Property Administrator will include a review of the contractor procedures during the annual/biennial contractor property control surveys. The Navy Supply System considers all purchases from the supply system that are not Government requisitions to be cash sales because of the method of payment used. NAVSEA refers to cash sales only for unique circumstances where the Government is providing assistance to the contractor to meet contract requirements without the administrative burden of contract modification. Other contract clauses exist which allow contractor access to the supply system for purchase of material for particular purposes. The Property Administrator must review the individual contract upon award to determine if such a clause has been included.
- b. RMC monitoring of contractor access to the supply system for purchase of material, excluding the Navy cash sales procedure, should be kept to a minimum. Involvement will vary depending on the type of contract. In all cases other than cash sales, the supply system is another vendor for the contractor. The material purchased by the contract will be covered by reference (n) requirements if purchased under a

cost type contract or as a line item under a fixed price contract. If the material is purchased under a fixed price contract (and not defined as a line item purchase), reference (n) requirements do not apply. RMCs should still monitor contractor actions under fixed price contracts in order to ensure that no fraud, waste or abuse is occurring. The property is CFM (if not a line item purchase) and Government oversight of that material is limited.

9.3.3 Special Tooling. Reference (o) gives direction for providing special tooling to contractors both existing special tooling and special tooling purchased by the contractor under cost-reimbursement contracts (Government acquires title) and fixed price contracts (Government may or may not acquire title). Special tooling requirements and clauses may vary between contracts. Therefore, the Property Administrator must review each contract carefully to determine the requirements and clauses in effect.

9.3.4 Special Test Equipment. Reference (p) addresses requirements for providing existing Government-owned special test equipment as well as requirements for acquiring special test equipment. It also references applicable Federal Acquisition Regulation clauses.

9.3.5 Agency-Peculiar Property. Reference (q) notes requirements for providing the contractor with agency-peculiar property (i.e., military property).

9.3.6 Facilities. Contractors are required to furnish all facilities required for performing Government contracts except as provided under reference (r). Reference (s) addresses the requirements for facilities contracts when the Government does provide facilities. Additional facilities determinations and approval guidance is provided in reference (t). Reference (u) gives specific Navy guidance on determinations and approval for providing facilities.

9.3.7 Industrial Plant Equipment. Reference (v) relates requirements for providing industrial plant equipment with an acquisition cost of \$15,000 or more.

9.3.8 Automated Data Processing Equipment. Reference (t) provides guidance to Administrative Contracting Officers on processing acquisition of automatic data processing equipment to the Defense Information Systems Agency in accordance with reference (w).

9.4 CONTRACTOR USE AND RENTAL OF GOVERNMENT PROPERTY. Reference (x) prescribes policies and procedures for use and rental of Government production and research property. Generally Government use is on a rent-free basis. Non-Government use is on a rental basis. RMCs administer very few contracts that allow rental of Government property for non-Government use. The value of those administered is very small. The Government Property Administrator must be aware of any rental clauses, since utilization rates for the property must consider Government and non-Government utilization.

9.5 ADMINISTRATION OF GOVERNMENT PROPERTY.

9.5.1 Regulation and Contractual Requirements. The primary contractual clauses affecting the administration of Government property are the Government Property clauses of reference (y). They may be used in solicitations and contracts when a fixed price, time-and-material or labor-hour contract is contemplated where the acquisition cost of all GFP is \$100,000 or less.

9.5.1.1 Oversight of Contractor Operations. Reference (x) and its supplemental documents contain extensive and detailed administrative requirements regarding Government property. The most detailed guidance is provided in Chapter 5 of reference (e), which addresses special topics related to the property administration process that may be applicable to property administrators. The Property Administrator must ensure that all types of government property are considered in property administration oversight. Property to which the Government has acquired a lien or title solely as a result of advance, progress or partial payments is not subject to the requirements of reference (n). There are special provisions related to the disposition of excess Government property related to fixed price incentive contracts that are not applicable for other types of fixed price contracts as explained in paragraph 9.5.3.5 of this chapter. The property administrator may be involved in review of contractor furnished material for fixed price contracts under other contracts requirements related to areas such as Material Management and Accounting Systems, but not under reference (n) requirements.

9.5.1.2 Liens and Title Clause. Specific contractual provisions that affect the administration of Government property (e.g., the Insurance clauses and the Liens and Title clause) are usually included in contracts. The Liens and Title clause in fixed price contracts does not affect the reference (a) guidance that property to which the Government acquires a lien or title solely as the result of advance, progress or partial payments is not subject to the requirements.

9.5.1.3 Transfer of Government Property Between Contracts. The Property Administrator must ensure that transfer of Government property between contracts is accomplished in accordance with reference (c). Excess Government property from one contract should be transferred for use on another contract where a need is identified, but must not be transferred to another contract where a need for the property is not identified.

9.5.1.4 Annual Property Administration Plan and Report. At the beginning of each fiscal year, each RMC shall schedule analyses of the contractor's system for property administration to be conducted for all active contractors during the upcoming fiscal year.

9.5.1.5 Annual Reports. For contracts that require annual property reports, property administrators and contractors should enter data in the appropriate contract property information system no later than 15 November at <http://web1.dcmde.dema.mil/cpms/> or mail paper copies of the certified DD 1662s of reference (f) to:

Assistant Secretary of the Navy (Research, Development and Acquisition)
OASN (RDA)ACQ,
1000 Navy Pentagon BF992
Washington, DC 20350-1000

9.5.1.6 Additional Reports. In accordance with reference (b), each RMC will submit a DD Form 1638 report to NAVSEA on a quarterly basis. Reports are required at NAVSEA by 15 October, 15 January, 15 April and 15 July. The Remarks Block of the form should be used to explain major increases or decreases in value of excess property reported and/or dispositioned. Excess property reutilized on other Government jobs or contracts at the contractor facility should not be reported on the DD Form 1638.

9.5.2 Responsibilities and Duties. Whatever the organizational alignment, personnel designated as Government Property Administrators are primarily responsible for the administration of contractual provisions related to Government property.

9.5.2.1 Appointment and Duties of Property Administrators. The selection, appointment and termination of appointment of property administrators shall be made in writing by the Head of the Contract Administration Office or designee. Reference (h) addresses selection and appointment/termination requirements. Reference (e) addresses the duties and responsibilities of the Property Administrator.

9.5.2.2 Appointment and Duties of Plant Clearance Officers. The Plant Clearance Officer shall be appointed in writing by the Head of the Contract Administration Office or designee. The Property Administrator may serve as the Plant Clearance Officer. Reference (w) delineates Plant Clearance Officer duties.

9.5.2.3 Training Requirements for Property Administrators and Plant Clearance Officers. Property Administrators and Plant Clearance Officers will satisfy the mandatory training course requirements for their certification level as required by reference (j).

9.5.3 Plant Clearance.

9.5.3.1 Procedures. In accordance with reference (l), contractors are to identify Government property when it is no longer needed to perform the contract. The Plant Clearance Officer should work with contractors to ensure excess Government property is disposed of in a timely manner by established time frames for reporting excess Government property with contractors.

9.5.3.2 Disposal Methods. References (l) and (z) address the plant clearance process and reference (aa) stipulates the use of the CIRS. The Navy has established other plant clearance programs to expedite and increase reutilization and disposal of excess material that should be utilized prior to CIRS actions. New, ready-for-issue, standard stock-numbered material may be returned to the Navy supply system through the Material Turn Into Stores program. Non-standard, ready-for-issue material may be returned through the Material Returns Program for identification and reutilization screening. Other Navy programs that are appropriate for the particular type of excess material to be disposed may be utilized. Disposition of Automated Data Processing equipment, Industrial Plant Equipment and special test equipment should follow procedures in reference (z). CIRS may be utilized for disposal of excess material that cannot be handled by the Navy disposal program.

9.5.3.3 Disposing of Hazardous Material/Hazardous Waste. The distinction of hazardous material and hazardous waste is important, particularly regarding the disposal actions. Reference (ab) provides the following definitions:

- a. Hazardous Material (or hazardous substance): Any material, which because of its quantity, concentration or physical, chemical or infectious characteristics may pose a substantial hazard to human health or the environment when released or spilled.
- b. Hazardous Waste: Any waste material, liquid, solid or gaseous, that because of quantity, concentration or physical or chemical characteristics may:
 - (1) Cause or significantly contribute to an increase in mortality or to a serious and irreversible or reversible but incapacitating illness.
 - (2) Pose a substantial present or potential hazard to human health or the environment when improperly treated, stored, transported, disposed or otherwise managed. This excludes infectious and radioactive waste. If infectious or radioactive wastes are mixed with an EPA/state-regulated hazardous waste, then the hazardous constituents remain regulated as a hazardous waste. Hazardous waste does not include hazardous material with an expired shelf life unless designated as such by a Defense Reutilization Marketing Service.

Coordination between Plant Clearance Officer and the Environmental Coordinator is necessary to ensure that excess hazardous material and hazardous waste are properly identified for disposition actions in accordance with contract requirements and federal, state and local environmental regulations.

9.5.3.4 Disposal Actions Resulting From Engineering Changes. Under fixed price contracts, engineering changes may result in CFM being converted to Government property. If the contractor has already purchased material to perform a part of the contract covered by the fixed price and that part is changed so that the contractor can no longer use the material, the engineering change will normally identify the material for purchase by the Government. The contractor should have a system to ensure that the material is identified to the Plant Clearance Officer as excess Government material. The Plant Clearance Officer then follows normal procedures to dispose to the material.

9.5.3.5 Disposal Provisions Under Different Types of Contracts.

- a. The need of the Government for the excess material should be considered in determining title to excess material since there is a cost to the Government associated with disposal actions. Contractor needs for the excess material may also be considered in determining title, as well as “value” to be credited to the contract if the contractor retains the material. The value credited to the contract will vary depending on the needs of the Government and the needs of the contractor. The value of the material can be zero, depending on the material and circumstances associated with disposal actions.
- b. Identifying excess Government property under firm-fixed-price and cost-reimbursable type contracts is straightforward.
 - (1) Under firm-fixed-price contracts, all excess GFP and property paid for as a line of the contract (outside the firm-fixed-price) is considered to be Government property for the Government plant clearance actions (though the form of the Liens and Title clause must be followed in the plant clearance process).
 - (2) In cost-reimbursable contracts, all excess GFP and excess contractor-acquired property accountable to the contract is considered Government property for plant clearance operations. Fixed price incentive contracts (with the fixed price Government property clause) require a more involved process to distinguish excess Government property (to be disposed through the plant clearance process) from excess contractor-owned property for contractor actions. The incentive portion of the contract creates a share line between the Government and the contractor. Other clauses in the contract may affect ownership of excess. Identification of ownership of residual contractor furnished material under the fixed price incentive contracts requires the coordination of the Property Administrator, Plant Clearance Officer and contracting officer, as well as NAVSEA 02, 00L and 04.
- c. The contractor is required to provide a list of all residual material on the fixed price incentive contract to the Government.
 - (1) If the Government takes title to the material, no further contract actions are required.

- (2) If the Government does not take title to the material and the material is retained by the contractor, the contract must be credited for the value of the material (the value may be negotiated). The Government may take title to only part of the residual, with the remainder going to the contractor and the contract being credited for only the value of the material going to the contractor.

9.6 RESPONSIBILITIES OF THE CONTRACTOR. Specific contract requirements determine responsibilities of the contractor. However, reference (n) was developed to allow the Government to review an entire system of contractor-Government property control. The Property Administrator must be aware of unique or additional contract provisions to ensure that the contractor adjusts his Government property control system to meet special requirements.

9.7 REPAIR OR MODIFICATION OF GOVERNMENT FURNISHED PROPERTY. When Government property is furnished to a contractor and is received in a condition not suited for its intended use, the contracting officer may, under the terms of the Government Property clause or other contract provision, direct the contractor to affect the necessary repair or modifications. Equitable adjustment in the contract price and other provisions may be necessary following procedures in the "Changes" clause or other provisions of the contract. Reference (ac) provides procedures to allow effective and economic ordering and pricing of repair or modification of GFP.

9.8 FACILITIES AND LEASES.

9.8.1 General. The RMC is responsible for the field administration of all facility contracts and leases for which it has been designated contract administrator, either by specific letter, contract document or by NAVSEA instruction. The RMC may also be assigned responsibility for administering the National Security clause in instruments of sale of industrial facilities.

9.8.2 Property Accountability. The cognizant RMC has property accounting responsibility for facilities which exist regardless of whether the facilities are under NAVSEA contracts, leases or permits for which representatives of other offices are the contract administrators. The responsibility includes supervising the contractor's preparation and maintenance of property record cards for Class III property, maintaining individual equipment identification logos, ensuring that equipment is properly marked and identified and taking periodic inventories. These functions are performed in accordance with the requirements of the Navy Comptroller Manual.

9.8.3 Use of Facilities. Facilities contracts may limit the contractor's use of the facilities to specified NAVSEA contracts or to other specified work. In the event that the involved contractor is using the facilities for commercial work when such work is not authorized, RMC will immediately direct the contractor, in writing, to cease the unauthorized use. When the unauthorized use is in performance of another Government contract, the RMC will inform the contractor that it must seek proper contractual authorization for use. All instances of unauthorized use of facilities will be reported in detail to the cognizant facility's contracting officer.

9.8.4 Rental Payment. NAVSEA facilities contracts, floating drydock leases and production equipment leases provide for rental payments to the Government on various bases. Rental payments are made monthly, quarterly or annually. To ensure prompt payment, the cognizant RMC should obtain from the contractor either a copy of the letter transmitting the rental payment to the Agency as designated in the lease/rental agreement or other assurances of payment, as necessary. When rental payments become 30 days overdue, the RMC should notify NAVSEA describing the circumstances. The RMC should also furnish NAVSEA with any other pertinent information it may have about the contractor's financial condition, so that NAVSEA may take appropriate action with regard to the delinquency. Any questions involving interpretation of the method of computing the amount of rental payments also should be referred to NAVSEA for clarification.

9.8.5 Insurance. When insurance of Government-owned facilities is required by the terms of the contract or lease, it is the RMCs' responsibility to see that the contractor or lessee carries the proper type of insurance in amounts acceptable to the Insurance Examiner of the Navy.

9.8.6 Need for Funds. The cost of normal maintenance and security for each facility must be borne by the contractor, lessee or occupant to the extent of its responsibility under the agreement. The cost of long term or Capital Maintenance may be funded by NAVSEA or through Contracting Officer approved use of lease revenue for Capital Maintenance projects with Not to Exceed ceilings. The RMC will monitor the contractor/lessee

maintenance efforts and inform NAVSEA of problems, if any, and when approved maintenance has been completed. In addition, the RMC should continually study and make recommendations as to the means by which preservation of essential reserve production capacity at reserve plants can be maintained on a self-supporting basis whenever possible.

9.8.7 Maintenance Responsibility Under Facilities Use Agreements.

- a. NAVSEA facilities contracts and leases generally require the contractor to protect, maintain, preserve and repair the facilities involved in accordance with sound industrial practices. Capital expenditures are not the contractor's responsibility and capital repairs at Government expense can generally be made only on the basis of specific authority and funding from the NAVSEA contracting officer.
- b. The beginning of the non-use period should be considered as that point at which productive use for the Government has terminated. Termination for productive use for the Government generally comes with the delivery of the last ship or boat to the Government. Incidental use of transportation or other equipment in connection with the storage and disposal of surplus Government-owned material and equipment alone should not delay the beginning of the non-use period.
- c. Prior to the time when maintenance expenses will become reimbursable by the Government under the contract, the contractor, in conjunction with the RMC, should prepare a maintenance and protection plan and budget, according to NAVSEA maintenance and protection standards. This plan and budget should then be forwarded to NAVSEA for approval. If the plan and budget are approved by NAVSEA, expenses incurred in performing the work are reimbursable under the facilities contract. The contractor should prepare and submit separate invoices for work performed in accordance with the approved plan and budget.

9.8.8 Inspection and Report of Machinery and Equipment Maintenance. The property administrator must review and approve the contractor's program for the inspection, maintenance, repair, adjustment, protection and preservation of equipment under facilities contracts. Such reviews are conducted at the inception of a contract and at least annually thereafter, as long as the facilities remain in the contractor's possession.

- a. The property administrator's inspection and intervening spot checks should be sufficiently detailed to determine that the machinery and equipment are receiving the care that the contract and good industrial practice require. Maintenance practices must include lubrication of bearings and other moving parts, adjustments for wear of moving parts before deterioration of associated parts takes place and regular and proper cleaning. Any evidence of inadequate care, unsatisfactory performance or possible damage to machinery or equipment that is discovered by the property administrator should be fully investigated.
- b. Maintenance inspection by the field office must include Navy machinery and equipment that is in storage or that is idle pending transfer. The removal of the machinery or equipment to storage or its contemplated transfer does not relieve the contractor of its maintenance responsibilities. The contractor is responsible for seeing that the property is properly handled and safeguarded against damage when it is moved into storage or prepared for transfer to a new location. Some time may elapse between the date on which machinery or equipment is reported idle and the date of its shipment to a new location. Prior to the removal of the machinery or equipment in such cases, the RMC should determine whether any damage, loss or deterioration that might alter the decision to transfer the property has occurred. If such a change has occurred, NAVSEA should be notified and confirmation or revision of the shipping order requested.
- c. Immediately following each maintenance inspection or spot check, the RMC shall notify the contractor by letter of any deficiencies that have been noted and direct it to take appropriate corrective action. Follow-up letters should be sent to the contractor as necessary to ensure that the deficiencies are corrected. Copies of all such letters shall be sent to NAVSEA. Any damage, excessive wear or deterioration of machinery or equipment should be recorded on all copies of the property record card, with a statement of the corrective action taken to repair the damage. If a periodic inspection of a plant (other than an occasional or spot check) discloses no deficiencies in the care, maintenance or use of the Navy-owned machinery or equipment and if the RMC is fully satisfied that the contractor is fulfilling its contractual obligations in this respect, NAVSEA should be so informed by letter. Whenever a

recommendation is made that maintenance should be accomplished, as a financial responsibility of NAVSEA, an estimate of the cost of making such repair should be included, along with an explanation of why the cost is considered NAVSEA's responsibility.

9.8.9 Inspection and Report of Maintenance of Civil Works.

- a. The Naval Facilities Engineering Command Engineering Field Division provides technical services to the RMC in connection with the inspection and maintenance of civil works. Civil works include lands, structures and utilities owned by the Government that are operated by contractors, are in the possession of contractors or are held under the National Security clause. Transportation and weight handling equipment are also considered civil works for purposes of this inspection. It is the RMC's responsibility to see that civil works are inspected at least annually (unless this requirement has been specifically waived by NAVSEA).
- b. Civil works inspections, conducted in accordance with reference (ad), are made by a team composed of representatives of the RMC, the Facilities Engineering Office (FEO) and the contractor. If the plant is under the administrative control of the General Services Administration, a representative of that agency will also participate in the inspection. Any deficiencies noted in the civil works should be called to the attention of the contractor's representative during the inspection.
- c. Following the inspection, the FEO submits a report of the deficiencies noted, with its recommendations for corrective action. This report is submitted to the RMC, with copies sent directly to NAVSEA by the FEO. The RMC, in turn, furnishes NAVSEA with its comment on the report and any special recommendations it may wish to make. The RMC also provides a copy of the report to the contractor and requests the contractor to submit a schedule of dates by which the recommended maintenance will be completed. With the assistance of the FEO the RMC then takes appropriate follow-up action to ensure that the work is, in fact, completed. If the RMC feels that the work is the responsibility of the Government rather than the contractor, NAVSEA should be so informed, with supporting reasons, contractor's estimate of cost and the FEO's comment as to the reasonableness of the estimate.

9.8.10 Inspection of Dry Docks. Periodic inspections of dry docks under facilities contracts or leases administered by the RMC shall be made in accordance with reference (ae).

9.8.11 Fire Protection Measures. The RMC is responsible for arranging for periodic inspections of the fire protection measures at the reserve plants under its cognizance. Inspections shall be made annually unless NAVSEA specifically waives this requirement. A waiver should be requested only in exceptional circumstances.

9.8.12 Inspection and Report of Mobilization Readiness. NAVSEA is required to submit to the Secretary of Defense annual inspection reports with regard to each plant in the National and Departmental Reserve for which NAVSEA is responsible. These reports are prepared by RMC and must be submitted to NAVSEA no later than 15 August each year. The preparation of the report should be correlated with the report of the annual inspection of civil works.

9.8.13 Shore Facilities Planning System. Except where the requirement has been specifically waived, the RMC is responsible for maintaining the Shore Facilities Planning System documents for facilities under its cognizance.

9.8.14 Redistribution and Disposal. The RMC is responsible for administering the removal, transfer and disposal of facilities under its cognizance. In addition, idle production equipment in industrial reserve plants should be reported to NAVSEA for further reporting by NAVSEA to the Defense Industrial Plant Equipment Center. No facilities may be removed or transferred from a facilities project until authority to do so has been received from NAVSEA.

VOLUME VII
CHAPTER 10
ENVIRONMENTAL, SAFETY AND HEALTH

REFERENCES.

- (a) OPNAVINST 5090.1 - Environmental and Natural Resources Program Manual
- (b) NAVSEA Standard Work Item 077-01 - Hazardous Waste Produced on Naval Vessels; control
- (c) Federal Acquisition Regulation (FAR)
- (d) Occupational Safety and Health Act of 1970
- (e) 29 CFR 1910 - Occupational Safety and Health Standards
- (f) OPNAVINST 5100.23 - Navy Occupational Safety and Health (NAVOSH) Program Manual
- (g) NAVSEA S9086-CH-STM-030 - NSTM Chapter 074 V3 (Gas Free Engineering)
- (h) National Fire Protection Association Codes and Standards 306 - Standards for the Control of Gas Hazards on Vessels
- (i) 10 USC 7311 - Repair or Maintenance of Naval Vessels: Handling of Hazardous Waste

10.1 PURPOSE. This chapter outlines Navy policies and Regional Maintenance Center (RMC) responsibilities associated with the protection of the environment, the safety and health of government personnel and the safety of government property in private shipyards.

10.2 ENVIRONMENTAL PROTECTION.10.2.1 Background.

- a. Reference (a) describes the Navy's Environmental Protection (EP) Program and establishes Navy policy for conducting operations in an environmentally sound manner. The goals of this program are to comply with existing federal, state and local environmental laws and regulations, conserve natural resources, prevent pollution, clean up existing waste sites and facilitate the development and introduction of new technologies that will support these goals.
- b. Federal facilities and personnel are responsible and liable for compliance within their areas of control. In addition, the Navy may be determined to be responsible for activities that occur in private shipyards associated with the construction, repair and modernization of Navy vessels.

10.2.2 General Policy. This section delineates policy guidance established by reference (a) for RMC implementation of the EP program. It contains a brief overview of inspections, liabilities, specific elements and limitations of the EP mission. In accordance with the policy stated in reference (a), RMC personnel are to perform their duties in compliance with federal, state and local laws, as well as Navy regulations and directives. Navy EP regulations, unless contractually invoked for shipboard applications, do not apply to contractors. Additionally, RMCs performing their contract administration responsibilities will not directly assume an enforcement role with respect to contractor EP program management, either by contract language or administrative or personnel actions, unless directed by higher authority.

10.2.3 Regional Maintenance Center Responsibilities.

10.2.3.1 Regional Maintenance Center Commanding Officers. RMC Commanding Officers are responsible for ensuring that the command mission is accomplished in accordance with applicable federal, state, local and Navy environmental protection laws and regulations. Specific EP program areas that should be addressed include, but are not limited to:

- a. Establishment of an appropriate environmental management system and organization.
- b. Reductions in internal hazardous materials usage.
- c. Oversight of contractor and Ship's Force hazardous materials and hazardous waste management efforts.
- d. Acquisition pollution prevention.
- e. Environmental self-evaluations.

- f. Management of government-furnished materials (including shelf-life management) for ship repair and modernization.
- g. Collection and reporting of data for determination of contractor performance award fees (when applicable).
- h. Collection and reporting of data for contractor past performance databases.
- i. Interface with Ship's Force during availabilities to ensure compliance with applicable requirements.
- j. Environmental issues related to management of inactive Fleet assets.
- k. Performing generator duties with regard to Navy-generated hazardous wastes (where applicable).
- l. Ensuring appropriate environmental controls are in place for new construction warranty work on homeported vessels.

10.2.3.2 Manager for Environmental Protection. The Manager for Environmental Protection (which may be combined with the Manager for Occupational Safety and Health) reports to the RMC Commanding Officer. Primary functions include:

- a. Developing, implementing, managing and evaluating local policy and directives to address the requirements defined above.
- b. Advising the RMC Commanding Officer on EP matters.
- c. Serving as the single point of contact on EP issues.
- d. Interfacing with contractor, regulator and other Navy personnel on EP issues.
- e. Developing and providing training for personnel.
- f. Submitting reports required by reference (a).

10.2.3.3 Environmental Self Evaluations. RMCs are required to conduct Environmental Self-Evaluations using the Naval Sea Systems Command (NAVSEA) 04R Environmental Compliance Checklist. The RMC should add all applicable state and local regulatory requirements as specific attributes to ensure compliance with issues applicable to the individual RMC. RMCs must conduct Environmental Self-Evaluations annually unless they are exempted from this requirement by the responsible Naval Facilities Engineering Command Engineering Field Division and NAVSEA. The result of the Environmental Self-Evaluation is a report to the Commanding Officer (CO) that allows the command to evaluate its own environmental compliance posture and its overall environmental management.

10.2.4 Regional Maintenance Center Oversight Functions.

- a. The RMC performs oversight, but not enforcement, of contractor EP programs. This oversight is limited to ensuring compliance with contractual requirements. The contractors are responsible for compliance with applicable federal, state and local environmental regulations in their facilities. Contractual deficiencies are to be brought to the contractor's attention for correction. Non-contractual deficiencies identified by RMC personnel shall be informally reported to the contractor. The RMC shall conduct more in-depth oversight in the event that significant or recurring deficiencies are identified, or in the event the contractor fails to take appropriate corrective action within a reasonable time frame. The RMC shall report violations of federal, state or local laws and regulations identified in the contractor's facility to the appropriate regulators and the contractor should be notified whenever this action is taken.
- b. Correction of EP deficiencies in contractor workplaces, whether at the contractor's facility or a Navy facility, is the contractor's responsibility. The RMC shall employ the Corrective Action Request (CAR) in accordance with Chapter 11 of this volume to bring deficiencies to the attention of the contractor. These CARs shall be titled "Environmental Deficiency Report" to differentiate them from other types of deficiencies reported in a CAR. CARs shall also be considered as supporting documentation for evaluation of contractor performance for award fee determination, where applicable, and also as past performance data for consideration in award of future contracts.

- c. RMCs shall coordinate with other Navy commands, whether shore facilities or ship COs, when contracts administered require work on Navy property to ensure contractor compliance with applicable Navy facility requirements.

10.2.5 Hazardous Waste. RMCs shall ensure that handling, storage, transportation and disposal of hazardous wastes from ships undergoing repair is in accordance with reference (b), and all Federal, State, and local regulations. Section 52.223-3 of reference (c), and the Alternate I clause of that same paragraph, provide additional guidance on the management and disposal of hazardous waste. Different states have established specific procedures for issuing Environmental Protection Agency generator numbers and disposal procedures for hazardous waste generated at private and government facilities. Ship COs and hazardous waste coordinators shall check with their local Manager for Environmental Protection to ensure that proper hazardous waste disposal procedures are used. The RMC shall establish a Memorandum of Agreement with Ship's Force to define responsibilities for disposal of hazardous and infectious wastes generated by the ship. Ship's Force-generated wastes are not subject to regulation as hazardous wastes while the wastes are on board the ship.

10.3 OCCUPATIONAL SAFETY AND HEALTH.

10.3.1 Background. It is Navy policy to enhance operational readiness and mission accomplishment by establishing an aggressive and effective Occupational Safety and Health (OSH) Program. The goals are to reduce job-related injuries, material damages, and to maintain healthful working conditions. Occupational safety addresses control of hazards that can result in immediate injury or death. Occupational health is primarily concerned with the identification and minimization of exposure to hazardous chemical, biological and physical agents.

- a. Section 19 of reference (d) and subsequent Presidential Executive Orders direct Federal Agencies to establish and maintain OSH programs. Reference (e) contains the requirements for these programs.
- b. The Navy OSH (NAVOSH) Program is a major component of the Navy's overall mission. A comprehensive overview of NAVOSH is contained in reference (f), the Navy Occupational Safety and Health Manual.

10.3.2 Policy Guidance. Reference (f) establishes policy guidance for implementation of the NAVOSH program. It contains a brief overview of liabilities, specific elements and limitations of the OSH program.

10.3.3 Regional Maintenance Center Responsibilities.

- a. RMC Commanding Officers are responsible for ensuring safe and healthful workplaces. Specific OSH program functions and responsibilities include, but are not limited to:
 - (1) Establishing an appropriate OSH management system and organization.
 - (2) Providing mishap prevention programs.
 - (3) Establishing hazard abatement programs.
 - (4) Providing OSH training.
 - (5) Conducting workplace inspections.
 - (6) Coordinating occupational health and industrial hygiene field support.
 - (7) Establishing OSH councils/committees.
 - (8) Establishing clear lines of authority to ensure all personnel are fully aware of their rights and responsibilities.
 - (9) Fostering hazard awareness in all personnel.
 - (10) Conducting contractor oversight.
 - (11) Collecting and reporting data for determination of contractor performance award fees.
 - (12) Collecting and reporting data for contractor past performance databases.
- b. Manager for Occupational Safety and Health. The primary functions and responsibilities of the Manager for Occupational Safety and Health include:

- (1) Developing, implementing, managing and evaluating local policy and directives to address the requirements cited above.
- (2) Advising the Commanding Officer on OSH matters.
- (3) Serving as the single point of contact on OSH issues.
- (4) Interfacing with contractor, regulator and other Navy personnel on OSH issues.
- (5) Developing and providing training for personnel.
- (6) Providing timely and accurate submittal of reports required by reference (f).

10.3.4 Occupational Safety and Health Oversight Functions.

- a. Navy Workplaces. Navy workplaces are defined as Navy-owned or Navy-leased facilities or those furnished by a contractor for Navy exclusive use. Navy workplaces should be inspected at least annually. Hazardous workplaces should be inspected more frequently as determined appropriate by the Manager for Occupational Safety and Health.
- b. Contractor Workplaces. RMCs will not conduct inspections of facilities owned and occupied solely by contractors. The contractor is responsible for providing safe working conditions for their personnel, in accordance with regulations, in contractor production shops, shipways, dry-docks, etc., that are not occupied by Navy personnel. When a contractor is performing work on board a Navy ship, the ship space involved is a contractor workplace in which the RMC and the ship's CO have a NAVOSH responsibility for protection of government personnel and property. The RMC does not enforce Occupational Safety and Health Act requirements in contractor workplaces, but does conduct monitoring to ensure safe working conditions for government employees. The RMC monitors the contractor's efforts, especially aboard Navy ships under construction, overhaul and repair, to ensure safe working conditions in areas where government personnel are present. It also brings OSH deficiencies to the contractor's attention for correction.
- c. Shared Workplaces. Certain workplaces, such as receiving areas for Government Furnished Equipment, are shared by both government and contractor personnel. As with contractor workplaces, the RMC monitors shared workplaces to ensure safe working conditions for government personnel and inform contractors of OSH deficiencies. RMCs may remove Government employees when a space is not compliant with Occupational Safety and Health Act, even if no imminent danger is present.
- d. Deficiency Abatement. NAVOSH deficiencies identified in Navy-owned workplaces are to be abated by the RMC or another cognizant Naval command. Abatement of OSH deficiencies at contractor facilities is the contractor's responsibility. Safety and environmental deficiencies are brought to the contractor's attention through the use of a CAR in accordance with Chapter 11 of this volume. These CARs should be titled "Safety Deficiency Report" to differentiate them from other types of deficiencies reported in CARs. These CARs should also be considered as supporting documentation for evaluation of contractor performance for award fee determination, where applicable, and also as past performance data for consideration in award of future contracts.
- e. Imminent Danger. In the event of imminent danger to personnel or property, work will be stopped immediately by the observing party (RMC, Ship's Force or contractor), and the RMC will immediately remove all government personnel from the site, notify responsible management and insist on immediate correction or termination of the operation.
- f. Ship CO Coordination. RMCs should collaborate with the ship's CO in NAVOSH inspections relating to contractor work sites and operations. Unless otherwise specified by agreement, NAVOSH responsibilities do not extend to Ship's Force. Nevertheless, NAVOSH requirements are essentially the same for each party. The RMC should keep the CO and prospective CO informed of significant deficiencies that could adversely affect the ship or Ship's Force.
- g. Gas-Free Engineering. Requirements for gas-free engineering by Navy personnel are addressed in reference (g). Gas-free operations accomplished by contractors are addressed in reference (h), Section 306.

10.3.5 Inspections.

- a. The Navy Inspector General coordinates the inspection program of NAVOSH and conducts oversight inspections of Navy shore activities. Additionally, United States Fleet Forces Command, Pacific Fleet and NAVSEA will conduct periodic onsite Environmental, Safety and Health reviews of ship repair contracts and the controls exercised by the RMC to ensure compliance with contractor oversight responsibilities and reference (i) requirements.
- b. RMC and other government personnel should comply with contractor safety precautions as well as Occupational Safety and Health Act regulations while in the contractor's facility. Navy fire protection and NAVOSH requirements, unless contractually invoked for shipboard applications, do not apply to the contractor. RMCs should not directly assume an occupational health and safety enforcement role with respect to the contractor's safety program, either by contract language or by administrative or personnel actions. Both the RMC and contractor are responsible for providing safe and healthful working conditions for their respective employees.

(This Page Intentionally Left Blank)

VOLUME VII

CHAPTER 11

CONTRACT ADMINISTRATION QUALITY ASSURANCE PROGRAM

REFERENCES.

- (a) Federal Acquisition Regulation - Part 46 - Quality Assurance
- (b) NAVSEA S9086-VD-STM-010 - NSTM Chapter 631 V3 (Preservation of Ships In-Service - General)
- (c) NAVSEA MS 6310-081-015 - Submarine Preservation
- (d) MIL-STD-1330 - Standard Practice for Precision Cleaning and Testing of Shipboard Oxygen, Helium, Helium-Oxygen, Nitrogen and Hydrogen Systems
- (e) NAVSEAINST 9304.1 - Shipboard Electrical Cable and Cableway Inspection and Reporting Procedures
- (f) NAVSEA T9074-AS-GIB-010/271 - Requirements for Nondestructive Testing Methods
- (g) NAVSEA 0900-LP-001-7000 - Fabrication and Inspection of Brazed Piping Systems
- (h) NAVSEAINST 4355.7 - Nondestructive Test (NDT) Examiner Qualification and Requalification
- (i) NAVSEA 250-1500-1 - Welding Standard
- (j) NSTR-99 - Qualification Examination Requirements for Nondestructive Test Personnel
- (k) NAVSEA SI 009-04 - Quality Management System
- (l) CNRMCIINST 4700.9 - Availability Quality **Management** Plan (QMP) Standard Operating Procedure (SOP)
- (m) NAVSEAINST 4700.17 - Preparation and Review of Trouble Reports
- (n) NAVSEAINST 9210.31 - Government Procurement Quality Assurance Source Inspection Actions for Shipyard Procured Material Under the Cognizance of NAVSEA 08

LISTING OF APPENDICES.

- A Preservation Departures from Specifications Process Decision Tree
- B Corrective Action Request
- C Letter of Delegation (Example Only)

11.1 PURPOSE. This chapter establishes the basic provisions for the Regional Maintenance Center (RMC) repair Contract Administration Quality Assurance Program (CAQAP) for hardware and technical data. This chapter includes provisions for tailoring the implementation of these programs to the particular need, based on contractual requirements. There are seven elements of the CAQAP that are designed to provide a systematic program for ensuring contractor compliance with contract requirements. These elements, which are based on the deliverable product and contractual requirements, are Planning, Document Review/Procedure Review (PR), Procedures Evaluation (PE), Product Verification Inspection (PVI), Quality Audits, Corrective Action and Quality Data Evaluation (QDE). The RMC will develop, apply and maintain an effective program for performing Government Quality Assurance (QA) actions consistent with the CAQAP. The elements of the CAQAP will be described by operating procedures that provide RMC personnel with specific direction in applying these to the local contracting environment. This chapter also includes the QA oversight requirements set forth by reference (a). Data related to PE, PVI, Quality Audits, and Corrective Action elements should relate to each individual availability to support Contractor Performance Appraisal Reporting System.

11.1.1 Scope. This chapter establishes the CAQAP requirements for repair and overhaul contracts and applies to all nuclear and non-nuclear areas, except as otherwise indicated.

11.1.2 Applicability. This chapter is applicable to repair and overhaul contracts administered by RMC activities.

11.1.3 Quality Assurance Directives. Fleet instructions, directives and policy letters not included in this chapter containing mandatory QA requirements will be incorporated into each CAQAP. Naval Sea Systems Command (NAVSEA) instructions, directives and policy letters not included in this chapter containing mandatory QA requirements will be incorporated into each CAQAP as directed in writing by the Fleet.

11.1.4 NAVSEA Evaluations. NAVSEA will conduct product-oriented evaluations of contractors and associated RMC contract administration activities as considered necessary. The purpose of these evaluations is to determine contractor conformance to specification requirements and RMC contract administration conformance to QA functions and responsibilities.

11.2 PROGRAM DIRECTION AND CONTROL.

11.2.1 Contractor Responsibilities. The contractor carries out the obligations as set forth in the terms and conditions of the contract and in the applicable specifications. The contractor is responsible for controlling product quality, offering to the Government for acceptance only those supplies and services that conform to contract requirements and, when required, for maintaining and furnishing objective evidence of this conformance.

11.2.2 Government Responsibilities. Government will determine the type and extent of CAQAP actions required based upon the particular procurement. These actions will include as a minimum:

- a. Inspection of the product or process.
- b. Adequacy Reviews and Audits of the contractor's Quality Management System (QMS) or of any other means employed by the contractor to control quality and to comply with contract requirements.
- c. Teaming with the contractor to establish and improve the QMS and associated processes.
- d. Maintenance of Government records to include:
 - (1) The number of observations/inspections made and the number and type of nonconformities detected.
 - (2) Corrective Action Requests (CAR).
 - (3) Records described in paragraph 11.2.4 of this chapter.
- e. Final acceptance of product, when required.

11.2.2.1 Compliance. The Government determines if the contractor's performance of work complies with the requirements of the contract. The contractual documents must provide the authority to require the contractor to maintain a QMS adequate for the work. The contractor must provide and maintain a QMS acceptable to the Government "as specified in the contractual documents." To implement this, cognizant Government personnel will determine the effectiveness of the contractor's quality effort, as well as perform the product inspections necessary to ensure contractor's conformance to the specification.

11.2.2.2 Quality. Government personnel shall be responsible to ensure that the contractor resolves quality issues and improves quality processes. Government personnel shall not serve as a replacement for the contractor's own QMS, nor shall Government personnel be used by the contractor as a progressive inspection device to determine end product acceptability.

11.2.2.3 Verification. If the product is repetitively not ready for inspection after Government services have been requested or items accepted by the contractor are found to be nonconforming during Government inspection, the Government representative will notify the contractor that contractual requirements have not been met. In addition, the Government representative shall discontinue verification actions and initiate corrective action identifying the specific nonconformities.

11.2.2.4 Evaluation. While evaluating the contractor's performance of work on a specific product, the Government representative shall require the contractor only meet those requirements set forth in the contractual documents. The Government representative will not require higher quality work than that set forth in the specifications. Doing so provides the contractor with grounds for requesting an increase in price to cover the higher costs of performance. The Government representative shall not accept lower quality work or work of a lesser scope than specified in the contractual documents. Work performed will only be accepted when the work conforms to the contractual documents and changes.

11.2.2.5 Preservation Oversight of Critical Coated Areas. The RMC is considered to be the third party inspector and shall be responsible for providing a qualified coating inspector in accordance with reference (b). The RMC third party qualified inspector is responsible for ensuring compliance with the requirements of references (b) and (c) before signing acceptance/witness for all Hold points, including (G) points in NAVSEA Standard Items (NSI)

during execution of the preservation process. The third party inspector may either perform the inspection or witness, by personal observation, a qualified contractor individual performing the required measurements. Hold points, including (G) points in NSIs (or key checkpoints) which the third party inspector must sign, are at a minimum, those items identified in reference (b), table 631-11-1 indicated by note 2. The RMC shall also provide for the retention of required preservation records. Any out-of-specification condition found is to be mitigated in accordance with Appendix A of this chapter and in accordance with Volume V, Part I, Chapter 8 of this manual.

11.2.3 Specification Review. Planning Activities, Executing Activities and contractors prepare and issue work specifications. Executing Activities will review these work specifications for adequate quality requirements and inclusion of all technical requirements. Modifications or sequences that are written to the original work specifications will also be reviewed for adequate quality and technical requirements. Specification review will include, as a minimum:

- a. The location of (I), (V) and (G) points are consistent with the procedure referenced in Chapter 4, Appendix E of this volume.
- b. There is adequate, written description of the technical requirements.
- c. Accept or reject criteria for inspections and tests is clearly stated and includes appropriate tolerances.
- d. The use of references in work specifications should be avoided unless the material is too extensive to quote or paraphrase.
- e. An (I), (V) and (G) point is not invoked in the work specification before a paragraph which references an NSI which invokes the same (I), (V) and (G) points.

Government will establish and maintain a feedback and corrective action process that formally reports specification problems and nonconformities to the preparing Government and/or contractor activity.

11.2.4 Retention and Disposal of Inspection Records. Quality inspection records (i.e., inspections, qualifications/training, assessments, evaluations, audits, CARs, PVI and critical coat paint preservation) and other quality assurance documents are part of the contract administration office contract file per Federal Acquisition Regulations, subpart 4.803. As such, these records must be retained for six years and three months after final contract payment for contracts exceeding the simplified acquisition threshold per Federal Acquisition Regulations, subpart 4.805 and SSIC 4200.1.b.(1) of SECNAV M-5210.1, Records Management Manual. Per Defense Federal Acquisition Regulation Supplement, subpart 204.805, the records should be kept for 12 months following contract completion by the office responsible for maintaining them at which time the records may be sent to the local records holding area or to a Federal Records Center until they are eligible for disposal. These records may be destroyed at the completion of the retention period unless legal action is pending with contractors for which these records pertain. Specialty inspection records, such as SUBSAFE, nuclear, Level I, etc., should be retained as specified in Volume V, Part I, Chapter 10, Paragraph 10.2.2 of this manual.

11.3 PERSONNEL CAPABILITY REQUIREMENTS.

11.3.1 Quality Assurance Manager/Department Head.

- a. Is responsible for determining needed personnel requirements, initiating action necessary to obtain the required personnel and providing training necessary to ensure the skills are available for the performance of QA functions.
- b. Will ensure that the required skills are available to determine acceptability of products produced and services rendered by the contractor. Training must be provided to ensure personnel have the skills, techniques and knowledge necessary to comply with the requirements of this chapter. QA training opportunities must be extended to all appropriate personnel engaged in performing quality related functions. A training plan/matrix will be established and maintained current.

11.3.2 Training.

- a. Personnel providing in-process oversight of the contractors shall complete introduction/overview training of CAQAP elements internally prepared by the QA Manager. Personnel performing contractor QMS Audits shall receive both introduction/overview training of CAQAP elements internally prepared by the QA Manager and also introduction/overview of International Organization for Standardization (ISO) 9001 training as a minimum and may be internally prepared by an experienced auditor.

- b. Personnel performing quality audits of the contractor must satisfactorily complete ISO 9001 Internal Auditor training or equivalent (trained by a Lead Auditor) as a minimum. This training is optional if Lead Auditor training has been received.
- c. Personnel assigned as Lead Auditor/Audit Team Leader must satisfactorily complete ISO 9001 Lead Auditor training as a minimum.

11.3.2.1 Coating Inspection. Specialized training and certification in Coating Inspection is required for each individual performing verification of contractor coating processes on critical surfaces. Training, certification and recertification must be accomplished through a NAVSEA approved course (e.g., NACE International Coating Inspector Program Level 1 or higher, NAVSEA Basic Paint Inspector or Society for Protective Coatings (SSPC) Protective Coating Inspector Program). Requirements for critical surfaces are defined in reference (b).

11.3.2.2 Oxygen Cleanliness. Specialized training and certification in Oxygen Cleanliness is required for each individual performing verification of contractor cleaning, assembly or packaging of certified oxygen clean systems and components. Training and certification must be administered by a NAVSEA approved Certified Oxygen Clean Instructor in accordance with reference (d). Recertification of personnel is required every three years.

11.3.2.3 Electrical Cableway. Personnel performing inspection or acceptance of electrical cableway work on Navy ships shall be trained and qualified to reference (e).

11.3.3 Nondestructive Test Personnel Requirements. Specialized training, experience and certification in the applicable Nondestructive Testing (NDT) method is required for each individual performing PR, PE, PVI, Process Quality Audits (PQA) and actual accomplishment of the NDT method. Unless otherwise specified herein, NDT personnel shall be qualified and certified in accordance with references (f) and (g), as applicable.

11.3.3.1 Training/Qualification. Training programs may be developed by the RMC or attained from Portsmouth Naval Shipyard (PNS), other Naval Activities, Navy technical schools, chapters of the American Society for Nondestructive Testing or from private industry. Work-time-experience required as a qualification prerequisite for NDT inspector candidates shall be obtained by actual hands-on experience and performance of PR, PE, PVI and PQAs of a contractor's inspection functions in the applicable NDT method under the guidance of a certified Level II (Inspector) or Level III (Examiner). Formal classroom training and qualification testing shall be in accordance with reference (f) or (g), as applicable. Work-time-experience may be considered sufficient when the inspector candidate's experience is such that the qualification requirements as defined in paragraph 11.3.3.2 of this chapter are met.

11.3.3.2 Qualification. NDT qualifications are:

- a. NDT LEVEL II (Inspector): An individual qualified to set up and calibrate equipment and to interpret and evaluate results with respect to applicable codes, standards and specifications. The Inspector shall be thoroughly familiar with the scope and limitations of the methods for which the individual is qualified, exercise assigned responsibility for on-the-job training and guidance of trainees and prepare written instructions, and document/report NDT results.
- b. NDT LEVEL III (Examiner): An Examiner will be capable of establishing techniques and procedures; interpreting codes, standards, specifications and procedures; and designing the particular test methods, techniques and procedures to be used. The Examiner will be responsible for the NDT operations for which qualified and to which assigned and will be capable of interpreting and evaluating results in terms of existing codes, standards and specifications. The Examiner will have sufficient practical background in applicable materials, fabrication and product technology to establish techniques and to assist in establishing acceptance criteria where none are otherwise available. The Examiner will have general familiarity with other appropriate NDT methods and will be qualified to train and examine Inspector personnel for certification.

NOTE: RMC ACTIVITIES REQUESTING EXAMINER CERTIFICATION MUST PROVIDE EVIDENCE TO THE CERTIFYING ACTIVITY AS TO THE NEED TO FUNCTION AT THIS LEVEL AND THAT FACILITIES AND EQUIPMENT ARE AVAILABLE.

11.3.3.3 Certification. RMC Inspectors shall be certified or recertified at their activity under a program administered by a reference (h) certified Examiner or by PNS. Reference (h) provides the reference (f) and (g) Test

Examiner certification requirements for all government-employed civilian and military personnel who are attached to Naval activities. Inspector certification is restricted to the oversight of contractor performed NDT and not for product acceptance inspections. Product acceptance inspections shall be performed by inspection personnel qualified in accordance with the applicable fabrication document and is not within the scope of this chapter. PNS can certify Inspector and/or Examiner personnel in any or all of the following methods:

- a. Visual Test (VT) Inspection.
- b. Magnetic Particle Test (MT) Inspection.
- c. Liquid Penetrant Test (PT) Inspection.
- d. Radiographic Test (RT) Inspection (Structural, Castings and Piping).
- e. Ultrasonic Test (UT) Inspection.
- f. Welds, Thickness and Silver Braze; Inspector personnel may obtain individual certification.
- g. Special Purpose Lead; Inspector certification only.
- h. Eddy Current Test (ET) Inspection (Welds and Base Material).

11.3.3.4 Certification Maintenance. Examiners are to recertify at the intervals specified in reference (h). Inspectors will recertify and perform documented verification of use of the applicable NDT method at intervals specified in reference (f) and/or (g). The required periodic maintenance of certification for Inspectors may consist of actual performance of the applicable NDT method, or by performance of a documented PR, PE, PVI or by a PQA in the applicable NDT method.

11.3.3.5 Inspector Oversight. The oversight and oversight periodicity of inspection personnel shall be clearly described in the activity's Written Practice. If so employed, oversight shall be conducted through a NAVSEA NDT Examiner. Otherwise, oversight of inspection personnel shall be conducted through normal supervisory managed controls (e.g., supervisor performs deck oversight or by way of a supervisory managed peer review program) to ensure inspection personnel remain proficient and active in the performance of contractor oversight duties. Inspectors failing to maintain proficiency shall be disqualified. Requalification shall be conducted as described herein. Records of inspector oversight shall be maintained.

11.3.3.6 Nuclear Nondestructive Testing Qualifications. RMC personnel performing Nuclear NDT Examiner duties are to be certified or recertified as specified in reference (h). Nuclear NDT Inspectors are to be certified or recertified by the RMC activity's Nuclear Examiner in accordance with references (i) and (j).

11.3.4 Ship's Force Quality Assurance Interface. Although the RMC is the Contract Administration Activity and the authority for acceptance of accomplished work in accordance with the contractual agreement, the ships Commanding Officer should be satisfied that the work performed on the ship is satisfactory. The Commanding Officer should normally assign members of the Ship's Force to inspect work performed on the ship. If a ship's inspector is dissatisfied with the quality of the contractor's work on an individual item, the ship's inspector will not attempt to require contractor personnel to redo or otherwise amend the work performed. Rather, the ship's inspector will relay the findings to the cognizant RMC representative who will then take appropriate action. Ship's Force inspectors should also participate in conferences held to determine progress of work and to discuss any problems with quality of the work or services provided to the ship. In addition, Ship's Force personnel may be provided training and/or assigned QA functions under the responsibility of the RMC Contract Administration Activity in accordance with a Memorandum of Understanding negotiated between the Commanding Officer of the ship and the Commanding Officer of the RMC Contract Administration Activity. (Aircraft Carriers only) For any space which is tracked by Corrosion Control Information Management System, accomplish a joint inspection with the Supervisor and the Commanding Officer's designated representative (i.e., Ship's Force personnel or a Type Commander National Association of Corrosion Engineers Inspector) upon completion, inspection and acceptance, by the contractor, of the work within each compartment. This joint inspection is essential for the integrity of the Corrosion Control Information Management System database and future availability preservation planning.

11.4 SURVEYS AND CONFERENCES.

11.4.1 Bidders' Conference. A bidders' conference provides an opportunity for discussion of the contract quality requirements to ensure all bidders understand the extent and level of QA required.

11.4.2 Pre-Award Surveys. Prior to the award of a contract, the prospective contractor shall be evaluated for quality organization, practices, procedures and/or quality history to determine capability for the type of work for which the contractor is being considered. The Contracting Officer and the Quality Manager will determine the method of evaluation. In addition, the scope of the pre-award survey will include a discussion of the contractual QA requirements to confirm the contractor's understanding of these requirements and how the contractor intends to implement the requirements. The QA participant in the pre-award survey is a member of the overall survey team headed by the team coordinator. When possible, the survey will be a joint team effort. When this is not possible, QA actions will be coordinated with the team coordinator. The QA report and recommendations are considered by the Pre-Award Survey Review Board in making the ultimate recommendation to the Procuring Contracting Officer who considers the recommendation in award of the contract.

11.4.3 Post-Award Conference. When it is determined after contract award that the contractor does not or may not have a clear understanding of the scope of the contract, the technical requirements or the rights and obligations of the parties, the Administrative Contracting Officer must initiate post-award orientation action to clarify contract requirements and resolve misunderstandings. A conference of all RMC participants should be held before conferring with the contractor to ensure that the RMC position on all matters is established.

11.4.4 Arrival Conference. An Arrival Conference must be held to discuss the conduct of the repair availability and the interface between Ship's Force, contractor, other Government activities and RMC personnel and the responsibilities and interface of each in performing quality related functions.

11.5 ELEMENTS OF THE CONTRACT ADMINISTRATION QUALITY ASSURANCE PROGRAM.

11.5.1 Planning. Planning the actions required to determine the contractor's compliance with the contract requirements will be systematic and consider the contractual requirements and relative importance of the product. This planning is to take into account all the factors involved in deciding how RMC personnel can most effectively and economically perform the CAQAP function. As a minimum, the planning for all products will include:

- a. Appropriate distribution of Government effort between inspection of products and evaluation of the contractor's QMS.
- b. Provisions for review of the contract package including specifications and related documents to determine completeness, continuity and responsibilities for ensuring contractor's performance of technical and quality requirements.
- c. For each availability, the activities shall have a specific quality oversight plan based on QDE evaluation to identify high risk areas and provide direction for targeted PVI/PE/PQA.
- d. For non Chief of Naval Operations maintenance, activities shall have a general quality oversight plan based on QDE evaluation to identify high risk areas and provide direction for targeted PVI/PE/PQA.
- e. Provisions for PR and/or approval of contractor's written procedures and technical data to ensure adequacy and timely release of the procedures.
- f. Provisions for PE of the contractor's written procedures to ensure the contractor accomplishes the intended purpose of controlling product/process quality.
- g. Provisions for the development of detailed PVI checklists and for the actual inspection or verification of products to determine conformance to the requirements of the contract.
- h. Provisions for applying corrective action when a breakdown or other inadequacy is noted in the contractor's quality.
- i. Provisions for the collection, evaluation and use of quality data.
- j. Provisions for accomplishing quality audits.
- k. Provisions for review of the contractor's quality history.

11.5.2 Document Review. Document Review is the CAQAP element for verifying that the contractor's documented procedures and technical data comply with contractual requirements.

11.5.2.1 Procedure Review Criteria. When a contractual requirement exists for a contractor to develop written procedures, the RMC will identify those procedures necessary for review based on the degree of risk. Each identified procedure will be reviewed for conformance to the administrative and technical requirements contained in the contract. The RMC representative must review the contractor's procedures in a timely manner and not delay the contractor's contract performance. This review may be accomplished in increments, is not limited to newly developed procedures and includes subsequent revisions and changes. When the contractor does not develop required written procedures or fails to correct inadequate procedures previously reported to the contractor, the RMC shall initiate corrective action.

11.5.2.2 Technical Data Review Criteria. Data review and evaluation will be performed on all deliverable technical data. Review of technical data means the detailed examination or review with the application of engineering judgment by engineers or technicians to determine if the data content and format conform to contract requirements. The RMC may use any local means of selecting characteristics or attributes of this technical data.

11.5.2.3 Acceptance of the Contractor's Documented Quality Management System. The collection of documents describing the contractor's policy and methods of implementing the specific requirements of reference (k) constitutes the contractor's documented QMS. The RMC will conduct an adequacy review and furnish the contractor written notice of the acceptability of the documented QMS.

11.5.2.4 Approval of Procedures. Approval of the written quality procedures will be based on full compliance with the contract provisions. When these written procedures are contractually required the contractor will be notified promptly on approval/disapproval.

11.5.2.5 Documentation. Documentation will include the identification number and title of the document(s), revision date, date reviewed, acceptability or unacceptability, the printed name and signature of the individual who accomplished the review.

11.5.3 Procedure Evaluation. PE is the CAQAP element that verifies that the contractor is compliant with contractually required quality procedures and that procedures are accomplishing the intended purpose of controlling product/process quality.

11.5.3.1 Conduct of Procedure Evaluation. PEs should be conducted utilizing the QA plan, checklists or an attribute system. Flexibility for adjustments in the frequency of inspections will depend on nonconformity rates and problem areas that develop based on contractor quality history. PQAs may be used in lieu of PEs.

11.5.3.2 Documentation. Documentation for PE/PQA will include:

- a. Developed checklists/attribute system for PE/PQA.
- b. PE/PQA results will include observations and nonconformities.

11.5.4 Product Verification Inspection. PVI (surveillance) is the CAQAP element that verifies that the product being produced by the contractor conforms to contract requirements. PVI is accomplished by the cognizant RMC representative by in-process inspections in the form of physical examination, verification, testing, concurrent witnessing or monitoring of critical aspects of the repair or overhaul process. Provide results to the QA manager.

NOTE WHEN GOVERNMENT (G) NOTIFICATION POINTS ARE NOT PERFORMED/WITNESSED, THE REASON WHY (E.G. CONFIDENCE IN THE CONTRACTOR'S INSPECTION, OVERTIME NOT AUTHORIZED, INADEQUATE MANPOWER, ETC.) SHALL BE DOCUMENTED IN THE COMMENTS SECTION OF THE (G) POINT LOG.

11.5.4.1 Conduct of Product Verification Inspection. PVIs should be conducted utilizing the QA plan, checklists or an attribute system. These checklists or attribute lists shall include Government (G) notification points, critical inspection points and those areas that may be concealed from further inspection. Flexibility for adjustments in the frequency of inspections will depend on nonconformity rates and problem areas that develop based on contractor quality history.

11.5.4.2 Documentation. Documentation for PVI will include:

- a. The reason why Government (G) notification points were not performed/witnessed.
- b. PVI results including observations/inspections and nonconformities.

11.5.5 Quality Audits. Quality audit is the CAQAP element that examines and evaluates products, procedures/processes, services, systems and elements thereof.

11.5.5.1 External Audit. External audits such as QMS audits (functional audit), and horizontal or vertical product quality audits are conducted to determine the effectiveness of the contractors QMS, analysis of the process and assessment of product conformance. The QMS audit may be conducted as a single audit or may be a combination of several audits. Targeted Process and Product Quality Audits shall be scheduled at least once every 12 to 18 months for each contractor, provided a complete QMS audit is performed every five years. Attributes for the accomplishment of the QMS audit shall be derived based on contractor performance and do not necessarily encompass the entire ISO checklist but will target specific areas. Process and product quality audits are encouraged for detailed root cause analysis. Process and product quality audits may be prompted by significant changes in the contractor's QMS, processes or product quality.

11.5.5.2 Internal Audit. Internal audits shall be conducted to determine RMC contract oversight compliance by internal departments with quality related directives and operating procedures/processes. The RMC will schedule and conduct the following audits at least once every 12 to 18 months at a minimum:

- a. Contract Administrative Quality Assurance Program (CAQAP).
 - (1) Planning.
 - (2) Documents Review/PR.
 - (3) PE.
 - (4) PVI.
 - (5) Quality Audits.
 - (6) Corrective Actions.
 - (7) QDE.
 - (8) Work Specification Review:
 - (a) Location of (I), (V) and (G) points is consistent with the procedure referenced in Chapter 4, Appendix E of this volume.
 - (b) There is adequate, written description of the technical requirements.
 - (c) Accept or reject criteria for inspections and tests are clearly stated and include the appropriate tolerances.
 - (d) The use of references in work specifications should be avoided unless the material is too extensive to quote or paraphrase.
 - (e) An (I), (V) and (G) point is not invoked in the work specification before a paragraph which references an NSI which invokes the same (I), (V) and (G) points.
 - (9) Training:
 - (a) Personnel providing in-process oversight of the contractors shall complete introduction/overview training of CAQAP elements.
 - (b) Personnel performing contractor Quality Management System Audits shall receive both introduction/overview training of CAQAP elements and also introduction/overview of ISO 9001 training.
 - (c) Personnel performing quality audits of the contractor must satisfactorily complete ISO 9001 Internal Auditor or Lead Auditor training or equivalent.
 - (d) Personnel assigned as Lead Auditor/Audit Team Leader must satisfactorily complete ISO 9001 Lead Auditor training as a minimum.
- b. Availability Quality Management Plans for Chief of Naval Operations (CNO) Availabilities and Continuous Maintenance Availabilities (CMAV) requiring certification, reference (l).

- (1) Navy Maintenance Database (G)-Point Tracking - G-Point completion recording is current with work progression and consistent with the contractor's Test and Inspection Plan (TIP).
- (2) Population of Contractor's TIP - Is consistent with the corresponding (I), (V) and (G)-Points required by the individual work items and the associated NSIs.
- (3) Maintenance of Contractor's TIP - Work progression is up to date and completed tests and inspections are in accordance with NSI 009-04 and 009-67.
- (4) Objective Quality Evidence documents are captured and complete.
- (5) Closeout processing of completed Expanded Process Control Procedures.
- c. Additional items for internal audit consideration. Reports for CNO/CMAV availability certification.
 - (1) Required Reports:
 - (a) Submission.
 - (b) Compliance to content dictated by the Work Specification.
 - (c) Appropriate RMC routing and technical parameter review via Engineering Support Request (ESR).
 - (d) Appropriate response with technical direction via ESR.
 - (e) Contractual incorporation into the work package of resultant technical direction.
 - (2) Condition Reports (growth):
 - (a) Appropriate RMC routing and technical parameter review via ESR.
 - (b) Appropriate response with technical direction via ESR.
 - (c) Contractual incorporation into the work package of resultant technical direction.
- d. Additional items for internal audit consideration. Certification Process/Execution for CNO/CMAV availabilities.
 - (1) Undocking (if applicable).
 - (2) Production Completion Date.
 - (3) Combat Systems Production Completion Date (AEGIS Light-off for AEGIS Ships).
 - (4) Dock Trials.
 - (5) Fast Cruise.
 - (6) Sea Trials.
- e. Expanded Process Control Procedures program review.
- f. Total Ship Readiness Assessment program review.

11.5.5.3 Documentation. Documentation will include:

- a. Audit schedule, including the identification of the lead auditor/team leader.
- b. Audit reports including results/resolutions and follow-up actions.

11.5.6 Corrective Action. Corrective action is the CAQAP element that defines the methods for requesting the contractor to act to correct nonconformities. To achieve systematic assurance of compliance throughout all phases of the contractor's operation, the basic causes of nonconformities must be identified and the contractor must initiate prompt corrective action to correct assignable conditions that have resulted in generating nonconformities. The correction of the nonconformity alone does not satisfy this goal. Corrective action as described in this section employs the "closed loop" concept (i.e., appropriate measures must be taken to identify the cause and prevent the recurrence of nonconformities and the corrective and preventive measures must be accepted by the government). The contractor will be required not only to correct specific nonconformities but also to initiate preventive action to

eliminate cause of nonconformities. RMC must determine the effectiveness of the contractor's action and will also determine the necessity for tighter control until ensured that the contractor's corrective action is satisfactory. In addition to the CAR, Appendix B, a Trouble Report shall also be prepared and distributed in accordance with reference (m) for all significant problems encountered in the construction, repair and maintenance of Naval ships. Significant problems are those that affect ship safety, cause significant damage to the ship or its equipment, delay ship deployment or incur substantial cost increase or involve severe personnel injury. Trouble Reports should also identify systemic problems and issues that constitute significant lessons learned for other activities.

11.5.6.1 Corrective Action Request. When corrective action by the contractor is required, one of the following methods will be requested:

- a. Minor Nonconformities (Method A)
 - (1) A minor nonconformity is a defect or flaw that will probably not impair the performance or life of a product or result in unsafe conditions for the user. Generally, a minor nonconformity is administrative in nature or can be corrected on the spot; at most, the contractor can be reasonably expected to correct it within one day. Examples of minor nonconformities are non-docking related late reports, repeated housekeeping violations, potential safety discrepancies such as a hot work chit not posted on-site, minor repetitive administrative discrepancies with submittals of work specifications, Process Control Procedures, reports, etc., minor Objective Quality Evidence discrepancies and G-Points called out during normal working hours that are not ready for inspection at the designated time.
 - (2) Minor nonconformities shall be presented to responsible contractor's personnel in writing for correction. Each minor nonconformity will be described in sufficient detail to allow the contractor to understand what contractual requirement is violated and to take appropriate corrective action. The RMC representative should not require contractor written response, however, the internal RMC process shall ensure that minor nonconformities are documented, corrected and date verified/cleared.
- b. Major Nonconformities (Method B)
 - (1) A major nonconformity is a nonconformance that judgment and experience indicate could impair the performance or life of a product or result in hazardous or unsafe conditions for the user. Examples of major nonconformities are late dry-dock related reports, repeated Method A nonconformities in the same area, safety discrepancies that pose an immediate threat or danger, serious injuries to personnel, damage to government property or ship's systems that impact the product or performance, contractor's actions that result in the issuance of a trouble report and technical authority violations such as unauthorized substitution of materials or unauthorized changes to ship's systems.
 - (2) When major nonconformities are detected or a trend of recurring minor nonconformities are noted, a CAR will be initiated citing the specific contract, specification or contractor's procedural requirement and a description of the nonconformity, clearly indicating how the contract, specification or contractor's procedural requirement was violated. Additionally, the CAR shall include contract number/job order, ship, appropriate references, originator's signature, unique serial number, contractor's corrective action response and preventive action(s) taken to eliminate the causes of potential nonconformities in order to prevent their occurrence and the RMC representative's indication of acceptability and signature. Appendix B provides an example of a CAR form that may be used. The CAR should be forwarded to the appropriate level of the contractor's management for action. The actual time frame for completion of contractor corrective action may vary, however, prompt response to CARs is required. An interim reply may be acceptable, pending contractor's completion of corrective actions.
- c. Systemic/Critical Nonconformities (Method C or Method D)

When the previous methods fail to obtain satisfactory results or when the severity of the situation warrants, a Method C letter shall be issued from the Quality Assurance Officer/Director/Manager or the appropriate department head notifying the contractor's appropriate level of management that a systemic or critical problem exists and immediate management action must be taken to comply with the provisions of the contract.

In addition, when a Method C letter fails to obtain satisfactory results or when the severity of the situation warrants, a Method D letter shall be issued by the Commanding Officer or the Contracting Officer notifying the contractor's top level of management that a systemic or critical problem exists and immediate management action must be taken to comply with the provisions of the contract. An electronic or hard copy of each Method C or D letter shall be furnished to the Contracting Officer.

11.5.6.2 Requesting Corrective Action. CARs will be used for requesting correction of quality-related nonconformities, elimination of the causes of the nonconformities and identification of preventive actions to eliminate the causes of potential nonconformities in order to prevent their occurrence. The CAR may also be used to request correction of non-quality related nonconformities (e.g., safety, environmental or management), elimination of the causes of the nonconformities and identification of preventive actions to eliminate the causes of potential nonconformities in order to prevent their occurrence provided the CARs can be readily segregated.

11.5.6.3 Documentation. Documentation of the corrective action element will include:

- a. Records of all Trouble Reports.
- b. Records of all CARs.
- c. Status of all CARs.

11.5.7 Quality Data Evaluation. QDE is the CAQAP element that provides for the collection, evaluation and use of contractor, RMC, NAVSEA Logistics Center and customer quality data. Operating procedures will be established to describe the system to be used for collecting, evaluating, maintaining and using the data. Quality data should include:

- a. Trouble Reports.
- b. Contractor Performance Assessment Report data.
- c. Critiques.
- d. PR, PE and PVI results.
- e. Audit results.
- f. CARs.

11.5.7.1 Data Evaluation. Evaluate the quality data individually or collectively at established periodic intervals for the purpose of:

- a. Adjusting the intensity of application of basic elements of the CAQAP.
- b. Providing a basis for acceptance or rejection of products or services.
- c. Determining effectiveness of contractor's QMS.
- d. Providing a basis for recommending process improvement initiatives to the contractor.
- e. Providing a basis for decisions related to the reallocation of personnel.
- f. Producing a metric for contractor quality history.

11.5.7.2 Documentation. Documentation will include a Quarterly Report indicating contractor QDE results and forwarded to codes 100, 200, 300 and 400.

11.6 GOVERNMENT CONTRACT QUALITY ASSURANCE ACTIONS AT SOURCE.

11.6.1 General. The prime contractor is responsible for controlling the quality of materials, items and services provided by its subcontractors. Government Contract Quality Assurance (GCQA) on subcontracted supplies or services shall be performed only when required in the Government's interest. The primary purpose is to assist the RMC in determining if the prime contractor is ensuring the conformance of subcontracted supplies or services with

contract requirements. GCQA at source, previously referred to as Government Source Inspection, does not relieve the prime contractor of any responsibilities of the contract and GCQA does not establish a contractual relationship between the Government and the subcontractor. Requests for GCQA shall be held to a minimum based on quality performance history.

11.6.2 Exception. This part does not apply to procurements under the technical responsibility of the Deputy Commander, Nuclear Power Directorate, NAVSEA 08. Reference (n) provides guidance for procurement of products under NAVSEA 08 cognizance.

11.6.3 Requesting Government Contract Quality Assurance at Source. RMCs will establish a process for invoking GCQA on subcontracted supplies and for preparation and issue of GCQA instructions to the Defense Contract Management Agency (DCMA) Contract Management Office. RMCs may elect to use prime contractor source inspection in lieu of those aspects normally requiring Government oversight provided the prime contractor performs each aspect of the inspection to be verified by the Government. When source inspection is used in lieu of GCQA the RMC shall have alternative evaluation methods (e.g., process evaluation, audits, QDE, etc.) to ensure conformance of subcontracted products or services with contractual requirements.

11.6.3.1 Government Contract Quality Assurance Criteria. Government inspection during contract performance is essential. Complex items have quality characteristics, not wholly visible in the end item, for which contractual conformance must be established progressively through precise measurements, tests and controls applied during purchasing, manufacturing, performance, assembly and functional operation either as an individual item or in conjunction with other items. GCQA is to be invoked based on the following criteria in reference (a):

- a. Mandatory GCQA actions imposed on the RMC that can be accomplished only at the subcontractor's location.
- b. Performance at any other place would require uneconomical disassembly, destructive testing or special required instruments, gauges or facilities available only at the subcontractor location.
- c. Performance at any other place would destroy or require the replacement of costly special packing and packaging.
- d. Considerable loss would result from the manufacture and shipment of unacceptable supplies or from the delay in making necessary corrections.
- e. Government inspection during contract performance is essential.
- f. The contract specifies that certain quality assurance functions, which can be performed only at the subcontractor's plant, are to be performed by the Government.
- g. A (G) POINT (see reference (k)) is invoked in purchase orders for inspections and tests to be performed which are outside a 50 mile radius of the contractor's plant nearest to place of performance of the contract.
- h. It is determined for other reasons to be in the Government's interest. Supplies or services for which a certificate, records, reports or similar evidence of quality must be at the subcontractor location.
- i. The item is to be shipped from the subcontractor's plant to the using activity and inspection at source is required.

11.6.3.2 Purchase Order Clause. When subcontract GCQA actions are determined to be necessary, the prime contractor will be requested to add the following Government notification and access clause to the purchase order:

"Government inspection is required prior to shipment from your plant. Upon receipt of this order, promptly notify and furnish a copy to the Government representative who normally services your plant so that appropriate planning for Government inspection can be accomplished. In the event the Government representative or office cannot be located, our purchasing agent shall be notified immediately."

11.6.3.3 Amending Subcontract After Release. When the decision to request GCQA actions at subcontract level is made after the subcontract is released, the contractor will be requested to amend the subcontract to include the appropriate requirement for GCQA action at source.

11.6.3.4 Letter of Delegation. When a condition stated in paragraph 11.6.3.1 of this chapter exists, a Letter of Delegation (LOD) (Appendix C of this chapter or similar) will be prepared. The RMC representative will define the necessary GCQA actions to be taken and the documentation to be provided by the Government representative at the subcontractor's plant. Defined actions should indicate specific quality characteristics, processes or procedures to be verified, tests to be witnessed, sampling plans to be used, or records, reports and certifications to be evaluated. All written statements, contract terms and conditions relating to GCQA actions at the subcontractor level shall be worded so as not to:

- a. Affect the contractual relationship between the prime contractor and the Government, or between the prime contractor and the subcontractor.
- b. Establish a contractual relationship between the Government and the subcontractor.
- c. Constitute a waiver of the Government's right to accept or reject the supplies or services.

11.6.3.5 Distribution of Letters of Delegation. The LOD, with copies of the purchase order, will be furnished to the cognizant Contract Management Office, as designated in the Federal Directory of Contract Administration Services (CAS) Components List, and to the Government representative at the subcontractor's facility. The Federal Directory of CAS Components List is available at <http://home.dcmamail.com>, then click on CAS Directory. The Quality Assurance Representative (QAR) will acknowledge receipt of delegation, by returning a receipted copy of the "DCMA ACKNOWLEDGMENT", identified in Appendix C, which will be included in the Government LOD. Changes to the purchasing document will be processed similarly.

11.6.3.6 Letter of Delegation Follow-up System. Maintain a follow-up system to ensure that the LOD was received, that the DCMA component will perform the inspection as stated, notification of the completion of all GCQA actions have been completed and that copies of the DCMA records will be provided or a certificate will be furnished stating that records are on file. Direct communications between the RMC and the DCMA component is encouraged.

(This Page Intentionally Left Blank)

APPENDIX A

PRESERVATION DEPARTURES FROM SPECIFICATIONS PROCESS DECISION TREE

NOTE: THIS DECISION TREE DOES NOT CHANGE ANY TECHNICAL REQUIREMENTS. THE LEVEL OF AUTHORITY REQUIRED INDICATES AT WHAT LEVEL AN OUT-OF-SPECIFICATION CONDITION CAN BE APPROVED WHEN PROPERLY DOCUMENTED AND WITH AN ACKNOWLEDGED INCREASE IN THE RISK OF PREMATURE FAILURE. THIS DOES NOT MEAN THAT THE OUT-OF-SPECIFICATION CONDITION WILL NECESSARILY BE ACCEPTED. THE DECISION TO ACCEPT OR REJECT WORK WILL BE MADE BASED ON THE APPLICABLE REQUIREMENTS AND OTHER CONSIDERATIONS.

General Usage of the Table

- A. This decision tree does not change any technical requirements. The “Level of Authority Required” indicates at what level an out-of-specification condition can be approved. Mitigation guidance on out-of-specification requirements does not imply that a particular out-of-specification condition will be accepted. The decision to accept or reject an out-of-specification requirement will be made at the level indicated in the table.
- B. Minor out-of-specification conditions as described in the columns for “Mitigation Only” and “Local Chief Engineer (CHENG)” in this table represent a low risk of premature coating failure as long as required mitigation actions are taken and the out-of-specification condition is limited with respect to the area being worked. More significant out-of-specification conditions require a formal Waiver/Deviation (Departure from Specification (DFS)) for adjudication of the condition.
- C. The “Mitigation Only” category must be adjudicated by the local Technical Authority (shipyard, Regional Maintenance Center and TRIDENT Refit Facilities) at the first occurrence of an out-of-specification condition during a particular work item after which the government Quality Assurance (QA) activity/representative can apply the same mitigation guidance for the specified requirement. Recurrences of a previously mitigated condition require documentation at each occurrence (see J, below).
- D. All DFSs (minor or major, temporary or permanent) must be adjudicated in accordance with Naval Sea Systems Command (NAVSEA) 5400.95 Enclosure 2.
- E. Unless otherwise specified, this table applies only to critical-coated areas.
- F. This table does not apply to NAVSEA 08 cognizant spaces as described in NAVSEA Instruction C9210.4, which specifically includes potable water tanks and reserve feed tanks.
- G. When using this decision tree for submarine preservation, the local technical authority is required to evaluate the nonconformance in accordance with the appropriate Unrestricted Operation/Maintenance Requirement Card requirements.
- H. Repeated waiving of the same out-of-specification requirements shall be cause for the applicator, with the assistance of the local Technical Authority (shipyard or Regional Maintenance Center engineering code), to determine and eliminate the root cause of the noncompliance. If it is determined that the applicator cannot meet the stated requirements, notify NAVSEA accordingly.
- I. The local Technical Authority shall decide when multiple out-of-specification conditions or repeated (same) out-of-specification conditions on the same work item warrant a minor or major DFS. In particular, if multiple out-of-specification “Mitigation Only” and/or “Local CHENG” conditions exist and/or affect an area in excess of 0.3% of the total surface area of a work item, the local Technical Authority will submit a minor or major DFS, depending on the severity/risk of the cumulative out-of-specification conditions.
- J. Unless otherwise specified, action to “document” an out-of-specification condition requires submittal of the NSI 009-32 QA inspection forms (included in the appendices of 009-32). These forms become part of the Objective Quality Evidence and shall be retained.

PRESERVATION DEPARTURES FROM SPECIFICATIONS PROCESS DECISION TREE

TABLE A

Surface Preparation					
QA Element	Requirement	Level of Authority Required			
		NAVSEA Major DFS	DFS	Local CHENG DL/DR/ESR/etc.	Mitigation Only
A. Surface Profile					
1. Critical-Coated Areas					
a. Average (mils)	2 ≤ profile ≤ 4	< 2 ⁽²⁾	> 6	5 ≤ profile ≤ 6	4 < profile < 5
b. Individual gage readings (mils)	1 ≤ gage reading ≤ 5	< 0.6 ⁽²⁾	> 6	0.6 ≤ profile < 1 and 5 < profile ≤ 6	n/a
2. Nonskid (flight deck, hangar bay and weather decks only)					
a. Average (mils)	3 ≤ profile ≤ 6	< 3	> 7.5	6 < profile ≤ 7.5	n/a
b. Individual gage readings (mils)	2.5 ≤ gage reading ≤ 7	< 2	> 8	7 < profile ≤ 8	n/a
3. QA Readings	(1)	≥ 10% missing	5% < missing < 10%	0% < missing < 5%	n/a
Notes:					
1. Documentation Requirement: See NAVSEA Standard Item 009-32 for detailed documentation requirements.					
2. Only when discovered during a record review; otherwise the condition should be corrected as it represents extremely high risk.					

VII-11A-2

COMUSFLTFORCOMINST 4790.3 REV C CH-2

PRESERVATION DEPARTURES FROM SPECIFICATIONS PROCESS DECISION TREE

Surface Preparation

Rationale for Allowing Departure:

- **Profiles below the limit:** The greatest risk of coating failure due to improper profile is if the profile is insufficient. If an inspection reveals that a profile is too low, local engineering or the inspector shall direct the area to be reblasted. A major departure will be written for a low profile only if the low profile is discovered during a record review. NAVSEA will then be consulted to weigh the various factors contributing to the decision and to determine if the risk of premature failure is justified based on the known schedule impact and cost of rework.
- **Profiles above the limit:** There is low risk of coating failure due to an excessively thick profile, but it does indicate that Quality Control has failed. With solvent based coatings, however, the risk of solvent entrapment increases with excessive profile as more coating must be applied to cover the high peaks with the proper WFT. Excessive profile may indicate a poor choice of abrasive and typically increases the cost of the job due to additional raw materials (paint and abrasive) and labor hours for blasting and clean up. When Dry-Film-Thickness (DFT) readings are performed per Society for Protective Coatings (SSPC)-PA 2, one of the requirements is to "zero" the gage on a blasted, unpainted area. This ensures that the gage readings reflect the coating thickness above the top of the profile peaks, which ensures that the coating thickness is adequate regardless of the surface profile.

Mitigation:

- When high profiles are allowed, mitigation efforts shall be documented and shall include: increased frequency of WFT gage use, special attention to DFT gage calibration, and increased primer thickness when deemed necessary. For paints with lower solids (e.g., MIL-DTL-24441), additional cure time may be necessary to ensure the complete release of solvent as the film cures.

PRESERVATION DEPARTURES FROM SPECIFICATIONS PROCESS DECISION TREE

TABLE B

Surface Preparation					
QA Element	Requirement	Level of Authority Required			
		NAVSEA Major DFS	DFS	Local CHENG DL/DR/ESR/etc.	Mitigation Only
1. Staining a. SSPC-SP 10, SSPC-WAB 10 (L) and SSPC-SP 12 WJ-2 (L)	random staining of an area ≤5%	n/a	random staining of an area >15%	10% < random staining of an area ≤15%	5% < random staining of an area ≤10%
2. Tightly Adherent Coating ⁽¹⁾ a. SSPC-SP 10, SSPC-WAB 10 (L) and SSPC-SP 12 WJ-2 (L)	none remaining	>0.05% remaining or size of largest tightly adherent area >5in ²	Area Affected ≤0.05% and Size of Largest Area <5in ²	Area Affected ≤0.02% and Size of Largest Area <2in ²	n/a
3. Flash Rusting a. SSPC-WAB 10 (L) and SSPC-SP 12 WJ-2 (L)	flash rust no greater than "L" on entire surface(2)	5% < not "L"	2% < not "L" ≤5%	0.5% < not "L" ≤2%	not "L" <0.5%

Notes:

- As defined by SSPC-SP 7.
- NAVSEA allows SSPC-WJ-2 and SSPC-WAB-10 surfaces to flash rust to "L" or "Light" for application of coatings on Naval vessels. SSPC defines flash rust as discoloration that develops within a few hours of completion of blasting as the surface dries. Any rust that develops over several hours or days after the surface has completely dried is defined as rust-back, not flash rust. Immediately after the surface has dried, the amount of flash rust that has developed shall be determined, and shall not be greater than "Light", as defined below. Immediately prior to painting, however, if rust-back has occurred such that rust is present in excess of the amounts allowed by SP-10, WJ-2, or WAB-10 (whether tightly adherent or not), the surface must be re-blasted to remove this rust and bring the surface back into the required condition. Rust-back is also an indication that chlorides remain present on the surface, which will directly negatively impact the final coating system performance, even if the rust itself is tightly adherent.

VII-11A-4

COMUSFLTFORCOMINST 4790.3 REV C

PRESERVATION DEPARTURES FROM SPECIFICATIONS PROCESS DECISION TREE

Surface Preparation

Rationale for Allowing Departure:

- **Staining:** Paragraph 5.4.7.3 of NSTM 631 states in part that SSPC-SP-6 (which allows 33% random staining) will result in a degree of cleaning that is adequate for the majority of conventional coating systems under normal exposure conditions. The current requirement for dry abrasive blasted areas is SSPC-SP 10 (which allows 5% random staining) - allowing up to 15% staining with adjudication and mitigation at the local level does not represent a high risk.
- **Staining and Productivity:** If a small area of out-of-specification cleanliness is discovered prior to complete cleaning of the tank or area, the inspector or local engineering code normally direct further blasting. If the condition is discovered after completion of the final cleaning, reblasting would normally involve the loss of two to three production days (as much as 60% of the original production blasting cost) to reblast and reclean the area. The cost of reblasting and recleaning generally is not cost effective since the small amount of surface prepared to SSPC-SP-6 is not expected to impact the coating performance.
- **Tightly Adherent Coating:** Paragraph 7.2.4.4 of NSTM 631 states in part, "Brush-off blasting (SSPC-SP-7) may be used instead of blasting to bare metal in those instances where an epoxy coating is in good condition and has been applied over a well-prepared surface. This method should result in a surface retaining all paint films, but free from all corrosion products, scale, and foreign matter". SSPC-SP-7 is considered an adequate surface preparation method when the remaining coating is in good condition.
- **Excessive Flash Rust:** During preparation of a large area with wet abrasive or Ultra high pressure, some of the adjoining area will flash to "M" or "H". Recovery from flash rusting often requires an effort equivalent to the initial preparation of the surface. In cases where a small area has excessive flash rust bloom adjoining a larger area of acceptable surface, the rework to recover the required surface condition will result in contamination of the adjoining surface with water, "mud" from the removed surface corrosion, grit and dust if an abrasive is used. Once an area is contaminated, the potential to leave some contaminant on the surface is increased, regardless of the recovery actions to clean the surface. The allowance above requires the area to be generally within specification with small areas of flash rusting in excess of "L", resulting in a very low risk of coating failure.

Mitigation:

- **Tightly Adherent Coating:** Mitigation of this condition consists of: 1) documenting the size and general location of remaining coating, 2) ensuring that the remaining coating is truly "tightly adherent" as defined by SSPC-SP 7, 3) ensuring remaining coating has a visible profile, and 4) ensuring that the estimates of size and percent area covered are as accurate as possible.
- **Excessive Staining:** Documentation of the extent of staining.
- **Excessive Flash Rust:** Flash rust must be minimized in areas that are prone to coating failure, e.g., edges, beneath overboard discharges, weld beads, etc. Document extent and location of flash rust.

PRESERVATION DEPARTURES FROM SPECIFICATIONS PROCESS DECISION TREE

TABLE C

Surface Preparation					
QA Element	Requirement	Level of Authority Required			
		NAVSEA Major DFS	DFS	Local CHENG DL/DR/ESR/etc.	Mitigation Only
A. Surface Contamination					
1. Conductivity					
a. All Immersed Areas	<30µS/cm	>35µS/cm	30µS/cm < conductivity ≤35µS/cm	n/a	n/a
b. Flight Decks, Weather Decks, Hangar Bay and All Other Areas	<70µS/cm	>85µS/cm	70µS/cm conductivity ≤85µS/cm	n/a	n/a
2. Hydrocarbons					
a. SSPS-SP 1 (before and after surface preparation)	none visible	when mitigation efforts fail and area contaminated >0.03%	when mitigation efforts fail and area contaminated ≤0.03%	n/a	n/a
3. Dust (ISO 8502-3)	dust quantity ≤2 dust particle size ≤2	dust quantity >3 dust particle >3	n/a	2< dust quantity <3 2< dust particle <3	n/a
4. QA Readings	(1)	missing >25%	10%≤ missing ≤25%	missing ≤10%	
Notes:					
1. Documentation requirement for conductivity: five (5) readings for each 1000ft ² of surface being prepared. Documentation requirement for dust test: three (3) tapes for the first 1000ft ² , one (1) tape per 1000ft ² thereafter, minimum of three (3) tapes per area being preserved.					

PRESERVATION DEPARTURES FROM SPECIFICATIONS PROCESS DECISION TREE

Surface Preparation

Rationale for Allowing Departure:

- **Conductivity:** Excessive chloride contamination can result in blistering of the coating in an immersion area, and can accelerate corrosion under the coating in immersion or non-immersion areas. Because chloride contamination presents a significant risk for premature spot coating failure there is very little tolerance for an out of specification condition. The values that will be resolved by NAVSEA approach a level where premature coating failure may occur, therefore NAVSEA involvement is required to ensure adequate recovery actions, process control and inspection is invoked.
- **Hydrocarbon Contamination:** Hydrocarbon contamination on a surface is a more significant cause for premature spot coating failure than chlorides. When contamination is discovered prior to surface preparation or upon completion of surface preparation, the surface will be rejected and re-cleaned. Local engineering codes and the inspectors will not authorize surface preparation or coating in cases where there is known contamination. The only time a DFS (local or off station) will be processed is if the contaminant is discovered after the surface preparation is completed and there is suspicion that the contaminant has been driven into the surface during surface preparation.
- **Dust:** Dust remaining on the surface prior to coating can significantly impact the long-term adhesion of the coating. The rationale for the high percentage of missing readings allowed prior to NAVSEA involvement is that normally very few readings are required. 25% missing readings may be only 1 reading less than the required number of readings.

PRESERVATION DEPARTURES FROM SPECIFICATIONS PROCESS DECISION TREE

TABLE D

Surface Preparation					
QA Element	Requirement	Level of Authority Required			
		NAVSEA Major DFS	DFS	Local CHENG DL/DR/ESR/etc.	Mitigation Only
A. Environmental Conditions (times are cumulative)					
1. % Relative Humidity					
a. Tanks	RH ≤50%	>55% for >2 hours	n/a	50%< RH ≤55% for ≥2 hours	50%< RH ≤55% for <2 hours
b. Other Areas	RH ≤85%	>90% for >2 hours	n/a	85%< RH ≤90% for ≥2 hours	85%< RH ≤90% for <2 hours
2. Substrate Temperature					
a. High, Out of Specification	varies by application	temperature during painting or curing >110% of maximum allowed ⁽³⁾	n/a	100%< temperature during painting <i>or</i> curing ≤110% ⁽³⁾	n/a
b. Low, Out of Specification	varies by application	temperature during painting or curing <90% of minimum required ⁽³⁾	n/a	90%≤ temperature during painting <i>or</i> curing <100% with no mitigation ^(2, 3)	90%≤ temperature during painting <i>or</i> curing <100% ⁽³⁾
c. Flight Deck Temperature	varies by application	any noncompliance	n/a	n/a	n/a
d. At or Close to Dew Point	substrate temperature >5°F above the dew point	at or below dew point during painting <i>or</i> curing	n/a	temperature <5°F above the dew point with no mitigation ⁽²⁾	temperature <5°F above the dew point (<i>not</i> allowed on submarines)
3. QA Readings	(1)	missing >25%	10%< missing ≤25%	missing ≤10%	n/a

PRESERVATION DEPARTURES FROM SPECIFICATIONS PROCESS DECISION TREE

Surface Preparation and Coating Application

Notes:

1. Varies by application, review technical documentation for specific documentation requirements.
2. This would occur when the condition was discovered during a record review of completed or in-process preservation.
3. Temperature in °F only.

Rationale for Allowing Departures:

- **Substrate Temperature:** When the substrate temperature is out of specification (except for high temperature), additional cure time within specification can be added prior to application of the next stripe or full coat of paint to mitigate “out of specification” conditions (additional cure time required is the amount of time the environmental conditions were out-of-specification). This additional cure time must be documented properly. Additional cure time after application of a subsequent coat of paint does not satisfy the curing requirement. For excessive temperature conditions, local engineering resolution is required.

Mitigation:

- **Substrate Temperature, At Or Close To Dew Point:** Painting or blasting when the substrate temperature is less than 5°F above the dew point may be acceptable in some circumstances, e.g., during the early morning when temperatures are clearly rising. Proper mitigation for this condition is a documented increase in dew point/substrate temperature measurement to ensure that the substrate temperature does not fall below the dew point and frequent visual inspection to ensure that moisture has not condensed on the surface.

PRESERVATION DEPARTURES FROM SPECIFICATIONS PROCESS DECISION TREE

TABLE E

Coating Application					
		Level of Authority Required			
QA Element	Requirement	NAVSEA Major DFS	DFS	Local CHENG DL/DR/ESR/etc.	Mitigation Only
A. Receipt Inspection	(1)	product applied, no receipt inspection possible	n/a	coating applied and sufficient coating remaining to perform receipt inspection	n/a
B. Shelf Life	verify coating shelf life not expired prior to application of coating	product applied, no shelf life extension possible	n/a	coating applied and sufficient coating remaining to perform shelf life extension inspection	n/a
C. Mixing (mixing temperature and ratio)					n/a
1. All Paint (except nonskid)	varies by application	improperly mixed or off-ratio paint applied	n/a	mixing temperature out of- specification ⁽²⁾	n/a
2. Nonskid	varies by application	any noncompliance	n/a	n/a	n/a

Notes:

1. Receipt inspection requirements: 1) surface ships require Certificate of Conformance for all coatings, and 2) submarine requirements are covered in NSTM Chapter 631, Table 11-1.
2. This would occur when the condition was discovered during a record review of completed or in-process preservation.

Rationale for Allowing Departure:

• **Shelf Life:** Coatings must be certified based on receipt inspection for submarines per NSTM Chapter 631, or based on receipt inspection or a Certificate of Compliance for surface craft per SI 009-32. In some cases due to logistical problems the coating is received without receipt inspection, or with an expired shelf life, just prior to when it must be applied.

PRESERVATION DEPARTURES FROM SPECIFICATIONS PROCESS DECISION TREE

TABLE E (CON'T)

Coating Application

QA Element	Requirement	Level of Authority Required			
		NAVSEA Major DFS	DFS	Local CHENG DL/DR/ESR/etc.	Mitigation Only
D. DFT (measured IAW SSPC-PA 2)					
1. Ultra-High Solids (UHS) Coatings (per coat or full system) ⁽³⁾	varies by application	overall average coating applied >30mils	system maximum < overall average coating applied ≤30mils	localized average coating applied ≤50mils on ≤20% of the surface ⁽²⁾ and area covered by runs, drips, and sags >1% or of thickness >50mils	area covered by runs, drips, and sags ≤1% of thickness ≤50mils
2. Solvent Based Coatings (per coat or full system) ⁽³⁾	varies by application	measured DFT >150% of maximum allowed	n/a	100% < measured DFT ≤150% of maximum allowed	n/a
3. All Coatings					
a. Total System	varies by application	low, out-of-specification	n/a	n/a	n/a
b. Individual Coat DFT	varies by application	n/a	n/a	low, out-of-specification	
4. QA Readings	(1.)	missing >25%	0% < missing ≤25%	n/a	n/a

Notes:

- SSPC-PA 2 requires five (5) DFT measurements over the first 100 ft², and, for areas up to 300 ft², each 100ft² area shall be measured. For areas up to 1000ft², three (3) 100ft² areas shall be measured. For areas larger than 1000ft², measure three (3) 100ft² areas in the first 1000ft², and one (1) 100ft² for each additional 1000ft² thereafter.
- This is intended to allow for film thickness variations caused by stripecoating and overspray during coating adjacent areas, not for poor workmanship.

VII-11A-11

COMUSFLTFORCOMINST 4790.3 REV C

PRESERVATION DEPARTURES FROM SPECIFICATIONS PROCESS DECISION TREE

TABLE E (CON'T)

Coating Application

Notes:

3. Film thickness indicated does not include stripe coat thickness unless specifically referenced.

Rationale for Allowing Departure:

- **High Solids Coatings:** Currently NSTM 631 Table 11-1 Note 7 allows coatings to be applied to 150% of the required coating thickness. Based on discussions with representatives, “required” thickness refers to the range if a range is stated. The result is that coatings can be applied up to 150% of the maximum range identified by the manufacturer. This interpretation has been common practice by the Naval Shipyards as well as contractors, in accordance with the understanding stated above with NAVSEA.
- **Solvent Based Coatings:** For solvent-based coatings there is a potential for solvent entrapment when a coating is applied at a higher DFT than the manufacturer recommends. The change in interpretation requires closer control for excessive thickness of solvent-based coatings. The risk of solvent entrapment may be mitigated by ventilation, temperature, humidity and the amount of cure time between coats. The new interpretation is somewhat more restrictive for solvent-based coatings, and requires engineering review if the coating is not applied within manufacturer’s recommendations.

Mitigation:

- **High DFT Readings:** Mitigation of high DFT values is mitigated by taking additional DFT readings (as necessary) to identify the extent of the nonconforming condition, documenting these findings, reducing the thickness of follow-on coats when appropriate, and increased attention to application processes (nozzle sizes, stand-off distances, etc.) to prevent recurrence.

PRESERVATION DEPARTURES FROM SPECIFICATIONS PROCESS DECISION TREE

TABLE E (CON'T)

COATING APPLICATION					
QA Element	Requirement	Level of Authority Required			
		NAVSEA Major DFS	DFS	Local CHENG DL/DR/ESR/etc.	Mitigation Only
E. Overcoat Window	see ASTM F-718 datasheet	time for cure insufficient <i>or</i> >125% of maximum time allowed	time for cure insufficient <i>or</i> 115% < of maximum time allowed ≤125%	time for cure insufficient <i>or</i> 100% < of maximum time allowed ≤115%	n/a
F. Cure to Service	see ASTM F-718 datasheet	insufficient	n/a	n/a	n/a
G. Amine Bloom					
1. Prime, Intermediate or Stripe Coat	none present	no corrective action taken	n/a	corrective action taken	n/a
2. Topcoat	n/a	n/a	n/a	condition documented	n/a
<p>Rationale for Allowing Change:</p> <ul style="list-style-type: none"> • Overcoat Windows: Temperature changes during curing can change the minimum and maximum overcoat windows. Local engineering oversight is directed for overcoat window problems because often the contractor or paint shop believes that there is an overcoat window problem in cases where close scrutiny of the environmental records show that there is additional overcoat window remaining. If there is an overcoat window problem the recovery may be to solvent wipe the coating, abrade the coating, or abrasive blast the coating. The local engineering code is to consult with the coating manufacturer to determine the appropriate recovery action, if recovery is possible. 					

VII-11A-13

COMUSFLTFORCOMINST 4790.3 REV C

PRESERVATION DEPARTURES FROM SPECIFICATIONS PROCESS DECISION TREE

TABLE F

Surface Preparation					
		Level of Authority Required			
QA Element	Requirement	NAVSEA		Local CHENG	
		Major DFS	DFS	DL/DR/ESR/etc.	Mitigation Only
A. Blasters	SSPC-C 7	no certification	out of date certification	n/a	n/a
B. Equipment Operators and Sprayers Utilizing Plural Component Equipment	MPCAC	no certification	out of date certification	n/a	n/a
C. Contractors Performing Preservation Work	QP-1	no certification	out of date certification	n/a	n/a
D. Coating Inspectors	NPBI or NACE CIP Level 1	no certification	out of date certification	n/a	n/a

**APPENDIX B
CORRECTIVE ACTION REQUEST**

(LOGO HERE)

CORRECTIVE ACTION REQUEST

TO:	FROM: (Your address here)	
SHIP/HULL NUMBER:	REFERENCES:	
CONTRACT NUMBER:		
SERIAL NUMBER:		
STATEMENT OF NONCONFORMANCE (INCLUDE CONTRACT/SPECIFICATION REQUIREMENTS):		
_____ SIGNATURE OF GOVERNMENT REPRESENTATIVE	_____ DATE	<input type="checkbox"/> SEE ATTACHED
CONTRACTORS RESPONSE (including corrective actions, root cause analysis and preventive actions for potential nonconformities identified):		
_____ SIGNATURE OF CONTRACTOR REPRESENTATIVE	_____ DATE	<input type="checkbox"/> SEE ATTACHED
VERIFICATION AND EVALUATION OF REPLY:	<input type="checkbox"/> SATISFACTORY	<input type="checkbox"/> UNSATISFACTORY
COMMENTS:	<input type="checkbox"/> SEE ATTACHMENT	
_____ SIGNATURE OF GOVERNMENT REPRESENTATIVE	_____ DATE	<input type="checkbox"/> SEE ATTACHED

(This Page Intentionally Left Blank)

APPENDIX C**LETTER OF DELEGATION (Example Only)**

From: _____ (Activity)
 To: _____ (DCMA Component)

Subj: (Insert contract or purchase order number, vendor or subcontractor and address, as appropriate)

Encl: (1) Contract Quality Assurance Requirements Invoked on DCMA at Source
 (2) "DCMA Acknowledgment" of Invoked Contract Quality Assurance Requirements
 (3) Specifications, Contract or Purchase Order (when required)

1. Enclosure (1) is forwarded for implementation by your activity on the subject contract or purchase order and is not intended to restrict any additional inspection requirements imposed by the QAR in accordance with Navy Special Emphasis Program or DCMA Quality Assurance Policy's.
2. Requests for reduction/elimination of any specific inspection requirements listed herein will be considered when supported by proper documentation attesting to the Contractor's control over the process. This documentation may include a copy of the QAR's facility surveillance and inspection program plan that details the method of DCMA verification, manner in which performed and statistical method in which derived. Documentation should include (where appropriate/practicable) a flow chart of the process under consideration detailing product and process audit points and the results of the Contractor's/DCMA statistical analyses of the process which clearly indicates the process is under control and meeting specifications.
3. It is requested that enclosure (2) be completed by the QAR and returned to (appropriate Activity and Code) by the date specified therein. In this endeavor, the QAR is advised as follows:
 - a. Contact (appropriate Activity and Code) when inspection performance requested in enclosure (1) may result in additional costs or delayed delivery.
 - b. Promptly notify this office if any portion of this delegation cannot be accomplished.
 - c. Take exception to enclosure (1) when any specific inspection requirement listed therein meets the conditions of paragraph 2, listed above, with the supporting documentation.
4. A copy of the QAR's inspection and surveillance records, or Navy Special Emphasis Program surveillance and inspection plan, generated in accomplishing enclosure (1) inspections, be submitted to the RMC with each shipment when requested.
5. In lieu of a copy of the actual QAR's inspection records, this Activity will accept a statement similar to that specified below, submitted to the RMC with each shipment. When this method is elected, this Activity reserves the right to request copies of specific records as needed and to review records during Activity's surveys. The QAR's records will be maintained and available upon request.

Contract Quality Assurance requirements invoked by (appropriate Activity and Code) transmittal letter serial number _____ dated _____ on contract or purchase order number _____ and vendor or subcontractor _____ have been satisfactorily completed.

QAR (print name) _____ QAR (Signature) _____ Date _____

GOVERNMENT CONTRACT QUALITY ASSURANCE REQUIREMENTS
INVOKED ON DCMA AT SOURCE

Contract Number: _____ Level: _____
Prime Contractor: _____ DCMA Loc: _____
Subcontractor: _____ DCMA Loc: _____

A. GENERAL INSTRUCTIONS:

The DCMA Quality Assurance Inspection/Surveillance Records or the Navy Special Emphasis Programs surveillance and inspection plan is a prime requisite to assure successful completion of this contract. Assurance of the Contractor's compliance to contract technical and quality requirements is required.

B. DEFINITIONS:

The words listed below are used throughout this delegation and defined herein to clarify intent to the QAR:

- (1) Perform (physically accomplish tests and/or inspections).
- (2) Witness (observe contractor's performance of tests and/or inspections).
- (3) Verify (by reviewing the Contractor's documented evidence of tests/inspections).
- (4) Visually Inspect (view the component, part features or characteristics (e.g., surface condition, cleanliness, marking)) and verify conformance to each visually discernable contract or specification requirement.

C. SPECIFIC INSTRUCTIONS:

The QAR is requested to maintain characteristic numbering as listed. Since only certain characteristics from the NAVSEA Master List are applicable to this contract, the numerical sequence may not be continuous. All correspondence should reference the numbers as listed below in order to assist this Activity to identify to overall program reporting.

Characteristics 1 through 4 below are required to be recorded on the QAR inspection records submitted, are highlighted here to alert the QAR to realize that they are an integral part of the overall control system and shall be administered on each lot ready for shipment:

1. Documentation: The QAR shall verify that paperwork (software pertaining to the shipment) is complete in quantity and applicable to the procurement document and shipment.
2. Damage: The QAR shall perform inspection to ensure damage free condition of shipping containers or protective devices to prevent impairing or degrading the function or quality of the material.
3. Preservation, Packaging, Packing and Marking: The QAR shall perform inspection to assure that preservation, packaging, packing and marking of each shipment is in accordance with the procurement document.
4. Visual: The QAR shall perform visual inspection to assure the material displays an appearance of cleanliness and good workmanship.

Characteristics 5 through 25 will be identified (e.g., circled) as applicable to the purchase order. The characteristics identified will meet the requirements of the purchase order.

5. Material Identification: (perform/verify)
6. Material Verification Tests: (verify)
7. Radiography: (verify)
8. Magnetic Particle Test: (verify)
9. Ultrasonic/Eddy Current Test: (verify)
10. Liquid Penetrant Test: (verify)
11. Operational or Functional Test: (witness)

12. Pressure Test: (witness)
13. Electrical/Electronic Test: (witness)
14. Missing, Wrong or Improperly Assembled Parts: (perform)
15. Dimensions: (perform)
16. Welding: (verify)
17. Brazing: (verify)
18. Soldering: (verify)
19. Finish: (perform)
20. Shelf Life: (verify)
21. Contracted Technical Data: (verify)
22. Mercury Free: (verify)
23. Procedure Approval (Special Process): (verify)
24. Manufacturing Process: (verify)
25. Design Evaluation Tests: (witness)
26. Other (describe in detail)

“DCMA ACKNOWLEDGMENT” OF INVOKED GOVERNMENT CONTRACT
QUALITY ASSURANCE REQUIREMENTS

Government Contract Quality Assurance (GCQA) requirements per transmittal letter dated _____ have been received. The following action(s) will be taken:

- (1) GCQA requirements as specified will be performed.
- (2) GCQA requirements as specified will be performed with exceptions noted below.
- (3) GCQA requirements as specified cannot be performed for reasons explained below.
- (4) QAR inspection records will be forwarded with each shipment per your transmittal letter.

QAR (printed name) _____ QAR (signature) _____ Date _____

Contract Number _____ Subcontractor/Vendor _____

Note: Addressees will check appropriate number(s), complete and return to:

Activity: _____

Location: _____

By Date: _____

VOLUME VII

CHAPTER 12

CONTRACTED SUBMARINE PRESERVATION SYSTEM REPAIRS

REFERENCES.

- (a) NAVSEA Standard Item 009-32 - Cleaning and Painting Requirements Accomplishment
- (b) NAVSEA T9081-AD-MMO-010 & 020 - URO MRC SSN 21 Class
- (c) NAVSEA 0924-LP-064-8010 - URO MRC SSN 688 Class
- (d) NAVSEA T0700-AA-PRO-010 - URO MRC SSBN/SSGN 726 Class
- (e) NAVSEA T9081-AE-MMO-010 - URO MRC SSN 774 Class
- (f) NAVSEA MS 7650-081-091 - Submarine Hull Inspection
- (g) NAVSEA MS 6310-081-015 - Submarine Preservation
- (h) NAVSEA 0924-062-0010 - Submarine Safety (SUBSAFE) Requirements Manual

12.1 PURPOSE. To ensure compliance with the Unrestricted Operations (URO) Maintenance Requirement Cards (MRC) Program when accomplishing contract preservation work on submarines. Reference (a) provides standard preservation requirements whereas references (b) through (h) provide submarine specific preservation requirements. This Chapter provides information for the Supervisor of Shipbuilding (SUPSHIP) contracting work on Submarine Preservation Systems to ensure that specific submarine URO MRC requirements are met.

12.2 SCOPE. This chapter provides requirements for Intermediate Maintenance Activities and Navy Contractors to be used in maintaining, repairing, and replacing preservation systems on non-nuclear components and spaces of U.S. Navy submarines. Technical questions regarding the structural URO MRCs or Submarine Preservation shall be directed to Naval Sea Systems Command (NAVSEA) 07T12.

12.3 APPLICABILITY. This chapter is applicable when contracting maintenance on preservation systems of all submarines in service.

NOTE: SUPERVISOR IS RESPONSIBLE TO ENSURE COMPLIANCE WITH ALL URO MRC PROGRAM REQUIREMENTS AND TO ENSURE THAT A URO MRC MEASURED PARAMETER IS NOT VIOLATED.

12.4 SUBMARINE PRESERVATION REQUIREMENTS FOR CONTRACTING. Submarine preservation work has additional requirements to ensure continued safe unrestricted operations until the next inspection. The URO MRC Program contains these requirements. URO MRC inspections and repairs shall be accomplished in accordance with references (b) through (g). The URO MRC Program is invoked by reference (h) and the Submarine Class Maintenance Plans. Preservation system repairs are a URO MRC attribute and are to be accomplished in accordance with reference (g). It is the responsibility of the SUPSHIP to ensure that all URO MRC requirements are met when invoking reference (a) for contracts. Reference (a) has been updated to contain submarine specific painting requirements, however SUPSHIP shall review references (b) through (h) to ensure all submarine safety requirements are accomplished. This may involve requiring structural inspections, repair and reporting.

12.4.1 Structural Integrity. Maintaining the protective capability of the coating system applied to areas that are listed on the Equipment Guide List of the URO MRC inspection and monitoring program is critical to maintaining structural integrity during the periods between inspections. For this reason, complying with requirements for coating system application for all aspects of the preservation process is essential. Other systems that impact the URO MRC 003 program are Special Hull Treatment application process, including Mold-In-Place, maintenance of Impressed Current Cathodic Protection systems and anodes, and installation of various types of tiles (acoustic, damping, etc.).

12.4.2 Tanks. Preservation work in submarine tanks and enclosed spaces is usually scheduled to occur when the tanks are opened and entered to perform URO MRC 003 structural inspections. Any time a tank is entered, if the scheduled URO MRC 003 structural inspection is not being performed, a structural visual examination in accordance with reference (f) shall be performed. There are specific qualifications for performing these inspections; requirements are contained in references (b) through (f).

12.4.3 Blasting. Any URO MRC 003 and URO MRC 002 item being blasted and painted must have the URO MRC 003 hull survey inspection and URO MRC 002 inspection performed prior to blasting and prior to repainting. When blasting and repainting an item, ensure that URO MRC structural repair sites are not contaminated with paint overspray until repairs have been completed. Upon completion of structural repairs, the affected areas will be abrasive blasted to SSPC-SP-10 prior to paint application unless otherwise specified.

12.5 REPORTING.

12.5.1 Existing Conditions. Report existing paint conditions and all preservation work performed as required by reference (g). This report and all preservation in-process Quality Assurance and Quality Control documentation are considered URO MRC Objective Quality Evidence. Submarine as-arrived coating inspection requirements are per reference (g) Attachment 7.

12.5.2 As Arrived Conditions. Report as-arrived coating inspections on Submarine Tanks/Voids/Free floods, Sail, Superstructure, and Interior Miscellaneous Inspection Worksheet, reference (g) Form 1, or Submarine Underwater Hull Inspection Worksheet (3.0 Form 2) electronically using the Corrosion Control Information Management System (CCIMS) database located at the following web address: <https://ccims.dc3n.navy.mil> or as a legible hard copy to SUPSHIP. Sample copies of preservation data forms and information on reporting requirements are provided in Section 8 of reference (h). Preservation feedback must be submitted for validation by email notification to preservation.SUBMEPP.ftc@navy.mil at the time the URO MRC report is due. This feedback is considered URO MRC 003 Objective Quality Evidence.

12.5.3 SSN 21 and SSN 774 Class Submarines. For SSN 21 and SSN 774 Class submarines, excessive use of mechanical tools (grinders, sanders, chippers, abrasive blasting, etc.) must be minimized to avoid metal loss due to lack of corrosion allowance. Overly aggressive blasting which causes metal thickness loss over the amount required for surface profile should be avoided. Any areas of potential metal loss by corrosion or mechanical means must be investigated in accordance with URO MRC 003. Mold-In-Place/Special Hull Treatment removal shall be accomplished only by water jetting. Removal by mechanical means is not allowed.

12.6 SUBMARINE PRESERVATION WAIVERS AND DEVIATIONS.

12.6.1 Requirements. Submarine Preservation Waivers and Deviations shall be in accordance with reference (g) section 9. URO MRC Program Waivers and Deviations requirements are as follows:

- a. Nonconformance requests that result in a change of the URO MRC inspection periodicity (not authorized by the URO MRC), a change in a URO MRC technical requirement, or deferral of required work during accomplishment of the URO MRC require NAVSEA approval. Local (Chief Engineer or Type Commander) approval is not authorized for these non-conformances.
- b. To support operational commitments, Commander, Submarine Force Atlantic (COMSUBLANT) and Commander, Submarine Force Pacific (COMSUBPAC) may authorize temporary periodicity extensions (not already authorized by the URO MRC) after consultation with SEA 07T. The periodicity extensions should be limited to the next availability or in port period, where a Submarine Fleet Maintenance Activity is available, and shall be documented by a Major Departure from Specification in accordance with Volume V, Part I, Chapter 8 of this manual. The Departure from Specification shall then be submitted to NAVSEA for approval.

12.6.2 Notification. The cognizant NAVSEA (SEA 07T) and Type Commander codes shall be notified in writing within two days of any URO MRC related decision made by an inspection activity that will result in a change of periodicity, a change of technical requirements, or deferral of required work.

- a. A copy of the notification shall also be forwarded to SUBMEPP (Code 1832). Any subsequent waiver or deviation requests shall be sent to NAVSEA for review and approval or disapproval.
- b. An official signed copy of all NAVSEA approved waivers or deviations shall be included with the Data Report Form when forwarding URO MRC inspection results to SUBMEPP and other addressees.

VOLUME VII**CHAPTER 13****SHIPBOARD CONTRACTING STRATEGY AND UTILIZATION**

13.1 **PURPOSE.** This chapter provides guidance on contracting for shipboard maintenance and modernization work.

13.2 **SCOPE.** This chapter applies to all activities conducting shipboard maintenance or modernization work in Continental United States (CONUS) and Hawaii. Shipboard maintenance and modernization work includes repairs, modernization, installations, alterations or engineering technical services if there is a potential for system/boundary entry, testing or impact on other ship operations; or if there is a requirement for coordination and integration of multiple contractors and government activities.

13.3 **APPLICABILITY.** This chapter does not apply to:

- a. The reactor or primary plant systems under the cognizance of Naval Sea Systems Command (NAVSEA) 08.
- b. Fleet Ballistic Missile systems under the cognizance of Submarine Strategic Program.
- c. Space Systems under the National Security Space Acquisition Policy.
- d. Naval aircraft and avionics equipment.

13.4 **OBJECTIVE.** The objectives of the Comprehensive Contracting Strategy for shipboard maintenance and modernization are:

- a. Alignment of contracting actions amongst Navy requirements officials and contracting and technical warrants.
- b. Solicit contracts for shipboard work only via warranted Navy contracting officers, and ensure they include appropriate technical content.
- c. Improve maintenance contracting “situational awareness”, thereby reducing unnecessary contract proliferation, redundant or niche contracts by identifying existing contracts that could service the need or identify national contracting strategies for similar services.
- d. Coordinate and vector proposed contracting to the proper authorities for procurement, administration, task order management and oversight.
- e. Ensure proper utilization and balance of Alteration Installation Team, Indefinite Delivery/Indefinite Quantity (IDIQ) and Private Sector Industrial Activity (PSIA) contracts to ensure the Navy has procurement options and leverage in the maintenance and modernization market place.
- f. Proper execution oversight.

13.5 **BACKGROUND.** The Fleets, Deputy Assistant Secretary of the Navy (Ships), and Naval Sea Systems Command have embarked on a joint initiative to develop a Comprehensive Contracting Strategy for shipboard maintenance and modernization that compliments the Navy’s use of PSIA contract vehicles as the primary means for accomplishing shipboard work in the private sector. This strategy is an effort to reduce the amount of coordination required during work execution on the waterfront and to reduce the inefficient use of available contracting resources in procurement and administration. This strategy emphasizes the four principles outlined in the paragraphs below.

13.5.1 **Optimal Use of Surface Force Ship/Aircraft Carrier Private Sector Industrial Activity Contracts.** The first strategy is the optimal use of Surface Force Ship/Aircraft Carrier PSIA contracts to accomplish as much maintenance and modernization work within their organic capability in order to gain learning curve efficiencies, facilitate predictable contractor loading, reduce premium prices paid and spread contractor overhead across a larger business volume.

13.5.2 Indefinite Delivery/Indefinite Quantity Contracts. The second strategy is the determination of the right types and numbers of IDIQ contracts required to supplement PSIA contracts so that viable options are available if PSIA contractors are unable to provide suitable coverage, encounter capacity constraints, cannot meet required schedule or exhibit unreasonably high costs.

13.5.3 Industrial Capabilities. The third strategy is the identification of industrial capabilities where the Navy will exclusively use IDIQ contracts to accomplish maintenance and modernization work beyond PSIA capability and develop procurement strategies that most efficiently meet such needs.

13.5.4 Contracts Portfolio. The final strategy is the cataloguing of these contracts in a "Portfolio of Shipboard Production Contracts" managed at the local Regional Maintenance Center (RMC). The local RMC shall be the point of entry for servicing all shipboard maintenance and modernization production requirements, and shall match (whenever possible) requirements to an existing Portfolio Contract.

13.6 OVERVIEW. The elements of the Comprehensive Contracting Strategy for shipboard maintenance and modernization include:

- a. Breadth: any contracted shipboard work (maintenance, repair, modernization, or alteration) that requires system/boundary entry, testing or impact to routine shipboard system operations. Exceptions:
 - (1) Non-permanent change installations (Temporary Alteration, Engineering Development Model and prototype installation).
 - (2) Non-intrusive shipboard technical reviews (ship checks, design reviews, logistic reviews/audits, etc.).
- b. Contract types: PSIA, Original Equipment Manufacturer, IDIQ/Commercial Industrial Services, Alteration Installation Team contracts, Performance Based Logistics repair contracts.
- c. Contract access: The "Portfolio of Shipboard Production Contracts" maintained at RMCs to serve all organizations performing shipboard work.
- d. Shipboard production work execution only with Portfolio Contracts.
- e. Portfolio content managed through the Contracts Governance Council Process.
- f. The Contracts Governance Council (CGC) is the standing body that manages the Contracts Portfolio and provides maintenance and modernization procurement oversight for the Fleet Maintenance Board of Directors (FMBoD). The CGC works to continuously improve this process and the Contracts Portfolio.

13.7 RESPONSIBILITIES.

13.7.1 Fleet Maintenance Board of Directors. The Fleet Maintenance Board of Directors (FMBoD) shall:

- a. Charter the CGC and provide oversight to all processes associated with the Comprehensive Contracting Strategy for shipboard maintenance and modernization.
- b. Render final approval or disapproval for any contractual actions unresolved by the CGC.

13.7.2 Contracts Governance Council. The CGC shall implement the Comprehensive Contracting Strategy for shipboard maintenance and modernization by managing the approved Contracts Portfolio available for customers with shipboard work requirements.

13.7.3 Systems Commands and Program Executive Offices. The Systems Commands and Program Executive Offices shall use contracts in the Contracts Portfolio (including PSIA) for any maintenance or modernization work that is performed on board ships or crafts, or if the work will require substantial integration with other executing activities.

13.7.4 Fleet Maintenance Activities. All CONUS and Hawaii maintenance activities shall ensure all contracted shipboard maintenance and modernization work is done using a contract in the Contracts Portfolio (including PSIA).

13.8 CONTRACTS GOVERNANCE COUNCIL.

13.8.1 Structure. The CGC is a standing body co-chaired by Commander, Naval Regional Maintenance Center (CNRMC), NAVSEA 21 and NAVSEA 02. It is responsible for the continuous improvement of the Contracts Governance process and for providing strategic guidance for the Navy's overall ship maintenance and modernization contracting strategy.

13.8.2 Contracts Governance Council Process. The governance process encompasses shipboard maintenance and modernization contracts used on Fleet assets in CONUS and Hawaii (all customers and all locations). The focus of the CGC is non-nuclear work. Maintenance and modernization of nuclear propulsion systems and supporting sub-systems, as well as SUBSAFE systems and sub-systems, are not applicable under the CGC's cognizance.

13.8.3 Contracts Governance Council Membership. The CGC will consist of senior members representing the following government maintenance and modernization organizations:

- a. CNRMC (Co-Chair)
- b. NAVSEA 21 (Co-Chair)
- c. NAVSEA 02 (Co-Chair)
- d. NAVSEA 00L (Legal Council)
- e. NAVSEA 02A, 02B, 21A, 024, PMS 400F, PMS 470, PMS 505
- f. Naval Regional Maintenance Center (NRMC) Code 300 and Code 400
- g. RMC Code 300 and Code 400
- h. Additional members may include:
 - (1) Fleet Forces Command N43
 - (2) Commanders Pacific Fleet N43
 - (3) Other RMC personnel
 - (4) Submarine Force, Surface Force and Aircraft Carrier Type Commanders (N43)
 - (5) Warfare Centers
 - (6) Program Executive Offices
 - (7) Naval Space and Warfare Command (SPAWAR) 04
 - (8) Naval Supply Fleet Logistics Center

13.8.4 Contracts Governance Council Policy. The CGC seeks to implement and support policy from the Assistant Secretary of the Navy Research, Development and Acquisition and this manual for Comprehensive Contracting and Depot Work Integration for ship maintenance and modernization contracting as follows:

- a. Operate the CGC to oversee contracts that support, plan and execute shipboard maintenance, modernization and sustainment production work.
- b. Manage the portfolio of approved shipboard contracts maintained by CNRMC.
- c. Focus on RMCs to implement standard policy throughout the non-nuclear maintenance and modernization enterprise. This includes any repairs, modernization, installations or alterations where potential exists for systems or boundary entry, work control or tag-out procedures.
- d. Discuss acquisition strategy and how future spirals of PSIA Contracts will be developed.

13.8.5 Contracts Governance Council Products. The CGC will provide:

- a. Management of authorized contracts portfolio to optimize the number of contracts needed to complement PSIA contracts.

- b. A quarterly summary report to CGC Membership. The RMCs shall provide metrics to support the quarterly reports per the Basis for Measurement provided by the CGC.
- c. Business rules for implementing CGC governance at the RMCs.

13.8.6 Contracts Governance Council Expectations. The CGC expects to impact cost and benefits in the following manner:

- a. Increase standardization in the execution of contracts across all RMCs.
- b. Optimize the number of contract vehicles required for shipboard work.
- c. Improve waterfront work integration.
- d. Increase discipline in the contracting process.

13.8.6.1 Contracts Governance Council Monthly Meetings. USFF N431 (Fleet Maintenance Acquisition Manager) will chair the monthly meetings of the CGC. The CGC will render one of three possible actions:

- a. Option year renewal(s) of existing contracts.
- b. Solicitation and award of new contracts.
- c. Incorporation of existing contracts not yet in the Contracts Portfolio.

13.8.6.2 Contracts Governance Council Consideration. The CGC shall approve or disapprove the request(s), or return the request to the requiring agent for clarification or alternate sourcing consideration.

13.8.6.3 Contracts Governance Council Decision. CGC approvals and disapprovals shall be by unanimous decision. Any request for which a unanimous decision can not be achieved will be referred to the “expanded” FMBOD for resolution. The Expanded FMBOD includes the permanent FMBOD members as well as a flag officer or senior executive of the requiring agent’s organization. The Expanded FMBOD will resolve the request.

13.8.6.4 Meeting Administration. CNRMC Business Office will prepare the agenda for the CGC, coordinate all CGC actions, replies, and record the minutes of the meeting. USFF N431 will send a status report to the CNRMC’s Business Officer informing him/her of the disposition of each request for CGC action within five days of the monthly CGC meeting.

13.8.6.5 Quarterly Briefing. USFF N431 will brief the FMBOD quarterly of actions taken by the CGC, and present any unresolved contract action requests for disposition by the FMBOD. The quarterly summary report to the FMBOD will include:

- a. Any changes to the Contracts Portfolio.
- b. Summary statistics on CGC actions.
- c. Any changes made to the review process.
- d. Any problems encountered.
- e. Any recommendations for process improvement.