



ERNEST ORLANDO LAWRENCE  
BERKELEY NATIONAL LABORATORY

Stephen Wiel, Head  
Energy Analysis Department  
Environmental Energy Technologies Division

MS 90R4000  
1 Cyclotron Road  
Berkeley, CA 94720-8136

Tel: 510-486-5396  
Fax: 510-486-6996  
e-mail: Swiel@lbl.gov

---

October 10, 2002

To: Chris Scruton (CEC)  
From: Steve Wiel  
Subject: **Cool Roof Colored Materials**: Monthly Progress Report for September 2002  
CC: Hashem Akbari, Paul Berdahl, Andre Desjarlais, Bill Miller, Ronnen Levinson

A summary of the status of Tasks and Deliverables as of September 30, 2002 is presented in Attachment 1.

## HIGHLIGHTS

- The first Project Advisory Committee (PAC) meeting was held on September 12, 2002, at CEC office in Sacramento.

## Tasks

- 1.1 Attend Kick-Off Meeting  
**This Task is completed.**
- 1.2 Describe Synergistic Projects  
**This Task is completed.**
- 2.1 Establish the Project Advisory Committee (PAC)  
*This task is essentially completed.* However, based on the comments received at the PAC meeting, we will try to add to the PAC two more members representing consumers of cool roofing materials.
- 2.2 Software Standardization  
(No activity.)
- 2.3 PAC Meetings  
We had our first PAC meeting at the CEC office in Sacramento on 12 September 2002, from 9 am to 12 noon. In attendance were the PAC members, the ORNL and LBNL project team, the industrial partners of the project, the CEC project manager, and a few interested CEC staff (see Attachment 2 for the minutes of the PAC meeting and the presentation materials). On the previous afternoon, 11 September 2002, the ORNL and LBNL project team had also met at LBNL with the industrial partners for final coordination for the PAC meeting.

## 2.4 Development of Cool Colored Coatings

### 2.4.1 Identify and Characterize Pigments with High Solar Reflectance

We have assembled two datasets of about 20 pigments each, one from freestanding films prepared by our collaborators at BASF, and one set based on acrylic paints applied over mylar substrates. The data include spectral reflectance with white backing, black backing, and no backing, and spectral transmittance. Extraction of Kubelka Munk scattering and absorption coefficients  $S$  and  $K$  from these data requires assumptions and/or measurements of reflection coefficients from interfaces interior to the films. Since we have four measurements at each wavelength (two more than are necessary for  $S$  and  $K$  determination only), we are presently working to try to extract information on internal interface reflection coefficients from the experimental data.

We experimented with pigment dispersion, using some of the Ferro cool dark pigments. Pigment dispersion (starting with a dry powder) is well known as a critical and difficult step in the preparation of coatings. The powder was milled in a simple shaking device using glass beads and thereby dispersed into an acrylic coating. The visual appearance of drawdowns prepared from this material is excellent.

Shepherd Color sent us a selection of 14 of their cool colored pigments. In cases where they have several pigments of similar color, they sent us the material with the highest solar reflectance. They also explained their measurement technique. They disperse each pigment into a PVDF/acrylic system. This coating is applied over a primed metal substrate at a thickness of 10 mils wet (5 mils dry). (The primer is a thin coating, heavily pigmented with the yellow anticorrosion pigment  $\text{SrCrO}_4$ .) These coatings are thicker than typical metal roof coatings (~1 mil). The idea is to hide the substrate as much as possible. Then the spectral reflectance (only) is measured. Values are posted on Shepherd's website (<http://www.shepherdcolor.com/>).

We located two recent state-of-the-art papers on pigment characterization. These sources are excellent for comparison with our work since they are quite detailed. The first treats DuPont R-960  $\text{TiO}_2$  rutile white pigment (*Acta mater.* 48 (2000) 4571–4576) and the second treats Ciba Specialty Chemicals quinacridone Cinquasia Magenta RT-143-D (*J. Appl. Phys.* 89 (2001) 283–293). We note one lesson in this work: In films with high pigment loading (e.g., 10% by volume) the assumption breaks down that Kubelka Munk  $S$  and  $K$  parameters are each linearly proportional to pigment amount. Thus, we infer that the industry standard Kubelka Munk approach is best used as an interpolation tool and not as a fundamental method for characterizing pigments.

### 2.4.2 Develop a Computer Program for Optimal Design of Cool Coatings (No activity.)

### 2.4.3 Develop a Database of Cool-Colored Pigments (No activity.)

## 2.5 Development of Prototype Cool-Colored Roofing Materials

### 2.5.1 Review of Roofing Materials Manufacturing Methods

The review of literature is progressing on schedule. Our industrial partners will be sharing manufacturing process information with us. Akbari is also planning to visit a few industrial sites (manufacturing of roofing materials) in the vicinity of the Bay Area.

2.5.2 Design Innovative Methods for Application of Cool Coatings to Roofing Materials  
(No activity.)

2.5.3 Accelerated Weathering Testing  
(No activity.)

2.6 Field-Testing and Product Useful Life Testing

2.6.1 Building Energy-Use Measurements at California Demonstration Sites

A written test plan was prepared for the proposed approach to setup and test “Cool Roof Colored Materials” (CRCM) at the California demonstration sites, at ORNL on the Envelope Systems Research Apparatus (ESRA) and at the California weathering farms. ORNL is awaiting comments from LBNL and the Florida Solar Research Center before submitting to the project technical manager at the CEC.

Contacts were made and participants of the CEC “Cool Roof Colored materials” project are in the process of preparing metal and tile roof products for field-testing on the ESRA Habitat for Humanity demonstration homes and for the weathering sites. The Habitat for Humanity has plans to build 12 new houses this upcoming fiscal year, and ORNL has made a commitment to supply roof materials for four of the new homes.

2.6.2 Materials Testing at Weathering Farms in California

A test plan has been prepared; see Task 2.6.1.

2.6.3 Steep-slope Assembly Testing at ORNL

The roof of the ESRA has a purlin structure supporting a metal deck and wood fiber-board insulation covered by several different single-ply membranes. The purlins are designed to support roof loads upwards of 40 lbs per square foot. A stress analysis is underway as part of an ORNL safety review to check the safe loading for this portion of the roof that will bear the new steep slope assembly. The assembly shall have five of its eight test lanes in tile roofing, which increases the weight by about 2,700 lbs. The stress analysis will determine whether additional beam supports are needed for strengthening the existing roof purlins.

2.6.4 Product Useful Life Testing  
(No activity.)

2.7 Technology transfer and market plan

2.7.1 Technology Transfer

Miller (ORNL) attended the National Coil Coaters Associations (NCCA) annual meeting in St. Louis and presented results on the loss of reflectance of painted and unpainted metal roof products as affected by three years of weathering exposure. The

presentation also addressed the performance of complex inorganic color pigments in painted polyvinylidene fluoride coatings applied to painted metal.

PRA International Center for Coatings Technology accepted an abstract, "Energy and Durability Performance of Complex Inorganic Color Pigments used in Polyvinylidene Fluoride Coatings," from Miller for presentation at their upcoming *Fluorine in Coatings V* conference call for papers to be held in Orlando, FL on January 21, 2003. A paper "Cool Color Roofs with Complex Inorganic Color Pigments" was presented at the American Council for an Energy Efficient Economy 2002 Summer Study. The paper addressed preliminary findings of the surface properties causing cool pigmented colors to reflect infrared radiation. Accelerated weather testing using natural sunlight and xenon-arc weatherometer exposure showed that color changes in the cool pigmented colors were indistinguishable from their original color, even after one year of field exposure and 5000 hours of xenon-arc exposure.

2.7.2 Market Plan  
(No activity.)

2.7.3 Title 24 Code Revisions  
(No significant activity.)

### **Management Issues**

- None

Attachment 1

**Project Tasks and Schedules (Approved on May 16, 2002)**

Task	Task Title and Deliverables	Plan Start Date	Actual Start Date	Plan Finish Date	Actual Finish Date	% Completion as of August 31, 2002
1.1	Attend Kick Off Meeting <i>Deliverables:</i> <ul style="list-style-type: none"> <li>Written documentation of meeting agreements and all pertinent information (<b>Completed</b>)</li> <li>Initial schedule for the Project Advisory Committee meetings (<b>Completed</b>)</li> <li>Initial schedule for the Critical Project Reviews (<b>Completed</b>)</li> </ul>	5/16/02	5/16/02	6/1/02	6/10/02	100%
1.2	Describe Synergistic Projects <i>Deliverables:</i> <ul style="list-style-type: none"> <li>A list of relevant on-going projects at LBNL and ORNL (<b>Completed</b>)</li> </ul>	5/1/02	2/1/02	5/1/02	5/1/02	100%
1.3	Identify Required Permits	N/A		N/A		
1.4	Obtain Required Permits	N/A		N/A		
1.5	Prepare Production Readiness Plan	N/A		N/A		
2.1	Establish the project advisory committee <i>Deliverables:</i> <ul style="list-style-type: none"> <li>Proposed Initial PAC Organization Membership List (<b>Completed</b>)</li> <li>Final Initial PAC Organization Membership List</li> <li>PAC Meeting Schedule (<b>Completed</b>)</li> <li>Letters of Acceptance</li> </ul>	6/1/02	5/17/02	9/1/02		95%
2.2	Software standardization <i>Deliverables:</i> <ul style="list-style-type: none"> <li>When applicable, all reports shall include additional file formats that will be necessary to transfer deliverables to the CEC</li> <li>When applicable, all reports shall include lists of the computer platforms, operating systems and software required to review upcoming software deliverables</li> </ul>	N/A		N/A		

**Project Tasks and Schedules (contd.)**

Task	Task Title and Deliverables	Plan Start Date	Actual Start Date	Plan Finish Date	Actual Finish Date	% Completion as of September 30, 2002
2.3	PAC meetings <i>Deliverables:</i> <ul style="list-style-type: none"> <li>Draft PAC meeting agenda(s) with back-up materials for agenda items</li> <li>Final PAC meeting agenda(s) with back-up materials for agenda items</li> <li>Schedule of Critical Project Reviews</li> <li>Draft PAC Meeting Summaries</li> <li>Final PAC Meeting Summaries</li> </ul>	9/1/02		6/1/05		
2.4	Development of cool colored coatings					
2.4.1	Identify and Characterize Pigments with High Solar Reflectance <i>Deliverables:</i> <ul style="list-style-type: none"> <li>Pigment Characterization Data Report</li> </ul>	6/1/02	6/1/02	12/1/04		~ 5%
2.4.2	Develop a Computer Program for Optimal Design of Cool Coatings <i>Deliverables:</i> <ul style="list-style-type: none"> <li>Computer Program</li> </ul>	11/1/03		12/1/04		
2.4.3	Develop a Database of Cool-Colored Pigments <i>Deliverables:</i> <ul style="list-style-type: none"> <li>Electronic-format Pigment Database</li> </ul>	6/1/03		6/1/05		
2.5	Development of prototype cool-colored roofing materials					
2.5.1	Review of Roofing Materials Manufacturing Methods <i>Deliverables:</i> <ul style="list-style-type: none"> <li>Methods of Fabrication and Coloring Report</li> </ul>	6/1/02	6/1/02	6/1/03		~ 5%
2.5.2	Design Innovative Methods for Application of Cool Coatings to Roofing Materials <i>Deliverables:</i> <ul style="list-style-type: none"> <li>Summary Coating Report</li> <li>Prototype Performance Report</li> </ul>	6/1/02		12/1/04		
2.5.3	Accelerated Weathering Testing <i>Deliverables:</i> <ul style="list-style-type: none"> <li>Accelerated Weathering Testing Report</li> </ul>	11/1/02		6/1/05		

**Project Tasks and Schedules (contd.)**

Task	Task Title	Plan Start Date	Actual Start Date	Plan Finish Date	Actual Finish Date	% Completion as of August 31, 2002
2.6	Field-testing and product useful life testing					
2.6.1	Building Energy-Use Measurements at California Demonstration Sites <i>Deliverables:</i> <ul style="list-style-type: none"> <li>Demonstration Site Test Plan</li> <li>Test Site Report</li> </ul>	6/1/02		10/1/05		
2.6.2	Materials Testing at Weathering Farms in California <i>Deliverables:</i> <ul style="list-style-type: none"> <li>Weathering Studies Report</li> </ul>	6/1/02		10/1/05		
2.6.3	Steep-slope Assembly Testing at ORNL <i>Deliverables:</i> <ul style="list-style-type: none"> <li>Whole-Building Energy Model Validation Presentation at the Pacific Coast Builders Conference</li> </ul>	6/1/02		10/1/05		< 5%
2.6.4	Product Useful Life Testing <i>Deliverables:</i> <ul style="list-style-type: none"> <li>Solar Reflectance Test Report</li> </ul>	5/1/04		6/1/05		
2.7	Technology transfer and market plan					
2.7.1	Technology Transfer <i>Deliverables:</i> <ul style="list-style-type: none"> <li>Publication of results in industry magazines and refereed journal articles</li> <li>Participation in buildings products exhibition, such as the PCBC</li> <li>Brochure summarizing research results and characterizing the benefits of cool colored roofing materials</li> </ul>	6/1/03		6/1/05		
2.7.2	Market Plan <i>Deliverables:</i> <ul style="list-style-type: none"> <li>Market Plan(s)</li> </ul>	5/1/05		6/1/05		
2.7.3	Title 24 Code Revisions <i>Deliverables:</i> <ul style="list-style-type: none"> <li>Document coordination with Cool Roofs Rating Council in monthly progress reports</li> <li>Title 24 Database</li> </ul>	6/1/02	5/16/02	6/1/05		~ 5%

Attachment 2  
Minutes of September 12, 2002, PAC meeting



September 26, 2002

To: Chris Scruton  
Project Manager  
California Energy Commission

From: Hashem Akbari

Subject: Cool Roof Colored Materials—Minutes of September 12, 2002 PAC Meeting

CC: Berdahl, P. (LBNL); Desjarlais, A. (ORNL); Jenkins, N. (CEC); Levinson, R. (LBNL);  
Miller, W. (ORNL); Wiel, S. (LBNL)

On September 12, 2002 from 9 am to 12 noon, the LBNL/ORNL project staff and the CEC project manager held their first Project Advisory Committee meeting at CEC headquarters in Sacramento for CEC's project on Development of Cool Colored Roofing Materials. Present at the meeting were the LBNL/ORNL project team, the CEC project manager, members of the PAC, representatives from nine industrial partners, and several interested Commission staff. The meeting participants are listed in Attachment 1. The agenda for the meeting is presented in Attachment 2. Attachments 3, 4, and 5 list the LBNL and ORNL project team members, the industrial partners to the project, and the members of the PAC, respectively.

## I. Introduction

- A. The CEC Project Manger, Chris Scruton, opened the meeting with some comments on the objectives of the project and the reasons to have PAC meetings. Before the meeting participants introduced themselves, Commissioner Rosenfeld remarked on the importance of the subject project and development of cool colored roofing materials particularly for the residential market in California.
- B. The meeting participants (PAC members, project team members, and industrial partners) introduced themselves and stated their specific interest in the project.

## II. Project Objectives and Technical Tasks

- A. **Project Objective and Organization.** The Project Director, Stephen Wiel (LBNL), briefly reviewed the project objectives and organization of the project (Slides 1–12 of the presentation materials presented in Attachment 6).
- B. **Task 2.4: Development of Cool-Colored Coatings (Slide 13)**
  1. *Identify and Characterize Pigments with High Solar Reflectance (Slides 14–22).* Hashem Akbari, LBNL's Project Technical Director, discussed the progress of Task 2.4.1 since the inception of the project, mentioning that 51 single-pigmented paints have been measured, characterized, and their Kubelka-Munk absorption and scattering coefficients calculated. Measurement methods and some early results were presented. Akbari acknowledged the contribution of BASF to this task. We will continue pigment characterization by measuring more single-pigmented and mass tone paints. Project team members and the industrial partners made various clarification comments.
  2. *Develop a Computer Program for Optimal Design of Cool Coatings (Slides 23–24).* Akbari discussed the objectives of Task 2.4.2 and mentioned that the computer program initially will be an algorithm that allows us to design a cool coating for the optimal solar reflectance. The algorithm will use the data developed in Task 2.4.1. The algorithm will allow us to estimate coating reflectance from pigment properties (absorption and scattering) and film geometry

- (mixing and layering). The output of the algorithm will be a recommendation of pigments and geometry to match color while maximizing solar reflectance.
3. *Develop a Database of Cool-Colored Pigments* (Slide 25–27). Akbari stated that the objective of Task 2.4.3 is to develop a database that initially can be used by all project team members and the industrial partners. The database will provide a uniform approach for reporting data on cool pigments. Upon the completion of the project, the database can be available to others and the public interested in application of cool-colored pigments. Akbari also presented an outline of the present LBNL database for cool roofs.
- C. Task 2.5: Development of Prototype Cool-Colored Roofing Materials** (Slide 28). Akbari stated that the objective of Task 2.5 is to review the current methods of application of color pigments on roofing materials and design innovative engineering methods to achieve superior solar reflectance.
1. *Review of Roofing Materials Manufacturing Methods* (Slides 29–30). The methods of applying color pigments to various roofing materials are significantly different. On Task 2.5.1 (started on June, 2002), with assistance from our industrial partners, we will prepare a summary report discussing the application of pigments on metal roofings, clay rooftiles, concrete rooftiles, wood shakes, and asphalt singles (granules).
  2. *Design Innovative Methods for Application of Cool Coatings to Roofing Materials* (Slides 31–34). In our previous collaboration with ISP Minerals, we developed granules for ultra-white shingles. ISP Minerals is currently manufacturing these ultra-white granules for materials used on low-sloped commercial roofing. In the laboratory, we have used some cool pigments and through innovative applications have achieved higher solar reflectance than the cool pigment on smooth surfaces. However, when cool pigments are applied to granules, their reflectance is not as high as the reflectance on smooth surfaces. One objective of Task 2.5.2 is to design methods to obtain higher solar reflectance of granules.
  3. *Accelerated Weathering Testing* (Slides 35–40). Manufacturers would like to understand the performance of their materials over time. This objective is typically achieved by testing the materials in weatherometers and weather farm. Many of our industrial partners have accelerated weather-testing facilities. The project team and the industrial partners will work closely on Task 2.5.3 to obtain accelerated weather test results for cool roofing materials. Some early results at Ferro indicated that the cool pigments have maintained their characteristics over time. Another issue related to cool coatings is the reduction in their solar reflectance because of aging and dust gathering. Tests performed at LBNL suggest that carbon soot is probably the main reason for the reduction in solar reflectance.
- D. Task 2.6: Field Testing and Product Useful Life Testing** (Slides 41–42). André Desjarlais, ORNL's Project Technical Director, stated that the objective of Task 2.6 is to demonstrate, measure, and document the building energy savings, improved durability and sustainability of cool-colored roofing materials. The testing will be performed at various sites in California.
1. *Building Energy Use Measurements at California Demonstration Sites* (Slides 43–46). On Task 2.6.1, we will measure the energy saving potentials of cool-colored roofs on several residences. Houses built for Habitat for Humanity (HfH) will be selected for side-by-side comparison of cool and standard roofs. The results will be used to calibrate an attic model (Attic SIM). It is preferable to have an unoccupied house with a simple operation. We will use California sizes for air-conditioners and electrical resistance heaters. Bill Pennington (CEC) mentioned that in California there are not many houses that are heated with electric resistance heaters; gas heating is used most often. Desjarlais' goal is to get metal and tile roofs installed on HfH homes before the next PAC meeting. Shingle and Shake installations must await better materials becoming available.
  2. *Materials Testing at Weathering Farms in California* (Slides 47–51). Desjarlais stated that the objective of Task 2.6.2 is to document changes in solar reflectance and thermal emittance for roofing products having cool pigments that occur from exposure to the elements. He

- presented some data showing the effect of biomass and dust accumulation on changes on solar reflectance.
3. *Steep-Slope Assembly Testing at ORNL* (Slides 52–56). The objective of Task 2.6.3 is to select appropriate cool color pigments, apply them to roofing materials and field test the roof products on the Envelope Systems Research Apparatus (ESRA) to document the effect of reflectance and emittance weathering on the thermal performance of the cool pigment roof system. Desjarlais presented some of the capabilities of the ESRA system. *Product Useful Life Testing* (Slides 57–58). It has been stated that cool roofing materials last longer. The objective of Task 2.6.4 is to investigate the effect of solar reflectance on the useful life of roofing products. We will perform accelerated testing of roofing materials of the same colors (cool vs. standard). The primary focus will be on shingles and wood shakes.
- E. Task 2.7: Technology Transfer and Marketing Plan** (Slide 59). The objective of Task 2.7 is to make cool-colored roofing materials a market reality within 3–5 years. In addition to the technical tasks discussed above, we will try to achieve this objective by technology transfer, working with industrial partners to develop marketing plans, and working with CEC/Title 24 to incorporate code changes.
1. *Technology Transfer* (Slide 60–62). Describing accomplishments to date in Task 2.7.1, Akbari stated that in the August meeting of ACEEE, Bill Miller (ORNL) presented a paper. Also, at LBNL we have developed a brochure featuring cool-colored metal roofing materials. We are planning to develop such brochures for other roofing materials.
  2. *Market Plan* (Slide 63). The objective of Task 2.7.2 is to develop and initiate actions to facilitate the market adoption of cool-colored roofing products. Bob Scichili (BASF) stated that as cool metal roofing gains market acceptability, BASF will probably phase out the standard color production line. There were several comments on how to develop effective marketing plans.
  3. *Title 24 Code Revisions* (Slides 64–68). Bill Pennington (CEC) presented the current status of commercial and residential building Title 24 standards. He pointed out that the CEC currently has criteria for prescriptive requirements for reflective roofing materials. He is very interested in moving the industry as rapidly as possible toward more cool roofing products. Akbari stated that the objective of Task 2.7.3 is to collaborate with Title 24 to revise the code to include cool colored roofs for sloped-roof buildings. He then provided an overview of sections of Title 24 related to roofs. He also presented a summary of a recent code-change proposal for application of cool roofs on low-sloped non-residential buildings.
- F. Discussion.** There was lively discussion during the presentations described above. Bill Pennington and Bob Scichili both commented that we should expand the PAC members to include representation from people who apply cool roofs, especially the architectural community. Nancy Jenkins (CEC) suggested inviting a representative from the American Institute of Architects (AIA). Mike Rothenberg (BAAQMD) suggested that the project focus on developing cool materials for those roofing materials most commonly sold in the market and hence having the greatest potential impact. There was a discussion on the market saturation of various roofing types in California. Tom Bollnow (NRCA) offered NRCA data on new market purchases to the team members. (Peter Fleming (3M) stated that he may have sales data for the California market and, if so, will make it available to the project team. Keith Tellman (Elk Corp.) observed that cool white shingles won't sell, so availability of colored materials is essential.

At various times during the meeting, people provided useful information. Bill Pennington pointed out the absence of resistance heaters and sparsity of heat pumps in California. Chris Scruton raised the issue of industry's frustration with EPA's EnergyStar rating system for cool roofs (three-years testing) and pointed out the opportunity for useful dialogue between industry and EPA. There was much discussion on this point. Suzuki (MCA Tile) questioned the need for the three year wait. Scichili (BASF) mentioned that on October 1, 2002 Desjarlais (ORNL) and Scichili will attend the "Metal Roofing" conference and raise the issue there. Hashem agreed to

write a letter with Bob Scichili's help, to the editors of *Metal Architecture*, *Metal Construction News* and *Metal Home Digest*. Desjarlais (ORNL) commented that a low reflectance threshold can lead to low energy savings. Srinivasan (GAF) questioned whether reflectance values of 0.1 to 0.4 can lead to significant energy savings. Desjarlais and Akbari suggested that in a hot climate and a 2000 square foot house you can save about \$100 per cooling season with a cool roof, with little or no incremental cost. On another subject, Chris Scruton pointed out that BAAQD and the American Lung Association can help spread the word in support of potential roofing improvements to California's Title 24 building code.

- III. **Summary Comments from PAC Members.** At the conclusion of the meeting, each PAC member commented on whatever was on his mind. Tom Shallow (ARMA) stated that he considers the overall project to be positive. He expressed a concern about the project's approach to a marketing plan. Chris Scruton responded by saying that neither the CEC nor its project team is marketing experts and that we're looking to industry to learn how the CEC can help. He also commented that our "market plan" task should have the views of the end-users of the roofing materials.

Mike Rothenberg (BAAQMD) suggested that it is important to focus on what people want now. He offered three ideas: (1) get people to include information about choosing reflective roofing in announcements to the public on Spare the Air Days, (2) develop a model ordinance requiring cool roofs, and (3) calculate cost-benefit breakpoints to help consumers make roofing decisions.

Tom Bollnow (NRCA) offered his organizations help in getting information about cool roofing materials to the design community, pointing out that they've got to be sold. Chris Scruton pointed out that increased roof longevity should get their attention. Krishna Srinivasan (GAF) agreed that the design community should care because consumers care so much about roof life.

- IV. **Schedules of PAC Meetings and Concluding Remarks** (Slides 69–70). The schedules of all future PAC meetings were presented. We will finalize the schedule for each meeting about 3 months in advance. All materials related to the project will be posted to <http://CoolColors.LBL.gov>.
- V. **Adjourn.** The PAC meeting adjourned at 12:20 pm.

*Attachment 1.*

**Attendance, Cool Colored Roof PAC Meeting  
Sacramento  
September 12, 2002**

<b>Name</b>	<b>Affiliation</b>	<b>Phone Number</b>
Akbari, Hashem	Lawrence Berkeley National Laboratory	510-486-4287
Berdahl, Paul	Lawrence Berkeley National Laboratory	510-486-5278
Blumstein, Carl	University of California/CIEE	510-643-0505
Bollnow, Tom	National Roofing Contractors Association	847-299-9070
Chiovare, Tony	Custom-Bilt Metals	626-454-4850
Desjarlais, André	Oak Ridge National Laboratory	865-574-0022
Dunn, Jim	Ferro Corporation	800-543-3776
Fleming, Pete	3M Minerals	651-733-5074
Jenkins, Nancy	California Energy Commission	916-654-4739
Joedicke, Ingo B.	3M Minerals	301-714-1481
Levinson, Ronnen	Lawrence Berkeley National Laboratory	510-486-7494
Miller, William A.	Oak Ridge National Laboratory	865-574-2013
Pennington, Bill	California Energy Commission	916-654-5013
Rogers, Melinda	California Energy Commission	
Rosenfeld, Arthur	California Energy Commission	
Rothenberg, Mike	Bay Area Air Quality Management District	415-749-4668
Scichili, Robert	BASF Corporation	972-234-0180
Scruton, Chris	California Energy Commission PIER	916-355-0948
Shallow, Tom	Asphalt Roofing Manufacturers	202-207-1110
Sparks, Philip	California Energy Commission	
Srinivasan, Krishna	GAF Materials Corporation	973-628-3043
Steger, Tom	Shepherd Color Company	513-874-0714
Suzuki, Yoshi	MCA Clay Tile	800-736-6221
Tellman, Keith	Elk Corporation	972-872-2284
Vondran, Michelle	BASF Corporation	909-825-6292
Wiel, Stephen	Lawrence Berkeley National Laboratory	510-486-5396

*Attachment 2.*

*Agenda*

**Development of Cool Colored Roofing Materials  
Project Advisory Committee Meeting**

9:00 am to 12 noon

September 12, 2002

California Energy Commission  
Sacramento, California

- I. Introduction (9:00–9:30)**
- A. Opening remarks and the objectives of the PAC meetings (CEC Project Manager: Chris Scruton)
  - B. Introduction of the PAC members (CEC Project Manager: Chris Scruton)
  - C. Introduction of the project ORNL and LBNL project staff (Project Director: Steve Wiel)
  - D. Introduction of the industrial partners (LBNL and ORNL Technical Leads: Hashem Akbari and Andre Desjarlais)
- II. Project Objectives and Technical Tasks: Review and Discussions (9:30–11:30)**
- A. Project Objectives and Organization (Wiel) (9:30–9:45)
  - B. Task 2.4: Development of cool colored coatings (Akbari et al.) (9:45–10:15)
    - 1. Identify and Characterize Pigments with High Solar Reflectance
    - 2. Develop a Computer Program for Optimal Design of Cool Coatings
    - 3. Develop a Database of Cool-Colored Pigments
  - C. Task 2.5: Development of prototype cool-colored roofing materials (Akbari, et al.) (10:15–10:45)
    - 1. Review of Roofing Materials Manufacturing Methods
    - 2. Design Innovative Methods for Application of Cool Coatings to Roofing Materials
    - 3. Accelerated Weathering Testing
  - D. Task 2.6: Field-testing and product useful life testing (Miller/Desjarlais) (10:45–11:15)
    - 1. Building Energy-Use Measurements at California Demonstration Sites
    - 2. Materials Testing at Weathering Farms in California
    - 3. Steep-slope Assembly Testing at ORNL
    - 4. Product Useful Life Testing
  - E. Task 2.7: Technology transfer and market plan (Akbari, Desjarlais) (11:15–11:30)
    - 1. Technology Transfer
    - 2. Market Plan
    - 3. Title 24 Code Revisions
- III. Summary comments from PAC members (11:30–11:50)**
- IV. Schedules of PAC meetings and concluding remarks (11:50–12:00)**
- V. Adjourn (12:00)**

**CEC-Sponsored  
Cool Roof Colored Materials Project  
Project Team Members**

1. **Hashem Akbari**  
Leader, Heat Island Group  
Lawrence Berkeley National Laboratory  
One Cyclotron Road, MS 90R2000  
Berkeley, CA 94720-8130  
Tel: 510-486-4287  
Fax: 510-486-4673  
h\_akbari@lbl.gov
2. **Paul Berdahl**  
Lawrence Berkeley National Laboratory  
One Cyclotron Road, MS 70R0108B  
Berkeley, CA 94720-8168  
Tel: 510-486-5278, 486-7417  
Fax: 510-486-7303  
PHBerdahl@lbl.gov
3. **André Desjarlais**  
Oak Ridge National Laboratory  
PO BOX 2008 MS6070  
Oak Ridge TN 37831-6070  
Tel: 865-574-0022  
Fax: 865-574-9354  
desjarlaisa@ornl.gov
4. **Ronnen Levinson**  
Lawrence Berkeley National Laboratory  
One Cyclotron Road, MS 90R2000  
Berkeley, CA 94720-8130  
Tel: 510-486-7494  
Fax: 510-486-4673  
RMLevinson@lbl.gov
5. **William A. Miller**  
Oak Ridge National Laboratory  
PO Box 2008 MS6070  
Oak Ridge TN 37831-6070  
Tel: 865-574-2013  
Fax: 865-574-9338  
millerwa1@ornl.gov
6. **Stephen Wiel**  
Head, Energy Analysis Department  
Lawrence Berkeley National Laboratory  
One Cyclotron Road, MS 90R4000  
Berkeley, CA 94720-8136  
Tel: 510-486-5396  
Fax: 510-486-6996  
SWiel@lbl.gov

*Attachment 4.*  
CEC Sponsored Cool Roof Project  
Industrial Partners

1. Peter Fleming  
3M Minerals  
651-733-5074  
[PBFeiming1@mmm.com](mailto:PBFeiming1@mmm.com)
2. Ingo Joedicke  
ISP Minerals  
301-714-1481  
[ijoedicke@ispcorp.com](mailto:ijoedicke@ispcorp.com)
3. Krishna Srinivasan / Mike Desouto  
GAF  
973-628-3000  
[Ksrinivasan@gaf.com](mailto:Ksrinivasan@gaf.com)  
[mdesouto@gaf.com](mailto:mdesouto@gaf.com)
4. Lou Hahn  
Elk Manufacturing  
972-872-2293  
[lhahn@elkcorp.com](mailto:lhahn@elkcorp.com)
5. Kenneth Loye / Jim Dunn  
Ferro Corporation  
216-750-7511  
[loyek@ferro.com](mailto:loyek@ferro.com)  
[dunnj@ferro.com](mailto:dunnj@ferro.com)
6. Jeffrey Nixon / Tom Steger  
Shepherd Color Company  
513-874-0714  
[jnixon@shepherdcolor.com](mailto:jnixon@shepherdcolor.com)
7. Tony Chiovare  
Custom-Bit Metals  
626-454-4884  
[Conniec@custombiltmetals.com](mailto:Conniec@custombiltmetals.com)
8. Robert Scichili  
Michelle Vondran  
BASF Metal Roofing  
972-234-0180  
[scichir@basf.com](mailto:scichir@basf.com)  
[vondran@basf-copr.com](mailto:vondran@basf-copr.com)
9. Yoshihiro Suzuki  
MCA Tile  
909-736-9590  
[ysuzuki@mca-tile.com](mailto:ysuzuki@mca-tile.com)



*Attachment 5.*

**Cool Roof Colored Materials  
Project Advisory Committee Members**

- 1. Carl Blumstein  
(or Jim Cole)**  
Director  
California Institute for Energy Efficiency  
UCOP  
1333 Broadway, MS 713948  
Oakland, CA 94612  
Carl: 510-287-3320  
Jim: (510-865-8827)  
[blumstei@socrates.berkeley.edu](mailto:blumstei@socrates.berkeley.edu)  
[JWCole@lbl.gov](mailto:JWCole@lbl.gov)
- 2. Tom Bollnow**  
National Roofing Contractors Association  
10255 W. Higgins Rd., Ste. 600  
Rosemont, IL 60018-5607  
Tel: 847-299-9070  
Fax: 847-299-1926  
[tbollnow@nrca.net](mailto:tbollnow@nrca.net)
- 3. Jack Colbourn**  
Director  
EPA SF Office  
75 Hawthorne Street  
San Francisco, CA 94105  
415-947-4109  
[colbourn.jack@epa.gov](mailto:colbourn.jack@epa.gov)
- 4. Noah Horowitz**  
CRRC Ex-Director  
CRRC  
c/o NRDC  
71 Stevenson Street, Suite 1825  
San Francisco, CA 94105  
415-777-0220  
[nhorowitz@nrdc.org](mailto:nhorowitz@nrdc.org)
- 5. Archie Mulligan**  
Executive Director  
Habitat for Humanity  
890 Morse Avenue  
Sacramento, CA 95864-4922  
T916-456-9543  
F916-456-5449  
[hfh@calweb.com](mailto:hfh@calweb.com)
- 6. Rick Olson**  
Roof Tile Institute  
35524 Zepher Way  
Pleasant Hill, OR 97455  
Tel: 888-321-9236  
Fax: 541-689-5530  
[ntrma@aol.com](mailto:ntrma@aol.com)
- 7. Mike Rothenberg**  
Program Manager  
Bay Area Air Quality Management  
District  
939 Ellis Street  
San Francisco, CA 94109  
415-749-4668  
[mrothenberg@baaqmd.gov](mailto:mrothenberg@baaqmd.gov)
- 8. Steven Ryan**  
Energy Star  
EPA  
Ariel Rios Building  
1200 Independence Avenue NW  
Washington, DC 20460  
202-564-1254  
[Ryan.Steven@epamail.epa.gov](mailto:Ryan.Steven@epamail.epa.gov)
- 9. Thomas A. Shallow**  
Asphalt Roofing Manufacturers  
Association  
1156 15<sup>th</sup> Street, NW Suite 900  
Tel: 202-207-1110  
Fax: 202-223-9741  
Washington, DC 20005  
[tshallow@kellencompany.com](mailto:tshallow@kellencompany.com)

*Attachment 6*

Power Point Presentation

# DEVELOPMENT OF COOL COLORED ROOFING MATERIALS

Project Advisory Committee (PAC) Meeting

**A Collaborative R&D  
Between Industry**

**LBNL**

and

**ORNL**



Sponsored by the California  
Energy Commission  
(Project Manager: Chris Scruton)

September 12, 2002; Sacramento, CA



## How Solar-Reflective Surfaces Save Energy, Improve Air Quality

- Direct Effect: **reflective roofs**
  - stay cool in the sun
  - reduce building air-conditioning use ~ 10%
  - may last longer (less thermal stress)
- Indirect Effect: cool **reflective surfaces**
  - transfer less heat to air
  - lower ambient air temperature ~ 2-3 °F
  - reduce smog ~ 5%



## Cool Roofing Material Availability



- Low-sloped roofs: many materials available
  - Coatings
  - Single-ply membranes
  - Painted metals
- Sloped roofs: limited material availability
  - Tiles
  - Metals
  - Shake
- Most sloped roofs use shingles (not cool)

3

## Solar Energy Distribution

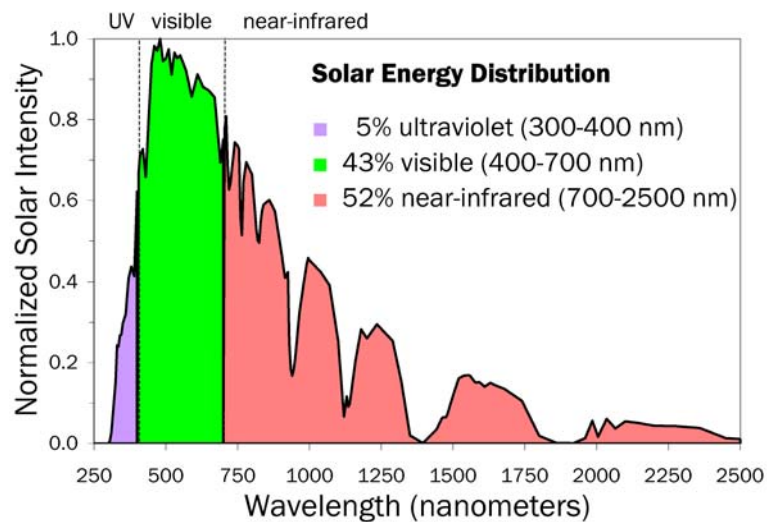

4

## Cool and Standard Browns



- Cool brown 16 °F cooler than standard brown

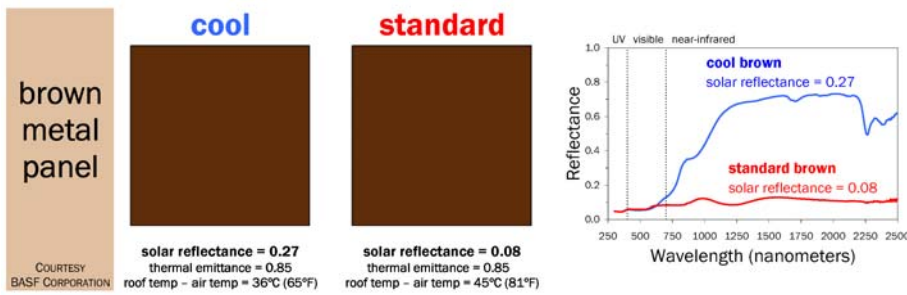

5

## Cool and Standard Greens



- Cool green 12 °F cooler than standard green

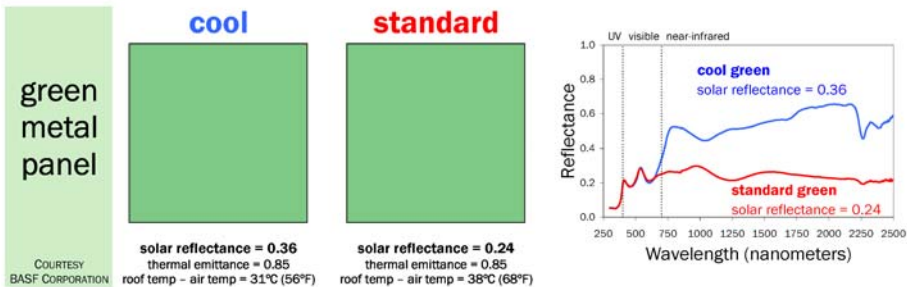

6

## Project Goal



- Bring cool colored roofing materials to the roofing market.
- Measure and document the laboratory and in-situ performance of roofing products
- Accelerate the market penetration of cool metal, tile, wood shake, and shingle products
- Measure and document improvements in the durability of roofing expected to arise from lower operating temperatures

7

## Project Advisory Committee (PAC) Members



1. Asphalt Roofing Manufacturers Association
2. Bay Area Air Quality Management District
3. California Institute for Energy Efficiency
4. Cedar Shake and Shingle Bureau
5. Cool Roof Rating Council
6. Environmental Protection Agency (EPA)
7. EPA San Francisco Office
8. Habitat for Humanity
9. National Roofing Contractors Association
10. Roof Tile Institute

8

## Industrial Partners



- **On Board**
  - 3M
  - BASF / Custom-Bilt Metals
  - Elk Manufacturing
  - Ferro
  - GAF
  - MCA
  - ISP Minerals
  - Shepherd Color Company
- **On List**
  - American Roof Tile Coating
  - DuroLast
  - Rising and Nelson Slate
  - Transmet Corp.

9

## Project Team



- **LBL**
  - Steve Wiel  
(Project Director)  
[S\\_Wiel@LBL.gov](mailto:S_Wiel@LBL.gov)
  - Hashem Akbari  
(Technical Lead)  
[H\\_Akbari@LBL.gov](mailto:H_Akbari@LBL.gov)
  - Paul Berdahl  
[PHBerdahl@LBL.gov](mailto:PHBerdahl@LBL.gov)
  - Ronnen Levinson  
[RMLevinson@LBL.gov](mailto:RMLevinson@LBL.gov)
- **ORNL**
  - Andre Desjarlais  
(Technical Lead)  
[yt7@ORNL.gov](mailto:yt7@ORNL.gov)
  - Bill Miller  
[wml@ornl.gov](mailto:wml@ornl.gov)

10

# Project Management

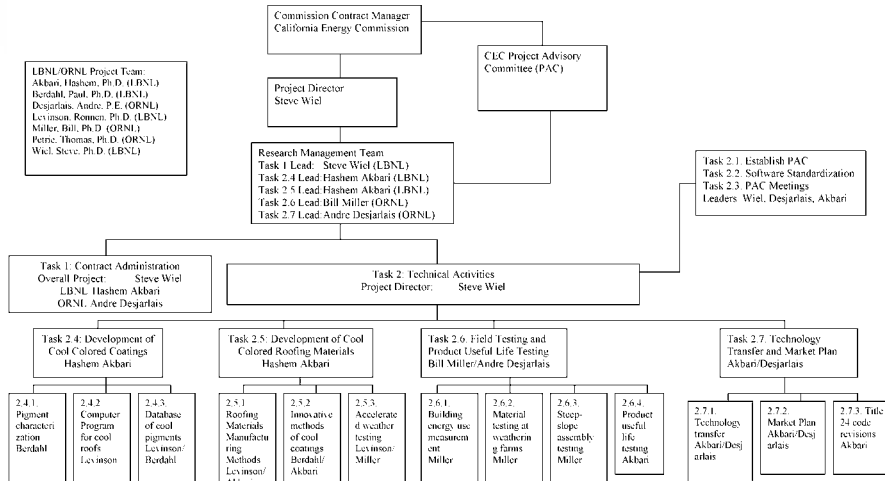

11

# Technical Tasks



- 2.4 Development of cool colored coatings
- 2.5 Development of prototype cool-colored roofing materials
- 2.6 Field-testing and product useful life testing
- 2.7 Technology transfer and market plan

12



## 2.4 Development of Cool Colored Coatings



- Objectives
  - Maximize solar reflectance of a color-matched pigmented coating
  - Compare performance of coated roofing product (e.g. shingle) to that of simple smooth coating
- Subtasks
  - Identify and characterize pigments with high solar reflectance
  - Develop a computer program for optimal design of cool coatings
  - Develop a database of cool-colored pigments

13

### 2.4.1 Identify & Characterize Pigments w/High Solar Reflectance



- Objective: Identify and characterize pigments with high solar reflectance that can be used to develop cool-colored roofing materials
- Deliverables:
  - Pigment Characterization Data Report
- Schedule: 6/1/02 – 12/1/04

14

## Pigment Characterization



- LBNL has characterized pigments used in 51 single-pigment paints (artist-color acrylics, BASF PVDFs)

- 9 blues
- 8 reds
- 7 greens
- 7 blacks
- 7 yellows
- 5 browns
- 3 whites
- 2 violets
- 2 oranges
- 1 gold

### ***Eight Reds***

B815R65 Red Iron Oxide (I)  
B815R66 Red Iron Oxide (II)  
B835R4 Monstral Red  
LM38 Interference Red  
LM108 Acra Burnt Orange  
LM112 Acra Red  
LM294 Naphthol Red Light  
LM335 Red Oxide

15

## Some BASF Single-Pigment Paints (25- $\mu$ m Film Over Opaque White)



16

## Paint Film Properties



- Paint films characterized by thickness, reflectance, absorptance, transmittance

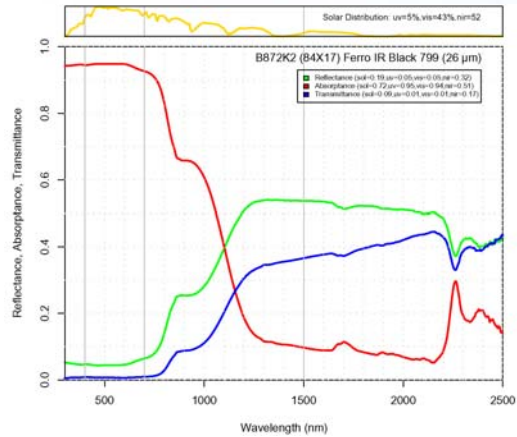

17

## Pigment Properties



- Pigments characterized by absorption, scattering coefficients (Kubelka-Munk theory)

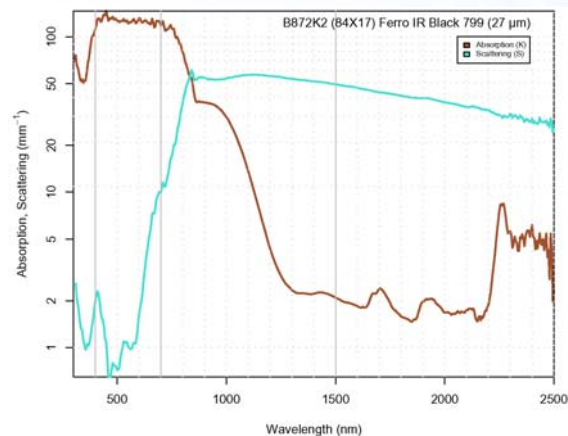

18

## Spectrometer for Spectral Reflectance, Transmittance



- UV-VIS-NIR instrument (Perkin-Elmer Lambda 19) with integrating sphere
- Accurate laboratory measurement



19

## Solar Reflectance Instrumentation



- Solar Spectrum Reflectometer (Devices & Services Company)
- Quick measurement over overall solar reflectance
- Laboratory instrument sometimes used in field

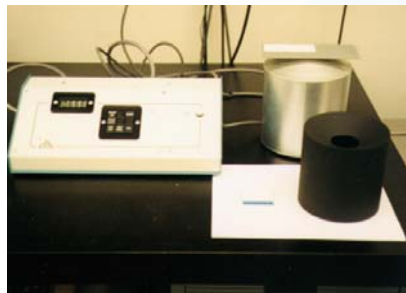

20

## Fourier-Transform Infra-Red (FTIR) Spectral Emittance



- Based on commercial Bruker IFS 28 FTIR spectrometer
- Spectral distribution of emittance (5 to 40 micrometers)
- Set-up unique in U.S.

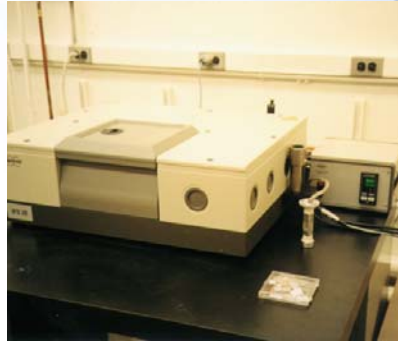

21

## Emittance



- Overall emittance (Devices & Services, Company)
- Compares emittance to high and low standards



22

## 2.4.2 Develop a Computer Program For Optimal Design of Cool Coatings



- Objective: Develop a computer program for optimal design of cool coatings used in colored roofing materials
- Deliverables:
  - Computer Program
- Schedule: 11/1/03 – 12/1/04

23

## Coating Design Software



- Estimate coating reflectance from pigment properties (absorption & scattering), film geometry (mixing & layering)
- Recommend pigments & geometry to match color, maximize solar reflectance

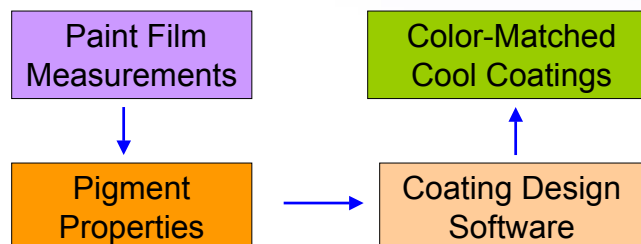

24

## 2.4.3 Develop a Database of Cool-Colored Pigments



- Objective: Develop a database that can be readily used by the industry to obtain characteristic pigment information for the design of cool-colored coatings
- Deliverables:
  - Electronic-format Pigment Database
- Schedule: 6/1/03 – 6/1/05

25

## LBL's Cool Roofing Material Database



Netscape: Cool Roofing Materials Data Base

Go To: <http://EETD.LBL.gov/CoolRoof> What's Related

### Cool Roofing Materials Database



[Lawrence Berkeley National Laboratory](#)  
[Environmental Energy Technologies Division](#)

Energy-efficient roofing systems can reduce roof temperatures significantly during the summer, and thus reduce the energy requirements for air conditioning. The purpose of this Cool Roofing Materials Database is to assist with the selection of roofing materials which reflect, or otherwise reject, the sun's radiant energy, before it penetrates into the interior of the building.

This Database has been prepared by the [Heat Island Project](#) within Berkeley Laboratory's Environmental Energy Technologies Division, under the direction of Paul Berdahl (PHBerdahl@lbl.gov (510) 486-5278). We welcome any [comments](#) you may have; they will help us improve the database.

[Tips on Using this Database](#)

26

## Temperature Rise of Various Roofing Materials in Sunlight

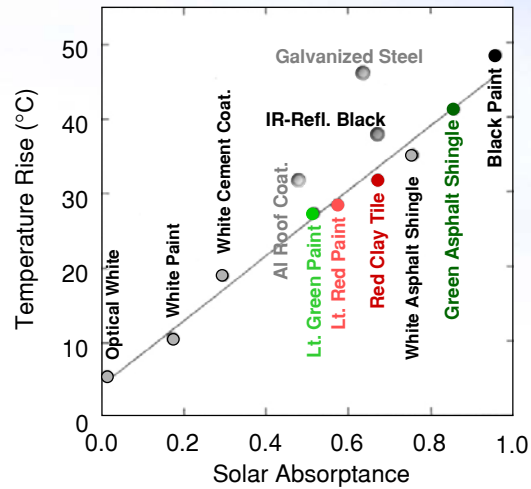

27

## 2.5 Development of Prototype Cool-Colored Roofing Materials

- Objective: Work with manufacturers to design innovative methods for application of cool coatings on roofing materials
- Subtasks:
  - Review of roofing materials manufacturing methods
  - Design innovative engineering methods for application of cool coatings to roofing materials
  - Accelerated weathering testing

28



## 2.5.1 Review of Roofing Materials Manufacturing Methods



- Objective: Compile information on roofing materials manufacturing methods
- Deliverables:
  - Methods of Fabrication and Coloring Report
- Schedule: 6/1/02 – 6/1/03

29

## Focus: Application of Cool Colors to Roofing Products



- Metal roofing
- Clay roof tiles
- Concrete roof tiles
- Wood shakes
- Asphalt shingles (granules)

30

## 2.5.2 Design Innovative Engineering Methods for Application of Cool Coatings To Roofing Materials



- Objective: Work with manufacturers to design innovative methods for application of cool coatings on roofing materials
- Deliverables:
  - Summary Coating Report
  - Prototype Performance Report
- Schedule: 6/1/02 – 12/1/04

31

## ISP/LBNL Shingle With Whiter Roofing Granules



32

# Improvement in Solar Reflectance: LBNL Results

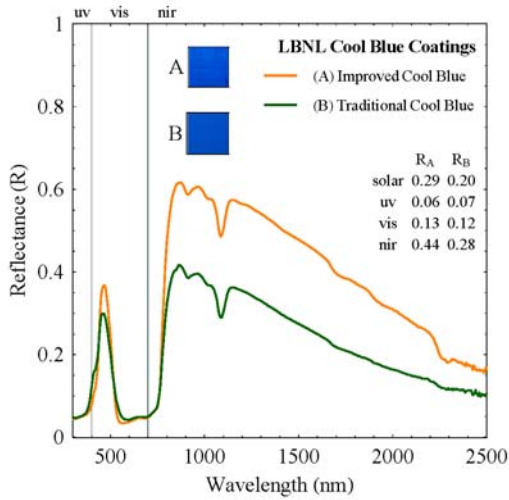

## Near-Infrared Reflectances

- standard blue ~ 0.15
- traditional cool blue = 0.28
- improved cool blue = 0.44

33

# From Cool Pigments to Cool Shingles: a Difficult Problem

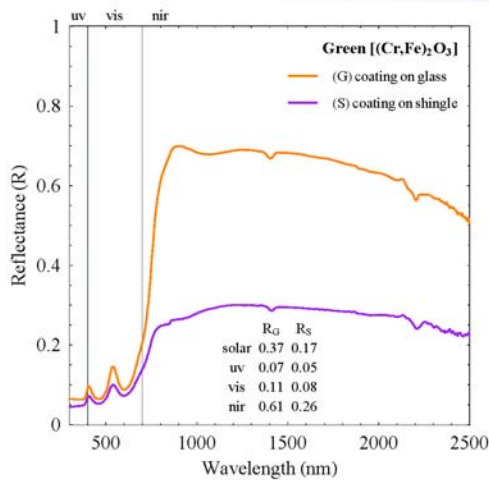

(G) coating on glass

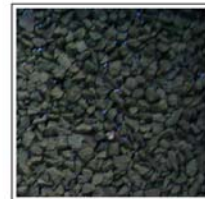

(S) coating on shingle

34

## 2.5.3 Accelerated Weathering Testing



- Objective: Identify latent materials defects early by accelerated weathering tests
- Deliverables:
  - Accelerated Weathering Testing Report
- Schedule: 11/1/02 – 6/1/05

35

## Plans



- High-degree of dynamic interactions with industrial partners
- Accelerated testing via weatherometer (exposure to cycles of light, moisture, and dry heat)
- Check for color-stability and integrity
- Tests are conducted for several prototype roofing materials

36

## Natural Sunlight Exposure



- Preliminary Florida exposure for 1 year
- IRR colors show better fade resistance than painted metal test standards

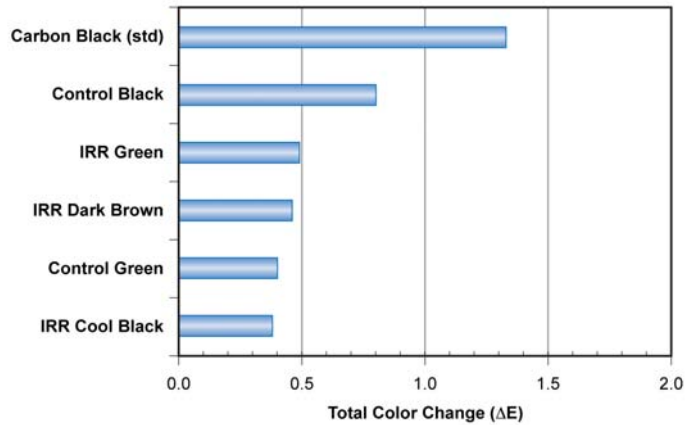

37

## Reduction of Reflectance: Membrane Reflectance Before and After Washing

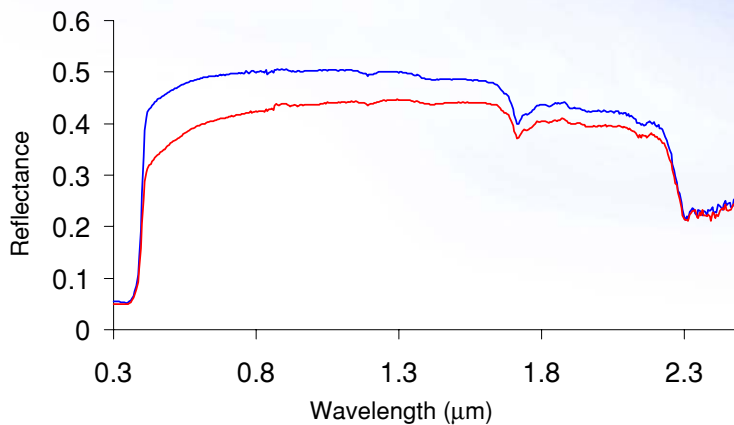

38

## Difference in Spectral Reflectance Before and After Washing

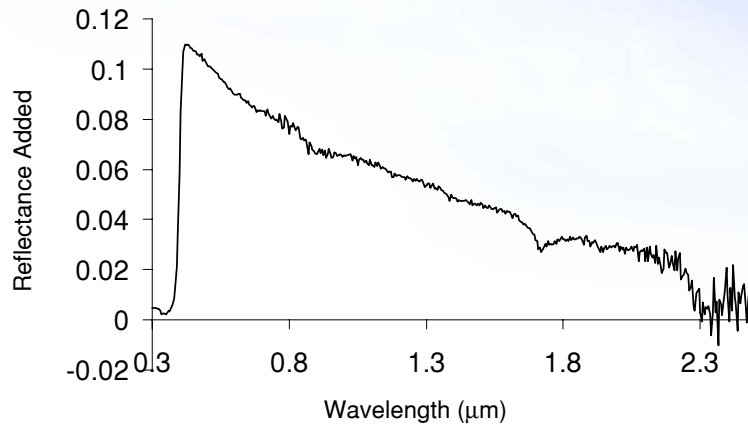

39

## Spectrum of Black Carbon Absorption

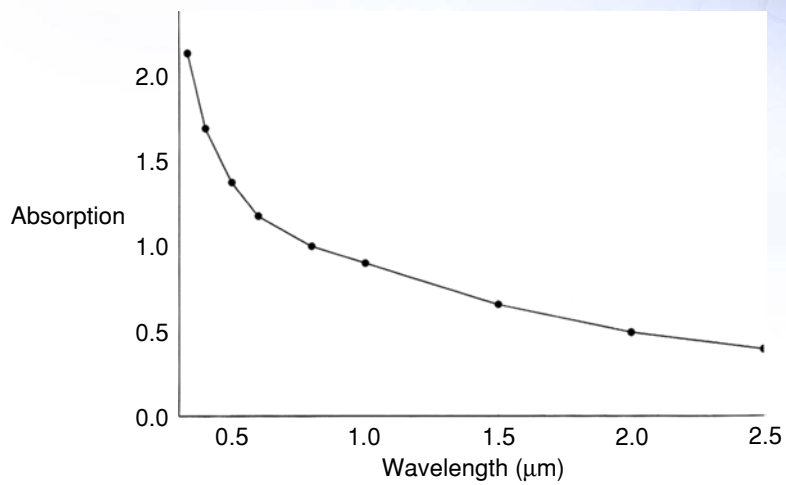

40

## 2.6 Field-testing and Product Useful Life Testing



- Objective: Demonstrate, measure and document the building energy savings, improved durability and sustainability of cool colored roofing materials
- Subtasks:
  - Building energy-use measurements at california demonstration sites
  - Materials testing at weathering farms in california
  - Steep-slope assembly testing at ORNL
  - Product useful life testing

41

## Cool Colored Roofing Materials Study

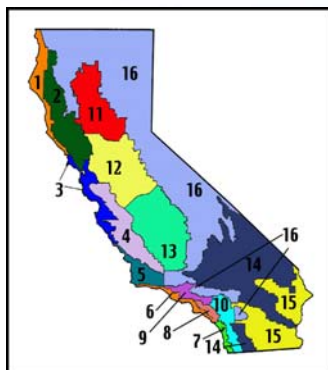

### • Demonstration sites

- Setup and Instrument Eight Test Roofs in Sacramento, California
- Setup and Instrument ESRA Test Stand at BTC
- Field exposure sites in California

42

## 2.6.1 Field-testing and Product Useful Life Testing



- Objective: Setup residential demonstration sites, measure and document the energy savings of cool pigmented roof materials
- Deliverables:
  - Demonstration Site Test Plan
  - Test Site Report
- Schedule: 6/1/02 – 10/1/05

43

## Habitat For Humanity



- Side-by-side performance monitoring of up to eight test homes



44



## AtticSIM (*Attic Simulation*) Model

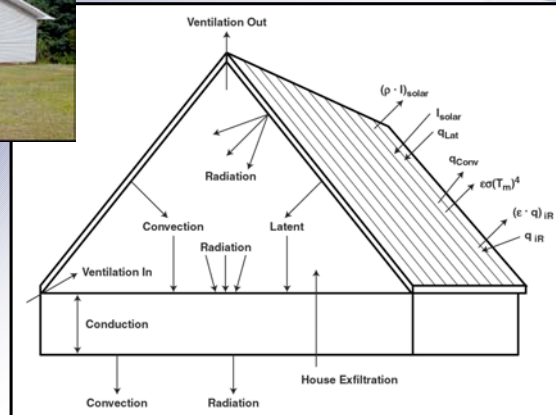

45

## Effect Of Climate



- Exercise models for unoccupied houses with simple operation in various climates
- Use California sizes for air conditioners and electrical resistance heaters

46

## 2.6.2 Materials Testing at Weathering Farms in California



- Objective: Document the change in reflectance and emittance for roof products having cool color pigments
- Deliverables:
  - Weathering Studies Report
- Schedule: 6/1/02 – 10/1/05

47

## Weathering Sites

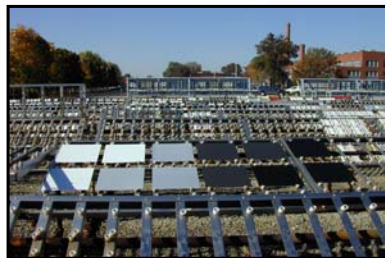

- Monroeville, PA

- Ft. Lauderdale, FL
- Nova Scotia, Canada
- Bethlehem, PA



8

# Biomass As Measured By PLFA



- Community Biomass range  $10^6$  to  $10^8$  cells per  $\text{ft}^2$
- Grassland soils contain significantly more bacteria than fungi

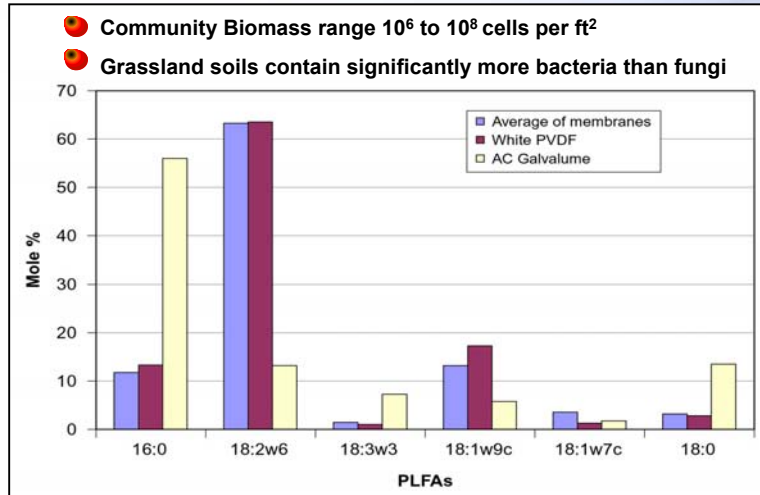

49

# Crustal Elements (DUST) Drive The Drop In Reflectance

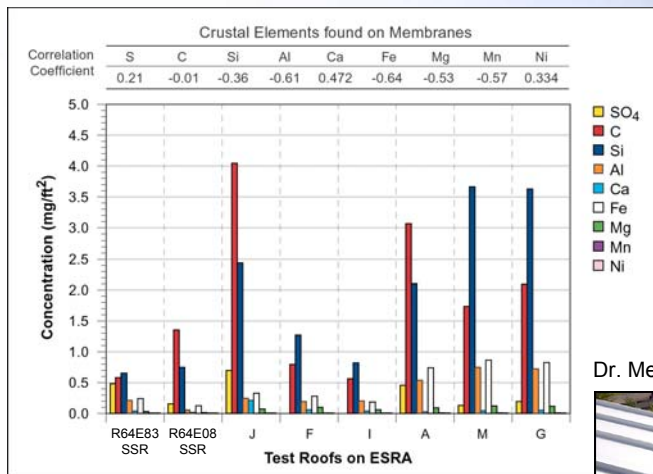

Dr. Meng-Dawn Cheng



50

## White Polyvinylidene Fluoride (PVDF) Has Higher Reflectance After 2 Yrs

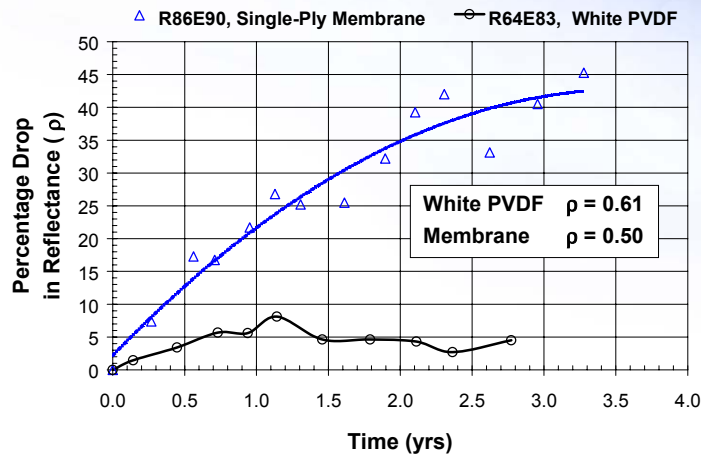

51

## 2.6.3 Steep-slope Assembly Testing at ORNL



- Objective: Select appropriate cool color pigments, apply them to roofing materials and field test the roof products on the Envelope Systems Research Apparatus (ESRA) to document the effect of reflectance and emittance weathering on the thermal performance of the cool pigment roof systems
- Deliverables:
  - Whole-Building Energy Model Validation
  - Presentation at the Pacific Coast Builders Conference
  - Step Slope Assembly Test Report
- Schedule: 6/1/02 – 10/1/05

52

## Our Test Facilities



- Some Sixty Roofs Under Evaluation
- Residential & Commercial Markets
- AISI, MCA, NamZAC, NCCA, MBMA, SPRI and RCMA



53

## Steep-Slope Roof Assembly

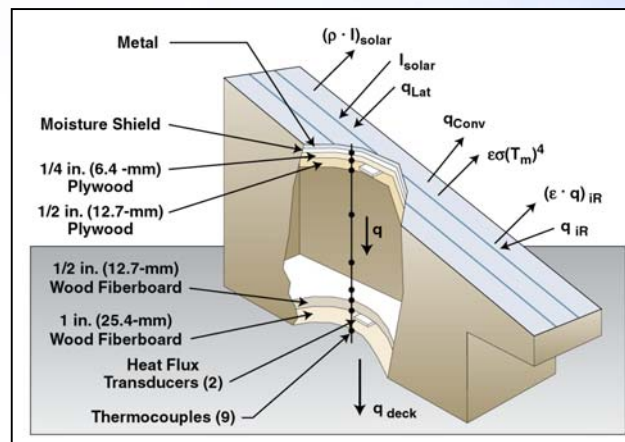

54

## Flurry of Activity to Finish before Hurricane Irene Hit



55

## Key Issue: Venting between Roof Deck and Tile or Metal Roof

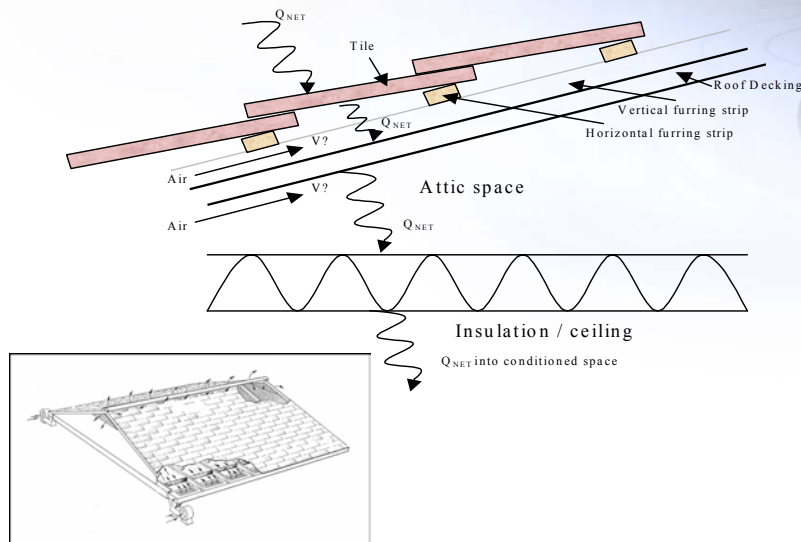

56

## 2.6.4 Product Useful Life Testing



- Objective: Investigate the effect of reflectance on the useful life of roofing products and measure the pertinent mechanical and rheological properties to assess the sustainability of the different roofing products
- Deliverables:
  - Solar Reflectance Test Report
- Schedule: 5/1/04 – 6/1/05

57

## Hypothesis: Cool roofing materials last longer



- Perform accelerated testing of roofing materials of the same color (cool vs. standard)
- Primary focus on shingles and wood shakes
- In collaboration with industry, develop required ASTM standards

58

## 2.7 Technology Transfer and Market Plan



- Objective: Make cool-colored roofing materials a market reality within three to five years
- Subtasks:
  - Technology Transfer
  - Market Plan
  - Title 24 Code Revisions

59

### 2.7.1 Technology Transfer



- Objective: Support the roofing industry by promoting and accelerating the market penetration of cool color pigmented roof products
- Deliverables:
  - Publication of results in industry magazines and refereed journal articles
  - Participation in buildings products exhibition, such as the PCBC
  - Brochure summarizing research results and characterizing the benefits of cool colored roofing materials
- Schedule: 6/1/03 – 6/1/05

60



## Publications



- Miller, W.A., Desjarlais A.O., Loye, K.T. and Blonski, R.P. "Cool Color Roofs with Complex Inorganic Color Pigments." in American Council for an Energy-Efficient Economy, proceedings of 2002 ACEEE Summer Study on Energy Efficiency in Buildings.

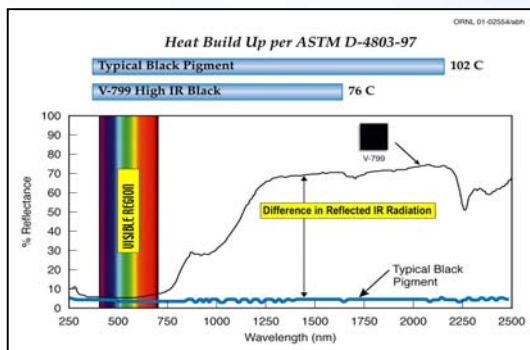

## Brochure



## 2.7.2 Market Plan



- Objective: Develop and initiate actions to facilitate the market adoption of cool-colored roofing products
- Deliverables:
  - Market Plan(s)
- Schedule: 5/1/05 – 6/1/05

63

## 2.7.3 Title 24 Code Revisions



- Objective: Collaborate with Title 24 to revise the code to include cool colored roofs for sloped roof buildings
- Deliverables:
  - Document coordination with Cool Roofs Rating Council in monthly progress reports
  - Title 24 Database
- Schedule: 5/16/02 – 6/1/05

64

## Code Change Proposal for Nonresidential Title 24 Prescriptive Requirements



- Prescriptive Requirements
  - adds requirement for non-residential buildings with low-sloped roofs (initial emittance  $\epsilon \geq 0.75$ , reflectance  $\geq 0.70$ )
- Overall-Envelope and Performance Approach
  - allows compliance credits or penalties
- Changes requirements for cool roofing products
  - qualifies low-emittance products with very high reflectance [initial emittance  $\epsilon < 0.75$ , reflectance  $\geq 0.70 + 0.34 \times (0.75 - \epsilon)$ ]

65

## Total Savings (15-Year NPV of Energy + Equipment Downsizing, \$/1000 ft<sup>2</sup>)

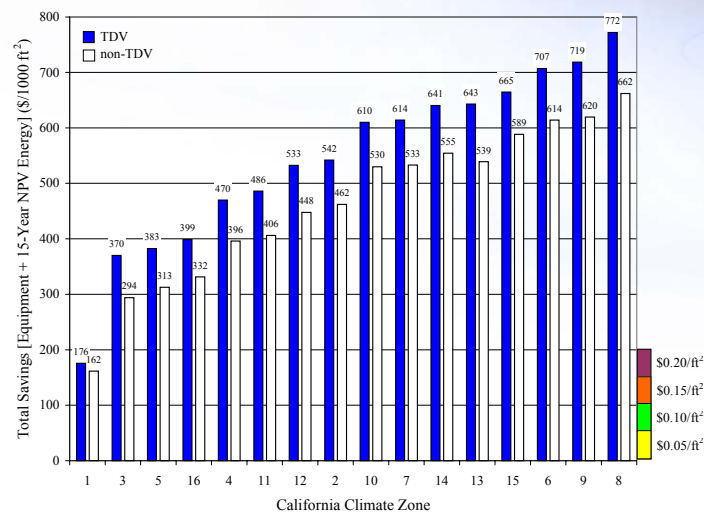

66

## Projected NR New Construction Annual Statewide Savings



- Increase in NR roof area..... **72 Mft<sup>2</sup>**
- Increase in low-sloped NR roof area..... **46 Mft<sup>2</sup>**
- Electricity savings..... **14.8 GWh**
- Natural gas **deficit**..... **199 ktherms**
- Source energy savings..... **132 GBTU**
- Peak power demand savings..... **9.2 MW**
- annual equipment savings..... **\$4.6M**
- TDV NPV energy savings..... **\$22.9M**
- TDV total savings (energy + equip)..... **\$27.5M**
- non-TDV NPV savings..... **\$18.9M**
- non-TDV total savings (energy + equip)... **\$23.5M**

67

## Plans



- Coordinate with the Title 24 staff
- Develop code change proposal(s)

68

## Schedule of PAC meetings



<b>Meeting</b>	<b>Date</b>
1. Project Kick-off Meeting (completed)	May 16, 2002
2. Project Advisory Committee Meeting 1 (PAC1)	September 12, 2002
3. Project Advisory Committee Meeting 2 (PAC2)	March 6, 2003
4. Project Advisory Committee Meeting 3 (PAC3)	September 4, 2003
5. Critical Path Review Meeting 1 (CPR1)	October 3, 2003 (or September 5, 2003)
6. Project Advisory Committee Meeting 4 (PAC4)	March 4, 2004
7. Project Advisory Committee Meeting 5 (PAC5)	September 2, 2004
8. Critical Path Review Meeting 2 (CPR2)	October 7, 2004 (or September 3, 2004)
9. Project Advisory Committee Meeting 6 (PAC6)	March 3, 2005
10. Project Final Meeting	October 6, 2005

69

## Cool Colors Project Website



- Project information (including copies of this presentation) will be available online next week at

<http://CoolColors.LBL.gov>

70