

My title is: "The Chandra X-Ray Observatory"

My Abstract is: The Chandra X-Ray Observatory, the X-Ray component of NASA's Great Observatory Program has been an outstanding scientific and technical success. Designed for a three year lifespan, Chandra is now beginning its 8-th year of scientific operation. Some of the history of the Project, including a discussion of the design, development, and calibration of the X-Ray optics will be presented. Of course the highlights of several of the myriad discoveries will be shown concerning topics ranging from solar system objects to dark matter studies in clusters of galaxies.

The Chandra X-Ray Observatory

An Overview of its Success

November 14, 2007
Martin C Weisskopf



The Great Observatories

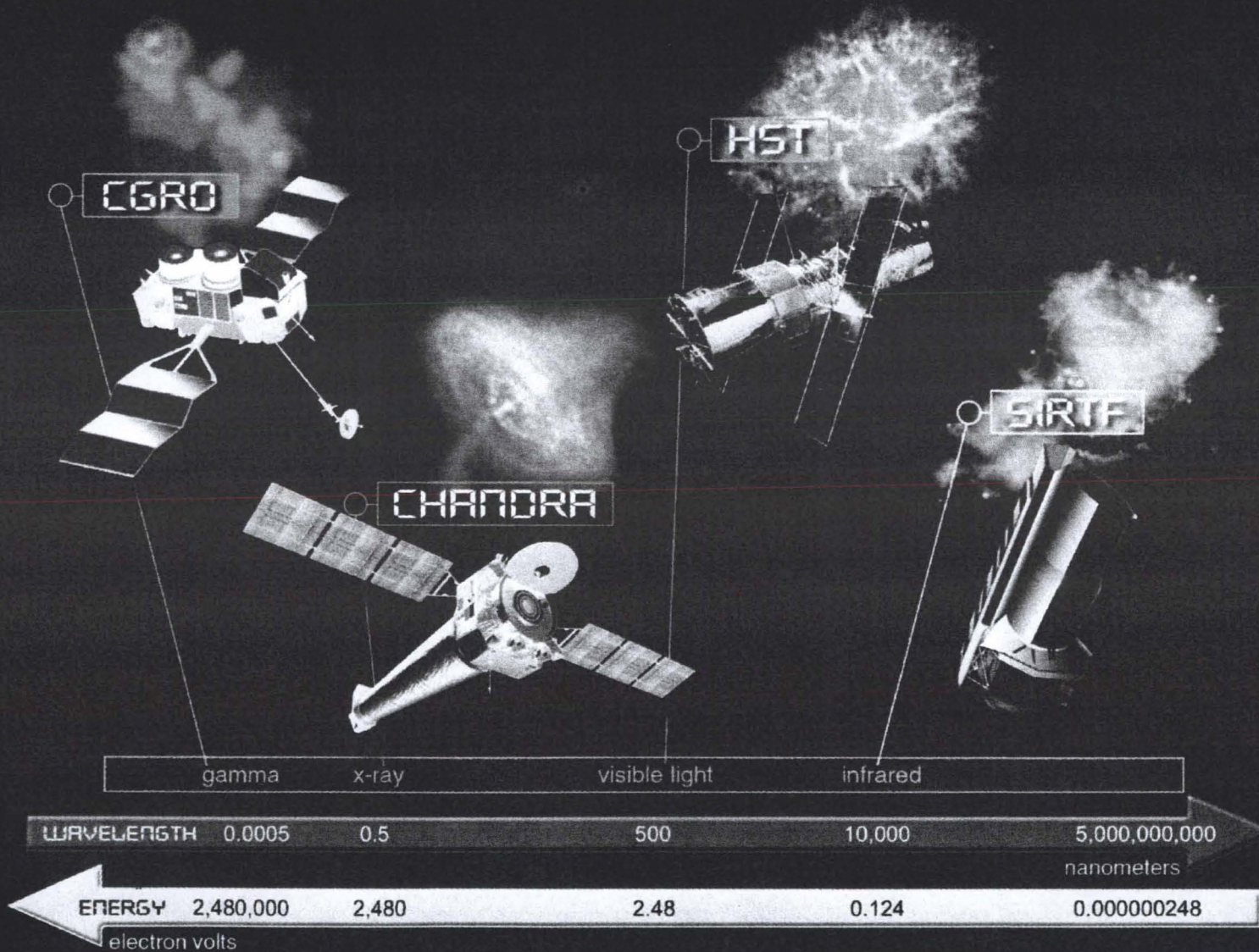



Chandra History Overview

- 1976: Program start
 - MSFC/SAO Collaboration selected by HASA HQ
- 1985: Instrument selection
- 1988: New Start

- 1999: Launch

Crab Nebula



Recipe for Success

- Team effort
- Science-driven requirements
 - Project Science Team
- Stability of requirements
- Technology programs
- Calibration program

Project Science

- More than a single person

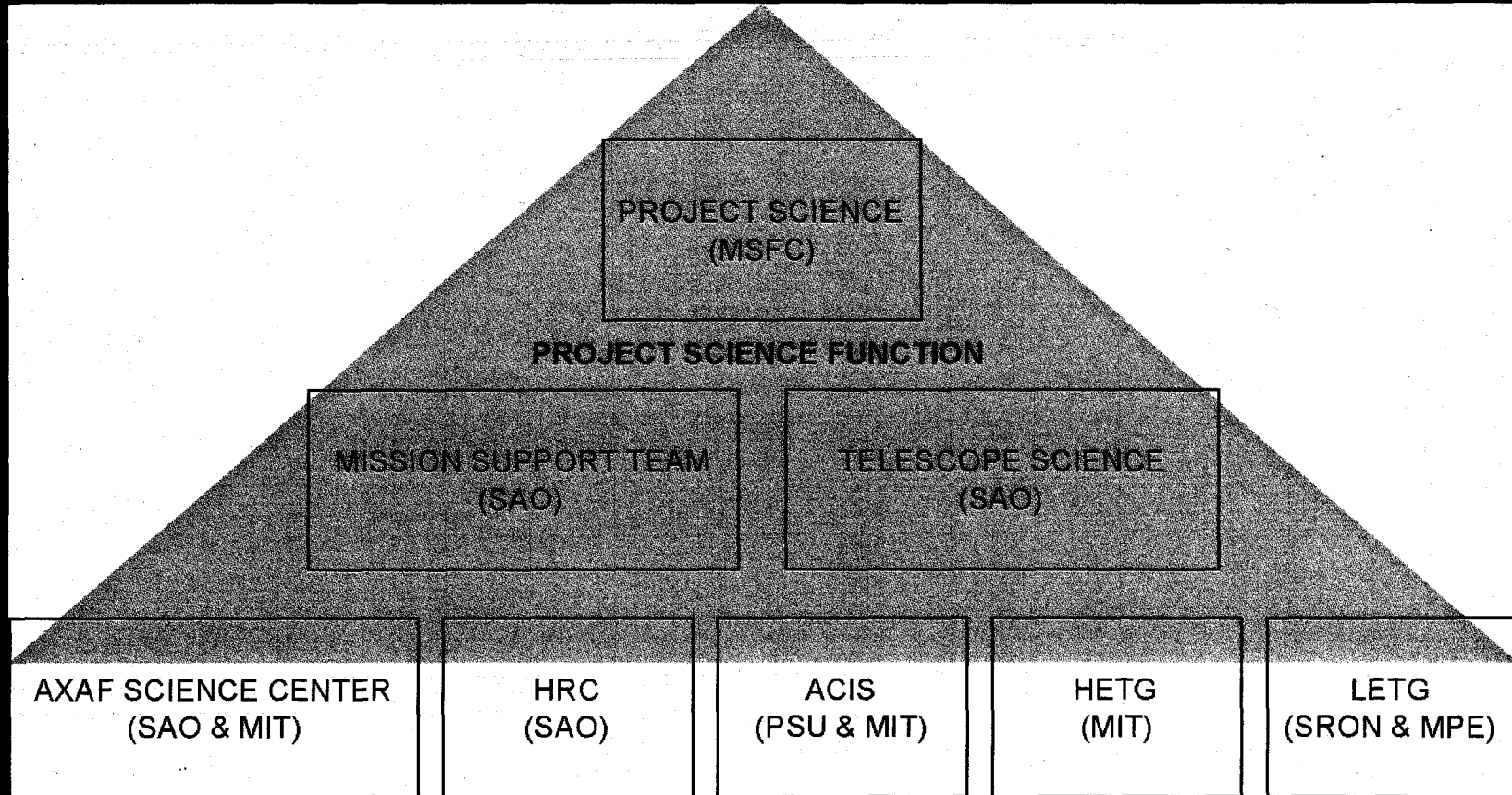

- On all review boards --- to level 3

The Observatory

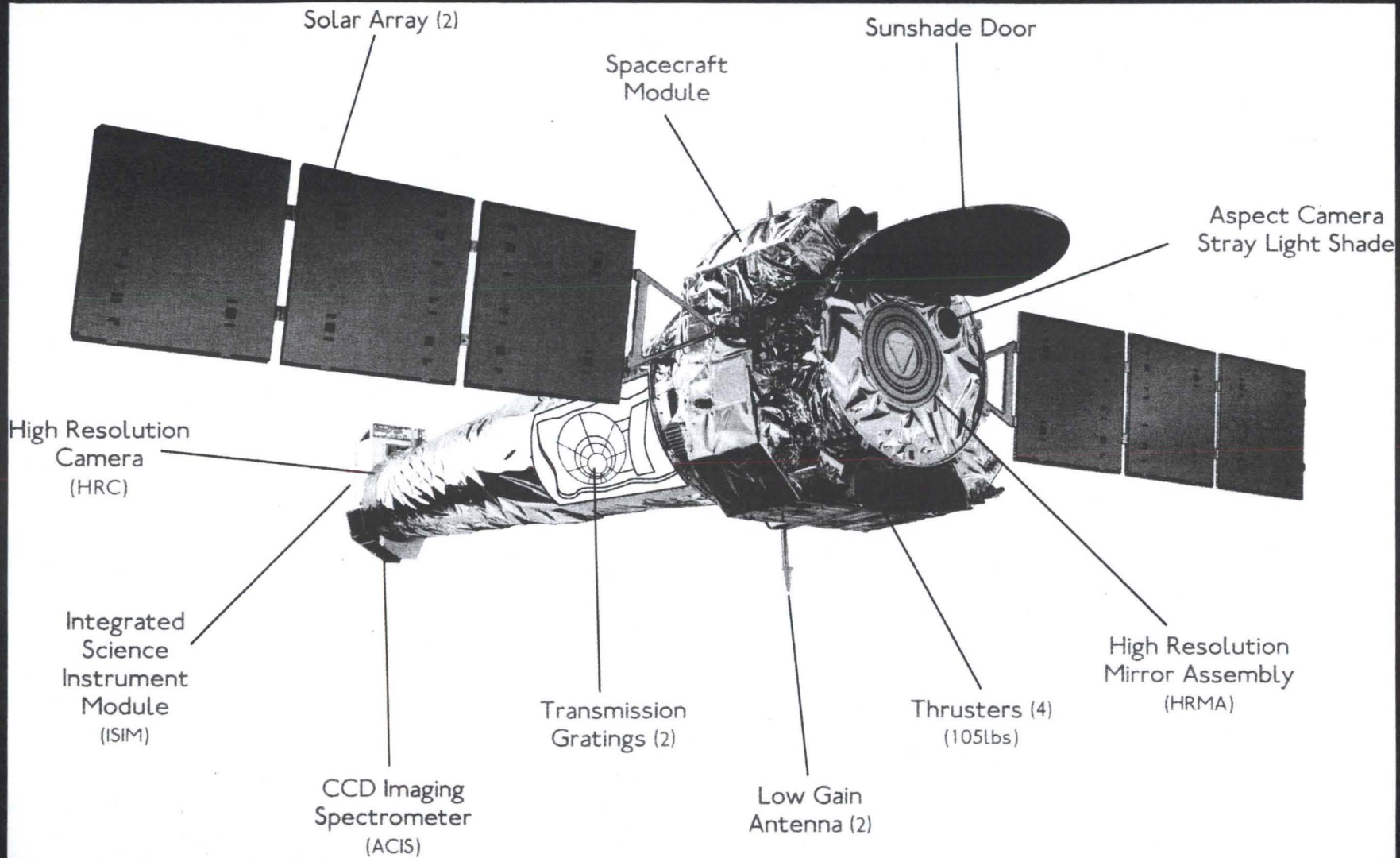



Project Sciences

- More than a single person
- On all review boards to level 3

Chandra Optics

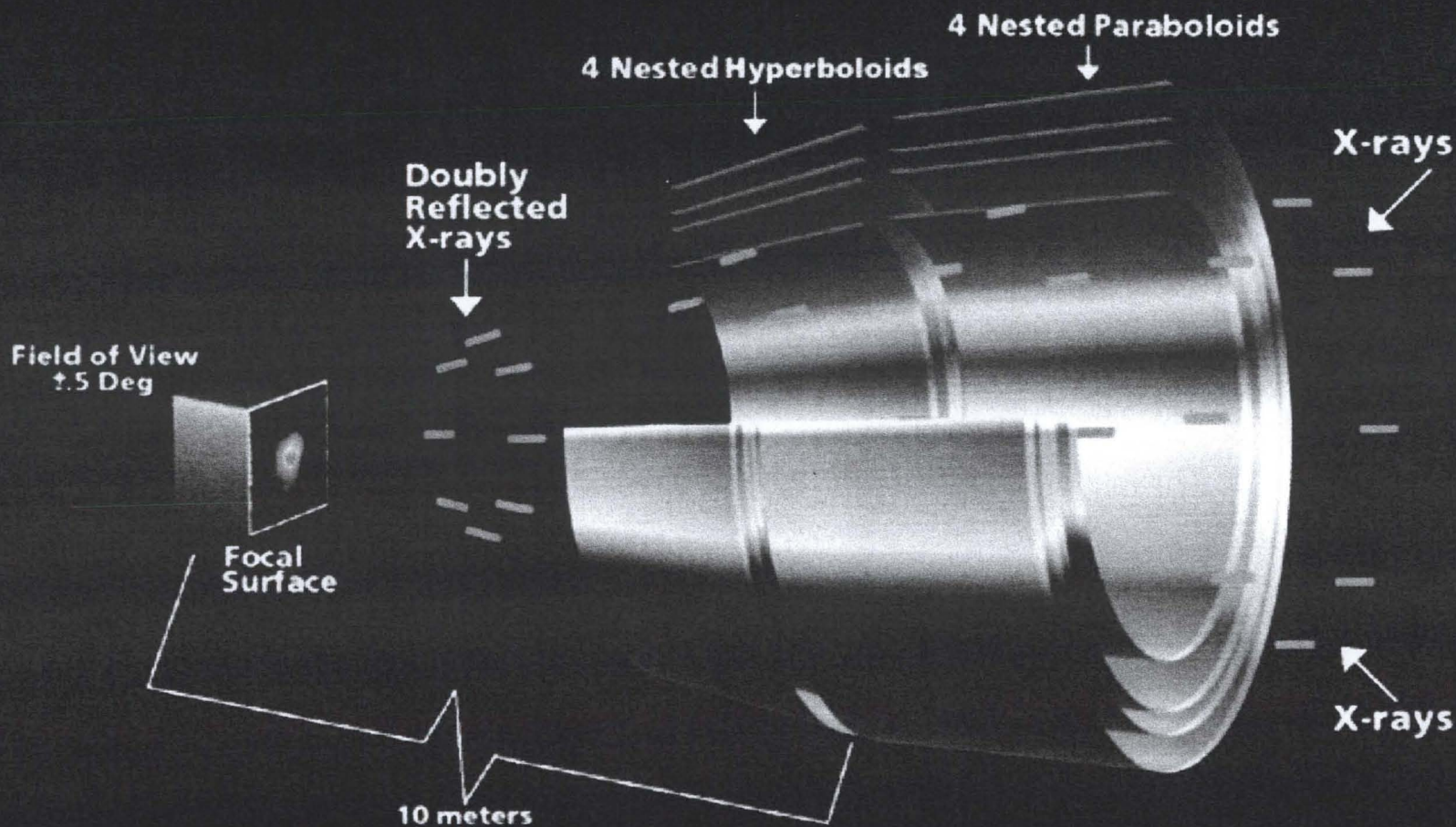

Mirror elements are 0.8 m long and from 0.6 m to 1.2 m diameter

The Beginning - 1976

- 1976 – Proposal was submitted – This was the “formal” beginning

PROPOSAL TO
NATIONAL AERONAUTICS AND SPACE ADMINISTRATION
FOR THE
STUDY OF THE 1.2 METER X-RAY TELESCOPE
NATIONAL SPACE OBSERVATORY
(Volume I - Technical Proposal)

P805-4-76

For the period 1 July 1976 to 30 September 1978

Principal Investigator

Dr. Riccardo Giacconi
Associate Director for
High-Energy Astrophysics Division

Co-Principal Investigator

Dr. Harvey Tansbaum

Co-Investigators

Dr. P. Gorinstein
Dr. R. Harnden
Dr. P. Henry
Dr. E. Kellogg
Dr. S. Murray
Dr. H. Schnopper
Dr. L. VanSpeybroeck

April 1976

Smithsonian Institution
Astrophysical Observatory
Cambridge, Massachusetts 02138

Director: Dr. George B. Field

Assistant Director: Mr. John G. Gregory

The Smithsonian Astrophysical Observatory
and the Harvard College Observatory
are members of the
Center for Astrophysics

The Real Beginning - 1963

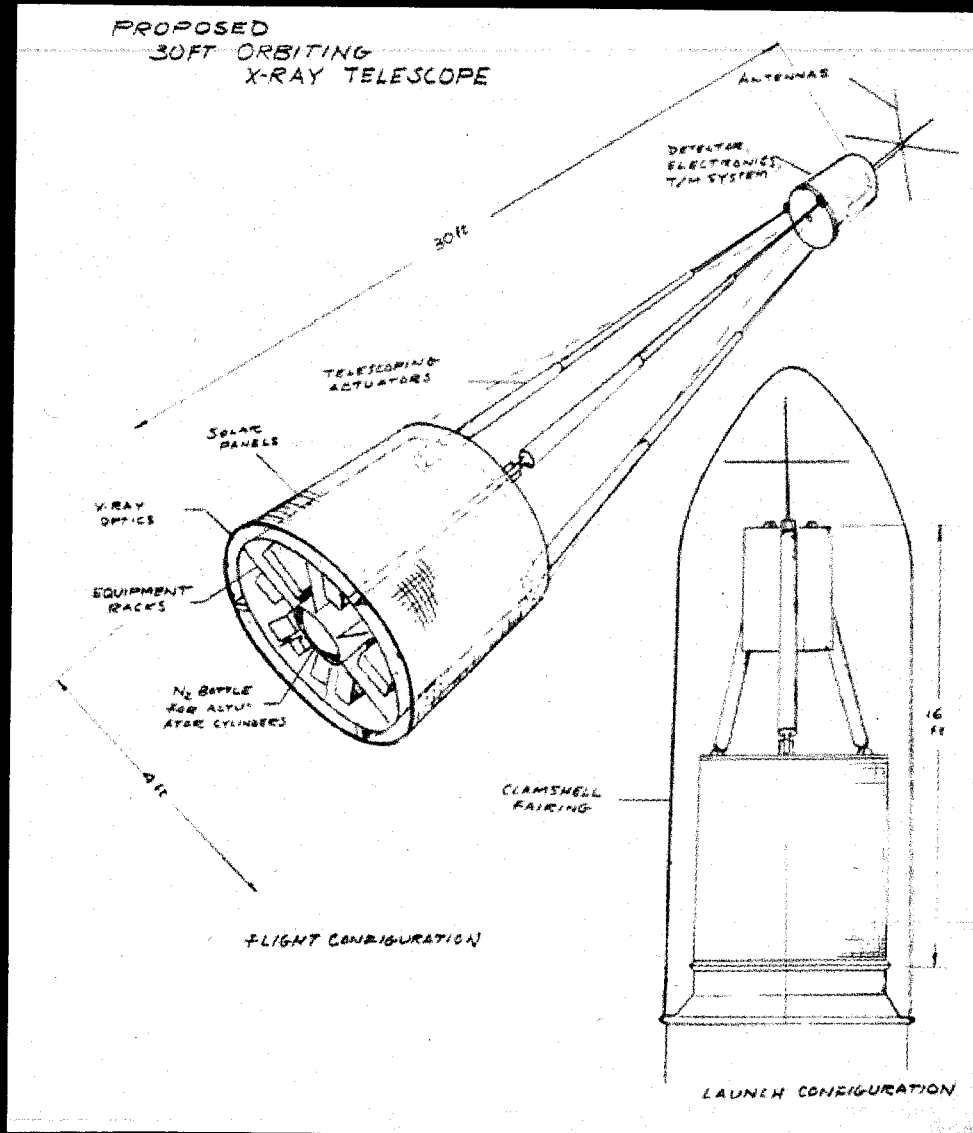

A Proposal for

AN EXPERIMENTAL PROGRAM OF EXTRA-SOLAR X-RAY ASTRONOMY

Prepared for
National Aeronautics and Space Administration
Washington 25, D. C.

Prepared by
American Science and Engineering, Inc.
11 Carleton Street
Cambridge 42, Massachusetts

25 September 1963

Approved:

This document consists of 75 pages.
Copy No. 4 of 1 Series 77

Riccardo Giacconi
Riccardo Giacconi
Vice President
Space Research and Systems Division

ASE Log No. 85-104-6

Smithsonian Institution Archives

X-Ray Astronomy

- Solar Studies in late 40's
 - Solar corona produces X-Rays
- Discovery of first extra-solar source in 1962
 - Also discovery of faint glow - the “diffuse” background

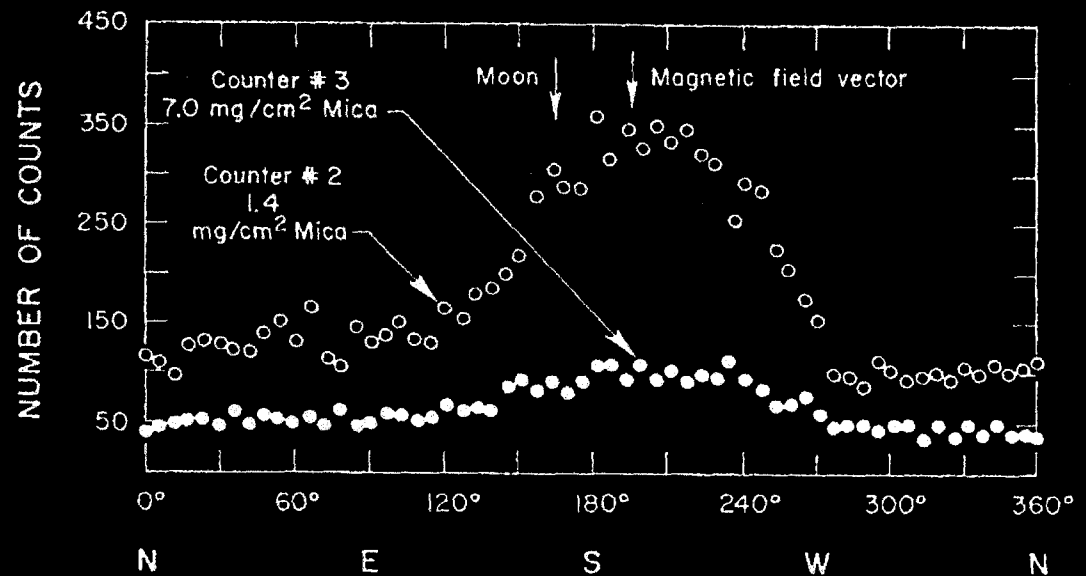

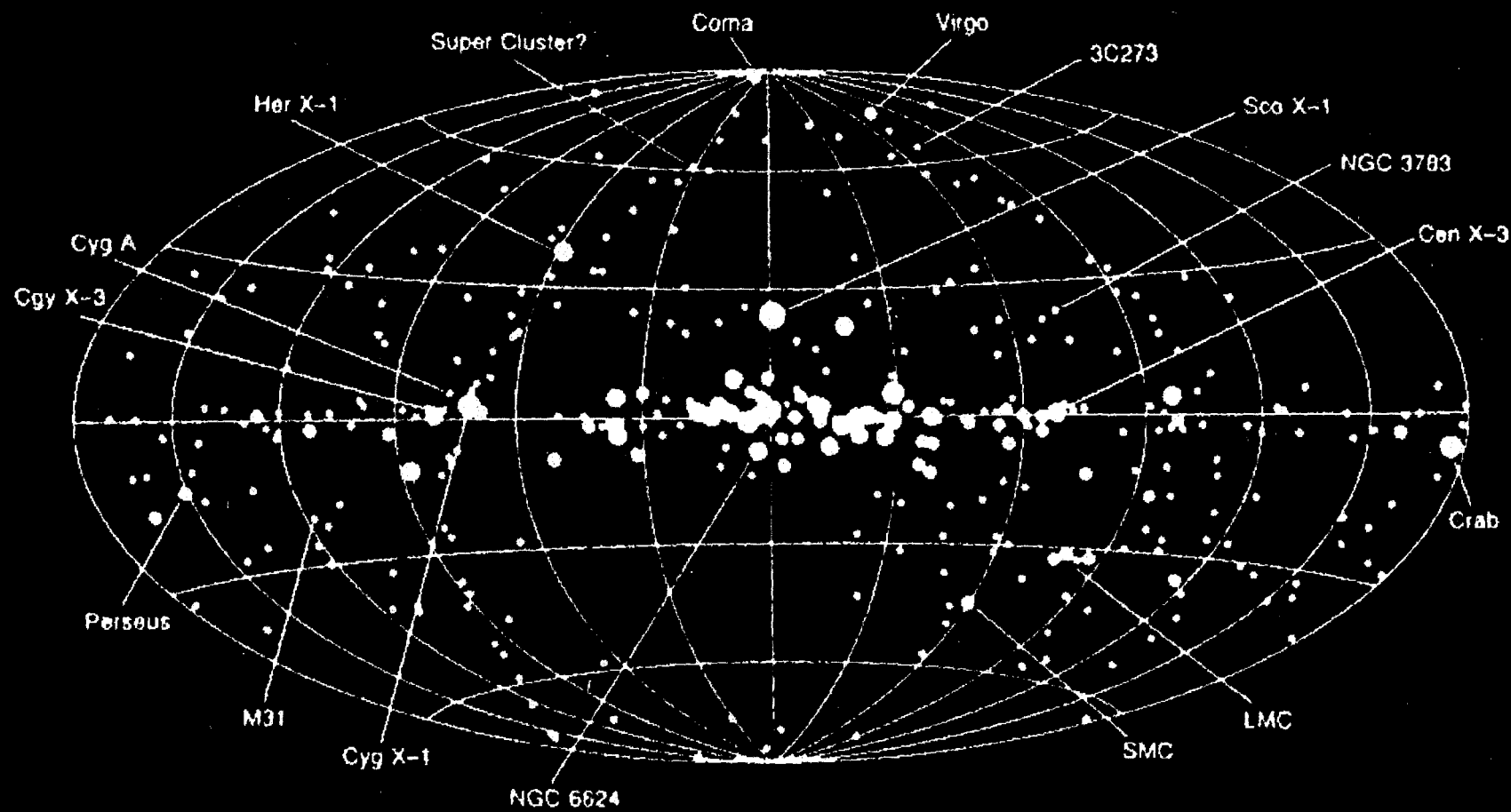

**Uhuru (SAS-1) Conducted the First
All Sky Survey of Cosmic X-Rays in 1971**

X-Ray Astronomy

- We now know that most of the matter that we “see” is visible to us from its X-Ray emission
- The bulk of this matter is hot, X-Ray-emitting, gas in the great galaxy clusters

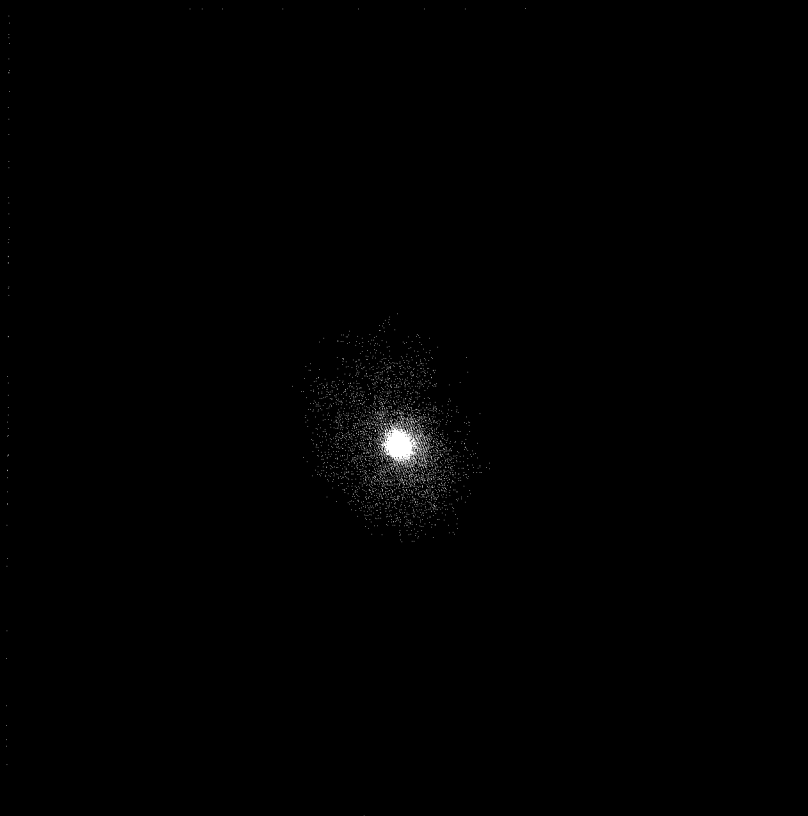

CHANDRA X-RAY



DSS OPTICAL

The Third Decadal Survey - 1981

Major New Programs:

#1: An Advanced X-
Ray Astrophysics
Facility (AXAF)

Astronomy
and Astrophysics
for the 1980's

VOLUME 1:
Report of the
Astronomy Survey
Committee





The Technology Mirror Assembly

- Single mirror pair
- Scaled (2/3) Version of innermost mirrors
- 6-m focal length
 - Allowed for testing in existing test facility
- 0.41-m element length
- 0.42-m diameter
- Gold coated (baseline at the time)

The Technology Mirror Assembly

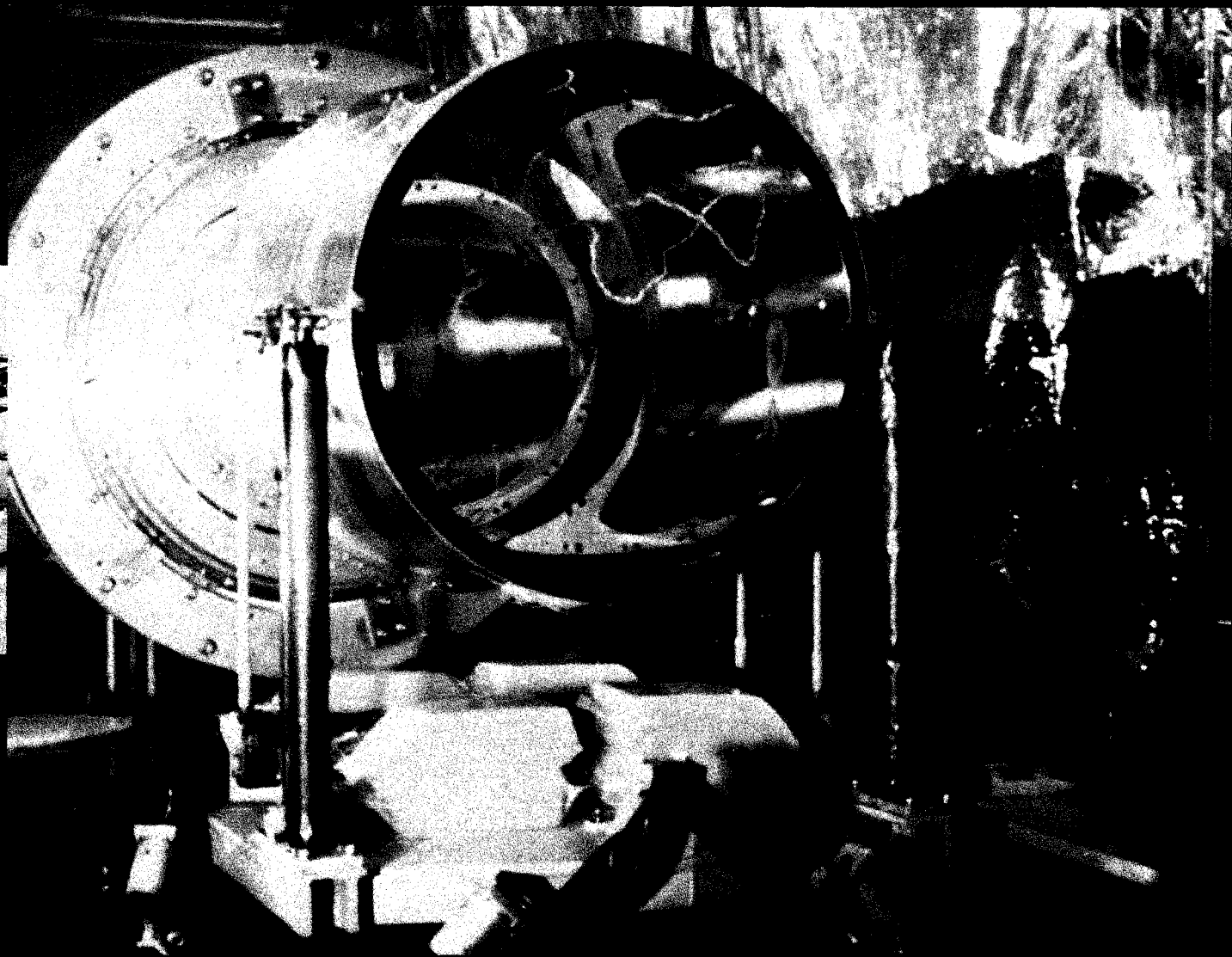
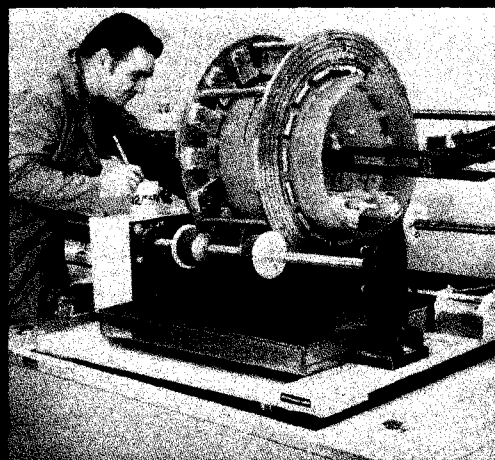

The Technology Mirror Assembly

- First delivery July 1985
 - Resolution better than 0.5"
 - However, near angle scattering
- Second delivery Jan 1989
- Final results were great
 - E.g. FWHM from 0.36" – 0.68"
 - Encircled energy as predicted

Flight Mirror Blanks

- Initiated purchase in 1987



Other Milestones

- Prime contractor selection – 1988
- “New Start” - 1988
- Selection of the Science Center – 1991
- Started the “VETA” program - 1988
– Verification Engineering Test Article

VETA

- P1/H1 – uncoated and uncut

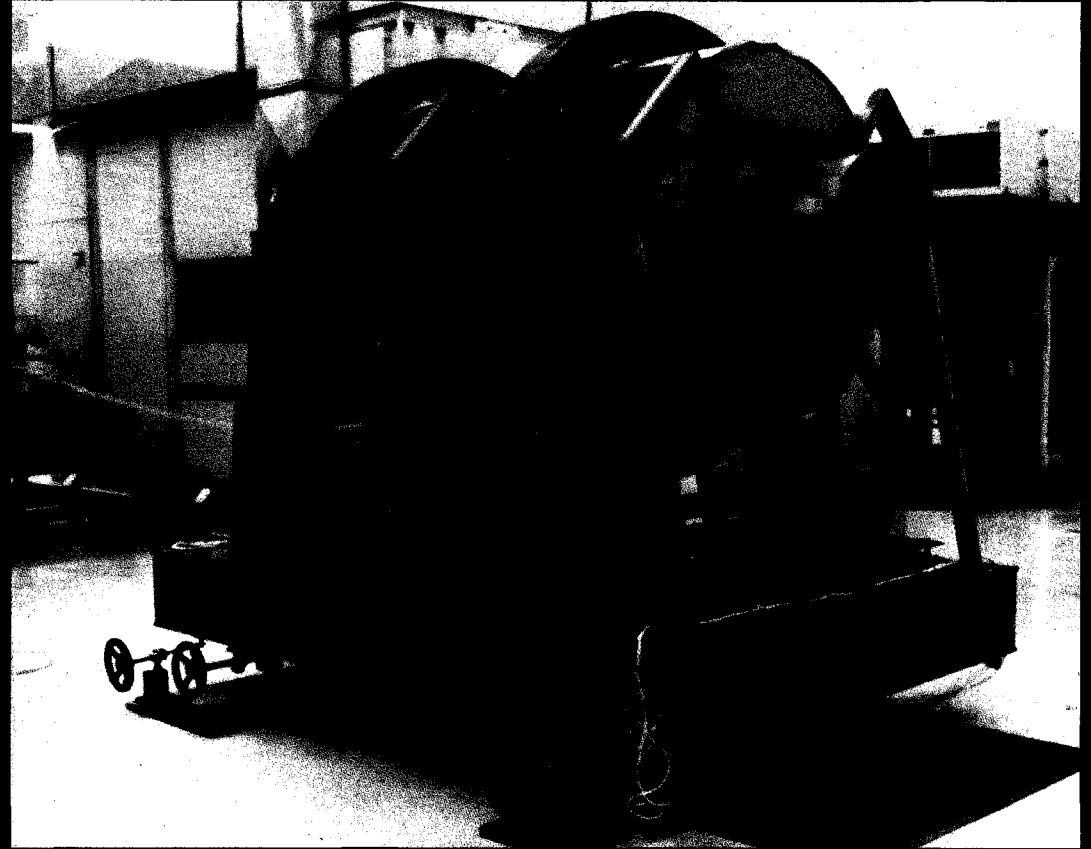
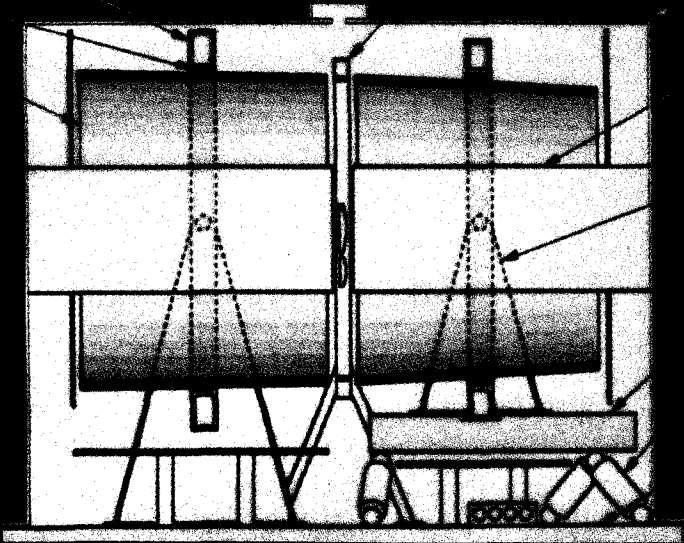

- Needed test facility at least one year earlier than planned!

The X-Ray Calibration Facility (XRCF)

X-RAY CALIBRATION FACILITY

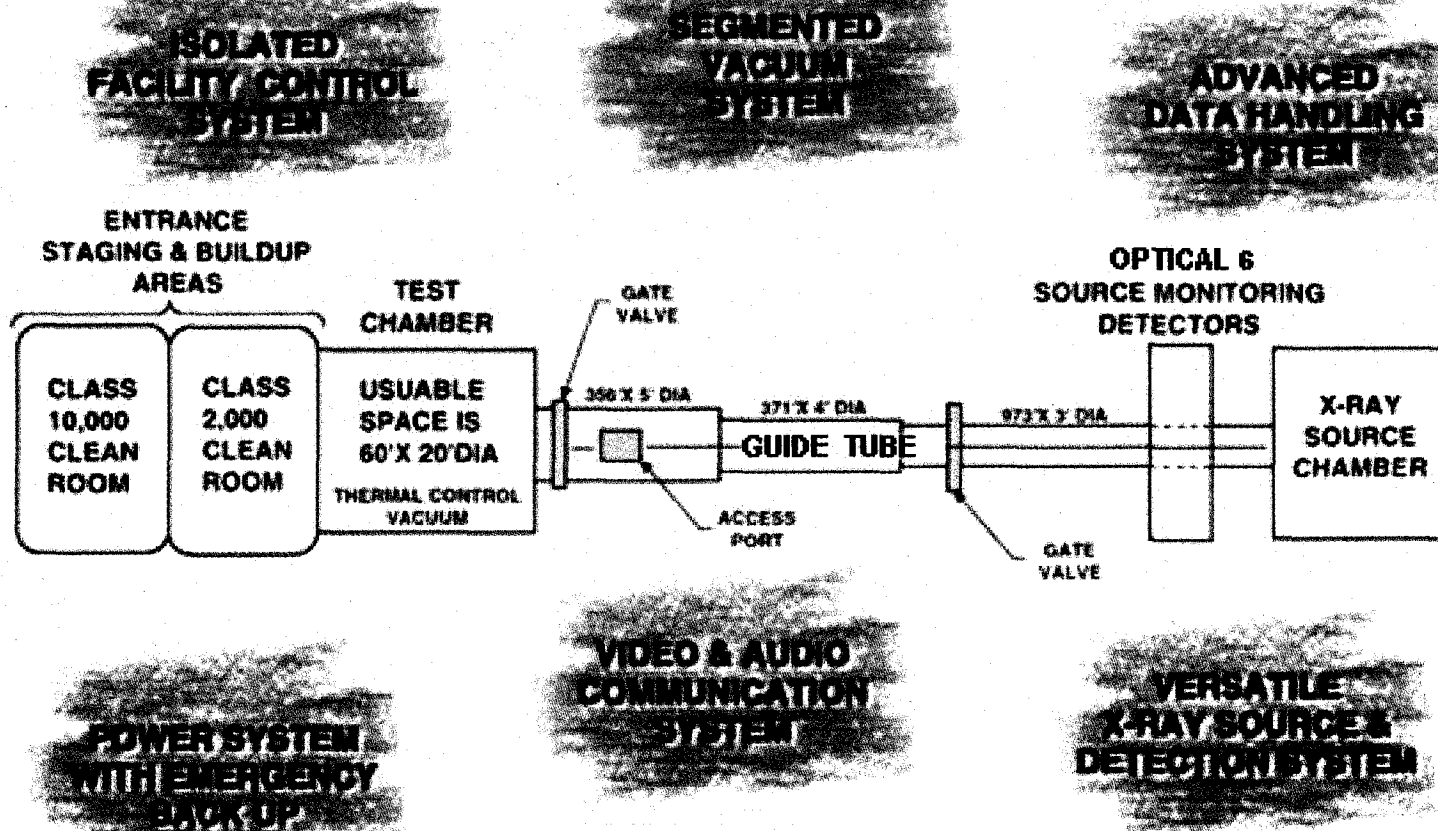

The X-Ray Calibration Facility (XRCF)

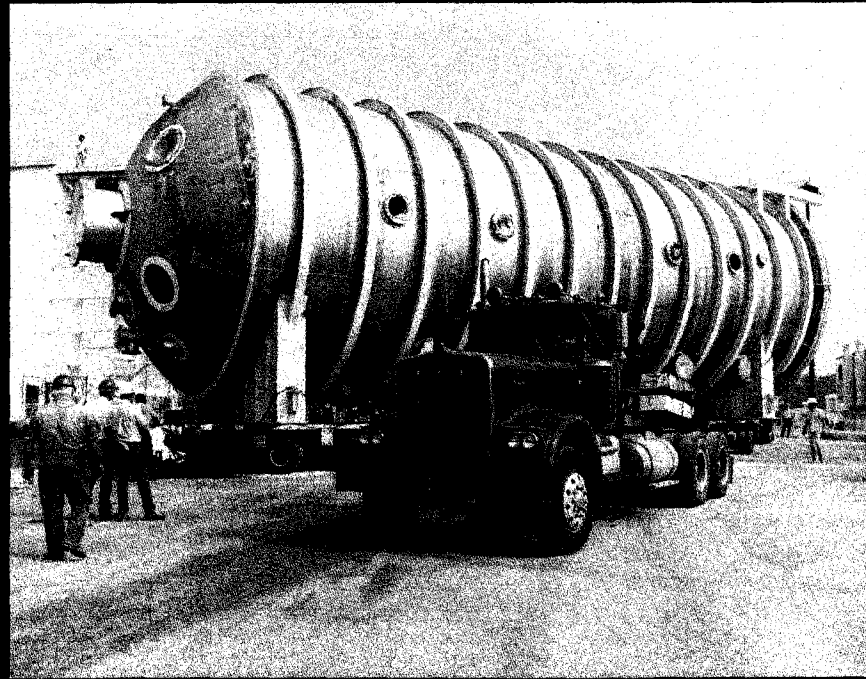

The X-Ray Calibration Facility (XRCF)

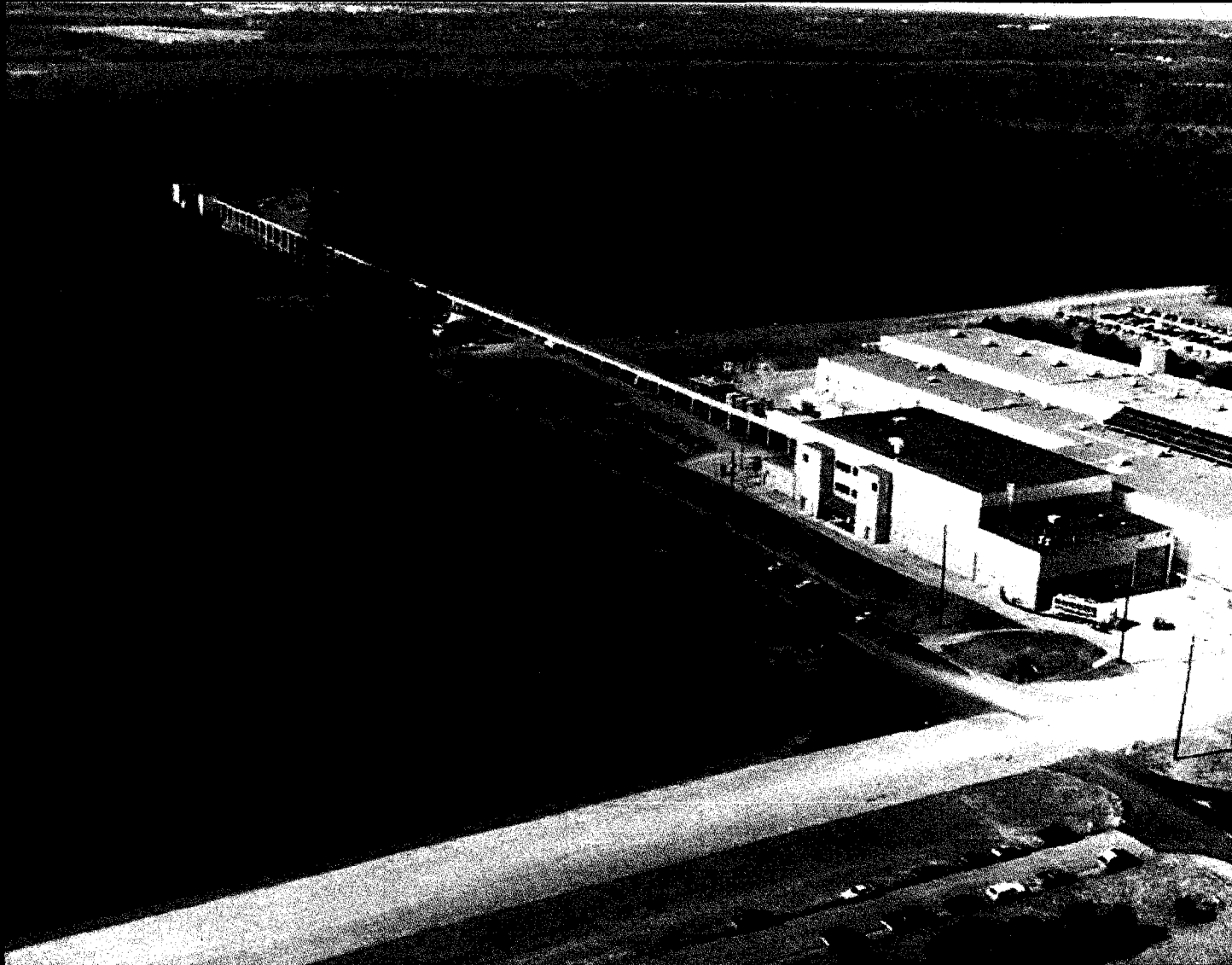

The Veta Tests - 1991

Estimated Mirror Performance on Orbit

Facility Effects Removed Using Lucy Deconvolution of 19 x 19 Scan

Energy: 1.49 keV

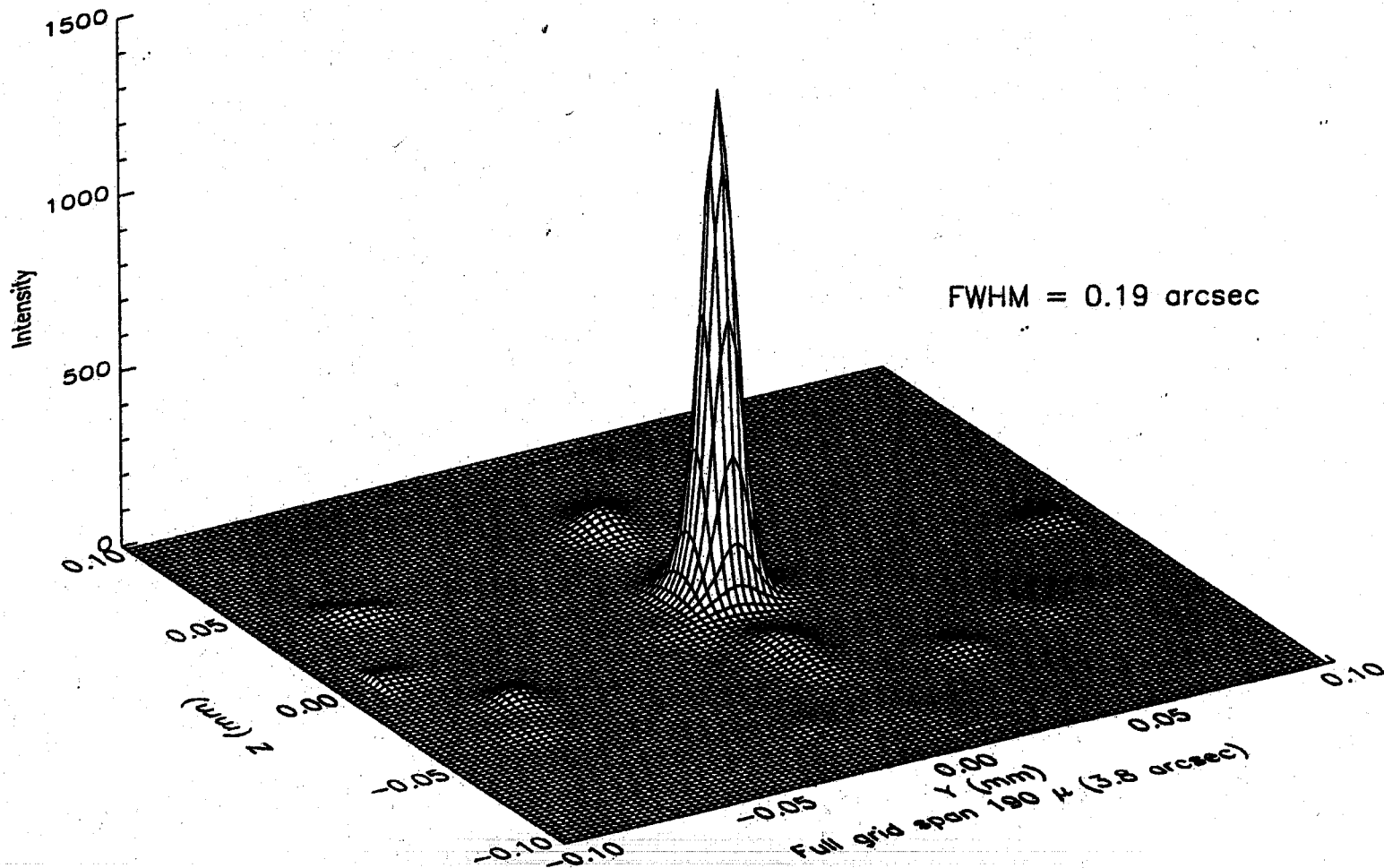

Telescope

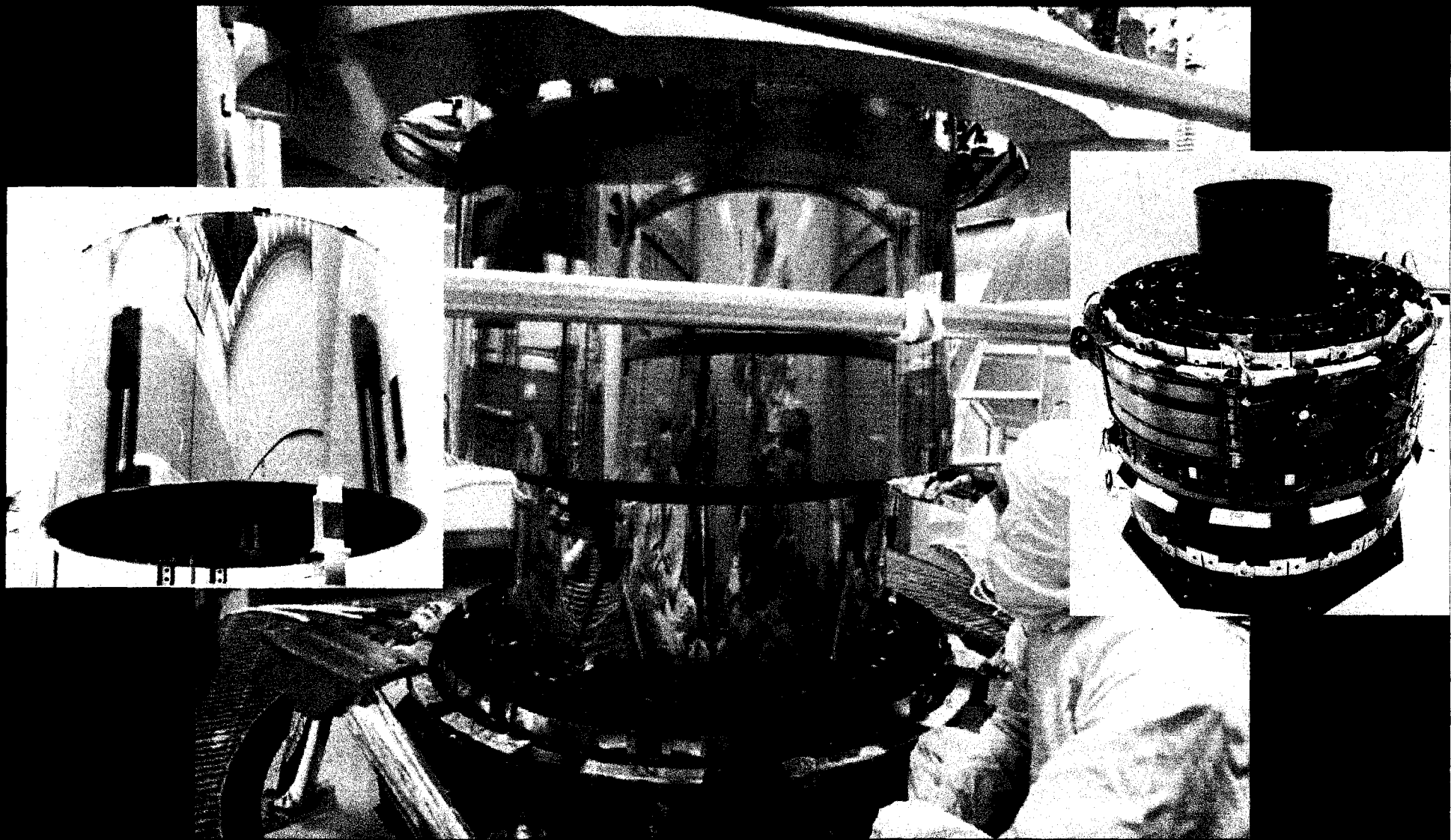

Calibration Program

- 6 months at the X-Ray Test Facility

X-ray Calibration (1996-1997)

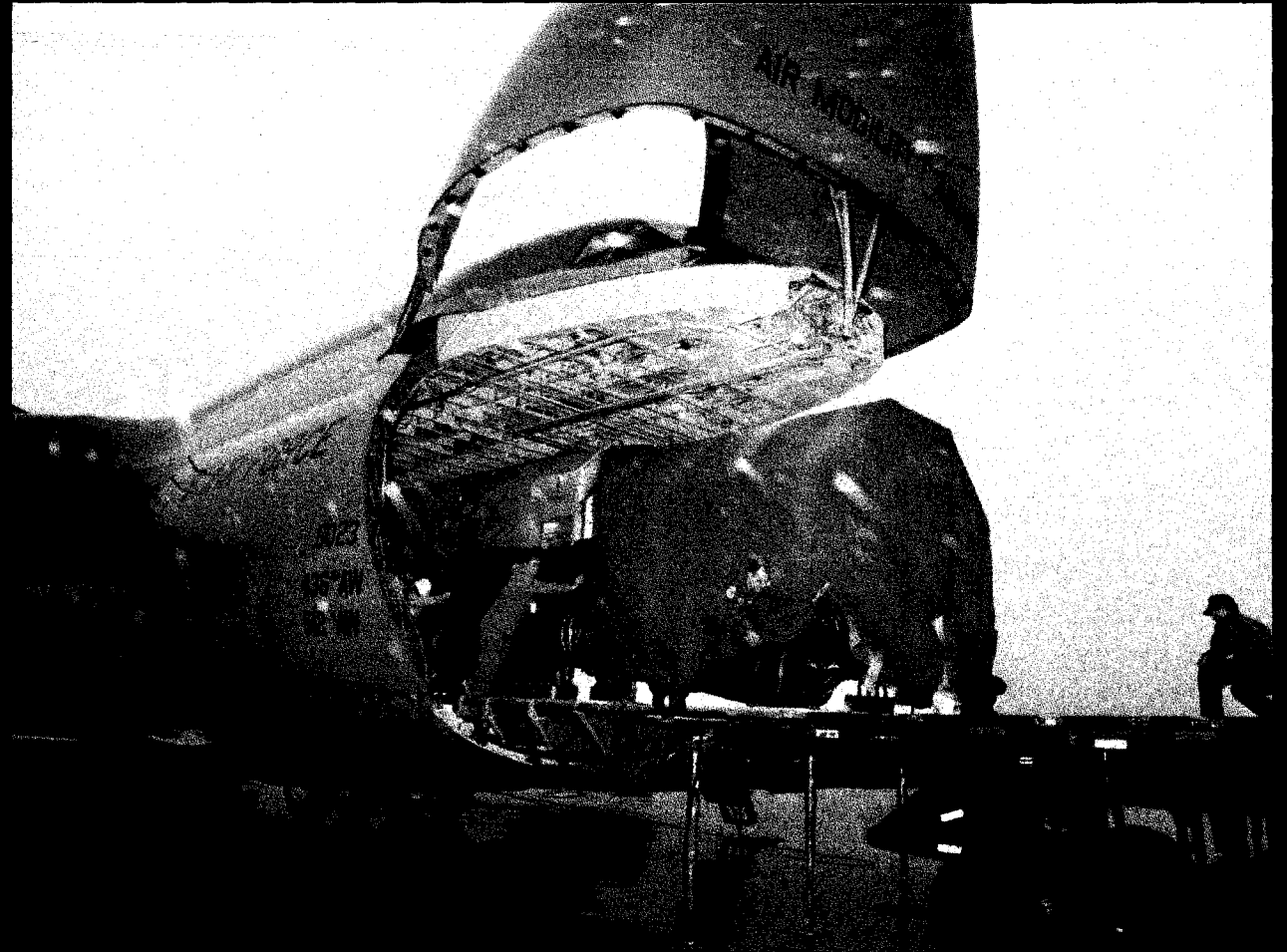



Three Launch Attempts

- Mon/Tue July 19/20
 - Sensor spike hydrogen in the engine compartment
- Wed/Thurs July 21/22
 - Lightning in the vicinity
- Thurs/Fri July 22/23
 - Third time is a charm

Launch at last! July 23 1999 @ 12:31 a.m.

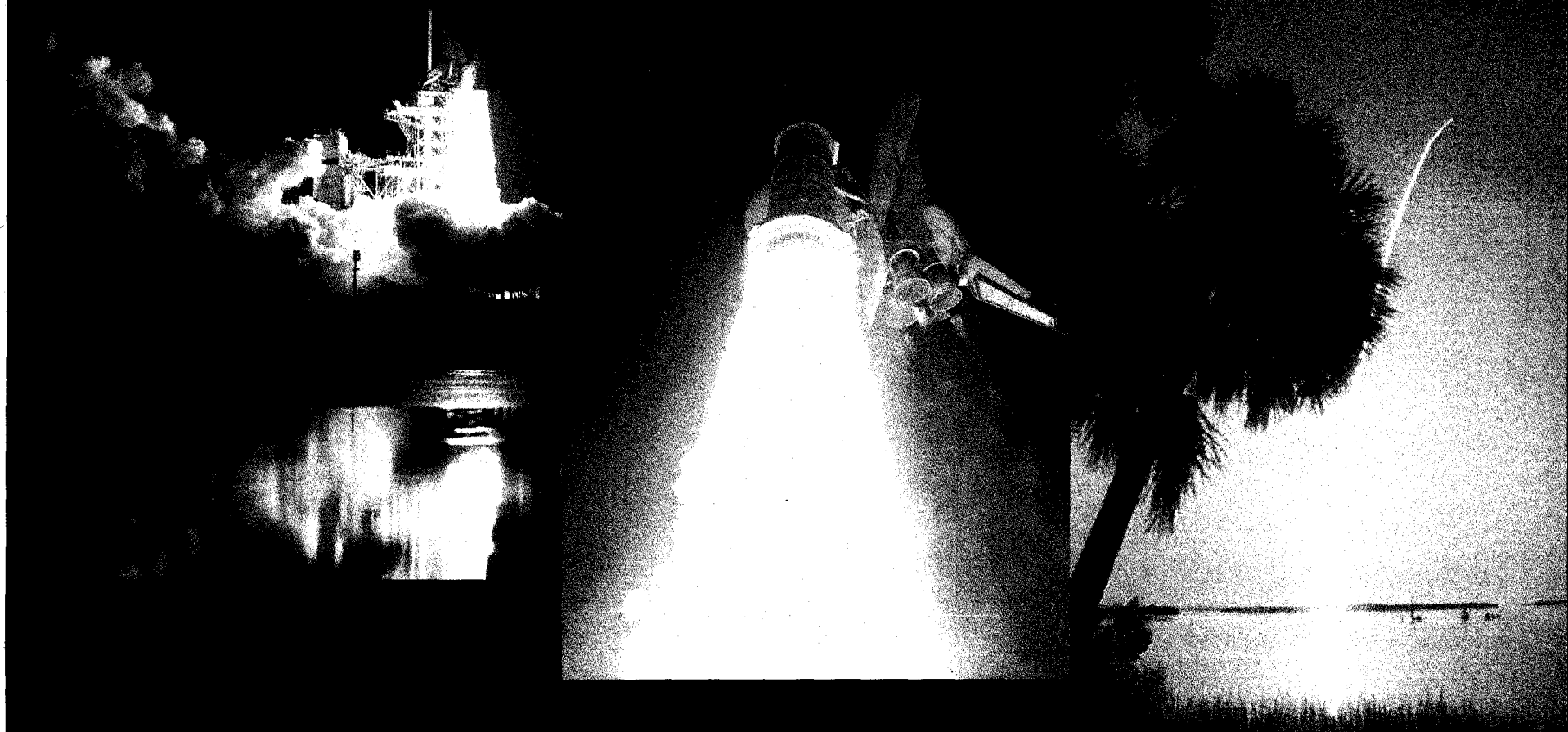

The Orbit

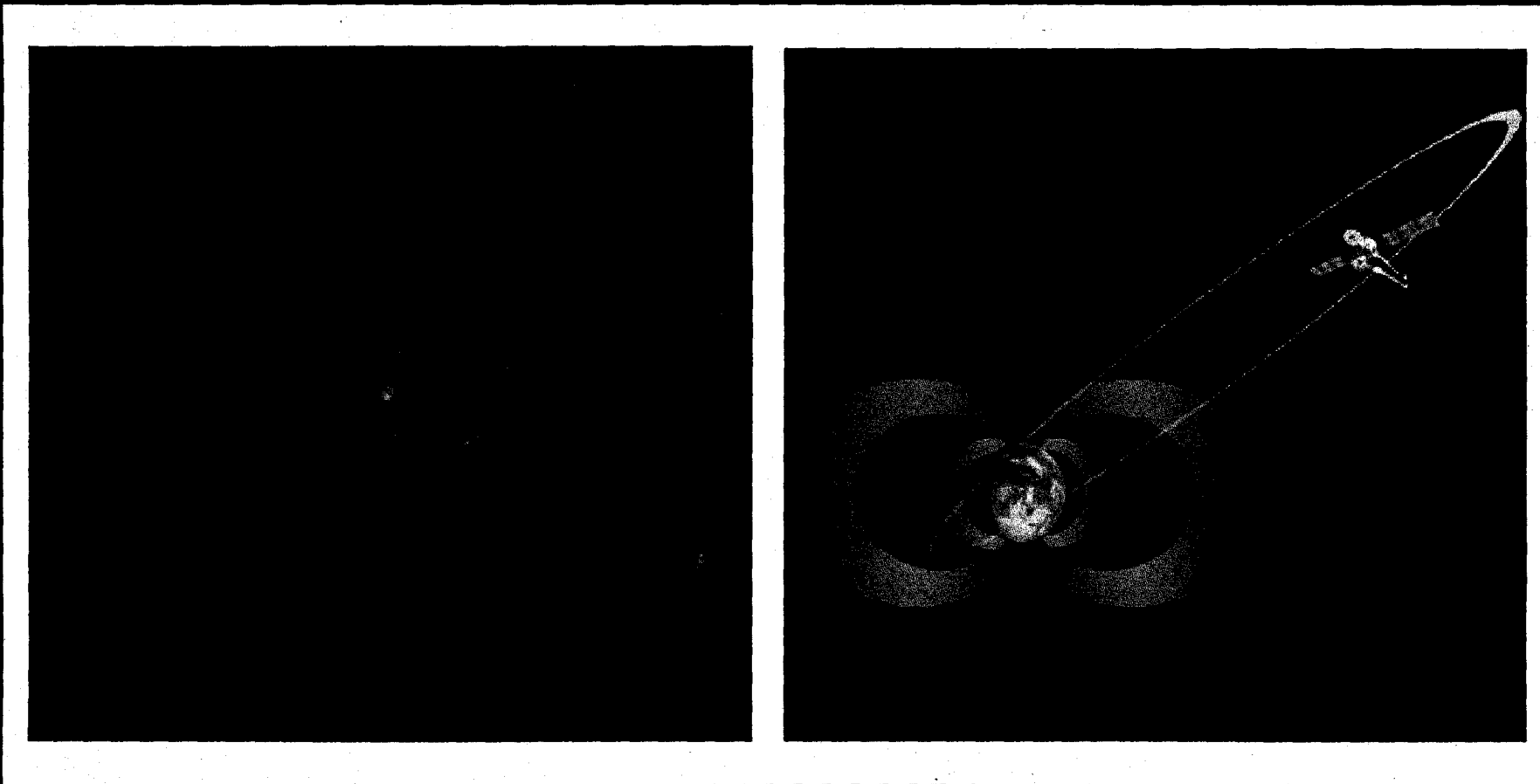

First Light – Cas A

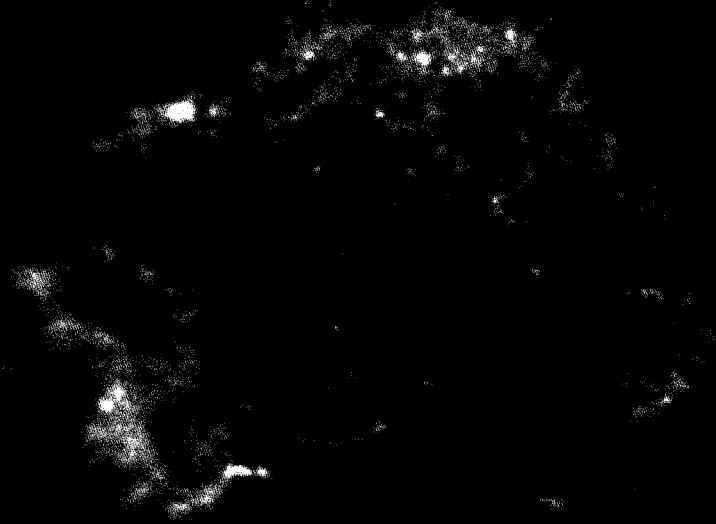

The Moon

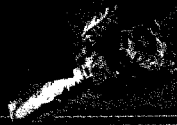

OPTICAL



X-RAY

All planets, other than Uranus,
are X-ray sources!

- Jupiter
 - Hot spots at high latitudes
 - *Big surprise*
 - Pulsates (45 minute period)

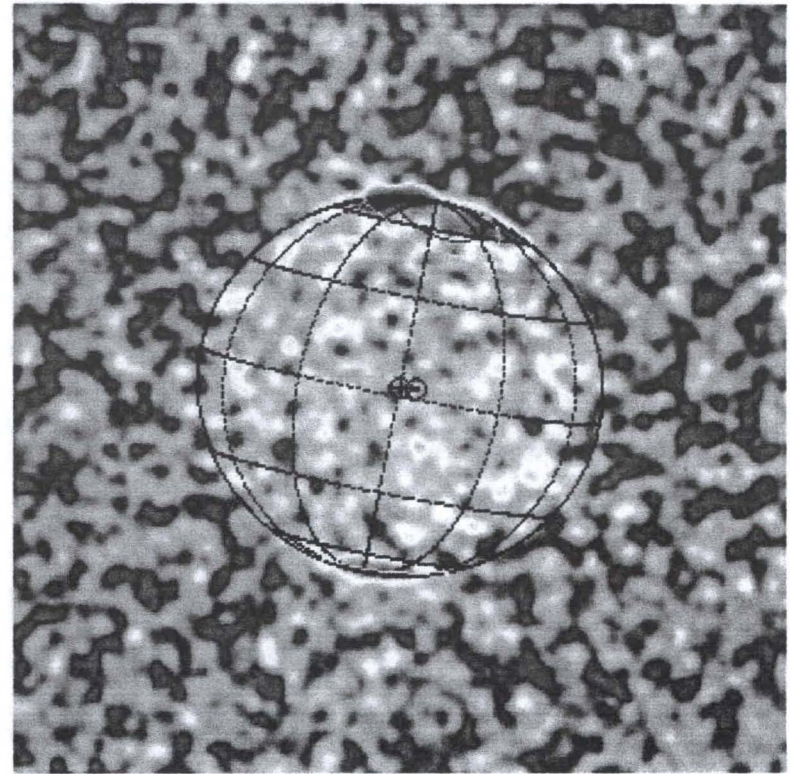

Double Quasar

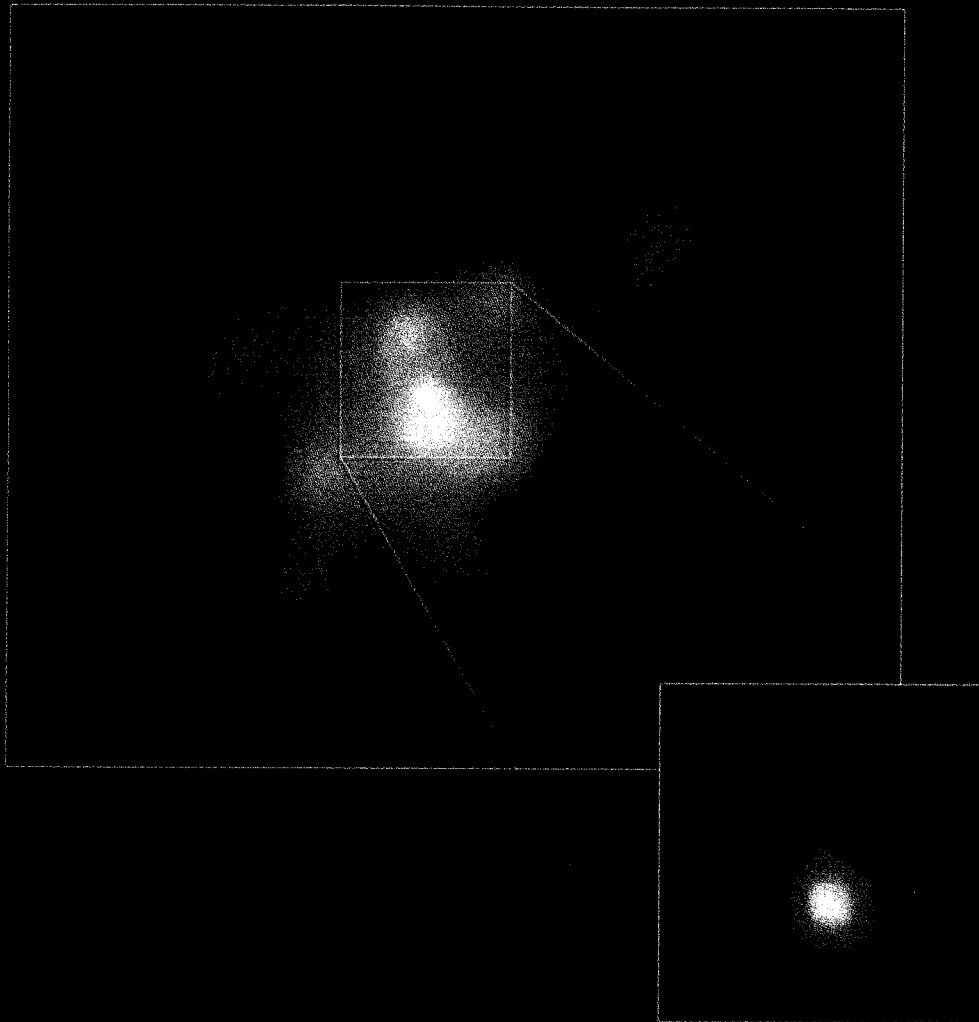

Dark Matter

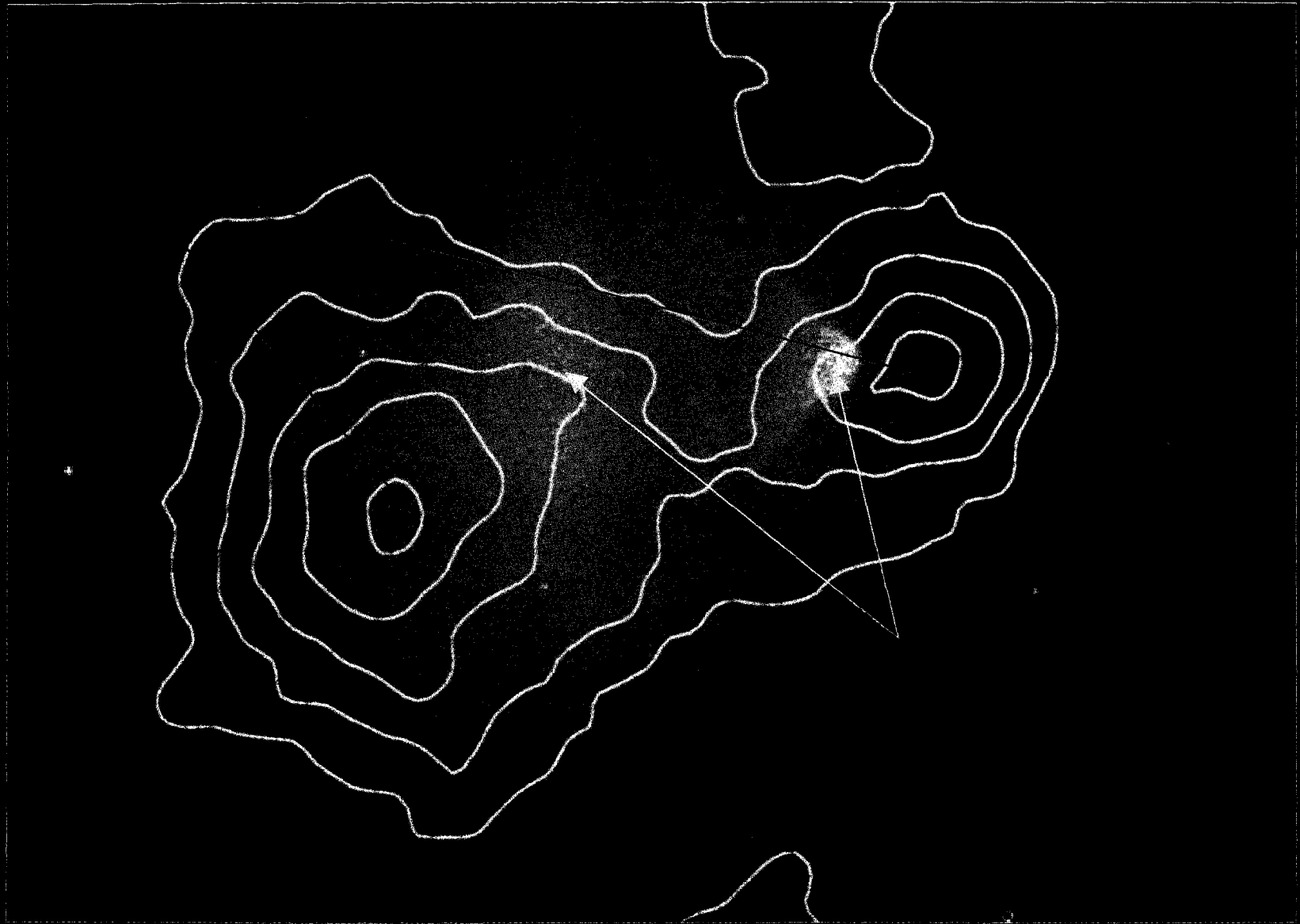

Dark Matter & Dark Energy

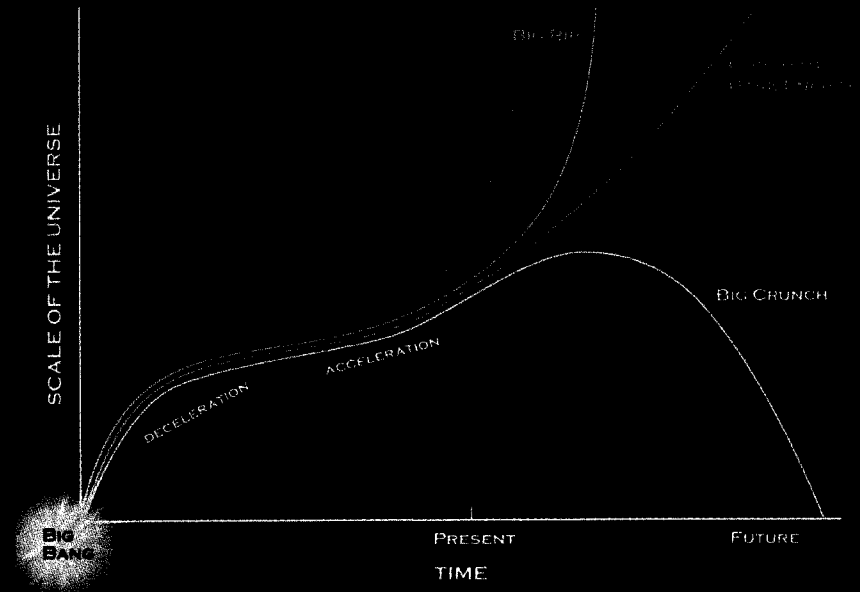
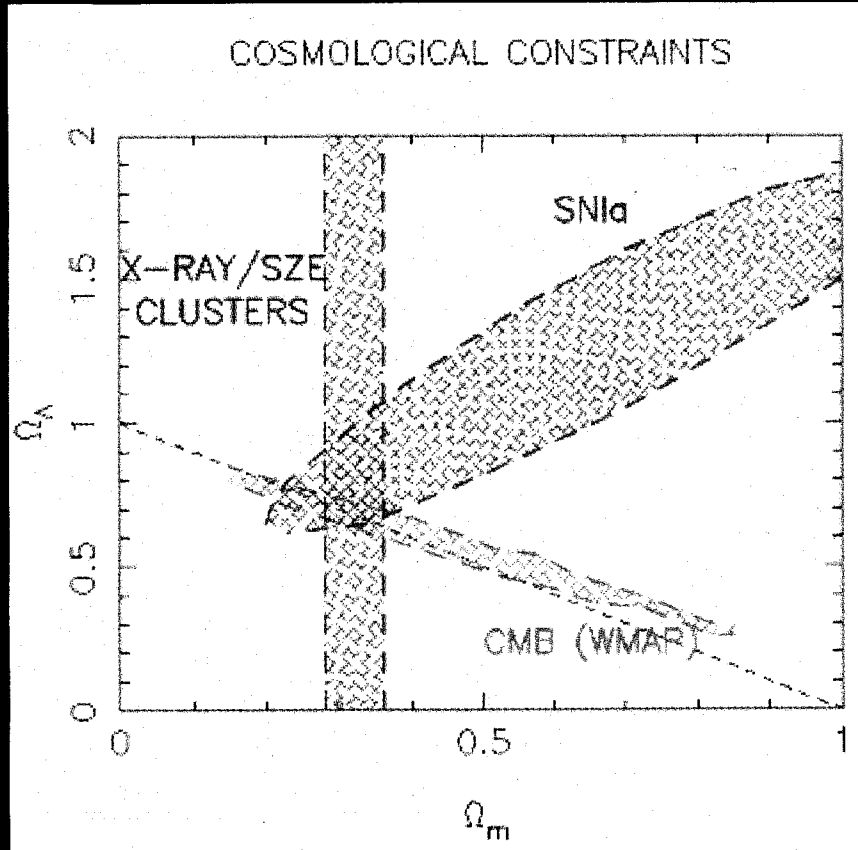

The Nobel Prize - 2002



Summary

- Operations are running smoothly
- Mission success
 - Design of the Observatory
 - Excellent and committed staff
 - Team effort
- Exciting and fundamental scientific results
 - Papers at a rate of ~10 per week
- Visit our web site @
www.chandra.harvard.edu

Chandra Lifetime

- Fuel: >40 years
- Orbit: 30-50 years
- Funding: NASA committed to (at least) a 13 year mission